



WORLD Sustainable Built Environment Conference **2017 Hong Kong**

Transforming Our Built Environment through
Innovation and Integration:
Putting Ideas into Action

Conference Proceedings

Organisers



International Co-owners

PUBLISHING DETAILS

This Conference Proceedings for World Sustainable Built Environment Conference 2017 Hong Kong (WSBE17 Hong Kong), which took place in Hong Kong on 5-7 June, 2017.

The Conference was jointly organised by Construction Industry Council (CIC) and the Hong Kong Green Building Council (HKGBC).

The Sustainable Built Environment (SBE) series of conference operates on a three-year cycle and includes five international organisations as co-owners:

- International Council for Research and Innovation in Building and Construction (CIB)
- International Initiative for a Sustainable Built Environment (iiSBE)
- United Nations Environment Programme (UNEP-SBCI, Sustainable Building and Climate Initiative)
- International Federation of Consulting Engineers (IFDIC)
- Global Alliance for Buildings and Construction (Global ABC)

The Conference Proceedings is available at the website of Hong Kong Green Building Council: <http://www.hkgbc.org.hk>

This proceedings gathers papers presented in the Conference, **“WSBE17 Hong Kong – Transforming Our Built Environment through Innovation and Integration: Putting Ideas into Action”**, presented in Hong Kong. **All the papers in this proceedings were double blind peer reviewed by the International Scientific Review Panel of WSBE17 Hong Kong.**

The proceedings was prepared from the input files supplied by the authors. The Conference Organisers make no representation, express or implied, with regard to the accuracy of the information contained in this proceedings and cannot accept any legal responsibility of liability for any errors or omission that may be made.

This proceedings is published by the Construction Industry Council and Hong Kong Green Building Council Limited in Hong Kong on May 2017.

Copyright © Construction Industry Council, Hong Kong Green Building Council Limited, 2017

ISBN 978-988-77943-0-1

Construction Industry Council
38/F, COS Centre
56 Tsun Yip Street, Kwun Tong
Hong Kong
www.cic.hk

Hong Kong Green Building Council Limited
1/F Jockey Club Environmental Building
77 Tat Chee Avenue, Kowloon Tong
Hong Kong
www.hkgbc.org.hk

Copying text and copyright laws

At all times, please be aware of the relevant copyright rules when copying text. Unauthorized use in a particular country basically depends on the national laws of that country. However, most countries offer protection to foreign works under certain conditions that have been greatly simplified by international copyright treaties and conventions.

If referring to the entire proceedings or any part of the proceedings other than individual abstracts or any other aspect of the conference, appropriate acknowledgement of these proceedings would be appreciated. If you wish to refer to one of the abstracts, it is recommended that you first contact the lead author to determine whether this abstract has subsequently been published in a journal, or if further information is available.

Table of Content

I.	ABOUT WSBE17 HONG KONG	40
II.	ABOUT THE ORGANISERS	41
III.	WELCOME MESSAGE FROM CHAIRMAN OF WSBE17 HONG KONG ORGANISING COMMITTEE	42
IV.	LIST OF HONORARY ADVISORS, ORGANISING COMMITTEE AND SCIENTIFIC COMMITTEE	43
V.	MESSAGES FROM CHAIRMAN OF CONSTRUCTION INDUSTRY COUNCIL, CHAIRMAN OF HONG KONG GREEN BUILDING COUNCIL AND GOVERNMENT OFFICIALS	48
VI.	CONFERENCE PROGRAMME	55
VII.	SBE16 REGIONAL CONFERENCES –TOP & BEST PAPERS	94
VIII.	SESSION SUMMARY & CONFERENCE PAPERS	108
A.	Keynote Sessions	108
B.	Plenary Session on Climate Change and Sustainable Development	111
C.	Roundtable Sessions.....	113
D.	Parallel Sessions.....	117
i.	Mainland China Sessions	117
(1)	The Comprehensive Scheme on Green Retrofitting and Performance Enhancement of Existing Buildings in China (Session Organiser: China Academy of Building Research).....	117
(2)	Green Building Design and Technological Challenges of Eco Skyscraper in China (Session Organiser: Shanghai Research Institute of Building Sciences).....	118
(3)	Turning Green to Gold – Green Practices for Urbanisation in China (Session Organiser: Shenzhen Green Building Association and Shenzhen Institute of Building Research)	119
(4)	The Development Framework and Professional Best Practices of Healthy Buildings in China (Session Organiser: Green Building Research Centre and the Chinese Society for Urban Studies).....	120
ii.	Regional Sessions.....	121
iii.	SBE Challenge (Session Organiser: iiSBE)	123
iv.	BEAM Plus Neighbourhood: From Theory to Praxis (Session Organiser: Hong Kong Green Building Council)	125
	Subsidised Sale Flats Development at Fat Tseung Street West	127
	Ada FUNG	

Transformation of EMSD Headquarters into a Green Building	128
Ernest HY YEUNG, Raymond KF LEUNG, Antony WT HO, Vicky CY NG	
West Kowloon Cultural District	129
William CHAN	
BEAM Plus Neighbourhood: Lessons Learned from Pilot-Testing	130
Larry POON	
v. Sponsored Sessions	131
(1) Vision-led Sustainable Neighborhoods: Myths and Musts (Session Organiser: AECOM)	131
(2) Transportation Hubs: Their Critical Role and Requirements? (Session Organiser: AECOM)	132
(3) Deep Energy Saving and Other Innovative Green Measures for Commercial Buildings in Hong Kong, Mainland China and Overseas (Session Organiser: Swire Properties Ltd).....	133
Sustainability Strategies on Deep Energy Saving and Energy Management of Property Developer.....	134
Raymond YAU, Isaac TSANG, Harry LUK, Ting YAO	
Technical Innovation Developed from Ten-year Research and Practice Collaboration of Private Sector and Academia on Building Energy Efficiency	141
WEI Qingpeng, Raymond YAU, WU YL, Jean QIN	
Cost & Value: Multiple Benefits of Green Commercial Buildings in Western Countries	150
Phil JONES	
YKK80 High Efficiency Building - Radiant Control both Outside and Inside	165
Kitaro MIZUIDE	
Performance Synergy from Integrated Design, Construction and Operation. Case Study on a High Performance Grade A Office - Swire One Taikoo Place	174
Vincent CHENG, Mark RICHARDSON, LEUNG Wai-Ho, Alvin LO, Raymond YAU, Raymond KWOK, Frenky YUE	
(4) The Secret Ingredients of Sustainable Real Estate Development (Session Organiser: Swire Properties Ltd).....	182
(5) Emerging Practices in Sustainable Built Environment (Session Organiser: Allied Environmental Consultants Ltd.)	183
Showcase of Green Campus Development in Hong Kong – A Case Review of Hang Seng Management College’s Master Campus Expansion Plan	184
Grace KWOK, Timothy SZE, Yvonne LIN, Danica CHAN, Martin TAM, Tom FONG, Hackman LEE	

	Drive towards Sustainable Development and Management: Case Study on International Commerce Centre.....	191
	Grace KWOK, Timothy SZE, Andy LAI, Frank CHEUNG, Sonia TSANG	
	Intelligence, Collaboration, Continuity – A Case Study of Improving the Environmental Performance of an Office Building.....	198
	Lewis LAM Yu-Hin, Patrick LEUNG Chi-Fai, Bonny WONG Yee-Ting	
(6)	A Collaborative Approach in Delivering Low Carbon Living (Session Organiser: Arup).....	205
(7)	Powering Up Smart City (Session Organiser: CLP Power Hong Kong Ltd).	206
(8)	Healthy and Sustainable Building for Resilient Future (Session Organiser: Link Asset Management Ltd. / Nan Fung Development Ltd).	207
(9)	Sustainability Assessment of Buildings as Part of Green-Public Procurement Based on the German BNB-System (Session Organiser: Division Sustainable Building, Federal Institute for Research on Building, Urban Affairs and Spatial Development (BBSR), Germany)	208
	Sustainability Assessment of Buildings as Part of Green Public Procurement – An Introduction	209
	Thomas LÜTZKENDORF, Andreas RIETZ	
	The Assessment System for Sustainable Building BNB by Taking the Example of the Complete Refurbishment BNB Module for Educational Buildings.....	213
	Julia MÜLLER	
	Sustainable Building Assessment System for Research- and Laboratory buildings - Austrian and Swiss Perspective on the BNB Applicability	220
	Alexander PASSER	
	Natural Resources and Sustainability	226
	Eike ROSWAG-KLINGE	
	PL·E·N·AR Planning Aid for Energy Efficient and Sustainable Architecture.....	229
	Günter LÖHNERT	
(10)	Smart and Digital Transformation for Sustainable Living (Session Organiser: Sino Group).....	237
	Policy, Design, and People: Developing a Sustainable East Asia	238
	Vincent CHENG, Jimmy TONG	
(11)	Environmentally Responsive Buildings and Human Interactions (Session Organiser: Somfy Asia-Pacific Co. Limited)	244

(12) High Performance Buildings and Sustainable Neighbourhoods in Sweden (Session Organiser: Sweden Green Building Council).....	245
(13) PolyU Green Deck: A Catalyst for a Green and Vibrant Community (Session Organiser: The Hong Kong Polytechnic University)	246
From Grey to Green	247
Alex LUI Chun-wan	
Improving Neighbourhood Sustainability with Landscaping in the Context of Climate Change: A Case Study of the Proposed Green Deck in Hong Kong	251
Edwin CHAN Hon-wan, CHAU Chi-kwan, Esther YUNG Hui-kwan, Conrad PHILIPP, HAN Jianbo	
Noise Mitigation Potential of PolyU Green Deck Proposal	258
TANG Shiu-keung	
Effect of the Green Deck on Local Air Quality	265
LEE Shun-cheng, Yuan Gao	
Proposed Green Deck Project: A Framework for Engaging Stakeholders...271	
Esther YUNG Hui-kwan, Edwin CHAN, Sheila CONEJOS	
“Smart Green Resilient” Integrative Urban Environment	278
Wilfred LAU	
vi. Paper Sessions.....	279
Track 1: Smart Initiatives & Advanced Building Systems	279
<u>Session 1.3 Advanced Building Elements</u>	279
Filter Façade.....	279
Ferdinand OSWALD	
The Impact of Double Skin Façade on the Energy Consumption of Office Buildings under the Tropical Brazilian Climate	284
Sabrina Andrade BARBOSA, Kenneth IP	
Climate-Adaptive and Optimized Building Envelope Designs in East Asia..290	
Kevin WAN, Timothy LOK, Antony HO, Vincent CHENG	
Folded Cardboard Sandwiches for Load-bearing Architectural Components	298
Stephan SCHÜTZ	
Multistorey Frame System for Energy Efficient Buildings	304
Petr HAJEK, Ctislav FIALA, Vlastimil BILEK, Michal ZENISEK, Jan RUZICKA, Jaroslav HEJL, Lenka LAIBLOVA, Martin VOLF	
<u>Session 2.3 Advanced Building Elements</u>	311
Remarkable Energy Retrofit for Existing Buildings by Advanced Fan Technology: Electronically Commutated Motor Plug Fan.....	311
Isaac TSANG Siu-chung, Tony LEE, LAM Tsz-kin, Andrew MAK, YAO Ting	

Low Temperature Radiant Cooling Design and Application in Tropical/ Sub-Tropical Countries	319
Paul CHAN Yim-cheong	
Hybrid Air-conditioning System Efficiency for Districts in the Tropics	326
Shanshan HSIEH, Jimeno FONSECA, Arno SCHLUETER, François Maréchal	
Evaluation of Saving Energy of SOFC and Battery Combined System	333
Takeshi SASE	
<u>Session 3.3 Advanced Building Systems - Energy Generation (1)</u>	341
Analysis of Fourth-Generation District Energy Systems with Renewable Energy Cogeneration by Using Rational Exergy Management Model.....	341
Biorol KILKIS	
The Application of Solid Oxide Fuel Cells in Buildings for Electricity, Heating and Cooling Tri-generation Using Bio-gas from Food Waste	351
WANG Qiancheng, CHEN Bin, NI Meng, Valeria Isabel ALVARADO ROMAN, XU Haoran, QIN Weicong, WANG Yitian	
Building and Community Energy Retrofit Housing in Wales	358
LI Xiaojun, Phil JONES, Jo PATTERSON	
Geothermal District Heating Investigation of Retired Oil/Gas Wells as Higher-temperature Renewable Heat Sources.....	364
GUO Hongshan, Forrest MEGGERS, KIM Min-gun	
<u>Session 4.3 Advanced Building Systems - Energy Generation (2)</u>	370
Exergoeconomic Assessment of a Building Integrated Photovoltaic (BIPV) System: A Case study of Yasar University, Izmir, Turkey.....	370
<i>Arif HEPBASLI, Emrah BIYIK, Mustafa ARAZ, YAO Runming, Mehdi SHAHRESTANI, Emmanuel ESSAH, SHAO LI, Armando C. OLIVEIRA, Teodosio DEL CAÑO, Elena RICO, Juan Luis LECHÓN</i>	
Variations of Systematic Solutions for 24-Hour Operating Sustainable Small-Scale Commercial Buildings	379
Bumpei MAGORI, Tomonari YASHIRO, Yu MORISHITA	
Study on the Potential of Converting Former Military Bunkers into Energy Storage Facilities.....	387
Joachim SCHULZE	
An Evaluation of Building Integrated Wind Energy.....	394
Mehmet Koray PEKERICLI, Ali Murat TANYER	
<u>Session 5.3: Smart Initiatives in SBE (1)</u>	400
The New Smart Cities Cities Built from Scratch and Old Cities Transformed into Smart Cities. Sustainable Growth	400

Ana Claudia Figueiredo OLIVEIRA, Carlos Alberto Assunção ALHO	
Enhanced Engineering Services for Electrical & Mechanical System via Integrated Building Management System, Remote Monitoring Unit, and Geographic Information System	406
LEE Che-kit, Sammy YEUNG Sau-kuen, HU Jinshan, CHAN Kin-hong, FUNG Ka-yan	
Decarbonising the City: Micro Energy Grids	412
Richard WANG, Derek CHAN, Vincent CHENG	
A Multi-Disciplinary Approach in Developing Sustainable Built Environment: A Case Study in Hong Kong Kowloon East Development Project (KEDP) ..	418
Schuman LAM, Edwin CHAN Hon-wan	
Sy(e)nergies Between Mega Event Buildings and The Surrounding Neighbourhoods	424
Simone MAGDOLEN	
<u>Session 6.3: Smart Initiatives in SBE (2)</u>	429
Transforming Building Information Modelling to Sustainable Building Asset Management	429
LEE Che-kit, CHAN Ping-sun, CHAN Hor-yin, YUEN Piu-hung	
Meter Online: Information Drives Behavioural Change to Save Building Energy.....	436
Eric CHEUNG, Simon LAM, Simon TSUI, Joseph LAI, Cary CHAN	
Energy Efficient Optimal Controls and Smart Energy Management of Buildings and Their Energy Benefits in Real Applications	442
WANG Shengwei, SHAN Kui	
Interactive Building-User Systems for Positive Behavioral Change by Enhancing E-Participation of Building Occupants	448
ZHANG Qianning, Stephen LAU Siu-yu	
Review on Demand Control Ventilation	455
ZHENG Caidan, WANG Yucheng	
<u>Session 7.3: Smart Initiatives in SBE (3)</u>	462
Using Advance Thermodynamics and Online Big Data Analytics to Maximize the Chiller Plant Performance	462
Rafael NAVARRO, Glen ANDERSON	
Transforming Data into Action – Building Energy Management System to Actualize a Sustainable Built Environment.....	472
Jovian CHEUNG Man-chit, CHAN Tze-chun, YIU Cheuk-man	

Telecommunications Infrastructure for High Performance Buildings	478
Philip TAI	
Using Big Data Analytics and Continuous Monitoring to Increase the Return on Investment (ROI) in Projects for Sustainable Building Performance.....	484
Rafael NAVARRO, Mark CASE, Jeffrey SLOW	
<u>Poster Session</u>	492
Vertical Farm: Integrating Multifunctional Microalgae Cultivation into the Sustainable Built Environment.....	492
LEE Tzan-chain	
Grid Connected Photovoltaic System Potentials and Performance in 4 University Campuses.....	495
Chanikarn YIMPRAYOON	
Track 2: Practices & Policies for High-Performance Buildings	501
<u>Session 1.4: Practices Review of High-Performance Green Buildings</u> .	501
When will Hong Kong build its first Passive House? : Concepts and Case Studies around Asia show great possibilities for Energy Savings	501
Anne JACOBS	
Insights into Energy Efficiency of hotels Constructed as Green Buildings ...	508
Duygu ERTEN	
Building Energy Efficiency in Hong Kong: Case Study of a Commercial Building with BEAM Plus Provisional Platinum Rating (Existing Buildings) .	517
POON Ka-man, CHAN Wai-ye, HUI Pui-shan	
An Elemental Approach for Predicting Embodied Carbon of Office Buildings	522
Michele VICTORIA, Srinath PERERA	
Exploring Risks and Rewards Associated with High Performance Manufactured Buildings	528
Karlson Charles HARGROVES, Lios HEBERT, Peter NEWMAN, Jemma GREEN, Daniel CONLEY	
<u>Session 2.4: Policies for High-Performance Green Buildings (1)</u>	534
Demystifying and Democratizing the Energy Use Conversation to Support the Net-Zero Challenge	534
Birgit SIBER, Mike WILLIAMS	
Building Energy Saving Strategy in Hong Kong —“Built-in” + “Plug in”	542
CHAN Pak-cheung, CHIU Chun-ting, KONG Ka-wah, SHUM Chung-ye	
How Sustainable Are the Quality Control Procedures for Constructions in Europe?.....	549
Frits MEIJER	

Policy Scenarios of Zero Carbon Building for Hong Kong: To Survive or To Lead?	555
PAN Wei, PAN Mi	
A Discussion on the Benefits of Environment Performance of the Promotion of Kaohsiung Green Building Specialties Policy.....	562
CHAO Chien-chiao, CHOU Po-cheng, SU Chih-hsun, HUANG Chih-ming, TSENG Pin-chieh, KUO Yi-chun	
<u>Session 3.4: Policies for High-Performance Green Buildings (2)</u>	567
Baseline and Water Efficiency for Green Building in Taiwan.....	567
CHENG Cheng-li, HO Ming-chin, LIAO Wan-ju, CHERN Szu-jen	
A Comparative Study on Economic Policies for Construction and Demolition Waste Minimisation	573
Jongsung WON, Jack CP CHENG, Irene MC LO	
Using Supply Chain Management for Sustainable Public Procurement	579
Johannes WALL, Jörg KOPPELHUBER, Christian HOFSTADLER	
Innovative Measures to Protect Residential Developments from Traffic Noise - Hong Kong Experience.....	585
LAU Kwok-keung, LEE Chee-kwan, Maurice YEUNG	
Energy Efficiency for a Sustainable Built Environment in Nigeria	591
Susanne GEISSLER, Ene MACHARM	
<u>Session 4.4: Processes of High-Performance Green Buildings</u>	598
What Are The Most Effective Drivers of Sustainable Development in The Decision Making Process	598
Hanne Tine Ring HANSEN, Mary-ann KNUDSTRUP.	
German ÖKOBAUDAT Goes International: An Online Infrastructure for LCA as a Basis for International Structure	605
Tanja BROCKMANN	
How Actors Can Implement in Practice the General Principles of Sustainability in Their Buildings and Civil Engineering Projects	611
Sylviane NIBEL, Thomas LÜTZKENDORF, Guido HOFF, Gérard SENIOR, Jabeen QUADIR	
Driver and Challenges Facing Leadership in Adopting Sustainability in the Built Environment: A Developer's Perspective	617
ZHANG Xiaoling	
Analyzing the Reference Flows for Energy Efficient Retrofit of Typical Residential Building in Tianjin, China.....	627
LIU Lu, YANG Wei, MA Lingbo, YU Hanze	

Session 5.4: Deep Renovations – Policies & Standards	635
Small, Beautiful, Yet Difficult: Energy Plus Renovation in Small Social Housing Companies.....	635
Christian KOCH, Anders LUTTEMAN	
Deep Renovation: Key Action for Active Protection of Modern Heritage. The Case of Architecture for the Service Sector	641
Claudia CALICE, Carola CLEMENTE	
Future Challenges for Renovation as Experienced by Swedish Housing Companies	647
Liane THUVANDER, Paula FEMENÍAS, Birgit BRUNKLAUS	
Integration of Sustainability Analyses into Business Models for Energy Renovation of Buildings: A Case Study in Norway	653
Roberta MOSCHETTI, Helge BRATTEBØ, Kristian S. SKEIE, Anne G.LIEN	
The Development of Existing Buildings Green Retrofitting in China	660
WANG Qingqin, WANG Junliang, FAN Dongye	
Session 6.4: Deep Renovations – Practices & Performance Review	669
The Verification and Implementation of Practical Renovation for net-ZEB Office.....	669
Hiroaki TAKAI, Takeshi ISHIGURO, Hiroshi ABE, Kouji TANAKA, Katsuhiko HIRANO, Kazuki WADA, Hiroki KAWAKAMI	
Humid Wall: Review on Causes and Solutions	675
Mohamad KHARSEH, York OSTERMEYER, Claudio NÄGELI, Izabela KURKOWSKA, Holger WALLBAUM	
Improving the Market Up-take of Energy Producing Solar Shading: Experiences from Three Cases of Retrofit	682
Paula FEMENIAS, Liane THUVANDER, Peter KOVÁCS	
Towards a Holistic Approach to Retrofitting: A Critical Review of State-of-the-art Evaluation Methodologies for Architectural Transformation	689
Stina Rask JENSEN, Aliakbar KAMARI, Anders STRANGE, Poul Henning KIRKEGAARD	
Renovation Needs and Potential for Improved Energy Performance Depending on Ownership – A Location Based Study of Multi-Family Building Stocks in an Urban Context	696
Magnus ÖSTERBRING, Liane THUVANDER, Érika MATA, Holger WALLBAUM	
Session 7.4: Deep Renovations – Processes & Methodologies	702
Towards a Holistic Methodology in Sustainable Retrofitting: Theory, Implementation and Application.....	702
Aliakbar KAMARI, Stina Rask JENSEN, Rossella CORRAO, Poul Henning KIRKEGAARD	

A Multidimensional Optimization Approach to Refurbishment Design on a Multi-Building Scale	709
Claudio NÄEGELI, York OSTERMEYER, Mohamad KHARSEH, Izabela KURKOWSKA, Holger WALLBAUM	
Development of Regenerative Design Principles for Building Retrofits	716
William James CRAFT, Lan DING, Deo PRASAD	
Passive Building: Energetic Refurbishment of a Secondary School	722
Antonio FRATTARI, Irene FERRO	
Factors Affecting High Performance Building Designs in Nigeria’s Built Environment: “The Architects Perception”	728
Abubakar Yahaya MUHAMMAD, Bashir Abdulmalik MOHAMMED, Usman Aliyu JALAM, Nma Yakubu MOHAMMED	
Poster Session	735
Building High on Sustainable Use of Water: Hong Kong’s Effort	735
Stephen CATLIN Kit-wai, KWAN Kai-yin	
Costs and Benefits of Implementing Green Building Policy	741
FAN Ke, GU Wei, Queena QIAN, Edwin CHAN	
A Framework towards Low-carbon Heritage Conservation of Hong Kong: with Analysis of Embodied Carbon	747
Nan GUO, Wei GU, Edwin CHAN, Esther YUNG	
A Discussion on the Benefits of Environment Performance of the Promotion of Kaohsiung Green Building Specialties Policy -the Case Study on Residential Building in Kaohsiung City	752
KUO Yi-chun, OU Po-cheng, SHIE Chih-chang, SHIE Yu-chun	
Thermal Behavior of a Low-Cost House Coated with Transparent Infrared Reflective Paint	758
Ochuko Kelvin OVEREN, Edson Leroy MEYER, Golden MAKAKA	
Dynamic Solar Shading in Sustainable Buildings	765
Anders HALL	
The Third Success Factor of Renovations with Energy Ambitions	772
Anke VAN HAL	
Thermal Performance as a Parameter of Choice of Materials: Brazilian Antarctic Station	777
Bruna Perovano SIRTULI, Filipe Galina COSTALONGA, Cristina Engel de ALVAREZ, Edna Aparecida NICORODRIGES	
Track 3: Advancing SBE Assessments	784

<u>Session 1.5 SBE Assessments - Green Neighbourhoods (1)</u>	784
LEED Certification and the New Standard of Sustainable Construction in Colombia	784
Andres PELAEZ, Alexander GONZALEZ, Laura MARIN	
Comparison Study of China's Eco-City Key Performance Indicator Systems	791
DENG Wu, Ali CHESHMEHZANGI, Ayotunde DAWODU, WANG Bingyu	
A Human-Oriented Study of the Assessment Method for Sustainable Urban District in China - Comparison of LEED Neighbourhood Development, BREEAM Community, CASBEE-Cities and DGNB Urban Districts	803
Edison ZHANG Zhidong, Stephen LAU Siu-yu, Edward SHEN, April HAO Tong-ping	
Reducing the Impacts of the Built Environment on the Environment through the Integration of Socio-economic Indicators in Certification Standards	809
Francesco CAPPAL, Daniel FORGUES, Mathias GLAUS	
Development of a Comprehensive City Assessment Tool Applicable to Various Type of Cities Around the World: CASBEE-City (worldwide use version)	815
Shun KAWAKUBO, Shuzo MURAKAMI, Toshiharu IKAGA, Junya YAMASAKI	
<u>Session 2.5: SBE Assessments – Green Neighbourhoods (2)</u>	821
Value Management as Tool for Delivering Sustainable Rail Projects	821
Ayodeji Emmanuel OKE, Clinton Ohis AIGBAVBOA, Njabulo Sydney NGUBANE	
Calculation Methodology of GHG Emissions from a Low Carbon Urban Development in an Underdevelopment Country – Case Study from a LEED ND Certified Project in São Paulo City, Brazil	827
Maria Carolina FUJIHARA	
A Stakeholder-Based Assessment Model (SAM) For Resource-Efficiency Measures in the Construction Industry	833
Richard Carl MÜLLER, Olga SCHAMBER, Rebekka VOLK, Frank SCHULTMANN	
Comparative Rich-Picture-Diagram for Assessment of Building Sustainability Labels.....	840
Sasha Nikolaus CISAR, Guillaume HABERT	
More Than Green: The DGNB Certification System for Sustainable Buildings and Districts.....	846
Alexander RUDOLPHI, Stephan ANDERS, Johannes KREIßIG, Christine LEMAITRE, Anna BRAUNE	
<u>Session 3.5: Performance Review of Green Buildings (1)</u>	853
Strategic Study on the Benefit Evaluation of Solar Photovoltaic Promotion Policy in Kaohsiung	853
CHAO Chien-chiao, LI Yenyi, HUANG Chi-ming, LIU Chung-ang, CHUNG Po-ren	

A Baseline Study on Thermal Performance of Prefabricated Modular Buildings in Australia	861
Sareh NAJI, Valentin PLOYET, Masa NOGUCHI, Lu AYE	
Energy Saving Potential of Thermal Broken Fenestration System in Hot Climate Counties	868
Simon WONG	
Potentials of Energy Efficiency and Generation Strategies for High-rise Office Buildings in Hong Kong	874
YU Cong, PAN Wei	
Effect of Corridor Design on Energy Consumption for School Buildings in the Cold Climate	880
ZHANG Anxiao, SUN Yanchen, HUANG Qiong, Regina BOKEL, Andy VAN DEN DOBBELSTEEN	
<u>Session 4.5: Performance Review of Green Buildings (2)</u>	888
The Importance of Understanding The Material Metabolism of The Built Environment	888
Danielle DENSLEY TINGLEY, Hadi ARBABI, Michael DURKIN	
Net Environmental Loads of Mineral Admixtures and Portland Blended Cements	895
Marcella Ruschi SAADE, Maristela Gomes SILVA, Vanessa Gomes SILVA	
Embodied Energy and Global Warming Potential in Construction: Perspectives and Interpretations	901
Maria BALOUKTSI, Thomas LÜTZKENDORF, Seongwon SEO, Greg FOLIENTE	
Study of Human Embodied Energy for Masonry Work During Building Construction	907
Pinky Devi L., Sivakumar PALANIAPPAN	
The Life Cycle Cost - Energy Relationship of Buildings	914
WANG Jie, PAN Wei	
<u>Session 5.5: SBE Assessments – Green Building Policies</u>	920
From Research to a National Standard: SBTool and Protocollo ITACA	920
Andrea MORO	
The Network for Sustainable Federal Building as an Instrument of Quality Assurance in The Implementation of the Assessment System BNB in The Public Sector	924
Andreas RIETZ, Nicolas KERZ, Merten WELSCH	
Competing Visions for Building Materials Assessment in US Green Building Certification Programs	930
Charles Joseph KIBERT, Andriel FENNER, Hashem IZADI MOUD, Mohamad AHMADZADE RAZKENARI, Hamed HAKIM	

CESBA Alps, From Building to Territory: Together Towards a Harmonized Built Environment Assessment	937
Markus BERCHTOLD-DOMIG, Andrea MORO, Etienne VIENOT	
LEED CS in Brazil: Discussing the Validity of the Method for the Improvement of Environmental Quality on Buildings	943
Monica Santos SALGADO	
<u>Session 6.5: SBE Assessments – Design Processes</u>	950
Does BEAM Really Matter to Construction Waste Management? What Big Data Does and Does Not Tell	950
CHEN Xi, LU Weisheng, LIU Xingjian	
Contribution of Knowledge in Sustainable Building Design in Emerging Markets: A Case of Vietnam	957
Hung Duy NGUYEN, Long Duy NGUYEN, CHIH Ying-yi, Long LE-HOAI	
Integrated Green Building Assessment Approach for the Next Decade	964
ANG Kian-seng, Jeffery NENG, May SIU	
Certification of Sustainability – Case Study Analysis of New German Standard.....	970
Merten WELSCH	
Integration of Energy and Material Performance of Buildings: I=E+M.....	977
Erik ALSEMA, David ANINK, Arjen MEIJER, Ad STRAUB, Geurt DONZE, Saskia VAN HULTEN	
<u>Session 7.5: SBE Assessments – Practice Review</u>	984
Transnational Harmonization of Built Environment Assessment Systems: The CESBA Passport Principle.....	984
Andrea MORO, Markus BERCHTOLD-DOMIG, Etienne VIENOT	
Generating and Providing Embodied Energy and Global Warming Potential Related Information: Recommendations for Construction Product Manufacturers	989
Alexander PASSER, Maria BALOUKTSI, Thomas LÜTZKENDORF, Angelika HINTERBRANDNER, Helmuth KREINER	
Discussing Sustainability in Building Construction: The Potential of SBTool for Brazilian Public Bidding in Fiocruz.....	996
Marcia Castilho CORREIA, Monica Santos SALGADO, Luis BRAGANÇA	
Assessment Tools for The Sustainability Performance of Building - Development of A Sustainability Assessment Method for Small Residential Buildings in Germany.....	1002
Natalie ESSIG	

Poster Session	1008
Renovation of Sheung Shui Staff Quarters – Green Building Actions Echoed by the Contractor.....	1008
LI Siu-lung	
Environmental Impact Assessment of the Central Kowloon Route Project	1015
LAM Man-san, Franki C K CHIU	
A Comparison on Two Certification Systems: Leadership in Energy and Environmental Design (LEED) And Building Environmental Assessment Method (BEAM) On Green Building in Hong Kong.....	1022
Ophelia CHU Ka-wai, Richard CHEUNG Yun-hing	
Research on Emission Evaluation Classification of Healthy Green Building Materials Label in Taiwan	1031
CHEN Cheng-chen, LEE Ching-chang, CHEN Jui-ling	
Sustainability Assessment: An Adaptive Neuro-Fuzzy Inference System Approach.....	1037
TAN Yongtao, SHUAI Chenyang, JIAO Liudan, SHEN Liyin	
Quantifying Greenhouse Gas Emissions: A Review of Models and Tools at the Precinct Scale.....	1042
Angela Maria ROJAS-AREVALO, Lu AYE, Seona CANDY	
Track 4: Innovations Driving for Greener Policies & Standards	1049
<u>Session 1.6 Innovations Driving for Greener Policies and Standards – Microclimate</u>	1049
The Potential of Applying Local Climate Zone for the Sustainable Planning in Urban Built Environment.....	1049
LIN Tzu-ping, CHEN Yu-cheng, REN Chao, Kevin LAU Ka-lun	
Building Envelopes and their Impact on our Urban Thermal Environment.	1054
MAING Minjung	
Urban Geometry and Wind Simulation Studies for Comfort in Bangkok Street Canyon.....	1061
Pattaranan TAKKANON	
Research of Urban Heat Island (UHI) in Shenzhen Based on Climatic Design and Urban Planning Strategies	1068
YU Wenjuan	
Influence of Moving Vehicles on Pollutant Dispersion in Street Canyon: A Numerical Study	1075
ZHANG Wenjing, CHOW Tin-tai	

Session 2.6: Innovations Driving for Greener Policies and Standards –

Carbon Assessment 1081

Building Carbon Footprint (BCF) Method for Nearly Zero-Energy Building
Design Assessment..... 1081
CHAO Yu-chan, HO Ming-chin, CHENG Ming-jen

Integrated Residential Household Energy Consumption and GHG Emissions
Modelling at Metropolitan Scale 1088
Raul MARINO, Greg FOLIENTE, Chris PETTIT

Building Life Cycle Carbon Emissions: A Review..... 1095
TENG Yue, PAN Wei

How Carbon Metric Standard Could Facilitate Innovation for Reduction of
GHG Emission from Buildings? 1102
Tomonari YASHIRO, Thomas LÜTZKENDORF, David CROWHURST, Rodney
MCPHEE, Guido HOFF, Gérard SENIOR, Ning HUANG

Climate Action Planning Strategies for Achieving Carbon Neutrality and Net
Zero Campus Operation 1109
Vuk VUJOVIC

Session 3.6: Innovations Driving for Greener Policies and Standards –

Practices Review 1115

Leap Forward or Snail Speed? Examining Radical Sustainable Innovation 1115
Christian KOCH

The Progress of Energy Renovations of Housing in the Netherlands..... 1121
Henk VISSCHER

Evaluation of Using BEAM-PLUS to Facilitate Waste Reduction in Building
Construction 1126
Lara Celine JAILLON, Ming Wai LEE, Chi Sun POON

Energy, Comfort and Cost Optimization of a Net-Zero Energy Building in
Berlin 1132
Olaf BOETTCHER, Fabrizio ASCIONE, Nicola BIANCO, Nicolas KERZ, Giuseppe
Peter VANOLI

Modeling the Built Environment Element by Element: Uncovering Greenhouse
Gas Intensive Policies and Structures with a New Visualization Tool 1140
Verena GÖSWEIN, Jonathan KRONES, John FERNÁNDEZ, Guillaume HABERT

Session 5.7: Innovations Driving for Greener Policies and Standards –

Assessment, Analysis and Modelling (1) 1146

European Horizontal Standardized Methods for the Assessment of the Sustainability
Aspects of Construction Works 1146
Ari ILOMAKI, Thomas LÜTZKENDORF

Life Cycle Energy and GHG Emissions Reduction of Retrofit Options for Existing Dwelling Stock.....	1152
Seongwon SEO, Greg FOLIENTE, Zhengen REN	
Renewable Energy Technologies: Economic Analysis Tool (RET-EAT) for Turkey	1160
Oguz Kursat KABAKCI, Burak HOZATLI, Korkmaz GÜL, Nilay ÖZELER KANAN, Aslı KARABACAK, Uygur KINAY	
Geo-dependent Heat Demand Model of the Swiss Building Stock	1166
Stefan SCHNEIDER, Jad KHOURY, Bernard LACHAL, Pierre HOLLMULLER	
Quantitative Impact Assessment of SEAP Measures Implementation on Several Districts in the City of Donostia	1173
Xabat OREGI, Lara MABE, Patxi HERNANDEZ, Eneko ARRIZABALAGA, Eduardo MIERA, Sergio SAIZ	
<u>Session 6.7: Innovations Driving for Greener Policies and Standards – Assessment, Analysis and Modelling (2)</u>	
Full Cost Assessment: A Method to Analyse Sustainability of Buildings ...	1179
Alessandra Akemi YOKOTA, Lu AYE, Masa NOGUCHI	
Integrated System for Energy Optimization and Reduction of Building CO ₂ Footprint	1185
Ernesto Enrique Echeverria VALIENTE, Flavio Celis d'AMICO, Manuel de Miguel SANCHEZ, Patricia Dominguez GOMEZ, Ignacio Delgado CONDE, Alvaro Mozas SANTANDER, Kevin Moreno GATA, Juan, Manuel Vega BALLESTEROS, Francisco Martin San CRISTOBAL	
Environmental Indicators for Monitoring the Swedish Construction and Real Estate Management Sector	1192
Kristina EINARSSON, Linda LAGNERÖ, Hans-Olof KARLSSON HJORTH	
Feasibility Study on Implementing Indoor Air Quality (IAQ) Index in Hong Kong.....	1199
MUI Kwok-wai, WONG Ling-tim, TSANG Tsz-wun	
Integrating Capital Cost with Energy Efficiency: Cost@Work.....	1204
TANG Chee-khoay	
<u>Session 7.7: Innovations Driving for Greener Policies and Standards – Smart Initiatives</u>	
Smart Cities: Selection of Indicators for Vitória	1211
Carolina SIMÕES ROCON, Cristina ENGEL DE ALVAREZ	
Establishing Smart Cities for Sustainability: An Analysis of the Japanese Innovation System and Implications for Asia.....	1218
Masaru YARIME	

PLUSQUA: Potential of Neighbourhoods to Reduce Thermal and Electrical Loads	1224
Diego HANGARTNER, Matthias SULZER , Stefan MENNEL, Urs-Peter MENTI	
Adoption of Smart Initiatives in Developing Anderson Road Quarry Site Towards a Sustainable and Green Living Area.....	1230
Matthew LAI Sze-yuen, Michael LEUNG Chung-lap, Barry SUM Pang-tuen, Kelvin CHENG Bing-cheung, Edwin FUNG Kook-koon	
PT Roadmap Towards Operational Energy Neutral Sewage Treatment Works.....	1237
Valeria ALVARADO, Charmane LAM Chor-man, Sussana W.K. LAI, KK CHEUNG, Mark HSU Shu-chien, Henry LEE Po-heng	
Poster Session	1244
Climate Responsiveness and Facade Design of AQUA-Certified School Buildings.....	1244
Doris C.C.K. KOWALTOWSKI, Leticia de Oliveira NEVES, Vanessa Gomes DA SILVA, Giseli Mary COLLETO	
Project Guidelines for Construction of Biodigesters in Poor Communities in Brasil	1251
Lizelda Maria MENDONÇA SOUTO, Sérgio PERES, Emilia KOHLMAN-RABBANI, Viviany NOGUEIRA, Ana Rita DRUMMOND	
Track 5: Innovation for Wellbeing	1258
Session 1.8: Innovations for Occupant Wellbeing (1)	1258
Research and Development of Noise Mitigation Measures for Public Housing Development in Hong Kong	1258
MW WONG, John HL HO, Stephen YIM	
Estimating Typhoon Haiyan's Wind Speeds Using Windicators and Post-Storm Wind Vulnerability Analysis on the Affected Areas	1265
Joshua AGAR, Jaime Jr. HERNANDEZ, William MATA	
Outdoor Lighting Quality and Glare Rating Evaluation of Night-Time Community Parks	1280
KUO Poyen, CHEN Yishan	
Better Places for People: Health and Wellbeing Measurement Methods in Workplaces.....	1287
Maíra DE MACEDO, Eleonora ZIONI, José Eduardo MODICA	
Development of a Home Indoor and Outdoor Environment Visualization System	1294
Yusuke NAKAJIMA	

<u>Session 2.8: Innovations for Occupant Wellbeing (2)</u>	1300
Outdoor to Indoor Air Quality in Urban Environment	1300
Alexis LAU Kai-hon, Jimmy TONG Chun-kuen, Wenwei CHE, FUNG Ka-kit, Joonho YEO, LI Tan-yui, PANG Wing-sum	
Redesigning Long-Term Senior Care: Design Solutions to Facilitate Different Levels of Care Needs in Senior Housing - Using Hong Kong's Latest Senior Housing as Example	1307
Bryant LU	
Occupant-Related Energy Use: a Qatar Office Case Study	1325
Chimay J. ANUMBA, Yewande ABRAHAM, Zhidan ZHAO, Somayeh ASADI	
Purifying City Air in Densely Urban Environment	1332
Jimmy C.K. TONG, David W.L. NG, Vincent S.Y. CHENG, Ricky Y.C. TSUI	
A Healthy and Sustainable Living Space – LOHAS	1338
Josh CHENG, Annie SHAO, Tony LAM, Vincent CHENG	
<u>Session 3.8: Innovative Practices for Occupant Wellbeing – Bioclimatic Design</u>	1345
Bringing Sustainable Neighbourhood Design into Reality – Case Sharing by Brickell City Centre, Miami.....	1345
Raymond YAU, Benny AU, Denise LEUNG, Bernardo FORT-BRESCIA, Hugh DUTTON	
On the Study of Shading Effect of Different Paving Materials Inside a Park.....	1354
SY CHAN, CK CHAU, Conrad PHILIPP, Edwin HW CHAN, HK YUNG	
Passive Design Strategies for Building Envelopes in Different Orientations.....	1362
Leidy Johana RAMIREZ, Elizabeth PARRA	
An Integrated Model for Urban Microclimate and Building Energy in High- Density City for Early Stage Design	1369
HUANG Jianxiang, Phil JONES, PENG Rong	
Re-Thinking Courtyard Housing: Development of Traditional Islamic Courthouses into Zero-Energy Buildings	1377
Samer EL SAYARY, Osama Mohamed OMAR	
<u>Session 4.8: Innovative Biophilic Design for Wellbeing</u>	1383
Systems Ecology as a Design Tool for Water Resources and its Environmental Education	1383
DAY Yeong-tyi	
Sustainable Neighbourhood of Shek Wu Hui Sewage Treatment Works ..	1389
WONG Sui-kan, LAU Wing-wah, Gigi POON Wing-chi, Echo LEONG I-man, Chris LAU Man-nin, Kevin CHENG Ka-yang	

Biophilia and Nature-based Features to Support Stress Reduction in Knowledge Workers.....	1397
Margaret Ann CALLAGHAN, Shauna MALLORY-HILL	
Pioneering “Comprehensive Urban Landscape Technology” (CULT): An Integrated System Model for Urban Sustainability as Community Amenity in A Compact Urban Environment	1405
Thomas CHUNG Wang-leung	
Foster a Healthy Community Through Active Design and Biophilic Design	1412
WANG Hong, LIN Han, TONG Yun-on	
Poster Session	1419
Development of Solar Photovoltaic Pavement Panels for Application on the Green Deck	1419
MA Tao, YANG Hongxing, LU Lin	
Study on the Prediction Model and Adjustment Strategies of Indoor Environment for Susceptible Populations.....	1426
LU Mei-chen, TSAY Yaw-shyan, SU Huey-jen, HSU Nai-yun	
Improvement Strategy of Urban Street Thermal Environment.....	1432
WANG Wen-an	
A Preliminary Exploration on the Climate Adaptive Design of Green Rural Houses in the South Shaanxi Province.....	1439
CAI Wei, HAN Yue, LIU Yi, ZHOU Haoran, WANG Runsheng	
Socio-Environmental Framework for Integration of Lightweight Tensile Structure Windcatchers in Contemporary Hot-arid Urban Context of Tehran	1445
Homeira MIRHOSSEINI, Shane Ida SMITH	
Track 6: Market Transformation & Green Building Management.....	1452
<u>Session 1.9: Practices & Methodologies for Green Building Management (1)</u>	1452
Incorporating Sustainability Criteria in Commercial Workplace Fit-Out Guidelines for A Banking Operation.....	1452
Mary Myla ANDAMON, James WONG Pow-chew	
Adopting Green Building Concepts in Housing Estate Development Projects in Abuja F.C.T., Nigeria: Exploring The Potentialities of End-Users’ Preferences	1459
Salisu Gidado DALIBI, FENG Jing-chun, Abubakar SADIQ, Bello SANI BELLO	
Project Management Strategies for Green Business Parks: Critical Success Factors, Barriers and Solutions.....	1468
HWANG Bon-gang, ZHU Lei, Joanne TAN Siow-hwei, CHI Seokho, SHAN Ming	
Smart, Green + Productive Workplace.....	1475

Simone SKOPEK, Jiri SKOPEK

Session 2.9: Practices & Methodologies for Green Building

Management (2) 1482

Green + Smart Buildings..... 1482

Jiri SKOPEK

Challenges in Realizing Green Building Concepts in Trade and Industry
Tower 1487

Alex CHAN, Joanna WAI, Raymond HO, Philip CHEN, K.T. Lee, Joyce TAI

The Perceptible Impacts of Building Envelope on Other Green Building
Features: “A Review” 1495

Salisu Gidado DALIBI, Abubakar SADIQ, Isa IBRAHIM DANJA, Abubakar
YAHAYA MUHAMMAD

Investigating Critical Safety Performance Factors in Green Building
Construction Projects: The Case of Singapore 1504

HWANG Bon-gang, SHAN Ming, PHUAH Siong-leng, CHI Seokho, ZHU Lei

Green Interior Renovation by Architectural Services Department 1510

Antony HO, Vicky NG, Eric POON, Shirley SETO, Chris YIP, L.C. SHEK

Session 3.9: Practices & Methodologies for Green Building

Management (3) 1519

Life Story of the Repurposed Shipping Container 1519

Alice L. F. YEUNG

Factor Influencing Human Capabilities for Practicing Sustainable Facilities
Management (SFM) - A Review..... 1525

Fathima Sabrina NAZEER, Sachie GUNATILAKE, Thanuja RAMACHANDRA

Sustainable Construction: Quality of Life of Construction Workers in Private
Sector: Case Study of L.P.N Development Public Co., Ltd. 1536

Pimchanok SRIRUTTRAKUL

Mining for Resources: Problem-Oriented Building Information Management
and Development of Agile Facility Management Methodologies Through
Industry-University-Public Collaborations..... 1541

Yu MORISHITA, Bumpei MAGORI, Tomonari YASHIRO

Development of MERIT and Normalization Factor for Different Operating
Hours for Building Energy Intensity (BEI)..... 1547

TANG Chee-khoay, Ahmad IDZIHAR, Kevin HOR

Session 5.9: Transforming Green Market – Green Economics (1) 1555

Stakeholders View on Commercial Benefits for Energy Neutral

Refurbishment of Let Properties 1555

TANG Chee-khoay, Ahmad IDZIHAR, Kevin HOR

How a Changing Socioeconomic Context Affects the Demand for High-performance Buildings	1561
Clinton ANDREWS	
Green Lease Insight – Integrated Approach	1565
Tim SHEN	
How Sustainable Planning Increases Real Estate Property Value The 3V Framework	1571
Serge SALAT, Françoise LABBÉ	
Responsible Investing in Green Buildings and Portfolios	1579
Ruben LANGBROEK	
<u>Session 6.9: Transforming Green Market – Green Economics (2)</u>	1580
Economic and Sensitivity Analysis of Net Zero Energy Refurbishment of Terraced Houses	1580
Angela GRECO, Tim JONATHAN, Andy VAN DEN DOBBELSTEEN	
Finding the Value in Deep Energy Retrofits	1586
James Scott BREW	
Productive Green Roofs	1591
Matthew PRYOR	
Sustainable Buildings – Impacts on Cash Flow and Business Case Analysis	1599
Thomas P. LÜTZKENDORF, David LORENZ, Peter MICHL	
Business for Sustainability: Market Incentives for the Better	1605
Thomas SCHLUCK, Robert BÜHLER, Sabine SULZER, Matthias SULZER	
<u>Session 7.1: Education and Training for Transforming SBE</u>	1611
Private Public Partnership Energy Efficiency Assessment Program at Hong Kong Aircraft Engineering Company, Xiamen facility, China	1611
Samuel KWONG, Matthew TANG	
Leveraging the Power of Story to Achieve Greater Sustainability	1616
James Scott BREW	
Embedding Sustainability in Higher Education Course Content: An Industry and Education Perspective	1620
Lloyd Martin SCOTT, Sushismita BHATTACHARJEE	
Importance of Built Heritage for World Sustainable Built Environment	1628
Shahid Ahmad RAJPUT	
Developing a Conceptual Framework for Integrating Project Risk Management and Sustainability Objectives	1634
Georgia Dodge GOSSE, Cheryl Julia Kiran DESHA, Timothy ROSE	

<u>Session 7.9: Transforming Green Market – Supply Chain</u>	1643
New Visitors? Small European Companies Entering the Chinese Sustainable Building Market	1643
Christian KOCH, Haixi LI, Yimin ZHAO, Anders LUTTEMAN	
Sustainable Electrical and Mechanical Services – Vision with Action.....	1649
CHEUNG Kwok-fai, Arthur WONG Kam-hay, CHAN Ming-ye	
Project Manager’s Role in Sustainable Building Projects: A Case Study in Canada.....	1655
Ricardo Ferreira LEOTO, Gonzalo LIZARRALDE	
A Study on Green Industry Project Construction Experience	1661
ZHANG Wei, WANG Hui	
The Economic Cost-benefit Analysis of Green Building Based on the Low-carbon Economic Policy	1667
Shiyu WAN, Yisheng LIU, Ming LAI	
<u>Poster Session</u>	1674
Study on Consumers’ Willingness to Pay for Products with a Green Building Material Label in Taiwan.....	1674
TSAY Yaw-shyan	
Improving the Relationship between Eco-Design and Environmental Education – A Case Study of Elementary Schools in Taiwan.....	1679
HUANG Wei-chih, TSAY Yaw-shyan, HO Shin-jia, HO Yen-yi	
Benefits of and Barriers to Green Building Implementation in Hong Kong.	1686
HUO Xiaosen, Ann TW YU	
Research on Development of a Guide for Environmental Study Classes Using Environment-conscious: Technologies of School Facilities	1692
Go MIYAZAKI, Yusuke NAKAJIMA	
Track 7: Innovative Practices for Transforming SBE	1699
<u>Session 1.10: Green Infrastructure in SBE - Hong Kong Cases</u>	1699
Implementing the Beautification and Sustainable Designs for the Harbour Area Treatment Scheme (HATS) Stage 2A	1699
Fergal WHYTE, David PICKLES, Mathew BAMB, Andrew LAI, WANG Shanshan, CHAU Kwok-ming, Anthony TSANG Kwok-leung	
Building Water Resilience in Sustainable Neighbourhoods: A Progressive Shift in Hong Kong.....	1705
Edmond W.F. LIU	
Integrating Water Management Facilities into The Built Environment – A Smart Green Resilient Approach	1710

Kenneth KWOK, LAU Wing-kam, CHUI Wai-lok, YAU Ka-tai, Katy FUNG, Peter CHAN

Driving Innovations for Green Infrastructure Components1717
Irene CHENG, Stephen YIM, Nicholas AU, Christine AU

Sustainable Engineering Practices in Landslip Prevention and Mitigation Works in Hong Kong.....1724
Harris LAM Wai-kei, Patrick HO Ho-man

Session 2.10: Transforming SBE Practices – Energy Management (1) 1730

Development of an Integrated Energy Simulation Tool for Buildings and MEP Systems, the BEST: A Pilot Study on Simulation of Demand Response with Cogeneration Systems 1730

Ryota KUZUKI, Makoto SATOH, Norie TSUJIMARU, Shuzo MURAKAMI, Takashi AKIMOTO, Hisaya ISHINO, Fumio NOHARA, Hiroshi NINOMIYA, Kenichi SASAJIMA, Tatsuo FUJII

Driving Ultimate Building Performance Through Smart E&M Systems for Sustainable Built Environment..... 1737
TAI Tak-him, Edmond CHEONG Siu-hung, CHAN Yiu-hon, Jovian CHEUNG Manchit

A Case Study to Automate Demand Response on a University Campus..1742
Thomas Mark LAWRENCE, Rick WATSON, Javad MOHAMMADPOUR, Marie-claude BOURDREAU, Sama AGHNIAEY, Justin HILL

Short-term Load Forecasting Model with Predicted Weather Data1748
ZHU Guangya, CHOW Tin-tai, Norman TSE

Session 3.10: Transforming SBE Practices – Energy Management (2)1755

Dynamic CO₂ and Occupancy Modelling for Predictive Control..... 1755
Alexandros PANTAZARAS, Mat SANTAMOURIS, LEE Siew-eang

Retro-commissioning Practice and In-depth Analysis Leading to Efficiency Optimization on HVAC Systems: Case Study on A Retail Mall in China ...1761
LI Wenpeng, ZHANG Ye, Raymond YAU, YS SO, KONG Wen-ping, Jean QIN

Study of Chiller Part Load Values for Hong Kong and Subtropical Climate1770
Tao LI, Christy CHOW, LEUNG Wai-ho, Alvin LO, Raymond YAU

HVAC System Design and Operation Performance of a Low-Carbon High-Rise Tenant Office Building Located in Tokyo1776
Yuichi TAKEMASA, Eikichi ONO, Shinichi HIROMOTO, Jun OWADA, Hideharu KOMODA, Masaya HIRAOKA

Optimizing Energy Efficiency for a High Rise Office Tower in Tropics.....1785
TANG Chee-khoay, Aida ELYANA, NG Yong-kong

<u>Session 4.10: Transforming SBE Practices – Energy Management (3)</u>	1793
Energy Data Transparency Benefits To Drive Down Of Energy Consumption Of A Commercial Hotel	1793
Conrad TC WONG, Antonio CM CHAN, Carmen YS WONG, Andrew NING, Albert TP SO	
ACT-Shop – A Retro-commissioning Scheme for Existing Buildings in Hong Kong.....	1800
Cary CHAN, Karen CHEUNG, Paul SAT	
Low-Carbon Building Environment Adaptation Countermeasures of Pingtung County.....	1807
CHANG Kuei-feng, KO Chien-hung, CHEN Ping-hung, CHOU Po-cheng, HUANG Lin-lin	
Impact of Energy Recovery Ventilation on the Ventilation and CO ₂ Concentration in One Bedroom Condominium in Thailand	1813
Daranee JAREEMIT, Panpisu JULPANWATTANA, Daranee JAREEMIT, Jittapat CHORUENGWIWAT	
<u>Session 5.10: Zero Energy</u>	1819
Achieving Net Zero: A Case Study of Hong Kong's First Zero Carbon Building	1819
Justin LI, Margaret KAM	
Life Cycle Greenhouse Gas Emissions of Material Use in the Living Laboratory..	1825
Marianne Rose KJENDSETH WIJK, Aoife Anne-Marie HOULIHAN WIBERG	
Paradoxical Feasibility of High-rise Zero Carbon Buildings.....	1831
PAN Wei, YU Cong	
Studies of Energy-Efficient Measures and Building Integrated Photovoltaic Towards Zero Energy Building.....	1837
LOU Siwei, Danny HW LI, Eric WM LEE, Joseph C. LAM, Stanley KH CHOW	
Net Zero Energy Building Policy: Benchmarking Australian Practices Against Some Asia Pacific Countries.....	1844
Usha IYER-RANIGA	
<u>Session 6.10: Innovative Practices to Transform SBE (1)</u>	1850
Comparative Analyses: Urban Quality, Living Standard, Sustainability. Modernist Housing Estate Vs 21st Century City.....	1850
Aleksandar TEPAVCEVIC	
Build Less and Make Cities Smarter by Unleashing Potential of Vacant Spaces	1857
CHAN Lai-kiu	

Green Transformation of Electrical and Mechanical Services Department Headquarters Building	1864
MAK Ka-chun, LEUNG Wing-hong, Dominic LAU Siu-kei	
Shaping Energetic Neighbourhoods: A Dynamic Approach for a Future Proof Urban Energy Planning.....	1870
Jürgen KNIES	
Building Drives for Behaviour Change – Role Model of Sustainability	1876
Ricky LI, Edwin CHAN, Tony LAM, Vincent CHENG	
<u>Session 7.10: Innovative Practices to Transform SBE (2)</u>	1883
A Revolutionary Study Commons and University Library Extension, The Chinese University of Hong Kong	1883
FUNG Siu-man, Thomas YUEN Ka-yiu	
Nearly Zero-Energy Care Home Design in Cold Climate in China	1889
HOU Shan-shan, Phil JONES, ZHOU Yanmin	
Preliminary Study on Natural Ventilation Efficiency in School Stadium by Different Opening Patterns	1897
LI Yenyi, CHUNG Poren, LIN Hungchun, CHIU Fongyu, CHEN Chen-yu	
Quantifying and Improving Environmental and Human Sustainability in Remote: Region Health Clinics, Australia	1904
Steve BURROUGHS	
Soaring of Urbanization: Optimized Approaches through Adaptive and Sustainable Masterplanning.....	1910
Antony HO, Rebecca KWAN, Kevin WAN, Vincent CHENG	
<u>Poster Session</u>	1919
Water Use of Thin-Layer Green Roof by Vertical-Flow Constructed Wetlands	1919
ENG Jr-jie, C.L. CHENG	
“Sponge City”, A Mental Experiment with Scientific Solution for “Sustainable Neighbourhood”.....	1926
James XIONG Jian, Jason YANG, TANG Yuqi, Simon TANG	
Track 8: Innovative Processes and Methodologies to Transform SBE	1933
<u>Session 1.11: Processes, Design, Tools and Methodologies in SBE (1)</u>	1933
Does the Sequence Matter? - Investigating the Impact of the Order of Design Decisions on the Life Cycle Performance	1933
Julia TSCHETWERTAK, Sven SCHNEIDER, Alexander HOLLBERG, Dirk DONATH, Jürgen RUTH	
Rethinking Architectural Passive Cooling Strategies in New Zealand’s Non- residential Building Stock.....	1939
Lesley METIBOGUN, George BAIRD	

Building in Existing Contexts – Densification	1945
Paul FLOERKE	
Problems and Prospects of Urban Compaction – A Case of Jaipur City ...	1955
Sakshi BANSAL, Satish PIPRALIA	
Where Planning Regulations and Development Practice Collide: The Multi- Storey Apartment Building in Subtropical Brisbane Australia	1961
Rosemary Jean KENNEDY	
<u>Session 2.11: Processes, Design, Tools and Methodologies in SBE (2)</u>	1967
Decision Making in the Pre-design Stage of Building Renovation Projects	1967
Anne N. NIELSEN, Tine S. LARSEN, Rasmus L. JENSEN, Søren B. NISSEN	
A Holistic Thriving Design Approach.....	1973
Dennis LEE	
Fostering Sustainable Buildings in Indonesia by Foreign Developer for Resilience	1979
Dennis MUI Heung-fu	
Reconsidering the Design of High-rise Mass Housing in Tropical Climates - A Case Study in Malaysia.....	1986
FOO Chee-hung, GAN Hock-beng, Zuhairi Abd HAMID	
Embodied Energy Versus Building Height, The “Premium” of Building Tall	1992
Rolf André BOHNE, Benedicte KASPERSEN, Julie LYSLO SKULLESTAD, Ejil YTREHUS	
<u>Session 3.11: BIM for Sustainability (1)</u>	1998
BIM Based Deep Building Renovation Optimisation for Sustainability.....	1998
HUANG Lizhen, Guri KRIGSVOLL, Bjørn Arild GODAGER, Anne Lise P. HELÅSEN	
Integrating BIM for Sustainable Planning, Design, Construction and Facilities Management for Hong Kong’s Public Housing Development.....	2005
Lawrence KW CHUNG, Edmund CHAN	
BIM Enabled Life Cycle Environmental Analysis for A Small Scale Zero Energy House.....	2011
YANG Wei, LI Qiyuan, YU Hanze, ZHANG Yifan	
The Use of FTA (Fault Tree Analysis) to Evaluate the Contribution of BIM Platform to The Environmental Quality on Rehabilitated Buildings.....	2020
Fabiana DIAS DA SILVA, Monica Santos SALGADO	
Sustainable Buildings with BIM.....	2026
Peter KONCZ	
<u>Session 4.11: BIM for Sustainability (2)</u>	2033

Assessment of Different Data Collection Methods for the Creation of BIM Models for Existing Buildings	2033
Bjoern Arild GODAGER, Guri KRIGSVOLD	
Boost Sustainability Certification by Using BIM.....	2040
Heinz J. BERNEGGER, Carsten K. DRUHMANN	
LCA Integration in BIM Through the Use of Integrated Dynamic Models ..	2046
Marios TSIKOS, Kristoffer NEGENDAHL, Jan Schipull KAUSCHEN	
Visualising Embodied Impacts Using Building Information Modelling (BIM)	2053
Martin RÖCK, Guillaume HABERT, Alexander PASSER	
Lifecycle Evaluation of Building Sustainability Using BIM	2060
Raja SHAHMIR, ZHANG Cheng	
Session 5.11: Processes, Design, Tool and Methodologies in SBE (3)	
Assessing Sustainable Urban Densification Using Geographic Information Systems.....	2066
Natasha CABRERA-JARA, Daniel ORELLANA, M. Augusta HERMIDA	
Traffic Quality Index to Intersections Considering Fuel Efficiency	2072
Fabianne Miranda AGUIAR, Marta Monteiro da Costa CRUZ, Gregório Coelho de MORAIS NETO, Adelmo Inacio BERTOLDE	
A Simulation-Based Method to Assess 3D Urban Noise Environment in High-Density Cities	2079
GUO Mengdi, HUANG Jianxiang	
Real Coded Quantum-Inspired Evolutionary Algorithm Applied to Sustainable Building	2086
Omar QUISPE POLANCO, Yvan TUPAC VALDIVIA	
Sustainable Neighbourhood Regeneration: Holistic Decision Support Methodology supported by a Software Tool.....	2095
Paul MITTERMEIER, Natalie EßIG, Ahmed KHOJA	
Session 6.11: Processes, Design, Tools and Methodologies in SBE (4)	
Evidence-Based Approach to Calibration of Whole Building Energy Model	2101
LAM Khee-poh, Adrian CHONG, XU Weili	
International LCA Data Network - Demonstration Project for an Open International Online Database Structure	2108
Tanja BROCKMANN, Hildegund FIGL, Oliver KUSCHE	
Noise Impact Assessment Study on High-performance of Sound Insulation for Residential Building at Neighboring Taiwan High Speed Rail Station ..	2114
LIN Wei, CHIANG Wei-hwa, HUANG Dan	

The Failures of Initial Commissioning, and its Impacts on Overall Building Performance.....	2120
Madeline Kathleen PARROTT	
Heating and Cooling Loads of a Poultry Shed in Central Coast, NSW, Australia	2127
ZHOU Yu, Asal BIDARMAGHZ, Guillermo NARSILIO, Lu AYE	
<u>Session 7.11: Processes, Design, Tools and Methodologies in SBE (5)</u>	2133
Measuring Sustainability in Buildings Using Construction Materials Database Based on Life Cycle Information in Turkey.....	2133
ilker KAHRAMAN, Hudai KARA	
When Digital Fabrication Provides Environmental Benefits: Study of Complex Structures	2141
Isolda AGUSTÍ-JUAN, Guillaume HABERT	
Sustainable Building Design for Enhancement of Street Ventilation and Air Quality Improvement	2147
Karl AN, Simon WONG Sze-ming, Jimmy FUNG Chi-hung	
Applicability of Maturity Assessment for Sustainable Construction.....	2155
Helmuth KREINER, Marco SCHERZ, Christian STEINMANN, Alexander PASSER	
Development of a Rotatable Outdoor Testbed and the Testing of an Integrated Auto-dimming Lighting and Automated Blind System in the Tropics	2161
ZHOU Jian, TAN Tian-chong, GAO Chun-ping, Selvam VALLIAPPAN, Alice GOH, Alvin SEOH, Sushanth BABU, Adrian LAMANO, ZHANG Zhe, Jatin SARVAIYA, WAN Man-pun, Yann GRYNBERG, Nakul NAPHADE	
<u>Poster Session</u>	2169
A BIM Based Integrated BIPV Design System.....	2169
YOU QI, OUYANG Antao, BAI Yang	
Design Strategies for Sustainability and Integration of Water Treatment Works – Case Study of Sha Tin Water Treatment Works, Hong Kong.....	2176
Aletta CHIU, Bevis W L MAK, Edward W K LEE	
Low-Carbon Transport Development Strategy of Coping with Climate Change-the Case of Pingtung County	2182
CHUNG Shih-yen, CHANG Kuei-feng, CHEN Ming-chang, KUO Wu-wei, CHEN Yu-jia	
Potential for Decreasing of Organizational Environmental Impacts Through Improvement of Property Energy Efficiency: A Case Study of Czech Ministry of Labour and Social Affairs.....	2188
Antonín LUPÍŠEK, Vladimír KOČÍ, Kateřina SOJKOVÁ, Kristina ZAKUCIOVÁ, Jiří TENCAR, Miloš LAIN, Miroslav URBAN, Jiří CÍGLER, Vladimír HORYNA	

A Preliminary Study on the Performance of Indoor Environment with Green BIM Tools - Taking Light Environment and Thermal Environment as an Example	2193
CHEN Nien-tsu, CHEN Ying-sheng, TSAY Yaw-shyan, LIN Chuan-hsuan	
Study on the Energy Efficiency of the Climatic Based Passive Design by Meinong Tobacco Barns in Kaohsiung	2199
LI Yen-yi, CHUNG Po-ren, LIN Hisn-I, TZENG Ping-chieh	
Sustainable Midfield Concourse Development at Hong Kong International Airport.....	2205
Kevin POOLE	
The Use of Recycled Aggregates for Full Depth of Sub-base in Pavement Construction in Hong Kong.....	2212
HUI Hok-tung	
Decision Making Process Assisted by Life Cycle Assessment: Greenhouse Gas Emission	2217
Ludimilla de Oliveira ZEULE, Laís David VINHAL, Sheyla Mara Baptista SERRA, Douglas BARRETO	
Building Life Cycle Assessment: Investigation of Influential Factors in a Helpful Decision Tool.....	2224
Marie-Lise PANNIER, Patrick SCHALBART, Bruno PEUPOORTIER	
Track 9: Transforming SBE Policies for People.....	2232
<u>Session 1.12: Regenerating Urban Space in Neighbourhoods</u>	2232
Cultivating a Village Impulse in the Midst of Warsaw, the Jazdów Settlement of Finnish Houses.....	2232
Dariusz ŚMIECHOWSKI	
Productive Transforming of the Urban Traffic Space	2239
ZHANG Yukun, HAN Dan, ZHANG Rui	
Nature-based Urban Space Transformation	2245
Kristin BARBEY	
Historic Relationship Between Urban Dwellers and the Tomebamba River	2252
Pablo OSORIO, Mateo NEIRA, M. Augusta HERMIDA	
Transformation from River Channelisation to River Revitalisation.....	2258
Richard LEUNG Wah-ming, Ivan NG Yu-ting, Stanley CHAN Chi-wai, Alex WU Yat-fei	
<u>Session 2.12: Process of Urban Regeneration</u>.....	2265
Energy Benchmarking Tool for Low-Carbon Transformation in Hong Kong: A Scientific Approach and Its Practical Applications.....	2265

Jason JZ YANG, Alvin TY LO, Karen HY CHEUNG, Cary WH CHAN, Benny KM CHOW, Paul SK SAT

Sustainability Indicators for the Assessment of the Energy System2272
 Lisa ANDES, Thomas LÜTZKENDORF, Jürgen KOPFMÜLLER, Christine RÖSCH

Creating Methods, Procedures and Tools for a More Sustainable
 Neighbourhood Development – Experiences from Germany2279
 Maria BALOUKTSI, Thomas LÜTZKENDORF, Jürgen KOPFMÜLLER, Volker
 STELZER

How Can We Assess the Achievement of The Sustainable Development Goals?
 – A Review of Indicators and Their Application at the City Level2285
 Roland ZINKERNAGEL

Session 4.12: Healthy Building, Human Comfort & Wellbeing2293

Healthy Buildings and Energy Performance – A Balancing Act2293
 Eriko TAMURA, Mark RICHARDSON

Significance of Sky Gardens for Healthy High-Rise Living of Urban Children
 and Old Adults2299
 Tony IP

Radon Infiltration in Rented Accommodation2307
 Torben Valdbjørn RASMUSSEN

A Case Study on Industrial Building IEQ Control and Operation Performance
 Analysis2314
 ZHANG Wei, WANG Hui

Research on the Strategies and Methods in Productive Green Renovation of
 Existing Urban Communities2321
 ZHANG Yukun, DING Xiaoying

Session 5.12: Occupants' Evaluation of Green Buildings2327

Users' Perceptions of Building Performance – An Analysis of the Occupants'
 Comments2327
 George BAIRD, Sara WAREING

Cooperative Research for High Performance Buildings2334
 Herbert Claus LEINDECKER, Armin WEBERBERGER

The Role of Perceived Social and Physical Environments on Older Adults'
 Social Interactions2340
 Piret VEEROJA, Greg FOLIENSTE, Rod MCCREA, Hannah BADLAND, Chris
 PETTIT

Every Breath We Take – Transforming the Health of China's Office Space2347
 Matthew CLIFFORD, Steven MCCORD, Eric HIRSCH, WU Xuchao, Louie
 CHENG, Linda YU

Are Patterns of Use the Key to Resource Efficiency in Office Buildings? ..2353
Ken DOOLEY, Davor STJELJA

Session 6.12: Green Buildings – Occupants' Perspectives.....2361

Sculpting Socially Sustainable Neighbourhoods2361

Thermal Comfort Based Occupancy-driven Building Energy Saving Control Strategies2366

The Effect of Occupant Behaviour on Real-time Electricity Consumption in Canadian School Spaces2371

Deep Green Approach to Create Sustainable Built Environment and Neighbourhoods, Case study of Lumpini Place Rama 4- Ratchada Project2378
M+, Sustainable Design for a Contemporary Art Museum in Hong Kong ..2384

Session 7.12: Multi-facet Considerations of Urban Regeneration

Policies.....2390

The Role of Stakeholders in Masterplan Regeneration Decisions.....2390
Hannah BAKER, Alice MONCASTER

Effect of Residential Tower Geometries on Urban Wind Environment2399
Ruffina THILAKARATNE, Paul CHU, XIAO Yana

Health Co-Benefits of Low Carbon Policies in the Built Environment: An Australian Investigation into Local Government Co-Benefits Policies.....2406
Sardar Masud KARIM, Susan THOMPSON, Peter WILLIAMS

Bai Wan Zhuang, A Beijing Community at The Crossroads - An Analysis About the Sustainable Update of Chinese Old Distinctive Residential Areas2418
WANG Liang

Methodology for a Sustainable Urban Regeneration: Urban Cell as Dissemination Unit.....2426
Miguel AMADO, Ines RAMALHETE

Poster Session.....2433

Urban Regeneration Introduced with Resilient City Concept - A Case Study of Pingtung City in Taiwan2433
CHANG Kuei-feng, CHANG Wan-ting, LIUNG Hing-heng, WONG Wei-jin

The Status and Operation Issues Related to Covered Playgrounds of Elementary Schools.....2440
HSIEH Hung-ren, LI Ming-da

Study of Public Mood Based on Sentiment Analysis in the City of Bandar Lampung, Indonesia2446
Munawir, Fritz Akhmad NUZIR, Bart Julien DEWANCKER

Track 10: Place-making & Community Empowerment2452

<u>Session 3.13: Community Empowerment (1)</u>	2452
The Strategy of Launching Rural Regeneration in Pingtung County Government.....	2452
Hung Chieh-jen, CHANG Kuei-feng, LIUNG Hing-heng, LU Yuan-hua 2030 Districts: Putting Ideas into Action.....	2457
Yaki WO, Jiri SKOPEK, Vincent MARTINEZ, David LOW, LI Jiexin	
A Critical Discussion on the Role of Architectural Practice in Development of Rural China: For Living Sustainably.....	2462
LI Ke-han, Edward NG	
Retrofit or behaviour change? Which Has the Greater Impact on Energy Consumption in Low Income Households?	2469
Melissa JAMES, Michael AMBROSE	
Towards a Holistic Methodology: A Practical Approach to Local Energy Planning	2470
Thomas SCHLUCK, Matthias SULZER	
<u>Session 4.13: Community Empowerment (2)</u>	2477
'Pride the Civilians Motivator for Resilient Sustainable Cities' Results of the 2016 Questionnaire Research Under Dutch Amsterdam Council Members	2477
Fred SANDERS	
Enhance Public Sustainability Awareness by Feng Shui.....	2486
Patrick LUI Yin-park, Michael Y MAK	
Social Sustainability.....	2492
Ada FUNG, Irene CHENG, Stephen YIM, Clarence FUNG, Cynthia CHU	
The Application of Social Innovation in Designing an Aged Care Centre in Malaysia	2498
Thomas TANG Sek-khuen	
Ritualized Place and Community Empower	2505
Wasana DE SILVA	
<u>Session 5.13: Stakeholder Collaboration</u>	2511
Green Management by Stakeholder Empowerment – The Hong Kong Housing Authority Experience.....	2511
Ada FUNG, Irene CHENG, Rosman WAI	
CoLLaboratoire Montreal: Living Experiments for Climate Change Awareness.....	2517
Carmela CUCUZZELLA	
Putting Regenerative Development into Action: Understanding the Decision Making Process of a 680 Hectare Regenerative Project.....	2523
Dominique HES, André STEPHAN, Sareh MOOSAVI	

Gamification as a Means to User Involvement in Decision-Making Processes for Sustainable Buildings	2531
Hanne Tine Ring HANSEN, Mary-ann KNUDSTRUP, Stine Skøtt PEDERSEN	
Accelerating HKIA's Carbon Footprint Reduction through Multi-stakeholder Engagement and its Potential for Multi-tenant Facilities.....	2537
Mike KILBURN, Stephen CHAN	
<u>Session 6.13: Place-making – Integrative Design Processes</u>	2543
Integrated Design Guidance for The Early Process Phase - PLENAR – ...	2543
Günter LÖHNERT, Sabine DORN-PFAHLER, Jessica STRITTER, Andreas DALKOWSKI	
Responsive Design – The Innovative Approach to Create Sustainable Neighbourhoods and Cities	2549
Mary CHAN	
Conceptualizing Sustainable Neighbourhoods through Collaborative Placemaking.....	2555
Solomon ADEWUMI, Husam ALWAER, Vincent ONYANGO	
A Conceptual Model of Integral Sustainable Design Framework.....	2561
Wilson YIK, Dicken POON, Matthew LEE, Ivy S. W. LEE	
From Environmental to Social and Cultural Sustainability.....	2569
Bryant LU, Peter YAM	
<u>Session 7.13: Place-making – Practices Review</u>	2574
From Icon to Community: Repositioning the Image of the Modern Mega-Towe	2574
Bryant LU, Guymo WONG	
Do We Design Our Cities?.....	2584
Eugenio Maria FONTAN YANES, Jorge BENEITEZ	
Sustainable Residential Building Developments Towards Neighbourhood Level: From A Hong Kong Private Developer's Perspective	2590
Kevin NG, Edward CHAN	
New Exposition of Sustainability – Linking People, Building and Community.....	2596
Gary CHEUNG, Teri TAN, Alvin LO, Gary LEUNG, Chris KWAN	
Sustainable Workplaces in High Density Urban Areas.....	2603
Ryusuke KOJIO	
<u>Poster Session</u>	2612
Estate Revitalization Scheme Ping Shek Estate: Pilot Project Completed	2612
WONG Man-lung, LAM Ho-yin	

The Study of Pavement Reconstruction Corresponding to Microclimate Cooling Efficiency in Elementary School Campus.....	2618
KAO Kuo-sheng, LIN Hung-chun, LI Yen-yi, CHUNG Po-ren, LIN Chia-hsiung	
Kai Tak Development – Migrating Towards Vision.....	2624
YING Fun-fong, Sunny LO	
Sustainable Interior Environments for Historic Buildings: A Case Study of the Presidential Palace of San Anton, Malta.....	2635
Amber WISMAYER, Carolyn S. HAYLES, Nick MCCULLEN	
Café des Visions: How to Anticipate and Consolidate Urban Negotiation through Art; a Practice-based Artistic Research.....	2641
Anna GRABER	
Track 11: Sustainable Neighbourhoods: Applications and Case Studies	2654
<u>Session 5.8: Sustainable Neighbourhoods - Case Study Review (1)</u>	2654
Learning from The Lessons of Transit-Oriented Development to Improve Urban Planning in China.....	2654
Frederic Daniel DU VERLE, Becky PY LOO	
A Green Campus Master Plan - The Chinese University of Hong Kong (CUHK).....	2661
FUNG Siu-man, Thomas YUEN Ka-yiu, Stephen HO Kin-wai	
Stepping Up to the Water-Energy Nexus Challenges at Tai Po Water Treatment Works.....	2668
Jeffrey LAI Siu-ming, Alan MAN Hoi-leung, Henry MAK Kei-choi	
Development Strategies for The Green Industry in Pingtung County	2674
KUO Wu-wei, HSU Wen-chi, CHANG Kuei-feng, WANG Yu-jie	
Strategic Planning for Sustainable Neighbourhoods: A Case Study from Palestine.....	2678
Sameer ABU-EISHEH, Muhannad HAJ HUSSEIN, Deemah SALAMEH	
<u>Session 6.8: Sustainable Neighbourhoods - Case Study Review (2)</u>	2685
Urban Regeneration Introduced with Resilient City Concept - A Case Study of Pingtung City in Taiwa	2685
CHANG Kuei-feng, LEE Ju-yii, NI Kuo-chun, PU Po-yen	
The District Cooling System at the Kai Tak Development.....	2692
CHAN Pak-cheung, LO Siu-kuen, NG Ting-sing	
Study on Business Scheme of a Community-wide Decentralized and Self-reliant Energy Network - Allocation of Co-benefits and Evaluation of Socio-environmental & Economic IRR.....	2699

Ryota KUZUKI, Shuzo MURAKAMI, Toshiharu IKAGA, Takahiro KAWAYOKE,
Yuichi IKUTA, Tsutsumi KOMIYAMA

Policy Framework and Instruments for Green Transformation in East Asia2707
Vincent CHENG

Session 7.8: Sustainable Neighbourhoods – Processes and Application2713

Current Challenges of Urban Energy Planning in a Norwegian Municipality2713
Eirik RESCH, Inger ANDRESEN

Citylab Action: Guiding Sustainable Urban Development.....2719
Jonas LIND, Josefin WANGEL, Ann-Kristin BELKERT, Tove MALMQVIST

The Break-Even Point: Impact of Urban Densities on Value Creation,
Infrastructure Costs and Embodied Energy2725
Serge SALAT

Barriers and Needs for Energy-Efficient Refurbishment at District Level2734
Tarja HAKKINEN, Samo GOSTIC, Nusrat JUNG

Building Regulations and Urban Policies as Incentives for Application of
District Cooling Systems in Singapore2741
SHI Zhongming, Jimeno A FONSECA, Arno SCHLUETER

Poster Session.....2746

The Exploration of Sustainable Neighbourhoods - A Case Study of
Shenyang2746
LI Li-hong, WANG Zhuo

Track 12: Emerging Green Construction Technology and Materials2752

Session 4.6: Green Construction Technologies (1)2752

Watering Type and Water Consuming Assessment of the Green
Construction Fence in Taichung City, Taiwan2752
CHEN Chen-chun, CHAO Yu-chan, LAI Wan-ting

Low Carbon Construction Implementation in a Public Housing Development
and the Implication to the Life Cycle Decision Making Tool2758
Felix WONG Yat-hang, TANG Yu-tin

Use of Incineration Bottom Ash for Road Construction in Singapor2765
HO Nyok-yong, Kelvin LEE Yang-pin, YAP Cheng-chwee, TONG Kum-kong, LIM
Chong-teik

Exploring the Relationships between Construction Phases and Sustainable
Construction Principles2771
Olabode Emmanuel OGUNMAKINDE, William David SHER, Kim MAUND

Session 5.6: Green Construction Technologies (2)2779

Innovative Building Technologies and Technical Equipment Towards Sustainable Construction: A Comparative LCA and LCC Assessment.....	2779
Alexander PASSER, Gernot FISCHER, Richard DEUTSCH, Petra SÖLKNER, Sebastian SPAUN	
A Peer-To-Peer Reviewing Framework for Selecting Construction Material Suppliers Using the Integration of Building Information Modelling and Web-Map Service	2786
CHEN Po-han, NGUYEN Thanh-chuong	
Improving the Supply Chain of Housing Industrialization from Transaction Costs Perspective: A Literature Review	2792
WU Hongjuan, Queen K QIAN, Henk VISSCHER, Ad STRAUB	
A Research Proposal to Improve the Environmental Performance of the Building Industry by Increasing the Innovation Activity of Small Contractors	2798
Karen Jane MANLEY, Timothy ROSE	
Mongolia's First Cooperative Transformation Attempt on Built Environment through Greening Kindergarten Building	2806
Nergui DORJ	
<u>Session 6.6: Green Construction Materials (1)</u>	2811
Naturally Ventilated Earth Timber Constructions	2811
Andrea KLINGE, Eike ROSWAG-KLINGE, Christof ZIEGERT, Patrick FONTANA, Matthias RICHTER, Johannes HOPPE	
The Study on Durability Testing of Heat-insulation Coating	2818
CHEN Chien-fu, HUANG Yuan-chang, HO Ming-chin, LIN Yu-hsin, LEE Shin-ku	
Utilizing Palm Rachis for Eco-Friendly and Flexible Construction in Egypt	2824
Yasser MANSOUR, Hamed ELMOUSLY, Eman Atef DARWISH	
Bamboo for the 21st Century	2834
Martin TAM Tin-fong	
Community Empowerment through Mud-Concrete Technology: Sustainable Building Techniques to Revitalise the War Victim Communities in Batticaloa, Sri Lanka	2843
Rizna AROOZ, Rangika HALWATURA, Chameera UDAWATTE	
<u>Session 7.6: Green Construction Materials (2)</u>	2850
Self-Compacting Clay Concrete: A Sustainable and Innovative Process to Build with Earth.....	2850
Gnanli LANDROU, Coralie BRUMAUD, Guillaume HABERT	
Trend of Dynamic Glass in Green Building	2857
HY CHIU	

Upgraded Mineral Sand fraction from MSWI Bottom Ash: An Alternative Solution for the Substitution of Natural Aggregates in Concrete Application 2865
 Jacques Rémy MINANE, Frédéric BECQUART, Nor-Edine ABRIAK, Christophe DEBOFFE

Autonomous Repair in Cementitious Material by Combination of Superabsorbent Polymers and Polypropylene Fibres: A Step Towards Sustainable Infrastructure2866
 Souradeep GUPTA, KUA Harn-wei, PANG Sze-dai

Poster Session2874

Study on the Shading Performance of Expanded Metal Mesh2874
 LIN Chien-hsun, TSAY Yaw-shyan, YANG Jih-hong, YANG Yu-fang

The Research of Enhancing the Performance of Impact Sound Insulation in Wooden Structure Floor.....2881
 LIN Fang-ming, FENG Chun-hao, TSAI Yueh-han

Construction of Green Residences for Ecological Immigrants - A Case Study of Ningqiang Area in the South of Shaanxi Province, China2887
 HE Jiao, LI Jing, LIU Yu, WANG Ding

Optimization of Aggregates for Sustainable Low Cement Concrete for Interlocking Concrete Block Pavers2894
 Chamod Kosala HETTIARACHCHI, Wasantha Kumara MAMPEARACHCHI

Development of a Functional Interior Material Using Scallop Shell Lime...2901
 Souradeep GUPTA, KUA Harn-wei, PANG Sze-dai

Research on Environmental Safety of Nanomodified Building Materials ...2907
 Petr ZHUK

VIII. AUTHOR INDEX	2912
IX. ACKNOWLEDGEMENT	2923

WSBE17 Hong Kong: THE MOST INFLUENTIAL GREEN BUILDING MEGA EVENT

The Construction Industry Council and the Hong Kong Green Building Council jointly welcome you to participate at the World Sustainable Built Environment Conference 2017 Hong Kong (WSBE17 Hong Kong).

Pre-eminent Conference Series

The Sustainable Built Environment (SBE) series began in 2000 and is now the pre-eminent international conference series on sustainable building and construction. The series operates on a three-year cycle with planning in year one, regional conferences in year two and a global conference in year three. Albeit strong competition, Hong Kong won the hosting right of the 2015-2017 cycle global conference, which will conclude the conference cycle by embracing all the top findings from the 20 regional conferences held in 2016.

About WSBE17 Hong Kong

With the theme of **Transforming Our Built Environment through Innovation and Integration: Putting Ideas into Action**, WSBE17 Hong Kong will bring together **1,800** green building advocates, policy-makers, academics, and industry practitioners from over **55 countries**. The three-day event includes conference sessions with top-notch speakers, and around 100 parallel sessions, with an exhibition alongside.



Organisers

Construction Industry Council (CIC)

The Construction Industry Council (CIC) was formed in 2007 under the Construction Industry Council Ordinance (Cap. 587). The CIC consists of a chairman and 24 members representing various sectors of the industry including employers, professionals, academics, contractors, workers, independent persons and Government officials.

The main functions of the CIC are to forge consensus on long-term strategic issues, convey the industry's needs and aspirations to Government, provide training and registration for the construction workforce and serve as a communication channel for Government to solicit advice on all construction-related matters.



Hong Kong Green Building Council (HKGBC)

The Hong Kong Green Building Council (HKGBC) is a non-profit, member led organisation established in 2009 with the vision to help save the planet and improve the wellbeing of the people of Hong Kong by transforming the city into a greener built environment. The Founding Members of the HKGBC include the Construction Industry Council (CIC), the Business Environment Council (BEC), the BEAM Society Limited (BSL) and the Professional Green Building Council (PGBC). Its mission is to lead market transformation by advocating green policies to the Government; introducing green building practices to all stakeholders; setting design, construction and management standards for the building profession; and promoting green living to the people of Hong Kong.



Message from Chairman of WSBE17 Hong Kong Organising Committee

Ir Conrad WONG Tin-cheung, BBS, JP

It has been my great honour to work closely with all Organising Committee and Scientific Committee members, and the Conference Secretariat, to bring WSBE17 Hong Kong to life. Since winning the hosting rights in 2014, the Organising Committee has dedicated itself to creating the best world conference ever; one that can inspire in-depth discussions and create a long-lasting impact on the transformation of our built environment, particularly in the interconnected domains of 'Policy & Standards', 'Practice & Business', 'Science & Technology' and 'People & Community'.



The Committee has worked hard for many years to reach this moment. Now, all that remains is for me to wish all delegates an enjoyable, thought-provoking and inspirational time at this important conference.

The planet urgently needs our help. Together, we can create a brighter future for all mankind.

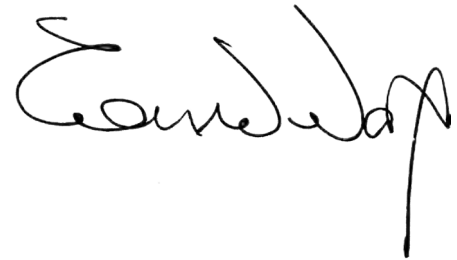
A handwritten signature in black ink, which appears to read 'Conrad Wong'. The signature is fluid and cursive.

Ir Conrad WONG Tin-cheung, BBS, JP

Chairman

WSBE17 Hong Kong Organising Committee



Honorary Advisors

International Conference President of Past World SB Conferences

Mr Felipe PICH-AGUILERA

Ms Helena SOIMAKALLIO

Prof. Greg FOLIENTE

Prof. Shuzo MURAKAMI

Mainland China

Dr QIU Baoxing

Prof. JIANG Yi

Hong Kong

Mr Matthew CHEUNG Kin-chung , GBS, JP

Mr Eric MA Siu-cheung , JP

Mr WONG Kam-sing, GBS, JP

Prof. Anthony CHEUNG Bing-leung, GBS, JP

Sr CHAN Ka-kui, BBS, JP

Sr WONG Bay

Position and Organisation

President, WSB14 Barcelona

Chair, Local Organising Committee of WSB11 Helsinki

Co-Chair, WSB08 Melbourne

Chair, the National Conference Board WSB05 Tokyo

Position and Organisation

Representative of the Ministry of Housing and Urban-Rural Development & Counsellor of Counsellor's Office of the State Council of PRC

Member, China Academy of Engineering; Director, Building Energy Conservation Research Center (BERC), Tsinghua University

Position and Organisation

Chief Secretary for Administration,
Government of the HKSAR

Secretary for Development, Government of the HKSAR

Secretary for the Environment,
Government of the HKSAR

Secretary for Transport and Housing,
Government of the HKSAR

Chairman, Construction Industry Council

Chairman, Hong Kong Green Building Council



Organising Committee

Chairman

Ir Conrad WONG

Chairman of Scientific Committee

Ir Prof. WONG Sze-Chun

Vice Chairman of Scientific Committee

Dr Benny CHOW

Members

Mr Nils LARSSON

Mr Albert LAM

Mr Vincent LIU

Ms Ada FUNG

Sr Sam CHENG

Ir CHOW Lap-man

Ir Prof. CHOY Kin-kuen

Mr Evans IU

Ar. Robert LAM

Prof. John NG

Ir Dr Otto POON

Sr WONG Bay

Representation

CIC & HKGBC

Representation

CIC & HKGBC

Representation

CIC & HKGBC

Representation

SBE Series Co-owner Representative

Development Bureau, Government of the HKSAR

Environment Bureau, Government of the HKSAR

Transport and Housing Bureau, Government of the HKSAR

HKGBC

HKGBC

HKGBC

HKGBC

CIC & HKGBC

HKGBC

HKGBC

CIC & HKGBC



Scientific Committee

Hong Kong

Chairman

Ir Prof. WONG Sze-chun

Representation

CIC & HKGBC

Vice Chairman

Dr Benny CHOW

Representation

CIC & HKGBC

Chairman of Sub-Committee on Conference Programme

Ar. LEUNG Man-kit

Ronald Lu & Partners (Hong Kong) Limited

Chairman of Sub-Committee on Paper Submission & Review

Ir Prof. POON Chi-sun

Department of Civil and Environmental Engineering,
The Hong Kong Polytechnic University

Chairman of Sub-Committee on Indexation & Proceedings

Dr Benny CHOW

CIC & HKGBC

Chairman of Sub-Committee on International Youth Competition

Prof. Edward NG

School of Architecture, The Chinese University of Hong Kong



Members

Sr Kenneth CHAN

Dr William CHAN

Mr CHAN Kwong-fat

Mr CHAN Pak-cheung

Prof. Christopher CHAO

Ir Dr Vincent CHENG

Ir Victor CHEUNG

Ir Colin CHUNG

Cr Paul CHUNG

Mr Kevin EDMUNDS

Ms Ada FUNG

Dr Paul HO

Sr Vincent HO

Ir John KWONG

Sr Junkers LAM

Mr Robert LAM

Prof. Andrew LEUNG

Prof. Thomas NG

Prof. NIU Jian-lei

Ar. Larry POON

Dr Peter Cookson SMITH

Ar. William TSENG

Mr WONG Tak-yip

Mr WONG Wai-kwong

Mr Andy YEUNG

Ms Lily YAM

Representation

BEAM Society Limited

The West Kowloon Cultural District Authority

The Hong Kong Federation of Electrical & Mechanical Contractors Limited

Electrical & Mechanical Services Department, Government of the HKSAR

School of Engineering, The Hong Kong University of Science & Technology

Ove Arup & Partners Hong Kong Limited

The Hong Kong Institution of Engineers

Parsons Brinckerhoff (Asia) Limited

The Hong Kong Institute of Construction Managers

Hong Kong Science & Technology Parks Corporation

Hong Kong Housing Authority;
Transport and Housing Bureau, Government of the HKSAR

Professional Green Building Council

The Hong Kong Institute of Surveyors

Development Bureau, Government of the HKSAR

Buildings Department, Government of the HKSAR

Wong & Ouyang (HK) Limited

-

Department of Civil Engineering, The University of Hong Kong

Department of Building Services Engineering,
The Hong Kong Polytechnic University;
Energy and Buildings Journal

Wong Tung & Partners Limited

The Hong Kong Institute of Urban Design

The Hong Kong Institute of Architects

The Hong Kong Institute of Landscape Architects

Architectural Services Department, Government of the HKSAR

Business Environment Council Limited

Planning Department, Government of the HKSAR



Scientific Committee

Mainland China & International

Members

Dr Wim BAKENS

Prof. CHENG Cheng-li

Prof. Raymond COLE

Prof. Kazuo IWAMURA

Prof. JIANG Yi

Prof. Philip JONES

Prof. LI Baizhan

Prof. Joseph LI

Prof. LIN Borong

Prof. LIN Tzu-ping

Prof. MENG Qinglin

Prof. Shuzo MURAKAMI

Prof. WANG Jun

Prof. WANG Qingqiu

Ms YE Qing

Representation

SBE Series Co-owner Representative

Department of Architecture, National Taiwan University of Science and Technology, Taiwan

School of Architecture and Landscape Architecture, University of British Columbia

Japan GreenBuild Council

Building Energy Conservation Research Centre, Tsinghua University

Welsh School of Architecture, Cardiff University

Chongqing University;
China Green Building Council

Graduate Institute of Architecture and Interior Design Shu-Te University, Kaohsiung, Taiwan

School of Architecture, Tsinghua University;
Youth Committee of China Green Building Council

National Cheng Kung University, Taiwan

School of Architecture, South China University of Technology

The Institute for Building Environment and Energy Conservation

China Academy of Building Research

China Academy of Building Research

Shenzhen Institute of Building Research;
China Green Building Council



Message from Chairman of Construction Industry Council

Sr CHAN Ka-kui, BBS, JP

It is my great pleasure to offer a warm welcome to all delegates coming to Hong Kong for WSBE17 Hong Kong. The Construction Industry Council is proud to be a co-organiser of this important event, which provides a platform that inspires and enables transformation in both the construction industry and the built environment, locally and worldwide.



The Hong Kong construction industry has achieved a great deal in the last decade, from ground-breaking research to innovative new projects. We are delighted to share our experiences with delegates from around the world.

This landmark conference offers valuable insights from the six world renowned keynote speakers, as well as the collected wisdom and experience of the other 400 distinguished speakers. The three-day conference will lead to fruitful discussions and provide a strong foundation for putting ideas into action, which will benefit the long-term sustainability of communities around the world.

A handwritten signature in black ink, appearing to read 'Chan Ka-kui' followed by a period. The signature is fluid and cursive.

Sr CHAN Ka-kui, BBS, JP

Chairman
Construction Industry Council



Message from Chairman of Hong Kong Green Building Council

Sr Bay WONG

The SBE16/17 conference series has, for the first time, expanded its focus from buildings to the overall built environment. It is fitting, therefore, that the series reaches its conclusion in Hong Kong, where our high-rise and high-density built environment poses a number of unique challenges. I believe that our experience in meeting and overcoming these challenges has great value for urban environments around the world.



This high-profile, global conference WSBE17 Hong Kong brings together more than 1,800 of the world's leading green building experts from 55 countries around the planet. I offer my sincere thanks to the Construction Industry Council for its wholehearted support in organising this important event, and to the Government of the HKSAR and the local construction industry for helping us to make this event a success.

On behalf of the HKGBC, I warmly invite you to join hands with us and work together to create a sustainable built environment in communities around the world.

A handwritten signature in black ink, appearing to read 'S Wong', written in a cursive style.

Sr Bay WONG

Chairman

Hong Kong Green Building Council



Message from Chief Executive of the Hong Kong Special Administrative Region

Hon. LEUNG Chun-ying, GBM, GBS, JP

I am very pleased to welcome some 1800 green building professionals from about 50 countries to Hong Kong for the World Sustainable Built Environment Conference (WSBE), 5-7 June. This is the first WSBE Conference to take place in Hong Kong, and it is an honour to host this significant international event as part of our celebrations for the 20th anniversary of the establishment of the Hong Kong Special Administrative Region.



The theme of this year's Conference "Transforming Our Built Environment through Innovation and Integration: putting Ideas into Action", is both timely and apt. I have no doubt that the Conference's innovative ideas and collaborative efforts will help us build a smart and green Hong Kong and, in doing so, contribute to the growing global movement to combat climate change.

I wish you every success at the Conference and a memorable stay in Hong Kong.

A handwritten signature in black ink, appearing to be 'W. C. Y.', which is a stylized representation of the name Leung Chun-ying.

Hon. LEUNG Chun-ying, GBM, GBS, JP

Chief Executive
Hong Kong Special Administrative Region



Message from Chief Secretary for Administration, Government of the HKSAR

Mr Matthew CHEUNG Kin-chung, GBS, JP

I offer my warmest congratulations to the Construction Industry Council and the Hong Kong Green Building Council on hosting the World Sustainable Built Environment Conference 2017 in Hong Kong. This year has a special and historic significance as it marks the 20th anniversary of the establishment of the Hong Kong Special Administrative Region. The conference is one of the flagship events celebrating this auspicious occasion.



Against the backdrop of a growing consensus on the need to combat climate change, global citizens nowadays have rising aspirations for an urban built environment which is sustainable, green and smart. As a vibrant, high-density and high-rise international city, Hong Kong is an ideal place for green building advocates, policymakers and academics from all over the world to come together and discuss how to build a sustainable future. Under the theme “Transforming Our Built Environment through Innovation and Integration: Putting Ideas into Action”, the Conference provides an invaluable platform for experts to share their expertise, innovative ideas, rich experience and insights on the common vision for sustainability.

The Hong Kong Special Administrative Region Government is committed to turning Hong Kong into a greener metropolis. We have, in collaboration with the industry, spearheaded the development of a sustainable built environment. The wide range of initiatives already put in place include imposing mandatory requirements, providing the private sector with incentives, encouraging government departments to lead by example and driving behavioural change in society. On top of all these, we announced earlier this year Hong Kong’s Climate Action Plan 2030+, which not only outlines our longer-term action to combat climate change but also sets out the carbon emission reduction target for 2030. As a member of the global village, Hong Kong needs to respond proactively to this cross-sector, cross-domain subject. With this in mind, we will continue to work closely with various sectors of the community and the general public to make our city more climate-resilient in the long run.

I would like to take this opportunity to extend my deepest gratitude to the hosts, co-owners, organisers, sponsors and participants for making the event possible. I wish the Conference every success and all overseas participants a rewarding and pleasant stay in Hong Kong.

A handwritten signature in black ink, appearing to read 'Matthew Cheung'. The signature is fluid and cursive, with a long horizontal stroke at the end. It is positioned above the printed name and title.

Mr Matthew CHEUNG Kin-chung, GBS, JP
Chief Secretary for Administration
The Government of the Hong Kong Special Administrative Region



Message from Secretary for Development, Government of the HKSAR

Mr Eric MA Siu-cheung, JP

I am delighted to offer my congratulations to the successful organisation of the World Sustainable Built Environment Conference 2017 in Hong Kong which has come to its 7th edition.

The ascension of the Conference from sustainable building in the 2014 edition held in Barcelona to sustainable built environment in the current edition is a remarkable achievement of the campaign for sustainable development. The move from focusing on the significance of individual sustainable buildings to encompassing the constituent fabrics for the built environment will definitely enhance the performance of the construction industry in combating climate change. I am certain that the local industry and participants coming from all over the world have longed to share together their brilliant ideas and prominent achievements in the global movement. Our joint efforts will be crucial and instrumental in shaping the living environment for our future generations. May I extend my heartfelt gratitude to the Construction Industry Council and the Hong Kong Green Building Council for their great efforts and wish the Conference a resounding success.



A handwritten signature in black ink, appearing to read 'Eric Ma'.

Mr Eric MA Siu-cheung, JP

Secretary for Development

The Government of the Hong Kong Special Administrative Region



Message from Secretary for the Environment, Government of the HKSAR

Mr WONG Kam-sing, GBS, JP

Let me extend my best congratulations to the successful organisation of the World Sustainable Built Environment Conference (WSBE) 2017 in Hong Kong. As a densely-populated world city where about 90% of the population lives in high-rise buildings, Hong Kong offers a unique setting for participants from around the world to discuss the challenges and strategies for sustainable built environment. The WSBE signifies the commitment to sustainable buildings which are important in preparing us to be “climate ready”. I am sure that participants will benefit from the discussions and exchanges that will help shape a sustainable built environment. My sincere gratitude goes to the Hong Kong Green Building Council and the Construction Industry Council for their outstanding contribution. I wish the WSBE 2017 a great success.



A handwritten signature in black ink, appearing to read 'Wong Kam-sing'.

Mr WONG Kam-sing, GBS, JP

Secretary for the Environment

The Government of the Hong Kong Special Administrative Region



Message from Secretary for Transport and Housing, Government of the HKSAR

Prof. Anthony CHEUNG Bing-leung, GBS, JP

I convey my warmest congratulations to the Hong Kong Green Building Council and the Construction Industry Council for the successful organisation of the WSBE17 Hong Kong Conference. Hong Kong is one of the most densely populated cities in the world. Driven by the vision to provide a better living environment for our citizens, the Government has been actively exploring new and innovative means towards green building development without compromising our environment. I sincerely wish all participants from round the globe to join hands in our common mission to “Put Ideas into Action” for a greener Earth with livable and sustainable environment.



A handwritten signature in black ink, reading "Anthony Cheung".

Prof. Anthony CHEUNG Bing-leung, GBS, JP

Secretary for Transport and Housing

The Government of the Hong Kong Special Administrative Region



Day 1 • 5 June 2017 (Mon)

08:00 - 09:00	Registration			
09:00 - 10:00	Opening Ceremony Welcome Remark Ir Conrad WONG , Chairman, WSBE17 Hong Kong Organising Committee Opening Remark Hon. LEUNG Chun-ying , Chief Executive, Hong Kong Special Administrative Region Dr QIU Baoxing , Representative of The Ministry of Housing and Urban-Rural Development & Counsellor of Counsellor's Office of the State Council of the PRC			
10:00 - 10:30 <i>Convention Hall</i>	Keynote 1: Mr Matthew CHEUNG Kin-chung , Chief Secretary for Administration, Government of the HKSAR			
10:30 - 11:00 <i>Convention Hall</i>	Keynote 2: Mr SU Yunshan , Director-General, Department of Science & Technology and Energy Saving on Buildings, Ministry of Housing and Urban-Rural Development, People's Republic of China			
11:00 - 11:20	<i>Coffee Break</i>			
11:20 - 11:50 <i>Convention Hall</i>	Keynote 3: Ms Christiana FIGUERES , Vice-chair, Global Covenant of Mayors for Climate & Energy			
11:50 - 12:00 <i>Convention Hall</i>	Platinum Sponsor's Sharing - Mr Sean CHIAO , President, Asia Pacific, AECOM			
12:00 - 13:30	<i>Networking Luncheon (Grand Hall, Level 3, Hong Kong Convention and Exhibition Centre)</i> <i>For registered guests only</i>			
13:30 - 15:00	Parallel Session 1			
		Venue		Venue
	1.1 Mainland China Session - The Comprehensive Scheme on Green Retrofitting and Performance Enhancement of Existing Buildings in China	Level 1 - Convention Hall	1.2 Regional Session - Czech Republic, Italy, Sweden and Switzerland	Level 1 - Theatre 1
	1.3 Advanced Building Elements	Level 1 - Theatre 2	1.4 Practices Review of High-Performance Green Buildings	Level 2 - S221
	1.5 SBE Assessments - Green Neighbourhoods (1)	Level 4 - S428	1.6 Innovations Driving for Greener Policies and Standards - Microclimate	Level 2 - S223
	1.7 Vision-led Sustainable Neighborhoods: Myths and Musts	Level 2 - S224 & 225	1.8 Innovations for Occupant Wellbeing (1)	Level 4 - S426 & 427
	1.9 Practices & Methodologies for Green Building Management (1)	Level 2 - S228	1.10 Green Infrastructure in SBE - Hong Kong Cases	Level 4 - S423 & 424
	1.11 Processes, Design, Tools and Methodologies in SBE (1)	Level 4 - S421	1.12 Regenerating Urban Space in Neighbourhoods	Level 4 - S425
	1.13 Healthy and Sustainable Building for Resilient Future	Level 2 - S226 & 227		
	15:00 - 15:20	<i>Coffee Break</i>		

15:20 - 16:20 <i>Convention Hall</i>	Roundtable 1: Emerging Perspectives for Transforming the Build Environment			
	<p>Session Chair: Prof. Thomas LÜTZKENDORF, Director, Centre for Real Estate; Head of Chair, Sustainable Management of Housing and Real Estate, Karlsruhe Institute of Technology</p> <p>Speakers: Ar. TAI Lee-siang, Chair, WorldGBC Prof. WANG Youwei, Chairman, China Green Building Council Prof. Serge SALAT, President, Urban Morphology and Complex Systems Institute Prof. Arno SCHLUETER, Professor, Architecture and Building Systems ETH Zurich; Principal Investigator, Future Cities Laboratory, Singapore ETH Centre Ar. Bryant LU, Vice Chairman, Ronald Lu and Partners</p>			
16:30 - 18:00	Parallel Session 2			
		Venue		Venue
	2.1 Mainland China Session - Green Building Design and Technological Challenges of Eco Skyscraper in China	Level 1 - Convention Hall	2.2 Regional Session: Turkey, Greece, Malta and Egypt	Level 1 - Theatre 1
	2.3 Advanced Building Systems	Level 1 - Theatre 2	2.4 Policies for High-Performance Green Buildings (1)	Level 2 - S221
	2.5 SBE Assessments - Green Neighbourhoods (2)	Level 2 - S222	2.6 Innovations Driving for Greener Policies and Standards - Carbon Assessment	Level 2 - S223
	2.7 Deep Energy Saving and Other Innovative Green Measures for Commercial Buildings in Hong Kong, Mainland China and Overseas	Level 2 - S224 & 225	2.8 Innovations for Occupant Wellbeing (2)	Level 4 - S426 & 427
	2.9 Practices & Methodologies for Green Building Management (2)	Level 2 - S228	2.10 Transforming SBE Practices - Energy Management (1)	Level 4 - S423 & 424
	2.11 Processes, Design, Tools and Methodologies in SBE (2)	Level 4 - S421	2.12 Processes of Urban Regeneration	Level 4 - S425
	2.13 Powering Up Smart City	Level 2 - S226 & 227	2.14 Sustainability Assessment of Buildings as Part of Green-Public Procurement Based on the German BNB-System	Level 4 - S428

Day 2 • 6 June 2017 (Tue)

08:00 - 09:00	Registration		
09:00 - 11:50 <i>Convention Hall</i>	Plenary Session on Climate Change and Sustainable Development		
	Session Chair: Mr Curt GARRIGAN , Cities and Buildings Programme Manager, UN Environment – Economy Division		
	Speakers: Mr WONG Kam-sing , Secretary for the Environment, Government of the HKSAR Ms Christiana FIGUERES , Vice-chair, Global Covenant of Mayors for Climate & Energy Ms Jennifer LAYKE , Director, Global Energy Program, World Resources Institute Mr Gregor HERDA , Regional Housing Advisor, United Nations Human Settlement Programme (UN-Habitat) Mr John DULAC , Technology Policy Building Sector Lead, International Energy Agency Mr Nils LARSSON , Executive Director, International Initiative for a Sustainable Built Environment Mr Pekka HUOVILA , Coordinator, 10YFP Sustainable Buildings and Construction (SBC) Programme Mr Roland HUNZIKER , Director, Sustainable Buildings & Cities, World Business Council for Sustainable Development Ms Christine LOH , Under Secretary for the Environment, Government of the HKSAR		
11:50 - 12:00 <i>Convention Hall</i>	Platinum Sponsor's Sharing - Dr Raymond YAU , General Manager, Technical Services & Sustainable Development, Swire Properties Ltd.		
12:00 - 13:30	<i>Lunch Break (Cafe Renaissance, M/F, Renaissance Harbour View Hotel)</i> <i>For registered guests only</i>		
13:30 - 15:00	Parallel Session 3		
		Venue	Venue
3.1	Mainland China Session - Turning Green to Gold – State of Green Finance to Drive Sustainable Low-Carbon Urban Development in China	Level 1 - Convention Hall	3.2 International Youth Competition (1) Level 1 - Theatre 1
3.3	Advanced Building Systems - Energy Generation (1)	Level 1 - Theatre 2	3.4 Policies for High-Performance Green Buildings (2) Level 2 - S221
3.5	Performance Review of Green Buildings (1)	Level 2 - S222	3.6 Innovations Driving for Greener Policies and Standards - Practices Review Level 2 - S223
3.7	High Performance Transportation Hubs: Their Critical Role and Requirements?	Level 2 - S224 & 225	3.8 Innovative Practices for Occupant Wellbeing - Bioclimatic Design Level 4 - S426 & 427
3.9	Practices & Methodologies for Green Building Management (3)	Level 2 - S228	3.10 Transforming SBE Practices - Energy Management (2) Level 4 - S425
3.11	BIM for Sustainability (1)	Level 4 - S421	3.12 Emerging Practices in Sustainable Built Environment Level 4 - S423 & 424
3.13	Community Empowerment (1)	Level 2 - S226 & 227	3.14 Environmentally Responsive Buildings and Human Interactions Level 4 - S428
15:00 - 15:20	<i>Coffee Break</i>		
15:20 - 16:20	Roundtable 2: Leadership Driving for the Sustainable Built Environment		
	Session Chair: Ms Christine LOH , Under Secretary for the Environment, Government of the HKSAR		
	Speakers: Dr George BAIRD , Emeritus Professor of Building Science, School of Architecture, Victoria University of Wellington Mr Douglas WOO , Chairman & Managing Director, Wheelock and Company Ltd. Prof. Greg FOLIEN , Enterprise Professor, University of Melbourne; Regional Director in Asia-Pacific, iiSBE; Founding Director, nBLue Pty Ltd. Mr TAN Tian-chong , Deputy Managing Director, Built Environment Research and Innovation Institute, Building and Construction Authority Mr Lincoln LEONG , Chief Executive Officer, MTR Corporation		

16:30 - 18:00		Parallel Session 4	
		Venue	
4.1	Mainland China Session - The Development Framework and Professional Best Practices of Healthy Buildings in China	Level 1 - Convention Hall	4.2 International Youth Competition (2)
4.3	Advanced Building Systems - Energy Generation (2)	Level 1 - Theatre 2	4.4 Processes of High-Performance Green Buildings
4.5	Performance Review of Green Buildings (2)	Level 2 - S222	4.6 Green Construction Technologies (1)
4.7	The Secret Ingredients of Sustainable Real Estate Development	Level 2 - S224 & 225	4.8 Innovative Biophilic Design for Wellbeing
4.9	A Collaborative Approach in Delivering Low Carbon Living	Level 2 - S228	4.10 Transforming SBE Practices - Energy Management (3)
4.11	BIM for Sustainability (2)	Level 4 - S421	4.12 Healthy Building, Human Comfort & Wellbeing
4.13	Community Empowerment (2)	Level 2 - S226 & 227	4.14 PolyU Green Deck: A Catalyst for a Green and Vibrant Community
18:30 - 19:00	Pre-Dinner Cocktail	Venue: Concord and Oasis Room, Level 8, Renaissance Hong Kong Harbour View Hotel, 1 Harbour Road, Wanchai, Hong Kong (For registered guests only)	
19:00 - 22:00	Gala Dinner		

Day 3 • 7 June 2017 (Wed)

08:00 - 09:00	Registration		
09:00 - 09:30 <i>Convention Hall</i>	Keynote 4: Prof. Peter GUTHRIE , Director, Centre for Sustainable Development, University of Cambridge		
09:30 - 10:00 <i>Convention Hall</i>	Keynote 5: Prof. Thomas AUER , Managing Director, Transsolar; Professor, Building Technology and Climate Responsive Design, Technical University of Munich		
10:00 - 10:30	<i>Coffee Break</i>		
10:30 - 12:00	Parallel Session 5		
	Venue		Venue
5.1 Regional Session - Canada, Brazil-Portugal, The Netherlands, Germany and Tallinn-Helsinki	Level 1 - Convention Hall	5.2 High Performance Buildings and Sustainable Neighbourhoods in Sweden	Level 1 - Theatre 1
5.3 Smart Initiatives in SBE (1)	Level 1 - Theatre 2	5.4 Deep Renovations - Policies & Standards	Level 2 - S221
5.5 SBE Assessments - Green Building Policies	Level 2 - S222	5.6 Green Construction Technologies (2)	Level 2 - S224 & 225
5.7 Innovations Driving for Greener Policies and Standards - Assessment, Analysis and Modelling (1)	Level 2 - S223	5.8 Sustainable Neighbourhoods - Case Study Review (1)	Level 4 - S426 & 427
5.9 Transforming Green Market - Green Economics (1)	Level 2 - S228	5.10 Zero Energy	Level 4 - S423 & 424
5.11 Processes, Design, Tools and Methodologies in SBE (3)	Level 4 - S421	5.12 Occupants' Evaluation of Green Buildings	Level 4 - S425
5.13 Stakeholder Collaboration	Level 2 - S226 & 227	5.14 Smart and Digital Transformation for Sustainable Living	Level 4 - S428
12:00 - 13:30	<i>Lunch Break (Cafe Renaissance, M/F, Renaissance Harbour View Hotel) For registered guests only</i>		
13:30 - 15:00	Parallel Session 6		
	Venue		Venue
6.1 Regional Session - Australia, Mainland China, Singapore, South Korea and Philippines	Level 1 - Convention Hall	6.2 SBE Urban Challenge: Assessment Protocol and Case Studies	Level 1 - Theatre 1
6.3 Smart Initiatives in SBE (2)	Level 1 - Theatre 2	6.4 Deep Renovations - Practices & Performance Review	Level 2 - S221
6.5 SBE Assessments - Design Processes	Level 2 - S222	6.6 Green Construction Materials (1)	Level 2 - S224 & 225
6.7 Innovations Driving for Greener Policies and Standards - Assessment, Analysis and Modelling (2)	Level 2 - S223	6.8 Sustainable Neighbourhoods - Case Study Review (2)	Level 4 - S426 & 427
6.9 Transforming Green Market - Green Economics (2)	Level 2 - S228	6.10 Innovative Practices to Transform SBE (1)	Level 4 - S423 & 424
6.11 Processes, Design, Tools and Methodologies in SBE (4)	Level 4 - S421	6.12 Green Buildings - Occupants' Perspectives	Level 4 - S425
6.13 Place-making - Integrative Design Processes	Level 2 - S226 & 227	6.14 BEAM Plus Neighbourhood: From Theory to Praxis	Level 4 - S428
15:00 - 15:10	<i>Coffee Break</i>		

15:10 - 16:40	Parallel Session 7			
		Venue		Venue
	7.1 Education and Training for Transforming SBE	Level 4 - S428	7.2 SBE Buildings Challenge: Assessment Protocol and Case Studies	Level 1 - Theatre 1
	7.3 Smart Initiatives in SBE (3)	Level 1 - Theatre 2	7.4 Deep Renovations - Processes & Methodologies	Level 2 - S221
	7.5 SBE Assessments - Practices Review	Level 2 - S222	7.6 Green Construction Materials (2)	Level 2 - S224 & 225
	7.7 Innovations Driving for Greener Policies and Standards - Smart Initiatives	Level 2 - S223	7.8 Sustainable Neighbourhoods - Processes and Application	Level 4 - S426 & 427
	7.9 Transforming Green Market - Supply Chain	Level 2 - S228	7.10 Innovative Practices to Transform SBE (2)	Level 4 - S423 & 424
	7.11 Processes, Design, Tools and Methodologies in SBE (5)	Level 4 - S421	7.12 Multi-facet Considerations of Urban Regeneration Policies	Level 4 - S425
	7.13 Place-making - Practices Review	Level 2 - S226 & 227		
16:50 - 17:20 <i>Convention Hall</i>	Keynote 6: Dr Raymond COLE , Professor, School of Architecture and Landscape Architecture, University of British Columbia			
17:20 - 18:00 <i>Convention Hall</i>	Closing Ceremony <ul style="list-style-type: none"> • Speech by Mr Eric MA, Secretary for Development, Government of the HKSAR • Presentation of International Youth Competition Awards • Announcement of Host of WSBE2020 by Mr Nils LARSSON, Representative of SBE Co-owners • Closing Remark by Ir Conrad WONG, Chairman of WSBE17 Hong Kong Organising Committee 			

Day 4 & 5 • 8 - 9 June 2017 (Thu-Fri)

Green Building Technical Visits & Eco Tours

Remark: The Organisers reserve the right to update or change the programme content, session and paper allocation as well as venue without prior notice. Speakers and delegates are recommended to check constantly the Conference App to observe the latest programme and venue.

<p>Session 1.1 - Session Organiser: China Academy of Building Research Mainland China Session - The Comprehensive Scheme on Green Retrofitting and Performance Enhancement of Existing Buildings in China</p> <p>Level 1 - Convention Hall</p>	<p>Session 1.2 Regional Session - Czech Republic, Italy, Sweden and Switzerland</p> <p>Level 1 - Theatre 1</p>
<p>Session Chair: YIN Bo Director, Division of Science and Technology, China Academy of Building Research</p>	<p>Session Chair: François BAILLON Board member, SBE series; Senior Adviser, FIDIC; Treasurer, Business and Climate Summit Association; Founder, Ideagrama Consultant</p>
<p>The Roadmap on the Development of Comprehensive Scheme on Green Retrofitting and Performance Enhancement of Existing Buildings in China YIN Bo, Director, Division of Science and Technology, China Academy of Building Research</p> <p>The Appropriate Technologies and Practical Case Study on Green Retrofitting the Residential Dwellings in the Severe Cold Climatic Zone in China JIANG Yiqiang, Professor, School of Municipal and Environmental Engineering, Harbin Institute of Technology</p> <p>The Appropriate Technologies and Case Studies on Green Retrofitting the Healthcare Facilities in China DI Yanqiang, Head of Division, Division of Construction Technologies, China Building Technique Group Co., Ltd.</p> <p>The Case Studies and Technology Advancements on Green Retrofitting the Office Buildings in China ZHAO Li, Deputy Head, Division of Research and Development, China Academy of Building Research</p> <p>The Study of Energy Efficiency and Retro-Commissioning for Existing Large-scale Public Buildings ZHU Neng, Professor, School of Environmental Science and Engineering, Tianjin University</p>	<p>SBE16 Prague Antonin LUPISEK, Head of Department, Architecture and the Environment, Czech Technical University, Czech Republic</p> <p>SBE16 Torino Andrea MORO, President, iiSBE Italia, Italy</p> <p>SBE16 Malmö Roland ZINKERNAGEL, Lund University, Sweden</p> <p>SBE16 Zurich Guillaume HABERT, Professor, ETH Zurich, Switzerland</p>
<p>Session 1.5 SBE Assessments - Green Neighbourhoods (1)</p> <p>Level 4 - S428</p>	<p>Session 1.6 Innovations Driving for Greener Policies and Standards - Microclimate</p> <p>Level 2 - S223</p>
<p>Session Chair: John NG Chairperson, BEAM Society Ltd.; Honorary Professor, Department of Urban Planning and Design, University of Hong Kong, Hong Kong SAR</p>	<p>Session Chair: Otto POON Chairman, ATAL Engineering Ltd., Hong Kong SAR</p>
<p>LEED Certification and the New Standard of Sustainable Construction in Colombia Andres PELAEZ, Architect, Universidad Pontificia Bolivariana, Colombia</p> <p>Comparison Study of China's Eco-City Key Performance Indicator Systems DENG Wu, Assistant Professor, University of Nottingham Ningbo China, Mainland China</p> <p>A Human-Oriented Study of The Assessment Method for Sustainable Urban District in China - Comparison of LEED Neighbourhood Development, BREEAM Community, CASBEE-Cities and DGNB Urban Districts Edison ZHANG Zhidong, GB Tech Consulting Ltd., Hong Kong SAR</p> <p>Reducing the Impacts of the Built Environment on the Environment through the Integration of Socio-economic Indicators in Certification Standards Francesco CAPPAL, Civil Engineer, GRIDD-ÉTS École de technologie supérieure, Canada</p> <p>Development of a Comprehensive City Assessment Tool Applicable to Various Type of Cities Around the World: CASBEE-City (worldwide use version) Shun KAWAKUBO, Assistant Professor, Hosei University, Japan</p>	<p>The Potential of Applying Local Climate Zone for the Sustainable Planning in Urban Built Environment CHEN Yu-cheng, Department of Architecture, National Cheng Kung University, Taiwan</p> <p>Building Envelopes and Their Impact on Our Urban Thermal Environment MAING Minjung, The University of Hong Kong, Hong Kong SAR</p> <p>Urban Geometry and Wind Simulation Studies for Comfort in Bangkok Street Canyon Pattaranan TAKKANON, Professor, Kasetsart University, Thailand</p> <p>Research of Urban Heat Island (UHI) in Shenzhen Based on Climatic Design and Urban Planning Strategies YU Wenjuan, Sustainable Design Assistant, Ronald Lu and Partners (Hong Kong) Ltd., Hong Kong SAR</p> <p>Influence of Moving Vehicles on Pollutant Dispersion in Street Canyon – A Numerical Study ZHANG Wenjing, Division of Building Science and Technology, City University of Hong Kong, Hong Kong SAR</p>

<p>Session 1.3 Advanced Building Elements Level 1 - Theatre 2</p>	<p>Session 1.4 Practices Review of High-Performance Green Buildings Level 2 - S221</p>
<p>Session Chair: Jian-lei NIU Chair Professor of Building Environment and Energy, Associate Head of Department, and Director - Research Centre for Building Environmental Engineering Department of Building Services Engineering, The Hong Kong Polytechnic University; Editor-in-chief, Energy and Buildings Journal, Hong Kong SAR</p>	<p>Session Chair: Phil JONES Chair of Architectural Science, Welsh School of Architecture, Cardiff University, United Kingdom; Visiting Research Professor, Faculty of Architecture, University of Hong Kong, Hong Kong SAR</p>
<p>Filter Facade Ferdinand OSWALD, Institute of Architecture Technology, Graz University of Technology, Austria</p> <p>The Impact of Double Skin Façade on the Energy Consumption of Office Buildings Under the Tropical Brazilian Climate Kenneth IP, Principal Lecturer, University of Brighton, United Kingdom</p> <p>Climate-Adaptive and Optimized Building Envelope Designs in East Asia Kevin WAN, Engineer, Arup, Hong Kong SAR</p> <p>Folded Cardboard Sandwiches for Load-bearing Architectural Components Stephan SCHÜTZ, Research Assistant, Architect, Bauhaus-Universität Weimar, Germany</p> <p>Multistorey Frame System for Energy Efficient Buildings Vlastimil BILEK, ZPSV a.s., Uhersky Ostroh, Czech Republic</p>	<p>When will Hong Kong Build its First Passive House? - Concepts and Case Studies around Asia Show Great Possibilities for Energy Savings Anne JACOBS, Senior Expert, Sustainable Construction, BASF, Hong Kong SAR</p> <p>Insights into Green Hotels: Case Studies Duygu ERTEN, Principal, TURKECO Consulting, Turkey</p> <p>Building Energy Efficiency in Hong Kong: Case Study of a Commercial Building with BEAM Plus Provisional Platinum Rating (Existing Buildings) POON Ka-man, Business Environment Council Ltd., Hong Kong SAR</p> <p>An Elemental Approach for Predicting Embodied Carbon of Office Buildings Srinath PERERA, Professor of Built Environment & Construction Management, Western Sydney University, Australia</p> <p>Exploring Risks and Rewards Associated with High Performance Manufactured Buildings Karlson Charles HARGROVES, Senior Research Fellow, Curtin University, Australia</p>
<p>Session 1.7 - Session Organiser: AECOM Vision-led Sustainable Neighborhoods: Myths and Musts Level 2 - S224 & 225</p>	<p>Session 1.8 Innovations for Occupant Wellbeing (1) Level 4 - S426 & 427</p>
<p>Session Chair: WONG Chi-chung Executive Vice President, Asia; Global Head, Chinese Overseas Investment (COI) Program, AECOM, Hong Kong SAR</p>	<p>Session Chair: Tony IP Deputy Director of Sustainable Design, Ronald Lu & Partners, Hong Kong SAR</p>
<p>Albert KB CHAN, Director of Development Planning & Design, Shui On Land</p> <p>Belinda YUEN, Professorial Fellow and Research Director, Lee Kuan Yew Centre for Innovative Cities, Singapore University of Technology and Design, Singapore</p> <p>Claire BONHAM-CARTER, Principal and Director of Sustainable Development, Design and Planning, AECOM, United States of America</p> <p>Raymond LEE, Director of Planning, Planning Department, Government of the HKSAR</p>	<p>Research and Development of Noise Mitigation Measures for Public Housing Development in Hong Kong John HL HO, Chief Civil Engineer, Hong Kong Housing Authority, Government of the HKSAR, Hong Kong SAR</p> <p>Estimating Typhoon Haiyan's Wind Speeds Using Windicators and Post-Storm Wind Vulnerability Analysis on the Affected Areas Joshua AGAR, Civil Engineer, University of Philippines Diliman, Philippines</p> <p>Outdoor Lighting Quality and Glare Rating Evaluation of Night-time Community Parks KUO Poyen, Associate Professor, Department of Architecture, Chaoyang University of Technology, Taiwan</p> <p>Better Places for People: Health and Wellbeing Measurement Methods in Workplaces Maira DE MACEDO, Architect – Institutional and Governmental Relations Coordinator, Green Building Council Brazil, Brazil</p> <p>Development of a Home Indoor and Outdoor Environment Visualization System Yusuke NAKAJIMA, Professor, Kogakuin University, Japan</p>

<p>Session 1.9 Practices & Methodologies for Green Building Management (1) Level 2 - S228</p>	<p>Session 1.10 Green Infrastructure in SBE - Hong Kong Cases Level 4 - S423 & 424</p>
<p>Session Chair: WONG Wai-kyong Chief Building Services Engineer/2, Architectural Services Department, Government of the HKSAR, Hong Kong SAR</p>	<p>Session Chair: Samuel KWONG Group Sustainable Development Manager, John Swire & Sons (H.K.) Ltd., Hong Kong SAR</p>
<p>Incorporating Sustainability Criteria in Commercial Workplace Fit-out Guidelines for a Banking Operation James WONG Pow-chew, Program Manager, RMIT University, Australia</p> <p>Adopting Green Building Concepts in Housing Estate Development Projects in Abuja F.C.T., Nigeria: Exploring The Potentialities Of End-Users' Preference Salisu Gidado DALIBI, Business School of Hohai University Nanjing, Mainland China</p> <p>Project Management Strategies for Green Business Parks: Critical Success Factors, Barriers and Solutions SHAN Ming, National University of Singapore, Singapore</p> <p>Smart, Green + Productive Workplace Simone SKOPEK, JLL, Canada</p>	<p>Implementing the Beautification and Sustainable Designs for the Harbour Area Treatment Scheme (HATS) Stage 2A Andrew LAI, Resident Engineer, Arup, Hong Kong SAR</p> <p>Building Water Resilience in Sustainable Neighbourhoods: A Progressive Shift in Hong Kong Edmond WF LIU, Senior Engineer, Water Supplies Department, Government of the HKSAR, Hong Kong SAR</p> <p>Integrating Water Management Facilities Into The Built Environment - A Smart Green Resilient Approach Kenneth KWOK, Associate Director, Arup, Hong Kong SAR</p> <p>Driving Innovations For Green Infrastructure Components Nicholas AU, Hong Kong Housing Authority, Government of the HKSAR, Hong Kong SAR</p> <p>Sustainable Engineering Practices in Landslip Prevention and Mitigation Works in Hong Kong Patrick HO Ho-man, Geotechnical Engineer, Civil Engineering and Development Department, Government of the HKSAR, Hong Kong SAR</p>
<p>Session 1.13 - Session Organiser: Link Asset Management Ltd. / Nan Fung Development Ltd Healthy and Sustainable Building for Resilient Future Level 2 - S226 & S227</p>	
<p>Session Chair: Chris KWAN Senior Project Manager, Project & Planning, Link Asset Management Ltd., Hong Kong SAR</p>	
<p>Green Buildings - The Foundation for Sustainable Development Calvin Lee KWAN, General Manager- Sustainability, Link Asset Management Ltd., Hong Kong SAR</p> <p>Nan Fung's Corporate Initiative for New and Revitalization Development Samuel WONG, Deputy General Manager, Project Dpt., Nan Fung Development Ltd., Hong Kong SAR</p> <p>Leading Edge Trend for Resilient Future Building Design Vincent CHENG, Director of Building Sustainability, Arup, Hong Kong SAR</p> <p>Exemplar Next Generation Commercial Development - NKIL6512 Bing KWAN, Director, P&T Architects and Engineers Ltd., Hong Kong SAR Alvin LO, Associate Director of Building Sustainability, Arup, Hong Kong SAR</p>	

<p>Session 1.11 Processes, Design, Tools and Methodologies in SBE (1) Level 4 - S421</p>	<p>Session 1.12 Regenerating Urban Space in Neighbourhoods Level 4 - S425</p>
<p>Session Chair: Chimay J. ANUMBA Dean & Professor, University of Florida, United States of America</p>	<p>Session Chair: Thomas TANG Sek-khuen Managing Director, Kuala Lumpur Centre for Sustainable Innovation, Malaysia</p>
<p>Does the Sequence Matter? - Investigating the Impact of the Order of Design Decisions on the Life Cycle Performance Julia TSCHEWERTAK, Bauhaus-University Weimar, Germany</p> <p>Rethinking Architectural Passive Cooling Strategies in New Zealand's Non-residential Building Stock Lesley METIBOGUN, School of Architecture, Victoria University of Wellington, New Zealand</p> <p>Building in Existing Contexts – Densification Paul FLOERKE, Associate Professor, Associate Chair, Department of Architectural Science, Ryerson University, Canada</p> <p>Problems and Prospects of Urban Compaction—A Case of Jaipur City Sakshi BANSAL, Urban Planner, Malaviya National Institute of Technology Jaipur, India</p> <p>Where Planning Regulations and Development Practice Collide; the Multi-storey Apartment Building in SubTropical Brisbane Australia Rosemary Jean KENNEDY, Queensland University of Technology, Australia</p>	<p>Cultivating a Village Impulse in the Midst of Warsaw, the Jazdów Settlement of Finnish Houses Dariusz ŚMIECHOWSKI, Senior Lecturer, Academy of Fine Arts in Warsaw, Poland</p> <p>Productive Transforming of the Urban Traffic Space HAN Dan, Tianjin University, Mainland China</p> <p>Nature-based Urban Space Transformation Kristin BARBEY, Lecturer, Karlsruhe Institute of Technology, Germany</p> <p>Historic Relationship Between Urban Dwellers and the Tomebamba River M. Augusta HERMIDA, Professor, Universidad de Cuenca, Ecuador</p> <p>Transformation from River Channelisation to River Revitalisation Richard LEUNG Wah-ming, Senior Engineer, Drainage Services Department, Government of the HKSAR, Hong Kong SAR</p>

<p>Session 2.1 - Session Organiser: Shanghai Research Institute of Building Sciences Mainland China Session - Green Building Design and Technological Challenges of Eco Skyscraper in China Level 1 - Convention Hall</p>	<p>Session 2.2 Regional Session: Turkey, Greece, Malta and Egypt Level 1 - Theatre 1</p>
<p>Session Chair: XU Qiang Chief Engineer, Shanghai Research Institute of Building Sciences (Group) Co., Ltd.</p>	<p>Session Chair: Wim BAKENS Secretary General, International Council for Research and Innovation in Building and Construction</p>
<p>Evaluation of Green Skyscraper Buildings in China SONG Ling, Deputy Director, Center for Science and Technology & Industrialization Development, Ministry of Housing and Urban-Rural Development of the P.R. China (MOHURD)</p> <p>Energy Saving Potential of Air-conditioning System with Low-Grade Energy Bus in Skyscrapers LI Xianting, Professor, School of Architecture, Tsinghua University</p> <p>In Pursuit of Excellence: Sustainable High-performance Skyscrapers ZHANG Bolun, Director, East China Architectural Design and Research Institute</p> <p>Green Design and Facility Management Systems in Shanghai Tower YANG Jianrong, Deputy Director, Shanghai Research Institute of Building Sciences (SRIBS)</p>	<p>SBE16 Istanbul Aygen ERKAL, Secretary General, Türkiye İMSAD- Association of Turkish Construction Material Producers</p> <p>SBE16 Thessaloniki Aikaterini TSIKALOUAKI, Associate Professor, Aristotle University of Thessaloniki</p> <p>SBE16 Malta Ruben Paul BORG, University of Malta</p> <p>SBE16 Cairo Wafaa NADIM, Architecture Program, German University Cairo, Egypt</p>
<p>Session 2.5 SBE Assessments - Green Neighbourhoods (2) Level 2 - S222</p>	<p>Session 2.6 Innovations Driving for Greener Policies and Standards - Carbon Assessment Level 2 - S223</p>
<p>Session Chair: John NG Chairperson, BEAM Society Limited; Honorary Professor, Department of Urban Planning and Design, University of Hong Kong, Hong Kong SAR</p>	<p>Session Chair: Otto POON Chairman, ATAL Engineering Ltd., Hong Kong SAR</p>
<p>Value Management as a Tool for Delivering Sustainable Rail Projects Clinton Ohis AIGBAVBOA, University of Johannesburg, South Africa</p> <p>Calculation Methodology of GHG Emissions from a Low Carbon Urban Development in an Underdevelopment Country – Case Study from a LEED ND Certified project in São Paulo City/Brazil Maria Carolina FUJIHARA, Green Building Council Brasil, Brasil; University of São Paulo, Brasil</p> <p>A Stakeholder-based Assessment Model (SAM) for Resource-efficiency Measures in the Construction Industry Richard Carl MÜLLER, Karlsruhe Institute of Technology, Germany</p> <p>Comparative Rich-Picture-Diagram for Assessment of Building Sustainability Label Sasha Nikolaus CISAR, Chair of Sustainable Construction, ETH Zurich, Switzerland</p> <p>More Than Green: The DGNB Certification System for Sustainable Buildings and Districts Thomas AUER, Managing Director & Founder, Transsolar; Profeesor, Building Technology and Climate Responsive Design, Technical University of Munich, Germany</p>	<p>Building Carbon footprint (BCF) Method for Nearly Zero-Energy Building Design Assessment CHAO Yu-chan, Assistant Professor, Feng Chia University, Taiwan</p> <p>Integrated Residential Household Energy Consumption and GHG Emissions Modelling at Metropolitan Scale Raul MARINO, Melbourne School of Design, University of Melbourne, Australia</p> <p>Building Life Cycle Carbon Emissions: A Review TENG Yue, The University of Hong Kong, Hong Kong SAR</p> <p>How Carbon Metric Standard Could Facilitate Innovation for Reduction of GHG Emission from Buildings? Tomonari YASHIRO, The University of Tokyo, Japan</p> <p>Climate Action Planning Strategies for Achieving Carbon Neutrality and Net Zero Campus Operation Vuk VUJOVIC, Director of Sustainability & Energy, Legat Architects, United States of America</p>

<p>Session 2.3 Advanced Building Systems Level 1 - Theatre 2</p>	<p>Session 2.4 Policies for High-Performance Green Buildings (1) Level 2 - S221</p>
<p>Session Chair: Lloyd Martin SCOTT Dublin Institute of Technology, Ireland</p>	<p>Session Chair: Richard LORCH Editor-in-Chief, "Building Research & Information" Journal, United Kingdom</p>
<p>Remarkable Energy Retrofit for Existing Buildings by Advanced Fan Technology: Electronically Commutated Motor Plug Fan Isaac TSANG Siu-chung, Assistant Building Services Manager, Swire Properties Ltd., Hong Kong SAR</p> <p>Low Temperature Radiant Cooling Design and Application in Tropical/ Sub-Tropical Countries Paul CHAN Yim-cheong, Director, Wong & Ouyang (Building Services) Ltd., Hong Kong SAR</p> <p>Hybrid Air-conditioning System Efficiency for Districts in the Tropics HSIEH Shanshan, Future Cities Laboratory, Singapore ETH Center, Singapore; Chair of Architecture and Building Systems, ETH Zurich, Switzerland; Industrial Process and Energy Systems Engineering Group, Ecole Polytechnique Federale de Lausanne, Switzerland</p> <p>Evaluation of Saving Energy with SOFC and Battery Combined System Takeshi SASE, Cooperative Researcher, Building Research Institute, Japan</p>	<p>Demystifying and Democratizing The Energy Use Conversation to Support The Net-Zero Challenge Birgit SIBER, Diamond Schmitt Architects, Canada Mike WILLIAMS, Rowan Williams Davies & Irwin Inc.</p> <p>Building Energy Saving Strategy in Hong Kong - "Built-in" + "Plug-in" CHIU Chun-ting, Electrical and Mechanical Services Department, Government of the HKSAR, Hong Kong SAR</p> <p>How Sustainable are the Quality Control Procedures for Constructions in Europe? Frits MEIJER, Senior Researcher, TU Delft / Faculty of Architecture and the Built Environment, The Netherlands</p> <p>Policy Scenarios of Zero Carbon Building for Hong Kong: To Survive or To Lead? PAN Mi, The University of Hong Kong, Hong Kong SAR</p> <p>A Discussion on the Benefits of Environment Performance of the Promotion of Kaohsiung Green Building Specialties Policy CHAO Chien-chiao, Director General, Bureau of Public Works, Kaohsiung City Government, Taiwan</p>
<p>Session 2.7 - Session Organiser: Swire Properties Ltd. Deep Energy Saving and Other Innovative Green Measures for Commercial Buildings in Hong Kong, Mainland China and Overseas Level 2 - S224 & 225</p>	<p>Session 2.8 Innovations for Occupant Wellbeing (2) Level 4 - S426 & 427</p>
<p>Session Chair: Benny AU Sustainable Development Manager, Swire Properties Ltd., Hong Kong SAR</p>	<p>Session Chair: Srinath PERERA Professor of Built Environment & Construction Management, Western Sydney University, Australia</p>
<p>Sustainability Strategies on Deep Energy Saving and Energy Management of Property Developer Raymond YAU, General Manager, Technical Services & Sustainable Development, Swire Properties Ltd.</p> <p>Overview of Building Energy Efficiency in China and the Upcoming Trend WEI Qingpeng, Building Energy Research Center, Tsinghua University, Beijing</p> <p>Cost & Value: Multiple Benefits of Green Commercial Buildings in Western Countries Phil JONES, Chair Architectural Science, Welsh School of Architecture, Cardiff University, United Kingdom; Visiting Research Professor, Faculty of Architecture, University of Hong Kong, Hong Kong SAR</p> <p>YKK80 High Efficiency Building - Radiant Control Both Outside and Inside Kitaro MIZUIDE, General Manager, M&E Design Department of NIKKEN SEKKEI, Japan</p> <p>Performance Synergy from Integrated Design, Construction and Operation. Case Study on a High Performance Grade A Office - Swire One Taikoo Place Vincent CHENG, Director of Building Sustainability, Arup, Hong Kong SAR</p>	<p>Outdoor to Indoor Air Quality in Urban Environment Alexis LAU Kai-hon, Professor, Division of Environment, The Hong Kong University of Science and Technology, Hong Kong SAR</p> <p>Redesigning Long-Term Senior Care: Design Solutions to Facilitate Different Levels of Care Needs in Senior Housing - Using Hong Kong's Latest Senior Housing as Example Bryant LU, Vice Chairman, Ronald Lu and Partners (Hong Kong) Ltd., Hong Kong SAR</p> <p>Occupant-Related Energy Use: A Qatar Office Case Study Chimay J. ANUMBA, Dean & Professor, University of Florida, United States of America</p> <p>Purifying City Air in Densely Urban Environment Jimmy CK TONG, Associate & East Asia Energy Skill Leader, Arup, Hong Kong SAR</p> <p>A Healthy and Sustainable Living Environment – LOHAS Josh CHENG, Building Sustainability Consultant, Arup, Taiwan</p>

<p>Session 2.9 Practices & Methodologies for Green Building Management (2) Level 2 - S228</p>	<p>Session 2.10 Transforming SBE Practices - Energy Management (1) Level 4 - S423 & 424</p>
<p>Session Chair: POON Chi-sun Chair Professor of Sustainable Construction Materials, Department of Civil and Environmental Engineering, The Hong Kong Polytechnic University, Hong Kong SAR</p>	<p>Session Chair: Tim HILL Research Director, Eco-business Research, Singapore</p>
<p>Green + Smart Buildings Jiri SKOPEK, Managing Director, JLL, Canada; 2030 Districts</p> <p>Challenges in Realising Green Building Concepts in Trade and Industry Tower Joanna WAI, Senior Project Manager, Architectural Services Department, Government of the HKSAR, Hong Kong SAR Daniel NG, Contract Manager, Guardian Property Management Ltd., Hong Kong SAR</p> <p>The Perceptible Impacts of Building Envelope on Other Green Building Features: "A Review" Salisu Gidado DALIBI, Business School of Hohai University Nanjing, Mainland China</p> <p>Investigating Critical Safety Performance Factors in Green Building Construction Projects: The Case of Singapore SHAN Ming, National University of Singapore, Singapore</p> <p>Green Interior Renovation by Architectural Services Department Vetus LAU, Director, Llewelyn Davies Hong Kong Ltd., Hong Kong SAR</p>	<p>Development of an Integrated Energy Simulation Tool for Buildings and MEP Systems, the BEST - A Pilot Study on Simulation of Demand Response with Cogeneration Systems Ryota KUZUKI, Acting General manager, Energy Strategy Planning Department, Tokyo Gas Co., Ltd., Japan</p> <p>Driving Ultimate Building Performance through Smart E&M Systems for Sustainable Built Environment TAI Tak-him, Deputy Director / Trading Services, Electrical and Mechanical Services Department, Government of the HKSAR, Hong Kong SAR</p> <p>A Case Study to Automate Demand Response on a University Campus Thomas Mark LAWRENCE, University of Georgia, United States of America</p> <p>Short-term Load Forecasting Model with Predicted Weather Data ZHU Guangya, City University of Hong Kong, Hong Kong SAR</p>
<p>Session 2.13 - Session Organiser: CLP Power Hong Kong Ltd. Powering Up Smart City Level 2 - S226 & 227</p>	<p>Session 2.14 - Session Organiser: Division Sustainable Building, Federal Institute for Research on Building, Urban Affairs and Spatial Development (BBSR), Germany Sustainability Assessment of Buildings as Part of Green-Public Procurement Based on the German BNB-System Level 4 - S428</p>
	<p>Session Chair: Thomas LÜTZKENDORF Director, Centre for Real Estate and Head of Chair, Sustainable Management of Housing and Real Estate, Karlsruhe Institute of Technology, Germany</p>
<p>Powering Up for Brighter Tomorrows Eric CHEUNG, Senior Director - Customer & Business Development, CLP Power (Hong Kong) Ltd., Hong Kong SAR</p> <p>Big Data Era for Building Management Amen TONG, General Manager, Technical Services, Airport Authority Hong Kong</p> <p>Smart Power Control for Peak Load Compensation Clement WONG, Head of Facility Management Hong Kong Science and Technology Parks Corporation</p> <p>How Hong Kong to be a Data Centre Hub in Asia in the Next Decade Charles LEE, Founder and CEO OneAsia Network Limited & Newtech Technology Co Ltd.</p>	<p>The Assessment System for Sustainable Building BNB by Taking the Example of the Complete Refurbishment BNB Module for Educational Buildings Julia MÜLLER, Federal Institute for Research on Building, BBSR, Germany</p> <p>Sustainable Building Assessment System for Research- and Laboratory buildings - Austrian and Swiss Perspective on the BNB Applicability Alexander PASSER, Assistant Professor, Graz University of Technology, Austria</p> <p>Natural Resources and Sustainability Eike ROSWAG-KLINGE, Ziegert Roswag Seiler Architekten</p> <p>PL-E-N-AR Planning Aid for Energy Efficient and Sustainable Architecture Günter LÖHNERT, sol-id-ar planungswerkstatt, Germany</p> <p>Panel Discussion</p>

<p>Session 2.11 Processes, Design, Tools and Methodologies in SBE (2) Level 4 - S421</p>	<p>Session 2.12 Processes of Urban Regeneration Level 4 - S425</p>
<p>Session Chair: Andrea MORO President, iiSBE Italia, Italy</p>	<p>Session Chair: Edward NG Professor of Architecture, School of Architecture, The Chinese University of Hong Kong, Hong Kong SAR</p>
<p>Decision Making in the Pre-design Stage of Building Renovation Projects Anne N. NIELSEN, University College of Northern Denmark, Aalborg University, Denmark</p> <p>A Holistic Thriving Design Approach Dennis LEE, Managing Director, Architecture: Innovative Limited, Hong Kong SAR</p> <p>Fostering Sustainable Buildings in Indonesia by Foreign Developer for Resilience Dennis MUI Heung-fu, (former) Assistant Project Director, Pacific Century Premium Developments Ltd., Hong Kong SAR</p> <p>Reconsidering the Design of High-rise Mass Housing in Tropical Climates – A Case Study in Malaysia GAN Hock-beng, G&A Architect, Malaysia FOO Chee-hung, Researcher, Construction Research Institute of Malaysia, Malaysia</p> <p>Embodied Energy Versus Building Height, The “Premium” of Building Tall Rolf André BOHNE, The Norwegian University of Science and Technology, Norway</p>	<p>Energy Benchmarking Tool for Low-Carbon Transformation in Hong Kong: A Scientific Approach and Its Practical Applications Benny KM CHOW, Director, Hong Kong Green Building Council Ltd., Hong Kong SAR</p> <p>Sustainability Indicators for the Assessment of the Energy System Lisa ANDES, Institute of Sustainable Management of Housing and Real Estate (OEW), Karlsruhe Institute of Technology, Germany</p> <p>Creating Methods, Procedures and Tools for a More Sustainable Neighbourhood Development – Experiences from Germany Maria BALOUKTSI, Karlsruhe Institute of Technology (KIT), Germany</p> <p>How Can We Assess the Achievement of the Sustainable Development Goals? – A Review of Indicators and Their Application at the City Level Roland ZINKERNAGEL, Lund University, Sweden</p>

<p>Session 3.1 - Session Organiser: Shenzhen Green Building Association and Shenzhen Institute of Building Research Mainland China Session - Turning Green to Gold – Green Practices for Urbanization in China Level 1 - Convention Hall</p>	<p>Session 3.2 International Youth Competition (1) Level 1 - Theatre 1</p>
<p>Session Chair: YE Qing Director, The Shenzhen Institute of Building Research Ltd and the President of Shenzhen Green Building Association</p>	<p>Session Chair: Edward NG Chairman, International Youth Competition Sub-committee, WSBE17 Hong Kong Scientific Committee; Professor of Architecture, School of Architecture, The Chinese University of Hong Kong, Hong Kong SAR</p>
<p>QIU Baoxing, Counsellor of Counsellor's Office of the State Council, PRC TANG Jie, Professor, School of Economics and Management, Harbin Institute of Technology (Shenzhen) ZHANG Xuefan, Director, Bureau of Housing & Construction of Shenzhen Municipality WANG Yun, Vice President, China Vanke Co., Ltd. Kevin MO, Managing Director, Paulson Institute Representative Office Ying HUA, Associate Professor, Department of Design and Environmental Analysis, The Cornell University</p>	<p>Presentation of 8 Shortlisted Teams Q & A Final Judging by International Jury Panel Thomas AUER, Managing Director, Transsolar; Professor, Building Technology and Climate Responsive Design, Technical University of Munich George BAIRD, Emeritus Professor of Building Science, School of Architecture, Victoria University of Wellington Greg FOLIENTE, Enterprise Professor, University of Melbourne; Regional Director in Asia-Pacific, iiSBE; Founding Director, nBlue Pty Ltd Peter GUTHRIE, Professor, Engineering for Sustainable Development, University of Cambridge Deborah KUH, Head of Greening, Landscape and Tree Management Section, Government of the HKSAR Christine LOH, Under Secretary for the Environment, Government of the HKSAR Serge SALAT, President, Urban Morphology & Complex Systems Institute Arno SCHLUETER, Professor, Architecture and Building Systems ETH Zurich; Principal Investigator, Future Cities Laboratory, Singapore ETH Centre</p>
<p>Session 3.5 Performance Review of Green Buildings (1) Level 2 - S222</p>	<p>Session 3.6 Innovations Driving for Greener Policies and Standards - Practices Review Level 2 - S223</p>
<p>Session Chair: Srinath PERERA Professor of Built Environment & Construction Management, Western Sydney University, Australia</p>	<p>Session Chair: Richard LORCH Editor-in-Chief, "Building Research & Information" Journal, United Kingdom</p>
<p>Strategic Study on the Benefit Evaluation of Solar Photovoltaic Promotion Policy in Kaohsiung CHAO Chien-chiao, Director General, Bureau of Public Works, Kaohsiung City Government, Taiwan A Baseline Study on Thermal Performance of Prefabricated Modular Buildings in Australia Sareh NAJI, The University of Melbourne, Australia Energy Saving Potential of Thermal Broken Aluminum Frames in Hot Climate Areas Simon WONG, Technoform Bautec Hong Kong Ltd., Hong Kong SAR Potentials of Energy Efficiency and Generation Strategies for High-rise Office Buildings in Hong Kong YU Cong, The University of Hong Kong, Hong Kong SAR Effect of Corridor Design on Energy Consumption for School Buildings in the Cold Climate ZHANG Anxiao, Tianjin University, Mainland China; Delft University of Technology, The Netherlands</p>	<p>Leap forward or Snail Speed? Examining Radical Sustainable Innovation Christian KOCH, Chalmers University of Technology, Sweden The Progress of Energy Renovations of Housing in The Netherlands Henk VISSCHER, Professor, Delft University of Technology-Faculty of Architecture and the Built Environment, The Netherlands Evaluation of Using BEAM-PLUS to Facilitate Waste Reduction in Building Construction Lara Celine JAILLON, City University of Hong Kong, Hong Kong SAR Energy, Comfort and Cost Optimization of A Net-Zero Energy Building in Berlin Olaf BOETTCHER, Federal Institute for Research on Building, Urban Affairs and Spatial Development, Germany Modeling the Built Environment Element by Element: Uncovering Greenhouse Gas Intensive Policies and Structures with a New Visualization Tool Verena GÖSWEIN, Instituto Superior Técnico, University of Lisbon, Portugal</p>

<p>Session 3.3 Advanced Building Systems - Energy Generation (1) Level 1 - Theatre 2</p>	<p>Session 3.4 Policies for High-Performance Green Buildings (2) Level 2 - S221</p>
<p>Session Chair: Phil JONES Chair of Architectural Science, Welsh School of Architecture, Cardiff University, United Kingdom; Visiting Research Professor, Faculty of Architecture, University of Hong Kong, Hong Kong SAR</p>	<p>Session Chair: Lloyd Martin SCOTT Dublin Institute of Technology, Ireland</p>
<p>Analysis of Fourth-Generation District Energy Systems with Renewable Energy Cogeneration by Using Rational Exergy Management Model Birol KILKIS, Baskent University, Turkey</p> <p>The Application of Solid Oxide Fuel Cells in Buildings for Electricity, Heating and Cooling Tri-generation Using Natural Gas or Bio-gas from Waste WANG Qiancheng, Department of Building Real Estate, The Hong Kong Polytechnic University, Hong Kong SAR</p> <p>Building and Community Energy Retrofit Housing in Wales LI Xiaojun, Research Associate, Cardiff University, United Kingdom</p> <p>Geothermal District Heating Investigation of Retired Oil/Gas Wells as Higher-temperature Renewable Heat Sources GUO Hongshan, Princeton University, United States of America</p>	<p>Baseline and Water Efficiency for Green Building in Taiwan CHENG Cheng-li, Dean of Design College; President of AIT, National Taiwan University of Science and Technology, Taiwan</p> <p>A Comparative Study on Economic Policies for Construction and Demolition Waste Minimization Jack CP CHENG, The Hong Kong University of Science and Technology, Hong Kong SAR</p> <p>Using Supply Chain Management for Sustainable Public Procurement Johannes WALL, Graz University of Technology, Austria</p> <p>Innovative Measures to Protect Residential Developments from Traffic Noise - Hong Kong Experience LAU Kwok-keung, Principal Environmental Protection Officer, Environmental Protection Department, Government of the HKSAR, Hong Kong SAR</p> <p>Energy Efficiency for a Sustainable Built Environment in Nigeria Susanne GEISSLER, SERA energy & resources, Austria</p>
<p>Session 3.7 - Session Organiser: AECOM High Performance Transportation Hubs: Their Critical Role and Requirements? Level 2 - S224 & 225</p>	<p>Session 3.8 Innovative Practices for Occupant Wellbeing - Bioclimatic Design Level 4 - S426 & 427</p>
<p>Session Chair: Sylvester Timothy WONG Vice President, Strategies + Development, Buildings + Places, Asia; Head of Buildings + Places, Philippines & Emerging Markets, AECOM, Philippines</p>	<p>Session Chair: Clinton ANDREWS Professor of Urban Planning & Policy Development, Rutgers University, United States of America</p>
<p>Marc COLELLA, Industry Director, Building Structures Practice Lead, Australia and New Zealand, AECOM, Australia</p> <p>Kevin POOLE, Executive Director, Third Runway, Airport Authority Hong Kong, Hong Kong SAR</p> <p>Tony ARMSTRONG, Asia Pacific Representative, International WELL Building Institute</p>	<p>Bringing Sustainable Neighbourhood Design into Reality—Case Sharing by Brickell City Centre, Miami Benny AU, Sustainable Development Manager, Swire Properties Ltd., Hong Kong SAR</p> <p>On the Study of Thermal Comfort and Temperature Enhancements by Park Features CK CHAU, The Hong Kong Polytechnic University, Hong Kong SAR</p> <p>Passive Design Strategies for Building Envelopes in Different Orientations Elizabeth PARRA, PVG Arquitectos, Colombia</p> <p>An Integrated Urban Microclimate and Building Energy Model for Early Stage Design HUANG Jianxiang, The University of Hong Kong, Hong Kong SAR</p> <p>Re-Thinking Courtyard Housing: Development of Traditional Islamic Courthouses into Zero-Energy Buildings Osama Mohamed OMAR, Assistant Professor of Architecture, Beirut Arab University, Lebanon</p>

<p>Session 3.9 Practices & Methodologies for Green Building Management (3) Level 2 - S228</p>	<p>Session 3.10 Transforming SBE Practices - Energy Management (2) Level 4 - S425</p>
<p>Session Chair: Thomas LÜTZKENDORF Director, Centre for Real Estate; Head of Chair, Sustainable Management of Housing and Real Estate, Karlsruhe Institute of Technology, Germany</p>	<p>Session Chair: Tim HILL Research Director, Eco-business Research, Singapore</p>
<p>Life Story of the Repurposed Shipping Container Alice LF YEUNG, Chief Architect, Architectural Services Department, Government of the HKSAR, Hong Kong SAR</p> <p>Factors Influencing Human Capability to Practice Sustainability in Facilities Management (FM) – A Review Fathima Sabrina NAZEER, University of Moratuwa, Sri Lanka</p> <p>Sustainable Construction: Quality of Life of Construction Workers in Private sector: Case Study of L.P.N. Development Public Co., Ltd., Pimchanok SRIRUTTRAKUL, Wisdom Consulting and Solution, Thailand</p> <p>Mining for Resources: Problem-oriented Building Information Management and Development of Agile Facility Management Methodologies Through Industry-University-Public Collaborations Yu MORISHITA, Assistant Professor, The University of Tokyo, Japan</p> <p>Development of MERIT and Normalization Factor for Different Operating Hours for Building Energy Intensity (BEI) Kevin HOR, Edgenta Energy Services PLC, Malaysia</p>	<p>Dynamic CO2 and occupancy modelling for predictive control Alexandros PANTAZARAS, National University of Singapore, Singapore</p> <p>Retro-commissioning Practice and In-depth Analysis Leading to Efficiency Optimization on HVAC Systems: Case Study on A Retail Mall in China Jean QIN, Swire Properties Ltd., Hong Kong SAR</p> <p>Study of Chiller Part Load Values for Hong Kong and Subtropical Climate LEUNG Wai-ho, Senior Engineer, Arup, Hong Kong SAR</p> <p>HVAC System Design and Operation Performance of a Low-Carbon High-Rise Tenant Office Building Located in Tokyo Yuichi TAKEMASA, General Manager, Kajima Technical Research Institute Singapore, Singapore</p> <p>Optimizing Energy Efficiency for a High Rise Office Tower in Tropics NG Yong-kong, NYK Engineering and Trading Sdn Bhd, Malaysia</p>
<p>Session 3.13 Community Empowerment (1) Level 2 - S226 & 227</p>	<p>Session 3.14 - Session Organiser: Somfy Asia-Pacific Co. Ltd. Environmentally Responsive Buildings and Human Interactions Level 4 - S428</p>
<p>Session Chair: Tony IP Deputy Director of Sustainable Design, Ronald Lu & Partners, Hong Kong SAR</p>	<p>Session Chair: Anders HALL International Business Development, Somfy International; Chairman, Marketing & Communication, ES-SO (EU Solar Shading Organisation)</p>
<p>The Strategy of Launching Rural Regeneration in Pingtung County Government HUNG Chieh-jen, Pingtung County Government, Taiwan</p> <p>2030 Districts: Putting Ideas into Action LI Jixin, China Lead, 2030 Districts</p> <p>Jiri SKOPEK, Managing Director, JLL, Canada; 2030 Districts</p> <p>A Critical Discussion on the Role of Architectural Practice in Development of Rural China: for Living Sustainably LI Ke-han, The Chinese University of Hong Kong, Hong Kong SAR</p> <p>Retrofit or Behaviour Change? Which Has the Greater Impact on Energy Consumption in Low Income Households? Melissa JAMES, Senior Experimental Scientist, CSIRO, Australia</p> <p>Towards a Holistic Methodology: A Practical Approach to Local Energy Planning Thomas SCHLUCK, Senior Scientist, Hochschule Luzern, Switzerland</p>	<p>Research and Experiences on Sustainability by ES-SO Anders HALL, Somfy International; Chairman, Marketing & Communication, ES-SO</p> <p>The Architect's View on a Design of More Sustainable and High Performing Facades – and It Works! Mark CURZON, Director of Architecture, Fender Katsalidis Mirams Architects</p> <p>Case Study - Understanding the key learnings from the use of Automated Solar Shading in Sustainable Buildings Alistair GRICE, Commercial Specification Manager, Somfy Oceania</p> <p>Connected Homes: A More Comfortable, Secure and Sustainable Life in the Future Jean-Pierre DUMAS, Managing Director, iHome Systems</p> <p>Panel Discussion</p>

<p>Session 3.11 BIM for Sustainability (1) Level 4 - S421</p>	<p>Session 3.12 - Session Organiser: Allied Environmental Consultants Ltd. Emerging Practices in Sustainable Built Environment Level 4 - S423 & 424</p>
<p>Session Chair: Paul HO Director, Professional Green Building Council, Hong Kong SAR</p>	<p>Session Chair: Grace KWOK Managing Director, Allied Environmental Consultants Ltd.</p>
<p>BIM Based Deep Building Renovation Optimization for Sustainability HUANG Lizhen, Associate Professor, Norwegian University of Science and Technology, Norway</p> <p>Integrating BIM for Sustainable Planning, Design, Construction and Facility Management for Hong Kong's Public Housing Development Lawrence KW CHUNG, Assistant Director of Housing (Development and Construction), Hong Kong Housing Authority, Government of the HKSAR, Hong Kong SAR</p> <p>BIM Enabled Life Cycle Environmental Analysis for a Small Scale Zero Energy House LI Qiyuan, School of Architecture, Tianjin University, Mainland China</p> <p>The Use of FTA (Fault Tree Analysis) to Evaluate the Contribution of BIM Platform to the Environmental Quality on Rehabilitated Buildings Monica Santos SALGADO, Federal University of Rio de Janeiro, Brasil</p> <p>Sustainable Buildings with BIM Peter KONCZ, Sales Manager, GRAPHISOFT Asia Ltd., Hong Kong SAR</p>	<p>Acoustics and Lighting Design for Green Building Henry Chan Chi-kee, Associate Director, Allied Environmental Consultants Ltd.</p> <p>Showcase of Green Campus Development in Hong Kong – A Case Review of Hang Seng Management College's Master Campus Expansion Plan Danica CHAN, Environmental Consultant, Allied Environmental Consultants Ltd.</p> <p>Drive towards Sustainable Development and Management: Case Study on International Commerce Centre Andy LAI, Senior Consultant, Allied Environmental Consultants Ltd.</p> <p>Intelligence, Collaboration, Continuity – A Case Study of Improving the Environmental Performance of an Office Building Lewis LAM, Assistant General Manager (Property Management), Kai Shing Management Services Ltd.</p> <p>Sustainability Strategies in Towngas Headquarters Building Nelson LO, Property Management Manager, The Hong Kong and China Gas Company Ltd.</p>

<p>Session 4.1 - Session Organiser: Green Building Research Centre and the Chinese Society for Urban Studies Mainland China Session - The Development Framework and Professional Best Practices of Healthy Buildings in China Level 1 - Convention Hall</p>	<p>Session 4.2 International Youth Competition (2) Level 1 - Theatre 1</p>
<p>Session Chair: MENG Chong Deputy Director, Green Building Research Centre, Chinese Society for Urban Studies, China</p>	<p>Session Chair: Edward NG Chairman, International Youth Competition Sub-committee, WSBE17 Hong Kong Scientific Committee; Professor of Architecture, School of Architecture, The Chinese University of Hong Kong, Hong Kong SAR</p>
<p>Water is the Essence of Healthy Building ZENG Ji, Deputy Director, Architectural Design Institute, China Academy of Building Research The Control and Prevention of Indoor PM2.5 against the Health Risks of Occupants ZHANG Yinping, School of Architecture, Tsinghua University, China Development of the China Healthy Building Assessment Standards and its Professional Practices MENG Chong, Deputy Director, Green Building Research Centre, Chinese Society for Urban Studies, China Technological Innovations and Best Practices of Healthy Buildings JIA Yan, Founder & CEO, First Human Environmental Technologies (Beijing) Co., Ltd., China</p>	<p>Presentation of 8 Shortlisted Teams Q & A Final Judging by International Jury Panel Thomas AUER, Managing Director, Transsolar; Professor, Building Technology and Climate Responsive Design, Technical University of Munich George BAIRD, Emeritus Professor of Building Science, School of Architecture, Victoria University of Wellington Greg FOLIENTE, Enterprise Professor, University of Melbourne; Regional Director in Asia-Pacific, iSBE; Founding Director, nBlue Pty Ltd Peter GUTHRIE, Professor, Engineering for Sustainable Development, University of Cambridge Deborah KUH, Head of Greening, Landscape and Tree Management Section, Government of the HKSAR Christine LOH, Under Secretary for the Environment, Government of the HKSAR Serge SALAT, President, Urban Morphology & Complex Systems Institute Arno SCHLUETER, Professor, Architecture and Building Systems ETH Zurich; Principal Investigator, Future Cities Laboratory, Singapore ETH Centre</p>
<p>Session 4.5 Performance Review of Green Buildings (2) Level 2 - S222</p>	<p>Session 4.6 Green Construction Technologies (1) Level 2 - S223</p>
<p>Session Chair: Lan DING Senior Lecturer, Faculty of Built Environment, University of New South Wales, Australia</p>	<p>Session Chair: Guillaume HABERT Professor, ETH Zurich, Switzerland</p>
<p>The Importance of Understanding The Material Metabolism of The Built Environment Danielle DENSLEY TINGLEY, Lecturer in Architectural Engineering, The University of Sheffield, United Kingdom Net Environmental Loads of Mineral Admixtures and Portland Blended Cements Marcella Ruschi SAADE, University of Campinas, Brazil Embodied Energy and Global Warming Potential in Construction – Perspectives and Interpretations Maria BALOUKTSI, Karlsruhe Institute of Technology, Germany Study of Human Embodied Energy for Masonry Work During Building Construction Sivakumar PALANIAPPAN, Assistant Professor, Indian Institute of Technology Madras, India The Life Cycle Cost-Energy Relationship Of Buildings WANG Jie, The University of Hong Kong, Hong Kong SAR</p>	<p>Watering Type and Water Consuming Assessment of the Green Construction Fence in Taichung City, Taiwan CHEN Chen-chun, Feng Chia University, Taiwan Low Carbon Construction Implementation in a Public Housing Development and the Implication to the Life Cycle Decision Making Tool Felix WONG Yat-hang, Senior Environmental Consultant, AECOM Asia Co. Ltd., Hong Kong SAR Use of Incineration Bottom Ash for Road Construction in Singapore Kelvin LEE Yang-pin, Senior Technical Manager, Samwoh Innovation Centre, Singapore Exploring the Relationships between Construction Phases and Sustainable Construction Principles Olabode Emmanuel OGUNMAKINDE, University of Newcastle, Australia</p>

<p>Session 4.3 Advanced Building Systems - Energy Generation (2) Level 1 - Theatre 2</p>	<p>Session 4.4 Processes of High-Performance Green Buildings Level 2 - S221</p>
<p>Session Chair: Wafaa NADIM Associate Professor, The German University in Cairo, Egypt</p>	<p>Session Chair: Ron WAKEFIELD Head of the School of Property, Construction and Project Management (PCPM) and Deputy Pro Vice Chancellor International, RMIT University, Australia</p>
<p>Exergoeconomic Assessment of a Building Integrated Photovoltaic (BIPV) System: A Case Study of Yasar University, Izmir, Turkey Arif HEPBASLI, Chairman of Energy Systems Engineering Department, Yasar University, Turkey</p> <p>Variations of Systematic Solutions for 24-hour Operating Sustainable Small-scale Commercial Buildings Bumpei MAGORI, Project Lecturer, Institute Industrial Science, the University of Tokyo, Japan</p> <p>Study on the Potential of Converting Former Military Bunkers into Energy Storage Facilities Joachim SCHULZE, Research Assistant, Architect M.Sc., Technical University Darmstadt, Germany</p> <p>An Evaluation of Building Integrated Wind Energy Mehmet Koray PEKERICLI, METU, Turkey</p>	<p>What Are The Most Effective Drivers of Sustainable Development in The Decision Making Process Hanne Tine Ring HANSEN, Sustainability Engineer, Søren Jensen Consulting Engineers, Denmark</p> <p>German ÖKOBAUDAT Goes International - An Online Infrastructure for LCA as Basis for International Structures Tanja BROCKMANN, Head of Division Construction and Environment, BBSR Federal Inst. for Research on Building, Urban Affairs and Spatial Development, Germany</p> <p>How Actors Can Implement in Practice the General Principles of Sustainability in Their Buildings and Civil Engineering Projects Thomas LÜTZKENDORF, Director, Centre for Real Estate; Head of Chair, Sustainable Management of Housing and Real Estate, Karlsruhe Institute of Technology, Germany</p> <p>Driver And Challenges Facing Leadership in Adopting Sustainability in The Built Environment: A Developer's Perspective ZHANG Xiaoling, Department of Public Policy, City University of Hong Kong, Hong Kong SAR</p> <p>Analysing the Reference Flows for Energy Efficient Retrofit of Typical Residential Building in Tianjin, China LIU Lu, School of Architecture, Tianjin University, Mainland China</p>
<p>Session 4.7 - Session Organiser: Swire Properties Ltd. The Secret Ingredients of Sustainable Real Estate Development Level 2 - S224 & 225</p>	<p>Session 4.8 Innovative Biophilic Design for Wellbeing Level 4 - S426 & 427</p>
<p>Session Chair: Ashley HEGLAND Consultant, Swire Properties Ltd.</p>	<p>Session Chair: Alan FOGARTY Sustainability Partner, Cundall, Hong Kong SAR</p>
<p>Themes/Trends of Sustainable Urban Planning and Sustainable Built Environment Christopher LAW, Founding Director, Oval Partnership, Hong Kong SAR</p> <p>Ingredients of Sustainable Real Estate: Criteria, Transparency, Engagement Ruben LANBROEK, Head of Asia Pacific, GRESB, Singapore</p> <p>Climate Change and Sustainable Real Estate: The Environmental, Social, and Economic Implications Liam SALTER, CEO, RESET Carbon</p> <p>Swire Properties' Approach to Sustainable Real Estate Raymond YAU, General Manager, Technical Services & Sustainable Development, Swire Properties Ltd.</p>	<p>System Ecology as a Design Tool for Water Resources and its Environmental Education DAY Yeong-tyi, Associate Professor, Chung Yuan Christian University, Taiwan</p> <p>Sustainable Neighbourhood of Shek Wu Hui Sewage Treatment Works Echo LEONG I-man, Executive Director, AECOM Asia Company Ltd., Hong Kong SAR</p> <p>Biophilia and Nature-based Features to Support Stress Reduction in Knowledge Workers Ann CALLAGHAN, Conestoga College, Canada; Algonquin College, Canada</p> <p>Pioneering "Comprehensive Urban Landscape Technology" (CULT): An Integrated System Model for Urban Sustainability as Community Amenity in a Compact Urban Environment Thomas CHUNG Wang-leung, The Chinese University of Hong Kong, Hong Kong SAR</p> <p>Foster a Healthy Community through Active Design & Biophilic Design WANG Hong, Executive Director, AECOM Asia Company Ltd., Mainland China</p>

<p>Session 4.9 - Session Organiser: Arup A Collaborative Approach in Delivering Low Carbon Living Level 2 - S228</p>	<p>Session 4.10 Transforming SBE Practices - Energy Management (3) Level 4 - S425</p>
<p>Session Chair: Jimmy CK TONG Associate & East Asia Energy Skill Leader, Arup, Hong Kong SAR</p>	<p>Session Chair: Clinton ANDREWS Professor of Urban Planning & Policy Development, Rutgers University, United States of America</p>
<p>Beyond Energy and Resource Efficiency: Sustainable Building in Digital Transformation Vincent CHENG, Director of Building Sustainability, Arup, Hong Kong SAR</p> <p>Investing for Longer-term Development: Financing the New Generation in Sustainability Carl BERRISFORD, UBS Wealth Management, Head of Sustainable Investing, APAC Chief Investment Office, Hong Kong SAR</p> <p>Creation of Green Neighbourhood Edwin CHAN, Project Director, New World Development Company Ltd., Hong Kong SAR</p> <p>Tall Buildings and Sustainability Florence CHAN, Director, Kohn Pedersen Fox Associates PC, Hong Kong SAR</p>	<p>Energy Data Transparency Benefits to Drive Down of Energy Consumption in A Green Hotel Antonio CM CHAN, REC Engineering Co., Ltd., Hong Kong SAR</p> <p>ACT-Shop – A Retro-commissioning Scheme for Existing Buildings in Hong Kong Cary CHAN, Executive Director, Hong Kong Green Building Council Ltd., Hong Kong SAR</p> <p>Low-Carbon Building Environment Adaptation Countermeasures of Pingtung County CHEN Ping-hung, Pingtung County Government, Taiwan</p> <p>Impact of Energy Recovery Ventilation on The Ventilation and CO2 Concentration in One Bedroom Condominium in Thailand Daranee JAREEMIT, Associate Dean for Academic Affairs, Faculty of Architecture and Planning, Thammasat University, Thailand</p> <p>Panpisu JULPANWATTANA, Senior Sustainable Designer, Magnolia Quality Development Corporation Ltd., Thailand</p>
<p>Session 4.13 Community Empowerment (2) Level 2 - S226 & 227</p>	<p>Session 4.14 - Session Organiser: The Hong Kong Polytechnic University PolyU Green Deck : A Catalyst for a Green and Vibrant Community Level 4 - S428</p>
<p>Session Chair: LEUNG Man-kit Director of Sustainable Design, Ronald Lu & Partners (Hong Kong) Limited, Hong Kong SAR</p>	<p>Session Chair: Alex LUI Chun-wan Chairman, Green Deck Task Force, The Hong Kong Polytechnic University, Hong Kong SAR</p>
<p>'Pride the Citizens Action Factor for Resilient Sustainable Cities' Results of the 2016 Questionnaire Research Under Dutch Amsterdam Council Members Fred SANDERS, Researcher and Lecturer, Delft University of Technology in the Netherlands, The Netherlands</p> <p>Enhance Public Sustainability Awareness by Feng Shui Patrick LUI Yin-park, Senior Engineer, Cundall Hong Kong Ltd., Hong Kong SAR</p> <p>Social Sustainability Stephen YIM, Chief Architect; Development & Standards, Hong Kong Housing Authority, Government of the HKSAR, Hong Kong SAR</p> <p>The Application of Social Innovation in Designing an Aged Care Centre in Malaysia Thomas TANG Sek-khuen, Kuala Lumpur Centre for Sustainable Innovation, Malaysia</p> <p>Ritualised Place and Community Empower Wasana DE SILVA, Senior Lecturer, University of Moratuwa, Sri Lanka</p>	<p>From Grey to Green Alex LUI Chun-wan, Chairman, Green Deck Task Force, The Hong Kong Polytechnic University, Hong Kong SAR</p> <p>Improving Neighbourhood Sustainability with Landscaping in the Context of Climate Change: A Case Study of the Proposed Green Deck in Hong Kong Edwin CHAN, The Hong Kong Polytechnic University, Hong Kong SAR</p> <p>Noise Mitigation Potential of PolyU Green Deck Proposal TANG Shiu-keung, The Hong Kong Polytechnic University, Hong Kong SAR</p> <p>Effect of Green Deck on Local Air Quality LEE Shun-cheng, The Hong Kong Polytechnic University, Hong Kong SAR</p> <p>Proposed Green Deck Project: A Framework for Engaging Stakeholders Esther YUNG Hiu-kwan, The Hong Kong Polytechnic University, Hong Kong SAR</p> <p>"Smart Green Resilient" Integrative Urban Environment Wilfred LAU, Director, Arup, Hong Kong SAR</p> <p>Panel Discussion</p>

<p>Session 4.11 BIM for Sustainability (2) Level 4 - S421</p>	<p>Session 4.12 Healthy Building, Human Comfort & Wellbeing Level 4 - S423 & 424</p>
<p>Session Chair: Paul HO Director, Professional Green Building Council, Hong Kong SAR</p>	<p>Session Chair: Holger WALLBAUM Full Professor in Sustainable Building, Chalmers University of Technology, Sweden</p>
<p>Assessment of Different Data Collection Methods for the Creation of BIM Models for Existing Buildings Bjoern Arild GODAGER, Assistant Professor, Norwegian University of Science and Technology, Norway</p> <p>Boost Sustainability Certification by Using BIM Heinz J. BERNEGGER, Zurich University of Applied Sciences ZHAW, Institute of Facility Management, Switzerland</p> <p>LCA Integration in BIM Through The Use of Integrated Dynamic Models Marios TSIKOS, Civil Engineer, Burohappold Engineering, United Kingdom</p> <p>Visualizing Embodied Impacts Using Building Information Modeling (BIM) Martin RÖCK, Scientific Assistant, Working Group Sustainability Assessment - Institute of Technology and Testing of Building Materials - Graz University of Technology, Austria</p> <p>Lifecycle Evaluation of Building Sustainability Using BIM ZHANG Cheng, Assistant Professor, Xi'an Jiaotong-Liverpool University, Mainland China</p>	<p>Healthy Buildings & Energy Performance – A Balancing Act Eriko TAMURA, Assistant Engineer of Building Sustainability, Arup, Hong Kong SAR</p> <p>Significance of Sky Gardens for Healthy High-rise Living of Urban Children and Old Adults Tony IP, Deputy Director of Sustainable Design, Ronald Lu & Partners (Hong Kong) Ltd., Hong Kong SAR</p> <p>Radon Infiltration in Existing Rented Accommodation Torben Valdbjørn RASMUSSEN, Danish Building Research Institute, Aalborg University, Denmark</p> <p>A Case Study on Industrial Building IEQ Control and Operation Performance Analysis WANG Hui, Green Building Engineer, BlueScope Building System (Xi'an) Co., Ltd., Mainland China</p> <p>Research on the Strategies and Methods in Productive Green Renovation of Existing Urban Communities DING Xiaoying, Tianjin University, Mainland China</p>

<p>Session 5.1 Regional Session - Canada, Brazil-Portugal, The Netherlands, Germany and Tallinn-Helsinki Level 1 - Convention Hall</p>	<p>Session 5.2 - Session Organiser: Sweden Green Building Council High Performance Buildings and Sustainable Neighbourhoods in Sweden Level 1 - Theatre 1</p>
<p>Session Chair: Luis BRAGANÇA University of Minho, Portugal</p>	<p>Session Chair: Bengt WÄNGGREN CEO and Founding Chairman, Sweden Green Building Council; Member of the Board, World Green Building Council</p>
<p>SBE16 Toronto Harry Robert BACH, Secretary Treasurer, iiSBE Canada; Director and Treasurer, iiSBE International; Director and Treasurer, Sustainable Buildings Canada</p> <p>SBE16 Brazil-Portugal Cristina Engel ALVAREZ, Professor/Coordinator, Laboratório de Planejamento e Projetos, Universidade Federal do Espírito Santo, Brazil</p> <p>SBE16 Hamburg Thomas LÜTZKENDORF, Director, Centre for Real Estate; Head of Chair, Sustainable Management of Housing and Real Estate, Karlsruhe Institute of Technology, Germany</p> <p>SBE16 Tallinn-Helsinki Pekka HUOVILA, Coordinator, 10YFP Sustainable Buildings and Construction (SBC) Programme</p> <p>SBE16 Utrecht Ivo OPSTELTEN, Professor, University of Applied Sciences Utrecht</p>	<p>Five Cases of Best Practice High-Performance Buildings in Sweden</p> <p>LIDL Växjö Johan AUGUSTSSON, Property Director, LIDL Sweden</p> <p>Greenhouse Augustenborg Jenny HOLMQUIST, Environmental Strategist, MKB Fastighet</p> <p>Solallén Björn BERGGREN, Senior Consultant/Phd Student, Skanska/Lund University</p> <p>BRF Viva Charlotta SZCZEPANOWSKI, Sustainability Director, Riksbbyggen Anders JOHANSSON, Project Manager, Riksbbyggen.</p> <p>IKEA Hubhult Bengt WÄNGGREN, CEO and Founding Chairman, Sweden Green Building Council; Member of the Board, World Green Building Council</p> <p>Three Projects for Sustainable Neighbourhoods in Sweden</p> <p>Citylab Tomas GUSTAFSSON, Program Director for Citylab Action, Sweden Green Building Council</p> <p>C/O City Emilie ZETTERSTRÖM, Communications officer, Sustainability and Innovation, The City of Stockholm</p> <p>Decode Åsa NORMAN, Sustainability Consultant, Tyréns Sarah BRAGÉE, Department Manager of Strategic Analysis, Tyréns</p>
<p>Session 5.5 SBE Assessments - Green Building Policies Level 2 - S222</p>	<p>Session 5.6 Green Construction Technologies (2) Level 2 - S224 & 225</p>
<p>Session Chair: Antonin LUPISEK Head of Department, Architecture and the Environment, Czech Technical University, Czech Republic</p>	<p>Session Chair: Andrew LEUNG Emeritus Professor, City University of Hong Kong; China Green Building (HK) Council, Hong Kong SAR</p>
<p>From Research to a National Standard: SBTool and Protocollo ITACA Andrea MORO, President, iiSBE Italia R&D, Italy</p> <p>The Network for Sustainable Federal Building as an Instrument of Quality Assurance in the Implementation of the Assessment System BNB in the Public Sector Andreas RIETZ, Head of Division Sustainable Building, Federal Institute for Research on Building, Urban Affairs and Spatial Development, Germany</p> <p>Competing Visions for Building Materials Assessment in US Green Building Certification Programs Charles Joseph KIBERT, Professor-Centre Director, University of Florida, United States of America</p> <p>CESBA: Together to a Harmonized Built Environment Assessment Markus BERCHTOLD-DOMIG, Spatial Planner, Heimateen, Austria</p> <p>LEED CS in Brazil: Discussing the Validity of the Method for the Improvement of Environmental Quality on Buildings Monica Santos SALGADO, Professor, Federal University of Rio de Janeiro, Brazil</p>	<p>Innovative Building Technologies Towards Sustainable Construction – A Comparative LCA and LCC Assessment Alexander PASSER, Assistant Professor, Graz University of Technology, Austria</p> <p>A Peer-to-peer Reviewing Framework for Selecting Construction Material Suppliers Using the Integration of Building Information Modelling and Web-Map Service NGUYEN Thanh-chuong, National Taiwan University, Taiwan</p> <p>Improving the Sustainable Supply Chain of Housing Industrialization with Transaction Costs Considerations Queen K QIAN, OTB Research Institute for the Built Environment, Delft University of Technology, The Netherlands</p> <p>A Research Proposal to Improve the Environmental Performance of the Building Industry, by Increasing the Innovation Activity of Small Contractors Timothy ROSE, Queensland University of Technology, Australia</p> <p>Mongolia's First Cooperative Transformation Attempt on Built Environment through Greening Kindergarten Building Nergui DORJ, Founder and BOD member, Mongolia Green Building Council, Mongolia</p>

<p>Session 5.3 Smart Initiatives in SBE (1) Level 1 - Theatre 2</p>	<p>Session 5.4 Deep Renovations - Policies & Standards Level 2 - S221</p>
<p>Session Chair: Natalie ESSIG University of Applied Sciences Munich (MUAS), Germany</p>	<p>Session Chair: Kenneth CHAN Director, BEAM Society Limited, Hong Kong SAR</p>
<p>The New Smart Cities Cities Built from Scratch and Old Cities Transformed into Smart Cities. Sustainable Growth Ana Claudia Figueiredo OLIVEIRA, Lisbon Faculty of Architecture, Portugal</p> <p>Enhanced Engineering Services for Electrical & Mechanical System via Integrated Building Management System, Remote Monitoring Unit, and Geographic Information System LEE Che-kit, Chief Engineer, Electrical and Mechanical Services Department, Government of the HKSAR, Hong Kong SAR</p> <p>Decarbonising the City: Micro Energy Grids Richard WANG, Sustainability Consultant, Arup, Hong Kong SAR</p> <p>A Multi-disciplinary Approach in Developing Sustainable Built Environment: A Case Study in Hong Kong Kowloon East Development Project (KEDP) Schuman LAM, The Hong Kong Polytechnic University, Hong Kong SAR</p> <p>Sy(energies between Mega Event Buildings and the Surrounding Neighbourhoods Simone MAGDOLEN, Munich University of Applied Sciences, Germany</p>	<p>Small, Beautiful, Yet Difficult: Energy Plus Renovation in Small Social Housing Companies Christian KOCH, Chalmers University of Technology, Sweden</p> <p>Deep Renovation as Tool for Active Protection of Modern Heritage: The Case of Architecture for The Service Sector Claudia CALICE, University of Rome, Italy</p> <p>Future Challenges for Renovation as Experienced by Housing Companies Liane THUVANDER, Chalmers University of Technology, Sweden</p> <p>Integration of Sustainability Analyses into Business models for Energy Renovation of Buildings: A Case Study in Norway Roberta MOSCHETTI, Norwegian University of Science and Technology, Norway</p> <p>The Development and Practice of Existing Buildings Green Retrofitting in China WANG Qingqin, China Academy of Building Research, Mainland China</p>
<p>Session 5.7 Innovations Driving for Greener Policies and Standards - Assessment, Analysis and Modelling (1) Level 2 - S223</p>	<p>Session 5.8 Sustainable Neighbourhoods - Case Study Review (1) Level 4 - S426 & 427</p>
<p>Session Chair: Guillaume HABERT Professor, ETH Zurich, Switzerland</p>	<p>Session Chair: Ellie TANG Head of Sustainability, New World Development Company Limited, Hong Kong SAR</p>
<p>European Horizontal Standardized Methods for the Assessment of the Sustainability Aspects of Construction Works Ari ILOMAKI, Senior Adviser, Confederation of Finnish Construction Industries, Finland</p> <p>Life Cycle Energy and GHG Emissions Reductions of Retrofit Options for Existing Dwelling Stock Greg FOLIENTE, Enterprise Professor, University of Melbourne; Regional Director in Asia-Pacific, iiSBE; Founding Director, nBlue Pty Ltd</p> <p>Renewable Energy Technologies - Economic Analysis Tool (RET-EAT) for Turkey Oguz Kursat KABAKCI, Expert on Energy And Natural Resources, Ministry of Energy And Natural Resources, Turkey</p> <p>Geo-dependent Heat Demand Model of the Swiss Building Stock Stefan SCHNEIDER, University of Geneva, Switzerland</p> <p>Quantitative Impact Assessment of SEAP Measures Implementation on Several Districts in the City of Donostia-San Sebastian Xabat OREGI, Tecnalia Research & Innovation, Spain</p>	<p>Learning from the Lessons of Transit-oriented Development to Improve Urban Planning in China Frederic Daniel DU VERLE, Urban Planner & Designer, Archimedialab, Germany / Mainland China</p> <p>A Green Campus Master Plan - The Chinese University of Hong Kong (CUHK) FUNG Siu-man, Director of Campus Development, The Chinese University of Hong Kong, Hong Kong SAR</p> <p>Stepping Up to the Water-Energy Nexus Challenges at Tai Po Water Treatment Works Jeffrey LAI Siu-ming, Engineer, Water Supplies Department, Government of the HKSAR, Hong Kong SAR</p> <p>Development Strategies for the Green Industry in Pingtung County KUO Wu-wei, Executive officer, Pingtung County Government, Taiwan</p> <p>Strategic Planning for Sustainable Neighbourhoods: A Case Study from Palestine Sameer ABU-EISHEH, Professor of Civil Engineering, An-Najah National University, Palestine</p>

<p>Session 5.9 Transforming Green Market - Green Economics (1) Level 2 - S228</p>	<p>Session 5.10 Zero Energy Level 4 - S423 & 424</p>
<p>Session Chair: Tim HILL Research Director, Eco-business Research, Singapore</p>	<p>Session Chair: Ron WAKEFIELD Head of the School of Property, Construction and Project Management (PCPM) and Deputy Pro Vice Chancellor International, RMIT University, Australia</p>
<p>Stakeholders View on Commercial Benefits for Energy Neutral Refurbishment of Let Properties Angela GRECO, Delft University of Technology, The Netherlands</p> <p>How a Changing Socioeconomic Context Affects the Demand for High-performance Buildings Clinton ANDREWS, Rutgers University, United States of America</p> <p>Green Lease Insight - Integrated Approach Andrew NICHOLSON, Executive Managing Director, Head of Asset Services, Asia Pacific, CBRE, RICS, Hong Kong SAR</p> <p>How Sustainable Planning Increases Real Estate Property Value Serge SALAT, President, Urban Morphology and Complex Systems Institute, France</p> <p>Responsible Investing in Green Buildings and Portfolios Ruben LANGBROEK, Head of Asia Pacific, GRESB, Singapore</p>	<p>Achieving Net Zero Carbon: A Case Study of Hong Kong's First Zero Carbon Building Justin LI, Assistant Director - Environmental & Sustainability, Construction Industry Council, Hong Kong SAR</p> <p>Life Cycle Greenhouse Gas Emissions of Material Use in the Living Laboratory Marianne Rose KJENDSETH WIIK, SINTEF, Norway</p> <p>Paradoxical Feasibility of High-rise Zero Carbon Buildings PAN Wei, Associate Professor, The University of Hong Kong, Hong Kong SAR</p> <p>Studies of Energy-Efficient Measures and Building Integrated Photovoltaic Toward Net Zero Energy Building LOU Siwei, City University of Hong Kong, Hong Kong SAR</p> <p>Net Zero Energy Building Policy: Benchmarking Australian Practices Against Asia Pacific Countries Usha IYER-RANIGA, Deputy Head International and Co Lead UN 10YFP SBC Programme, RMIT University, Australia</p>
<p>Session 5.13 Stakeholder Collaboration Level 2 - S226 & 227</p>	<p>Session 5.14 - Session Organiser: Sino Group Smart and Digital Transformation for Sustainable Living Level 4 - S428</p>
<p>Session Chair: Thomas NG Professor (Construction Engineering and Management), The University of Hong Kong, Hong Kong SAR</p>	<p>Session Chair: Jimmy CK TONG Associate & East Asia Energy Skill Leader, Arup, Hong Kong SAR</p>
<p>Green Management by Stakeholder Empowerment - The Hong Kong Housing Authority Experience Ada FUNG, Deputy Director of Housing (Development & Construction), Hong Kong Housing Authority, Government of the HKSAR, Hong Kong SAR</p> <p>CoLLaboratoire Montreal: Living Experiments for Climate Change Awareness Carmela CUCUZZELLA, Design and Computation Arts, Concordia University, University Research Chair IDEASBE, L.E.A.P, Canada</p> <p>Putting Regenerative Development into Action: Understanding the Decision-making Process of a 680 Hectares Regenerative Project Dominique HES, Director – Thrive Research Hub, The University of Melbourne, Australia</p> <p>Gamification as A Means to User Involvement in Decision-making Processes for Sustainable Buildings Hanne Tine Ring HANSEN, Sustainability Engineer, Søren Jensen Consulting Engineers, Denmark</p> <p>Accelerating HKIA's Carbon Footprint Reduction through Multi-stakeholder Engagement and its Potential for Multi-tenant Facilities Mike KILBURN, Acting General Manager, Sustainability, Airport Authority Hong Kong, Hong Kong SAR</p>	<p>Sino's Smart Initiative Eugene LEUNG, Director, Sino Investment, Hong Kong SAR</p> <p>Artificial Intelligence in Built Environment Samson TAI, CTO, IBM Hong Kong, Hong Kong SAR</p> <p>Smart Eco Home - Project Moses Andy ANN, CEO, NDN Group, Hong Kong SAR</p> <p>Policy, Design, and People: Developing a Sustainable East Asia Vincent CHENG, Director of Building Sustainability, Arup, Hong Kong SAR</p>

<p>Session 5.11 Processes, Design, Tools and Methodologies in SBE (3) Level 4 - S421</p>	<p>Session 5.12 Occupants' Evaluation of Green Buildings Level 4 - S425</p>
<p>Session Chair: Kazuo IWAMURA Japan GreenBuild Council, Japan</p>	<p>Session Chair: Henk VISSCHER Professor, Delft University of Technology-Faculty of Architecture and the Built Environment, Germany</p>
<p>Assessing Sustainable Urban Densification Using Geographic Information Systems M. Augusta HERMIDA, Professor, Universidad de Cuenca, Ecuador</p> <p>Traffic Quality Index to Intersections Considering Fuel Efficiency Marta Monteiro da Costa CRUZ, Professor, Federal University of Espírito Santo, Brazil</p> <p>A Simulation-Based Method to Assess 3D Urban Noise Environment in High-Density Cities GUO Mengdi, The University of Hong Kong, Hong Kong SAR</p> <p>Real Coded Quantum-Inspired Evolutionary Algorithm Applied to Sustainable Building Omar QUISPE POLANCO, Universidad Catolica San Pablo, Arequipa-Peru</p> <p>Sustainable Neighborhood Regeneration: Holistic Decision Support Methodology Supported by a Software Tool Paul MITTERMEIER, Munich University of Applied Science, Germany</p>	<p>Users' Perceptions of Building Performance - An Analysis of the Occupants' Comments George BAIRD, Emeritus Professor of Building Science, Victoria University of Wellington</p> <p>Cooperative Research for High Performance Buildings Herbert Claus LEINDECKER, University of Applied Sciences Upper Austria, Austria</p> <p>The Role of Perceived Social and Physical Environments on Older Adults' Social Interactions Piret VEEROJA, University of Melbourne, Australia</p> <p>Every Breath We Take – Transforming The Health of China's Office Space WU Xuchao, Associate Director of Energy & Sustainability Services, JLL, Mainland China Louie CHENG, President, PureLiving China, Mainland China</p> <p>Are Patterns of Use The Key to Resource Efficiency in Office Buildings? Ken DOOLEY, Granlund Consulting, Finland</p>

<p>Session 6.1 Regional Session - Australia, Mainland China, Singapore, South Korea and Philippines Level 1 - Convention Hall</p>	<p>Session 6.2 - Session Organiser: iiSBE SBE Urban Challenge: Assessment Protocol and Case Studies Level 1 - Theatre 1</p>
<p>Session Chair: Greg FOLIENTE Enterprise Professor, University of Melbourne; Regional Director in Asia-Pacific, iiSBE; Founding Director, nBLue Pty Ltd</p>	<p>Session Chair: Andrea MORO President, iiSBE Italia, Italy</p>
<p>SBE Sydney Deo PRASAD, Scientia Professor, CRC for Low Carbon Living</p> <p>SBE Chongqing Andrew BALDWIN, Chongqing University</p> <p>SBE Singapore Selvam VALLIAPPAN, Senior Manager, Green Building Research, Built Environment Research and Innovation Institute (BERII), Building and Construction Authority, Singapore</p> <p>SBE Seoul SHIN Sungwoo, Division of Architecture and Architectural Engineering at Hanyang University ERICA</p> <p>SBE Manila Fernando GERMAR, Chairman of Scientific Committee</p>	<p>A New SBE Challenge Process for a Transnational Generic Framework at Urban Scale Andrea MORO, President, iiSBE Italia, Italy Nils LARSSON, Executive Director, International Initiative for a Sustainable Built Environment</p> <p>Case Study - Europe: CESBA MED, CESBA Alps, NewTREND and Felicity Projects Andrea MORO, President, iiSBE Italia, Italy Stefania UGLOLA, iiSBE Italia R&D, Italy Paul MITTERMEIER, Munich University of Applied Science, Germany Ken DOOLEY, Granlund Consulting, Finland</p> <p>Case Study - South America: URBENERE Network Cristina Engel ALVAREZ, Professor/Coordinator, Laboratório de Planejamento e Projetos, Universidade Federal do Espírito Santo, Brazil Luis BRAGANÇA, University of Minho, Portugal</p> <p>Case Study - Asia: China's KPIs for Sustainable Cities</p> <p>Case Study - North America: DISTRICT 2030 Jiri SKOPEK, Managing Director, JLL, Canada; 2030 Districts</p>
<p>Session 6.5 SBE Assessments - Design Processes Level 2 - S222</p>	<p>Session 6.6 Green Construction Materials (1) Level 2 - S224 & 225</p>
<p>Session Chair: Natalie ESSIG University of Applied Sciences Munich (MUAS), Germany</p>	<p>Session Chair: Alexander PASSER Assistant Professor, Graz University of Technology, Austria</p>
<p>The Effects of Hong Kong Building Environment Assessment Method (HK-BEAM) Accreditation on Construction and Demolition Waste Minimization CHEN Xi, Department of Real Estate and Construction, The University of Hong Kong, Hong Kong SAR</p> <p>Contribution of Knowledge in Sustainable Building Design in Emerging Markets- A Case of Vietnam CHIH Ying-yi, The Australian National University, Australia</p> <p>Integrated Green Building Assessment Approach for the Next Decade May SIU, Director, Green Mark Department for New Development, Building and Construction Authority of Singapore, Singapore</p> <p>Certification of Sustainability-Case Study Analysis of New German Standard Merten WELSCH, Scientific Associate and Consultant, Federal Institute for Research on Building, Urban Affairs and Spatial Development (BBSR), Germany</p> <p>Integration of Energy and Material Performance of Buildings: I=E+M Saskia VAN HULTEN, Senior Consultant, W/E Consultants Sustainable Building, The Netherlands</p>	<p>Naturally Ventilated Earth Timber Constructions Andrea KLINGE, Senior Architect, Roswag Architekten, Germany</p> <p>The Study on Durability Testing of Heat-insulation Coating CHEN Chien-fu, National Cheng-Kung University, Taiwan</p> <p>Utilizing Palm Rachis for Eco-Friendly and Flexible Construction in Egypt Eman Atef DARWISH, Demonstrator, Department of Architecture, Ain Shams University- Cairo, Egypt</p> <p>Bamboo for The 21st Century Martin TAM Tin-fong, Founder and CEO, Able Mart Ltd., Hong Kong SAR</p> <p>"Community Empowerment through Mud-concrete Technology" - Sustainable Building Techniques to Revitalise the War Victim Communities in Batticaloa, Sri Lanka Rizna AROOZ, Research Assistant, University of Moratuwa, Sri Lanka</p>

<p>Session 6.3 Smart Initiatives in SBE (2) Level 1 - Theatre 2</p>	<p>Session 6.4 Deep Renovations - Practices & Performance Review Level 2 - S221</p>
<p>Session Chair: Antonio FRATTARI Full Professor, University of Trento, Italy</p>	<p>Session Chair: Antonin LUPISEK Head of Department, Architecture and the Environment, Czech Technical University, Czech Republic</p>
<p>Transforming Building Information Modelling to Sustainable Building Asset Management LEE Che-kit, Chief Engineer, Electrical and Mechanical Services Department, Government of the HKSAR, Hong Kong SAR CHAN Hor-yin, Senior Engineer, The Electrical and Mechanical Services Department, Government of the HKSAR, Hong Kong SAR</p> <p>Meter Online - Information Drives Behavioural Change to Save Building Energy Simon TSUI, CCE Manager - Commercial Accounts, CLP Power Hong Kong Limited, Hong Kong SAR</p> <p>Energy Efficient Optimal Controls and Smart Energy Management of Buildings and Their Energy Benefits in Real Applications WANG Shengwei, Chair Professor of Building Services Engineering, The Hong Kong Polytechnic University, Hong Kong SAR</p> <p>Interactive Building-user Systems for Positive Behavioral Change by Enhancing E-participation of Building Occupants ZHANG Qianning, Research Scholar, National University of Singapore, Singapore</p> <p>Review on Demand Control Ventilation ZHENG Caidan, Faculty of Urban Construction and Environmental Engineering, Chongqing University, Mainland China; National Centre for International Research of Low-carbon and Green Buildings, Ministry of Science & Technology</p>	<p>The Verification and Implementation of Practical Renovation for net-ZEB Office Hiroaki TAKAI, Design Department Head Office, Principal Engineer(Environment), Takenaka Corporation, Japan</p> <p>Humid Wall: Causes and Solutions Mohamad KHARSEH, Chalmers University of Technology, Sweden</p> <p>Improving the Market Up-take of Energy Producing Solar Shading: Experiences from Three Cases of Retrofit Paula FEMENIAS, Chalmers University of Technology, Sweden</p> <p>Towards a Holistic Approach to Retrofitting: A Critical Review of State-of-the-art Evaluation Methodologies for Architectural Transformation Stina Rask JENSEN, Aarhus University, Denmark</p> <p>Renovation Needs and Potential for Improved Energy Performance Depending on Ownership – A Location Based Study of Multi-Family Building Stocks in an Urban Context Magnus ÖSTERBRING, Chalmers University of Technology, Sweden</p>
<p>Session 6.7 Innovations Driving for Greener Policies and Standards - Assessment, Analysis and Modelling (2) Level 2 - S223</p>	<p>Session 6.8 Sustainable Neighbourhoods - Case Study Review (2) Level 4 - S426 & 427</p>
<p>Session Chair: Holger WALLBAUM Full Professor in Sustainable Building, Chalmers University of Technology, Sweden</p>	<p>Session Chair: Matthias Georg SULZER Professor, Swiss Federal Laboratories for Materials Science and Technology, Switzerland; Head Swiss Competence Center for Energy Research – Future Energy Efficient Buildings & Districts, Switzerland</p>
<p>Full Cost Assessment: A Method to Analyse Sustainability of Buildings Alessandra Akemi YOKOTA, The University of Melbourne, Australia</p> <p>Integrated System for Energy Optimization and Reduction of Building CO₂ Footprint Flavio CELIS D'AMICO, University of Alcalá, Spain</p> <p>Environmental Indicators for Monitoring the Swedish Building and Real Estate Management Sector Kristina EINARSSON, National Board of Housing, Building and Planning, Sweden</p> <p>Feasibility Study on Implementing Indoor Air Quality (IAQ) Index in Hong Kong MUI Kwok-wai, The Hong Kong Polytechnic University, Hong Kong SAR</p> <p>Integrating Capital Cost with Energy Efficiency – Cost@Work TANG Chee-khoay, CK@Work Sdn Bhd, Malaysia</p>	<p>Urban Regeneration Introduced with Resilient City Concept - A Case Study of Pingtung City in Taiwan CHANG Kuei-feng, Pingtung County Government, Taiwan</p> <p>The District Cooling System at The Kai Tak Development LO Siu-ken, Senior Engineer, Electrical and Mechanical Services Department, Government of the HKSAR, Hong Kong SAR</p> <p>Study on Business Scheme of a Community-wide Decentralized and Self-reliant Energy Network - Allocation of Co-benefits and Evaluation of Socio-environmental & Economic IRR Ryota KUZUKI, Acting General Manager, Energy Strategy Planning Department, Tokyo Gas Co., Ltd., Japan</p> <p>Policy Framework and Instruments for Green Transformation in East Asia Vincent CHENG, Director of Building Sustainability, Arup, Hong Kong SAR</p>

<p>Session 6.9 Transforming Green Market - Green Economics (2) Level 2 - S228</p>	<p>Session 6.10 Innovative Practices to Transform SBE (1) Level 4 - S423 & 424</p>
<p>Session Chair: Thomas TANG Sek-khuen Managing Director, Kuala Lumpur Centre for Sustainable Innovation, Malaysia</p>	
<p>Economic and Sensitivity Analysis of Net Zero Energy Refurbishment of Terraced Houses Angela GRECO, Delft University of Technology, The Netherlands</p> <p>Finding the Value in Deep Energy Retrofits James Scott BREW, Senior Sustainability Architect, Nikken Sekkei, Japan</p> <p>Productive Green Roofs Matthew PRYOR, Associate Professor (Teaching), The University of Hong Kong, Hong Kong SAR</p> <p>Sustainable Buildings – Impacts on Cash Flow and Business Case Analysis Thomas LÜTZKENDORF, Director and Head of Chair, Karlsruhe Institute of Technology, Germany</p> <p>Business for Sustainability: Market Incentives for the Better Thomas SCHLUCK, Senior Scientist, Hochschule Luzern, Switzerland</p>	<p>Comparative Analyses: Urban Quality, Living Standard, Sustainability. Modernist Housing Estates vs 21st Century City Aleksandar TEPAVCEVIC, University Assistant, Graz University of Technology, Austria</p> <p>Build Less and Make Cities Smarter by Unleashing Potential of Vacant Spaces CHAN Lai-kiu, arQstudio Ltd, Hong Kong SAR</p> <p>Green Transformation of Electrical and Mechanical Services Department Headquarters Building Dominic LAU Siu-kei, Senior Building Services Engineer, Electrical and Mechanical Services Department, Government of the HKSAR, Hong Kong SAR</p> <p>Shaping Energetic Neighbourhoods: A Dynamic Approach for a Future Proof Urban Energy Planning Jürgen KNIES, Jade University of Applied Sciences, Germany</p> <p>Building Drives for Behaviour Change - Role Model of Sustainability Tony LAM, Senior Engineer, Arup, Hong Kong SAR</p>
<p>Session 6.13 Place-making - Integrative Design Processes Level 2 - S226 & 227</p>	<p>Session 6.14 - Session Organiser: Hong Kong Green Building Council BEAM Plus Neighbourhood: From Theory to Praxis Level 4 - S428</p>
<p>Session Chair: Roland ZINKERNAGEL Lund University, Sweden</p>	<p>Session Chair: Larry POON Convener of BEAM Plus Neighbourhood Steering Committee/ Roll-out Taskforce, Hong Kong Green Building Council Ltd., Hong Kong SAR</p>
<p>Integrated Design Guidance for the Early Process Phase Günter LÖHNERT, Sol-id-ar Planungswerkstatt, Germany</p> <p>Responsive Design - The Innovative Approach to Create Sustainable Neighbourhoods and Cities Mary CHAN, Dennis Lau & Ng Chun Man Architects and Engineers (HK) Ltd., Hong Kong SAR</p> <p>Conceptualising Sustainable Neighbourhoods Through Collaborative Place-making Solomon ADEWUMI, University of Dundee, United Kingdom</p> <p>A Conceptual Model of Integral Sustainable Design Framework Wilson YIK, Associate (Sustainability), Leigh & Orange Ltd, Hong Kong SAR</p> <p>Matthew LEE, Assistant Project Designer (Sustainability), Leigh & Orange Ltd, Hong Kong SAR</p> <p>From Environmental to Social and Cultural Sustainability Peter YAM, Ronald Lu & Partners (Hong Kong) Ltd., Hong Kong SAR</p>	<p>BEAM Plus Neighbourhood: An Introduction Larry POON, Convener of BEAM Plus Neighbourhood Steering Committee/ Roll-out Taskforce, Hong Kong Green Building Council Ltd., Hong Kong SAR</p> <p>Subsidised Sale Flats Development at Fat Tseung Street West Ada FUNG, Deputy Director of Housing (Development & Construction), Hong Kong Housing Authority, Hong Kong SAR</p> <p>Transformation of EMSD Headquarters into a Green Building Antony HO, Arup, Hong Kong SAR</p> <p>West Kowloon Cultural District William CHAN, Chief Operating Officer, West Kowloon Cultural District Authority, Hong Kong SAR</p> <p>Lessons learnt from BEAM Plus Neighbourhood Pilot-testing Larry POON, Convener of BEAM Plus Neighbourhood Steering Committee/ Roll-out Taskforce, Hong Kong Green Building Council</p>

<p>Session 6.11 Processes, Design, Tools and Methodologies in SBE (4) Level 4 - S421</p>	<p>Session 6.12 Green Buildings - Occupants' Perspectives Level 4 - S425</p>
<p>Session Chair: Andrew LEUNG Emeritus Professor, City University of Hong Kong; China Green Building (HK) Council, Hong Kong SAR</p>	<p>Session Chair: Kevin EDMUNDS Senior Manager - Sustainable Development, Hong Kong Science & Technology Parks Corporation, Hong Kong SAR</p>
<p>Evidence-Based Approach to Calibration of Whole Building Energy Model Adrian CHONG, Carnegie Mellon University, United States of America; National University of Singapore, Singapore</p> <p>International LCA Data Network - Demonstration Project for an Open International Online Database Structure Hildegund FIGL, IBO Austrian Institute for Building and Ecology, Austria</p> <p>Noise Impact Assessment Study on High-performance of Sound Insolation for Residential Building at Neighboring Taiwan High Speed Rail Station LIN Wei, Associate Professor, Dep. of Interior Design, Hwa Hsia University of Technology, Taiwan</p> <p>The Failures of Initial Commissioning, and its Impacts on Overall Building Performance Madeline Kathleen PARROTT, British Columbia Institute of Technology, Canada</p> <p>Heating and Cooling Loads of a Poultry Shed in Central Coast, NSW, Australia ZHOU Yu, The University of Melbourne, Australia</p>	<p>Sculpting Socially Sustainable Neighbourhoods Franklin YU, Singular Studio Ltd., Hong Kong SAR</p> <p>Thermal Comfort Based Occupancy-driven Building Energy Saving Control Strategies ZHANG Cheng, Assistant Professor, Xi'an Jiaotong-Liverpool University, Mainland China</p> <p>The Effect of Occupant Behaviour on Real-time Electricity Consumption in Canadian School Spaces Mohamed H. ISSA, University of Manitoba, Canada</p> <p>Deep Green Approach to Create Sustainable Built Environments and Neighborhoods - Case Study of Lumpini Place Rama 4 - Ratchada Project Panita VARA-URAIAT, Director of Sustainable Development Department, Wisdom Consulting and Solution Co., Ltd., Thailand</p> <p>M+, Sustainable Design for a Contemporary Art Museum in Hong Kong Mark RICHARDSON, Senior Engineer of Building Sustainability, Arup, Hong Kong SAR</p>

<p>Session 7.1 Education and Training for Transforming SBE Level 4 - S428</p>	<p>Session 7.2 - Session Organiser: iiSBE SBE Buildings Challenge: Assessment Protocol and Case Studies Level 1 - Theatre 1</p>
<p>Session Chair: Samuel KWONG Group Sustainable Development Manager, John Swire & Sons (H.K.) Ltd., Hong Kong SAR</p>	<p>Session Chair: Nils LARSSON Executive Director, International Initiative for a Sustainable Built Environment</p>
<p>Private Public Partnership Energy Efficiency Assessment Program at Hong Kong Aircraft Engineering Company, Xiamen Facility, China Samuel KWONG, Group Sustainable Development Manager, John Swire & Sons (H.K.) Ltd., Hong Kong SAR</p> <p>Leveraging the Power of Story to Achieve Greater Sustainability James Scott BREW, Senior Sustainability Architect, Nikken Sekkei, Japan</p> <p>Embedding Sustainability in Higher Education Course Content: An Industry Perspective Lloyd Martin SCOTT, Dublin Institute of Technology, Ireland</p> <p>Importance of Built Heritage for World Sustainable Build Environment Shahid Ahmad RAJPUT, COMSATS Institute of Information Technology, Pakistan</p> <p>Developing A Conceptual Framework for Integrating Project Risk Management and Sustainability Objectives Timothy ROSE, Queensland University of Technology, Australia</p>	<p>General Intro about the Process and the Idea of Predicted vs. Actual Performance and the CanTeam Protocol Gordon SHYMKO, President, G.F. Shymko & Associates Inc., Canada</p> <p>Green and Monitoring in Holiday Inn Express SoHo Hong Kong Antonio CM CHAN, REC Engineering Co., Ltd., Hong Kong SAR</p> <p>The 2014 CanTeam Evaluation of 9 Case Studies Gordon SHYMKO, President, G.F. Shymko & Associates Inc., Canada</p> <p>Current Proposal for New Canadian Work Gordon SHYMKO, President, G.F. Shymko & Associates Inc., Canada</p> <p>UNSW BPE for 50 Dwellings Lan DING, Senior Lecturer, Faculty of Built Environment, University of New South Wales, Australia</p> <p>Panel Discussion</p>
<p>Session 7.5 SBE Assessments - Practices Review Level 2 - S222</p>	<p>Session 7.6 Green Construction Materials (2) Level 2 - S224 & 225</p>
<p>Session Chair: Antonin LUPISEK Head of Department, Architecture and the Environment, Czech Technical University, Czech Republic</p>	<p>Session Chair: Kevin EDMUNDS Senior Manager - Sustainable Development, Hong Kong Science & Technology Parks Corporation, Hong Kong SAR</p>
<p>Transnational Harmonization of Built Environment Assessment Systems: the CESBA Passport Principle Andrea MORO, President, iiSBE Italia R&D, Italy</p> <p>Generating and Providing Embodied Energy and Global Warming Potential Related Information – Recommendations for Construction Product Manufacturers Angelika HINTERBRANDNER, Graz University of Technology, Austria</p> <p>Discussing Sustainability in Building Construction: The Potential of SBtool for Brazilian Public Bidding in Fiocruz Monica Santos SALGADO, Federal University of Rio de Janeiro, Brazil</p> <p>Assessment Tools for The Sustainability Performance of Building - Development of A Sustainability Assessment Method for Small Residential Buildings in Germany Natalie ESSIG, University of Applied Sciences Munich, Germany</p>	<p>Self-Compacting Clay Concrete: A Sustainable and Innovative Process to Build with Earth Guillaume HABERT, Professor, ETH Zürich, Switzerland</p> <p>Trend of Dynamic Glass in Green Building HY CHIU, Director, Full Treasure, Hong Kong SAR</p> <p>Upgraded Mineral Sand fraction from MSWI Bottom Ash: An Alternative Solution for the Substitution of Natural Aggregates in Concrete Application Jacques Rémy MINANE, IMT Lille-Douai, LGCGE-GCE, France</p> <p>Autonomous Repair in Cementitious Material by Combination of Superabsorbent Polymers and Polypropylene Fibres - A Step towards Sustainable Infrastructure Souradeep GUPTA, National University of Singapore, Singapore</p>

<p>Session 7.3 Smart Initiatives in SBE (3) Level 1 - Theatre 2</p>	<p>Session 7.4 Deep Renovations - Processes & Methodologies Level 2 - S221</p>
<p>Session Chair: Vincent CHENG Director of Building Sustainability, Arup, Hong Kong SAR</p>	<p>Session Chair: Antonio FRATTARI Full Professor, University of Trento, Italy</p>
<p>Using Advance Thermodynamics and Online Big Data Analytics to Maximize the Chiller Plant Performance Glen ANDERSON, Vice President, ETC Group, Macau SAR</p> <p>Transforming Data into Action – Building Energy Management System to Actualize a Sustainable Built Environment Jovian CHEUNG Man-chit, Electrical & Mechanical Services Department, Government of the HKSAR, Hong Kong SAR</p> <p>Telecommunications Infrastructure for High Performance Buildings Philip TAI, Telecommunications Manager, Swire Properties Ltd., Hong Kong SAR</p> <p>Using Big Data Analytics and Continuous Monitoring to Increase the Return of Investment (ROI) in Projects for Sustainable Building Performance Rafael NAVARRO, Asia Regional Manager, ETC Group, Macau SAR</p>	<p>Towards a Holistic Methodology in Sustainable Retrofitting: Theory, Implementation and Applications Aliakbar KAMARI, Department of Engineering, Aarhus University, Denmark</p> <p>A Multidimensional Optimisation Approach to Refurbishment Design on a Multi-Building Scale Claudio NÄGELI, Chalmers University of Technology, Sweden</p> <p>Development of Regenerative Design Principles for Building Retrofits William James CRAFT, University of New South Wales, Australia</p> <p>Passive Building: Energetic Refurbishment of a Secondary School Antonio FRATTARI, University of Trento, Italy</p> <p>Factors Affecting High Performance Building Designs in Nigeria's Built Environment: "The Architects Perception" Abubakar Yahaya MUHAMMAD, Lecturer, Abubakar Tafawa Balewa University, Nigeria</p>
<p>Session 7.7 Innovations Driving for Greener Policies and Standards - Smart Initiatives Level 2 - S223</p>	<p>Session 7.8 Sustainable Neighbourhoods - Processes and Application Level 4 - S426 & 427</p>
<p>Session Chair: Shengwei WANG Chair Professor of Building Services Engineering, The Hong Kong Polytechnic University, Hong Kong SAR</p>	<p>Session Chair: Phil JONES Chair of Architectural Science, Welsh School of Architecture, Cardiff University, United Kingdom; Visiting Research Professor, Faculty of Architecture, University of Hong Kong, Hong Kong SAR</p>
<p>Smart Cities: Selection of Indicators for Vitória Cristina Engel ALVAREZ, Professor/Coordinator, Laboratório de Planejamento e Projetos, Universidade Federal do Espírito Santo, Brazil</p> <p>Establishing Smart Cities for Sustainability: An Analysis of the Japanese Innovation System and Implications for Asia Masaru YARIME, Associate Professor, City University of Hong Kong, Hong Kong SAR</p> <p>PLUSQUA: Potential of Neighbourhoods to Reduce Thermal and Electrical Loads Matthias SULZER, Professor, Swiss Federal Laboratories for Materials Science and Technology; Head Swiss Competence Center for Energy Research - Future Energy Efficient Buildings & Districts, Switzerland</p> <p>Adoption of Smart Initiatives in Developing Anderson Road Quarry Site Towards A Sustainable and Green Living Area Michael LEUNG Chung-lap, Deputy Project Manager (New Territories East) 1, Civil Engineering and Development Department, Government of the HKSAR, Hong Kong SAR</p> <p>PT Roadmap Towards Operational Energy Neutral Sewage Treatment Works Valeria ALVARADO, Civil and Environmental Engineering, The Hong Kong Polytechnic University, Hong Kong SAR</p>	<p>Current Challenges of Urban Energy Planning in A Norwegian Municipality Eirik RESCH, Norwegian University of Science and Technology, Norway</p> <p>Citylab Action: Guiding Sustainable Urban Development Jonas LIND, Licentiate Candidate, KTH Royal Institute of Technology, Sweden; Project Coordinator, Sweden Green Building Council, Sweden</p> <p>The Break-Even Point : Impact of Urban Densities on Value Creation, Infrastructure Costs and Embodied Energy Serge SALAT, President, Urban Morphology and Complex Systems Institute, France</p> <p>Barriers and Needs for Energy-efficient Refurbishment at District Level Tarja HAKKINEN, Senior Principle Scientist, VTT Technical Research Centre of Finland Ltd., Finland</p> <p>Building Regulations and Urban Policies as Incentives for Application of District Cooling Systems in Singapore SHI Zhongming, Chair of Architecture and Building Systems, ETH Zurich, Switzerland</p>

<p>Session 7.9 Transforming Green Market - Supply Chain Level 2 - S228</p>	<p>Session 7.10 Innovative Practices to Transform SBE (2) Level 4 - S423 & 424</p>
<p>Session Chair: Amie SHUTTLEWORTH Global Head of Sustainability Amie Shuttleworth, Cundall, Hong Kong SAR</p>	
<p>New Visitors? Small European Companies Entering the Chinese Sustainable Building Market Christian KOCH, Chalmers University of Technology, Sweden</p> <p>Sustainable Electrical and Mechanical Services - Vision with Action CHAN Ming-ye, Senior Engineer / Business Planning, Electrical and Mechanical Services Department, Government of the HKSAR, Hong Kong SAR</p> <p>Project Manager's Role in Sustainable Building Projects: A Case Study in Canada Ricardo Ferreira LEOTO, Architect and Sustainable Building Consultant, Faculté de l'Aménagement, Université de Montréal, Canada</p> <p>A Study on Green Industrial Project Construction Experience ZHANG Wei, Vice President - Engineering & Innovation, Bulter (Shanghai) Inc., Mainland China</p> <p>The Economic Cost-benefit Analysis of Green Building Based on the Low-carbon Economic Policy WAN Shiyu, School of Economics and Management, Beijing Jiaotong University, Mainland China</p>	<p>A Revolutionary Study Commons and University Library Extension, The Chinese University of Hong Kong FUNG Siu-man, Director of Campus Development, The Chinese University of Hong Kong, Hong Kong SAR</p> <p>Nearly Zero-Energy Care Home Design in Cold Climate in China HOU Shan-shan, Research Associate, Cardiff University, United Kingdom</p> <p>Preliminary Study on Natural Ventilation Efficiency in School Stadium by Different Opening Patterns LI Yenyi, Associate Professor, ShuTe University / TSSBE (iISBE-Taiwan), Taiwan</p> <p>Quantifying and Improving Environmental and Human Sustainability in Remote-Region Health Clinics, Australia Steve BURROUGHS, University of Canberra, Australia</p> <p>Soaring of Urbanisation - Optimised Approaches through Adaptive and Sustainable Masterplanning Antony HO, Associate, Arup, Hong Kong SAR</p>
<p>Session 7.13 Place-making - Practices Review Level 2 - S226 & 227</p>	
<p>Session Chair: Wafaa NADIM Associate Professor, The German University in Cairo, Egypt</p>	
<p>From Icon to Community: Repositioning the Image of the Modern Mega-Tower Bryant LU, Vice Chairman, Ronald Lu and Partners (Hong Kong) Ltd., Hong Kong SAR</p> <p>Do We Design Our Cities? Eugenio Maria FONTAN YANES, Director – Architect – BIM Implementation, Enzyme Apd, Hong Kong SAR</p> <p>Sustainable Residential Building Developments towards Neighbourhood Level – From a Hong Kong Private Developer Perspective Edward CHAN, Henderson Land Development Co. Ltd., Hong Kong SAR</p> <p>New Exposition of Sustainability – Linking People, Building and Community Gary CHEUNG, Consultant of Building Sustainability, Arup, Hong Kong SAR</p> <p>Sustainable Workplaces in High Density of Urban Areas Ryusuke KOJIO, Architect, Takenaka Corporation, Japan; General Manager, Design, Takenaka Europe GMBH, Germany</p>	

<p>Session 7.11 Processes, Design, Tools and Methodologies in SBE (5) Level 4 - S421</p>	<p>Session 7.12 Multi-facet Considerations of Urban Regeneration Policies Level 4 - S425</p>
<p>Session Chair: Kazuo IWAMURA Japan GreenBuild Council, Japan</p>	<p>Session Chair: Thomas NG Professor (Construction Engineering and Management), The University of Hong Kong, Hong Kong SAR</p>
<p>Measuring Sustainability in Buildings Using Construction Materials Database Based on Life Cycle Information in Turkey İlker KAHRAMAN, Yaşar University, Turkey</p> <p>When Digital Fabrication Provides Environmental Benefits: Study of Complex Structures Isolda AGUSTÍ-JUAN, Scientific Assistant, Chair of Sustainable Construction, ETH Zurich, Switzerland</p> <p>Sustainable Building Design for Enhancement of Street Ventilation and Air Quality Improvement Karl AN, The Hong Kong University of Science and Technology; AECOM Environment, Hong Kong SAR</p> <p>Applicability of Maturity Assessment for Sustainable Construction Marco SCHERZ, Scientific Assistant, Graz University of Technology - Institute of Technology and Testing of Building Materials - Working Group for Sustainability Assessment, Austria</p> <p>Development of a Rotatable Outdoor Testbed and the Testing of an Integrated Auto-dimming Lighting and Automated Blind System in the Tropics WAN Man-pun, Energy Research Institute@NTU (ERI@N) Nanyang Technological University, School of Mechanical & Aerospace Engineering Nanyang Technological University, Singapore</p>	<p>The Role of Stakeholders in Masterplan Regeneration Decisions Hannah BAKER, University of Cambridge, United Kingdom</p> <p>Effect of Residential Tower Geometries on Urban Wind Environment Ruffina THILAKARATNE, Associate Professor, Chu Hai College of Higher Education, Hong Kong SAR</p> <p>Health Co-benefits of Low Carbon Policies in the Built Environment: An Australian Investigation into Local Government Co-benefits Policies Sardar Masud KARIM, The University of New South Wales, Australia</p> <p>Bai Wan Zhuang, A Beijing Community at The Crossroads - An Analysis About the Sustainable Update of Chinese Old Distinctive Residential Areas WANG Liang, CAUPD, Mainland China</p> <p>Methodology for a Sustainable Urban Regeneration: Urban Cell as Dissemination Unit Miguel AMADO, Instituto Superior Tecnico, Portugal</p>

Poster Sessions

Poster no.:	Paper Title	Venue
1	Vertical Farm: Integrating Multifunctional Microalgae Cultivation into the Sustainable Built Environment LEE Tzan-chain, Biodiversity Research Center, Academia Sinica, Taiwan	Level 2
2	Grid Connected Photovoltaic System Potentials and Performance in 4 University Campuses Chanikarn YIMPRAYOON, Faculty of Architecture, Kasetsart University, Thailand	Level 2
3	Building High on Sustainable Use of Water: Hong Kong's Effort Stephen CATLIN Kit-wai, Water Supplies Department, Government of the HKSAR, Hong Kong SAR KWAN Kai-yin, Water Supplies Department, Government of the HKSAR, Hong Kong SAR	Level 2
4	Costs and Benefits of Implementing Green Building Policy FAN Ke, The Hong Kong Polytechnic University, Hong Kong SAR GU Wei, The Hong Kong Polytechnic University, Hong Kong SAR Queenia QIAN, Delft University of Technology, The Netherlands Edwin CHAN, The Hong Kong Polytechnic University, Hong Kong SAR	Level 2
5	A Framework towards Low-carbon Heritage Conservation of Hong Kong: with Analysis of Embodied Carbon GUO Nan, The Hong Kong Polytechnic University, Hong Kong SAR GU Wei, The Hong Kong Polytechnic University, Hong Kong SAR Edwin CHAN, The Hong Kong Polytechnic University, Hong Kong SAR Esther YUNG, The Hong Kong Polytechnic University, Hong Kong SAR	Level 2
6	A Discussion on the Benefits of Environment Performance of the Promotion of Kaohsiung Green Building Specialties Policy -the Case Study on Residential Building in Kaohsiung City KUO Yi-chun, Shu Te University, Taiwan OU Po-cheng, Shu Te University, Taiwan SHIE Chih-chang, Kaohsiung City Government, Taiwan SHIE Yu-chun, Kaohsiung City Government, Taiwan	Level 2
7	Thermal Behavior of a Low-Cost House Coated With Transparent Infrared Reflective Paint Ochuko Kelvin OVEREN, Fort Hare Institute of Technology, University of Fort Hare, South Africa	Level 2
8	Dynamic Solar Shading in Sustainable Buildings Anders HALL, SOMFY International; European Solar Shading Organization Edson Leroy MEYER, Fort Hare Institute of Technology, University of Fort Hare, South Africa Golden MAKAKA, Physics Department, University of Fort Hare, South Africa	Level 2
9	The Third Success Factor of Renovations with Energy Ambitions Anke VAN HAL, Nyenrode Business University, The Netherlands; Delft University of Technology, The Netherlands	Level 2
10	Thermal Performance as a Parameter of Choice of Materials: Brazilian Antarctic Station Bruna Perovano SIRTULLI, Universidade Federal do Espírito Santo, Brazil Filipe Galina COSTALONGA, Universidade Federal do Espírito Santo, Brazil Cristina Engel de ALVAREZ, Universidade Federal do Espírito Santo, Brazil Edna Aparecida NICO-RODRIGES, Universidade +A53Federal do Espírito Santo, Brazil	Level 2
11	Renovation of Sheung Shui Staff Quarters – Green Building Actions Echoed by the Contractor LI Siu-lung, Water Supplies Department, Government of the HKSAR, Hong Kong SAR	Level 2

12	Environmental Impact Assessment of the Central Kowloon Route Project LAM Man-san, Highways Department, Government of the HKSAR, Hong Kong SAR Franki C K CHIU, Arup, Hong Kong SAR	Level 2
13	A Comparison on Two Certification Systems: Leadership in Energy & Environmental Design (LEED) and Building Environmental Assessment Method (BEAM) on Green Building In Hong Kong Ophelia CHU Ka-wai, City University of Hong Kong, Hong Kong SAR Richard CHEUNG Yun-hing, City University of Hong Kong, Hong Kong SAR	Level 2
14	Research on Emission Evaluation Classification of Healthy Green Building Materials Label in Taiwan CHEN Cheng-chen, Department of Interior Design, Tung Fang Design Institute, Taiwan LEE Ching-chang, Department of Environmental Occupational Health, National Cheng Kung University, Taiwan CHEN Jui-ling, Architecture and Building Research Institute, Ministry of Interior, Taiwan	Level 2
15	Sustainability Assessment: An Adaptive Neural Fuzzy Interference System Approach TAN Yongtao, The Hong Kong Polytechnic University, Hong Kong SAR SHUAI Chenyang, The Hong Kong Polytechnic University, Hong Kong SAR SHUAI Chenyang, Chongqing University, Mainland China JIAO Liudan, Chongqing Jiao Tong University, Mainland China SHEN Liyin, Chongqing University, Mainland China	Level 2
16	Quantifying Greenhouse Gas Emissions: A Review of Models and Tools at the Precinct Scale Angela Maria ROJAS-AREVALO, The University of Melbourne, Australia 17Lu AYE, The University of Melbourne, Australia Seona CANDY, The University of Melbourne, Australia	Level 2
17	Climate Responsiveness and Facade Design of AQUA-Certified School Buildings Doris C.C.K. KOWALTOWSKI, University of Campinas, UNICAMP, Brazil Leticia de Oliveira NEVES, University of Campinas, UNICAMP, Brazil Vanessa Gomes DA SILVA, University of Campinas, UNICAMP, Brazil Giseli Mary COLLETO, University of Campinas, UNICAMP, Brazil	Level 2
18	Project Guidelines for Construction of Biodigesters in Poor Communities in Brasil Lizelda Maria MENDONÇA SOUTO, Polytechnic School of University of Pernambuco, Brazil Sérgio PERES, Polytechnic School of University of Pernambuco, Brazil Emilia KOHLMAN-RABBANI, Polytechnic School of University of Pernambuco, Brazil Viviany NOGUEIRA, Polytechnic School of University of Pernambuco, Brazil Ana Rita DRUMMOND, Polytechnic School of University of Pernambuco, Brazil	Level 2
19	Development of Solar Photovoltaic Pavement Panels for Application on the Green Deck MA Tao, Renewable Energy Research Group (RERF), Department of Building Services Engineering, The Hong Kong Polytechnic University, Hong Kong SAR YANG Hongxing, Renewable Energy Research Group (RERF), Department of Building Services Engineering, The Hong Kong Polytechnic University, Hong Kong SAR LU Lin, Renewable Energy Research Group (RERF), Department of Building Services Engineering, The Hong Kong Polytechnic University, Hong Kong SAR	Level 2
20	Study on the Predictive Model and Adjustment Strategies of Indoor Environment for Susceptible Populations LU Mei-chen, Department of Architecture, National Cheng Kung University, Taiwan TSAY Yaw-shyan, Department of Architecture, National Cheng Kung University, Taiwan SU Huey-jen, Department of Environmental and Occupational Health, College of Medicine, National Cheng Kung University, Taiwan HSU Nai-yun, Department of Environmental and Occupational Health, College of Medicine, National Cheng Kung University, Taiwan	Level 2
21	Improvement Strategy of Urban Street Thermal Environment WANG Wen-an, Tamkang University, Taiwan	Level 2

22	<p>Study of Climate Adaptive Design of Green Rural Houses in South Shaanxi Province CAI Wei, Northwestern Polytechnical University, Mainland China HAN Yue, Northwestern Polytechnical University, Mainland China LIU Yi, Northwestern Polytechnical University, Mainland China ZHOU Haoran, Northwestern Polytechnical University, Mainland China WANG Runsheng, Northwestern Polytechnical University, Mainland China</p>	Level 2
23	<p>Study on Consumers' Willingness to Pay for Products with a Green Building Material Label in Taiwan TSAY Yaw-shyan, National Cheng-Kung University, Taiwan CHANG Yi-hsuan, National Cheng-Kung University, Taiwan</p>	Level 4
24	<p>Improving The Relationship Between Eco-Design and Environmental Education – A Case Study of Elementary Schools in Taiwan HUANG Wei-chih, National Cheng Kung University, Taiwan TSAY Yaw-shyan, National Cheng Kung University, Taiwan HO Shin-jia, Center for General Education, National Taichung University of Science and Technology, Taiwan HO Yen-yi, Department of Interior Design, Shu-Te University, Taiwan</p>	Level 4
25	<p>Benefits of and Barriers to Green Building Implementation in Hong Kong HUO Xiaosen, The Hong Kong Polytechnic University, Hong Kong SAR Ann TW YU, The Hong Kong Polytechnic University, Hong Kong SAR</p>	Level 4
26	<p>Research on Development of a Guide for Environmental Study Classes Using Environment-conscious Technologies of School Facilities Go MIYAZAKI, Kogakuin University, Japan Yusuke NAKAJIMA, Kogakuin University, Japan</p>	Level 4
27	<p>Water Use of Thin-Layer Green Roof by Vertical-Flow Constructed Wetlands PENG Jr-jie, National Taiwan University of Science and Technology, Taiwan CL CHENG, National Taiwan University of Science and Technology, Taiwan</p>	Level 4
28	<p>“Sponge City”, A Mental Experiment with Scientific Solution for “Sustainable Neighborhood” James XIONG Jian, WSP PARSONS BRINCERHOFF, Hong Kong SAR Jason YANG, WSP PARSONS BRINCERHOFF, Hong Kong SAR Yuqi TANG, WSP PARSONS BRINCERHOFF, Hong Kong SAR Simon TANG, WSP PARSONS BRINCERHOFF, Hong Kong SAR</p>	Level 4
29	<p>A BIM Based Integrated BIPV Design System YOU Qi, China Smart Construction Group, Mainland China OUYANG Antao, China Smart Construction Group, Mainland China BAI Yang, China Smart Construction Group, Mainland China</p>	Level 4
30	<p>Design Strategies for Sustainability and Integration of Water Treatment Works – Case Study of Sha Tin Water Treatment Works, Hong Kong Aletta CHIU, Water Supplies Department, Government of the HKSAR, Hong Kong SAR Bevis W L MAK, AECOM Asia Company Ltd., Hong Kong SAR Edward W K LEE, AECOM Asia Company Ltd., Hong Kong SAR</p>	Level 4
31	<p>Low-Carbon Transport Development Strategy of Coping With Climate Change-the Case of Pingtung County CHUNG Shih-yen, Pingtung County Government, Taiwan CHANG Kuei-feng, Pingtung County Government, Taiwan CHEN Ming-chang, Pingtung County Government, Taiwan KUO Wu-wei, Pingtung County Government, Taiwan CHEN Yu-jia, Pingtung County Government, Taiwan</p>	Level 4

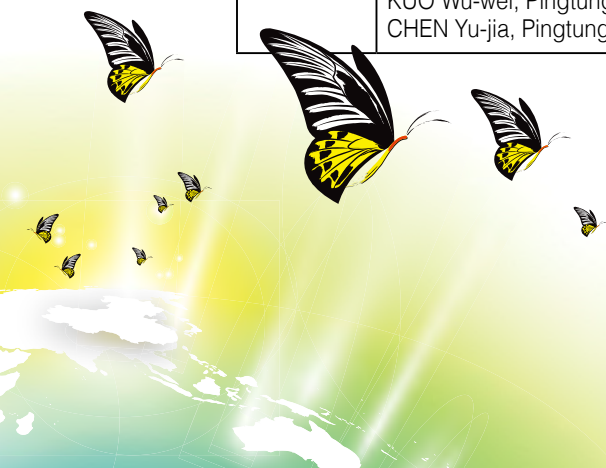

32	<p>Potential for Decreasing of Organizational Environmental Impacts: A Case Study of Czech Ministry of Labour and Social Affairs</p> <p>Antonín LUPÍŠEK, Czech Technical University in Prague, University Centre for Energy Efficient Buildings, Czech Republic Vladimír KOČÍ, University of Chemistry and Technology, Prague, Czech Republic Kateřina SOJKOVÁ, Czech Technical University in Prague, University Centre for Energy Efficient Buildings, Czech Republic Kristina ZAKUCIOVÁ, University of Chemistry and Technology, Prague, Czech Republic Jiří TENCAR, Czech Technical University in Prague, University Centre for Energy Efficient Buildings, Czech Republic Miloš LAIN, Czech Technical University in Prague, University Centre for Energy Efficient Buildings, Czech Republic Miroslav URBAN, Czech Technical University in Prague, University Centre for Energy Efficient Buildings, Czech Republic Jiří CÍGLER, Czech Technical University in Prague, University Centre for Energy Efficient Buildings, Czech Republic Vladimír HORYNA, Czech Technical University in Prague, University Centre for Energy Efficient Buildings, Czech Republic</p>	Level 4
33	<p>A Preliminary Study on the Performance of Indoor Environment with Green BIM Tools - Taking Light Environment and Thermal Environment as an Example</p> <p>CHEN Nien-tsu, Department of Interior Design, Tungfang Design Institute, Taiwan CHEN Ying-sheng, Department of Architecture, National Cheng Kung University, Taiwan TSAY Yaw-shyan, Department of Architecture, National Cheng Kung University, Taiwan LIN Chuan-hsuan, Department of Architecture, National Cheng Kung University, Taiwan</p>	Level 4
34	<p>Study on the Energy Efficiency of the Climatic Based Passive Design by Meinong Tobacco Barns in Kaohsiung</p> <p>LI Yen-yi, ShuTe University / TSSBE (iiSBE-Taiwan), Taiwan CHUNG Po-ren, Graduate School of Architecture, National ChengKung University, Taiwan LIN Hisn-I, ShuTe University / TSSBE (iiSBE-Taiwan), Taiwan TZENG Ping-chieh, Bureau of Public Works, Koahisung City Government, Taiwan CHEN Chen-Yu, Department of Architecture, ChengKung University, Taiwan</p>	Level 4
35	<p>Sustainable Midfield Concourse Development at Hong Kong International Airport</p> <p>Kevin POOLE, Airport Authority Hong Kong, Hong Kong SAR</p>	Level 4
36	<p>The Use of Recycled Aggregates for Full Depth of Sub-Base in Pavement Construction in Hong Kong</p> <p>HUI Hok-tung, Highways Department, Government of the HKSAR, Hong Kong SAR</p>	Level 4
37	<p>Decision Making Process Assisted by Life Cycle Assessment: Greenhouse Gas Emission</p> <p>Ludimilla de Oliveira ZEULE, Federal University of São Carlos, Brazil Lais David VINHAL, Federal University of São Carlos, Brazil Sheyla Mara Baptista SERRA, Federal University of São Carlos, Brazil Douglas BARRETO, Federal University of São Carlos, Brazil</p>	Level 4
38	<p>Urban Regeneration Introduced with Resilient City Concept - A Case Study of Pingtung City in Taiwan</p> <p>CHANG Kuei-feng, Pingtung County Government, Taiwan CHANG Wan-ting, Pingtung County Government, Taiwan LIUNG Hing-heng, Pingtung County Government, Taiwan WONG Wei-jin, Pingtung County Government, Taiwan</p>	Level 4
39	<p>The Status and Operation Issues Related to Covered Playgrounds of Elementary Schools</p> <p>HSIEH Hung-ren, National Ilan University, Taiwan LI Ming-da, National Ilan University, Taiwan</p>	Level 4
40	<p>Study of Public Mood Based on Sentiment Analysis in the City of Bandar Lampung, Indonesia</p> <p>Munawir, The University of Kitakyushu, Japan; Cokroaminoto Palopo University, Indonesia Fritz Akhmad NUZIR, Bandar Lampung University, Indonesia Bart Julien DEWANCKER, The University of Kitakyushu, Japan</p>	Level 4

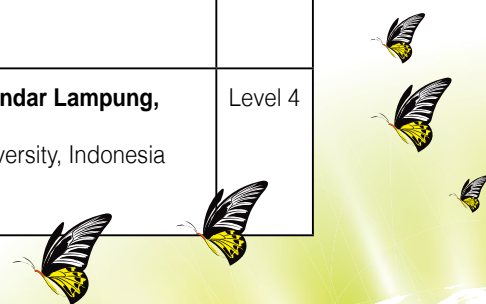

41	Estate Revitalization Scheme Ping Shek Estate: Pilot Project Completed WONG Man-lung, Hong Kong Housing Department, Government of the HKSAR, Hong Kong SAR LAM Ho-yin, Hong Kong Housing Department, Government of the HKSAR, Hong Kong SAR	Level 4
42	The Study of Pavement Reconstruction Corresponding to Microclimate Cooling Efficiency in Elementary School Campus KAO Kuo-sheng, Department of Computer and Communication, SHU-TE University, Taiwan LIN Hung-chun, Grad. School of Architecture and Interior Design, SHU-TE University, Taiwan LI Yen-yi, Grad. School of Architecture and Interior Design, SHU-TE University, Taiwan CHUNG Po-ren, Graduate School of Architecture, National Cheng Kung University, Taiwan LIN Chia-hsiung, Department of Interior Design, SHU-TE University, Taiwan	Level 4
43	Kai Tak Development - Migrating Towards Vision YING Fun-fong, Civil Engineering and Development Department, Government of the HKSAR, Hong Kong SAR Sunny LO, Civil Engineering and Development Department, Government of the HKSAR, Hong Kong SAR	Level 4
44	Sustainable Interior Environments for Historic Buildings: A Case Study of the Presidential Palace of San Anton, Malta Amber WISMAYER, University of Bath, United Kingdom Carolyn S. HAYLES, INSPIRE @ UWTSO, Mount Pleasant Campus, United Kingdom Nick MCCULLEN, University of Bath, United Kingdom	Level 4
45	Café des Visions: How to Anticipate and Consolidate Urban Negotiation through Art; a Practice-based Artistic Research Anna GRABER, Café des Visions, Switzerland	Level 4
46	The Exploration of Sustainable Neighbourhoods - A Case Study of Shenyang LI Li-hong, Shenyang Jianzhu University, Mainland China WANG Zhuo, Shenyang Jianzhu University, Mainland China	Level 4
47	Study on the Shading Performance of Expanded Metal Mesh LIN Chien-hsun, Department of Architecture, National Cheng Kung University, Taiwan TSAY Yaw-shyan, Department of Architecture, National Cheng Kung University, Taiwan YANG Jih-hong, Department of Architecture, National Cheng Kung University, Taiwan YANG Yu-fang, Shang Kai Steel Co., Ltd., Taiwan	Level 4
48	The Research of Enhancing the Performance of Impact Sound Insulation on Wooden Structure Floor LIN Fang-ming, National Pingtung University of science and technology, Taiwan FENG Chun-hao, National Cheng Kung University, Taiwan TSAI Yueh-han, National Pingtung University of science and technology, Taiwan	Level 4
49	Construction of Green Residences for Ecological Immigrants - A Case Study of Ningqiang Area in The South of Shaanxi Province HE Jiao, Northwestern Polytechnical University, Mainland China LI Jing, Northwestern Polytechnical University, Mainland China LIU Yu, Northwestern Polytechnical University, Mainland China WANG Ding, Shanghai Construction NO.4(Group)Co.,Ltd.Architectural Design & Research Institute, Mainland China	Level 4
50	Optimization of Packing Density Parameters for Reduction of Cement Content in Interlocking Concrete Block Pavers Chamod Kosala HETTIARACHCHI, University of Moratuwa, Sri Lanka Wasantha Kumara MAMPEARACHCHI, University of Moratuwa, Sri Lanka	Level 4
51	Development of a Functional Interior Material Using Scallop Shell Lime Hinako UEHARA, Kogakuin University, Japan Yusuke NAKAJIMA, Kogakuin University, Japan	Level 4
52	Research on Environmental Safety of Nanomodified Building Materials Petr ZHUK, Moscow Architectural Institute (State Academy), Russia	Level 4



VII. SBE16 REGIONAL CONFERENCES – TOP & BEST PAPERS

SBE16 DUBAI (17-19 JANUARY 2016)

[Website: <http://conference.buid.ac.ae/sbe16/>]

1. [Certification of Sustainability – Case Study Analysis of New German Standard](#)
Merten WELSCH^a
^a Federal Institute for Research on Building, Urban Affairs and Spatial Development (BBSR), Germany, merten.welsch@bbr.bund.de

Also presented at World Sustainable Built Environment Conference 2017 Hong Kong (Session 6.5).
2. [Thermal Comfort Analysis for the First Passivhaus Project in Qatar](#)
May KHALFAN^a, Steve SHARPLES^b
^a University of Liverpool, United Kingdom, m.khalfan@liverpool.ac.uk
^b University of Liverpool, United Kingdom, steve.sharples@liverpool.ac.uk
3. [Evaluation of Villas Codes in Dubai Green Building Regulation and Specification](#)
Jaheen NOHA^a, Abu-Hijleh BASSAM^b
^a Faculty of Engineering and IT, The British University in Dubai, Dubai-UAE, nohamohameed@hotmail.com
^b Faculty of Engineering and IT, The British University in Dubai, Dubai-UAE, bassam.abuhijleh@buid.ac.ae

SBE16 TORINO (18-19 FEBRUARY 2016)

[Website: <http://sbe16torino.org/>]

1. [The Break-Even Point : Impact of Urban Densities on Value Creation, Infrastructure Costs and Embodied Energy](#)
Serge SALAT^a
^a Urban Morphology and Complex Systems Institute, France: serge.salat@gmail.com

Also presented at World Sustainable Built Environment Conference 2017 Hong Kong (Session 7.8).
2. [Understanding Variation in Building Energy Analyses: Using Extant Literature to Explain Policy Outcomes](#)
JC MARTEL^a
^a University of Kansas, jcmartel@ku.edu
3. [Feasibility Analysis of an Integrated Building Energy System](#)
Maria BRUCOLI^a, Alessandro GRIECO^b, Michele Antonio TROVATO^c
^a Arup, London, maria.brucoli@arup.com
^b Politecnico di Bari Via E. Orabona, 4 70126 Bari, alexgrieco@hotmail.it
^c Politecnico di Bari Via E. Orabona, 4 70126 Bari, micheleantonio.trovato@poliba.it
4. [Sustainable Neighborhood Regeneration: Holistic Decision Support Methodology supported by a Software Tool](#)
Paul MITTERMEIER^a, Natalie EßIG^b, Ahmed KHOJA^c
^a Munich University of Applied Science, Germany, paul.mittermeier@hm.edu
^b Munich University of Applied Science, Germany, natalie.essig@hm.edu
^c Munich University of Applied Science, Germany, khoja@hm.edu

Also presented at World Sustainable Built Environment Conference 2017 Hong Kong (Session 5.11).

5. [BIM-GIS Modelling for Sustainable Urban Development](#)
Sara TORABI MOGHADAM^a, Francesca M. UGLIOTTI^b, Patrizia LOMBARDI^c, Guglielmina MUTANI^d, Anna OSELLO^e
^a Inter University Department of Regional and Urban Studies and Planning, Politecnico di Torino, Italy, sara.torabi@polito.it
^b Department of Structural, Geotechnical and Building Engineering, Politecnico di Torino, Italy, francesca.ugliotti@polito.it
^c Inter University Department of Regional and Urban Studies and Planning, Politecnico di Torino, Italy, patrizia.lombardi@polito.it
^d Department of Energy, Politecnico di Torino, Italy, guglielmina.mutani@polito.it
^e Department of Structural, Geotechnical and Building Engineering, Politecnico di Torino, Italy, anna.osello@polito.it

6. [Istanbul Metro: A Possible Example of Energy Geostructure](#)
Luca SOLDI^a, Antonio DEMATTEIS^b, Fabio FURNO^c, Marco BARLA^d
^a Geodata SpA Corso Bolzano 14 Torino (Italy), luca.soldo@geodata.it
^b Geodata SpA Corso Bolzano 14 Torino (Italy), ade@geodata.it
^c Politecnico di Torino, Dipartimento di Ingegneria, Strutturale, Edile e Geotecnica, corso Duca degli Abruzzi 24, Torino (Italy), fabio.furno@studenti.polito.it
^d Politecnico di Torino, Dipartimento di Ingegneria, Strutturale, Edile e Geotecnica, corso Duca degli Abruzzi 24, Torino (Italy), marco.barla@polito.it

7. [Local Sustainability Profiles – A New Approach to Urban Sustainability Strategies](#)
Peter ULRICH^a, Edgar GOELL^b
^a ICLEI European Secretariat Leopoldring 3 79098 Freiburg, Germany, peter.ulrich@iclei.org
^b IZT Institute for Futures Studies and Technology Assessment Schopenhauerstr. 26 14129 Berlin, Germany, e.goell@izt.de

8. [Cultivating a Village Impulse in the Midst of Warsaw, the Jazdów Settlement of Finnish Houses](#)
Dariusz ŚMIECHOWSKI^a
^a Academy of Fine Arts in Warsaw, Poland, dariusz.smiechowski@gmail.com

Also presented at World Sustainable Built Environment Conference 2017 Hong Kong (Session 1.12).

9. [Nature-based Urban Space Transformation](#)
Kristin BARBEY^a
^a Karlsruhe Institute of Technology, Germany, kristin.barbey@berlin.de

Also presented at World Sustainable Built Environment Conference 2017 Hong Kong (Session 1.12).

[Smart and Sustainable Transport through University Campus](#)

Codrin CUCIUREAN^a, Mihai FLOREA^b, Valerian CROITORESCU^c
^a Scientific Research and Continuous Training Center for Sustainable Automotive Technologies, University Politehnica of Bucharest, Faculty of Transport, Romania, codrib.cuciurean@gmail.com
^b Scientific Research and Continuous Training Center for Sustainable Automotive Technologies, University Politehnica of Bucharest, Faculty of Transport, Romania, mihai_florea@live.com
^c Scientific Research and Continuous Training Center for Sustainable Automotive Technologies, University Politehnica of Bucharest, Faculty of Transport, Romania, valerian.croitorescu@upb.ro

SBE16 HAMBURG (8-11 MARCH 2016)

[Website: <http://www.zebau.de/projekte/sbe16-hamburg>]

1. [Innovative Building Technologies Towards Sustainable Construction – A Comparative LCA and LCC Assessment](#)
Alexander PASSER^a, Gernot FISCHER^b, Richard DEUTSCH^c, Petra SÖLKNER^d, Sebastian SPAUN^e
^a Graz University of Technology, Austria, alexander.passer@tugraz.at
^b Graz University of Technology, Austria, gernot.fischer@tugraz.at
^c Graz University of Technology, Austria, richard.deutsch@tugraz.at
^d Austrian Cooperative Researchm, Austria, petra.soelkner@gmx.at
^e Austrian Cooperative Researchm, Austria, spaun@voezfi.at

Also presented at World Sustainable Built Environment Conference 2017 Hong Kong (Session 5.6).

2. [Sustainability and Risk](#)
Sarah Ok Kyu STRUNK^a, Christian STOY^b
^a *Institute for Construction Economics, University of Stuttgart, Stuttgart, Germany, sarah.strunk@bauoekonomie.uni-stuttgart.de*
^b *Institute for Construction Economics, University of Stuttgart, Stuttgart, Germany, christian.stoy@bauoekonomie.uni-stuttgart.de*
3. [Planning of Ecologically and Economic Optimized District Refurbishments](#)
Rafael HORN^a, Michael JÄGER^b, Roberta GRAF^c
^a *Fraunhofer Institute for Building Physics, rafael.horn@ibp.fraunhofer.de*
^b *Fraunhofer Institute for Building Physics, michael.jaeger@ibp.fraunhofer.de*
^c *Fraunhofer Institute for Building Physics, roberta.graf@ibp.fraunhofer.de*
4. [Life Cycle Approach as a Method for Optimizing Building Services Systems in Extremely Low Energy Buildings](#)
Jens TØNNESEN^a, Torhildur KRISTJANSDOTTIR^b
^a *Norwegian University of Science and Technology, Norway, jens.tonnesen@ntnu.no*
^b *Norwegian University of Science and Technology, Norway, torhildur.kristjansdottir@ntnu.no*
5. [Sustainability Profile of Urban Planning in Algiers](#)
Mohamed SRIR^a, Ewa BEREZOWSKA-AZZAG^b
^a *EPAU, Algeria, mohamed.srir@gmail.com*
^b *EPAU, Algeria, ewaazzag@yahoo.fr*
6. [Building Life Cycle Assessment: Investigation of Influential Factors in a Helpful Decision Tool](#)
Marie-Lise PANNIER^a, Patrick SCHALBART^b, Bruno PEUPOORTIER^c
^a *Mines ParisTech PSL Research University, France, marie-lise.pannier@mines-paristech.fr*
^b *Mines ParisTech PSL Research University, France, patrick.schalbart@mines-paristech.fr*
^c *Mines ParisTech PSL Research University, France, bruno.peuportier@mines-paristech.fr*

Also presented at World Sustainable Built Environment Conference 2017 Hong Kong (Track 9 - Poster Session).

SBE16 VALLETTA (16-18 MARCH 2016)

[Website: <http://www.sbe16malta.org/>]

SBE16 UTRECHT (6-8 APRIL 2016)

[Website: <https://www.onderzoek.hu.nl/Evenementen/Zero-Transition-SBE16-Conference>]

SBE16 ZURICH (13-17 JUNE 2016)

[Website: <http://www.sbe16.ethz.ch/>]

1. [Geo-dependent Heat Demand Model of the Swiss Building Stock](#)
Stefan SCHNEIDER^a, Jad KHOURY^b, Bernard LACHAL^c, Pierre HOLLMULLER^d
^a *University of Geneva, Switzerland, stefan.schneider@unige.ch*
^b *University of Geneva, Switzerland, jad.khoury@unige.ch*
^c *University of Geneva, Switzerland, bernard.lachal@unige.ch*
^d *University of Geneva, Switzerland, pierre.hollmuller@unige.ch*

Also presented at World Sustainable Built Environment Conference 2017 Hong Kong (Session 5.7).

2. [Naturally Ventilated Earth Timber Constructions](#)
Andrea KLINGE^a, Eike ROSWAG-KLINGE^b, Christof ZIEGERT^c, Patrick FONTANA^d, Matthias RICHTER^e, Johannes HOPPE^f
^a *Roswag Architekten, Germany, klinge@zrs-berlin.de*
^b *Roswag Architekten, Germany, roswag@zrs-berlin.de*
^c *Ziegert Seiler Ingenieure, Berlin, Germany, ziegert@zrs-berlin.de*
^d *Bundesanstalt für Materialforschung und -prüfung (BAM), Berlin, Germany, patrick.fontana@bam.de*
^e *Bundesanstalt für Materialforschung und -prüfung (BAM), Berlin, Germany, matthias.richter@bam.de*
^f *Ziegert Seiler Ingenieure, Berlin, Germany, johannes.hoppe@bam.de*

Also presented at World Sustainable Built Environment Conference 2017 Hong Kong (Session 6.6).

3. The Cost and Environmental Impact Of Service Life Extending Self-Healing Engineered Materials For Sustainable Steel Reinforced Concrete
P. VAN DEN HEEDE^a, B. VAN BELLEGHEM^b, N. DE BELIE^c

SBE16 PRAGUE (22-24 JUNE 2016)

[Website: <http://cesb.cz/>]

1. [Embodied Energy and Global Warming Potential in Construction – Perspectives and Interpretations](#)
Maria BALOUKTSI^a, Thomas LÜTZKENDORF^b, Seongwon SEO^c, Greg FOLIEN^d
^a Karlsruhe Institute of Technology, Germany, maria.balouktsi@kit.edu
^b Karlsruhe Institute of Technology, Germany, thomas.luetzkendorf@kit.edu
^c CSIRO Land and Water, Australia, seongwon.seo@csiro.au
^d CSIRO Land and Water, Australia, greg.foliente@csiro.au

Also presented at World Sustainable Built Environment Conference 2017 Hong Kong (Session 4.5).

2. [Life Cycle Greenhouse Gas Emissions of Material Use In The Living Laboratory](#)
Marianne Rose KJENDSETH WIİK^a, Aoife Anne-Marie HOULIHAN WIBERG^b
^a SINTEF, Norway, marianne.wiik@sintef.no
^b Norwegian University of Science and Technology, Norway, aoife.houlihan.wiberg@ntnu.no

Also presented at World Sustainable Built Environment Conference 2017 Hong Kong (Session 5.10).

3. [Hygrothermal Behaviour of Wood-based Structures: Full Scale Experiment](#)
Veronika BURESOVA^a, Michal BURES^b
^a CTU in Prague, Faculty of Civil Engineering, Czech republic, veronika.buresova@fsv.cvut.cz
^b CTU in Prague, Faculty of Civil Engineering, Czech republic; University Centre for Energy Efficient Buildings of Technical University in Prague, Czech Republic, michal.bures@fsv.cvut.cz
4. [Global Impulse Sensitivity Analysis for Building Energy Simulation of Residential Quarters](#)
Manuel LINDAUER^a
^a Technical University of Munich, Germany, manuel.lindauer@tum.de

SBE16 MANILA (13-15 JULY 2016)

[Website: <http://sbe16.upd.edu.ph/www.conference.upd.edu.ph/index.php/SBE>]

1. Estimating Typhoon Haiyan's Wind Speeds Using Windicators and Post-Storm Wind Vulnerability Analysis on the Affected Areas
Joshua AGAR^a, Jaime Jr. HERNANDEZ^b, William MATA^c
^a University of the Philippines Diliman, Philippines, jcagar@up.edu.ph
^b University of the Philippines Diliman, Philippines, jyhernandez@up.edu.ph
^c University of the Philippines Diliman, Philippines, william.mata@yahoo.com

Also presented at World Sustainable Built Environment Conference 2017 Hong Kong (Session 1.8).

2. Takbuhan: Evacuation Center Design for Earthquake and Typhoon-Proof Communities in the Philippines
Mary Ann Arañas ESPINA^a, Dolores Cecilia T. MADRID^b, Christopher Stonewall P. ESPINA^c, Carmen Bettina S. BULAONG^d, Marie Edraline B. BELGA^e, Jose Ricardo F. RUSTIA^f, Jose Gabriel M. YAP^g, Wenona Maffe Kaye Z. DAGCUTA^h, Patricia Anne L. GRAFILⁱ, Koreen C. HIDALGO^j
^a University of the Philippines, Philippines, upca.extension@gmail.com
^b University of the Philippines, Philippines, upca.extension@gmail.com
^c University of the Philippines, Philippines, upca.extension@gmail.com
^d University of the Philippines, Philippines, upca.extension@gmail.com
^e University of the Philippines, Philippines, upca.extension@gmail.com
^f University of the Philippines, Philippines, updst.bbb@gmail.com
^g University of the Philippines, Philippines, updst.bbb@gmail.com
^h University of the Philippines, Philippines, updst.bbb@gmail.com
ⁱ University of the Philippines, Philippines, updst.bbb@gmail.com
^j University of the Philippines, Philippines, updst.bbb@gmail.com
3. Kapit-Bahay: Designing a Resilient Self-Build House for the Typhoon Yolanda-Stricken Communities
Mary Ann A. ESPINA^a, Dolores Cecilia T. MADRID^b, Christopher Stonewall P. ESPINA^c, Carmen Bettina S. BULAONG^d, Marie Edraline B. BELGA^e, Jose Ricardo F. RUSTIA^f, Jose Gabriel M. YAP^g, Wenona Maffe Kaye Z. DAGCUTA^h, Patricia Anne L. GRAFILⁱ
^a University of the Philippines, Philippines, upca.extension@gmail.com
^b University of the Philippines, Philippines, upca.extension@gmail.com
^c University of the Philippines, Philippines, upca.extension@gmail.com
^d University of the Philippines, Philippines, upca.extension@gmail.com
^e University of the Philippines, Philippines, upca.extension@gmail.com
^f University of the Philippines, Philippines, updst.bbb@gmail.com
^g University of the Philippines, Philippines, updst.bbb@gmail.com
^h University of the Philippines, Philippines, updst.bbb@gmail.com
ⁱ University of the Philippines, Philippines, updst.bbb@gmail.com
4. Expectations vs. Reality: Disparities in Energy Efficiency and Conservation Practices and Perceptions among Tourist Accommodation Providers in Coron, Palawan
Geomilie TUMAMAOG-GUITTAP^a, Sheilah NAPALANG^b
5. Application of Disaster Risk Reduction Management Principles in Humanitarian Logistics: A Case of Bohol Province, Philippines
Michelle Garcia NASAM^a
^a School of Urban and Regional Planning, Philippines, michelle.navagarcia@gmail.com
6. Impacts of Climate Change in Farming Practices: Its effects on Selected Barangays in San Mateo, Isabela
Annlouise Genevieve CASTRO^a, Mario DELOS REYES^b
^a University of the Philippines, Philippines, bidayc@gmail.com
^b University of the Philippines, Philippines, mrdelosreyes@up.edu.ph
7. Earthquake Debris Management in Bohol
Jireh Joy LUMANOG^a, Aerholl Son RAMOS^b, Ma. Brida Lea DIOLA^c, Maria Antonia TANCHULING^d
^a University of the Philippines Diliman, Philippines, jirehhumanog@gmail.com
^b University of the Philippines Diliman, Philippines, aerholl@yahoo.com
^c University of the Philippines Diliman, Philippines, mddiola@up.edu.ph
^d University of the Philippines Diliman, Philippines, mntanchuling@up.edu.ph
8. Sustainable Wastewater Management for the University of the Philippines Campus in Sta. Elena, Tacloban City
Christian R. OROZCO^a, Ma. Brida Lea D. DIOLA^b, Maria Antonia N. TANCHULING^c

SBE16 SINGAPORE (5-6 SEPTEMBER 2016)

[Website: <http://www.sbe-series.org/sbe-16/singapore/overview/>]

1. Use of Incineration Bottom Ash for Road Construction in Singapore
HO Nyok-yong^a, Kelvin LEE Yang-pin^b, YAP Cheng-chwee^c, TONG Kum-kong^d
^a Samwoh Innovation Centre, Singapore, nyok.yong.ho@samwoh.com.sg
^b Samwoh Innovation Centre, Singapore, kelvin.lee@samwoh.com.sg
^c Land Transport Authority, Singapore, yap_cheng_chwee@lta.gov.sg
^d Land Transport Authority, Singapore, tong_kum_kong@lta.gov.sg

Also presented at World Sustainable Built Environment Conference 2017 Hong Kong (Session 4.6).

2. Redefining Indoor Air Quality - Improving the Green Mark Standards based on recent Tropical IAQ Research
Karl WAGNER^a
^a University of Kuala Lumpur, Malaysia
3. Occupant Behaviour and Direct Rebound Effect in Commercial Building Energy Retrofits
ONG Shu-qing^a
^a Department of Building, National University of Singapore, Singapore
4. Incorporating Effects of Oblique Waves in the Design of Coastal Protection Structures Under Sea Level Rise
Lydia LIM Sin-hwei^a
^a NUSDeltares Alliance, National University of Singapore, Singapore
5. The Enclosed Household: Air-conditioning and the Perception of the Household Built Environment
QUEK Ri-an^a
^a Lee Kuan Yew Center for Innovative Cities, Singapore University of Technology and Design, Singapore
6. Interactive Building-user Systems for Positive Behavioral Change by Enhancing E-participation of Building Occupants
ZHANG Qianning^a, Stephen LAU Siu-yu^b
^a National University of Singapore, Singapore, zqn2814@gmail.com
^b National University of Singapore, Singapore, akilssy@nus.edu.sg

Also presented at World Sustainable Built Environment Conference 2017 Hong Kong (Session 6.3).

7. Comparing Microorganisms in Settled Dust from Childcare Centers with Different Ventilation Modes
Caroline CHENARD^a, Stephan SCHUSTER^b, Federico LAURO^c
^a Singapore Centre for Environmental Life Science Engineering, Nanyang Technological University, Singapore
^b Singapore Centre for Environmental Life Science Engineering, Nanyang Technological University, Singapore
^c Singapore Centre for Environmental Life Science Engineering, Nanyang Technological University, Singapore
8. Use of Sedimentary Rocks for Construction Applications
HO Nyok-yong^a, Kelvin LEE Yang-pin^b, LIM Wee-fong^c, Zhang Weide^d, Cherlyn LEONG Pei-ying^e
^a Samwoh Corporation Pte Ltd, Singapore
^b Samwoh Corporation Pte Ltd, Singapore
^c Samwoh Corporation Pte Ltd, Singapore
^d JTC Corporation, Singapore
^e JTC Corporation, Singapore

SBE16 BRAZIL & PORTUGAL (7-9 SEPTEMBER 2016)

[Website: http://civil.uminho.pt/sbe16_Brazil_Portugal/]

1. [LEED Certification and The New Standard of Sustainable Construction in Colombia](#)
Andrés PELÁEZ^a, Alexander GONZALEZ^b, Laura MARIN^c
^a *Universidad Pontificia Bolivariana, Colombia, andres.po.6@hotmail.com*
^b *Universidad Pontificia Bolivariana, Colombia, alexandergonzalez@upb.edu.co*
^c *PVG Arquitectos, lauramarin@pvgarquitectos.com*

Also presented at World Sustainable Built Environment Conference 2017 Hong Kong (Session 1.5).
2. [Smart Cities: Selection of Indicators for Vitória](#)
Carolina SIMÕES ROCON^a, Cristina ENGEL DE ALVAREZ^b
^a *Laboratório de Planejamento e Projetos, Universidade Federal do Espírito Santo, Brazil, carolinarocon@gmail.com*
^b *Laboratório de Planejamento e Projetos, Universidade Federal do Espírito Santo, Brazil, engelaalvarez@hotmail.com*

Also presented at World Sustainable Built Environment Conference 2017 Hong Kong (Session 7.7).
3. [Historic Relationship Between Urban Dwellers and The Tomebamba River](#)
Pablo OSORIO^a, Mateo NEIRA^b, M. Augusta HERMIDA^c
^a *Universidad de Cuenca, Ecuador, pablo.osorio@ucuenca.edu.ec*
^b *Universidad de Cuenca, Ecuador, mateo0719@gmail.com*
^c *Universidad de Cuenca, Ecuador, augusta.hermida@ucuenca.edu.ec*

Also presented at World Sustainable Built Environment Conference 2017 Hong Kong (Session 1.12)
4. [Traffic Quality Index to Intersections Considering Fuel Efficiency](#)
Fabianne Miranda AGUIAR^a, Marta Monteiro da Costa CRUZ^b, Gregório Coelho de Moraes NETO^c, Adelmo Inacio BERTOLDE^d
^a *Federal University of Espírito Santo, Brazil, fabianneaguiar@gmail.com*
^b *Federal University of Espírito Santo, Brazil, marta.cruz@ufes.br*
^c *Federal University of Espírito Santo, Brazil, gregorioufes@msn.com*
^d *Federal University of Espírito Santo, Brazil, adelmo.ufes@gmail.com*

Also presented at World Sustainable Built Environment Conference 2017 Hong Kong (Session 5.11).
5. [Comparative Assessment of Selected Sustainability Strategies Applied to Urban Neighbourhoods in Brazil, Germany and Sweden](#)
Karin Regina de Castro MARINS^a
^a *University of Sao Paulo, Brazil, karin.marins@usp.br*
6. [Passive Design Strategies For Building Envelopes In Different Orientations](#)
Leidy Johana RAMIREZ^a, Elizabeth PARRA^b
^a *PVG Arquitectos, Colombia, leidyramirez@pvgarquitectos.com*
^b *PVG Arquitectos, Colombia, elizabethparra@pvgarquitectos.com*

Also presented at World Sustainable Built Environment Conference 2017 Hong Kong (Session 3.8).
7. [Urban metabolism and food flows: The municipality of Feliz, State of Rio Grande do Sul, Brazil](#)
Eugenia Aumond KUHN^a, Miguel Aloysio SATTLER^b, Lucas Dorneles MAGNUS^c
^a *Centro Universitário Ritter dos Reis – UniRitter, Brazil, eugeniaaakuhn@gmail.com*
^b *Universidade Federal do Rio Grande do Sul, Brazil, masattler@gmail.com*
^c *Universidade Federal do Rio Grande do Sul, Brazil, ldm.oasis@ymail.com*
8. [Integrated System for Energy Optimization and Reduction of Building CO₂ Footprint](#)
Ernesto Enrique ECHEVERRIA VALIENTE^a, Flavio CELIS D'AMICO^b, Fernando DA CASA MARTIN^c, Manuel DE MIGUEL SANCHEZ^d, Patricia DOMINGUEZ GOMEZ^e, Ignacio DELAGADO CONDE^f, Alvaro MOZAS SANTANDER^g, Kevin MORENO GATA^h, Juan Manuel VEGA BALLESTEROSⁱ, Francisco MARTIN SAN CRISTOBAL^j
^a *University of Alcala, Spain, ernesto.echeverria@uah.es*

- ^b University of Alcalá, Spain, flavio.celis@uah.es
^c University of Alcalá, Spain, fernando.casa@uah.es
^d University of Alcalá, Spain, mozasalvaro@gmail.com
^e University of Alcalá, Spain, interpatridg@gmail.com
^f University of Alcalá, Spain, igdeco@gmail.com
^g University of Alcalá, Spain, mozasalvaro@gmail.com
^h University of Alcalá, Spain, kevin.morenogata@gmail.com
ⁱ University of Alcalá, Spain, juanmanuel.vega@uah.es
^j University of Alcalá, Spain, francisco.martin@larentia.es

Also presented at World Sustainable Built Environment Conference 2017 Hong Kong (Session 6.7).

9. [Assessing Sustainable Urban Densification Using Geographic Information Systems](#)

Natasha CABRERA-JARA^a, Daniel ORELLANA^b, M. Augusta HERMIDA^c

^a Universidad de Cuenca, Ecuador, natashat.cabrera@ucuenca.edu.ec

^b Universidad de Cuenca, Ecuador, daniel.orellana@ucuenca.edu.ec

^c Universidad de Cuenca, Ecuador, augusta.hermida@ucuenca.edu.ec

Also presented at World Sustainable Built Environment Conference 2017 Hong Kong (Session 5.11).

10. [Project Guidelines for Construction of Biodigesters in Poor Communities in Brasil](#)

Lizelda Maria MENDONÇA SOUTO^a, Sérgio PERES^b, Emilia KOHLMAN-RABBANI^c, Viviany NOGUEIRA^d, Ana Rita DRUMMOND^e

^a Polytechnic School of University of Pernambuco, Brazil, lizambr2004@yahoo.com.br

^b Polytechnic School of University of Pernambuco, Brazil, sergperes@gmail.com

^c Polytechnic School of University of Pernambuco, Brazil, emilia.rabbani@upe.br

^d Polytechnic School of University of Pernambuco, Brazil, vivianyogueira@gmail.com

^e Polytechnic School of University of Pernambuco, Brazil, anaritadrummond@gmail.com

Also presented at World Sustainable Built Environment Conference 2017 Hong Kong (Track 4 - Poster Session).

11. [Decision Making Process Assisted by Life Cycle Assessment: Greenhouse Gas Emission](#)

Ludimilla de Oliveira ZEULE^a, Sheyla Mara Baptista SERRA^b, Laís David VINHAL^c, Douglas BARRETO^d

^a Federal University of São Carlos, Brazil, milla_zeule@hotmail.com

^b Federal University of São Carlos, Brazil, sheylabs@ufscar.br

^c Federal University of São Carlos, Brazil, laiscruzeiro@yahoo.com.br

^d Federal University of São Carlos, Brazil, dbarreto@ufscar.br

Also presented at World Sustainable Built Environment Conference 2017 Hong Kong (Track 8 - Poster Session).

SBE16 TORONTO (19-20 SEPTMBER 2016)

[Website: www.SBE16Toronto.com]

1. [Demystifying and Democratizing the Energy Use Conversation to Support the Net-Zero Challenge](#)

Birgit SIBER^a, Mike WILLIAMS^b

^a Diamond Schmitt Architects, Canada, bsiber@dsai.ca

^b Rowan Williams Davies & Irwin Inc., mike.williams@rwdi.com

Also presented at World Sustainable Built Environment Conference 2017 Hong Kong (Session 2.4).

2. [Biophilia and Nature-based Features to Support Stress Reduction in Knowledge Workers](#)

Ann CALLAGHAN^a, Shauna MALLORY-HILL^b

^a Conestoga College, Canada; Algonquin College, Canada, ann.callaghan@gmail.com

^b University of Manitoba, Canada, s.mallory-hill@umanitoba.ca

Also presented at World Sustainable Built Environment Conference 2017 Hong Kong (Session 4.8).

3. [The Benefits of Green Roof Retrofits as Local Interventions for Mitigating the Urban Heat Island Effect in Toronto](#)

Umberto BERARDI^a

^a Ryerson University Toronto Ontario, Canada

4. [Building in Existing Contexts – Densification](#)

Paul FLOERKE^a, Sonja WEISS^b

^a Department of Architectural Science, Ryerson University, Canada, paul.floerke@ryerson.ca

^b Department of Architectural Science, Ryerson University, Canada, sonja.weiss@tu-dortmund.de

Also presented at World Sustainable Built Environment Conference 2017 Hong Kong (Session 1.11).

5. [The Effect of Occupant Behaviour on Real-time Electricity Consumption in Canadian School Spaces](#)

Mohamed M. OUF^a, Mohamed H. ISSA^b

^a University of Manitoba, Canada, oufm@myumanitoba.ca

^b University of Manitoba, Canada, mohamed.issa@umanitoba.ca

Also presented at World Sustainable Built Environment Conference 2017 Hong Kong (Session 6.12).

6. [Improving the Resilience of Buildings: An Integrated Approach to Measuring Optimum Density](#)

C.LUO^a, H.L. MACLEAN^b, A. HAY^c

^a University of Toronto, Department of Civil Engineering, chibulu.luo@mail.utoronto.ca

^b University of Toronto, Department of Civil Engineering

^c Centre for Resilience of Critical Infrastructure (CRCI), University of Toronto

7. [Post-Occupancy Evaluation of a High-Density Affordable Housing Complex of a High-Density Affordable Housing Complex with Innovative Mechanical Heating and Ventilation Systems](#)

F. SUERICH-GULICK^a, M. TARDIF^b, S. CELIS MERCIER^c, H. F. NOUANEGUE^d, Woytek KUJAWSKI^e, D. PEARL^f

^a CanmetENERGY– Natural Resources Canada, Coteau Vert Housing Coop

^b CanmetENERGY – Natural Resources Canada

^c Archiscience

^d Institut de recherche, Hydro-Québec

^e Integrative Solutions Group

^f l'OEUF Architectes

8. [The Third Success Factor of Renovations with Energy Ambitions](#)

Anke VAN HAL^a

^a Nyenrode Business University, Delft University of Technology, The Netherlands, a.vanhal@nyenrode.nl

Also presented at World Sustainable Built Environment Conference 2017 Hong Kong (Track 2 - Poster Session).

SBE16 DUBLIN (29-30 SEPTEMBER 2016)

SBE16 HELSINKI AND TALLINN (5-7 OCTOBER 2016)

[Website: <http://www.sbe2016.org/>]

1. [Impact of Urban Density and Building Height on Energy Use in Cities](#)
Eirik RESCH^a, Rolf André BOHNE^b, Trond KVAMSDAL^c, Jardar LOHNE^d
^a Department of Civil and Transport Engineering, Norwegian University of Science and Technology, Norway
^b Department of Civil and Transport Engineering, Norwegian University of Science and Technology, Norway
^c Department of Civil and Transport Engineering, Norwegian University of Science and Technology, Norway
2. [Integration of Energy and Material Performance of Buildings: I=E+M](#)
Erik ALSEMA^a, David ANINK^b, Arjen MEIJER^c, Ad STRAUB^d, Geurt DONZE^e
^a W/E Consultants Sustainable Building, Utrecht, The Netherlands, alsema@w-e.nl
^b W/E Consultants Sustainable Building, Utrecht, The Netherlands, anink@w-e.nl
^c OTB Research Institute, Delft University of Technology, Delft, The Netherlands, a.meijer@tudelft.nl
^d OTB Research Institute, Delft University of Technology, Delft, The Netherlands, a.straub@tudelft.nl
^e W/E Consultants Sustainable Building, Utrecht, The Netherlands, donze@w-e.nl

Also presented at World Sustainable Built Environment Conference 2017 Hong Kong (Session 6.5).

3. [Energy Savings for a Wood Based Modular Pre-fabricated Façade Refurbishment System Compared to other Measures](#)
Svein Halvor RUUD^a, Leif ÖSTMAN^b, Philip ORÄDD^c
^a SP Technical Research Institute of Sweden, Sweden, svein.ruud@sp.se
^b NOVIA University of Applied Science, Finland, leif.ostman@novia.fi
^c Umeå University, Sweden, phille_o92@hotmail.com
4. [Geothermal Heat Pump Plant Performance in a Nearly Zero-Energy Building](#)
Jevgeni FADEJEVA^a, Raimo SIMSON^b, Jarek KURNITSKIA^c, Jyrki KESTI^d, Tarmo MONONEN^e, Petteri LAUTSO^f
^a Aalto University, School of Engineering; Tallinn University of Technology
^b Tallinn University of Technology
^c Aalto University, School of Engineering; Tallinn University of Technology
^d Ruukki Construction Oy
^e Ruukki Construction Oy
^f Ruukki Construction Oy
5. [Partnering Elements' Importance for Success in the Norwegian Construction Industry](#)
Jenny WØIEN^a, Ali HOSSEINI^b, Ole Jonny KLAKEGG^c, Ola LÆDRE^d, Jardar LOHNE^e
^a Department of Civil and Transport Engineering, Norwegian University of Science and Technology
^b Department of Civil and Transport Engineering, Norwegian University of Science and Technology
^c Department of Civil and Transport Engineering, Norwegian University of Science and Technology
^d Department of Civil and Transport Engineering, Norwegian University of Science and Technology
^e Department of Civil and Transport Engineering, Norwegian University of Science and Technology

SBE16 ISTANBUL (13-15 OCTOBER 2016)

[Website: <http://www.sbeistanbul.com/>]

1. [Analysis of Fourth-Generation District Energy Systems with Renewable Energy Cogeneration by Using Rational Exergy Management Model](#)
Biol KILKIS^a
^a Baskent University, Turkey, biolkilkis@hotmail.com

Also presented at World Sustainable Built Environment Conference 2017 Hong Kong (Session 3.3).

2. [A Sustainability Approach in Construction: Sustainability Management, Innovative and Eco-Friendly Products](#)

Yasin ENGIN^a, İsmail GÖKALP^b, Sezgi KUMBARACIBAŞI^c, Emre AKINCI^d

^a Akçansa Cement, Turkey, yasin.engin@akcansa.com.tr

^b Akçansa Cement, Turkey, ismail.gokalp@akcansa.com.tr

^c Akçansa Cement, Turkey, sezgi.kumbaracibasi@akcansa.com.tr

^d Akçansa Cement, Turkey, emre.akinci@akcansa.com.tr

3. [Renewable Energy Technologies - Economic Analysis Tool \(RET-EAT\) for Turkey](#)

Oğuz Kürşat KABAKÇI^a, Burak HOZATLI^b, Korkmaz GÜL^c, Nilay ÖZELER KANAN^d, Aslı KARABACAK^e, Uygur KINAY^f

^a Ministry of Energy and Natural Resources, Turkey, okabakci@yegm.gov.tr

^b Ministry of Environment and Urbanization, Turkey, burak.hozatli@csb.gov.tr

^c Ministry of Energy and Natural Resources, Turkey, kgul@yegm.gov.tr

^d **Yüzüncüyıl University, Turkey**, nilayozelerkanan@yyu.edu.tr

^e UNDP Turkey, asli.karabacak@undp.org

^f Ministry of Environment and Urbanization, Turkey, asli.karabacak@undp.org

Also presented at World Sustainable Built Environment Conference 2017 Hong Kong (Session 5.7).

4. [Public Projects on Energy Efficiency in Buildings – Sample on Promoting Energy Efficiency in Buildings “Integrated Building Design Approach”](#)

Nilay ÖZELER KANAN^a, Esra TOMBAK^b, Korkmaz GÜL^c, Oğuz Kürşat KABAKÇI^d, Aslı KARABACAK^e

^a **Yuzuncu Yil University, Faculty of Architecture and Design, Department of Architecture, Van, Turkey**, nilayozelerkanan@yyu.edu.tr

^b Ministry of Environment and Urbanization, General Directorate of Occupational Services, Department of Energy Efficiency and Installation, Ankara, Turkey, esra.tombak@csb.gov.tr

^c Ministry of Environment and Urbanization, General Directorate of Occupational Services, Department of Energy Efficiency and Installation, Ankara, Turkey, kgul@yegm.gov.tr

^d Ministry of Energy and Natural Resources, General Directorate of Renewable Energy, Ankara, Turkey, okabakci@yegm.gov.tr

^e UNDP Turkey CO, Ankara, Turkey, asli.karabacak@undp.org

5. [Measuring Sustainability in Buildings Using Construction Materials Database Based on Life Cycle Information in Turkey](#)

İlker KAHRAMAN^a, Hudai KARA^b

^a **Yaşar University, Turkey**, ilker.kahraman@yasar.edu.tr

^b **Metsims, Turkey**, hudai.kara@metsims.com

Also presented at World Sustainable Built Environment Conference 2017 Hong Kong (Session 7.11).

SBE16 THESSALONIKI (17-19 OCTOBER 2016)

[Website: <http://sbe16-thessaloniki.gr/>]

SBE16 CHONGQING (5-6 NOVEMBER 2016)

[Website: <http://sbe16chongqing.com/>]

1. [Environmental and Human-Oriented Building Design Research](#)

Stephen S Y LAU^a, Wajishani GAMAGE^b

2. [Exergoeconomic Assessment of a Building Integrated Photovoltaic \(BIPV\) System: A Case Study of Yasar University, Izmir, Turkey](#)

Arif HEPBASLI^a, Emrah BIYIK^b, Mustafa ARAZ^c, Runming YAO^d, Mehdi SHAHRESTANI^e, Emmanuel Essah^f, Li SHAO^g, Armando C. OLIVEIRA^h, Teodosio del CAÑOⁱ, Elena RICO^j, Juan Luis LECHÓN^k

^a Yasar University, Turkey, arifhepbasli@gmail.com

^b Yasar University, Turkey, emrah.biyik@yasar.edu.tr

^c Yasar University, Turkey, mustafa.araz@yasar.edu.tr

^d The University of Reading, United Kingdom, r.yao@reading.ac.uk

^e The University of Reading, United Kingdom, m.shahrestani@reading.ac.uk

^f The University of Reading, United Kingdom, e.a.essah@reading.ac.uk

^g The University of Reading, United Kingdom, l.shao@reading.ac.uk

^h University of Porto, Portugal, acoliv@fe.up.pt

ⁱ Onyx Solar Energy S.L., Spain, tdc@onyxsolar.com

^j Onyx Solar Energy S.L., Spain, erico@onyxsolar.com

^k Onyx Solar Energy S.L., Spain, jlechon@onyxsolar.com

Also presented at World Sustainable Built Environment Conference 2017 Hong Kong (Session 4.3).

SBE16 SYDNEY (17-18 NOVEMBER 2016)

[Website: <http://www.sbe16sydney.be.unsw.edu.au/>]

1. [Retrofit or Behaviour Change? Which has the Greater Impact on Energy Consumption in Low Income Households?](#)

Melissa JAMES^a, Michael AMBROSE^b

^a CSIRO, Australia, melissa.james@csiro.au

^b CSIRO, Australia, michael.ambrose@csiro.au

Also presented at World Sustainable Built Environment Conference 2017 Hong Kong (Session 3.13).

2. [Upgraded Mineral Sand Fraction from MSWI Bottom Ash: an Alternative Solution for the Substitution of Natural Aggregates in Concrete Application](#)

Jacques Rémy MINANE^a, Frédéric BECQUART^b, Nor Edine ABRIAK^c, Christophe DEBOFFE^d

^a IMT Lille-Douai, LGCgE-GCE, France, remyminane@gmail.com

^b IMT Lille-Douai, LGCgE-GCE, France, frederic.becquart@imt-lille-douai.fr

^c Néo-Eco Développement, France, nor-edine.abriak@imt-lille-douai.fr

^d Néo-Eco Développement, France, cdeboffe@neo-eco.fr

Also presented at World Sustainable Built Environment Conference 2017 Hong Kong (Session 7.6).

3. [Spatial and Activity Preferences During Heat Stress Conditions in Adelaide: Towards Increased Adaptation Capacity of the Built Environment](#)

E. SHARIF^a, A. SIVAM^b, J. BOLAND^c

^a School of Information Technology and Mathematical Sciences, University of South Australia, Australia, ehsansh57@gmail.com

^b School of Art, Architecture and Design, University of South Australia, Australia

^c School of Information Technology and Mathematical Sciences, University of South Australia, Australia

4. [Towards an Automated Approach for Compiling Hybrid Life Cycle Inventories](#)

Robert H. CRAWFORD^a, Paul-Antoine BONTINCK^b, Stephan ANDRÉ^c, Thomas WIEDMANN^d

^a Faculty of Architecture, Building and Planning, The University of Melbourne, Australia, rhcr@unimelb.edu.au

^b Faculty of Architecture, Building and Planning, The University of Melbourne, Australia

^c Faculty of Architecture, Building and Planning, The University of Melbourne, Australia

^d Sustainability Assessment Program, School of Civil and Environmental Engineering, The University of Sydney, Australia

5. [Enabling Innovation in Building Sustainability: Australia's National Construction Code](#)
Alexander ARMSTRONG^a, Clare WRIGHT^b, Brian ASHE^c, Heather NIELSEN^d
^a Australian Building Codes Board, Australia, alexander.armstrong@abcb.gov.au
^b Australian Building Codes Board, Australia
^c Australian Building Codes Board, Australia
^d Australian Building Codes Board, Australia
6. [Concrete Containing Recycled Concrete Aggregate with Modified Surface](#)
Jozef JUNAK^a, Alena SICAKOVA^b
^a jozef.junak@tuke.sk
7. [Computational Design and Parametric Optimization Approach with Genetic Algorithms of an Innovative Concrete Shading Device System](#)
Andrea ZANI^a, Michele ANDALORO^b, Luca DEBLASIO^c, Pierpaolo RUTTICO^d, Andrea GIOVANNI MAININI^e
^a andrea.zani@polimi.it
8. [Optimization of Wind Tower Cooling Performance; A wind Tunnel Study of Indoor Air Movement and Thermal Comfort](#)
Mahsan SADEGHI^a, Richard de DEAR^b, Bijan SAMALI^c, Graeme WOOD^d
^a Faculty of Architecture, Design & Planning, The University of Sydney, Australia, mahsan.sadeghi@sydney.edu.au
^b Faculty of Architecture, Design & Planning, The University of Sydney, Australia
^c Centre for Infrastructure Engineering, Western Sydney University, Australia
^d Cermak, Peterka and Peterson, Sydney, Australia
9. [Thermal Environment and Thermal Sensations of Occupants of Nursing Homes: A Field Study](#)
Federico TARTARINI^a, Paul COOPER^b, Richard FLEMING^c
^a University of Wollongong, Australia, ft674@uowmail.edu.au
^b University of Wollongong, Australia
^c University of Wollongong, Australia

SBE16 CAIRO (29 NOVEMBER-1 DECEMBER 2016)

[Website: <http://sbe16cairo.com/>]

1. [Adoption of Appropriate Technology in Construction: A Pilot Study of Compressed Earth Blocks Uptake in Kamuli District – Uganda](#)
Thomas NIWAMARA^a, Alex NDIBWAMI^b
^a Uganda Martyrs University, Nkozi, Uganda, pniwe@yahoo.com
^b Uganda Martyrs University, Nkozi, Uganda, andibwami@gmail.com
2. Utilizing Palm Rachis for Eco-Friendly and Flexible Construction in Egypt
Yasser MANSOUR^a, Hamed ELMOUSLY^b, Eman Atef DARWISH^c
^a Department of Architecture, Ain Shams University-Cairo, Egypt, yasser_mansour@eng.asu.edu.eg
^b Department of Architecture, Ain Shams University-Cairo, Egypt, cdsilt@idsc.gov.eg
^c Department of Architecture, Ain Shams University-Cairo, Egypt, eman.atef@eng.asu.edu.eg

Also presented at World Sustainable Built Environment Conference 2017 Hong Kong (Session 6.6).
3. Strategic Plans For Egyptian Cities and Its Role in Dealing with Urban Land Use Dynamics in Peri-Urban Areas
Rania Hieder AHMAD^a
^a General organization of physical planning, Egypt, raniahieder@yahoo.com
4. Design of Funicular Arched Wooden False Work
Mohamed Mohamed Salaheldin DARWISH^a
^a American University in Cairo, Egypt, mdarwish@aucegypt.edu

5. Statistical Analysis on the Impact of Dusty Weather on Power Output of Solar Cells on Commercial Roof-top PV Systems in Egypt
Heba Ahmed MOSALAM^a, Eldahan OMAR^b
^a Heliopolis University for Sustainable Development, Egypt, heba.mosalam@hu.edu.eg
^b Heliopolis University for Sustainable Development, Egypt, omar.eldahan@hu.edu.eg
6. [Technology Era City Models and Governance Urban Innovation Integrated Planning](#)
Eman ABDEL SABOUR^a, Manar AL GAMMAL^b
^a Qatar University, Qatar, eman.abdel@polimi.it
^b Politecnico di Milan, manar.elgammal@polimi.it
7. Developing a Methodology to Cluster Commercial Transport Services in Urban Areas
Farid RANDA^a
^a randa.farid@gmail.com
8. Alternative Concepts and Housing Typologies for a Socially Inclusive, Sustainable City
Juettner MONIQUE^a
^a monique.juettner@guc.edu.eg
9. Using Intelligent Case-Based Reasoning (CBR) for Parametric Cost Estimating in Construction
Georgy MAGED^a
^a maged.georgy@rmit.edu.au
10. **The Emergent Biophilia: An Exploratory Study on the Impact of Integrating “Biophilic Principles” in Designing Educational Spaces for Childhood**
Khodeir LAILA^a
^a drlailakhodeir80@gmail.com

SBE16 MALMO (30 NOVEMBER-2 DECEMBER 2016)

[Website: <http://malmo.se/scd2016>]

1. Monitoring Progress toward the Achievement of Sdgs in European Local Governments
Junya YAMASAKI^a, Toshiharu IKAGA^b, Shuzo MURAKAMI^c, Shun KAWAKUBO^d
^a Keio University, Japan, woodenbat@a6.keio.jp
^b Keio University, Japan, ikaga@sd.keio.ac.jp
^c Institute for Building Environment and Energy Conservation, Japan murakami@ibec.or.jp
^d Hosei University, Japan, kawakubo@hosei.ac.jp
2. How Can We Assess the Achievement of the Sustainable Development Goals? – A Review of Indicators and their Application at the City Level
Roland ZINKERNAGEL^a
^a Lund University, Sweden, roland.zinkernagel@iiee.lu.se

Also presented at World Sustainable Built Environment Conference 2017 Hong Kong (Session 2.12).

SBE16 SEOUL (11-14 DECEMBER 2016)

VIII. SESSION SUMMARY & CONFERENCE PAPAERS

A. Keynote Sessions

KEYNOTE 1

Matthew CHEUNG Kin-chung, GBS, JP, *Chief Secretary for Administration, The Government of the Hong Kong Special Administrative Region*

KEYNOTE 2

SU Yunshan, *Director-General, Department of Science & Technology and Energy Saving on Buildings, Ministry of Housing and Urban-Rural Development, People's Republic of China*

KEYNOTE 3

Topic: The Paris Agreement Meets the Future Where We Need to Be: in Cities That Are Crowded, Clean and Connected, with Buildings That Are Organic, Efficient and Resilient
Christiana FIGUERES, Vice-Chair, Global Covenant of Mayors for Climate & Energy

ABSTRACT

Does the Paris Agreement solve climate change?

No, it seeks to prevent the worst effects of climate change. Insurance industry deems a temperature rise that goes beyond 2 degrees as systemically uninsurable.

Does it include every country and every sector?

It has been adopted by 195 countries and ratified by 110 countries. It constitutes a global business plan for the decarbonization of the economy. That business plan is now being devolved down to the level of countries, states and cities. It includes most sectors of human endeavor but in particular it points toward a transformation of our physical infrastructure (energy, transportation, buildings) and our natural infrastructure (forests and agriculture).

Will it be implemented?

Yes, the advance in clean energy generation technologies and the drop in prices have taken climate change beyond the sphere of politics into the sphere of the market place. The competitiveness of RE is established and will continue to escalate exponentially based on increasing public and private demand. Smart meters and blockchain technology are just two of the many innovations that will escalate RE. In turn the increasing abundance of cheap and clean electricity is catalyzing electric transportation. And electric vehicles may turn out to be one part of the answer on storage. Coal has no future. Oil and gas are quickly losing ground. Benefits of clean technologies are becoming more visible and more valued. Demand for cleaner technologies is on the rise. Decarbonization of the global economy is unstoppable.

What are the implications for the built environment?

Infrastructure is at the center of the climate challenge for three reasons. First because of direct physical impacts due to increasing extreme weather events. Secondly because the interest in and demand for resilient and environmentally responsible urban planning and building is on the rise. Third because of the unprecedented growth in urbanized population over the next two decades.

Those three trends point to a fundamental transformation in the way we plan, build and inhabit our cities. It points to a fundamental transformation in building design, materials, and operational efficiency. The direction is clear: buildings that are organically designed, using materials that obey cradle to cradle or circular principles, and are energy and water efficient. The integration of innovation is giving the best results. Practices such as integrated project delivery and triple bottom line cost benefit analysis are showing the way forward. Finally, the literature shows that this built environment leads to happier and healthier citizens.

KEYNOTE 4

Topic: Infrastructure, Resilience and Sustainability

Peter GUTHRIE, *Professor, Engineering for Sustainable Development, University of Cambridge*

ABSTRACT

The understanding of sustainability has now matured over thirty years since the Brundtland definition came to world attention. Its success in being accepted has also been its shortcoming, in that there is wide diversity in its interpretations applied to different fields.

In the field of civil infrastructure, the emerging concept of resilience is finding more traction with practitioners. Whilst subject to a similar diversity of meanings as sustainability, resilience can be more readily translated into physical interventions to improve performance. Infrastructure can be made more robust, more adaptable, more amendable, to be better prepared for shocks to the system.

Using case studies from a review of infrastructure delivery, past disasters, and current thinking on resilience, this presentation will draw together lessons learned and put forward proposals for action to improve resilience so as to achieve greater sustainability.

KEYNOTE 5

Topic: Environmental Transformation of the Built Environment

Thomas AUER, *Managing Director, Transsolar, Professor, Building Technology and Climate Responsive Design, Technical University of Munich*

ABSTRACT

The European **Union's Roadmap for Moving to a Competitive Low Carbon Economy in 2050 ('carbon roadmap')** states that in comparison to 1990, CO₂ emissions of the building sector should be reduced by 90% by 2050. This will have a significant impact on our environment, and the architecture of buildings and cities will change dramatically. But the requirements for energy efficiency and comfort cannot be fulfilled by technology alone. A balance of passive design strategies and active ones is the key to a well-orchestrated system. This requires a thorough understanding of first principles, where climate-responsive design contributes a piece to this complex puzzle.

The goal is for architecture and climate control strategies to become a synergistic unit, where technology is optimised and/or supplemented where needed. The aim of climate responsive design is to develop buildings that offer maximum comfort while minimizing the use of resources and systems. In this regard, building efficiency and user comfort are closely connected with architecture. Besides, vernacular design principles often illustrate the potential of passive design strategies. We recognise that all aspects of design influence environmental conditions. For a sophisticated climate design it is required that form, material and mechanical systems are synergistic components of a finely-tuned climate control system; and conversely, an environmental control strategy is integral to the architectural concept. A full appreciation of all technical aspects of comfort is essential for advanced climate design, both on a building and an urban scale.

It is necessary to approach design holistically. A holistic approach to design, however, also requires expansion of the focus from individual buildings (at district level) to the overall urban context in order to accomplish the goals defined within the EU carbon roadmap. Mixed-use urban districts provide the potential for energy and water supply strategies in which requirements that vary between different program areas enable synergetic service strategies. In this regard it is essential to deploy climate design in on all scales. Aside from an efficient use of resources, outdoor environmental quality becomes another aspect that is directly linked to urban form, materiality and the design of the public realm.

KEYNOTE 6

Topic: Reframing Environmentalism: Shaping a Positive Future

Raymond COLE, *Professor, School of Architecture and Landscape Architecture, University of British Columbia, Canada*

ABSTRACT

Environmentalism has been variously framed as concern about and action aimed at protecting the environment. Critics argue that its message is alarmist, sets environmental issues apart and contextually disconnected from other pressing societal concerns, and situates responsibility and solutions within the domain of a separate movement and its expertise. The current period of increasing climate and political uncertainty creates a qualitatively different context for environmentalism.

In building design, environmentalism has been exercised through strategies directed at reducing non-renewable **resource use and pollutant emissions**. What is commonly referred to as “green building” design, for example, has been almost exclusively directed at reducing the degenerative consequences of the built environment on the health and integrity of ecological systems rather than emphasizing positive outcomes. While important and necessary, such a response is increasingly recognized as being an insufficient one.

Rather than reducing destructive impacts, the emerging notion and practice of regenerative approaches views buildings as catalysts for positive change, adding value and enabling the full potential of the social and ecological systems to the unique place they are situated. Regenerative approaches are therefore inherently hopeful and full of promise – a marked contrast to the negative messaging of much of the current environmental discourse. While the technical strategies of green design remain valid, the intention, language and more comprehensive framing of regenerative development offers considerable potential to accelerate the development of a shared vision, shared ownership and shared responsibility. The most significant and necessary shift does not therefore reside solely at the strategic level, but in the mind-set of design teams and clients.

Eventually, perhaps, we will come to view the act of building not as destructive of natural systems and depleting **the earth’s resources but as contributing to and supporting the creation of a thriving**, resilient and abundant world. To achieve such an ambition, we will need to articulate the vision and associated values necessary to affect and guide positive change and, in particular, how these are communicated to a broader public. Buildings, it would seem, can and should form a critical part of this communication process.

B. Plenary Session on Climate Change and Sustainable Development

Meeting the global challenges related to climate change and resource use requires action at all levels, including national governments, local authorities, private sector and civil society. Globally, the building sector contributes more than one third of the energy consumption, nearly 25% of greenhouse gases emissions and up to 40% of resource consumption. At a time when rapid urbanisation and development in many parts of the world is increasing demand for resources and energy, the building sector plays a critical role in assuring that what is built, now and in the future, meets both the needs of the communities while contributing to address climate change and achieve broader sustainable development objectives.

Led by UN Environment, the Plenary Session on Climate Change and Sustainable Development will take place on 6 June (Day 2 morning) at WSBE17 Hong Kong. Through presentations and interactive panel discussion, influential leaders of several international organisations will discuss:

- Why the building sector is critical to mitigate climate change and achieve sustainable development
- The potential of the building sector to contribute to the less than 2-degree scenario as outlined in the Paris Climate Agreement, as well as to the Sustainable Development Goals (SDGs)
- The pathways and that countries and other stakeholders, including local authorities and the private sector, can adopt to realise climate objectives
- How actions that organisations could take in the building sector contribute to achieving the targets in the SDGs

This session will feature key perspectives, including from Ms Christiana FIGUERES, Vice-Chair, Global Covenant of Mayors for Climate & Energy, and former Executive Secretary of the UN Framework Convention on Climate Change, as well as other organisations representing the public and private sector and the international community. Through presentations and a moderated panel discussion, this session will provide an overview of environmental impact and highlight the potential of the building sector, focusing on solutions and necessary actions to achieve the objectives of the Paris Climate Agreement, and the Sustainable Development Goals.

SESSION CHAIR

Curt GARRIGAN, Cities and Buildings Programme Manager, UN Environment- Economy Division

SPEAKERS

Topic: Hong Kong Government's Initiatives in Combating Climate Change

WONG Kam-sing, GBS, JP, Secretary for the Environment, The Government of the Hong Kong Special Administrative Region

Topic: The Paris Agreement Is a Blueprint for a Comprehensive Economic and Technological Transformation in the Way We Live, Move and Work, and Buildings are at the Nexus of This Revolution
Christiana FIGUERES, Vice-Chair, Global Covenant of Mayors for Climate & Energy

ABSTRACT

The Paris Agreement is not merely an environmental treaty. It is a blueprint for a comprehensive economic and technological transformation in the way we live, move and work. None of these are independent of each other, but rather they all mutually reinforce each other.

There are three main building blocks of the new urban paradigm: energy, transportation and the built environment. Energy is being rapidly decarbonized thanks to the dramatic drop in costs of renewables over the past 8-10 years and the incipient storage technology. Transportation is going shared, driverless and electric. Buildings are at the nexus of the energy and transportation revolutions. Buildings need to keep pace with those revolutions in order to benefit from them, and to provide an integrated living experience of high quality to dwellers.

Topic: City Actions to Achieve Global Climate and Sustainable Development Objectives
Jennifer LAYKE, Director, Global Energy Program, World Resources Institute

Topic: Addressing National Housing Needs: Risks and Opportunities for the Environment
Gregor HERDA, Regional Housing Advisor, United Nations Human Settlement Programme (UN-Habitat)

Topic: Energy Technology Perspectives: Transitions to Sustainable Buildings
John DULAC, Energy Technology Policy Building Sector Lead, International Energy Agency

Topic: Survey of Effective Actions for Mitigating Climate Change
Nils LARSSON, Executive Director, International Initiative for a Sustainable Built Environment

Topic: Mainstreaming Sustainable Building and Construction - Collaboration Opportunities in the UN
10YFP on Sustainable Consumption and Production
Pekka HUOVILA, Coordinator, The 10YFP Programme on Sustainable Buildings and Construction

Topic: Engaging the Private Sector to Transform Our Cities
Roland HUNZIKER, Director, Sustainable Buildings & Cities, World Business Council for Sustainable Development

PANEL DISCUSSION

Christine LOH, Under Secretary for the Environment, The Government of the Hong Kong Special Administrative Region

Christiana FIGUERES, Vice-Chair, Global Covenant of Mayors for Climate & Energy

Jennifer LAYKE, Director, Global Energy Program, World Resources Institute

Gregor HERDA, Regional Housing Advisor, United Nations Human Settlement Programme (UN-Habitat)

Pekka HUOVILA, Coordinator, The 10YFP Programme on Sustainable Buildings and Construction

Roland HUNZIKER, Director, Sustainable Buildings & Cities, World Business Council for Sustainable Development

C. Roundtable Sessions

The Roundtable Sessions at WSBE17 Hong Kong echo with the conference theme “Transforming Our Built Environment through Innovation and Integration: Putting Ideas into Action”. Roundtable 1 emphasises “Ideas” on emerging trends and forward-looking principles to transform the built environment. Roundtable 2 focuses “Actions” and practice-focused viewpoints on leading the changes to drive the sustainable built environment.

ROUNDTABLE 1

Topic: Emerging Perspectives for Transforming the Built Environment

The construction and real estate sector faces multiple challenges that the solutions today may not be optimal for the future. The knowledge of emerging trends is thus indispensable for the development of innovative and integrative solutions to transform the built environment.

A group of international industry experts and representatives from various stakeholder groups will gather to stimulate a vibrant dialogue to discuss how the emerging perspectives relate to the topics of high-performance building, deep building renovation, sustainable neighbourhood and community empowerment.

SESSION CHAIR

Thomas LÜTZKENDORF, Director, Centre for Real Estate and Head of Chair, Sustainable Management of Housing and Real Estate, Karlsruhe Institute of Technology (KIT), Germany

SPEAKERS

Topic: Winning the Battle against Climate Change

TAI Lee-siang, Chair, WorldGBC

ABSTRACT

WorldGBC represents a body of diverse building industry players seeking to overturn the threat posed by Climate Change. This presentation provides an outline of the main strategies and thrusts of the relatively young global organization. In addition, Lee Siang will share from his experiences, both as an architect and urban planner, the holistic principles to unlock the potential of traditional wisdom and ground up efforts to achieve total sustainability. In particular, he will focus the discussion on strategies in cities – the highly urbanized future of mankind.

Topic: An Emerging Trend of Green Building Development in China

WANG Youwei, Chairman, China Green Building Council

Topic: How to Create High Real Estate Value with Sustainable Urban Planning

Serge SALAT, President, Urban Morphology & Complex Systems Institute

Topic: Towards Buildings as Active Agents in Low Carbon Cities

Arno SCHLUETER, Professor, Architecture and Building Systems ETH Zurich; Principal Investigator, Future Cities Laboratory, Singapore ETH Centre

ABSTRACT

Towards Buildings as Active Agents in Low Carbon Cities

For future-proof cities, buildings need to evolve from passive consumers to active agents in the urban fabric, balancing and trading energy, resources and fostering comfort, indoors and outdoors. This poses challenges on many ends which needs to be overcome to transition towards a more sustainable building stock. We can call them the Three Grand Challenges:

Dealing with complexity

Future efficient buildings employ sophisticated building systems to ensure efficient operation, energy generation and occupant comfort. These systems span across different domains, over the entire building lifecycle. Increased

complexity not only means a higher risk of false installation, malfunction and improper operation, it also means different skillsets of people that design, plan build and operate buildings. The challenge therefore is: how do we address the increasing complexity in our designs, our processes and adapt the skillsets of people involved in the building process?

Human-in-the-loop

With all technology, we sometimes forget that buildings are actually made for humans. Energy efficiency is therefore nothing without maintaining or even improving occupant comfort and human well-being. Whereas we understand well the building and systems physics, the occupants, their stochastic behavior and differencing preferences remain as a challenge. How can we design, build and operate environments that that respond, adapt and thus learn from the humans it is inhabited by? Furthermore, as buildings are artefacts with very long lifecycles, how do we design buildings and buildings systems that are flexible, expandable and fit for change?

New Models

Knowledge without realistic chance of implementation has not impact. We are beyond just technological solutions. The solutions we develop must take into account the specificities of the built environment such as the large scale, long lifecycles and risk aversion. This requires an understanding of its fundamental economic mechanisms in order to leverage and eventually change them. The grand challenge is to make efficient systems economically viable. This calls for new business models that leverage cross-benefits, that leverage the lifecycle, that control and mitigate risk in order to create economic incentives for implementing new approaches on a large scale.

Topic: Disruptive Innovations Transforming Sustainable Built Environment
Bryant LU, Vice Chairman, Ronald Lu and Partners

ROUNDTABLE 2

Topic: Leadership Driving for the Sustainable Built Environment

This Roundtable focuses on the importance of leadership in driving change. Expert panelists will discuss the use of data to showcase outcomes and results in order to demonstrate environmental, financial and other benefits, as well as using decision-making tools to clarify and help leaders make sense of different types of challenges. The case of Singapore and Hong Kong will be raised on how government leaders approached developing policies for sustainable buildings and environment, and a specific corporate leader will share experience on how decisions have been made and what will continue to drive change.

SESSION CHAIR

Christine LOH, Under Secretary for the Environment, The Government of the Hong Kong Special Administrative Region

SPEAKERS

Topic: Why we should be Assessing Building Performance from the Point of View of the Users and How It Can Be Done

George BAIRD, Emeritus Professor, Building Science, School of Architecture, Victoria University of Wellington

Douglas WOO, Chairman & Managing Director, Wheelock and Company Ltd.

Topic: Innovative and transformative leadership in the built environment – The Cynefin decision-making framework and the search for tipping points

Greg FOLIENTE, Enterprise Professor, University of Melbourne; Regional Director in Asia-Pacific, iiSBE; Founding Director, nBlue Pty Ltd

Topic: Singapore's drive towards a Sustainable Tropical City

TAN Tian-chong, Deputy Managing Director, Built Environment Research and Innovation Institute, Building and Construction Authority

ABSTRACT

Singapore has been striving towards achieving a sustainable built environment for more than a decade. A number of initiatives were shaped and successfully implemented under the Singapore's Green Building Masterplans, covering a wide range of policies, programmes and measures. Driven by government leadership through BCA, we have greened (certified through BCA Green Mark standards) over 30% of buildings in Singapore and are on track to achieve our goal of greening at least 80% of our building stock by 2030.

Moving forward, an aspirational goal is set for Positive Energy Low-rise, Zero Energy Medium-rise and Super Low Energy High-rise (PE-ZE-SLE) Buildings in the Tropical Urban City. The government, industry, and academia are jointly developing a technology roadmap to guide the implementation and further spur innovation in green buildings.

Topic: Building Inclusive and Sustainable Communities through Transit Integration

Lincoln LEONG, Chief Executive Officer, MTR Corporation

ABSTRACT

Hong Kong's experience in building sustainable and inclusive communities through transit integration may have relevance to cities around the world that are facing challenges arising from urbanisation. It is an example of how 'value capture' principles can be adopted in an urban environment to help cities meet their development needs for housing and transportation in ways that are user-friendly, and also financially and environmentally sustainable.

In Hong Kong, the MTR Corporation's railway services form the backbone of the local public transport system, carrying around 5.6 million passenger journeys every weekday with a world-class on-time performance of 99.9%.

Residential and commercial properties have been developed above or adjacent to railway stations and depots to create communities that are fully integrated with the railway network, and also offer a range of facilities and services to meet the diverse needs of individuals of all ages.

In this way, Hong Kong has evolved an integrated rail and community development model that is financially and environmentally sustainable for the long term. Through integrated station development, railway patronage is stimulated, profits from property sales can be used to finance new railway projects, and fares can thus be kept at reasonable levels without the need for government subsidies.

The model follows a transit-oriented development approach centred around a high-quality low-carbon railway service, which connects to bus, minibuses, tram and taxi services. Building residential and commercial properties above railway stations optimises the use of scarce and valuable land in an urban environment. Seamless transport connections provide maximum convenience for people living and working above the stations, while unnecessary road traffic is also reduced.

To promote sustainable building design, construction, operations and maintenance, new residential property developments are required to achieve Hong Kong BEAM Plus Gold certification as a minimum.

D. Parallel Sessions

i. Mainland China Sessions

(1) The Comprehensive Scheme on Green Retrofitting and Performance Enhancement of Existing Buildings in China

Session Organiser: China Academy of Building Research

SESSION OUTLINE

From 1995 to 2005, China's building stock nearly tripled, and it is expected to nearly triple again by 2030. This forum will investigate the governance of existing buildings in China from the policy perspective, the technology for improving energy efficiency of buildings, and the standards for green retrofitting.

Strategies have been developed to respond to different climatic conditions, building types and users. It will lead to different technical approaches and considerations on the green retrofitting policy and performance enhancement of buildings. Case studies will be used to illustrate the implementation process.

The forum has invited five experts to share their professional insights and academic research with us, including the retrofit of green roofs, retro-commissioning, and retrofits of existing commercial buildings, building performance enhancement of existing residential dwellings and the experience on sustainable building operational and management.

SESSION CHAIR

YIN Bo, Director, Division of Science and Technology, China Academy of Building Research (CABR)

SPEAKERS AND PRESENTATION TOPICS

1. The Roadmap on the Development of Comprehensive Scheme on Green Retrofitting and Performance Enhancement of Existing Buildings in China
YIN Bo, Director, Division of Science and Technology, China Academy of Building Research (CABR)
2. The Appropriate Technologies and Practical Case Study on Green Retrofitting the Residential Dwellings in the Severe Cold Climatic Zone in China
JIANG Yiqiang, Professor, School of Municipal and Environmental Engineering, Harbin Institute of Technology (HIT)
3. The Appropriate Technologies and Case Studies on Green Retrofitting the Healthcare Facilities in China
DI Yanqiang, Head of Division, Division of Construction Technologies, China Building Technique Group Co., Ltd. (CBTGC)
4. The Case Studies and Technology Advancements on Green Retrofitting the Office Buildings in China
ZHAO Li, Deputy Head, Division of Research and Development, China Academy of Building Research (CABR)

(2) Green Building Design and Technological Challenges of Eco Skyscraper in China Session Organiser: Shanghai Research Institute of Building Sciences

SESSION OUTLINE

According to the global tall building database of the CTBUH, around half of the Top 10 completed skyscrapers in the world are located in China, including Shanghai Tower (Shanghai, 632m), Ping An Finance Center (Shenzhen, 599m), and Guangzhou CTF Finance Centre (Guangzhou, 530m), etc. The design, construction, and management of super skyscraper bring a unique challenge to the green building development. The session will start with the discussion on the development of evaluation standard for the green skyscraper buildings in China and extend to the energy-saving strategies focusing on the low-grade energy bus in the HVAC system. Performance enhancement of the green skyscraper buildings is one of the key focus areas. Finally, the session will present a business case study on the green design features and facility management of the tallest building in China – Shanghai Tower.

SESSION CHAIR

IXU Qiang, Chief Engineer, Shanghai Research Institute of Building Sciences (Group) Co., Ltd.

SPEAKERS AND PRESENTATION TOPICS

1. Evaluation of Green Skyscraper Buildings in China
SONG Ling, Deputy Director, Center for Science and Technology & Industrialization Development, Ministry of Housing and Urban-Rural Development of the P.R. China (MOHURD)
2. Energy Saving Potential of Air-conditioning System with Low-Grade Energy Bus in Skyscrapers
LI Xianting, Professor, School of Architecture, Tsinghua University
3. In Pursuit of Excellence: Sustainable High-performance Skyscrapers
ZHANG Bolun, Director, East China Architectural Design and Research Institute
4. Green Design and Facility Management Systems in Shanghai Tower
YANG Jianrong, Deputy Director, Shanghai Research Institute of Building Sciences (SRIBS)

(3) Turning Green to Gold – Green Practices for Urbanisation in China Session Organiser: Shenzhen Green Building Association and Shenzhen Institute of Building Research

SESSION OUTLINE

Shenzhen is a winner of C40 Cities Annual Awards for Best Finance & Economic Development Project of 2016. The city has a population of 15 million and an annual GDP growth rate of 10%. Shenzhen is one of the most inspiring and innovative cities tackling climate change. The session will present the action plan/program, implementation strategy and the challenges of Shenzhen to tackle the climate change. For the governance of climate change, it involves policy on setting up targets, monitoring and restricting the carbon emission and energy use, and the implementation of legal system. Market driver is one of the approaches to lead the green city transformation. A business case study on green building development in city transformation will be presented from a leading property developer in China. To conclude, the session will discuss the potential to increase credit rating of green bond to drive the sustainable development in China.

SESSION CHAIR

YE Qing, Director, The Shenzhen Institute of Building Research Ltd and the President of Shenzhen Green Building Association

SPEAKERS AND PRESENTATION TOPICS

1. QIU Baoxing
Counsellor of Counsellor's Office of the State Council, PRC
2. The Action and Challenges of Climate Change Governance in Shenzhen
TANG Jie, Professor, School of Economics and Management, Harbin Institute of Technology (Shenzhen)
3. Low-Carbon Development in Shenzhen – Policy and Implementation,
ZHANG Xuefan, Director, Bureau of Housing & Construction of Shenzhen Municipality
4. A Business Case of Vanke in Green City Transformation,
WANG Yun, Vice President, China Vanke Co., Ltd.
5. Increasing Credit Rating of Green Bond to Drive the Green Building Development in China
Kevin MO, Managing Director, Paulson Institute Representative Office
6. Ying HUA
Associate Professor, Department of Design and Environmental Analysis, The Cornell University

(4) The Development Framework and Professional Best Practices of Healthy Buildings in China Session Organiser: Green Building Research Centre and the Chinese Society for Urban Studies

SESSION OUTLINE

With the joint efforts of China Academy of Building Research, the Chinese Society for Urban Studies and the China **Architecture Design & Research Group, China has developed its "Assessment Standard for Healthy Building"** (T/ASC 02-2016), and published in the first quarter of 2017. The session will cover a wide range of topics, including the development of the China Assessment Standard for Healthy Building, the best professional practices and its applications, the control and prevention of the exposure of indoor air pollutants PM2.5 against the health risks of occupants, the technological innovations and business case studies on how to monitor, manage and control the indoor air quality for the occupants in dwellings.

SESSION CHAIR

MENG Chong, Deputy Director, Green Building Research Center, Chinese Society for Urban Studies

SPEAKERS AND PRESENTATION TOPICS

1. Water is the Essence of Healthy Building
ZENG Ji, Deputy Director, Architectural Design Institute, China Academy of Building Research
2. The Control and Prevention of Indoor PM2.5 against the Health Risks of Occupants
ZHANG Yinping, School of Architecture, Tsinghua University, China
3. Development of the China Healthy Building Assessment Standards and its Professional Practices
MENG Chong, Deputy Director, Green Building Research Center, Chinese Society for Urban Studies, China
4. Technological Innovations and Best Practices of Healthy Buildings
JIA Yan, Founder & CEO, First Human Environmental Technologies (Beijing) Co., Ltd., China

ii. Regional Sessions

There are four Regional Sessions discussing the intensity and importance of the specific issues in relation to sustainability in the 20 countries which held the SBE Regional Conferences in 2016. Common challenges and differences will be identified, and the significance of current conditions, initiatives and trends will be explored.

The sessions are presented by the 20 Regional Conference Organisers and chaired by SBE16 Conference Series Co-owners.

Session 1.2

CZECH REPUBLIC, ITALY, SWEDEN AND SWITZERLAND

SESSION CHAIR

François BAILLON, Board member, SBE series; Senior Adviser, FIDIC; Treasurer, Business and Climate Summit Association; Founder, Ideagrama Consultant

1. SBE16 Prague
Antonin LUPISEK, Czech Technical University in Prague, University Centre for Energy Efficient Buildings, Czech Republic
2. SBE16 Torino
Andrea MORO, President, iSBE Italia, Italy
3. SBE16 Malmö
Roland ZINKERNAGEL, Lund University, Sweden
4. SBE16 Zurich
Guillaume HABERT, Professor, ETH Zurich, Switzerland

Session 2.2

TURKEY, GREECE, MALTA AND EGYPT

SESSION CHAIR

Wim BAKENS, Secretary General, International Council for Research and Innovation in Building and Construction

1. SBE16 Istanbul
Aygen ERKAL, **Secretary General, Türkiye İMSAD**- Association of Turkish Construction Material Producers
2. SBE16 Thessaloniki
Aikaterini TSICALOUDAKI, Associate Professor, Aristotle University of Thessaloniki
3. SBE16 Malta
Ruben Paul BORG, University of Malta
4. SBE16 Cairo
Wafaa NADIM, Architecture Program, German University Cairo, Egypt

Session 5.1

CANADA, BRAZIL-PORTUGAL, THE NETHERLANDS, GERMANY AND TALLINN-HELSINKI

SESSION CHAIR

Luis BRAGANÇA, University of Minho, Portugal

1. SBE16 Toronto
Harry Robert BACH, Secretary Treasurer, iiSBE Canada; Director and Treasurer, iiSBE International;
Director and Treasurer, Sustainable Buildings Canada
2. SBE16 Brazil-Portugal
Cristina Engel ALVAREZ, Professor/Coordinator, Laboratório de Planejamento e Projetos, Universidade
Federal do Espírito Santo, Brazil
3. SBE16 Hamburg
Thomas LÜTZKENDORF, Director, Centre for Real Estate; Head of Chair, Sustainable Management of
Housing and Real Estate, Karlsruhe Institute of Technology, Germany
4. SBE16 Tallinn-Helsinki
Pekka HUOVILA, Coordinator, 10YFP Sustainable Buildings and Construction (SBC) Programme
5. SBE16 Utrecht
Ivo OPSTELTEN, Professor, University of Applied Sciences Utrecht

Session 6.1

AUSTRALIA, MAINLAND CHINA, SINGAPORE, SOUTH KOREA AND PHILIPPINES

SESSION CHAIR

Prof. Greg FOLIENSTE, Enterprise Professor, University of Melbourne; Regional Director in Asia-Pacific, iiSBE;
Founding Director, nBLue Pty Ltd

1. SBE16 Sydney
Deo PRASAD, Scientia Professor, CRC for Low Carbon Living
2. SBE16 Chongqing
Andrew BALDWIN, Chongqing University
3. SBE16 Singapore
Selvam VALLIAPPAN, Senior Manager, Green Building Research, Built Environment Research and
Innovation Institute (BERII), Building and Construction Authority, Singapore
4. SBE16 Seoul
SHIN Sungwoo, Division of Architecture and Architectural Engineering, Hanyang University ERICA
5. SBE16 Manila
Fernando GERMAR, Chairman of Scientific Committee, SBE16 Manila

iii. SBE Challenge
Session Organiser: iiSBE

SBE Urban Challenge: Assessment Protocol and Case Studies

SESSION OUTLINE

The performance assessment of small urban areas is complex, since it raises questions of scale (how large is a small urban area?), suitable key performance indicators, appropriate reference performance benchmarks (similar areas or historical values or...?).

Research and professional teams from several countries will present, analyse and discuss their own approaches to small-area urban performance assessment in the session, supported by case studies where possible.

The sessions will compare the various methods and tools that have been used to describe and assess key performance aspects of small urban areas (e.g. neighborhoods or urban districts). This is an area of research that is under active development in a number of countries around the world and the session should therefore be of environmental and social impact.

SESSION CHAIR

Andrea MORO, President, iiSBE Italia, Italy

SPEAKERS AND PRESENTATION TOPICS

1. A New SBE Challenge Process for a Transnational Generic Framework at Urban Scale
Andrea MORO, President, iiSBE Italia, Italy
Nils LARSSON, Executive Director, International Initiative for a Sustainable Built Environment
2. Case Study - Europe: CESBA MED, CESBA Alps, NewTREND and Felicity Projects
Andrea MORO, President, iiSBE Italia, Italy
Stefania UGLOLA, iiSBE Italia R&D, Italy
Paul MITTERMEIER, Munich University of Applied Science, Germany
Ken DOOLEY, Granlund Consulting, Finland
3. Case Study - South America: URBENERE Network
Cristina Engel ALVAREZ, Professor/Coordinator, Laboratório de Planejamento e Projetos, Universidade Federal do Espírito Santo, Brazil
Luis BRAGANÇA, University of Minho, Portugal
4. Case Study - Asia: China's KPIs for Sustainable Cities
5. Case Study - North America: DISTRICT 2030
Jiri SKOPEK, Managing Director, JLL, Canada; 2030 Districts

SBE Buildings Challenge: Assessment Protocol and Case Studies

SESSION OUTLINE

Building Performance Evaluation compares performance in key aspects (e.g. energy, emissions, water, IEQ, cost) that was predicted at the design stage through simulations and other predictive methods and tools, with the actual performance as assessed during the operation of the building, after at least two years of operation.

Research and professional teams from several countries will present, analyse and discuss their own approaches to BPE in the session, supported by case studies where possible.

Such building performance evaluations are extremely useful to all major actors in the industry who want to have a better understanding of the gap in performance between design and operations.

The Canadian iSBE team has previously undertaken this type of building performance evaluation, and presented the results of the evaluation of nine Canadian case studies at the 2014 WSB Conference in Barcelona. The results were of considerable interest and utility to the Canadian industry, and we anticipate that many other research-oriented teams may find their results to be of equal value in their own regions.

SESSION CHAIR

Nils LARSSON, Executive Director, International Initiative for a Sustainable Built Environment

SPEAKERS AND PRESENTATION TOPICS

1. General Intro about the Process and the Idea of Predicted vs. Actual Performance and the CanTeam Protocol
Gordon SHYMKO, President, G.F. Shymko & Associates Inc., Canada
2. Green and Monitoring in Holiday Inn Express SoHo Hong Kong
Antonio CM CHAN, REC Engineering Co., Ltd., Hong Kong SAR
3. The 2014 CanTeam Evaluation of 9 Case Studies
Gordon SHYMKO, President, G.F. Shymko & Associates Inc., Canada
4. Current Proposal for New Canadian Work
Gordon SHYMKO, President, G.F. Shymko & Associates Inc., Canada
5. UNSW BPE for 50 Dwellings
Lan DING, Senior Lecturer, Faculty of Built Environment, University of New South Wales, Australia

iv. BEAM Plus Neighbourhood: From Theory to Praxis

Session Organiser: Hong Kong Green Building Council Limited

Session 6.14

SESSION OUTLINE

At the Habitat III Cities Conference in Quito, Ecuador, in late 2016, the New Urban Agenda was adopted by the United Nations to set a new global standard for sustainable urban development by taking into the account of the Paris Agreement on Climate Change. The Agenda also put emphasis on the role of cities in social inclusion, economic prosperity and environmentally responsive and resilient urban systems through improved urban planning and design, collaboration and effective use of resources, promoting quality public spaces, supporting green initiatives and infrastructural provisions etc. This echoes the need for a concerted approach to tackling multiple challenges in city and urban development.

Neighbourhood, as a basic “city block”, can play a critical role in sustainable urban development. The compact and dense urban morphology in Hong Kong also implies that the notion of neighbourhood can vary in different degrees in both its scale and typology. With this in mind, BEAM Plus Neighbourhood, the first rating tool in Hong Kong to assess urban sustainability at a neighbourhood or community scale, was developed to assist the development industry in integrating a broader framework of sustainability indicators at the inception or masterplanning stage of a development project before it proceeds to the implementation phase. It aims to fill the current gap in the BEAM Plus Suite of building-level tools: New Buildings, Existing Buildings and Interiors.

The Neighbourhood tool places emphasis on the design and provisions for space between buildings, and embraces socio-economic as well as ecological aspects of a development. Assessment by the tool is divided into seven performance aspects: Community, Site, Materials and Waste, Energy, Water, Outdoor Environmental Quality, as well as Innovations and Additions. By adopting a more holistic approach to the assessment such as the foregoing, it is hoped that BEAM Plus Neighbourhood would play a key role in creating more liveable and healthier environment in Hong Kong.

To ensure greater relevance, user-friendliness and smooth operation of the tool, HKGBC engaged three life projects to undergo semi-internal pilot-testing conducted between 2015 to 2016 prior to recalibrating the launch version of the tool. The three projects are: the Subsidized Sale Flats Development at Fat Tseung Street West of Hong Kong Housing Authority (HKHA), the Transformation of EMSD Headquarters into a Green Building and the West Kowloon Cultural District of West Kowloon Cultural District Authority (WKCDA).

In this session, the notion of BEAM Plus Neighbourhood, its relevance to the Hong Kong context and what the tool measures will be summarised, followed by a sharing of the experience in the tool application by the three pilot-testing project users, and finally, a discussion of the lessons learnt throughout the pilot-testing process.

SESSION CHAIR

Lary POON, Convener of BEAM Plus Neighbourhood Steering Committee/ Roll-out Taskforce, Hong Kong Green Building Council (HKGBC)

SPEAKERS AND PRESENTATION TOPICS

1. BEAM Plus Neighbourhood: An Introduction
Larry POON, Convener of BEAM Plus Neighbourhood Steering Committee/ Roll-out Taskforce, Hong Kong Green Building Council (HKGBC)
2. Subsidized Sale Flats Development at Fat Tseung Street West
Ada FUNG, Deputy Director of Housing (Development & Construction), Hong Kong Housing Authority, Government of the HKSAR, Hong Kong SAR
3. Transformation of EMSD Headquarters into a Green Building
Antony HO, Associate, Arup, Hong Kong SAR

4. West Kowloon Cultural District
William CHAN, Chief Operating Officer, West Kowloon Cultural District Authority, Hong Kong SAR
5. BEAM Plus Neighbourhood: Lessons Learned from Pilot-Testing
Larry POON

Subsidised Sale Flats Development at Fat Tseung Street West

Ada FUNG^a

^a Hong Kong Housing Authority, Government of the HKSAR, Hong Kong SAR, ada.fung@housingauthority.gov.hk

ABSTRACT

The Hong Kong Housing Authority (HKHA) adopts a people-centred approach to provide quality homes for people in need. When designing new public housing developments, HKHA is committed to build for the future by taking into account quality, comfort, sustainability, as well as neighbourhood friendliness.

The introduction of BEAM Plus Neighbourhood (ND) provides a valuable reference for HKHA to enhance the design of public housing in a wider community scale, as demonstrated by its pilot project of the Subsidised Sale Flats Development at Fat Tseung Street West (FTSW).

The FTSW Development comprises a 41-storey domestic block providing 811 flats, estate management facilities, a semi-basement car park and associated external works. The planning and design of the FTSW Development aims to create a sustainable, cost effective and healthy living environment while taking into account the integration with the surroundings, optimization of environmental qualities and enhancement of greening opportunities.

To build for the community effectively, it is vital to engage the stakeholders with inclusiveness, transparency and creativity. We have conducted rounds of community engagement workshops and district council consultations during the early planning and design stages of FTSW. Feedback received was thoroughly considered and has been reflected in the revised master planning of the project, in which the original two single aspect domestic blocks were transformed to one site specific block with specially designed flats to combat surrounding fixed plant noise constraints. This not only allows wind permeability and open view for the neighbourhood, but also enables deferred closing of the existing Fat Tseung Street West Playground for construction at a later stage, so that the disruption to public services could be minimized.

The site abuts public road and streets on three sides while the vehicular access is segregated from the pedestrian route. Residents can access the development conveniently with the covered walkway system and enjoy vehicle-free pedestrian environment. Given the advantages of its siting, the FTSW Development was designed in **conjunction with HKHA's adjacent comprehensive development at the North West Kowloon Reclamation Site 6** from which it is provided with convenient access to public open spaces, sports centre and public library, welfare facilities, retail facilities and transportation hubs including a public transport interchange and the adjacent Nam Cheong MTR Station. The covered pedestrian network serves the community at both the pedestrian and podium levels promoting a vibrant neighbourhood. Commuters can also easily access to the adjoining public housing development at Lin Cheung Road and the waterfront by a long span footbridge over the West Kowloon Highway.

To facilitate the enjoyment of outdoor amenity spaces, we connect different portions of external areas by barrier free access and covered walkways. Moreover, technical studies have been conducted not only to ensure desirable outdoor environment in terms of air quality, noise, natural lighting, thermal comfort etc., but also to seek opportunities to improve the micro-climate environment of the neighbourhood, such as the introduction of a three-storey void at the main entrance to maintain good wind environment and visual permeability.

In line with the commitment of HKHA, the FTSW Development has also attained Gold rating in the provisional assessment under the BEAM Plus New Building scheme. Uses of materials, energy and water etc. have all been optimized in the design and construction stages to reduce the carbon footprint and future energy consumption of the development.

The FTSW Development is scheduled to complete in 2020 and will form part of the vibrant community together with other new public housing developments in Cheung Sha Wan district. With the accomplishment and recognition of this pilot project in the BEAM Plus ND assessment, HKHA shall continue to build for the community with holistic considerations of urban sustainability and neighbourhood friendliness, and enhance the planning and design of public housing developments with reference to the guidelines and good practices promulgated in BEAM Plus ND.
Keywords: BEAM Plus neighbourhood, build for community, neighbourhood friendliness

Transformation of EMSD Headquarters into a Green Building

Ernest HY YEUNG^a, Raymond KF LEUNG^b, Antony WT HO^c, Vicky CY NG^d

^a *Electrical and Mechanical Services Department, Hong Kong*

^b *Electrical and Mechanical Services Department, Hong Kong*

^c *Ove Arup & Partners Hong Kong Ltd, Hong Kong*

^d *Ove Arup & Partners Hong Kong Ltd, Hong Kong*

ABSTRACT

The Electrical and Mechanical Services Department Headquarters (EMSD HQs) was nominated by the Hong Kong Green Building Council (HKGBC) to participate a pilot-scheme of the BEAM Plus Neighbourhood rating tool (BEAM Plus ND) which will be officially launched in December 2016.

The EMSD Headquarters is located in 3 Kai Shing Street, Kowloon Bay, Kowloon, Hong Kong with a project site area of about 28,160 m² with a Piazza of 2,417 m². It has been being put into operation since 2005, was formerly the cargo terminal building occupied by Hong Kong Cargo terminals Limited (HACTL). It is an eight-storey building comprising workshops, car parks, and office space with a gross floor area (GFA) of about 74,414 m².

In 2005, EMSD exhibited successfully an excellent showcase of sustainable development, by converting the former air cargo terminal into their current Headquarters (HQs). EMSD HQs is one of the Green Check Points of Kowloon East to promoting low carbon buildings and providing diversified environmental friendly information to the public. In 2015, EMSD decided to further enhance the sustainable performance of EMSD HQs to maximize the benefits to neighbourhood community. Transformation works will be carried out for the EMSD HQs to further improve the building and the site, and to enhance the environmental performance and sustainability of the development in the connection to the neighbourhood and the society.

As part of the Transformation, the modification of the Piazza will provide a green and sustainable area for public use. Thermal comfort and Urban Heat Island studies were conducted to optimize the design of the Piazza. The proposed soft landscaping area in Piazza will provide a quality leisure and recreational open space. It will allow various activities, such as outdoor exhibition and gathering venue, for public enjoyment. As discovered from the flood risk assessment, the surface runoff from the existing public open space plaza would be decreased by around 14% under 50-year rainfall event due to an increase in permeable area resulting from the proposed development after the Transformation.

The Revamp of the Education Path redesigned both interior and outdoor area of the EMSD HQs, aiming to raise the public awareness of the sustainability initiatives. It will be operated to showcase and promote sustainable lifestyle by mean of education and community collaboration for the visitors and the occupants of the EMSD HQs.

To cut the energy consumption of individual HVAC system, the project site will be connected to the Kai Tak District Cooling System (KT-DCS). It is anticipated to be completed by June 2017. KT-DCS will provide a maximum allowable cooling capacity of 6,600kW to the project site. It covers the cooling demand of 5,000kW by centralized air-conditioning system in the project site, which is over 95% of the site annual cooling energy.

Keywords: sustainability, neighbourhood, BEAM Plus

West Kowloon Cultural District

William CHAN^a

^a West Kowloon Cultural District Authority, Hong Kong SAR, william.chan@wkcd.hk

ABSTRACT

Stretching across 40 hectares of reclaimed land, the West Kowloon Cultural District (WKCD) provides world-class arts and cultural facilities for gestating both international and local arts and cultural developments. To coherent with its Sustainable Master Planning Framework, the West Kowloon Cultural District Authority (WKCD) was engaged by the Hong Kong Green Building Council (HKGBC) to be one of the Pilot Projects for the new BEAM Plus Neighbourhood certification.

With the broader framework of urban sustainability governed by the BEAM Plus Neighbourhood, WKCD demonstrated a commitment on implementing urban sustainability with top-down strategy from master planning level to building level. 3 stages of public engagement exercises were carried out from 2009 to 2011 for collating stakeholders and public concerns. With this placemaking landmark, the socio-economic study confirmed the positive impact on social cohesion to adjacent communities. There is a waterfront promenade along the seaside providing wonderful Harbour view, and part of the site area is public accessible open and greenery area, especially the Park at the west of the WKCD. These greenery areas help to reduce the urban heat island effect by maximizing intra-urban heat island index. Covered linking bridges and subways are planned to provide convenient walkable paths for enhancing the accessibility of both the district and adjacent developments. To provide better outdoor air quality, the local transportation network is planned to be connected with outside roadway network at basement level, so that the pollutant source from vehicles can be separated from the ground floor where people access at most of the time for different kinds of activities. Also, the first smart bike rental system in Hong Kong has been introduced in the district to promote health and sustainable life style as well as reducing the carbon emissions from vehicle.

With a well district planning, infrastructural style utilities are planned. Majority of the cooling load of the non-domestic developments are supported by an energy efficient district cooling system. In addition, to minimize the influence of daylight access of neighbouring sensitive buildings due to WKCD development, vertical daylight factor on the facades of adjacent sensitive buildings are examined. High visual quality of public accessible open space is also recognized. Through this third party benchmarking tool, WKCD was granted the Platinum rating in December 2016.

With this achievement, it forms a role model of Green and Sustainable Master Planning for developments with compact cities characteristic.

Keywords: district, park, cultural

BEAM Plus Neighbourhood: Lessons Learned from Pilot-Testing

Larry POON^a

^a Hong Kong Green Building Council, Hong Kong, larrycpoon@wongtung.com

ABSTRACT

As the global trend moves from building sustainability to urban sustainability, BEAM Plus Neighbourhood (ND) is the first BEAM Plus rating tool to place emphasis on the public realm and socio-economic elements. In so doing, **it demands a more holistic approach to assess a project's performance.**

With the objective to set the appropriate benchmark and embrace a wider range of project types, BEAM Plus ND embarked the first ever pilot-testing amongst the BEAM Plus suite of tools prior to its launch. Three real projects of different scale and use were selected, namely, the Subsidized Sale Flats Development at Fat Tseung Street West of Hong Kong Housing Authority (HKHA), the Transformation of EMSD Headquarters into a Green Building and the West Kowloon Cultural District (WKCD) of West Kowloon Cultural District Authority. The pilot-testing was instrumental to the further refinement of the tool. The lessons learned came in three ways:

- Refining scoring structure to ensure more balanced distribution of credits in different performance aspects;
- Modifying credit requirements to ensure realistic expectations and benchmarking criteria and
- Exploring new methodology to improve the relevance and practicality of the assessment.

Overall speaking, the pilot-testing of BEAM Plus ND confirms the flexibility of the tool in its application to different typologies in Hong Kong. While BEAM Plus ND is primarily intended for use in new development, the EMSD HQ **project demonstrates the tool's versatility for adaptation to existing neighbourhood.**

The project at Fat Tseung Street West comprises a single multi-storey tower which represents a typical residential development in Hong Kong. Despite the site constraints, it demonstrates that by thoughtful site planning and design it can be a good neighbour itself, creating a more cohesive environment with likeable amenities for enjoyment by the local community. At WKCD project - the largest cultural district in Hong Kong – much thought **and effort has been invested in the public realm. It is also a prime example where citizens' view takes centre stage and the stakeholders' interests are empowered.**

Keywords: BEAM Plus neighbourhood, pilot-testing assessment

v. Sponsored Sessions

(1) Vision-led Sustainable Neighborhoods: Myths and Musts

Session Organiser: AECOM

Session 1.7

SESSION OUTLINE

Why is it time to reboot established approaches to neighborhood planning? When is a vision not a vision? And what are the myths and musts for achieving vision-led planning?

Fact

Asia is one of the world's fastest urbanizing regions, providing significant opportunities and challenges for those shaping new developments or regenerating and re-integrating older ones. It has the ability to tip the scale for the rest of the world through its successes and failures. However, societal needs and environmental challenges in cities are growing in complexity.

Worldwide, there is reducing availability of green-field versus brown-field land. And decades of galloping urbanization now raise the challenges of preserving the natural resources, heritage and public realms that distinguish and nurture the city, and that connect citizens with the city and with each other. Future climate change particularly for coastal cities and those in flood plains also makes the challenges even more complex.

The factors driving designs of future new towns are considerably evolved from those that shaped the "older" new towns – such as Shatin, Hong Kong's first new town development forty years ago. Also, Hong Kong, Macau, Guangzhou and Shenzhen are now not only cities, they are part of arguably the world's largest metropolis – the Pearl River Delta. How can we achieve sustainable neighborhoods in the face of urbanization on such a scale? Beyond meeting the basic necessity of housing, what role should the built environment play – in resilience and sustainability - in the future? How can the built environment take on a more adaptive and citizen-friendly form for neighborhood communities to flourish?

Make up your own mind

What are the myths and musts of achieving sustainable neighborhoods? This AECOM-moderated session will engage panelists and audience participants in an exchange of experiences and innovative ideas to better anticipate and address the future design and delivery of sustainable neighborhoods that achieve jointly positive economic, environmental and social impact.

SESSION CHAIR

WONG Chi-chung, Executive Vice President, Asia; Global Head, Chinese Overseas Investment (COI) Program, AECOM, Hong Kong SAR

SPEAKERS

1. Albert KB CHAN
Director of Development Planning & Design, Shui On Land
2. Belinda YUEN
Professorial Fellow and Research Director, Lee Kuan Yew Centre for Innovative Cities, Singapore University of Technology and Design, Singapore
3. Claire BONHAM-CARTER
Principal and Director of Sustainable Development, Design and Planning, AECOM, United States of America
4. Raymond LEE
Director of Planning, Planning Department, Government of the HKSAR

(2) Transportation Hubs: Their Critical Role and Requirements? Session Organiser: AECOM

Session 3.7

SESSION OUTLINE

Beyond dispute, the continuous expansion of transportation infrastructure to connect more of the global population to more of the world has been achieved up to now at a heavy cost to the environment.

This AECOM-moderated session will engage panelists and the audience in an exchange of experiences and ideas **on how to continue providing transportation facilities that enrich people's experiences of the world and** enhance the future economic competitiveness of their cities and countries, with the least possible environmental degradation.

This session provides a practical discussion on the challenges of integrating these large scale additions to the built environment successfully. It features the WSBE17 host city of Hong Kong as one of its case studies. **Hong Kong is a microcosm of so many of the world's most pressing, transportation-related environmental challenges and, at the same time, also at the forefront of piloting and practicing many of the world's leading ideas for solutions.** As the city moves forward with its strategies to update its role in the Pearl River Delta – **and as Asia's world city** - we look at the globally pioneering approaches being implemented for the signature land, sea and air infrastructure to help its continuous evolution as a Smart City. How do high performance transportation hubs translate into high performance as a Smart City, and as a sustainable city?

SESSION CHAIR

Sylvester Timothy WONG, Vice President, Strategies + Development, Buildings + Places, Asia; Head of Buildings + Places, Philippines & Emerging Markets, AECOM, Philippines

SPEAKERS

1. Marc COLELLA
Industry Director, Building Structures Practice Lead, Australia and New Zealand, AECOM, Australia
2. Kevin POOLE
Executive Director, Third Runway, Airport Authority Hong Kong, Hong Kong SAR
3. Tony ARMSTRONG
Asia Pacific Representative, International WELL Building Institute

(3) Deep Energy Saving and Other Innovative Green Measures for Commercial Buildings in Hong Kong, Mainland China and Overseas Session Organiser: Swire Properties Ltd.

Session 2.7

SESSION OUTLINE

Electricity use in building remains the largest source of local carbon emission in Hong Kong, accounting up to 63% of the total emission. Enhancing energy efficiency in our new and existing building stocks becomes crucial to our **commitment in meeting Hong Kong's carbon target and also fulfilling both Hong Kong's Climate Action Plan 2030+ and Energy Saving Plan 2015-2025+**.

With Gross Floor Area of 27.2 million square feet, Swire Properties recognize the potential significant contribution it can make to our climate. It starts its energy saving journey as early as 2001 with firm determination, clear vision, professional knowledge, researches and use of design tools. It strives to achieve the committed targets at the outset through concerted efforts of the whole team at both design and operational stages.

In this parallel session, we deep dive into our long-term energy saving strategy and practice, ranging from high-level management system to day-to-day data analysis over building services systems in Hong Kong and mainland China. Our ten-year collaboration with Tsinghua University contributes to various successful energy efficient case study. The knowledge accumulated also join together with advanced technology and best practices brought up by top-tier consultancy firm to implement in our new building. These are also demonstrated by another case study in **Japan. Going beyond energy efficiency, the total package of 'multiple benefits' derived from green sustainable building will also be discussed.**

SESSION CHAIR

Benny AU, Sustainable Development Manager, Swire Properties Ltd., Hong Kong SAR

SPEAKERS AND PRESENTATION TOPICS

1. Sustainability Strategies on Deep Energy Saving and Energy Management of Property Developer
Raymond YAU, General Manager, Technical Services & Sustainable Development, Swire Properties Ltd.
2. Overview of Building Energy Efficiency in China and the Upcoming Trend
WEI Qingpeng, Building Energy Research Center, Tsinghua University, Beijing
(Paper title: Technical Innovation Developed from Ten-year Research and Practice Collaboration of Private Sector and Academia on Building Energy Efficiency)
3. Cost & Value: Multiple Benefits of Green Commercial Buildings in Western Countries
Phil JONES, Chair Architectural Science, Welsh School of Architecture, Cardiff University, United Kingdom;
Visiting Research Professor, Faculty of Architecture, University of Hong Kong, Hong Kong SAR
4. YKK80 High Efficiency Building - Radiant Control Both Outside and Inside
Kitaro MIZUIDE, General Manager, M&E Design Department of NIKKEN SEKKEI, Japan
5. Performance Synergy from Integrated Design, Construction and Operation. Case Study on a High Performance Grade A Office - Swire One Taikoo Place
Vincent CHENG, Director of Building Sustainability, Arup, Hong Kong SAR

Sustainability Strategies on Deep Energy Saving and Energy Management of Property Developer

Raymond YAU^a, Isaac TSANG^b, Harry LUK^c, Ting YAO^d

^a Swire Properties Limited, raymondyau@swireproperties.com

^b Swire Properties Limited, isaactsang@swireproperties.com

^c Swire Properties Limited, harryluk@swireproperties.com

^d Swire Properties Limited, yaoting@swireproperties.com

ABSTRACT

This paper presents the sustainability strategies on energy management implemented by a property developer, which achieved deep and continuous improvement in the period from 2001 to 2015. It aimed for reducing electricity consumption across their portfolios in Hong Kong over the years, and strategically established a comprehensive **energy database for monitoring and analysing the energy data**. This “**Knowledge-based energy management**” involved the collecting, analysis of operating data and turning them into information for determining strategies to enhance the operation efficiencies of their plant and equipment. It also involved the carrying out of practical researches through both in-house efforts and collaboration with universities and equipment manufacturers.

With a sufficient understanding of energy use and building performance, ambitious energy targets were set. Energy management opportunities (EMOs) were then identified and implemented systematically. This amounted to a 16% reduction in electricity energy consumption despite a 16% increase in gross floor area from 2001 to 2015. Three key issues will be discussed in this paper including database establishment, energy improvement practices and **energy efficiency research**. It is concluded that the “**Knowledge-based energy management**” strategy has potential to be success industry-wide.

Keywords: sustainability strategies, knowledge-based energy management, energy saving

1. INTRODUCTION

Hong Kong is one of the high density financial and commercial cities in the world. As much of our activities take place indoors, buildings consume substantial amount of energy. In 2013, over 92% of electricity generation was consumed by these buildings and around 66% of it was contributed by commercial sector (Hong Kong Energy End-use Data 2015). To cope with the energy saving plan of HKSAR (i.e. reduce energy intensity by 40% by 2025 using 2005 as the base) (Energy Saving Plan, 2015) and implement low-carbon living and working style, contribution from the commercial sector is important.

Nowadays, commercial buildings are always better managed. The control of major building services installations like, heating and ventilation air-conditioning (HVAC) system, electrical distribution system, lighting system, lift and escalator system are normally integrated into the building management system (BMS) to facilitate daily operation. Developers are more willing to invest as it can increase their rental income and reputation. Nevertheless, operators of the building tend to focus in routine operation and prevention of equipment breakdown instead of operation efficiencies. They are conservative and prefer replacing inefficient building services installation until the end of their equipment life. This case study investigated a developer in Hong Kong, who works in another way and their energy saving journey showcased the success of transforming routine operation into a Knowledge-based management and strategy.

2. CASE STUDY

2.1 Background of the case

This case study is a developer established in 1970s in Hong Kong. It owns and manages office, retail, hotel and residential properties, with a focus on mixed use developments in prime, accessible locations across Hong Kong, Mainland China and the United States. Up to 2015, they have investment properties (office, retail and hotel) of over 2.72 million square meters (Annual Report, 2015).

Since 2001, this developer have worked to reduce electricity use, by monitoring and analysing data collected and stored in a comprehensive energy database, setting energy efficiency targets and developing strategies and actions to meet these targets. Up to 2015, over 37 million kWh energy consumption was reduced despite there was increase in portfolios size. In percentage, this amounted to a 16% reduction in electricity energy consumption despite a 16% increase in gross floor area from 2001 to 2015. By implementing knowledge-based energy management and continuously evaluating their operation, they set an ambitious target for 2020 of reducing annual energy consumption by 64 million kWh electricity (26%) compared with 2008 baseline (Annual Report, 2015).

What makes their operation efficiencies and energy management different is that they act on information and researches; collaborate with academia to sustain their initiatives; actively influence their stakeholders and make their energy performance transparent through the yearly sustainable development (SD) reporting and carbon disclosure project.

Their energy improvement journey can be described in 3 stages:

- Establishment of database and using extensive operating data to monitor building performance from early 2000's
- Develop Knowledge-based energy management system, reduction plan and influencing others from 2006
- Carry out practical researches, collaborate with universities and put newly discovered measures into practice from 2010

2.2 Methodologies

2.2.1 From dataset to knowledge-based

It has been long in the building industry that building operation data collected with the BMS are not fully utilized. Indeed, these data are extremely useful in analysing the building performance, especially in energy management and evaluate system efficiencies.

The reasons they are not used are that most of them are raw data, lack of housekeeping or even not properly **logged**. And it is extremely difficult to analyse such "big data" without technical expertise and systematic management. To begin with, this developer started to build up a high level energy database from 2001. By means of simple utility bills and analysis tools, the energy data, in correlation with other parameters such as occupancy level and outdoor temperature, are transformed into valuable information. It is extremely useful as it can give the management a full picture of how the energy is utilized throughout the years (Figure 1).

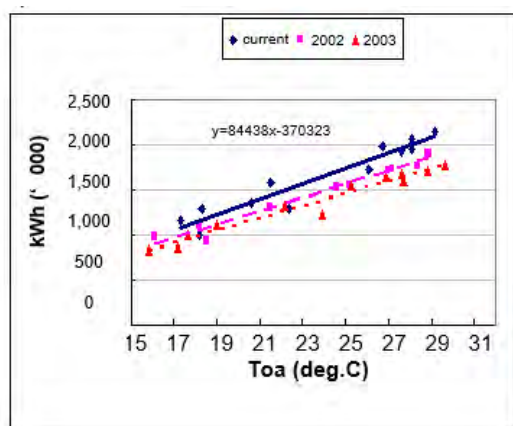

Figure 1: Energy database with correlation with outdoor air temperatures (TOA)

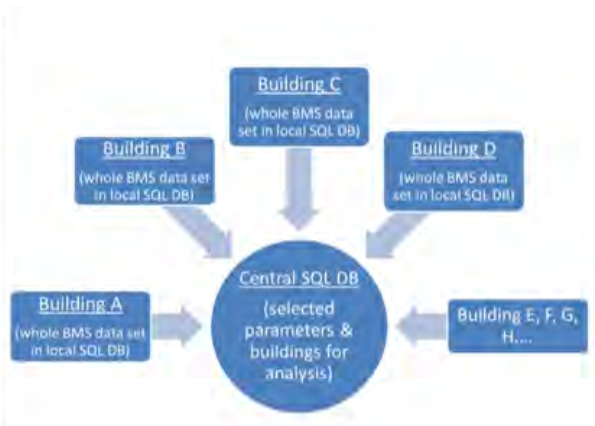

Figure 2: Strategy in logging BMS data in SQL DB

Besides energy data, BMS hourly operating data like, supply and return temperatures, flow rates, damper and valve positions can also provide a lot of information in the characteristics, performances and efficiencies of different building services installation. However, the data amount and network requirement can be enormous that BMS network may not able to cater. In 2005, the developer started to collaborate with BMS vendors in establishing hardware and software strategies and investigating the technology breakthrough in building individual BMS logging database. Instead of tradition csv, text or excel files, they explored a way to use Structured Query Language (SQL) database (DB) that is optimized for large data storage and prompt data retrieval. Individual and central databases

were built to mitigate the network loading and prioritize frequent analysing data. Figure 2 is a diagram showing the strategy on how to manage the large amount of monitoring data from individual buildings.

With the aid of energy and BMS databases above, energy consumption and system performance are easily keep tracked and analysed. Management would be easy to establish energy baseline and improvement plan for upcoming years. Measurement and verification methods can also be developed for verifying the success of initiatives by means of the data.

2.2.2 From knowledge to internal and external energy strategy

Establish targets and strategies internally

By reviewing the extensive operating data in a systematic way, raw data are transformed into information and knowledge. Improvement opportunities could be identified through the regular equipment performance monitoring. For instance, the chiller control optimization was identified based on the analyses of chilled water / condenser side water supply and return temperatures and electricity power consumption; VAV system static pressure reset was reviewed based on the statistic of VAV boxes damper position. A series of methodology for practical use of operating data was thus developed such as, energy performance analysis in chiller performance and chilled water system (Yu and Chan, 2012), feasibility study in conversion of cooling tower, VSD chillers, duct static pressure reset (Zhang et al., 2015), automatic tube cleaning system and chilled water differential pressure reset (Xuefeng et al., 2015). Those operating information not only give simple performance evaluation, but also facilitate management decision on operation optimization as well as replacement investment. Figure 3 showed a chiller performance analysis using year round operating data and design figures from the manufacturer, to justify whether the chiller should be replaced.

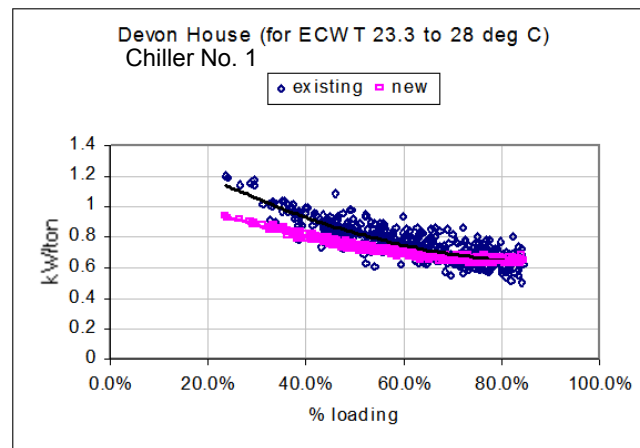

Figure 3: Strategy in logging BMS data in SQL DB

Instead of relying advices from energy consultant or equipment manufacturer, self-studies with actual site operating data provide more objective findings. Figure 4 is a road map showing the energy analysis they have been carried out in past years. Sometimes, it can speed up energy saving opportunities and bring out new initiatives as data are readily on hand for in-depth analysis. More importantly, the effectiveness of energy saving opportunities and new initiatives can be closely monitored. Detailed measurement and verification (M&V) can be done to verify the saving and summarize the pros and cons of different measures for future implementation.

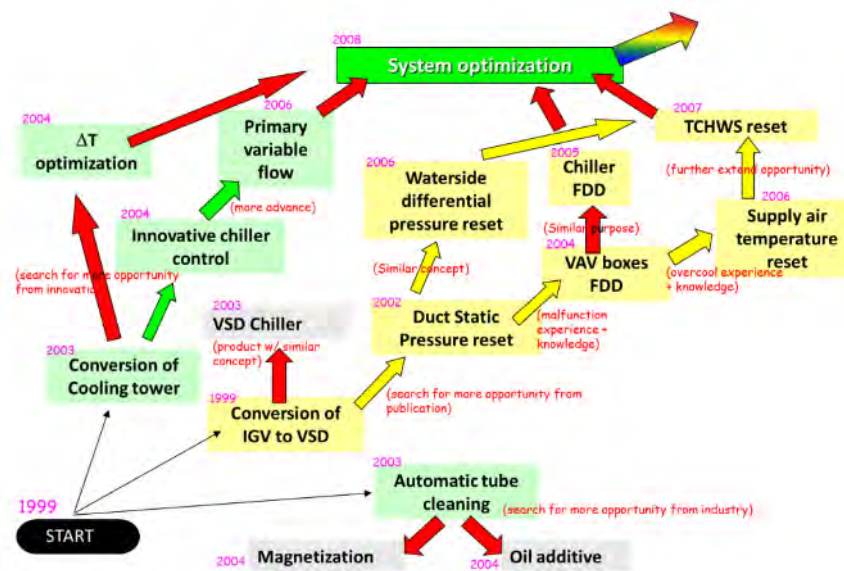

Figure 4: Road map of energy analysis in past years

Readiness of data also helps in other ways, e.g. meeting local energy codes, acquiring international recognition (e.g. BEC2012, ISO 50001), professional awards and developing reduction plan. Long before the implementation of mandatory energy audit initiated by Hong Kong government in 2012, the developer was able to carry out similar audits from 2010 and establish an ambitious energy plan, i.e. target for 64 million kWh electricity saving a year (26%) by 2020 for Hong Kong portfolio with 2008 as the baseline.

Benchmarking with others globally

In addition to internal target, it is also good to a company to step up to the industry globally. In 2006, the developer spearheaded a 'Best-in-class' exercise to benchmark and share best practices with peer companies in the USA, Australia, the UK, Singapore and Hong Kong. The objectives were to understand the practices adopted by industry leaders and ways to enhance each participant's performance through sharing of knowledge. The developer did not only manage their own consumptions but more importantly influenced others and facilitated other owners to reduce carbon emission.

Influencing stakeholder and the society

Success of sustainability is building on the cooperation with all stakeholders. Instead of own long-term energy reduction target, initiatives should also extend to stakeholders by various programs like tenant engagement.

Electricity consumption of tenants accounts for over 40% of the total consumption of a typical office building in Hong Kong (Annual Report, 2015). Management companies, indeed, can play an active role to encourage energy saving in the tenant side.

In this case, free energy audit was provided to the tenant. They started to carry out free energy audits for its office tenants and explore improvement opportunities in their premises. According to the information collected, about **44% of their office areas had been audited and the tenants' power intensity has been reduced by 35% from 2009 to 2015** (Figure 5).

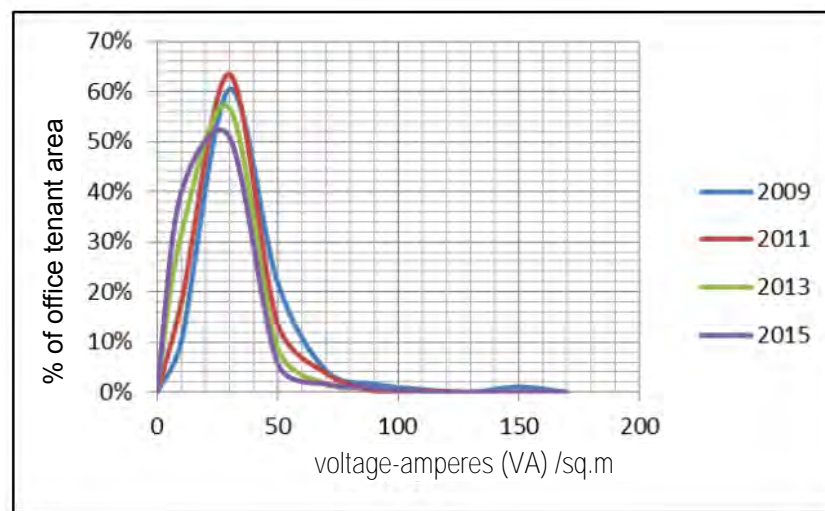

Figure 5: Reduction on tenant's power intensity from 2009 to 2015

Furthermore, increasing energy conservation awareness among own staff and tenants through targeted campaign can help decrease the cooling demand in office and retail portfolios, and thus further reducing the total building **energy consumption**. For example, the developer implements "Green Pledge" with tenants to apply a series of green initiatives that help improve the environmental performance of their office premises, encourages the tenants in shopping malls to join the Green Shop Alliance that join forces to promote green shopping practices by putting forward the green initiatives.

2.2.3 From experience to action research and new initiatives

Technology comes in steps. In the past, energy reduction can be easily achieved by chiller and LED replacement. However, it is making difficult in further saving if there is no major breakthrough in technology advancement. Though developers can make a different step, they can partner with universities as they have valuable experience and operating data to share. In this case, the developer demonstrated a good movement as they have established a joint research centre with an international grade national university, Tsinghua University, to carry out researches on optimization of plant efficiencies of existing buildings. Operating buildings can be used as living laboratories for testing pilot initiatives in energy efficiency improvement and to put newly discovered measures into practice.

Academia can involve at various phases of development to help optimize energy efficiency through the life cycle of buildings also, e.g. integrated design at planning and testing and commissioning stages and monitoring based commissioning in operating stages. This kind of collaboration can result in substantial energy savings, and also help influence and share new knowledge with colleagues, partners, industry peers and researchers about new building technologies and management processes.

Moreover, we can partner with equipment vendor. Synergy can be found when building owner, suppliers and academia are pull together. With the technical support from equipment manufacturer, operating experience from building owner and in-depth analysis from universities, new energy initiative and control algorithm can be discovered and refined. For instance, the developer developed a fault detection and diagnosis (FDD) program of VAV terminals with Hunan University and Honeywell Limited and won the ASHRAE Technology Award in 2013.

3. DISCUSSION

In previous sections, we have identified different aspects in forming a sustainable energy strategy. That included the development of database and knowledge, establishment of internal and external strategies and partnering with equipment vendors and academia.

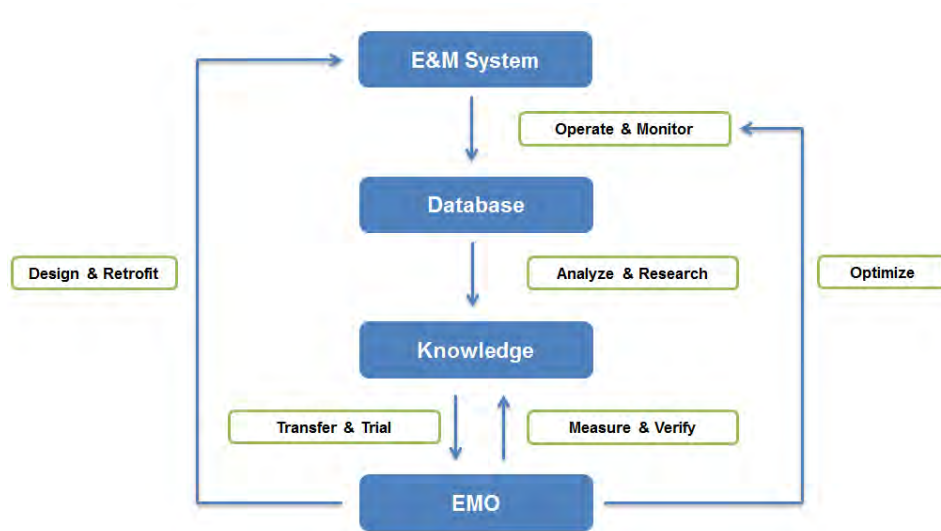

Figure 6: Process of knowledge-based management

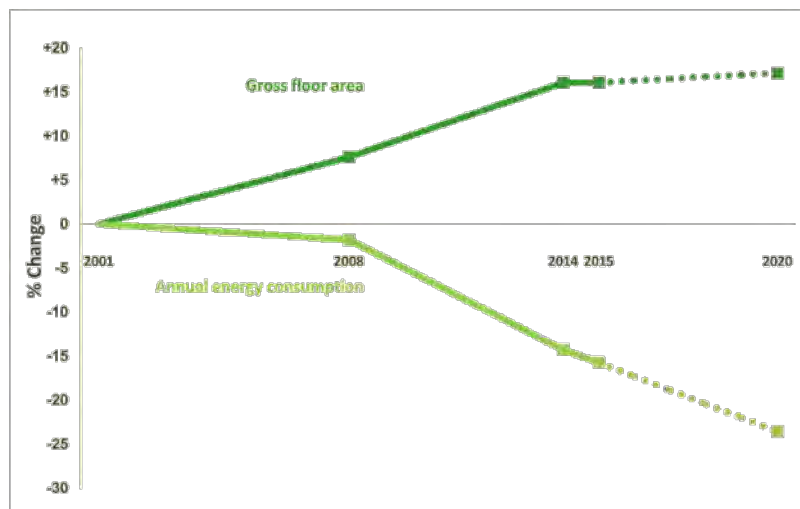

Figure 7: Energy saving trend and projection of the developer from 2001 to 2020

The main concept of this idea is Knowledge-based management (Figure 6). First of all, build a database integrating the data collected from different electrical and mechanical (E&M) system. With simple data mining tools, data can be clustered into information and knowledge with a series of analysis and researches by professionals, engineers and operators. Individual initiative and strategy can then be set, including short term EMOs and long term reduction strategies. The implementation can be supported by manufacturer and academia as they have expertise in product design and installation. Performance is closely monitored by means of sensors afterwards and allowed benchmarking with others. Experiences and knowledge are accumulated throughout the processes. Figure 7 summarized the developer's energy reduction trend despite the increase of gross floor area from 2001 to 2015.

Difficulties in setting up the database and energy management system

Data from BMS and energy meters can be enormous. For instance, a 70-storey high grade A office buildings with VAV system and having area around 2,000 sq.m per floor, can have more than 40,000 BMS points and more than 100 energy meters installed in total. If data are logged in every 5-minute, there will be over 11 million data set per day. Data mining process can be exhaustive if they are not properly managed and analysed. At the same time, buildings that were built over 15 years ago may not have the capability to log such a large amount of data in terms of hardware and software provision. Moreover, owners may not invest in such infrastructure as there is no direct payback from them.

Nevertheless, prioritizing the BMS points to be logged and selecting the right logging interval may solve the problems. For instance, less frequent energy data is more critical than routine hourly operation data as energy data can provide clues in major energy use installation. Instead, operating data can be logged at designated interval and specific periods (e.g. a few weeks in summer and winter times) to mitigate the loading on the hardware and software infrastructure.

4. CONCLUSION

Apart from traditional operation and maintenance practices and preventative maintenance, Knowledge-based management could be another way in enhancing energy efficiency and forming energy management strategy. With the establishment of energy and operating databases, analysis could be carried out effectively. The operation data would be turned into valuable knowledge, and strategies and initiatives are then established which eventually enhance the building performance. Moreover, synergy and innovation could also be stimulated.

In conclusion, Knowledge-based management in sustainability strategies is viable and would be a new way out in energy management.

ACKNOWLEDGEMENTS

The case study presented in this paper was supported by Swire Properties Limited.

REFERENCES

- [1] Electrical and Mechanical Services Department, 2015. *Hong Kong Energy End-use Data 2015*. [pdf] Hong Kong: Electrical and Mechanical Service Department. Available at: <http://www.emsd.gov.hk/filemanager/en/content_762/HKEEUD2015.pdf> [Accessed September 2015]
- [2] Environment Bureau, 2015. *Energy Saving Plan*. [pdf] Hong Kong: Environment Bureau. Available at: <<http://www.enb.gov.hk/sites/default/files/pdf/EnergySavingPlanEn.pdf>> [Accessed May 2015]
- [3] Swire Properties Limited, 2015. *Annual report*. [online] Available at: <<http://ir.swireproperties.com/en/ir/reports/ar2015.pdf>> [Accessed May 2015].
- [4] Zhang, J., Li, X., Zhao, T., Yu, H., Chen, T., Liu, C. and Yang, X. (2015) 'A review of static pressure reset control in variable air volume air condition system', *Procedia Engineering*, 121, pp. 1844–1850. doi: 10.1016/j.proeng.2015.09.165.
- [5] Xuefeng, L., Jinping, L., Zhitao, L., Kongzu, X. and Yuebang, M. (2015) 'Diversity of energy-saving control strategy for a parallel chilled water pump based on variable differential pressure control in an air-conditioning system', *Energy*, 88, pp. 718–733. doi: 10.1016/j.energy.2015.05.097.
- [6] Yu, F.W. and Chan, K.T. (2012) 'Chiller system performance benchmark by data envelopment analysis', *International Journal of Refrigeration*, 35(7), pp. 1815–1823. doi: 10.1016/j.ijrefrig.2012.07.003.

Technical Innovation Developed from Ten-year Research and Practice Collaboration of Private Sector and Academia on Building Energy Efficiency

WEI Qingpeng^a, Raymond YAU^b, WU YL^c, Jean QIN^d

^a Building Energy Research Center, Tsinghua University, Beijing, qpwei@tsinghua.edu.cn

^b Swire Properties Ltd., raymondyau@swireproperties.com

^c Swire Properties Ltd., ylwu@swireproperties.com

^d Swire Properties Ltd., jeanqin@swireproperties.com

ABSTRACT

The paper presents fruitful results from ten-year collaborative research and practice carried out by Tsinghua University – Swire Properties Joint Research Centre on energy efficiency in HVAC systems in large-scaled commercial buildings. Substantial savings were obtained through retro-commissioning on HVAC systems with the assistance of control performance modelling during the building operation. The optimization was achieved not only by conventional system re-balancing/fine-tuning, but also through innovative technologies like data-driven modelling of chillers. Hand-in-hand joint efforts of the academia and the industry consolidated practical guidelines of testing and commissioning (T&C), and a series of case studies for building energy efficiency.

The knowledge accumulated from the existing building study was also transferred to the new building design and construction processes to improve the whole life-cycle building sustainability. T&C was stressed during the whole process from the design stage of T&C provision, the construction stage of T&C specifications to the operation stage of performance tests. This paper shares the experiences of the building energy consumption target setting and control during the whole process of design, construction and operation, through the joint efforts of a private sector and a university.

Keywords: HVAC system, innovative technology, energy saving, existing building, new building

1. INTRODUCTION

The buildings sector consumes about one-third of world energy and associates with almost one-third of global carbon dioxide (CO₂) emissions. Energy efficiency in buildings was well recognized as an important approach to alleviate global warming and to achieve a sustainable future. However, a recent-published IEA report shows that building energy use has risen nearly 20% since 2000 although significant efforts on policy was adopted in recent years to improve building energy efficiency. Thus, the multiple-discipline joint-efforts may offer an alternative solution to industry and government on this crucial topic.

The collaboration of a private sector and the academia on building energy efficiency has been continued for ten years taking the real operating buildings as the living laboratories. The relationship started as the pilot study in 2007 and further developed to Tsinghua University – Swire Properties Joint Research Center for Building Energy Efficiency and Sustainability in 2011.

As the pioneer and leader in green building design and management with a long history on continuous improvement, the private sector is committed to incorporate environmental sustainability principles and practices throughout the business operations with long term goals and action plans.

The joint efforts not only fulfilled significant energy saving in the operating portfolio, but also demonstrated the increasing commitment on the real estate sustainable development and the influence to the industry by participated in the international research projects, i.e. IEA Annex 53, IEA Annex 66, and the US-China Clean Energy Research Center.

The field of this collaboration focuses on energy efficiency and sustainable built environment in commercial buildings, especially on Heating, Ventilation, and Air-Conditioning (HVAC) systems which dominate energy use in buildings. In this paper, the ten-year research and practice collaboration journey of the private sector and the

academia is presented. The innovative technologies developed from the real applications as well as deployed into the reality are introduced.

2. FROM OPERATIONAL DATA TO EVALUATION METRICS

The collaborative works initiated from HVAC system and Indoor Environment Quality (IEQ) data gathering for saving potential analysis. The metrics to evaluate system performance, which were standardized and applicable for all HVAC systems, had been developed based on the collected data.

2.1 Operational data gathering and analysis in existing buildings

The operation of condensing water pumps and cooling towers not only affects electricity consumption in condensing side, but also influences energy performance of chillers. A case study below demonstrates the performance evaluation methodology.

Based on the annual hourly records of chiller saturated condensing temperature (SCT), chiller condensing water leaving temperature (CDWLT) and entering temperature (CDWET), and the outdoor wet bulb temperature (WBT), the performance of condensing side can be evaluated by three temperature differentials (dT) as shown in Figure 1a to 1c.

The first considered temperature difference, dT_1 , refers the differential between SCT and CDWLT which reflects heat transfer performance of the condenser. For common fresh water cooled chillers, dT_1 should be maintained lower than 2K, otherwise the condensers should be cleaned for higher chiller efficiency, as shown in Figure 1a.

The second consideration, dT_2 , refers the differential between CDWLT and CDWET which is usually designed to around 5K. If the actual dT_2 is obvious higher or lower than 5K, problems may be hidden in the operation of condensing pumps. Figure 1b shows annual hourly measured dT_2 in the case. If dT_2 during the year are significant higher than 5K, the insufficient condensing water flow rate could be identified, which deteriorated the performance of the efficiency.

The last considered, dT_3 , refers the differential between CDWRT and WBT which reflects the heat and mass transfer performance of cooling towers. In this case all-year round measured dT_3 are shown in Figure 1c. It is obviously that dT_3 in off-peak season are much larger than that in peak summer time. Based on the measured data analysis, a cooling tower operation scheme was suggested to achieve a smaller dT_3 in the off-peak season, which resulted in higher chiller efficiency.

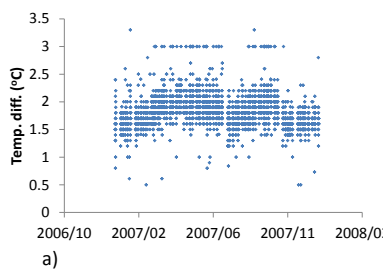

Figure 1a: dT_1

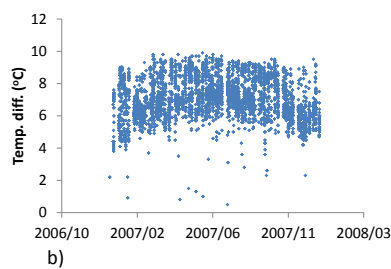

Figure 1b: dT_2

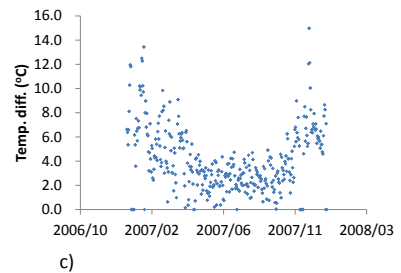

Figure 1c: dT_3 annual hourly measured data

2.2 Metrics to evaluation system energy performance

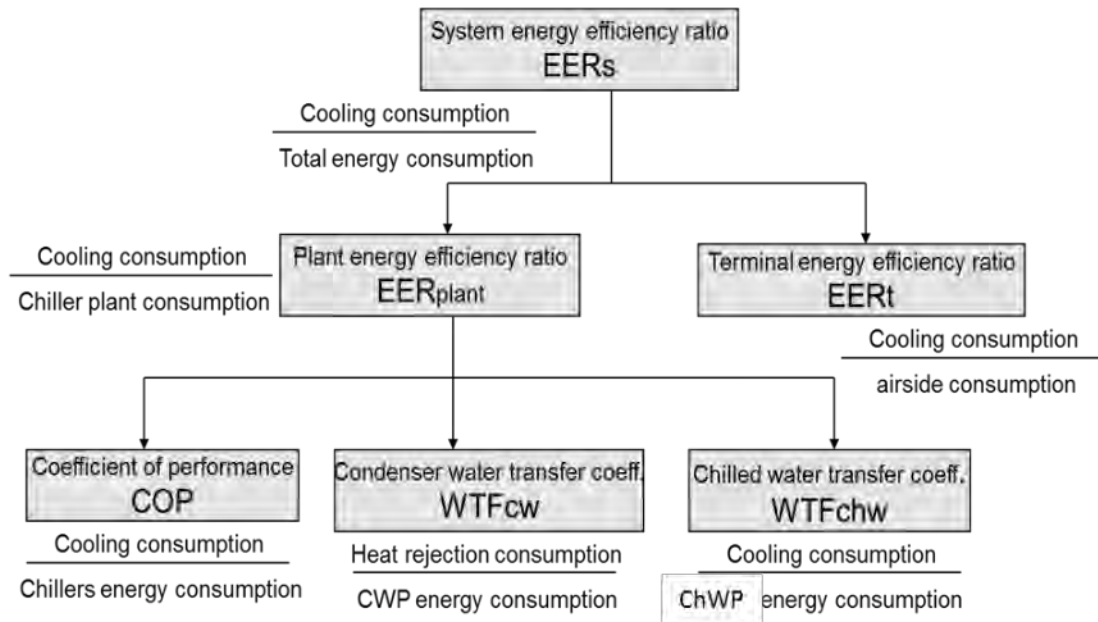

Figure 2: Key Performance Index (KPI) of HVAC system to evaluate energy performance of major systems / equipment based on measured operational data

The case studies of the existing buildings drew the conclusion that it is necessary to develop a systematic way to dig out energy saving potentials for built environment maintenance based on measured data. A standardized Key Performance Index (KPI) system was developed as the efficiencies of major systems / equipment in HVAC systems which can also be proposed for benchmarking, for target setting and control, as shown in Figure 2. Those metrics of efficiency can be compared with other similar systems on the apple-to-apple basis.

As shown in Figure 3, operational performance of 56 chiller plants were evaluated by the metrics and huge saving potentials in systems were figured out by the benchmarking.

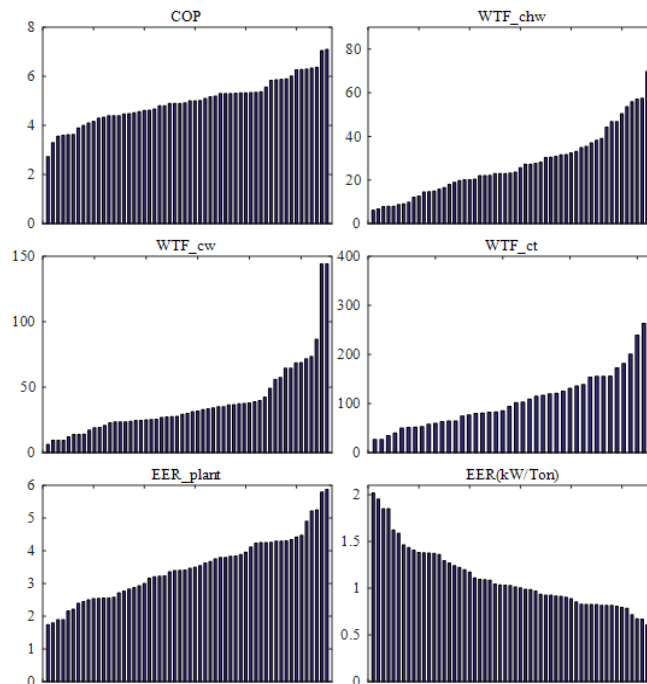

Figure 3: Benchmarking of 56 chiller plants through developed metrics on energy efficiency

3. FROM OPERATIONAL OBSERVATIONS TO MODELING AND ALGORITHM

The data-based evaluation on system performance disclosed significant saving potential on the operating systems in buildings. New methodology/technologies were also developed from the above exercises using the real buildings as the living laboratories for testing pilot initiatives on energy efficiency analysis and improvement. Fundamental studies were carried out including modelling and simulation and fine-tuned during the application of the algorithm for control to realize actual energy savings and efficiency improvement.

3.1 Concise graphic - Analytic method for chilled water system characteristics analysis

The phenomenon of “large flow – small ΔT ” is always found in variable flow chilled water systems. A concise graphic-analytic method is introduced for the analysis on the overall performance characteristics of a group of cooling coils and identifying the probable problems.

The method uses the ideal curve of the relative cooling load vs. the relative flow rate as the baseline for the analysis. The cooling load imbalance and the hydraulic imbalance are analysed for their impacts on “large flow – small ΔT ” phenomenon, which presents “collapse” in the performance curve.

Cooling load imbalance analysis

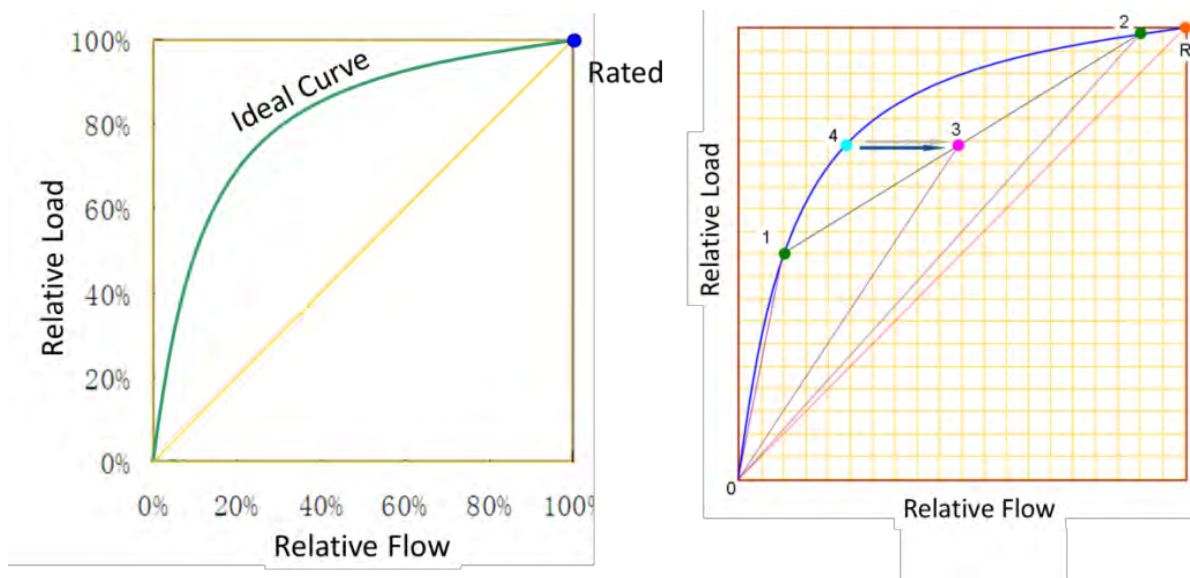

Figure 4: Cooling load imbalance analysis

If the two identical coils are working under different loads as “Point 1” and “Point 2” in Figure 4, the overall system operating condition is “Point 3”, which deviates from the ideal curve.

Hydraulic Imbalance Analysis

For the two identical coils, the control valve of one coil is faulty and fully open while the relevant air-side system is switched off. The other coil is under normal operation with the operating curve of “061R”. The overall system characteristic would be “543” (Figure 5a). If the malfunctioning valve is partially open, the system curve would be “5’4’3”.

If the two identical coils are in operation, one is under normal control, the control valve of the other coil is faulty and fully open. The overall operating curve would be shifted to “53R” (Figure 5b).

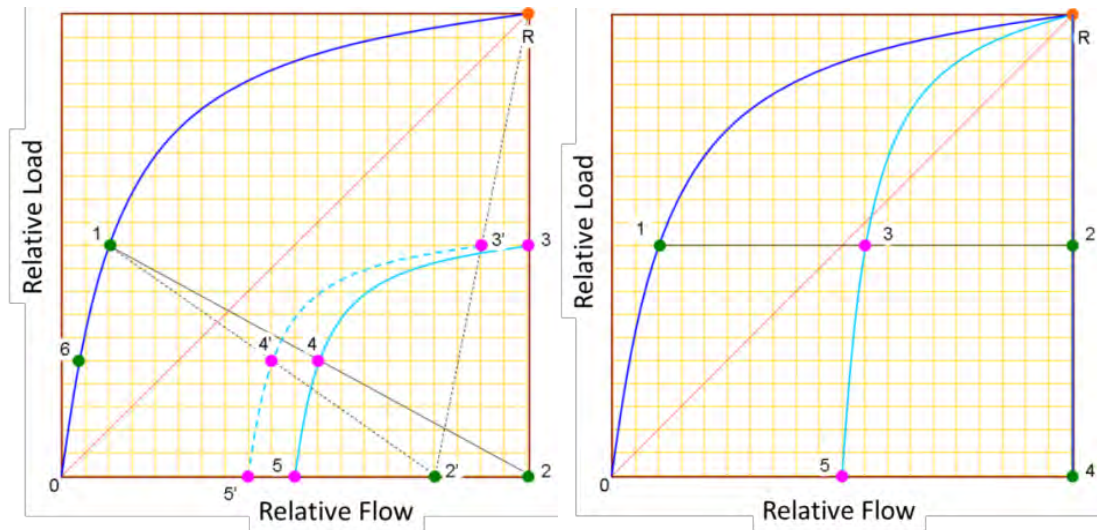

Figure 5a

Figure 5b

Figure 5: Hydraulic imbalance analysis

3.2 Data-driven modelling of chiller

Chillers are the most energy consuming equipment in HVAC system. As the development of chiller technology, the rated efficiency of large scale centrifugal chillers or screw chillers is high. However, the chiller operating conditions always deviated from the rated point and lead to significant energy waste. Thus, it is important to continuously monitor the chiller operating points and make necessary optimization or retrofiting to improve the operating efficiency.

The chiller efficiency can be represented by the thermodynamic perfection of the cycle, which is defined in Equation 1. It illustrates deviation of operational COP, as defined in Equation 2, to the best condition which follows the reversed Carnot cycle as shown in Equation 3. The modeling is a typical data-driven type since all the parameters of the model can be measured directly from real operating system.

$$\gamma = COP / ICOP$$

Equation 1

$$COP = q / W$$

Equation 2

$$ICOP = T_{ev} / (T_{co} - T_{ev})$$

Equation 3

In above equations, γ is the thermodynamic perfectness, COP is the coefficient of performance, ICOP is the COP in the reversed Carnot cycle, q is the cooling energy produced (kW), W is compressor power (kW) and T is temperature in Kelvin. Subscripts ev and co represent evaporating and condensing respectively.

For constant speed chillers, the main influencing factors to the thermodynamic perfection are compressing pressure differential between evaporation and condensation, as well as the refrigerant mass flow rate. The former one can be represented by the differential between saturated evaporating temperature and saturated condensing temperature, expressed as $dT_{ev,co}$. The latter one can be approximately substituted by partial load ratio (PLR), which is the ratio of actual cooling output to rated cooling capacity.

The hourly operating data of chillers are shown in Figure 6. It was found that the running points of the chillers were far from the rated point, shown as the star in the Figure. It can be seen that the chiller thermodynamic perfection is quite low during most operation conditions. New chillers with relative smaller compression ratio were selected to replace the existing ones to make actual operation points closer to the rated point. Millions of kWh electricity savings were accomplished from this proper chiller replacement since the modeling and measured data played the important roles in this case.

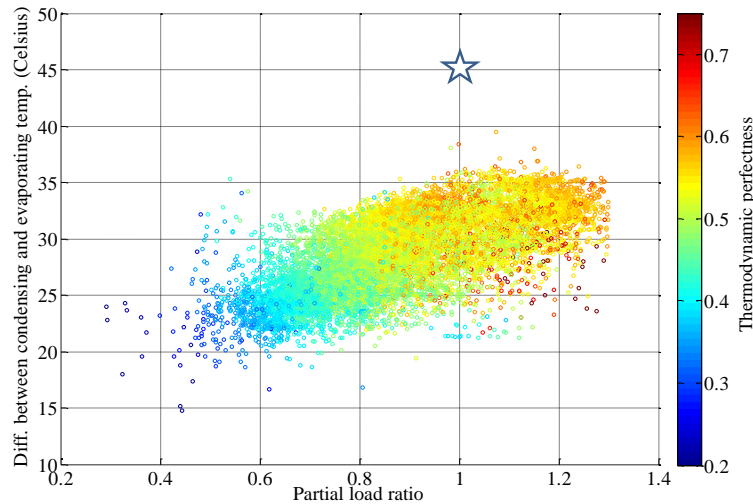

Figure 6: Chiller thermodynamic perfectness map with hourly measured data during a year

4. FROM OPERATIONAL EXPERIENCES TO DESIGN CRITERIA

Integrated Design Approach (IDA) is a concept where consideration of environmental performance of the development is placed at the start of a project and the objectives are to be met by the concerted effort of the development team. The knowledge accumulated from the existing building study was also transferred to the new building design and construction processes to improve the whole life-cycle building sustainability.

4.1 Solving oversized capacity problems

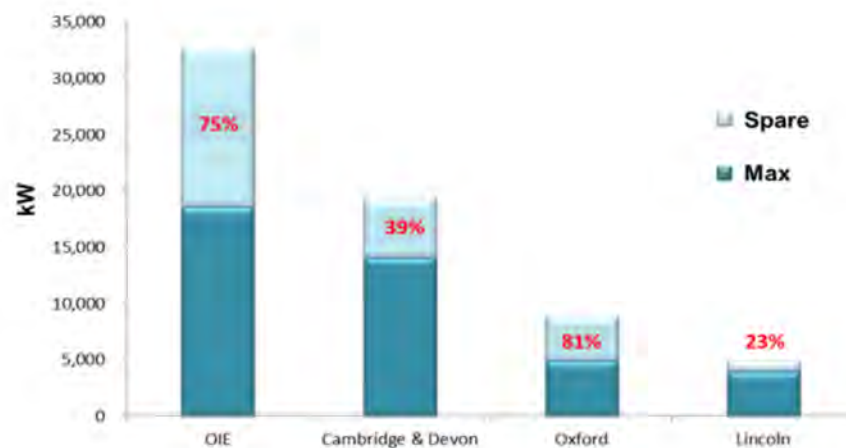

Figure 7: Oversized chiller plants

Oversizing of plant and equipment is a very common issue within the building industry. The result indicated the amount of oversizing ranges from 23% to 81% after a survey on several commercial buildings (Figure 7). The problem of oversizing increases the capital cost and sacrifices the system energy performance.

Variable speed drives can't solve the problem of oversizing. Although the variable speed drives can maintain a reasonably high efficiency during some part load conditions, the control range would be narrowed and the equipment would run at low efficiency if the loading is too low and has exceeded the turn down ratio limit.

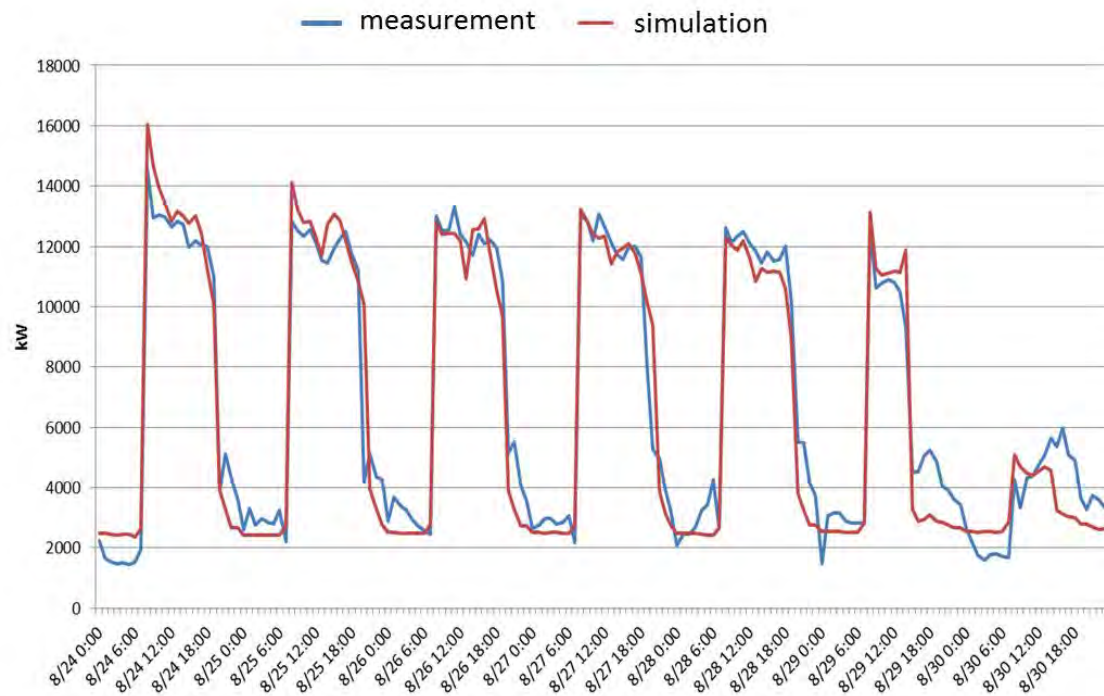

Figure 8: Calibrated simulation

Oversizing starts from load calculations which are done by computer simulation. The design input parameters are usually based on handbooks and local code of practices, which usually differ from the real situation. With the reference to the data collected as the input parameters, the simulation exercise showed that the estimated cooling load is much closer to the real demand (Figure 8). The database of the existing buildings would play the more active role for new building design. Further research works should be carried out on how to choose more realistic design parameters based on the operating data.

4.2 Detailed design for T&C and operation

In system design and equipment selection, part load efficiency should be addressed as the most important issue. The equipment should have the capacity to cater for a wide range of loading while maintaining the high efficiency. This can be achieved through the use of multiple units with different capacities and selecting of equipment with the right operating range and part load characteristics.

System efficiency should also be evaluated together with the current operating practices taking into account the control robustness. Too complicated control logics depending on multiple sensors would not be a good solution as multiple soft sensor errors are always difficult to be identified. To evaluate the system performance, sufficient provision of sensors/gauges/testing points is recommended. The guidelines of sensors/gauges/testing points provision need to be worked out with the detailed specifications.

Testing and commissioning (T&C) is the critical procedure to put the designed system to the real operation. Performance tests of major systems/equipment are standardized by the joint-efforts. The performance tests methodology and the relevant standard forms are developed for chillers, pumps, cooling towers, air handling units, primary air units, water balance, air balance, VAV systems and water-side system resistance analysis.

4.3 Publications and workshops

The Joint Research Center published a book entitled <The Analysis on Common Disputed Technical Topics for Building Energy Efficiency> (Figure 9) in August 2015. This co-publication, which is available in selected bookstores in Mainland China, presents six technical cases and explains the related concepts of integrated design and whole-process management, a system that enables commercial developers on energy efficiency throughout the building development process.

The six technical cases were summarized by the two parties together with their own opinions/methodology developed from accumulated practical experiences as well as the in-depth research works. In each case, the common misunderstanding areas were pointed out and clarified with detailed analysis.



Figure 9: Publications

The plant study case was also cited as a showcase in <2014 Annual Report on The Development of Building Energy Efficiency in China> (Figure 9), and it was the second time since 2010 (Figure 9) the joint-effort of energy performance and best practices adopted was recognised.

In past years, workshops sharing experiences from the Joint Research Center were held every year in Beijing and/or Hong Kong. The research and practice collaboration pushed the boundaries of building energy research to the application and developed new benchmarks in building energy efficiency and sustainability. The platform also helps sharing with the industry peers and researchers about new building technologies and management processes related to achieving greater energy efficiency.

5. FURTHER COLLABORATION AND CHALLENGES

In the future phase of this collaboration project, one of the focuses is to build an Energy Management System (EMS) for the company's commercial buildings across Hong Kong and Mainland China. The EMS will allow real-time remote monitoring of the buildings' electricity consumption data. Both parties are expected to work hand-in-hand to optimize the structure of EMS and to investigate potential energy saving opportunities through the on-line system by built-in expert rules.

EMS had been developed by some developers with different features based on their particular needs. However, the data quality and data utilization are still facing big challenges.

The information management functions of BMS are also planned to be used for monitoring-based commissioning. The accumulated knowledge would be incorporated to develop the online fault detection and diagnosis (FDD) strategies as the existing BMS may not suit our demand. The joint-efforts are necessary to put this forward successfully.

ACKNOWLEDGMENTS

The research works presented in this paper were under Tsinghua University – Swire Properties Joint Research Center for Building Energy Efficiency and Sustainability. The authors would like to express our thanks to Swire Properties Ltd.

REFERENCES

- [1] Building Energy Use in China: Transforming Construction and Influencing on Consumption to 2050, IEA, 2015
- [2] <http://www.swireproperties.com/en/sustainability.aspx>
- [3] IEA Annex 53 <http://www.iea-ebc.org/index.php?id=141>
- [4] IEA Annex 66 <http://www.iea-ebc.org/projects/ongoing-projects/ebc-annex-66/>
- [5] US – China Clean Energy Research Center <http://www.us-china-cerc.org/>
- [6] **Yiming Feng, Cheng Chang and Qingpeng Wei** “Ongoing Commissioning Based on BMS Data Logs”, ASHRAE Transactions Vol. 118, Issue 1, 2012, P301-308.
- [7] Cary Chan, Towards Zero Carbon Building – Bridging the Performance Gap, World Sustainable Building Conference, 2014, Barcelona, Spain
- [8] <The Analysis on Common Disputed Technical Topics for Building Energy Efficiency>, 2015, published by Tsinghua University – Swire Properties Joint Research Centre for Building Energy Efficiency and Sustainability
- [9] <2010 Annual Report on The Development of Building Energy Efficiency in China >

Cost & Value: Multiple Benefits of Green Commercial Buildings in Western Countries

Phil JONES^a

^a Welsh School of Architecture, Cardiff University, United Kingdom; Faculty of Architecture, University of Hong Kong, Hong Kong SAR, jonesp@cardiff.ac.uk

ABSTRACT

This chapter reviews the cost of green buildings, together with their quantifiable and qualitative added value. It reviews energy costs in relation to other benefits of green building design and retrofit, at building, community and national scales. Where data is available it presents cost benefits and also discusses benefits of a more qualitative nature.

Keywords: green buildings, energy, cost and value

1. INTRODUCTION

It is widely accepted that a green and more sustainable building will provide added value to its owners and occupiers, justifying any cost increase incurred in its design and construction. However, it has been difficult to attach an actual financial value to the benefits of green buildings, to assess whether they are more attractive to tenants and occupiers, and, the extent to which they attract a financial premium in terms of any increased rental and sales value. Generally, the main recognized quantifiable return on an investment in green design has been the energy savings, and even this is often uncertain in relation to the finished building, and how its users operate it. However, there is the potential for multiple benefits arising from green buildings, in addition to the actual energy savings. The IEA report, 'Spreading the net: the multiple benefits of energy efficiency improvements', published in 2012 (Ryan and Campbell, 2012), recognizes the wider benefits of 'clean energy' projects, which in addition to being of direct benefit to the individual or organization implementing the project, also has benefits for both national and global economies. However, such 'non-market' and socio-economic benefits are often difficult to quantify. Projects are often assessed by energy professionals, with little experience of how energy efficiency might impact on other non-energy sectors. The report also recognized the "rebound effect", by which non-energy sector benefits may result in the predicted energy savings being less than expected. A report by the US IEA, 'Assessing the Multiple Benefits of Clean Energy' (Environmental Protection Agency, 2011) identified environmental and health benefits, and a broad range of economic benefits, as well as reducing stress on the energy system.

Green buildings using clean energy systems can also enjoy the wider economic and environmental benefits. Although currently not well understood, the potential added value of the total package of benefits can be considerable, and much greater than just the energy savings alone, though there also may be rebound effects as introduced above for clean energy systems in general. For example, a rebound effect through the take up of affordable warmth in houses that are designed or retrofitted to be more efficient to heat, which is a positive benefit.

On a life cycle cost basis, even allowing for any rebound effects, the energy savings alone should typically exceed any additional design and construction cost premiums, within a reasonable payback period. There may be increased costs associated with green buildings, especially retrofitting existing buildings to a greener standard. However, by adopting an integrative holistic design approach, these additional costs can be reduced, to an affordable level, and potentially to a level comparable with standard building costs for new build, and within acceptable budgets for retrofit. In addition to energy savings, operations and maintenance costs have the potential to be reduced, for example, through the use of less complex environmental systems for heating, cooling and ventilation.

Energy costs are generally small in comparison to overall business operating costs, which are usually dominated by staff costs. For commercial buildings, green design can lead to a better quality indoor environment, which can improve worker productivity, and occupant health and well-being. This can result in improved productivity 'bottom line' benefits for businesses. However, in spite of these potential benefits, the improved indoor environmental quality associated with green buildings has not generally been a priority in building design and construction.

Buildings that are not designed with sustainability credentials may in future be considered high risk, which might affect their rental income and future asset value, in turn affecting their return on investment. So, buildings with better sustainability credentials could enjoy increased marketability, and their asset value should increase over time. They should be able to more easily attract tenants and to command higher rents and resale prices, and as a result offer a greater overall yield on investment.

Future trends in building regulations to reduce carbon dioxide emissions have also become a concern to building owners, as regulations place greater emphasis on the existing building stock. Changing tenant requirements and investor risk screening may also affect the value of buildings that do not have green credentials. The indication is that in markets where green is becoming more main-stream, **there are emerging 'brown discounts', where buildings that are not green, may rent or sell for less.** There is therefore an increasing interest in retrofitting existing buildings. Therefore developing retrofit solutions for different building types, and new investment models to address financing retrofits, **are crucial to maintaining a building's future asset value.**

In summary, green and more sustainable buildings need not necessarily incur significant additional design and construction costs. Their impact scales up to national and global levels, for example, energy cost savings at building scale will result in reduced carbon dioxide emissions at a global scale. The benefits are both quantitative and qualitative, and in future, developers who do not provide green buildings, will potentially incur an investment risk, and reduced marketability. However, these factors and benefits, although having been identified over the last decade or more, have yet to make a marked penetration into the building construction and operation industry. When assessing the benefits of a green building, the main analysis is still generally based on cost of energy saving measures versus cost of energy savings.

This paper reviews the above cost and value benefits associated with green building design. It is based on a review of some of the emerging findings from research and practice, with the main focus on office buildings and housing. It contributes to the activities of the EU COST T1104 Action, Smart Energy Regions, which is exploring a regional approach to implementing low carbon policy into practice in the built environment.

2. COST AND VALUE

The additional cost of a green building relates to how much money is spent on the building compared to a non-green building. **If a 'bolt-on' approach is used, the costs are easily identified in relation to the additional 'bolt-on' items of construction or equipment. Such a 'bolt-on' approach tends to incur** relatively higher additional costs compared to a holistic and more integrative design approach, where costs may be reduced. **Where a more holistic approach is used, it can be difficult to assess costs precisely, as the additional 'green' technologies used in the building may be offset by reducing costs in other areas.** For example, the increased cost of a high performance façade may be offset by reduced costs for heating and cooling equipment. Also, a green feature may also be simultaneously used as a more traditional building element, for example, when a Photo Voltaic (PV) panel over a window can 'double up' as a shading device.

The value of a green building can be related to the overall return on the investment, which may be in quantitative terms, for example, energy saved, or, of a more qualitative nature, such as, improved quality of life, although such qualitative improvements can also result in cost benefits. Assessing payback on investment using a single cost parameter, such as the cost associated with energy savings, does not recognize the total value of a green building in use. Added value aspects might include multiple benefits, such as, for a commercial building: more satisfied occupants; longer tenancies and higher lease rates, reduced absenteeism and an overall higher asset value; future proofed and reduced risk of obsolescence; less need for refurbishment in the future; higher demand from institutional investors and satisfying corporate social responsibilities; and, lower operating and maintenance costs.

There is a growing body of evidence, which identifies increased costs and added value benefits for office buildings. It has been shown that, in general, the costs associated with green offices are often exaggerated, and their added value underplayed. **The World Green Building Council's report in 2013 (World Green Building Council, 2013),** based on a variety of building types in United States, United Kingdom, Australia, Singapore and Israel, summarised a range of benefits from adopting a green building approach, and stated that, whereas the increased design and construction costs associated with a new green building are perceived to be as high as 29%, the actual cost increases found in practice are less than 12.5%, and sometimes equal to, or even slightly less than, the costs of a standard building. Some ten years earlier Kats, et. al. published a report (Kats G, Leon A, & Adam B, 2003)

indicating that the additional costs of a green building were on average (from a sample of 33 buildings) around 2% and this could be repaid ten-fold over a twenty year lifetime through lower energy, water and waste costs, lower environmental and emissions costs, lower operations and maintenance costs, and savings from increased health and productivity. They reported increased productivity and health contributing 70% of the benefits, reduced operations and maintenance 16%, and energy savings 11%.

The increased costs for a green building may therefore often be over-estimated, whilst the additional value-added benefits are not always appreciated, and are generally underestimated, or not considered at all. Johnson Controls (Johnson Controls, 2012) reported a range of value-added benefits that green buildings exhibit, including: increased resale value (2-17%); increased rental rates (5.8-35%); higher occupancy rates (0.9-18%); lower operating expenses (30%); higher net operating income (5.9%); lower capitalization rates (50-55 basis points); and, productivity gains (4.8%).

A study by Davis Langdon (Davis Langdon, 2007) has also identified benefits for green building owners including: potential higher occupancy rates; higher future capital value; reduced risk of obsolescence; less need for refurbishment in the future; ability to command higher lease rates; higher demand from institutional investors; lower operating costs; mandatory for government tenants; lower tenant turnover; and, less cost to maintain and operate.

Further studies by RICS (RICS, 2005) identified green building benefits to: be quicker to secure tenants; command higher rents or prices; enjoy lower tenant turn over; cost less to operate and maintain; attract grants, subsidies and other inducements to do with environmental stewardship, increase energy efficiency and lessen greenhouse gas emissions; improve business productivity for occupants, affecting churn, renewals, inducements and fitting out costs; and, benefit occupants to an **extent that may even exceed the underlying asset's value.**

In 2010 Eichholtz et al (Eichholtz P, Kok N, & Quigley JM, 2010) reported a study of some 10,000 buildings indicating that there was an effective rental premium of around 7%, and selling premium of 16% for green office buildings in the US. Pivo and Fisher (Pivo G and Fisher JD, 2009) found that green buildings had up to 5.9% and 13.5% higher market values, driven by 9.8% lower utility bills, 4.8% higher rents, and 0.9% higher occupancy rates. A study by McGraw-Hill (MacGraw Hill 2013) looked into the payback period for green investments and operating costs. It was found that over a one-year and a five-year period, new green buildings were expected to reduce operating costs by 8% and 15% respectively, and by 9% and 13% for retrofits. The payback times were expected to be eight years for new green buildings and seven years for green retrofits. Building values were expected to increase by 7% and 5%, and asset values by 5% and 4%, for new build and retrofit respectively.

A recent study (Nils Kok and Avis Devine, 2015) showed that improved property performance is strongly correlated to green building certification. The research analysed ten years of financial performance data across a 58 million square feet office portfolio in the USA and Canada, indicating: net effective rents on 3.7 % higher in LEED certified properties, and 9.5% higher with ENERGY STAR certification in the U.S. compared to similar non-certified buildings, and 18.7% higher in Canadian buildings having both LEED and BOMA BEST certification; tenant renewal rates were 5.6% higher in Canadian buildings with BOMA BEST Level 3 certification than in buildings with no BOMA BEST certification; tenant satisfaction scores were 7% higher in Canadian buildings with BOMA BEST level 3 and 4 certification than in non-certified buildings; energy consumption per square foot was 14% lower in U.S. LEED certified properties than in buildings without certification.

However, although there are positive signs that green buildings attract higher value in the US, a study by RICS on London offices was not so positive (Chegut, P, Eichholtz, and N Kok, 2012.), and failed to identify improvements of significance.

The energy savings for new build may be related to three levels (table 1). The first is the level of energy reductions (also relating to carbon dioxide emission reductions) in relation to typical improvements in Building Regulations. In the UK typically there would be 25% carbon dioxide reductions between subsequent upgrades of building regulations, which may be every 4 to 5 years. These are considered relatively easy to achieve in an incremental way. The next level might relate to the best level of energy reductions associated with building environmental assessment methods, such as LEED and BREEAM, which are typically 40 to 50%. Finally savings relating to a PassiveHaus level of performance would be of the order of 75%, the remaining 25% potentially provided by renewables, creating a carbon neutral building. Actual energy use will vary with building type and location, but

ballpark average levels (UK) might be 200kWh/m² per year for housing, and 360kWh/m² per year for offices, with average energy costs of £12/m² per year and £25/m² per year respectively.

Level	% savings	Description
1	25	Building regulation improvements
2	40-50	High LEED BREEAM
3	75	PassiveHaus

Table 1: Levels of energy savings

Retrofitting existing offices can yield similar benefits as new build. A US study (Pacific Northwest National Laboratory, 2011) has identified three levels of approach to office retrofit: (i) commissioning, which can typically achieve up to 25% energy savings. An example from a US study of commissioning projects found that office **buildings typically realised 22% energy savings through existing building commissioning, with an average simple payback period of 1.1 years** (Evan Mills, 2009); (ii) standard retrofit, which can typically produce 25-45% savings with payback period of less than 4 years. Such retrofits generally adopt a cost-effective low risk approach, typically using a package of component-level replacements of existing equipment; (iii) Deep retrofits, which are based on an integrated whole-building approach to energy savings projects. Savings of 45% and higher, with a typical payback period of up to 3 years, are achievable when upgrades to the building envelope are combined with retrofits of lighting and mechanical systems. In order to achieve a good performance for a building in use, it is essential to provide a high level of commissioning, and operations and maintenance. The report identified a range of benefits from improved operations and maintenance, including: energy savings; reduced comfort complaints; equipment that operates adequately until the end of its planned useful life, or beyond; improved indoor environmental quality; safe working conditions for building operating staff. It identified energy costs typically constituting 30% of overall operating costs, leading to a substantially increased net operating income and asset value.

The above discussion has focussed on a green approach to commercial buildings, covering both new build and retrofit. For housing, the increased costs associated with new build together with value added benefits, cover a similar range as for offices. However, whereas a component approach to retrofit can be affordable, though perhaps **limited in benefits, 'deep' retrofits** are generally currently considered high cost, and difficult to finance. In the UK, homes account for more than 28% of total UK energy use, with related carbon emissions (based on 2009 Figures). In the UK, the rate of new build for housing in a year is around 120,000, of a total housing stock of around 27 million, which is a renewal rate of around 0.5% per year. It is expected that 80% of existing dwellings will still be in use in 2050, so housing retrofit is a major area for saving energy and reducing carbon dioxide emissions. A large demonstration programme of housing retrofit was carried out in the UK between 2010 and 2012. Reported results from this programme (M Baeli, 2013) indicated that energy saving measures from deep retrofit schemes could produce on average around 63% energy reduction with most cases in the range 50% to 85%, and for an average cost of around £77,000, from a range of about £45,000 to £118,000. In addition, for most cases between £42,000 to £100,000 was spent on non-energy saving improvements. Clearly these costs are high in relation to potential payback. However, there are indications that costs can be reduced, and if combined with value-added benefits, can sometimes make deep retrofits financially acceptable. This will be discussed later, with to recent case studies.

3. ENVIRONMENTAL ASSESSMENT METHODS

Green' labels are often used to assess the green credentials of a building. A range of Environmental Assessment Methods are now available to apply to buildings in order to assess their performance during design. They include BREEAM (UK) and LEED (US), and they address a range of design aspects, such as indoor environment, material use, location, etc, as well as energy performance. There have been studies to assess the cost of achieving a high assessment rating and the return on the investment. The cost increase associated with majority of certified green buildings typically ranges from <0% to 4%. Higher levels of certification (such as BREEAM Very Good and LEED Silver/Gold) have been shown to have a cost increase in the range from 0% to 10%. Highest levels, such as BREEAM Excellent and LEED Platinum have increased costs of around 2% to 12.5%.

A review of ENERGY STAR and LEED projects (J Jackson, 2009) has identified rent and occupancy premiums that not only pay for the additional green development costs, but also provide an attractive internal rate of return (IRR) on green investments, for an incremental cost of between 1 and 5%.

David Langdon (Davis Langdon, 2007) has indicated from their research in Australia that the initial impact on construction costs (compared to non-Green projects) is likely to be in the order of 3 – 5% for a 5 Star solution, with a further 5% plus for a 6 Star non-iconic design solutions.

A review of recent studies has found that office buildings with green certifications command between around 2 to 27% higher rents than otherwise comparable buildings (Appraisal Institute and the Institute for Market Transformation, 2013). There are also significantly higher occupancy rates for buildings with green and efficient certifications.

However, the cost of an environmental assessment can be considerable. For some companies, the value is in having the certificate, and not always in the improved performance, so there are sometimes pressures to deliver a high assessment rating level for minimum investment.

4. ORGANISATION COSTS

Green building costs, and in particular related to energy performance, should be looked at in the context of the total organisation costs of a building, especially for commercial and public buildings. Studies have estimated that building construction costs and energy savings are a relative small proportion of total organisation costs. For commercial buildings, staff costs make up the bulk of operational expenses, with over 85% of total workplace costs spent on salaries and benefits, compared to less than 10% on rent, and less than 1% on energy (World Green Building Council, 2013).

Operational costs can greatly exceed design and construction costs over a buildings lifetime. Examples of two whole life-costing studies for offices have been described by Evans (Evans, R, Haryott, R, Haste, N and Jones, A, 1998) and Hughs (Hughes, WP and Ancell, D and Gruneberg, S and Hirst, L, 2004). Evans quotes a ratio of 1:5:200, for design/construction costs to operating costs to business costs, respectively. Hughes, however, questions the validity of this ratio, and suggests a ratio of 1:0.4:12, as being more realistic for commercial buildings. However, this still indicates that business costs, a large proportion of which will be staff salaries, outweigh design, construction and operating costs, which include energy costs (typically 30% of operational costs). Design costs can also be included in this ratio, simplistically as 10% of construction costs. Other studies have suggested that an initial 2% upfront investment for a green building will generate a return ten times higher than the initial investment over the life cycle of the building (Kats G, Leon A, & Adam B, 2003). They report that salary costs (USA) of around \$65,000 are roughly ten times higher than operations and maintenance costs, which include energy and rent, energy being only 1% of overall costs.

The above analysis implies that the largest return on investment should arise when green buildings also improve business productivity.

5. PRODUCTIVITY, HEALTH AND QUALITY OF LIFE

The previous section has argued that the benefits of increased productivity for a green building outweigh any energy savings, and by itself justifies increased design and construction costs. So life-cycle assessments based on energy savings alone, only provide a relatively small part of the potential overall value benefits to an organization. David Langdon reported that the Building Commission of Victoria indicated that optimal levels of indoor **environmental quality would increase Australian workforces' productivity by as much as 30%** (Davis Langdon, 2007).

Therefore a major aim of green building design is to achieve good standards of indoor environment, which can in turn improve worker productivity, and occupant health and well-being. In commercial buildings, sick building syndrome (SBS) has often been associated with spaces that have poor indoor environments, usually associated with air-conditioned offices. As long ago as 1984, the World Health Organization (WHO, 1984) reported that 30% of buildings globally may have indoor environments that contribute to SBS. More recently, Heerwagen (2010) (J. Heerwagen, 2010) reported that up to 20% of workers might be affected. Reducing SBS symptoms can potentially reduce absenteeism, as well as increasing productivity, and creating a more favourable working environment, which in turn can reduce staff churn.

As already discussed, an estimated average increase in productivity for a green building with a good environment is 4.8% (Johnson Controls, 2012), with increases up to 30% suggested in some reports (Davis Langdon 2007). If the cost of an office worker is estimated at around £30,000 per year (UK), a 4.8% improvement in productivity would therefore be equivalent to a value of around £150/m² of office floorspace per year (roughly assuming 1 person per 10m²). If the average sick leave is about 7.0 days per year, using the same estimated staff costs, and assuming 220 working days per year, the average cost of absenteeism is estimated at around £100/m² per year. A 10% reduction in absenteeism would benefit the business by around £10/m² per year. These estimated potential cost benefits totalling some £160/m² are relatively large compared to typical energy cost savings of typically around £3 (to a maximum £30)/m² a year.

Loftness et al, (Loftness V, Hartkopf V, Gurtekin B, Hansen, D, Hitchcock R, 2003) presented results from eight case studies linking individual temperature control to productivity gains of up to a 3%; fifteen studies linking improved ventilation with up to 11% gains in productivity; twelve studies linking improved lighting design with up to a 23% gains in productivity; and, thirteen studies linking the access to the natural environment through daylight and operable windows to individual productivity gains of up to an 18%. Lucuik et al, (Lucuik M, Trusty W, Larsson N, and Charette R, 2005) cited 35% less absenteeism in spaces with higher office ventilation rates.

Fisk (W.J. Fisk, 2000) has identified for the USA, potential annual savings through productivity gains are \$10 to \$30 billion from reduced Sick Building Syndrome symptoms and \$20 to \$60 billion from direct improvements in worker performance that are unrelated to health.

However, although the benefits of a good environment on staff moral and productivity seem obvious, improved indoor environmental quality has not generally been a priority in building design and construction.

6. FUTURE PROOFING

Both businesses and householders are becoming increasingly concerned of the future energy performance of their property. Energy costs, though often considered relatively small for the majority of businesses and households, are rising significantly. Also, security of energy supply may become an issue in future. Energy related building regulations are expanding to consider existing as well as new build. The value of a building in future may therefore be affected by its energy performance, carbon dioxide emissions, and its indoor environmental quality. These may affect the rental income, resale value, and the future overall value of real estate assets, in turn affecting their return on investment.

There may also be affects of extreme weather events and changes in weather patterns that might affect future **insurance costs, in relation to a building's resilience. As building buyers, tenants and investors, begin to understand** these risks, non-green buildings may become obsolescent. Green buildings may be considered a lower risk, which could result in a higher yield on investment. Interest rates on building related loans may be less for green buildings, reflecting their reduced risk. A green building, whether new or retrofit, can therefore future-proof against these potential cost liabilities.

A positive stance towards environmental issues may in future impact on supply chain acceptance. A company's 'green' real estate can demonstrate a visible signal of the adoption of an environmental policy. It may even **contribute to a firm's success in attracting and retaining high-quality employees.**

7. CORPORATE RESPONSIBILITY

Carroll's pyramid of Corporate Social Responsibility (Carroll, AB, 1991) for a business includes ethical and philanthropic responsibilities, alongside economic and legal responsibilities. The economic and legal responsibilities relate mainly to its shareholders, owners, and employees. The ethical and philanthropic level responsibilities relate mainly to public interest, which includes the environment.

Green buildings can form a major part of a company's Corporate Social Responsibility Strategy. They have many tangible benefits to a company, as discussed in previous sections, together with the less tangible benefits that can contribute to a favorable corporate reputation. A company therefore may be inclined to choose a green building in comparison to a standard building, to enhance its environmental credentials. A green building can therefore meet **both social responsibilities whilst achieving cost savings and other 'quality of life' and economic benefits.**

8. MARKETABILITY

There are many reports that relate to the added value of green buildings. Generally they support the argument that buildings with better sustainability credentials enjoy increased marketability. Green buildings are able to more easily attract tenants and to command higher rents and prices. In markets where green has become more mainstream, there are indications of emerging 'brown discounts', where buildings that are not green may rent or sell for less.

The World Green Building Council's report (World Green Building Council, 2013) focusing on commercial buildings, explained that green buildings have a higher asset value, as evidenced by higher sale prices, with higher rental/lease rates, lower operating expenses, higher occupancy rates and lower yields (leading to a higher transaction price). They can be quicker to secure tenants, command higher prices enjoy lower tenant turnover, cost less to operate.

However, as discussed above, there are some barriers relating to understanding the benefits of green buildings, including, the assumption that it costs more to build green, the fact that green strategies are not widely understood, construction companies lack experience, there is a lack of awareness of the market, a shortage of engineers with experience of operating green building systems, a lack of incentives for owner-investors as opposed to owner-occupants. There is also a perceived lack of evidence between lower energy costs for building occupiers, and the benefit to the landlord. Leases do not generally take account of green issues. However green leases can provide benefits to both tenants and landlords (Langley, Hopkinson, Stevenson, 2008). The tenant will benefit from reduced energy bills and improved indoor environments, whilst the landlord can benefit from longer lease periods, a more stable tenant base, and a higher asset value on their estate.

9. FUEL POVERTY AND HEALTH

The 'rebound' effect introduced above (Ryan and Campbell, 2012) may occur when energy savings are not fully realised due to other benefits. One such benefit is affordable warmth in fuel poor housing. Fuel poverty is defined as when a household pays more than 10% of its annual income on energy, and extreme fuel poverty is when they pay more than 20% of annual income on energy. In some countries this is becoming of epidemic proportions. For example, up to 25% of UK households, and up to 33% in Wales, live in fuel poverty (Association for the Conservation of Energy, 2014).

Fuel poverty will often result in households not being able to achieve sufficient warmth. Substandard housing is already estimated to cost the UK National Health Service £2.5 billion a year (National Housing Federation / ECOTEC, 2010). When energy saving measures are applied in fuel poor communities, often a large proportion of **the benefit will be 'taken back' in improved comfort. This take-back**, or rebound effect, has been estimated to be up to 50% of the expected energy saving measures (Lomas, 2010).

Referring to the above, some 25% of the UK's 26.4 million housing may experience fuel poverty, which generally contributes to substandard environments, and or the need to improve energy efficiency. This would equate to around 6 million dwellings. Based roughly on the above £2.5 billion health impact from substandard housing, the potential health impact cost per dwelling would equate to an average of £400 per substandard dwelling per year. If say a retrofit dwelling has a health benefit lifetime of twenty years, this equates to a saving of £8,000 per retrofit, by the health industry. So, from this simplistic analysis, reducing fuel poverty can potentially save the health industry considerable amounts of money.

10. COMMUNITY BENEFITS

The above discussion has focussed on the building scale benefits from green buildings, in terms of reduced energy costs, improved well-being and productivity, and increased building asset value. There are also potential benefits to the community in which the building is located. Green housing can increase wealth through reduced operating costs. Green commercial buildings can improve the quality of the built environment, attracting higher value businesses, and creating higher value jobs. There are also jobs associated with green industries, which are often appropriate to the mix of available skills within the local community. For example, the construction sector could create 400,000 new jobs from making buildings more energy efficient to meet the requirements of the Energy Efficiency Directive (European Commission, 2014).

It is difficult to quantify the cost benefit of a green building to the community, but it could be of a level equivalent to the benefit to the building operator, as benefits of increased productivity, asset value may all be reflected in downstream community economic and quality of life benefits, and the increased value feeds through to the community, through higher wages, green jobs, and less pollution.

11. ENVIRONMENTAL DAMAGE

Burning fossil fuel contributes to considerable environmental damage at a global and national level, which results in huge cost penalties. The DARA group have reported (DARA 2012) that climate change is already contributing to the deaths of nearly 400,000 people a year and costing the world more than \$1.2 trillion a year, with developing countries bearing the brunt, through deaths from malnutrition, poverty and their associated diseases. Air pollution caused by the use of fossil fuels is also separately contributing to the deaths of at least 4.5m people a year. By 2030, it is estimated that the cost of climate change and air pollution combined will rise to 3.2% of global GDP, with the world's least developed countries forecast to bear the greater cost, of up to 11% of their GDP.

The Stern Review (Stern N, 2006) estimated that the overall costs and risks of climate change will be equivalent to losing at least 5% of global GDP each year and the estimates of damage could rise to 20% of GDP or more. In contrast, it suggests that the costs of reducing greenhouse gas emissions to avoid the worst impacts of climate change can be limited to around 1% of global GDP each year.

The most environmentally damaging business sectors are oil and gas producers, followed by industrial metals and mining. These together accounted for almost a trillion dollars' worth of environmental harm in 2008 (PRI, 2010). In 2003, research results on socio-environmental damages due to electricity production and transport (European Communities, 2003) showed that, if the external cost of producing electricity from coal were to be factored into electricity bills, 2-7 eurocents per kWh would have to be added to the then current price of electricity in the majority of EU Member States.

The European Environment Agency reported that air pollution in Europe cost more than 100 billion euros in 2009 alone due to health and environmental damage (European Environment Agency, 2011). Emissions from power plants in Europe made up the largest share of the environmental damage costs, at £56.8bn-£96.4bn. The construction and operation of the built environment is closely linked to these industries. If we assume 40% of electricity is used in buildings the environmental damage equates to around £120 per household per year across Europe. That includes damage associated with global warming, acid rain, resource depletion, habitat destruction by fuel extraction, environmental damage from processing and transportation, and photochemical smog.

Future increases in environmental damage and resource depletion, could potentially lead to governments to apply a "polluter pays" principle. This in turn will affect the built environment, with reduced asset values for non-green buildings, higher insurance premiums on companies, carbon taxes, and the costs associated with retrofits that could be the subject of future changing building regulations.

12. CASE STUDIES

Many of the studies discussed above have been associated with large-scale surveys. However, there are an increasing number of green building projects, both new build and retrofit that are yielding invaluable information on green building design and the resulting benefits. The following case studies, carried out by the author, are used to further evidence some of the above discussion points.

Office design (Figure 1): A green approach to modern office design should adopt an integrative systems approach, to maximise performance, reduce costs and improve reliability. The EMPA zero energy office in Zurich is a good example of this approach, using a combination of 'smart' façade design, thermal mass cooling and renewable energy supply (Jones P J and Kopitsis K 2005). It uses a central atrium for night cooling in summer, using a "passive" approach by exposing the concrete ceiling to absorb daily heat gains from the space. At night the building is naturally ventilated through the atrium, cooling the building down. This is combined with a ground ventilation cooling system, which operates during the daytime, typically cooling outside air by up to 8oC for delivery to the occupied space. The building is highly insulated and does not need a conventional heating or cooling system. The increased cost of the façade is offset by the reduced costs of the environmental systems, so the total costs are comparable to a standard office building. The mechanical ventilation ground cooling system that operates during

the day, provides enough fresh air for occupants, and not the larger quantities that would be associated with more traditional air-conditioning systems. Therefore, fan power and space for ducts and systems are reduced. The EMPA building uses passive thermal mass ceiling cooling. This, to some extent, decouples the cooling from the ventilation system. Whereas a standard air cooling (heating) system would be based on the ventilation being provided by the heating and cooling system. This holistic approach to design leads to multiple cost and value attributes, including: lower fan power; less space for plant; less space for air distribution; greater use of space for occupants; good thermal comfort; better air quality; more stable easier to control conditions; good use of daylight. Such an integrative systems approach to new commercial buildings can therefore provide an overall more sustainable design solution at affordable costs.



Figure 1: EMPA zero energy office

Energy positive house (Figure 2): An energy positive house (Welsh School of Architecture, SOLCER Project) has been designed within an affordable budget, equivalent to the standard costs of good quality one-off social housing. It incorporates near PassiveHaus standards, PV and solar thermal renewable energy systems, and has thermal and electrical storage, within the cost budget. The design adopted a systems approach integrating reduced energy demand, renewable energy supply and energy storage. It has electricity grid back-up, for periods when the energy storage system is not sufficient. Its energy positive design means that it can export more energy to the grid than it imports from the grid.



Figure 2: Zero carbon house (SOLCER project)

Individual house retrofits (Figure 3): The SOLCER Project has also carried out retrofits of existing social housing. **The first one completed in September 2014 (Figure 3a) used a whole house 'deep' retrofit systems approach** including, solar PV (the whole of the south facing roof is replaced with a PV roof system), MVHR, external wall insulation, battery storage, and increased airtightness. The total package of measures cost around £27,000, with an estimated carbon dioxide emission reduction of 70%. An additional £25,000 was spent by the housing association to bring the house up to current standards. This compares with a previous case study (Figure 3b) for a similar size end-terrace house, which cost around £54,000 to achieve 80% carbon dioxide emission reductions with an additional £70,000 spent on non-energy saving improvements. This previous case study was one of the TSB cases discussed above (M Baeli, 2013), and generally adopted a less integrative more **'bolt-on' approach**.



Figure 3a

Figure 3b

Figure 3: Examples of social housing retrofit. Figure 3a shows a recent retrofit where the whole south facing roof has been replaced by a PV panel. Figure 3b shows a 'bolt on' approach to PV.

For the SOLCER house, prior to retrofit, the house was unoccupied, thus losing the housing association around £450/month in basic rent. Post retrofit, a tenant was easily found, and the house rented at an increased rate of around £540/month (plus 20%), therefore achieving considerable multiple cost benefits for the housing association. There are currently around 20,000 such empty houses in Wales, in many cases where this approach could be implemented, bringing current unoccupied housing back into the market place, so they become an asset rather than a liability to their owners. Bringing empty houses into use also benefits the community and reduces the need for new build.

Large-scale retrofit

Housing retrofit programmes are often carried out on large samples (Jones PJ, et al, 2013). An example is that of **the whole housing stock in the Neath Port Talbot local authority in Wales. This targeted lower cost 'elemental' energy saving measures**, rather than the deep whole house approach discussed above. It was carried out between 2004 to 2007, and some 49,831 households were assessed, and 28,799 energy efficiency measures carried out to 18,832 properties. Around 28,799 tonnes of carbon dioxide emissions were saved. The project took advantage to provide multiple benefits in addition to energy savings, including: improved comfort; creating 54 new jobs, 127 workers receiving training; 2,305 households removed from fuel poverty; a total £10.3 million invested in the Borough. This project demonstrates the added value that can be applied to large-scale retrofit projects.

The earlier single house and the large-scale retrofit projects have illustrated the range of cost versus energy savings and carbon dioxide emission reductions in relation to shallow elemental measures and deep whole house measures (Figure 4). The recent single house retrofit (Figure 3a) illustrates the speed at which costs are being reduced through a more systems based approach. Both scales illustrate the range of value added benefits in addition to energy savings.

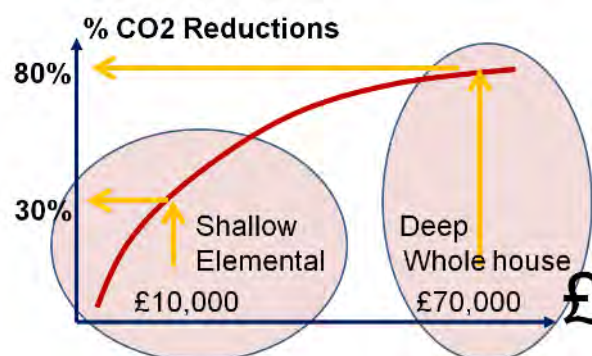

Figure 4: Range of retrofit costs versus carbon dioxide emission reductions (Jones PJ, et al, 2013)

These above case studies indicate that, for new build, it is now possible to achieve near zero carbon performance at an affordable cost. The cost of deep retrofits for housing is also being reduced significantly. Both of these

developments have involved a systems approach, carefully selecting the most appropriate combination of reduced energy demand, renewable energy supply and energy storage, to meet the requirements of the specific buildings in question.

13. THE VALUE OF GREEN BUILDINGS

The above sections have introduced a number of issues associated with cost and value of green buildings. Some of the areas covered have associated the estimated costs of the value added aspects of green buildings. In some sections, an estimation has been provided, based on rough values from the literature, with some 'back of envelope' estimates. The intention has been to provide an initial estimation for an overall cost and value estimate. In the estimations, neither increased energy costs nor interest rates have been considered, so they should be considered 'ball park' Figures.

In the past, a cost analysis has mainly related increased cost of a green building against the reduced operating costs, which have been mainly energy savings. What the above discussion has identified is a range of added value factors, some of which are potentially considerably higher than the potential energy savings. It has also identified a scale of value added which benefits not just the building owner, but also considers benefits at community and national (and global) levels. At the national/global level, benefits include, reduced environmental damage (eg. from climate change and air pollution), reduced national health costs (eg. arising from affordable warmth and improved well-being), and security of energy supply and reduced energy imports. At a community level, there is the potential for green jobs, a better quality built environment, and higher value local economic activities. At a building level, which is where the majority of this discussion has been based, the benefits are associated with energy savings, increased value of the building, future proofing, and improved health, well-being and productivity. Table 2 summarises these three areas of green building multiple benefits.

National / Global	Community	Building
<ul style="list-style-type: none"> • Carbon emissions reduction. • Reduced use of resources. • Security of energy supply. • Improved public health and well-being, and reduced health related costs. • Reduced environmental damage. 	<ul style="list-style-type: none"> • Jobs. • Skills and training. • Local economy. • Less pollution. 	<ul style="list-style-type: none"> • Increased resale value. • Increased rental rates. • Higher occupancy rates. • Lower operating expenses. • Higher net operating income. • Lower capitalization rates. • Increased energy efficiency and lessening greenhouse gas emissions. • Reduced risk of obsolescence. • Less need for refurbishment in the future. • Lower tenant turnover affecting renewals, inducements and fitting out costs amongst others. • Quicker to secure tenants. • Better indoor environment: health, well-being and productivity gains. • Attract grants, subsidies and other inducements to do with environmental stewardship. • Higher demand from institutional investors mandatory for government tenants. • Contribute to company CSR policy.

Table 2: Summary of potential green building cost and value benefits

Office buildings have the potential for considerable added value, in relation to the increased asset value of the building, productivity gains, as well as energy savings, which are relatively small compared to the total benefits. The above discussion has identified a range of sources of information in this area. These have been interpreted into an overall cost value performance. Figure 5 indicates the range of cost benefits for a new 'green' office taken from the above review. Retrofit offices will have a similar range of benefits, although not to the extent of new offices.

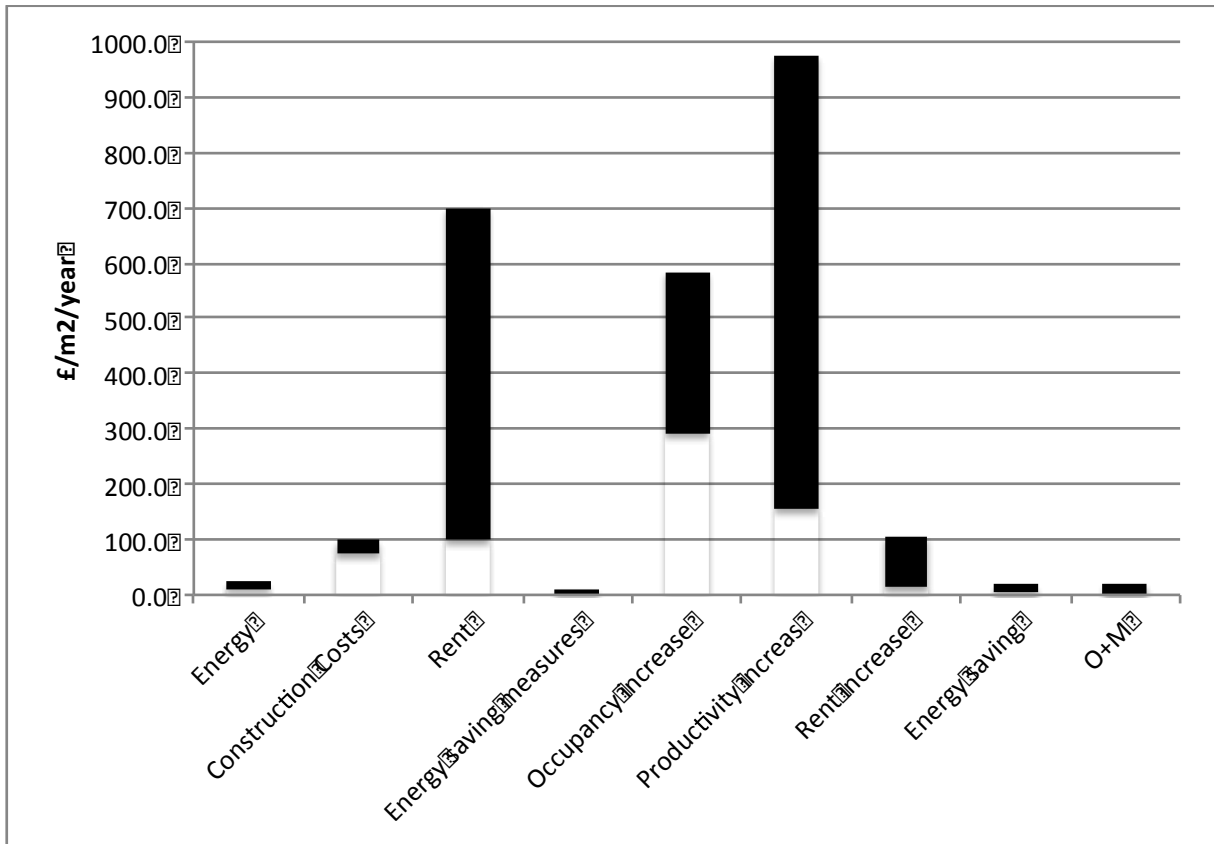

Figure 5: Potential cost savings for a 'green' office

New houses designed to green standards will also incur a range of benefits. The national/global, and to some extent the community benefits, will be as for offices. The building benefits include energy savings, increased value of the building, future proofing, affordable warmth, and improved health and well-being. The range of cost benefits are summarised in Figure 6.

For new build offices and housing, the increased costs associated with low to zero energy performance are being driven down by new technologies, integrated into the building design through a systems approach. This was demonstrated in the case studies presented above. The cost of retrofit is also being significantly reduced, through the lowering of costs for renewables, improved understanding of the process, and, as for new build, a more systems based approach. This was also demonstrated in the above case studies, for deep housing retrofits. The above discussion has also indicated that retrofit of office costs are highly beneficial with relatively short payback times, in just terms of energy savings.

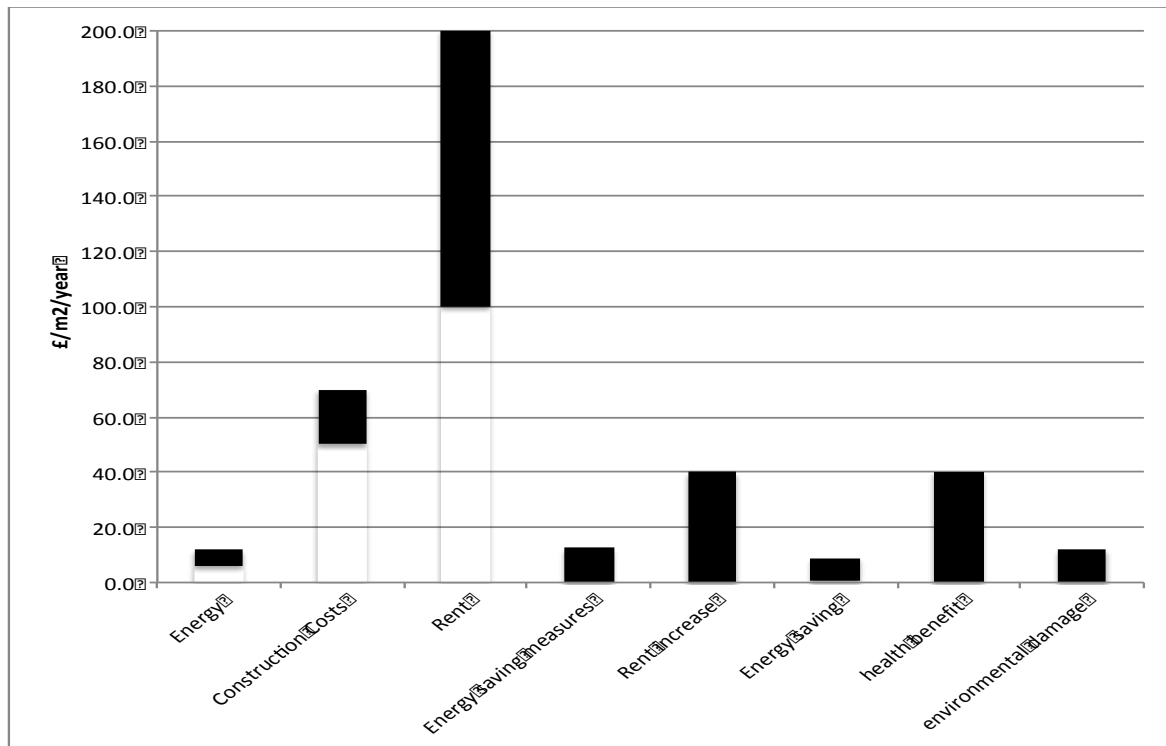

Figure 6: Cost and value benefits for a new 'green' house

14. CONCLUSIONS

This chapter has highlighted the multiple benefits from green building design, in addition to the usual focus on energy savings. There are of course significant energy savings and carbon dioxide emission reductions to be **achieved for both new build and retrofit. However, it is the additional 'value added' multiple benefits that are** becoming increasingly attractive, and to some extent they are zero or low cost, as the energy savings alone justify the initial green design costs. In summary, green buildings do not necessarily incur significant additional initial cost. For new build, and retrofit, costs are being reduced. The benefits are multiple and both quantitative and qualitative, and are realised at a building, community and national / global scale. Energy savings alone can potentially exceed any design and construction cost premiums, within an acceptable payback period. The total benefits can far outweigh any additional cost outlay. Developers who do not provide green buildings incur investment risk, and reduce marketability. Non-green buildings may now be considered short term, and can potentially spiral down the economy. Green buildings can provide better places to live and work, a higher value asset, and generally spiral up the economy at building, community and national levels, and promote tangible benefits to people.

Addressing the low carbon agenda at a building development level may be termed **'bottom-up'**, compared to say **'top-down' approaches, such as large-scale renewables, carbon trading, smart meters, and green-deals.** A **bottom-up approach, which is based within an overall systems approach, can be termed 'smart-up', with reference to the added value of a green building as it impacts at higher levels of community and national/global scale, providing the potential for cost and other benefits at these higher levels.** It also localises the low carbon agenda, as it promotes economic activity at a regional scale, with potential social benefits, through jobs, local investment and ownership. **Top-down approaches may also be termed 'smart' but they are often associated with high risks, and any added benefits are generally more 'big industry' commercial and national based.** Smart-up has the potential to reduce the **pressure on top down scenario's, making them easier to implement, as demand is reduced, being displaced by building based distributed generation.** These factors all contribute to the overall value-added outcomes.

ACKNOWLEDGMENTS

Transport and Urban Development COST Action TU1104, Smart Energy Regions.

REFERENCES

- [1] Appraisal Institute and the Institute for Market Transformation (2013) Green Building property value: A primer for building owners and developers
- [2] Association for the Conservation of Energy, Fuel Poverty: 2014 update.
- [3] Baeli, Marion (2013) Residential retrofit 20 case studies RIBA pub.
- [4] **Buildings Performance Institute Europe (BPIE), 2011, Europe's buildings under the microscope: A country-by-country review of the energy performance of buildings.**
- [5] Carroll, A. B. (1991) The Pyramid of Corporate Social Responsibility: Toward the Moral Management of Organizational Stakeholders. *Business Horizons*, 34(4), 39–48.
- [6] Chegut, Andrea, Eichholtz, Piet and Kok Nils (2012) Supply, Demand and the Value of Green Buildings, RICS, March.
- [7] DARA (2012) Climate Vulnerability Monitor: A Guide to the Cold Calculus of A Hot Planet. Climate Vulnerable Forum, Dara International.
- [8] Davis Langdon (2007) The cost & benefit of achieving Green buildings
- [9] Eichholtz, P., Kok, N., & Quigley, J. M. (2010). Doing Well by Doing Good? Green Office Buildings. *American Economic Review*, 100(5), 2492–2509. doi :10.1257/aer.100.5.2492.
- [10] European Commission Memo (2014) MEMO/14/446, Brussels.
- [11] European Communities (2003) External Costs: Research results on socio-environmental damages due to electricity and transport, ISBN 92-894-3353-1.
- [12] European Environment Agency (EEA) (2011) Revealing the costs of air pollution from industrial facilities in Europe, EEA Technical Report No 15/2011.
- [13] Evans, R, Haryott, R, Haste, N and Jones, A (1998) The long term costs of owning and using buildings, London: Royal Academy of Engineering.
- [14] Fisk WJ (2000) Health and productivity gains from better indoor environments and their relationship with building energy efficiency, *Annu. Rev. Energy Environ.*, 25 pp. 537–566.
- [15] Hughes, Will P. and Ancell, Debbie and Gruneberg, Stephen and Hirst, L. (2004) Exposing the myth of the 1:5:200 ratio relating initial cost, maintenance and staffing costs of office buildings. In: Khosrowshahi, F., (ed.) Proceedings 20th ARCOM Conference.
- [16] J. Heerwagen, (2010) Healthy Buildings: A Proposal for a Research Initiative on Health and Indoor Environments University of Washington, Seattle
- [17] Jackson, Jerry (2009) How Risky Are Sustainable Real Estate Projects? An Evaluation of LEED and ENERGY STAR Development Options, *JOSRE Vol 1 No 1*
- [18] Johnson Controls factsheet (2012) Assessing the Value of Green Buildings, Institute for Building Efficiency.
- [19] **Jones PJ and Kopitsis K (2005) The building physics design of the EMPA "Forum Chriesbach" low carbon office, CLIMA2005 Congress, pages 258-264 (Switzerland),**
- [20] Jones PJ, Lannon SC and Patterson JL, (2013) Retrofitting existing housing: how far, how much?. *Building Research and Information* 41(5), pp. 532-550.
- [21] Jones, PJ (2015) A Low Carbon Built Environment: policy to practice through a bottom-up approach. *European Energy Innovation*, pp. 12-14.
- [22] Kats G, Leon A, & Adam B (2003) The costs and financial benefits of green buildings, Sustainable Building Task Force.
- [23] Nils Kok and Avis (2015), Green Certification and Building Performance: Implications for Tangibles and Intangibles *Journal of Portfolio Management Special Real Estate Issue 2015*, Vol. 41, No. 6: pp. 151–163.
- [24] Langley Angela, Hopkinson Lara, Stevenson Vicki (2008) Green Leases: an opportunity to develop a sustainable approach for tenanted commercial buildings in the UK 247 n, Proceedings of the 5th International Conference on Improving Energy Efficiency in Commercial Buildings: IE ECB Focus.
- [25] Loftness, V, Hartkopf, V, Gurtekin, B, Hansen, D, Hitchcock, R. (2003) Linking energy to health and productivity in the built environment. Evaluating the cost-benefits of high performance building and community design for sustainability, health and productivity. Greenbuild Conference.
- [26] Lucuik M, Trusty W, Larsson N, & Charette R. (2005). A Business Case for Green Buildings in Canada: Morrison Hershfield, presented to Industry Canada..
- [27] National Housing Federation / ECOTEC, (2010). Social Impact of poor housing. London: National Housing Federation / ECOTEC
- [28] Lomas, K. J. (2010). Carbon reduction in existing buildings: a transdisciplinary approach. *Building Research and Information*, 38(1), 1-11.

- [29] MacGraw Hill Construction, World Green Building Trends (2013)
- [30] Mills, Evan (2009) Building Commissioning A Golden Opportunity for Reducing Energy Costs and Greenhouse Gas Emissions, Lawrence Berkeley National Laboratory Berkeley, CA 94720 USA, Report Prepared for: California Energy Commission Public Interest Energy Research (PIER).
- [31] Pacific Northwest National Laboratory and PECO (2011) Advanced Energy Retrofit Guide, Practical Ways to Improve Energy Performance, Office Buildings, September 2011, Prepared for the U.S. Department of Energy under Contract DE-AC05-76RLO 1830.
- [32] Pivo, Gary and Fisher, Jeffrey D (2009) Investment Returns from Responsible Property Investments: Energy Efficient, Transit-oriented and Urban Regeneration Office Properties in the US from 1998-2008, Working Paper, Responsible Property Investing Center, Boston College and University of Arizona Beneck Center for Real Estate Studies, Indiana University.
- [33] PRI (2010) Putting a Price on Global Environmental Damage, UNEP Finance Initiative, Innovative financing for sustainability.
- [34] Ryan, Lisa and Campbell, Nina (2012) THE BUSINESS CASE FOR GREEN BUILDING: SPREADING THE NET: THE MULTIPLE BENEFITS OF ENERGY EFFICIENCY IMPROVEMENTS, OECD/IEA.
- [35] Schofield, C. (2005) Green Value, Green buildings, growing assets, www.rics.org/greenvalue, October 2005/50261/
- [36] Stern, N. (2006) Stern Review on The Economics of Climate Change, HM Treasury, London.
- [37] U.S. Environmental Protection Agency, Office of Air and Radiation (1991) Indoor Air Facts No. 4: Sick Building Syndrome, revised.
- [38] US Environmental Protection Agency (2011) Assessing the Multiple Benefits of Clean Energy: A RESOURCE FOR STATES, EPA-430-R-11-014, Revised September 2011.
- [39] Welsh School of Architecture, SOLCER Project (2015)
- [40] World Green Building Council (2013) The Business Case for Green Building, A Review of the Costs and Benefits for Developers, Investors and Occupants.
- [41] World Health Organisation (WHO), 1984, Indoor Air Quality Research. Euro-RTeport and Studies No 103; WHO-regional office for Europe, Copenhagen, Denmark.

YKK80 High Efficiency Building - Radiant Control both Outside and Inside

Kitaro MIZUIDE^a

^a M&E Design Department of NIKKEN SEKKEI, Japan

1. INTRODUCTION



Located in the metropolitan city of Tokyo, Japan, the new YKK headquarters building is named “YKK 80” because it was completed in 2015, which marked the 80th year since the company was founded. Tragically, in March 2011, just one month after design began, the Great East Japan Earthquake and disaster occurred. Japan rapidly shut down all of its nuclear power plants (nearly 30% of Japan’s total energy supply) and reassessed their energy supply and demand as well as their seismic vulnerability. This allowed the owner and design team to reassess the energy, comfort, sustainability, and seismic design requirements for this project—ultimately leading to much more innovative, integrated, comfortable, healthy, and aseismic design solution.

The project site is a 5-minute walk from Akihabara station, and the longer axis of the site is 70 meters (230 feet) in length, faces westward, and overlooks a metropolitan expressway. These constraints immediately established several energy, daylight, noise and view design challenges for the hot and humid summer climate of Tokyo.



2. ENERGY EFFICIENCY

Using a passive first approach, an exterior “sudare screen”, or Japanese traditional blind, was used over the entire west facing façade to block and filter direct solar gain while maintaining daylight and views. This sudare screen is positioned 1.5 meters (~5 ft.) in front of the glazed façade utilizing the cantilevered floor structure as overhangs. The screen is made of “Y” shaped aluminium bars making a delicate filtering of light. Clear double glazing with automatically controlled bottom-up or “climbing” blinds also provides solar shading while still allowing exterior views. The sudare screen also helps filter outdoor noise, creates a safe service space for maintenance of exterior installed mechanical systems, and even provides lightning protection—ultimately providing 6 functions for a single cost (shading, reflecting daylight, noise filter, deck enclosure, maintaining views, and lightning protection)

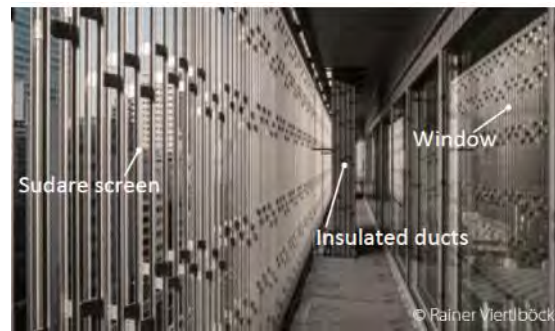

Photo 1: Sudare screen/ maintenance deck



Figure 1: Details of sudare screen/ perimeter image

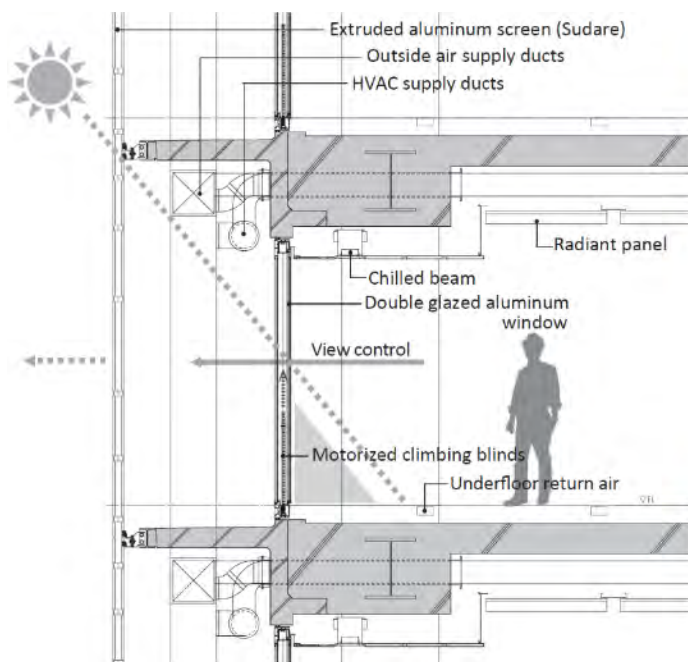

Figure 2: Multi-functional facade system

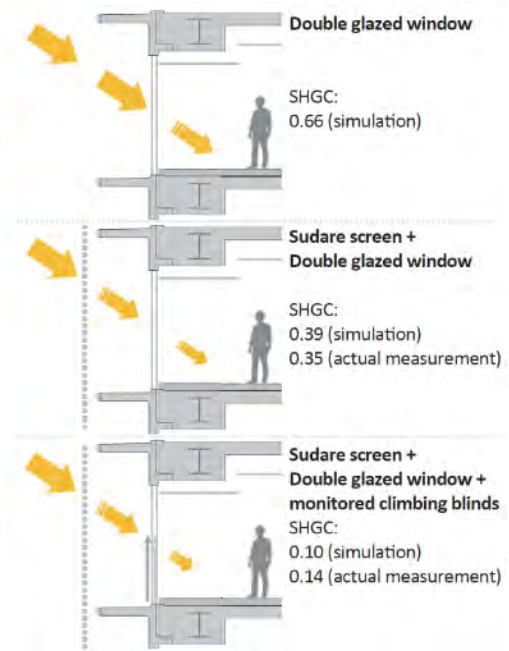

Figure 3: SHGC diagram

Daylighting is maximized by controlling the light coming through the windows with automatic solar adjustment of the angle of the blind slats every 10 minutes. Through post-occupancy evaluation, which was completed in February 2016, more than 80% of the occupants were satisfied with the indoor lighting conditions noting that it was "bright enough" and "not too bright" (no presence of glare). Ceiling integrated LED lighting and controls for dimming or turning off lighting in vacant areas using daylight and motion sensors, extends the value of the energy saving façade design to the indoor environment.

With direct solar heat gains mitigated and daylight and lighting optimized, a properly sized, high-efficiency HVAC system could be designed. A custom, radiant ceiling panel cooling/heating system was designed to facilitate integration of hot/cold water piping with lighting and low-velocity (slight) air flow. This slight air-flow concept came from the memory of experiencing a natural breeze under the shade of a tree. Small fans, functioning as diffusers, provide the slight air flow behind the inclined radiant panels and allow greater variation in temperature set points.

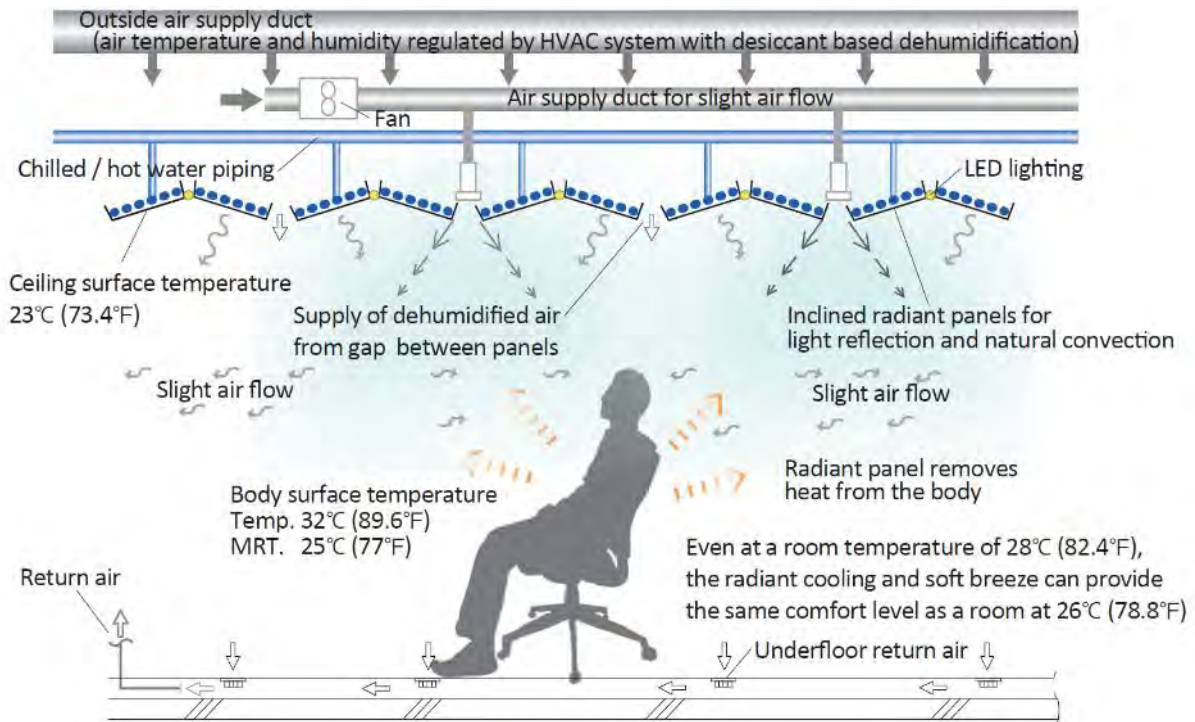

Figure 4: Conceptual drawing of HVAC system

Figure 5 shows the quantity of energy consumption for control of the sensible heat load on the vertical axis and the difference between outside temperatures and an average of all room air temperatures on the horizontal axis. This proved that if room temperature is increased by 1K (kelvin) in cooling mode, energy savings is 8.6MJ/h (source energy 23.3MJ/h). Similarly, lowering the room temperature by 1K while in heating mode, saves 12.0MJ/h (source energy 32.4MJ/h). The chilled water temperature is relatively high which contributes to the high performance operation of the chillers.

Thermal loads in the interior zone, where the temperature does not significantly change, are met by the radiant ceiling panel system. However, the variable thermal load near the exterior windows is met using an Active Chilled Beam. Together, this zoned approach provides for a very efficient distribution of both energy and comfort.

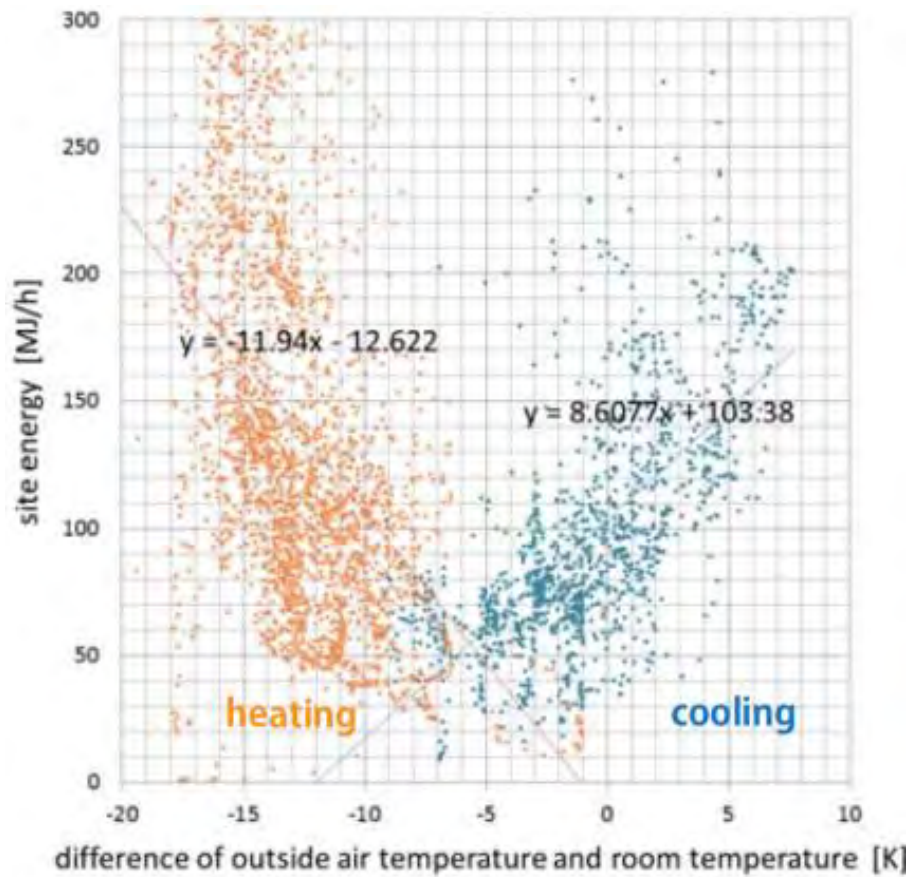

Figure 5: Energy savings from YKK actual temperature set point mitigation

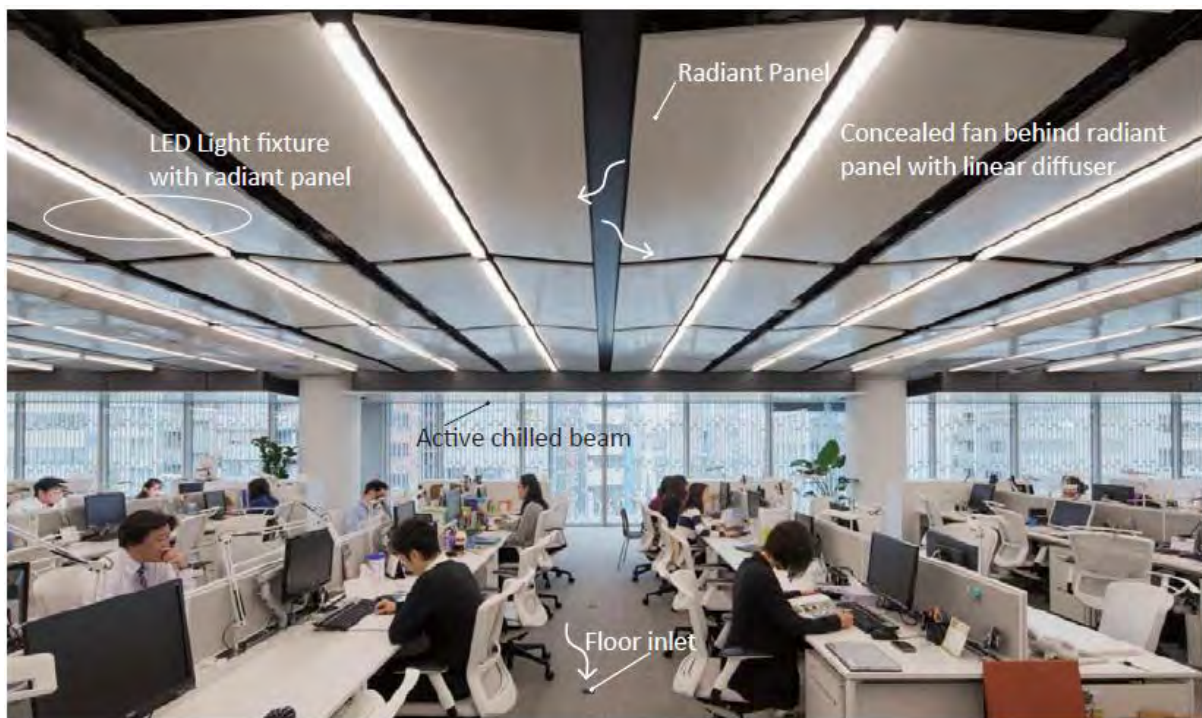

Photo 2: Interior image

Other energy reduction strategies include active plug-load management and geo-exchange. Each desk is equipped with an electric outlet or receptacle which is capable of showing electricity consumption for that desk. It is also equipped with a sensor which detects an occupant's presence and the power is automatically turned off when nobody is present.

Earth-to-air energy exchange occurs using a trench in the seismic isolation layer to preheat or precool outdoor air through an underground tunnel. In addition, well water for direct thermal exchange is used as an untapped natural resource in the lower level air handlers.

The final energy results are shown in both Table 1 and Figure 6. These results, when modeled using Energy Plus against an ASHRAE 90.1 baseline, demonstrate a 27.5% savings (site energy) and, when comparing actual results to the baseline, they indicate a 32.5% savings (site energy) and indicate a 53 % (source energy) savings compared to an average Tokyo regional office building.

	Site	Source
ASHRAE Baseline	153.65 kWh/m ² -yr (48.71 kBtu/ft ² -yr)	1,371 MJ/m ² -yr (120.74 kBtu/ft ² -yr)
Proposed (modeled)	111.40 kWh/m ² -yr (35.31 kBtu/ft ² -yr)	1,034 MJ/m ² -yr (91.06 kBtu/ft ² -yr)
Actual	103.69 kWh/m ² -yr (32.87 kBtu/ft ² -yr)	932 MJ/m ² -yr (82.08 kBtu/ft ² -yr)

※ Source-Site Ratios in Tokyo Japan
Electricity:2.711 ; Natural Gas:1.005

Table 1: Annual energy performance summary

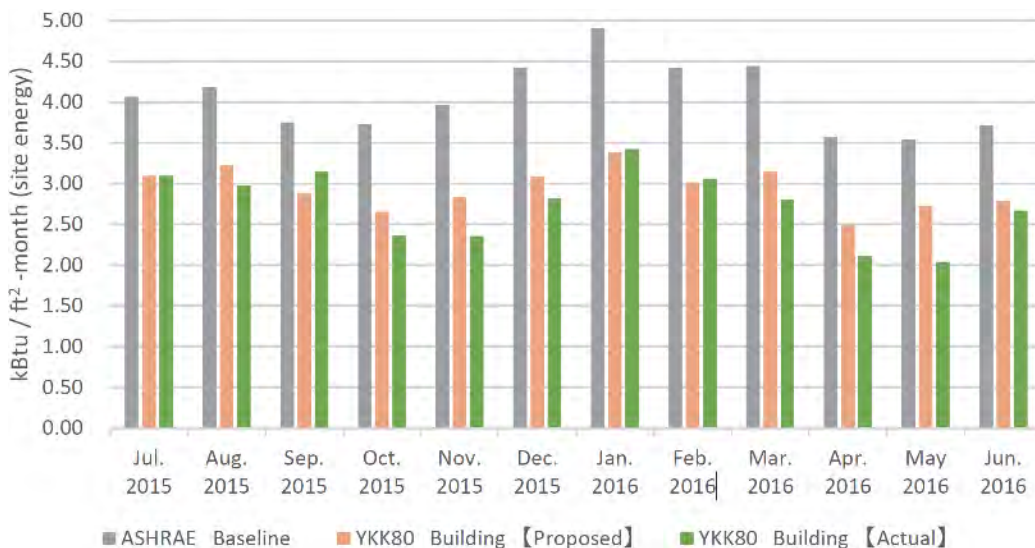

Figure 6: One year monthly operating data of building energy performance

3. INDOOR AIR QUALITY AND THERMAL COMFORT

Excellent indoor air quality is maintained throughout the year by utilizing air handling units with desiccant-based dehumidification, a Dedicated Outdoor Air System (DOAS) and proper control of the quantity of outdoor air based on CO₂ concentration. The minimum quantity of outside air, which is taken through the air handlers, is supplied to the space above the radiant ceiling panels. This air is continuously returned at the floor level and is then returned to the rooftop air handlers. Figure 7 shows indoor CO₂ concentration data on the vertical axis, which was measured by floor and time of day when the air handlers were in operation, and the average temperatures of each season (summer, shoulder seasons, and winter) on the horizontal axis. CO₂ concentration has been maintained around

707 ppm throughout the year, indicating very good air quality. Additionally, MERV 13 filtration of supply air was used to control respirable particulate matter, pollen and dust.

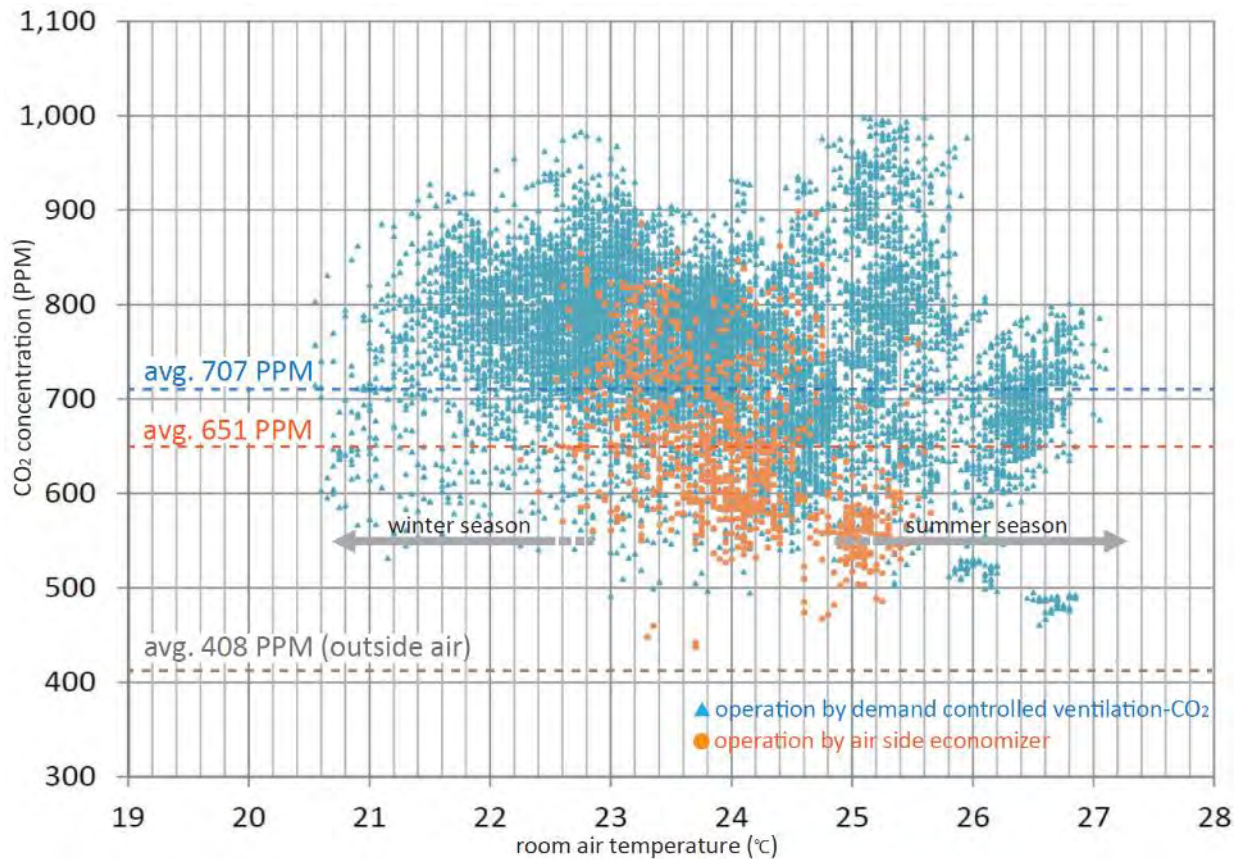

Figure 7: Relationship of CO₂ concentration and room temperature

Using a detailed 3-dimensional Building Information Model (BIM) and Computational Fluid Dynamics (CFD) comfort verification of the radiant cooling assisted by the slight air flow system was confirmed during the design phase. Additionally, experiments were conducted with subjects in a mock-up research laboratory to verify comfort in areas using the slight air flow (Figures 8, 9). Figure 10 shows the relationship between the room temperature, Predicted Mean Vote (PMV=0), Mean Radiant Temperature (MRT), and air speed-- referencing Thermal Comfort from the 2013 ASHRAE Fundamentals Handbook. It was determined that when the average radiant temperature is lower than the air temperature of the room, the room temperature could be increased by around 2°C--from 26°C to 28°C (78.8°F to 82.4 °F)--keeping the PMV the same if the air is supplied with a slight air flow of 0.2 or 0.3m/s (0.66 or 0.98 ft/s) with a MRT of 25°C (77 °F). The mock-up research and lab experiment, with over 150 participants, confirmed comfort in over 75% of the participants using higher temperature set points with a slight air flow--demonstrating compliance with ASHRAE Standard 55-2010 (Figure 11).

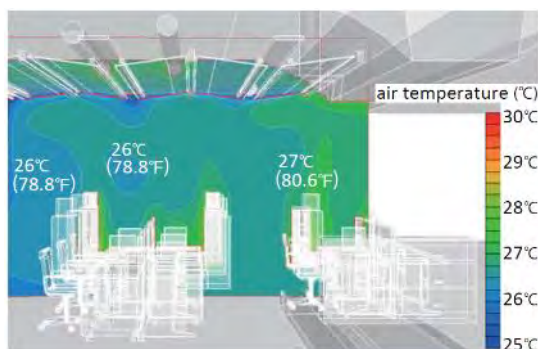

Figure 8: CFD coupled with BIM (air temperature)

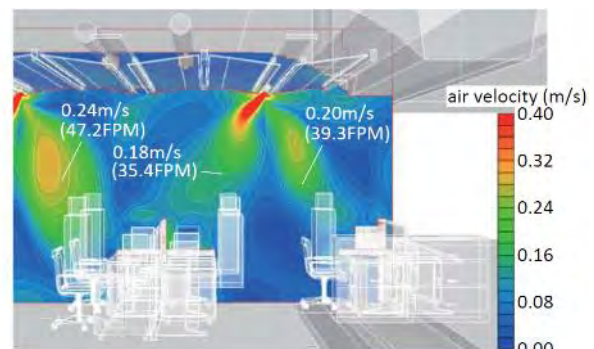

Figure 9: CFD coupled with BIM (air velocity)

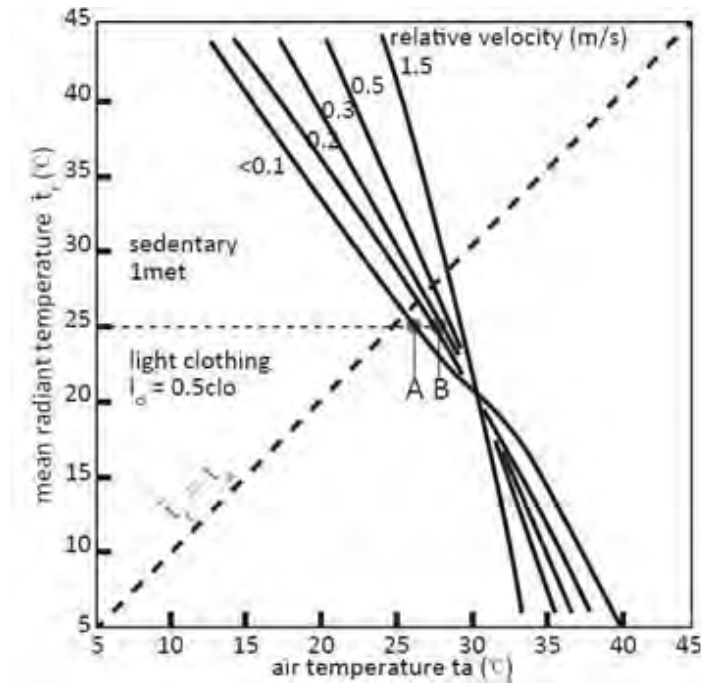

Figure 10: Air temperature and MRT necessary for comfort (PMV=0) of sedentary persons in summer clothing at 50% RH

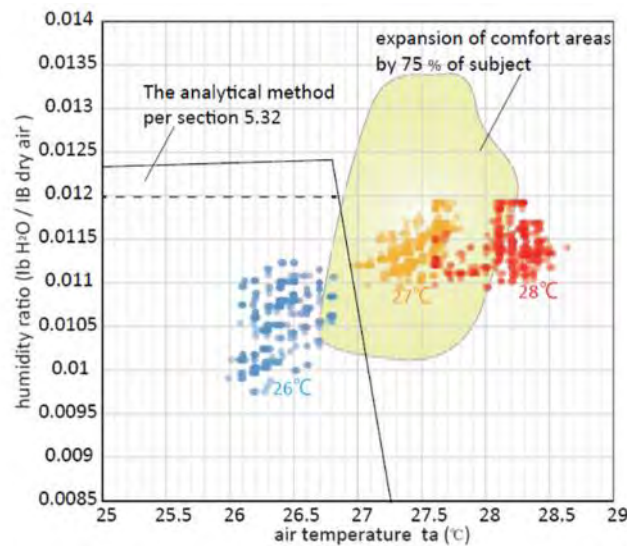

Figure 11: Expansion of comfort zone

4. INNOVATION

The real innovation of the YKK80 building was in meeting the challenges brought forth by the 3/11 disaster and the entire owner, design and construction teams commitment to utilize an integrated design process in response to that. The key innovations include: the multi-functional façade design, the “under-the-tree” breeze radiant cooling system, the design, mock-up and lab comfort verification process, and the enhanced commissioning and ongoing measurement and verification. Today, YKK80 is one of the lowest energy consuming offices in Japan with verified occupant comfort (Figure 12). Beyond energy savings and comfort, YKK invites visitors on regular facility tours and utilizes graphic-based data from their Building Energy Management System (BEMS) to communicate the value of energy and water reduction strategies. Another innovation feature is a state-of-the-art, real-time earthquake detection system designed to provide immediate response and safety information for occupants. The entire building rests on seismic isolation pads.

5. OPERATION AND MAINTENANCE

Two years of performance verification was included in each team members contract and uses sophisticated BEMS data to support operation and maintenance. The entire team (owner, designer, contractor, manufacturers, and operators) will participate in this ongoing performance verification until two years after occupancy. Detailed real time monitoring of energy and environmental systems (cooling/heating, plumbing systems, water use, electricity, and lighting) is provided by the Building Automation System (BAS). This information is reported monthly at a commissioning meeting and contributes to ongoing energy-savings and improved occupant comfort. Figure 6 on page 5 shows one year of actual monthly operating data as compared to the ASHRAE baseline and energy simulation.

6. COST EFFECTIVENESS

YKK80 utilized an integrated design process to optimize the whole building as a system and to utilize single elements, such as the sudare screen or the sloped radiant ceiling panels, for multiple functions. Still, the initial investment was greater than a conventional similar office building. The increase in the initial (2013) investment was JPY720 million (~\$7.2 million USD) or JPY34,418/m² (~\$32 USD/ft²). The present day utility cost savings are JPY66 million (~\$630,000 USD) per year, or JPY 3,155/m² (\$2.8/ft²), which is 52% less than a similar sized Tokyo office building. Using a simple payback analysis, this will require just under 11 years to pay back the additional investment—assuming utility costs do not increase. It should be noted that even with a modest productivity gain of 5% (much higher increases have been documented in other green office buildings) this 11 year payback period would be less than 2 years.

7. ENVIRONMENT IMPACT

The actual reduction in CO₂ emissions is 22.6kg-CO₂/m² (4.64 lbs/ft²) or 32% below the baseline (CO₂ emission factor in Tokyo, Japan, Electricity: 0.496kg-CO₂/kWh ; Natural Gas: 2.23kg-CO₂/kWh ; Tap Water: 3.129kg-CO₂/m³). This building also incorporated high-efficiency water-saving equipment (water closets: 3.8L (1 gallon US) water per flush, faucets with 14 second shut-off timer), and currently consumes 65% less tap water than that of an ordinary office building in Japan. In addition, 100% of the non-tap water necessary for a bio-film process is provided using treated wastewater and reclaimed rain water.

8. SOCIAL ENGAGEMENT/ CONCLUSION

YKK understands the importance of being a good corporate citizen and integrating themselves with the local community. Examples of their community engagement include: utilizing outdoor plants (with signage) on their site that have been present in their neighbourhood since the Edo period; promoting farm-to-table food utilizing their **rooftop garden; and offering local handicraft manufacturer's opportunities to hold workshops and exhibition events** using the area around the building entrance. YKK staff also participate in the local traditional festival and allow **their lobby to be used for displaying the "Mikoshi" or sacred portable shrine.**

Based on the latest data from Tokyo Metropolitan Government, YKK80 energy performance is in the top 1% of the 465 buildings sampled.

Focusing on the initial project goals of energy-savings, comfort, health, seismic safety and cost-effectiveness in the life cycle design, the YKK80 building has clearly met, and even exceeded these goals—providing a new benchmark for green office buildings in Japan.



Photo 3: Rooftop garden

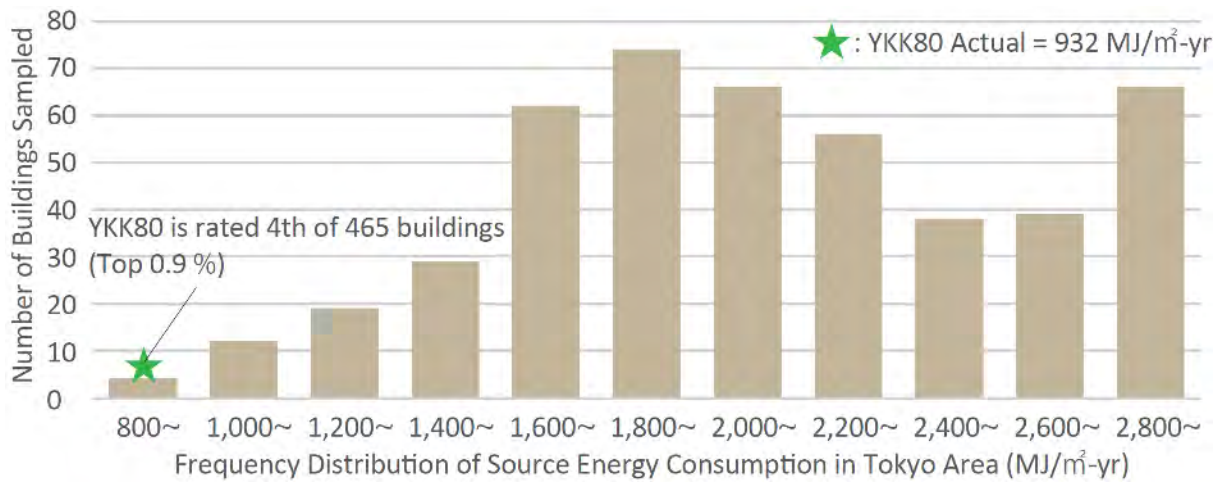

Figure 12: Source energy of office buildings over 10,000m² in Tokyo (2009)

Performance Synergy from Integrated Design, Construction and Operation. Case Study on a High Performance Grade A Office - Swire One Taikoo Place

Vincent CHENG^a, Mark RICHARDSON^b, LEUNG Wai-Ho^c, Alvin LO^d, Raymond YAU^e, Raymond KWOK^f, Frenky YUE^g

^aArup, Hong Kong SAR, vincent.cheng@arup.co

^bArup, Hong Kong SAR, mark-a.richardson@arup.com

^cArup, Hong Kong SAR, wai-ho.leung@arup.com

^dArup, Hong Kong SAR, alvin.lo@arup.com

^eSwire Properties Ltd., raymondyau@swireproperties.com

^fSwire Properties Ltd., raymondkwok@swireproperties.com

^gSwire Properties Ltd., frenky.yue@swireproperties.com

ABSTRACT

Taikoo Place Phase 2A Tower (TKP2A) is Swire Properties Ltd new and prestigious office development project. It is redeveloping Somerset House in Taikoo Place on Quarry Bay, Hong Kong with a target occupation date in 2018. The key objective of TKP2A is to develop a best in class, green and sustainable building from demolition, design, construction to operation. This will be a leader of high performance sustainable buildings in Hong Kong.

TKP2A embraces modern integrated design. This positions sustainability at the key elements of design and brings the design team together from the earliest project stage to jointly develop solutions. This fosters innovation and the application of new technologies and processes.

With the desire for TKP2A, to push low carbon construction significantly beyond what had already been achieved **across current Swire's Building properties it was essential to approach design** from a non-conventional starting point. From this early vision a design team was formed, with green and sustainability as the core values at the heart forming a design platform and integrating the multidisciplinary design team together with various departments from Swire Properties. At this early stage, project goals were set and every member of team was empowered to develop towards these goals through design charrettes and regular workshops. This ensured that future challenges were identified early and mitigated, enabling a new level of low carbon construction to be attained.

This integrated design process and key elements of design are discussed in this paper.

Keywords: integrated design, sustainable construction, high performance

1. INTRODUCTION

Taikoo Place Phase 2A Tower (TKP2A) is Swire Properties Ltd new and prestigious office development project. It is redeveloping Somerset House in Taikoo Place on Quarry Bay, Hong Kong with a target occupation date in 2018.

The key objective of TKP2A is to develop a best in class, green and sustainable building from demolition, design, construction to operation. This will be a leader of high performance sustainable buildings in Hong Kong.

TKP2A embraces modern integrated design. This positions sustainability at the heart of design and brings the design team together from the earliest project stage to jointly develop solutions. This fosters innovation and the application of new technologies and processes.

With the desire for TKP2A, to push low carbon construction significantly beyond what had already been achieved **across Swire's Building Stock it was essential to approach design from a non-conventional** starting point. From **this early vision a design team was formed, with Arup's Building Sustainability group** at the heart providing design platforms and integrating the multidisciplinary design team. At this early stage, project goals were set and every member of team was empowered to develop towards these goals through design charrettes and regular workshops. This ensured that future challenges were identified early and mitigated, enabling a new level of low carbon construction to be attained.

This integrated design process and key elements of design are summarised in this paper.



Figure 1: Rendering of TKP2A

2. INTEGRATED APPROACH TO HIGH PERFORMANCE BUILDING

Sustainability in the context of today's building market has taken on a holistic nature where many different initiatives are required to interact to enhance and sustain the triple bottom line: environmental, social and economic drivers.

The design of the building must embed systems, technologies and interfaces that enable operators and occupants to achieve the highest sustainable performance throughout the buildings life.

Excellent cross-team coordination and integration work is crucial for the project to achieve real performance enhancements. Starting from the early design stage, the TKP2A project team together with Swire Properties building operational team and Swire Properties sustainability team had a deep involvement in the TKP2A design. This wealth of building operation experience was essential in developing design driver. As such, TKP2A was designed by occupant and operational needs. The measured energy performance data of several buildings in Taikoo Place was given to the design team for them to identify a genuine energy performance benchmark. The design team could then test the performance of various green strategies against this benchmark.

A number of charrettes occurred across the project team, design team and operational teams at early stage. These included facade, sustainability, mechanical and electrical systems, demolition, green construction etc. The charrette acted as a communication platform to highlight the requirements of performance quantification, operational and maintenance activity, design constraints etc. It was a key and successful tool in project delivery.

3. SUSTAINABLE DEMOLITION

To first task was the demolition of Somerset House. As such a sustainable waste management plan was developed. Sustainable demolition aims to minimise the use of resources, i.e minimising waste sent to landfill.

Through in depth discussions with the structural engineer an understanding of the safe execution of demolition processes, waste handling procedures and waste sorting methods were developed. Then a sustainable waste management strategy was proposed which outlined demolition waste and material treatment. Three hierarchal principles were followed:

Waste avoidance

Reuse of materials is the most effective way to minimise waste generation, Swire Properties collaborated with local charities to donate fixtures and fitting for onward distribution to the needy. This extends the fittings service life and

avoids waste by reuse of good quality of interior fittings such as furniture, carpet, electrical appliances and equipment. A number of local charities or institutes are in operation e.g. Crossroad, Industrial Relation Institute etc. There are also some waste recycling programs organized by local government e.g. Computer Recycling Programme by the Environment Protection Department which will collect donated computers and electrical appliances for onward distribution.

Waste recovery

After all reusable materials are taken out, the materials are then processed for recycling. The main source of waste is the permanent structure of Somerset House accounting for over 86% of waste by weight of the whole project, over 70,000 tonnes. There are several waste concrete recyclers in Hong Kong. Over 75% of the broken concrete (normally smaller than 400mm in size), plus other inert C&D waste including rocks, boulders, rubble and bricks were distributed to local recyclers for recycling. These inert wastes go through a series of crushing and screening processes to become recycled aggregates of different grades. Recycled aggregates serve a wide range of applications including road sub-bases, filter layers, ingredients in concrete and the filling of bridge columns. The broken concrete will also mix with the recycled glass sand and titanium dioxide to form eco-paving blocks which will be re-utilised in hard landscaping.

Another major source of waste is the reinforcing steel bars in concrete structures and aluminium scraps from window frames. Processes for metal recycling are common and these materials were easy to recycle.

The overall performance of demolition waste recycling for TKP2A is over 75% by accounting for waste not taken to the local public fill. Approximately 35,300tons of embodied carbon was saved by the reduction of virgin materials.



Figure 2: Recycling of waste metal in TKP2A project during demolition

4. LOW CARBON CONSTRUCTION

Swire Properties take a great effort on the sustainable development industry. With closely collaboration with Swire's Technical Services and Sustainability Department (TSSD), the embodied carbon for material selection and carbon emission during construction has been evaluated and managed properly.

The embodied carbon of building materials can be taken as the total carbon emissions released over its life cycle. This includes the process of extraction, manufacturing and transportation. Several low carbon construction strategies have been considered during the initial design stage in order to avoid large wastages of materials in TKP2A tower.

4.1 Utilization of low carbon material

Use of high recycled content materials which are regionally sourced can significantly reduce the emissions of embodied carbon from transportation and raw material extraction and manufacturing. Strategies to reduce of all these factors were considered.

Concrete mixed fly ash – TKP2A uses fly ash to replace cementitious material in concrete, as cement has a very high embodied carbon content to add significant benefit.

Reinforcement steel is a major material in high rise buildings. It is common to adopt around 10% to 20% recycled metal into the steel.

Use of regionally manufactured and sourced materials within the project can effectively reduce transportation carbon emissions. According to the international green building certification system – LEED Core and Shell, a regional material is defined as material which is extracted and manufactured locally within 800km of the site. The overall target of recycled content of materials and regional manufactured material is 20%.

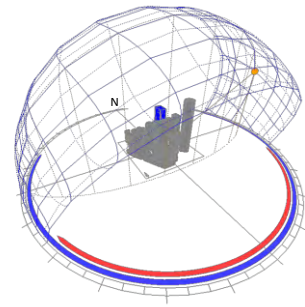

4.2 Higher flexibility for interior layout design

With the collaboration with architectural and structural design team, a range of initiatives are adopted in the design in order to avoid excessive material consumption and wastage due to frequent changes of tenant layout.

Knock-out panels were designed into the floor slabs. These reduce the additional renovation works for the installation of internal escalators or staircases by future tenants. Integration with the structural engineer is required in order to locate this movable panel into the building structure.

Application of digitally addressable wireless control systems for lighting. This allows for the easy adoption of various **zoning and lighting control strategies based on tenant's needs** by programming and eliminating any additional wiring works for future tenant rezoning. Installation of additional energy saving controls e.g. occupancy sensor, daylight harvesting is relatively simple when using wireless control systems.

5. IN USE ENERGY CONSUMPTION & CARBON EMISSIONS

TKP2A has been designed to minimise operational carbon emissions. This requires a number of integrated initiatives across the energy design hierarchy. Through the design platforms, design charrettes and integrating the multidisciplinary design team at this early stage, the building operational consideration and the characteristic of energy consumption for existing buildings nearby the project site has been referred and a more suitable design approach that fit the needs for TKP2A has been identified. This design hierarchy ensures that building loads are minimised with passive design before they are served with highly efficient active services and finally grid supplied electricity is replaced with renewable energy.

5.1 Passive design

Passive energy design is reduction of building loads with the use of architectural features. The excellent thermal properties (solar controlled glazing and opaque insulation) of the building envelope effectively insulates the building **from Hong Kong's hot climate**.

The external shading devices which were designed in response to TKP2A's solar environment, help to further block the unwanted solar heat gain throughout the year. The overall OTTV of proposed model is around 19W/sq.m. in the office tower as compared to the statutory maximum OTTV requirement for offices of 24W/sq.m.

At the same time as blocking solar heat gain the glazing also allows the whole office tower to experience daylight. Artificial lighting is automatically dimmed when daylight is present. This reduces artificial lighting energy consumption.

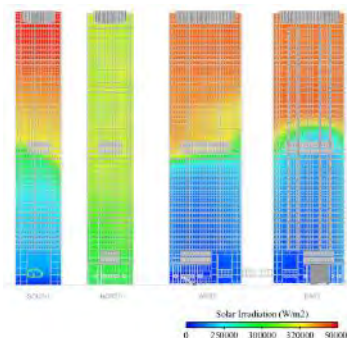

Figure 3: Sun path analysis and solar heat gain study from building envelope

5.2 Active design

TKP2A includes a range of energy saving systems which enable the building to substantially reduce energy consumption beyond local and international code. With collaboration with architectural team, building services design consultant and Swire TSSD and Taikoo Place Management Office (TPMO), a selection of the key systems are noted here.

High Performance Chiller and Plant Optimization. Cutting edge, high performance centrifugal variable speed chillers and optimised chiller sequencing will deliver cooling effectively for the buildings life. Starting from the review of chiller plant operational data from existing buildings, together with the consideration of condenser water temperature and building loads, chillers dynamically adjust and operate at the optimum efficiency in order to obtain an optimization control and operation. This strategy obtained around 5% of total building energy consumption.

100% Free Cooling and Air Economisers. The side core design in TKP2A enables floor by floor fresh air intakes. This in turn increases the potential fresh air intake volume allowing 100% free cooling with an air economising. This cooled air system enables a chiller bypass when the outdoor conditions are cooler.

Demand Control Ventilation. Carbon dioxide (CO₂) levels are a good measure for the fresh air requirements as people breathe out CO₂ and require more fresh air. CO₂ monitoring systems in the office area of TKP2A detect the occupancy levels so that the amount of fresh air can be adjusted in accordance with the demand. A similar system in the car parks detects carbon monoxide. These detectors are installed in basement car parks to monitor the pollutant concentration levels and modulate fresh air delivery based on traffic conditions.

Energy recovery

When stale and cold air is exhausted from buildings it contains useful energy, heat recovery collects this useful energy for use in the building. The high efficiency heat wheel has been designed to recover energy from office and toilet exhausts.

High efficient lighting

Lighting energy is a major consumer of energy in office buildings. The lighting design has, optimised lighting lux levels, high energy efficient light tubes and high reflective luminaires as well as an effective lighting grid arrangement. These measures reduce lighting power levels by almost 40% compared to local code levels.

Efficient air movement

Moving air around buildings with fans consumes significantly quantities of energy. High efficiency fans with brushless direct drive motors (EC plug fan) are a new technology which reduce fan energy consumption by almost 20%.

The overall building energy saving for the proposed TKP2A is about 33% as compared to the HK Building Energy Code Version 2012 as baseline. The annual building energy cost saving is about 28% as compared to the ASHRAE Standard 90.1 (2004) baseline setting.

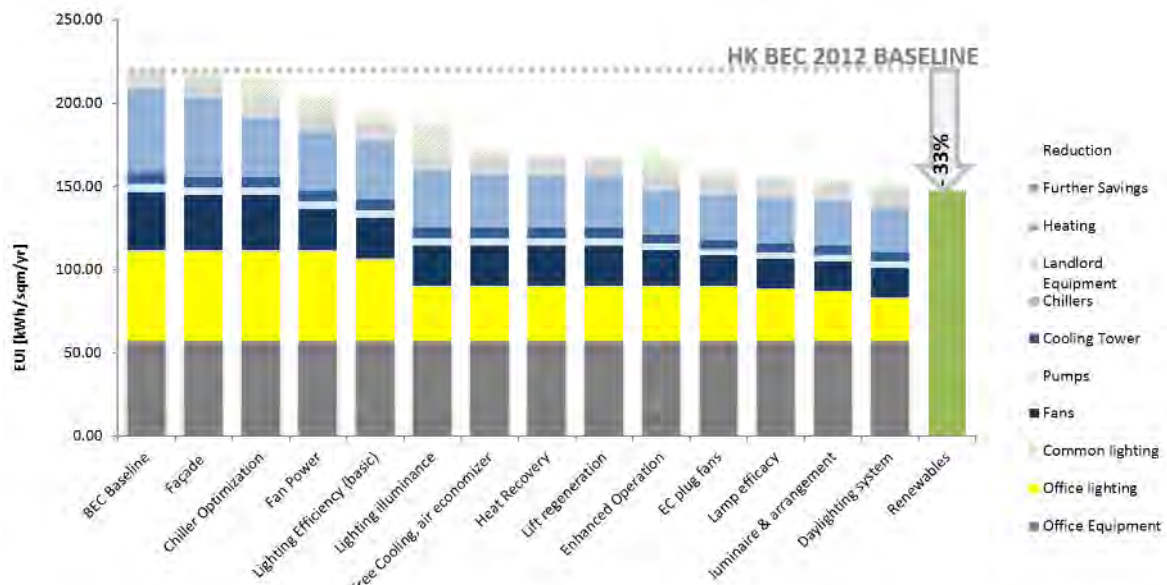

Figure 4: Annual energy reduction of TKP2A from HK BEC 2012 baseline

5.3 Waste to renewable energy

After application of passive strategy and active system, large portion of building energy has been reduced. On-site renewable energy generation is one of the strategy to further reduce the residual energy of the building. For a high-rise high energy intensity building with limited building footprint and usable roof area, TKP2A pushed the boundaries and worked with the government to introduce waste cooking oil power generation. A commercial building first in Hong Kong.

In Hong Kong, an estimation of 20,000 tons used cooking oil and 175,000 tons of grease trap waste each year are **generated from eateries and food businesses which is typically disposed of at landfill. Hong Kong's landfill sites** are going to be exhausted by 2020. The Environmental Bureau has set a target of a 40% reduction in food waste to landfill by 2022. To help achieve this, food waste can be used for bio-diesel production. Biodiesel is normally made from feedstock such as used cooking oil, grease or disposed animal fats.

The 200 kW (electricity) bio-diesel generator proposed for TKP2A consumes 540L a day approximately of B100 grade bio-diesel made of 100% food waste. Eventually around 135,000L of waste cooking oil will be reused **annually. Provided the waste oil production from F&B tenants and hotels in Swire's portfolios approximates 20,400L** annually, all the used cooking oil could be utilized by the power generation plant. 15% oil demand of generator is fulfilled and there is sufficient capacity to take up more waste cooking oil from other from eateries and food businesses. As such TKP2A bio-diesel generator completes the cycle of waste-to-energy for the community.

The generator provides electricity for the building and the waste heat from the generators is used to generate cooling. This energy cascade maximises the usable energy from the system. In energy terms, over 400 MWhrs of renewable energy is generated. It is equal to 278 tons of CO2 emission being off-set by 1400 trees. It provides over 2% of the total building electricity consumption.

5.4 Wind performance and outdoor comfort at open space

The new development will contain a range of public spaces, streetscape amenities and a new elevated walkway corridor naming Taikoo Plaza and Taikoo Gardens that will enhance the setting and context of a distinctive and emerging area of Hong Kong. The concept for this landscape proposal is a contemporary reinterpretation of the landscape that surrounds the city of Hong Kong with its particular geological nature and cultural refinement through craftsmanship using noble materials.



Figure 8: Masterplan of Taikoo Place

Vegetation

Provide highly vegetated areas and dense planting to reduce urban heat island effect and improve the micro-climate within the scheme. Address the green ratio requirements. It also minimizes the impact on urban heat island effect. Compared to the existing development having 3 buildings, the current building plan with massive public space and greenery obtain around 2°C reduction at local area.

Sustainability

Provide an enhanced environment to the neighbourhood where sustainable techniques can be included to mitigate energy use, water consumption, air pollution and bring a potential layer of biodiversity into the site especially within the core landscape areas. Provide an enhanced environment to the neighbourhood where sustainable landscaping techniques can be included to reduce energy use and water consumption and mitigate air pollution as well as urban heat island effect.

Social connectivity

Create an inclusive landscape and open space framework that encourages outdoor activities, promenading and passive recreational activities, where residents, workers and visitors can have an enjoyable and calm experience relaxing, meeting and mingling in an outstanding urban landscape.

6. FURTHER SUSTAINABILITY

Other than the material use reduction and operational carbon emission reduction, the project team also considered other sustainable design elements which further enhanced the building performance and thus beneficial to the building occupants.

6.1 Performance verification of design elements

Project team put an effort on the performance verification and design review on the system and key design elements by modelling and simulation. For example, a computational fluid dynamic (CFD) model has been applied to verify the air distribution effectiveness of AC system. The solar irradiation with 3D rendering tool has also been applied to verify the performance of PV system and analyses the reflective glare impact to surrounding buildings. It built up a sophisticated quality control measures for TKP2A and a new practice to future projects.

6.2 Enhancement to future tenants and building operators

With an integrated collaboration among the architect and MEP engineers during design stage, additional centralized exhaust systems were designed into the central core. These are available for future tenants to connect their individual exhaust ducts to for air exchange during fit-out periods. This minimizes the spreading of odours and cross contamination between tenants. Further collaboration with operational and maintenance team would help to understand further the needs and criteria from the building users. Earlier involvement with O&M team would also help enhancing a more user-oriented design to this project.

7. CONCLUSION

The demolition, construction and ongoing maintenance of buildings consumes significant quantities of resources. This is particularly prevalent in the higher end property market which demands the best of current provisions. As such TKP2A followed a focused approach to sustainability where by all possible efforts were made to reduce **resource consumption. As was noted in this paper, this process was driven by Arup's Building Sustainability team,** and involved the integration of all members of the design team, project team and operation teams from the early stage to realize the vision of Swire Properties.

REFERENCES

- [1] Accounting procedure references the embodied carbon database, Electrical and Mechanical Services Department, Hong Kong, Life Cycle Impact Assessment Tool,
- [2] US Green Building Council, LEED Core and Shell Version 2009.
- [3] HKSAR Environmental Bureau – A food waste & Yard Waste Plan for Hong Kong 2014-2022.

(4) The Secret Ingredients of Sustainable Real Estate Development Session Organiser: Swire Properties Ltd.

Session 4.7

SESSION OUTLINE

What constitutes a sustainable built environment? And how do the myriad of stakeholders involved contribute and collaborate to this objective?

Beyond high performance buildings, engagement and collaboration with building users, the community, and other parties are essential to making and keeping sustainable places. This session will establish a platform with experts from a range of disciplines to discuss:

- The environmental, social, and economic factors that make up a sustainable built environment
- The role of impact measurement and data transparency in supporting sustainable real estate development
- The complexities of managing climate change in real estate

With the aim of bringing a broader view to the management requirements for a sustainable built environment, this **session aims to support the conference theme of "Putting Ideas into Action"**.

SESSION CHAIR

Ashley HEGLAND, Consultant, Swire Properties Ltd.

SPEAKERS AND PRESENTATION TOPICS

1. Themes/Trends of Sustainable Urban Planning and Sustainable Built Environment
Christopher LAW, Founing Director, Oval Partnership, Hong Kong SAR
2. Ingredients of Sustainable Real Estate: Criteria, Transparency, Engagement
Ruben LANGBROEK, Head of Asia Pacific, GRESB, Hong Kong SAR
3. Climate Change and Sustainable Real Estate: The Environmental, Social, and Economic Implications
Liam SALTER, CEO, RESET Carbon
4. **Swire Properties' Approach to Sustainable Real Estate**
Raymond YAU, General Manager, Technical Services & Sustainable Development, Swire Properties Ltd.

(5) Emerging Practices in Sustainable Built Environment Session Organiser: Allied Environmental Consultants Ltd.

Session 3.12

SESSION OUTLINE

Themed “Emerging Practices in Sustainable Built Environment”, this 90-minute Parallel Session (hereinafter the “Session”) will focus on how sustainability best practices can be applied to local buildings with the aid of case studies.

In general, a typical building has a “lifespan” of over 50 years. It is without doubt that operation and maintenance phase plays an important role in the environmental performance of a building throughout its life cycle. One of the **common lessons learned from the case studies is the importance of a “body check-up” for buildings** through conducting regular audits to collect data, which provide the basis for identifying areas of improvement and enhancing environmental performance. A few case studies also demonstrate another way of improving environmental performance through collecting feedback from stakeholders such as staff members. These role models serve as good examples of stakeholder engagement when it comes to enhancing sustainability of buildings.

The Session will first begin with individual presentations, followed by a question-and-answer session, where speakers and audience will exchange insights on the topics presented.

SESSION CHAIR

Grace KWOK, Managing Director, Allied Environmental Consultants Ltd.

SPEAKERS AND PRESENTATION TOPICS

1. Acoustics and Lighting Design for Green Building
Henry CHAN Chi-kee, Associate Director, Allied Environmental Consultants Ltd.
2. Showcase of Green Campus Development in Hong Kong – A Case Review of Hang Seng **Management College’s** Master Campus Expansion Plan
Danica CHAN, Environmental Consultant, Allied Environmental Consultants Ltd.
3. Drive towards Sustainable Development and Management: Case Study on International Commerce Centre
Andy LAI, Senior Consultant, Allied Environmental Consultants Ltd.
4. Intelligence, Collaboration, Continuity – A Case Study of Improving the Environmental Performance of an Office Building
Lewis LAM, Assistant General Manager (Property Management), Kai Shing Management Services Ltd.
5. Sustainability Strategies in Towngas Headquarters Building
Nelson LO, Property Management Manager, The Hong Kong and China Gas Company Ltd.

Showcase of Green Campus Development in Hong Kong – A Case Review of Hang Seng Management College’s Master Campus Expansion Plan

Grace KWOK^a, Timothy SZE^b, Yvonne LIN^c, Danica CHAN^d, Martin TAM^e, Tom FONG^f, Hackman LEE^g

^a Allied Environmental Consultants Limited, Hong Kong S.A.R. (China), gk@aechk.com

^b Allied Environmental Consultants Limited, Hong Kong S.A.R. (China), ts@aechk.com

^c Allied Environmental Consultants Limited, Hong Kong S.A.R. (China), yl@aechk.com

^d Allied Environmental Consultants Limited, Hong Kong S.A.R. (China), dc@aechk.com

^e Hang Seng Management College, martintam@hsmc.edu.hk

^f Hang Seng Management College, tomfong@hsmc.edu.hk

^g Hang Seng Management College, hackmanlee@hsmc.edu.hk

ABSTRACT

As one of the world’s most competitive cities, Hong Kong has a growing shortage of undergraduate places. This increase in demand for tertiary education drives vigorous campus development and expansion.

Being one of the self-financed higher education institutions in Hong Kong, Hang Seng Management College (“HSMC”) has undergone a strategic campus expansion plan with the commitment towards sustainable growth and development while maintaining the quality of built environment and optimising usage of existing and new facilities to meet needs and expectations of students. This paper presents how HSMC tallies campus development projects toward their sustainability goals through (1) green campus design in master planning; (2) on-going building operation and maintenance; and (3) stakeholders’ engagement. Buildings under the campus development project have garnered the final platinum and provisional platinum rating respectively under the BEAM Plus for New Buildings, which is a Hong Kong’s green building assessment scheme. The successful story of HSMC campus development shall serve as a model for future school or campus development of similar scale in Hong Kong and on an international stage.

Keywords: sustainability, sustainable campus, green building design, maintenance and operation, stakeholder engagement, green education, community outreach, holistic approach

1. INTRODUCTION

Hang Seng Management College (hereinafter “the College”) is a non-profit-making private university-level institution aims to be a leading private university pursuing excellence in teaching, learning and research in Hong Kong. Established in 2010, it was restructured from the former Hang Seng School of Commerce. College facilities and services has been highlighted as one of the strategic focus areas in the College Strategic Plan 2013 – 2018 – Road map to University and Beyond. Key strategies include affording a modern and stimulating campus environment to facilitate and support teaching and learning activities by expanding the original campus.

Sustainable campus concept was integrated in its Master Campus Expansion Plan and the newly developed premises were awarded the highest Platinum Rating under the BEAM Plus for New Buildings which is a comprehensive environmental assessment scheme for buildings in Hong Kong. The Master Campus Expansion Plan has demonstrated the College’s commitment to support local sustainability development as well as its leadership role in teaching environmentally social behaviour and its status as a world-class institution.

1.1 Project overview

The Master Campus Expansion Plan aims at expanding the physical facilities of the College from the original Hang Seng School of Commerce campus and buildings located in Sha Tin. In the Master Campus Expansion Plan, four new buildings were developed under Phase I and Phase II. They were the S H Ho Academic Building (Block A), the Sports and Amenities Centre (Block B) and the Lee Quo Wei Academic Building (Block D) and which comprise a total GFA of about 34,000 m² as well as the HSMC Jockey Club Residential Colleges (Site F) comprising three resident blocks housing 1,200 students.



Figure 1: 3D rendering of the campus of Hang Seng Management College

1.2 Sustainable campus approaches

Hang Seng Management College endeavours to maintain a sustainable growth in campus development. As a campus for 21st Century, the College recognises a greater social awareness and demand in the industry and community. Thereby, the College adopted sustainable campus approach which can demonstrate the mission of an educational institution to communicate a sustainable future to young generations.

The campus is not only conceived as a physical space for activities but also a learning campus where students can participate and understand sustainable issues through daily use of the buildings. During the design and construction stages, the concept of sustainable campus was realised by embracing a variety of green design features and the new buildings were awarded Final Platinum (Block A, Block B, Block D) and Provision Platinum (Site F) under the BEAM Plus for New Buildings.

Beyond the design and construction stages of the buildings, sustainable considerations are also integrated into on-going building operation and maintenance with a series of stakeholder engagement programme in maintaining a sustainable campus. The College is a showcase of a holistic development of a sustainable campus in terms of the following approaches:

- Green campus design
- On-going building operation and maintenance
- Stakeholder engagement and community outreach

2. GREEN CAMPUS DESIGN

The development of a sustainable campus started with the conceptual stage of the expansion project. The College adopted a variety of green designs and features in the development of sustainable campus.

2.1 Site planning and design issues

The College took a proactive approach to integrate green elements into site design in order to minimise the adverse impact of the campus expansion to the locality and to enhance the site and its surrounding neighbourhood. The site design fulfilled 100% of all relevant sub-items in the Urban Design Guidelines in Hong Kong Planning Standard and Guidelines. Particularly, a stepped height design approach was adopted for the entire site to optimise the building massing which reserved a visual corridor viewing the ridgeline of Tate's Cairn and allowed a visual connection existing greenery slope from different angles away from the site.

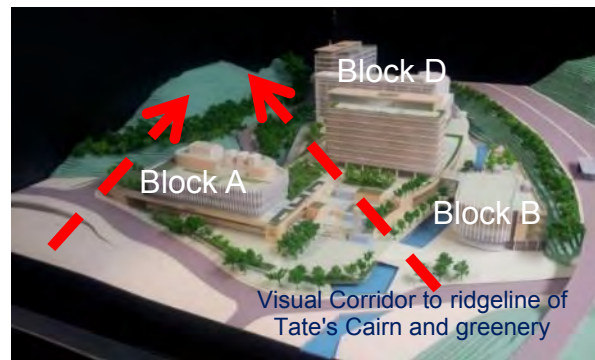

Figure 2: Illustration of stepped height design approach

Within the site, extensive greenery was given more than the statutory requirement for the improvement of the site ecological value while its social value was not overlooked. More than 30% of soft landscape was well blended with different recreation provisions each as lawn, farm, shade for seating facilities, and plaza to provide pleasant environment for students socialisation. Bamboo which is fast-growing, highly adaptable and good at CO₂ absorption was selected as the major species to further maximise the environmental benefits.



Figure 3: Bamboo planting in campus

The design of the site is to realise students' socialisation and personal growth which cannot be distinguished in modern education. With the Open Campus Policy, the greenery, open space, outdoor sitting areas and bicycle racks were provided to encourage site usage by locals and public so as to enhance the liveability of the surrounding areas for the seek of a sustainable neighbourhood.

2.2 Life cycle perspectives in building materials

A careful selection and design in building materials and assembly from cradle-to-grave can greatly improve the building sustainability. Loose fit design was adopted to give flexibility of the multipurpose space to cope with activity changes over time. Modular glass wall partitions inside library are fully demountable, reusable and recyclable, and the partitions are kept away from the false ceiling to avoid disruption due to physical changes in the future. Standardised ceiling panels, doors and classroom furniture was adopted to enable different arrangement with minimum extra components.

Having a tremendously faster growth rate than trees, bamboo is a one of the solutions to preserve trees. The College applied Bamboo extensively in interior fitting-out works and classroom furniture such as bamboo chairs, working tables and shelves. The selection of rapidly renewable products greatly reduced the carbon footprint of a building.



Figure 3: A collection of bamboo furniture

2.3 High performance cooling design and energy efficient system

Given the high proportion of total campus energy consumption in air conditioning system, the College looked for various efficient designs and modern technologies to enhance the energy efficiency and reduce the energy use. The cluster of newly developed buildings enables the condition for developing a Central Chiller Plant System. With the advantage of economy of scale, the Central Chiller Plant which consists of two 950 TR Chillers and two 250TR Chillers can sufficiently provide the cooling for the whole campus. This arrangement reduces the overall cooling capacity with less diversity factor compared with a de-centralised chiller plant for each building, thus, energy consumption can be reduced with the same cooling demand.

To infuse innovative ideas into the detailed design, chilled ceiling system were installed in the Lee Quo Wei Academic Building. This system could significantly reduce annual energy consumption cost of MVAC by 20% in the first year operation. The system also has an active control of fresh air supply with no return air which prevent the cross infection and the spread of disease with sufficient supply of fresh air. The design demonstrates how an efficient system reduces energy consumption without the compromises of services quality. To further reduce the carbon footprint of the site in combating climate change, renewable energy such as PV panels were installed on the roof floor of each buildings residential blocks in the College which could offset 4.3% energy use in common area.



Figure 4: On-site overview of chilled ceiling air conditioning system

2.4 Rainwater and grey water recycling

Utilisation and conservation of water resources is a crucial part of green building design. Simply the application of water saving faucets as well as water closet and urinal devices, the College can achieve an annual fresh water saving by more than 25% and an annual sewage discharge reduction by more than 35% respectively.

Furthermore, rainwater harvesting system was installed to better utilise water resources. The system which consists of pneumatic pump sets and filtration system distributes the treated rainwater to the water tanks for cleansing, irrigation and AC condenser water make-up installations. It is estimated that reclaimed water recycled from rainwater is 2,250 m³/year. With the provision of residence for the students, there is a great amount of domestic wastewater where grey water recycling was regarded as a possible measure in utilising water resources. Grey Water Recycling Treatment Plant was installed in residence blocks which employs a compact biological process and submerged aerated filter. Annual grey water recycled from showers and basin is estimated to be 2,700 m³/year.

2.5 Pleasant indoor environment

Considered that the exposure to daylight can improve health and studying performance, the building design optimised the site topography, layouts in interior spatial design and fenestration design so as to maximise the access of daylight. To prevent glare effect on the building users at the Sports and Amenities Centre, additional shading device system was installed. It also avoids direct view from the outside to protect privacy of the building users.

Indoor air quality is another critical factors for the health and comfort of the building users. Low-emitting paint and sealant were selected for interior fitting out works. Measurements on parameters of both outdoor and indoor pollution sources were also conducted before occupancy according to the benchmark of IAQ Certification Scheme of Hong Kong Environmental Protection Department. The measurement results demonstrated a satisfactory indoor air quality and the Excellent Class of IAQ Objectives were achieved.

Allowing an undisturbed teaching and living environment for teachers and students, acoustic windows were **installed in the residential blocks to mitigate the traffic noise induced from Tate's Cairn Highway**; environmental-friendly bamboo acoustic wall panels were installed in the lecture hall to suit the associated reverberation time for speech clarity; partition with excellent sound insulation and absorption performance were also adopted.

3. ON-GOING BUILDING OPERATION AND MAINTENANCE

On-going building operation and maintenance is an unneglectable part to retain the sustainable campus after occupancy. As a benchmarking, the College is targeted to go through the BEAM Plus for Existing Buildings with the support of the Consultant Team. Several aspects are highlighted to demonstrate the upcoming plan towards a sustainable campus.

3.1. Building management system

In order to better manage the building operation performance, the College installed building management system (BMS) in support of the management of lighting system and MVAC system in particular. This system provides instant data of the operational energy use allocation and demand pattern as well as easy diagnosis of system failure for maintenance. Operation data such as pressure, temperature, flow rate, on/off status for monitoring operation and function are recorded by the system. This enables management to review the overall energy policies and targets in the campus operation based on real life data and analysis.

3.2. Monitoring and audit

It is essential to have continuous monitoring on the environmental performance in order to demonstrate the commitment of a sustainable campus development. Auditing tools such as energy audit, carbon audit and waste audit which comprises a process of inspection, survey and analysis of the energy and resources consumption flow as well as the waste generation streams can help assess the building performance and identify opportunities for improvement. With the assistance of Consultant Team, the auditing systems will enable a continuous improvement in sustainable performance.

3.3. Waste management system

While extensive waste management practice was implemented during the construction period of the College, waste management strategies and categories during the building operation will be greatly altered. As the College is providing resident places for students, food waste is one of the strategic focus on waste reduction. Food waste recycling scheme has been initiated for waste reduction in the College canteen. The food waste will be delivered to a composter for processing. The treated food waste will then be used as the organic fertilisers and applied on the organic farm on the roof top of the Sports and Amenities Centre. The food waste recycling scheme not only serves as a solution in reducing food waste generation, it can also arouse the 3R concepts of reduce, reuse and recycle within the campus.

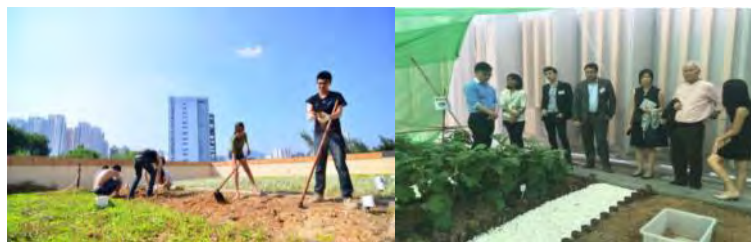

Figure 5: Organic farm on the rooftop

4. STAKEHOLDER ENGAGEMENT AND COMMUNITY OUTREACH

Human culture and knowledge are always an indispensable part in driven a sustainable future. Engaging stakeholders in the process of sustainable campus development **enables direct feedback of users' satisfaction on building performance** and increases the buy in of sustainable initiatives. As an educational institution, the College also intends to advocate sustainable campus development through green education and community outreach programme.

4.1 Sustainability and feedback loops

To strive for a long term sustainable development of the campus, a Working Group on Energy Conservation and Sustainability was formed in 2015 to identify and facilitate implementation of practical measures on energy conservation and sustainability by engaging staff and students. It comprises staff members from the Campus Development and Management Office, Information Technology Services Centre, Student Affairs Office, Vice-President (Organisational Development)'s Office and student representatives who are all major stakeholders of the campus. The Working Group is responsible for conducting regular review of the energy consumption level and measures on sustainability, and identifying practical College-wide initiatives and communication channels to staff, students and the wider community relating to energy conservation and sustainability with the mission to raise awareness of sustainability.

Feedback loop was also established by conducting user survey with staff members and students on the building performance including health, safety and environmental comfort, temperature, noise, light, air quality, ventilation and relative humidity. Consequently, the air conditioning settings were fine-tuned and the operation hour of each building system was revised according to the survey results. The feedback loop provided input for the management to review maintenance policy and energy efficiency policy and highlight the problems that should be duly addressed and solved.

4.2 Green education and outreach programme

As an educational institution, the College does not see the design and management of physical structures as the only opportunity in contributing sustainability. Green education can influence young generations and the community in creating a sustainability culture. A series of green campus events for staff and students have been held in since the year of 2015, including Greening Workshop, Organic Planting Day, Visits on Organic Farm. Three Green campus tours were also organised within the campus in 2016 using the BEAM Plus awarding building blocks as a demonstration on sustainable campus development.

To communicate its sustainable mission to the wider community, the College has been organising various education events. For instant, "HSMC Symposium on Sustainability and Bamboo" was held in collaboration with UNESCO-APEID in Jul 2015. The College presented the campus itself as a showcase of sustainable campus especially on the use of bamboo in replacing wood consumption. Around 300 participants including students from universities and secondary schools, professional bodies' members, the public, HSMC Board and Council members, and staff members joined the events. The event enabled an outreach of a boarder community in enhancing the awareness of sustainability of the students and exchanging experiences with professionals from the broader field of sustainability.



Figure 6: Scenes at the symposium and green campus tours

5. CONCLUSION

As Hang Seng Management College is developing into one of the leading tertiary educational institutions in Hong Kong, it endeavours to maintain a sustainable growth in campus development. The Master Campus Expansion Plan has realised the ideas by embracing a variety of green design features and successfully benchmarked its performance by getting the highest Platinum Rating under the BEAM Plus for New Buildings. Considering the entire building life, the integration of green designs in the new buildings development is regarded as the very first step in the journey of a sustainable campus. After occupancy, the College is preparing to push forward the sustainable system and practice in on-going building operation and maintenance. To further benchmark and improve the sustainable performance, the College is targeted go through the BEAM Plus for Existing Buildings.

As an educational institution, people and community is the core value in campus development. Stakeholders engagement in the management and evaluation of buildings performance and the advocacy of sustainable campus through education and community outreach programme process have been regarded as a crucial part in realising a sustainable campus. With such, the College is a showcase of a holistic development of a sustainable campus for future school or campus development of similar scale in Hong Kong and on an international stage.

REFERENCES

- [1] Hong Kong Green Building Council, *BEAM Plus New Buildings* [Online]. Retrieved from: https://www.hkgbc.org.hk/eng/NB_Intro.aspx [Retrieved on 28 September 2016]
- [2] Planning Department HKSAR, *Hong Kong Planning Standards and Guidelines Ch. 11 Urban Design Guidelines* [Online]. Retrieved from: http://www.pland.gov.hk/pland_en/tech_doc/hkpsg/full/ch11/pdf/ch11.pdf [Retrieved on 28 September 2016]
- [3] Indoor Air Quality Information Centre, *IAQ Certification Scheme* [Online]. Retrieved from: <http://www.iaq.gov.hk/en/iaq-certification-scheme.aspx> [Retrieved on 28 September 2016]
- [4] BEAM Society Limited, *BEAM Plus Assessment Tool* [Online]. Retrieved from: http://www.beamsociety.org.hk/en_beam_assessment_project_1.php [Retrieved on 28 September 2016]

Drive towards Sustainable Development and Management: Case Study on International Commerce Centre

Grace KWOK^a, Timothy SZE^b, Andy LAI^c, Frank CHEUNG^d, Sonia TSANG^e

^a Allied Environmental Consultants Ltd., gk@aechk.com

^b Allied Environmental Consultants Ltd., ts@aechk.com

^c Allied Environmental Consultants Ltd., al@aechk.com

^d Allied Environmental Consultants Ltd., fc@aechk.com

^e Allied Environmental Consultants Ltd., st@aechk.com

ABSTRACT

Hong Kong is one of the most densely-populated, highly commercial, and fast-paced societies in the world. The topic of green construction and sustainable buildings has been a common theme in the industry for quite some time. Popular green building accreditation schemes such as BEAM Plus, LEED, or China GBL are the most often attain green building certification system in Hong Kong; the certification systems act as a driver to ensure healthier, more efficient and environmentally sustainable working and living environment. However, as the life cycle of a typical building in Hong Kong is to be maintained more than 50 years, the operation and maintenance of the building very often plays a more substantial role in maintaining a continuity of the environmentally sustainable life cycle of the building.

This paper presents a case study for the International Commerce Centre (ICC), ICC is the tallest building in Hong Kong, one of the forerunner in terms of environmentally sustainable building; during the design and construction phases of ICC (2003 to 2010), the project has acquired BEAM 4/04 certification, the management office of ICC and some of the tenant offices have acquired LEED Commercial Interiors. In the operational stage, ICC has been operate the building in an environmentally sustainable manner and is current targeting to acquire BEAM Plus Existing Building certification.

This study aims to identify the importance of early planning, integrated design, building management policies, operation and maintenance, and continual monitoring and improvement on the building systems in attributing to a sustainably built and operated building in Hong Kong.

Keywords: sustainable, green body check, high-performance building, education and training, energy saving, green rating tool, green building management

1. INTRODUCTION

Hong Kong is one of the most densely-populated, highly commercial, and fast-paced societies in the world. The topic of green construction and sustainable buildings has been a common theme in the industry for quite some time. Popular green building accreditation schemes such as BEAM Plus, LEED, or China GBL are the most often attain green building certification system in Hong Kong; the certification systems act as a driver to ensure healthier, more efficient and environmentally sustainable working and living environment. However, as the life cycle of a typical building in Hong Kong is to be maintained more than 50 years, the operation and maintenance of the building very often plays a more substantial role in maintaining a continuity of the environmentally sustainable life cycle of the building.

This paper presents a case study for the International Commerce Centre (ICC), ICC is the tallest building in Hong Kong with 118 storeys and Gross Floor Area of 273,000m², one of the forerunner in terms of environmentally sustainable building; during the design and construction phases of ICC, the project has acquired BEAM 4/04 certification, the management office of ICC and some of the tenant offices have acquired LEED Commercial Interiors. In the operational stage, the property management team has been operating the building in an environmentally sustainable manner.

1.1 Sustainability of ICC

ICC was originally designed with 3 buildings blocks, the three building block are then reduced to one building block to open up the outdoor plaza and landscape area, to improve microclimate around buildings. Below are other sustainable measures ICC has adopted, both in its design and operation.

1.2 Air

Fresh air intake of ICC is located on top of podium, away from outdoor pollutant sources. Fresh air is pre-treated by the Variable air volume primary air handling units. The amount of supplied pre-treated air can be varied and controlled by CO₂ sensors. The designed ventilation in tenant spaces supports the well-being and comfort of occupants.

ICC provides regular maintenance of filters on air side system. Titanium dioxide (TiO₂) are provided in areas where pollutants are likely to be arise, such as toilet, lift. Frequent general cleaning is provided in occupied areas to maintain the proper indoor air quality.

Green fit-out guideline is **issued to provide guidance to tenant's fitting-out** contractor to adopt environmental friendly materials and equipment for fitting out works and comply with the requirements on green working manner.

ICC has obtained Excellent Class in HKSAR IAQ Certification Scheme and IAQwi\$e. The HKSAR IAQ Certification Scheme is a voluntary scheme for offices and public places, to improve the indoor air quality (IAQ) and promote public awareness of the importance of IAQ. The IAQwi\$e Certificate is to encourage and recognise participants achieving IAQ standards beyond the HKSAR IAQ Certification Scheme requirements. To achieve Excellent Class in IAQwi\$e, participants are required to obtain Excellent Class in HKSAR IAQ Certification Scheme, and demonstrate achievement(s) in education or promotion of IAQ awareness amongst stakeholders or general public. Both of the certificates are valid for 12 months, ICC renews the HKSAR IAQ and IAQwi\$e certificate annually, to **show continual improvement in ICC's IAQ.**

1.3 Noise

ICC is situated next to the Western Harbour Crossing, West Kowloon Highway and above MTR Kowloon station. To provide a good acoustic environment of ICC, enhanced acoustic insulation, like Integrated Glazing Unit System is provided to minimise the intruding noise from nearby traffic and fixed plant noise.

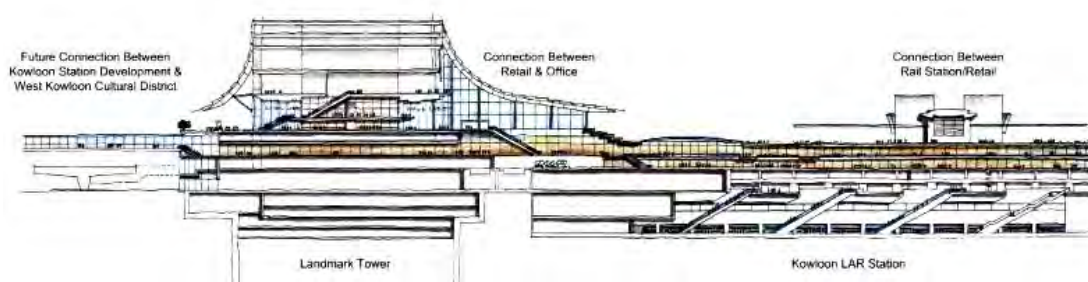

Figure 2: Section of ICC podium

Noise and vibration control measures are also adopted in building services equipment in ICC. All mechanical equipment are installed with vibration treatments to mitigate noise and vibration transmission.

1.4 Energy

During the design stage, daylight analysis was conducted to optimise the daylight assess and the use of artificial lighting. Low-e glass was chosen for the curtain wall system together with a depth restriction design on office room to maximize effective daylight access. Daylight access is also enhanced by the "dragon-tail" atrium located on the north side of the tower, beneath a roof formed by the shingled scales of the façade. The "dragon tail" atrium is shown in Figure 2 above.



Figure 3: Curtain wall system of ICC

Comprehensive metering infrastructure were incorporated during design of ICC, Power management system connected with various E&M systems and equipment were installed to monitor energy use and power quality. This system enables the estate management to audit the energy performance, setup the benchmark, setup the energy goals and targets, and establish the policy and action plan.

Chiller plant control system optimizer is adopted in chiller plant control system which optimises sequencing control of chillers and cooling tower to meet the cooling load with the most energy efficient manner.

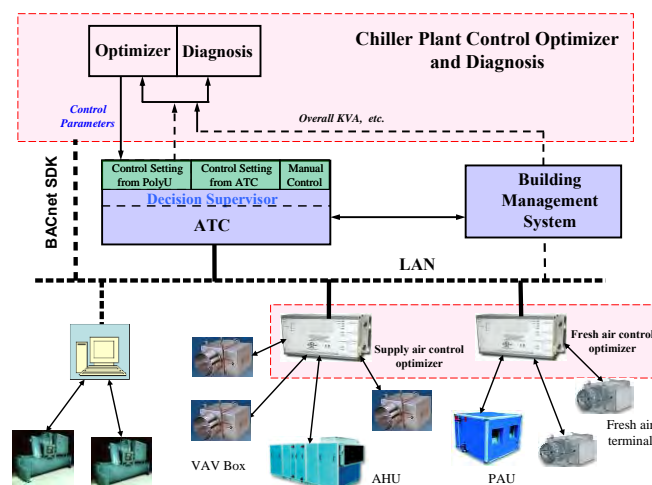

Figure 4: Chiller plant control system optimizer

ICC has undergone an energy optimization study to develop energy efficient control strategies, which mainly involve optimal chiller sequencing control, cooling tower sequencing control, optimal water pressure differential set-point control, AHU supply air static pressure rest control and DCV-based fresh air control, optimal chilled/cooling water temperature set-point reset strategy etc.

Double deck lift with destination control system is provided in ICC to maximise the efficiency. This system shortens the waiting time in lift lobbies and riding time in lift cars, provide optimised elevating service for passengers. Power is also regenerated from the lifts during braking and connected to the supply network, thus to reduce energy consumption. It helps boosting up the handling capacity by 15%.

ICC adopts energy saving management activities including turn off the escalators during non-peak hours, suspend half of the passenger lifts during non-peak hours at various zones, switch off the normal lighting at common area during non-office hour for various zones and shorten the running hours for air handling units at Sky Lobby. These activities save 142,143 kWh in total annually.

ICC is one of the first buildings to obtain ISO 50001 Energy Management standard, ICC's ISO 50001 was granted in 2011. ICC also obtained Excellent Class in the Energywi\$e Certificate annually starting from year 2011. Energywi\$e is to encourages participants to adopt energy reduction measures covering the key energy consuming

facility. To achieve Excellent Class in Energywi\$e, participants are required to fulfil 50% and 9 or more additional pre-set energy saving targets.

Moreover, there is a provision of energy audit service to ICC tenants upon request. Energy consumption analysis with energy management opportunity will be offered to the tenants.

1.5 Sustainable material use

To reduce construction waste and carbon footprint of the construction materials of ICC, the life cycle approach during the construction was adopted by using environmental friendly materials, such as high portion of PFA (35%) in concrete, structural steel with postconsumer recycled content, steel couplers, non-ozone depleting materials, certified wood and recyclable materials.



Figure 5: Environmental friendly materials

1.6 Water

During the operation, ICC adopts various measures to recycle the water waste as far as practicable. Bleed-off water from cooling tower plant is recycled for flushing water use to reduce consumption of flushing water. Condensate water from AC system is collected and recycled for cooling tower use. Native and drought-tolerant plant species are selected to reduce irrigation water use.

1.7 Waste

ICC provides the waste compactor and food waste decomposer in the refuse room to reduce the carbon emission of transport of waste and to reduce food waste.



Figure 6: Waste compactor and food waste decomposer

ICC has obtained the Excellent class of the Wastewi\$e Label annually starting from October 2011. Wastewi\$e is to encourage Hong Kong organisations in adopting measures to reduce the amount of waste generated within their establishments or generated through the services and products they provide and recognise the waste reduction efforts of those companies. A series of management strategies are adopted to reduce waste. Waste management programme and glass bottle recycle scheme in ICC increases the recycling rate of paper, aluminium cans, plastics and glass. Green housekeeping reduces the wastage of materials by updating the checklist of stock, and 'First-In-First-Out' principle to avoid materials expired before consumption.



Figure 7: Green housekeeping and glass bottle recycling scheme

1.8 Green Body Check

On top of all the works being carried out, ICC did not cease to improve continuously. In order to further quantify and qualify the sustainable built environment in ICC, a “Green Body Check” in 2016 based on Hong Kong Building Environment Assessment Method (BEAM) Plus Existing Building(EB) Version 2.0 Comprehensive Scheme, is proposed to be conducted in the building thoroughly. The following areas are focused in terms of BEAM Plus (EB):

Management

Objectives, policies and procedures were reviewed to ensure a sustainable operation manner. It included management on green procurement, ISO 140001 & 50001, proper operation and maintenance, indoor air quality and pest control, etc.

Site aspect

The site location was reviewed regarding the adequacy of local amenities and public transport provisions, reduction of travel needs and reliance on private vehicles. Also, to minimise any potential negative impacts on the neighbours, noise and light pollution controls were reviewed and seen if necessary actions shall be taken. Another features related to the reduction of heat island effect and amenities features for O&M and building users, were also reviewed.

Material use

Proper material purchase and disposal could reduce environmental pollutions via manufacturing and disposal process. The review included material purchasing plan, avoidance the use of ozone depleting substance, waste and food waste management, recycling facilities and establishment of waste reduction target and etc.

Energy use

The energy consumption by the building services system were assessed by comparing with the benchmarks derived from audits of similar building type. It included energy management, and analysis, regular commissioning, comparison of benchmark and future improvement and etc.

Water use

The quality and quantity of the water use were assessed through management and audit. It included water conservation plan, provision of water efficiency devices, water quality survey, reuse of process water, regular plumbing and drainage inspection, water metering and audit and provision of twin tank system for fresh and flushing water and etc.

Indoor environmental quality

The indoor environment qualities were checked which might impact on the human health and comfort, as well as improvement of quality and functionality. It included ventilation, thermal comfort, hygiene, indoor air quality, control of environmental tobacco smoking, room acoustic and background noise and etc.

Innovation

Innovative ideas and designs were discussed and determine the feasibility of new innovations in order to achieve more ambitious targets and exemplary performances.

2. FINDINGS AND RECOMMENDATIONS

Using BEAM Plus for Existing Building as a tool, a range of workshops with the building management team were **conducted as “Green Body Check”**. **Operation and management best practices previous developed and implemented** have been appreciated by the certification tool. Moreover, some improvement opportunities or value-adding actions were identified for considerations by the team.

2.1 Management plan and action

Occasionally, management practices were implemented but the formulation of procedures or plans were not **developed and often the intended goals or targets cannot be executed effectively**. From the result of **“Green Body Check”** carried out, **green purchasing plan and water conservation plan were not developed and are thereon** produced by the team and implemented thereafter.

Procurement of equipment and goods are carried out by the procurement department where environmental friendly products are always considered. However, the range of equipment and goods under governing or the environment attributes of products are not clearly identified. After the implementation of the green purchasing plan, the team can set the specify goals and targets for the procurement of the governing products, but also setting guidelines/ requirement on the environment attributes of the products.

Water Conservation is one of the major targets of ICC, water saving opportunities were previously investigated such as reducing the water usage of cooling system. However short term and long term water saving targets, the method of monitoring water consumption and regular water audits were not scheduled. With the addition of water conservation plan in place, the team can regularly monitor the water consumptions, conduct water audit and implement the water conservation plan regularly to reduce the water use in an orderly manner.

2.2 System audit

“If you don’t measure, you cannot improve”. In order to clearly set out the goals and target for different environmental performance of building, a range of audits shall be conducted regularly to benchmark the environmental performance of the building. The frequencies of each audit shall be set in corresponding plans and procedures for the management team to follow.

Energy and water audit shall be carried out yearly to determine the energy and water usage of the building systems, **to continuously benchmark ICC’s performance in respect to Hong Kong and/or International green building standards**.

Indoor air quality monitoring shall be carried out regularly to determine the air quality of the internal occupying spaces of the building.

Comfort surveys with regards to thermal, acoustical and possible nuisance caused by odour or vibration shall be regularly carried out to investigate if any problems where raised.

2.3 Management opportunity

Based on the findings on regular audits and feedbacks from stakeholders, management opportunities can be explored in greater details, and continuous benchmarking can give the management directions and focal points for improvement strategies. Thus, it is most importantly to allocate resources and manpower efficiently and strategically.

3. CONCLUSION

International Commerce Centre not only is the tallest building in Hong Kong, it is also one of the best managed buildings in Hong Kong. The facilitate management team of ICC well understands the fact that a sustainable management is as important as the sustainable design of the building where the building is anticipate to operate more than 50 years and perhaps more.

However, even when the facilitate team is operating the building in an effective and sustainable manner, regularly checking and continuous benchmarking the buildings performance against recognized green building schemes or other equivalent tools would drives the team further in achieving more ambitious goals and create continuity in their operation.

REFERENCES

- [1] BEAM Society Limited, March 2016, BEAM Plus Existing Building Version 2.0 [online]. Retrieved from: http://www.beamsociety.org.hk/files/download/BEAM%20Plus%20Existing%20Buildings%20v2_0_Comprehensive%20Scheme.pdf [Retrieved on 29 Sept 2016].
- [2] Hong Kong Green Organisation Certification,2016, Guidebook for IAQwise Certificate [online]. Retrieved from: http://www.hkaee.gov.hk/english/hkgoc/iaqwise_certificate/files/IAQwise_GB_eng_Apr2016.pdf [Retrieved on 29 Sept 2016].
- [3] Hong Kong Green Organisation Certification,2016, Guidebook for Energywise Certificate [online]. Retrieved from: http://www.hkaee.gov.hk/english/hkgoc/energywise_certificate/files/Energywise_GB_Eng_Apr2016.pdf [Retrieved on 29 Sept 2016].
- [4] Hong Kong Green Organisation Certification,2016, Guidebook for Wastewise Certificate [online]. Retrieved from: http://www.hkaee.gov.hk/english/hkgoc/wastewise_certificate/files/Wastewise_GB_Eng_Apr2016.pdf [Retrieved on 29 Sept 2016].
- [5] The Government of the Hong Kong Special Administrative Region Indoor Air Quality Management Group, September 2003, A Guide on Indoor Air Quality Certification Scheme for Offices and Public Places [online]. Retrieved from: <http://www.iaq.gov.hk/media/8694/certguide-eng.pdf> [Retrieved on 29 Sept 2016].

Intelligence, Collaboration, Continuity – A Case Study of Improving the Environmental Performance of an Office Building

Lewis LAM Yu-Hin^a, Patrick LEUNG Chi-Fai^b, Bonny WONG Yee-Ting^c

^a Kai Shing Management Services Limited, Hong Kong S.A.R. (China), lewislam@kaishing.com.hk

^b Kai Shing Management Services Limited, Hong Kong S.A.R. (China), patrickleung@kaishing.com.hk

^c Kai Shing Management Services Limited, Hong Kong S.A.R. (China), bonnywong@kaishing.com.hk

ABSTRACT

Commercial Buildings Consume A Large Portion of The Total Energy Consumption In Hong Kong And Energy Use Is A Major Element Contributing to The Emission of Carbon And Global Warming. Facilities Managers Have To Be Conscious of Their Roles in Shaping the Use of Energy of Buildings. Through Employing Available Technologies, Collaborating With Stakeholders From Within The Building and The Community As Well As Continuing Sustainable Facilities Management Practices, It Is Possible To Improve The Environmental Performance Of Commercial Buildings. The Tallest Commercial Building In Hong Kong Would Be Used As A Case Study To Illustrate How This Model Could Be Applied And The Results That Have Been Achieved That Could Derive A Win-Win For Businesses And The Society.

Keywords: high-performance building, corporate social responsibility, energy

1. INTRODUCTION

1.1 Our present environmental challenges

From construction to demolition, stocks of buildings in the built environment are the major consumer of energy. Over 68% of the greenhouse gas that leads to global warming is attributed to the burning of fossil fuels to produce energy. According to the Electrical and Mechanical Services Department (EMSD) in Hong Kong (HK), among all facilities in commercial buildings, air conditioning system consumes most of the energy (26%). Other mechanical systems such as lifts and escalators are also at the top of the chart. This pattern of energy consumption among **HK's buildings is no different from other metropolitan cities worldwide, thus making this issue of global significance.**

Apart from energy, **waste management is another important issue in HK. Based on 2013's data from the Environmental Protection Department, 63% of the municipal solid waste went to landfills with 37% waste could be recycled.** The existing 3 landfill sites in HK are about to saturate with one as early as 2017. With little alternatives to handle municipal solid waste, there is an urgent need in HK for all to act immediately to support the waste reduction movement.

Unlike new buildings that could take advantage of the latest energy efficient technology and waste separation facilities during the design stage, the performance of the existing building stocks would have to resort to other ways to improve their environmental performance. With proactive management strategy, diligent and practical work approach, it is feasible to achieve energy and waste reduction in existing buildings. This does not give rise to instant upgrading of facilities and render the existing facilities immediately useless.

1.2 Important role of property and facility management professionals

Property and facility managers (PFM) who run buildings, have an active role to play. PFM take care of all aspects **of the building during the building's life cycle. With efficient building operation and good maintenance of** facilities, owners and occupants are benefited while environmental impacts of buildings could be minimized.

PFM not only take care of the basic functions such as security, cleaning and maintenance of building facilities but they also take care of occupants' **needs, the building's community and the society at large. It is often assumed that** the building management staff would operate the building according to the design of the architect and building consultants. Very often, there is a mismatch between the design intent and the actual operation of the building. In a less than optimal operation setting such as the number of occupants fall short of expectation, the building facilities may not be fully utilized and wastage could occur. Besides, since buildings consume a large amount of energy and

produce a significant amount of waste, PFM have the responsibility to evaluate the operational needs and adjust the use of resources to drive for optimality.

2. A THREE-SPHERE FRAMEWORK FOR BUILDING OPERATION

In order to improve the environmental performance of buildings, thus minimizing the environmental impacts of buildings to the society, we propose PFM to implement a three-sphere framework in their operation incorporating elements in the form of intelligence, collaboration and continuity. This framework can be applied and adapted to all types of buildings.

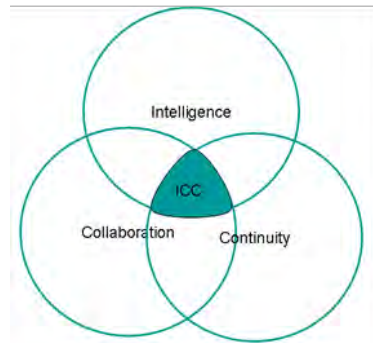

Figure 1: Intelligence, collaboration and continuity framework

2.1 Intelligence - Integration of people, place, process and technology

The task of the PFM is to integrate people, work process, place, and technology. It is only when these four elements are considered will the building achieves its optimal operational efficiency. There are a few layers of intelligence. **First of all, there is people's intelligence.** Intelligent people are those who possess sufficient know-how, make informed choices by studying the operating data of buildings and make decision based on balancing interests of stakeholders and the environment. Well planned on-going trainings and exercises will ensure the members of the PFM possess the necessary skill sets to operate the building efficiently.

The second layer of intelligence relates to process intelligence that could lead to improvement. PFM must also make use of various different processes that help to track the building performance effectively. One of which is to follow a process in designing, undertaking, tracking and improving the building operations by applying the plan-do-check-act quality management process. The application of ISO 14001 Environmental Management System to the building management would enable a systematic process keeping track of the data with measurable metrics to evaluate the effectiveness of different improvement programs.

The third layer of Intelligence refers to the use of intelligent building facilities that has provided PFM with performance tracking and feedback mechanisms. The intelligent systems help to collect data and make them appear in a meaningful data format for the ease of analysis. The use of Building Management System (BMS) is one of the ways in which multiple facilities can be controlled and monitor. It also helps to ease operators dealing with repetitive tasks resulting in productivity improvement.

2.2 Collaboration - Vitalizing the trade experts and recognising the contributions from stakeholders from within and outside the building environment

Collaboration refers to the process in which people work together with the same goal to achieve in their mind. There are altogether three-tier of collaborations.

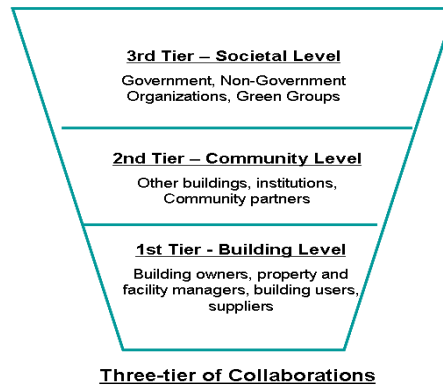

Figure 2: Three-tier of collaborations

In the primary tier, collaboration is done within the building. This tier of collaboration involves building owners, PFM, suppliers and building users. These four entities work together in order that a common goal such as minimizing the environmental impacts in the course of the building operation could be achieved. The building owner acts as the driver for the goal of minimization of environmental impacts while PFM execute the process by working together with suppliers and building users.

The secondary tier covers the local community. This level of collaboration will start to work outside the building and with people who have the stakes in the community, thus benefiting the environment through sharing of good practices.

The tertiary tier covers the societal level collaboration. The Government and organizations operating on a territorial-wide platform from time to time put forward schemes and programmes of raising the awareness of citizens about environmental protection. **PFM's participation in the new programmes could lead to building management tasks** being conducted in a more environmentally friendly manner.

2.3 Continuity - Working towards a common goal of reducing environmental impacts

While it is good by setting up a common goal and starting to work with stakeholders from within and outside the building environment, those benefits could only have lasted if the good cause is applied continuously and in a consistent and sustainable manner. The application of the life cycle testing and commissioning method in the building operation is one of the ways to sustain good building operational practices. Building owners and PFM should take a long term view by first conducting a short to medium term resource allocation plan to support building operation. With this plan, building users can also obtain a clear picture of how the building is going to be operated consistently and prepare themselves to adapt to the building practices that will be good for the environment.

3. CASE STUDY

We shall make use of a commercial building as a case study which has applied this 3-sphere framework in its operation.

3.1 History and background

The commercial building is situated in the West Kowloon and is classified as a super-tall building. The building is built on top of mass transit rail station. It is a composite building with over 80% of floor area used as office premises serving over ten of thousands of people forming a new neighbourhood in the district. The building is equipped with mega scale chilled water plants, cooling towers and close to 100 lifts and a large number of escalators. With the large building scale and the associated population, the consumption of energy and the waste production are expected to be significant. With minimizing the environmental impacts of this building in mind, these two items must be controlled and monitored.

3.2 Design and environmentally friendly construction

The building is designed based on the HK green building standard, the Hong Kong Building Environmental Assessment Method (BEAM) under version 4/04 new building category and achieving a high rating at that time. From both the cost and the environmental protection point of view, the tenants are encouraged to adopt green interior fit-out standards such as BEAM Plus Interior and LEED (Leadership in Energy and Environmental Design) for Interior Design and Construction and work together with the building owners, the architect and the PFM to achieve the standard.

3.3 Putting framework into practice

The company that operates the building has clear goals and visions that have put environmental protection in their **top agenda of businesses. In line with the company's vision and mission, the building's PFM has instituted the cultural of 'greenkeeping is a habit' into its operation.**

3.4 Intelligence - Smart people operate intelligent system

The building is operated by a team of building management professionals in the scale of about 200. The building management team has qualified professionals who are affiliated to various different professional institutions and the key members of staff have achieved green building professional accreditations. Their know-how can enable them to identify the environmental issues associated with their daily tasks and devise suitable ways to resolve those issues.

In order to effectively identify and conduct appropriate measures to minimize the environmental impacts from the building operation, the building management team has instituted different process intelligence into its operation based on the requirements of BEAM Plus (Existing Building), ISO 50001 Energy Management System, ISO 22301 Societal-security Business Continuity Management System and OHSAS Occupational Health and Safety Management System. The use of quality management cycle is the cornerstone of their operation.

BMS is used to facilitate the operation, control and monitoring of building services. BMS engineers are stationed in a central control centre to ensure all parts of building system is under good condition and any abnormality will be observed at an early stage to eliminate possible interruption to the systems and minimize unnecessary disturbance to building users. Power Monitoring System (PMS) is added as an additional module to analyze data to capture the peak and off-peak as well as seasonal variations. Optimization of energy usage is done by gathering **and analyzing various different sets of data followed by adjusting the system's operational parameters.**

Energy saving opportunities are sought by optimizing air conditioning system operating parameters together with professionals in the field and continuously explore cutting edge practices with scholars from universities. For instance, robust chiller sequencing control and optimal control of cooling tower using hybrid quick search method are some of the examples that no additional hardware is required to be added. Energy audit is carried out yearly by independent and qualified energy assessor to help the team identifying further areas for improving the energy performance.

3.5 Management by walking around (MBWA)

Additional process like MBWA is instituted in the team's operation. MBWA requires the management and supervisory staff members of the building conducting regular inspection covering all areas as a housekeeping good practice. This corresponds to the first level of energy management opportunity conceptualized by BEEO (EMO I). Through MBWA, some of lamps were taken out and the lumens of some of the lamps were dimmed. Some facilities were turned off for several more hours daily for energy saving. Some corridors were cordoned off and occupants were re-directed to use other passageways to minimize the use of energy during non-peak hours.

3.6 Integrated waste management

An integrated waste management plan has been adopted. The building management team has worked together with the tenants to educate the occupants on waste reduction and recovery of waste for reuse and recycling purpose. A central waste recycling facility is made ready for tenants to handle recyclables. A total of 26 types of recyclables are collected from tenants. The collected recyclables will be distributed to responsible and reputable

non-Government organizations for handling. Food waste from tenants, hotels and restaurants are collected with onsite decomposer to further reduce the waste load. The composite decomposed from food waste is mainly used **by gardeners to work on the building's landscape features with the rest taken to other organic farms in the New Territories.**

3.7 Collaboration - Promotion and education

Tenants are invited to give out their ideas and suggestions on green practices through regular meetings with building management staff. Bi-monthly news flash is provided to occupants about the latest green practices of the **building management, helping the management to raise occupants' awareness of maintaining a low carbon office environment.** Various kinds of campaigns are launched to raise awareness of occupants on green management. **These include "Celsius 26" campaign. This campaign encourages occupants to set a higher temperature inside their premises with the indoor temperature of all common areas set to 26 Degree Celsius.** For waste management **campaign, the 'Say No to Disposable Utensils' campaign encourages more occupants to bring their own utensils to work place and reduce the disposal of plastic.** The indoor air quality is maintained at a high level based on the local and international standard.

In addition, as a way to demonstrate their commitment towards reducing the environmental impacts of building operation, the building management has agreed with tenants to setup and make available a comprehensive environmental management plan on dealing with environmental issues and on reducing environmental impacts to the community and society. Tenants are consulted to establish waste separation facilities inside their premises for the ease of sorting and sifting waste.

On the community level, the building management has delivered presentations in various seminars and share energy management and green initiatives with different participants including business leaders, stakeholders and students. Through these sharings, best practices can be exchanged with participants and existing building performance can be reviewed and reflected upon based on insufficiency. Professionals, local and overseas property management companies, education institution have visited to the building.

On a societal level, the building has participated in different kinds of schemes and programmes which aim to promote environmental protection awareness among citizens in the society. The building has joined all the programmes put forward by the Hong Kong Awards for Environmental Excellence (HKAEE). This includes the **HKAEE's sectoral award under the property management sector, the continuous participation of the waste reduction programme, indoor air quality maintenance programme, energy reduction program and carbon reduction programme.** The building management has participated in these programmes for more than 5 years consecutively. The building management of the building has raised its standard by joining the low carbon-office operation programme (LOOP) initiated by the Hong Kong World Wild Fund for the past 5 years. The participation of these programmes requires support from tenants, occupants and staff in order that measureable carbon reduction could be tracked and monitored.

3.8 Continuity

The building owners and building management has committed to a long term view of environmental protection and minimizing the environmental impacts of the building to community and society. The essence of corporate social **responsibility, the triple bottom line and the 'use less, waste less' culture are instituted in the team during the operation and maintenance.** For instance, materials and supplies are selected that can last for 5-10 years and reduce the need for short term replacement. It also continuously maintains the established processes and best practices such as the adoption of the latest green building standard, demonstrating their competence and commitment to independent auditors of ISO 9001 Quality Management Standard, ISO 14001 Environmental Management System, ISO 50001 Energy Management System, ISO 22301 Societal security - Business continuity management systems and OHSAS 18001 Occupational Health and Safety Management Standard. In addition, continuously participating in schemes and programmes put forward by the Government and other green groups is **a way to support the Government's initiatives on energy saving and waste reduction.**

3.9 Result

In terms of energy consumption, Figure 1 shows the total energy consumption of the building in the past 5 years. Following the above-mentioned framework with careful execution of good building management practices, the total energy consumption of the building has dropped with over 10 million kWh of energy was conserved. There is also **a continuous decreasing trend throughout the 5 years. Besides, the building's Energy Utilization Index (EUI), a measure of energy consumption in buildings, has also reduced from 153kWh/m²/annum to 136 kWh/m²/annum up to 2016, see Figure 2. The carbon emission has also followed by a decreasing trend, see Figure 3.**

In view of waste recycling, successful waste recycling begins with waste separation in which the participation rate of waste separation recycle programme increased from 60% in 2010 to 90% in 2016. The recyclables collected increased from 96,000kg in 2013 to 120, 000kg in 2016 with 25% increment, see Figure 4.



Figure 1: Annual energy consumption from 2012 to 2016



Figure 2: Trend of energy utilization index (EUI)

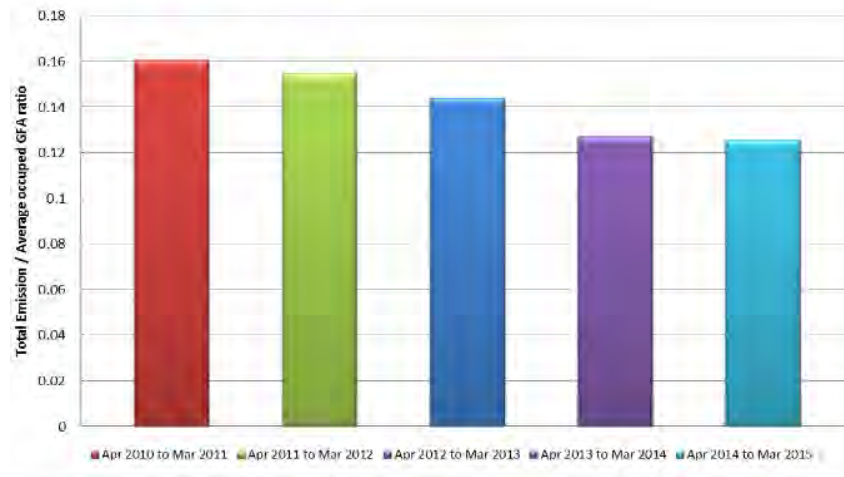

Figure 3: Trend of carbon reduction

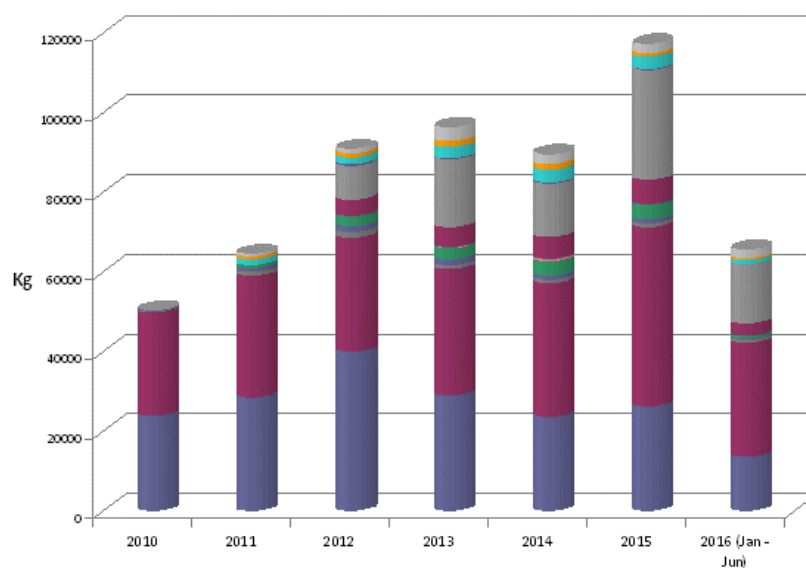

Figure 4: Annual recycle quantity from 2012 to 2016

4. CONCLUSION AND SUMMARY

The resources being used to construct and operate a commercial building will bring environmental impacts to the society. The existing building stocks account for the most of the building stocks in HK and there is a need to keep track of the environmental performance of existing building stocks. A 3-sphere framework incorporating intelligence, collaboration and continuity is proposed that could be applied to the operation of existing commercial buildings. The framework essentially integrates the people, process, place and technology working from the building level towards the societal level. The framework requires a long term commitment of building owners and building management to maintain but the benefits to the environment could be significant. This framework has been applied to a commercial building and good results have been achieved in terms of minimizing the energy usage and waste production. This framework can be applied to other buildings and further developed to derive a universal model of building operational practices for the good of the environment.

REFERENCES

- [1] EMSD, Hong Kong Energy End-use Data 2015
- [2] Environmental Protection Department of Hong Kong, Retrieved from: <http://www.epd.gov.hk>
- [3] Department of Building Services Engineering (BSE), Report of Building Energy Efficiency and Life Cycle Commissioning, Department of BSE, the Hong Kong Polytechnic University

(6) A Collaborative Approach in Delivering Low Carbon Living Session Organiser: Arup

Session 4.9

SESSION OUTLINE

To make a sustainable environment into reality, many parties are needed. To start, we need investors that have a vision to provide the resource to kick start a project. Next, we need to have developers to put together a team to plan and execute projects that focus on sustainable development. During the design of the projects, architects and consultants need to work closely with all the relevant parties to bring the vision into the physical world. In this session, UBS have been working with investors that are keen to creating sustainable projects. We also have New World Development Company Limited to share about the projects that realized in the recent years. KPF is a well-known architect firm that delivers many sustainable buildings around the world. Lastly, we also have Arup as a total engineering consultant to share a holistic approach to integrate multi-disciplinary professionals in realizing many green and sustainable projects.

After the individual presentations, the panel will provide their views in how working together is the key success of creating the new sustainable world for our future.

SESSION CHAIR

Jimmy CK TONG, Associate & East Asia Energy Skill Leader, Arup, Hong Kong SAR

SPEAKERS AND PRESENTATION TOPICS

1. Beyond Energy and Resource Efficiency: Sustainable Building in Digital Transformation
Vincent CHENG, Director of Building Sustainability, Arup, Hong Kong SAR
2. Investing for Longer-term Development: Financing the New Generation in Sustainability
Carl BERRISFORD, UBS Wealth Management, Head of Sustainable Investing, APAC Chief Investment Office, Hong Kong SAR
3. Creation of Green Neighbourhood
Edwin CHAN, Project Director, New World Development Company Ltd., Hong Kong SAR
4. Tall Buildings and Sustainability
Florence CHAN, Director, Kohn Pedersen Fox Associates PC, Hong Kong SAR

(7) Powering Up Smart City Session Organiser: CLP Power Hong Kong Ltd.

Session 2.13

SESSION OUTLINE

CLP's session will include building management of Hong Kong Airport, world-class Data Centre, smart power control from Science Park and CLP's energy management services. Our moderator will introduce the speaker background and do a shorten wrap up after each topics.

Presentation Rundown:

Powering Up for Brighter Tomorrows *by CLP*

- In this digital era, CLP has been proactive in innovating smart energy solutions to meet and exceed the expectations of our business and residential customers, and striding towards a smarter city.

Big Data Era for Building Management *by Airport Authority Hong Kong*

- Pilot trial of utilizing big data to enhance building management at North Satellite Concourse is completed in Feb 2017. The cloud-based software uses powerful analytics and performance monitoring dashboards to promote proactive operations, such as predictive maintenance and energy saving opportunities identification.

Smart Power Control for Peak Load Compensation *by Hong Kong Science and Technology Parks Corporation*

- Power supply at peak load is always inefficient and expensive. Capacity of electrical installation needs to cater for the peak load. Hence there is much benefit in reducing the peak load – reduce the use of less efficient generator, defer the transmission and distribution system upgrading, reduce the electricity tariff and finally, the reduction of CO2 emission. This presentation shows the experience in using a smart power control for peak load compensation in one of the buildings in Hong Kong Science Park

How Hong Kong to be a Data Centre Hub in Asia in the Next Decade *by Hong Kong Data Centre Association*

- Role of data centres in smart city development and how Hong Kong to be developed as a data centre hub in Asia in the next decade, especially when facing stiff competition from other Asian countries such as Singapore, Taiwan and Japan.

SPEAKERS AND PRESENTATION TOPICS

1. Powering Up for Brighter Tomorrows
Eric CHEUNG, Senior Director – Customer & Business Development, CLP Power (Hong Kong) Ltd., Hong Kong SAR
2. Big Data Era for Building Management
Amen TONG, General Manager, Technical Services, Airport Authority Hong Kong
3. Smart Power Control for Peak Load Compensation
Clement WONG, Head of Facility Management Hong Kong Science and Technology Parks Corporation
4. How Hong Kong to be a Data Centre Hub in Asia in the Next Decade
Charles LEE, Founder and CEO OneAsia Network Limited & Newtech Technology Co Ltd

(8) Healthy and Sustainable Building for Resilient Future

Session Organiser: Link Asset Management Ltd. / Nan Fung Development Ltd.

Session 1.13

SESSION OUTLINE

The new commercial development at 77 Hoi Bun Road, Hong Kong, is a fine business case for developers in building Green Buildings, which has been a global trend in the last decades.

Climatic challenges, energy performance, efficient use of resources, users' health and wellness, ease of maintenance and safe operations of the building systems, site impacts and amenities as well as neighbourhood engagement have all been carefully considered by the multi-disciplinary team with an aim to achieve new benchmark for Grade-A office buildings.

Nan Fung Development Ltd. and Link REIT both have strong commitments to the environment, and sustainable development is central to their business philosophies:

- **Nan Fung will share the developer's perspective on how their vision is being realised through sustainable new and revitalization developments.**
- Link will share about the green building projects and corporate initiatives they have implemented in recent years.
- Arup will share the leading trends in resilient future building designs.
- P&T Architects and Arup will share on the holistic design approach in realizing the exemplary next generation commercial building.

Speakers will hold a panel sharing session on how an integrated design approach is the key to future sustainable and healthy development.

SESSION CHAIR

Chris KWAN, Senior Project Manager, Project & Planning, Link Asset Management Ltd., Hong Kong SAR

SPEAKERS AND PRESENTATION TOPICS

1. Green Buildings - The Foundation for Sustainable Development
Calvin Lee KWAN, General Manager- Sustainability, Link Asset Management Ltd., Hong Kong SAR
2. Nan Fung's Corporate Initiative for New and Revitalization Development
Samuel WONG, Deputy General Manager, Project Dpt., Nan Fung Development Ltd., Hong Kong SAR
3. Leading Edge Trend for Resilient Future Building Design
Vincent CHENG, Director of Building Sustainability, Arup, Hong Kong SAR
4. Exemplar Next Generation Commercial Development - NKIL6512
Bing KWAN, Director, P&T Architects and Engineers Ltd., Hong Kong SAR
Alvin LO, Associate Director of Building Sustainability, Arup, Hong Kong SAR

(9) Sustainability Assessment of Buildings as Part of Green-Public Procurement Based on the German BNB-System

Session Organiser: Division Sustainable Building, Federal Institute for Research on Building, Urban Affairs and Spatial Development (BBSR), Germany

Session 2.14

SESSION OUTLINE

In Germany, adherence to the principles of sustainable development is an essential aspect of procurement by the public authorities. This applies both to the planning and construction of new buildings (high performance buildings) as well as to modernization projects (deep building renovation). The Federal Ministry for the Environment, Nature Conservation, Building and Nuclear Safety (BMUB) formulated with the Guideline for Sustainable Building essential requirements for Federal Buildings. The Assessment System for Sustainable Building (BNB) provides a tool which supports planning and evaluation and is used in public procurement. It is freely accessible on the internet. The BNB simultaneously and equally addresses the classic three dimensions of sustainability and the technical implementation and the planning process as cross-sectional qualities. Both LCA and LCC are used.

In the workshop, the BNB will be presented using the example of the modernization of school buildings and the planning of research and laboratory buildings. Practical examples from Germany and Austria will be explained. In other lectures, possibilities for the increased use of renewable raw materials as well as tools for the support of integrated design are discussed.

The workshop is aimed at representatives of the public sector as well as developers and users of planning and assessment tools. In the moderated discussion, the public authorities deal with certification systems as well as the importance of integrated design for sustainable construction.

SESSION CHAIR

Thomas LÜTZKENDORF, Director, Centre for Real Estate; Head of Chair, Sustainable Management of Housing and Real Estate, Karlsruhe Institute of Technology, Germany

SPEAKERS AND PRESENTATION TOPICS

1. Sustainability Assessment of Buildings as Part of Green Public Procurement – An Introduction
Thomas LÜTZKENDORF, Director, Centre for Real Estate; Head of Chair, Sustainable Management of Housing and Real Estate, Karlsruhe Institute of Technology, Germany
2. The Assessment System for Sustainable Building BNB by Taking the Example of the Complete Refurbishment BNB Module for Educational Buildings
Julia MÜLLER, Federal Institute for Research on Building, Urban Affairs and Spatial Development (BBSR), Germany
3. Sustainable Building Assessment System for Research- and Laboratory buildings - Austrian and Swiss Perspective on the BNB Applicability
Alexander PASSER, Assistant Professor, Graz University of Technology, Austria
4. Natural Resources and Sustainability
Eike ROSWAG-KLINGE, Ziegert Roswag Seiler Architekten
5. PL·E·N·AR Planning Aid for Energy Efficient and Sustainable Architecture
Günter LÖHNERT, sol·id·ar planungswerkstatt, Germany

Sustainability Assessment of Buildings as Part of Green Public Procurement – An Introduction

Thomas LÜTZKENDORF^a, Andreas RIETZ^b

^a Karlsruhe Institute of Technology, Centre for Real Estate, Karlsruhe, Germany, thomas.luetzkendorf@kit.edu

^b Federal Institute for Research on Building, Urban Affairs and Spatial Development, Berlin, Germany, andreas.rietz@bbr.bund.de

ABSTRACT

The special session organized by the Federal Ministry for the Environment, Nature Conservation, Building and Nuclear Safety (BMUB) will present and discuss the principles and tools for green or sustainable public procurement. On the basis of examples and experiences from Germany, transferable recommendations for action are to be developed.

Sustainable procurement is a key component in public administrations. With the introduction of the Guideline for Sustainable Building, the Federal Government has enforced an important component of its sustainability strategy in the public sector. In the first step, the Federal Building Authorities are obliged by edict to evaluate their buildings, using the Assessment System for Sustainable Buildings (BNB). BNB has become the most important tool to implement high quality standards. The actual task is, to establish good conditions for a broad implementation of the BNB into the daily work of the public sector in total. The BNB provides a practical tool for holistic sustainability assessment for federal buildings. It is specially adapted to the procedures and needs of the public sector and can therefore be used to support sustainable procurement. In addition to the federal government, this can also be applied by federal states and municipalities and other public builders / clients. Further information is available on the **"Sustainable Building Information Portal"**, see www.nachhaltigesbauen.de.

In the workshop the German Assessment System BNB will be explained and discussed on the basis of two examples: the assessment of the refurbishment of educational buildings and the planning of new research and laboratory buildings including a sustainability assessment. Additional examples from Germany, Austria and Switzerland are presented. In other papers, the possibilities of using renewable energy to operate buildings, as well as the application of principles of integral design, are discussed. It is planned to discuss with the participants the application possibilities of sustainability assessment systems for public procurement.

Keywords: policy and regulation, sustainability assessment tool, public sector, procurement

1. INTRODUCTION

The public sector has a special role and responsibility in the implementation of the principles of sustainable development. In particular, it fulfils tasks aiming at enabling the targeted control of social development. Besides safeguarding public interests, the objectives pursued include the conservation of natural resources and the protection of the environment and health. The public sector has a wide range of policy instruments to support the achievement of these objectives, including public procurement.

The public sector, considering its comparatively high share of investments, has a significant market power. The states or public authorities, in their role as a consumer, can stimulate the market towards environment-friendly and socially acceptable goods and services and promote the development and proliferation of environmentally and socially compatible innovations. Therefore, they can and should act as a role model in the field of the implementation of sustainable development principles.

Public authorities recognised at an early stage the importance of integrating environmental and social standards into the procurement processes, as well as the tendering and contracting procedures. There are various initiatives, guidelines and examples at both the international and European. A gradual transition from green public procurement (GPP) to sustainable public procurement (SPP) is also evident [EC, 2016b].

The GPP and SPP principles can also be applied to the procurement of buildings or the tendering and contracting of design and construction services. A prerequisite is the definition of clear goals for the performance of buildings. In addition to the specification of the technical and functional requirements, EN 15643-1 [CEN, 2010] recommends

setting goals for the environmental, social and economic performance of buildings. In order to take into account the objectives of sustainable development in the design, construction and use of buildings, guidelines, databases and tools, as well as sustainability assessment systems, have been developed in Germany to support the public sector bodies. These can also be applicable to all types of clients and developers.

2. PUBLIC PROCUREMENT FOR CONSTRUCTION WORKS IN GERMANY

In Germany, adherence to the principles of sustainable development is an essential aspect of public procurement. This applies both to the design and construction of new buildings (high performance buildings) as well as to refurbishment projects (deep building renovation). This is linked to a long tradition which goes back to the nineties. Although the procurement activities were initially focused on the aspects of the environmental friendliness of buildings and issues related to the selection of construction products, already since then, the situation has started changing. The attention has consistently started been directed towards the implementation of sustainable development principles in the design, construction and operation of buildings and construction works. To promote **activation and provide support, the round table “Sustainable Building” was established by the Building Ministry**, where both industry and science are represented.

The Federal Ministry for the Environment, Nature Conservation, Building and Nuclear Safety (BMUB) formulated with the Guideline for Sustainable Building essential requirements for federal buildings. This provides an important basis for the sustainable procurement of buildings. Additionally, it forms the basis for a set of databases and tools required for sustainability assessment. All these have been produced with public funds and are freely available – see www.nachhaltigesbauen.de.

The Assessment System for Sustainable Building (BNB) provides a tool which supports the design and assessment of sustainable buildings and is used in public procurement. The BNB addresses the three dimensions of sustainability simultaneously and equally. In addition to sustainability requirements, also requirements for the technical and functional performance of the building, as well as requirements for the quality of the design, construction and management processes, are formulated within this system. The assessment is based on a predominantly quantitative approach including the use of both life cycle assessment (LCA) and life cycle costing (LCC).

For the application of BNB various work aids and data sources are available. Among others, the provision of basic data for the calculation of Life Cycle Analysis (LCA) and Life Cycle Cost (LCC) is necessary. This data is stored in freely available databases. Additionally, calculation and documentation tools are available for simplifying the application of BNB, while preventing multiple entries. Guidelines and system-specific brochures provide basics principles for calculation and assessment and up-to-date information – see <http://www.nachhaltigesbauen.de/sustainable-building-english-speaking-information/publications.html>. For the early design stages and design competitions, special tools are available. The BNB system comprises various types of buildings (e.g. office buildings, educational buildings, laboratory buildings, etc.) as well as defined building-related tasks (e.g. design of new buildings, optimisation of the operation of existing buildings, refurbishment projects). It can be transferred to other building and use types.

3. PRACTICAL EXPERIENCES

The sustainability aspects must be integrated throughout the entire design and procurement process. This begins with a uniform sustainability understanding, the basic decision about the start of design and construction work and **the formulation of goals already in the task definition (client's brief). It is possible to take into consideration sustainability aspects already in the early design stages and in the assessment of competition entries.**

Sustainability assessment systems can initially be used as a checklist of sustainability criteria. It is a way to ensure that all relevant topics and requirements (including the ones related to sustainability) are taken into account in the design of buildings. Sustainability assessment systems are therefore evolving into tools ensuring the consideration **of the “overall performance” of buildings.**

Individual requirements and standards for the relevant characteristics of the building are indicated through the provision of benchmarks and quality levels as design and decision-making tools.

It has been proved to be of fundamental importance to ensure the consideration of sustainability aspects in terms of its **“breadth”**. **This means to ensure a complete treatment of all aspects** - from aspects related to the technical and functional quality to aspects related to the environmental, economic and social performance of buildings. Additionally, information about the quality of the site has to be provided. This is not to be assessed, but only treated as additional information. However, the quality of the design and execution processes is also assessed.

In Germany, the compliance with sustainability requirements must be demonstrated not only as a whole (presented as a percentage of compliance with all the requirements), but also in its subparts, and therefore, the compliance **with the requirements of every single “pillar”**. **In the early design stages**, it has proven useful to define individual indicators.

One way of further developing and refining the sustainability assessment systems and the qualification of the employees is the exchange of experience. In Germany, the Network for Sustainable Federal Building was set up for this purpose.

4. CONCLUSION

The development and application of sustainability assessment systems assist in the integration of sustainability aspects into public procurement. Developing special system variants for the public sector has the advantage that the special requirements and objectives of these institutions can be addressed. In Germany, for the remaining real estate market, the sustainability assessment system DGNB (German Sustainable Building Council) is available. It was developed and introduced in parallel with the BNB system.

It is recommended not only to use a sustainability assessment system during the design process, but also in view of obtaining a certificate or label showing the level of overall performance that has been achieved. Experience in Germany has shown the advantages of defining objectives and targets for all partial requirements. This facilitates the design process.

Besides having data and tools available, it is also important to maintain and expand the competence of the public sector in the field of design, construction and operation of buildings. In Germany, a special training program has been set up and established for the further education of public employees on the topic of sustainable construction. Through this program, they become more receptive to their responsibility as customers in the area of sustainable construction and are better prepared to integrate the relevant sub-themes into the task definition, tendering and awarding of public contracts. Additionally, they are better equipped to ensure the quality of the design and execution.

It is also important to consider sustainability aspects in the use/ operation of buildings. This is closely linked to sustainability reporting on the public building stock.

REFERENCES

- [1] [BMUB, 2013] Federal Ministry for the Environment, Nature Conservation, Building and Nuclear Safety (BMUB). Systematik für Nachhaltigkeitsanforderungen in Planungswettbewerben. Retrieved from: http://www.nachhaltigesbauen.de/fileadmin/pdf/veroeffentlichungen/SNAP_1_Empfehlungen-korr.pdf
- [2] [BMUB, 2015] Federal Ministry for the Environment, Nature Conservation, Building and Nuclear Safety (BMUB). Guideline for Sustainable Building. Vol. 1, Berlin. Retrieved from: <http://www.nachhaltigesbauen.de/sustainable-building-english-speaking-information/guideline-for-sustainable-building.html>
- [3] [BMUB, 2016] Federal Ministry for the Environment, Nature Conservation, Building and Nuclear Safety (BMUB). Assessment System for Sustainable Building (BNB). Retrieved from: <http://www.nachhaltigesbauen.de/sustainable-building-english-speaking-information/assessment-system-for-sustainable-building.html>
- [4] [CEN, 2010] European Committee for Standardization. EN 15643-1 Sustainability of construction works - Sustainability assessment of buildings - Part 1: General framework
- [5] [EC, 2016a] European Commission. Green Public Procurement Criteria for Office Building Design, Construction and Management. Retrieved from: http://ec.europa.eu/environment/gpp/pdf/Guidance_Buildings_final.pdf
- [6] [EC, 2016b] European Commission. Green and Sustainable Public Procurement Retrieved from: http://ec.europa.eu/environment/gpp/versus_en.htm
- [7] [EC, 2017] European Commission. Green Public Procurement Criteria – overview. Retrieved from: http://ec.europa.eu/environment/gpp/eu_gpp_criteria_en.htm
- [8] [PWC, 2009] PricewaterhouseCoopers. Collection of statistical information on Green Public Procurement in the EU - Report on data collection results. Retrieved from: http://ec.europa.eu/environment/gpp/pdf/statistical_information.pdf
- [9] [UN, 2015] United Nations. Principles of Sustainable Public Procurement. Retrieved from <http://www.scpclearinghouse.org/sites/default/files/10yfp-spp-principles.pdf>

The Assessment System for Sustainable Building BNB by Taking the Example of the Complete Refurbishment BNB Module for Educational Buildings

Julia MÜLLER^a

^a Federal Institute for Research on Building, Urban Affairs and Spatial Development (BBSR), Germany, julia.mueller@bbr.bund.de

ABSTRACT

Sustainable building is a key issue for the public procurement in Germany since the mid-1990s. The Federal Ministry for the Environment, Nature Conservation, Building and Nuclear Safety (BMUB) formulated essential and mandatory requirements for the Federal Buildings, which are regularly further developed with the Guideline for Sustainable Building and the Assessment System for Sustainable Building BNB. Besides sustainable new buildings the sustainable development of existing buildings needs to be considered equally. Around two thirds of the building stock were erected before the first Ordinance on Heat Conservation in 1977 and most of them have not yet undergone complete energy efficiency improvement. Furthermore, existing buildings represent a high ecological value. Extending the period of use of existing buildings is one way to save resources and protect the environment. Currently especially the refurbishment of educational buildings becomes an important construction field. Therefore, also an assessment system for refurbished educational buildings is necessary. Within the framework of a research project, the BNB was adapted for existing educational buildings. Basis are the BNB-modules **“New Construction” and “Complete Refurbishment” for office buildings**. To meet the special requirements of these buildings some assessment criteria had to be substantively revised.

Keywords: policy and regulation, sustainability assessment, existing buildings

1. SUSTAINABLE PLANNING, CONSTRUCTION, USE AND OPERATION OF BUILDINGS

The starting point for developing principles and assessment criteria for sustainable building is the overarching concept of a policy of sustainable and future-enabled development, which is based on the three dimensions of sustainability ecology, economy and socio-culture. This concept simultaneously addresses ecological, economic and socio-cultural requirements as equally important aspects. In the national approach the technical quality is included as a cross-sectional quality because the technical properties of a building have a strong impact on sustainability quality. The same applies to the process-related aspects of planning. While the quality of the planning process already strongly influences the other sustainability qualities in the early planning phase, it also determines the degree to which the planned quality is actually implemented during execution. In addition, qualities regarding the location profile are also examined because a building and its location always interact with each other.

As a tool for the sustainability assessment of buildings the Federal Building Ministry published the Guideline for Sustainable Building for the first time in 2001. This Guideline explains the generally valid principles and methods for sustainable planning, construction, use and operation and can be used as a tool for taking aspects of sustainability throughout the entire life cycle of buildings. Since it was updated in 2013, the Guideline now covers not only new buildings, but also refurbishment and building conversion projects. While the Guideline for Sustainable Building provides an explanatory framework document for implementing and operationalising sustainable planning, building, utilisation and operation, the Assessment System for Sustainable Building (Bewertungssystem Nachhaltiges Bauen: BNB) delivers verification methodology to be applied. For all federal buildings, the silver standard of the BNB is the minimum standard that must be adhered to. The gold standard should be the target for selected buildings. First model projects by the federal government have shown that the highest sustainability requirements of the gold standard are economically feasible while providing a high level of user comfort.

2. ASSESSMENT SYSTEM SUSTAINABLE BUILDING (BNB)

The Assessment System transposes the requirements set forth in the Guideline into a structure of evaluation criteria and assessment benchmarks. The aim here is to describe and assess the sustainability quality in its entire complexity. The system takes a comprehensive view of the entire life cycle of buildings, giving equal consideration to ecological, economic and socio-cultural qualities as well as technical and process qualities. The BNB is also a quality management system for planning, building, using and operating buildings. It can be used by owners and planners as a checklist, a decision-making and planning tool as well as a basis for discussion and agreement.

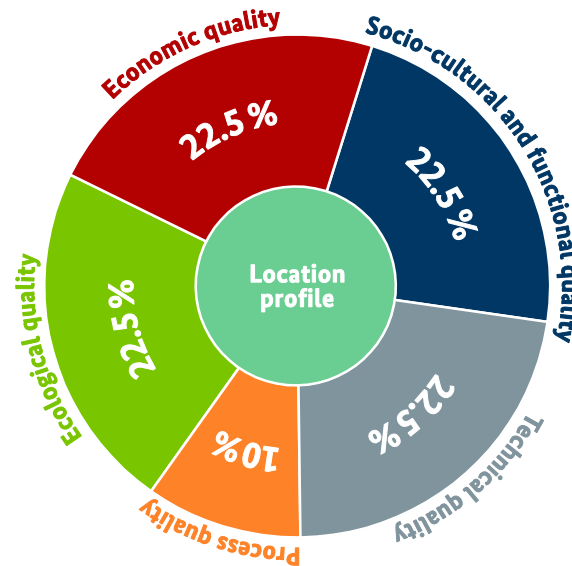

Figure 8: Weighting of the main criteria groups (BBSR)

Sustainability assessment according to the BNB

The Assessment System BNB is structured on the levels of the main criteria groups which are derived from the five sustainability qualities and the location profile, and the individual criteria. Assessing with the BNB the quality of each main criteria group is quantitatively mapped on the basis of the individual criteria. The assessment is carried out for each individual criterion by assigning an assessment score according to defined rules and assessment standards. The individual results are compiled within the respective main criteria group while the individual criteria are weighted with a fixed factor of relevance 1 to 3 depending on their relevance for the protection goals. The degree of fulfilment within the main criteria group is calculated using the ratio between the maximum possible score and the score actually achieved. The results of the main criteria groups are calculated with a defined weighting factor to identify the total degree of fulfilment. The quality standard reached - gold, silver or bronze - depends on the degree of fulfilment. The conformity test, a binding examination of the result documents, ensures the quality assurance within the scope of certification.

System variants

For selected types of buildings and uses the BNB system provides specific system variants so that the particular requirements can be systematically taken into consideration in the sustainability assessment. Basically, the dimensions, principles and qualities of sustainable building equally apply to all types of buildings. Nevertheless, different types of buildings have many type-specific characteristics. This may make necessary different priorities, other individual aspects or a different weighting factor in the sustainability assessment. The system variants are:

- Office and administration buildings
- Educational buildings
- Laboratory buildings
- Inter-company vocational training facilities
- Outdoor facilities

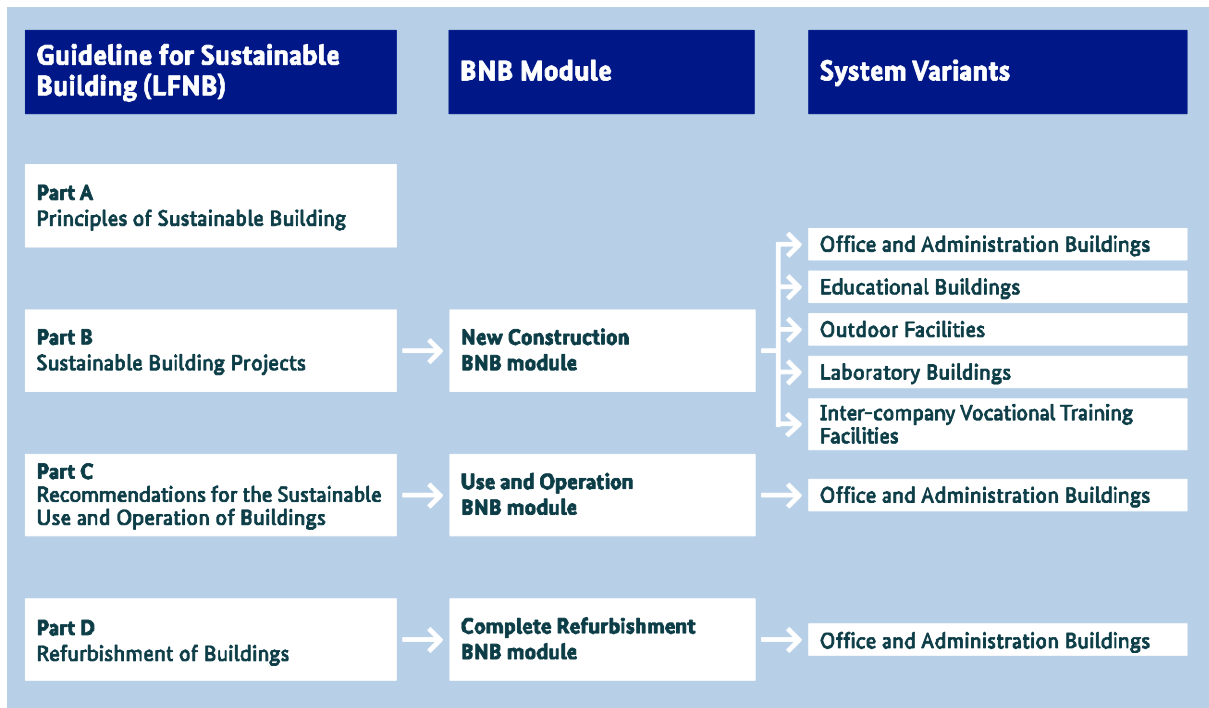

Figure 2: The BNB and its modules and system variants (BBSR)

If it is not possible to clearly assign a building to one system variant due to its location, type of building or use or scope of the project, analogous application of the BNB is generally possible. In this case, the general conditions for the respective country, climate zone or building type must be identified. The aim is to consider the protection goals of sustainability in the project as broad as possible.

Modular layout

A building as well as its use and operation processes can undergo multiple sustainability assessments during the life cycle of the building. For this purpose the BNB has a modular structure with following three modules:

- New construction module
- Use and operation module
- Complete refurbishment module

The BNB modules reflect the cases planning and erecting new buildings, using and operating buildings, as well as planning and performing refurbishment and conversion projects.

Principles of sustainable refurbishment

The principles of sustainable development must be implemented for existing buildings in much the same way as in the case of new buildings. When it comes to qualifying and converting existing buildings, the same ecological, economic and socio-cultural aspects must be equally taken into account. However, the special requirements of the existing building must be considered without generating excessive costs in relation to the benefits. The Complete Refurbishment BNB module is made up of unchanged criteria for new buildings, modified criteria for new buildings as well as specific criteria for existing buildings. The set of criteria reflects the special features of refurbishment projects. **The only structural difference exists in the two additional criteria “Stock-Taking” (5.1.6) and “Demolition Planning” (5.1.7), as part of the process quality.**

Focus of examination is the entire building and not individual structural intervention measures alone. This means that the building which results from refurbishment or conversion will be considered. Accordingly, the products and building parts already installed into and remaining in the existing building are considered in conjunction with the selected assessment criteria and calculations. The scope of application of the Complete Refurbishment BNB module depends on the complexity of refurbishment, which is a function of the scope of the measure, its depth of

intervention in the building and the type of measure. A distinction is made between “complete refurbishment” and “partial refurbishment”. Complete refurbishment is characterised as follows:

- Scope of the measure: complete refurbishment means construction work on an independent, existing structure in its entirety.
- Depth of intervention in the building: the purpose of complete refurbishment is to provide an existing building in its entirety with characteristics and features that correspond largely to those of a new building. Existing buildings are largely stripped down to the structurally relevant elements of the building.
- Type of measure: complete refurbishment encompasses comprehensive work on existing buildings and generally several types of measures. It is characterised by interaction between repair work, refurbishment work, conversion work and interior work.

All building measures of existing buildings that do not go along with this definition are so called partial refurbishments. One of the main differences is that partial refurbishment projects mostly lead to an analogous application of the Complete Refurbishment BNB module since the individual aspects cannot be fully assessed. For partial refurbishment measures the determination of the total degree of fulfilment with the Complete Refurbishment BNB-module usually means an unreasonable level of effort and is hence dispensable. Furthermore, a quantitative assessment of partial refurbishment measures using benchmarks is generally impossible for certain criteria because a general benchmark cannot be developed in view of the wide range of different construction measures. However, the individual measures performed within a partial refurbishment project must be in line with the requirements of sustainable building. A binding target agreement table must be formulated without determining the total degree of fulfilment nor any partial degrees of fulfilment.

3. SUSTAINABLE REFURBISHMENT OF EDUCATIONAL BUILDINGS

Currently around 70% of the educational construction projects are refurbishment projects. Therefore, besides the BNB assessment system for refurbished office buildings, which was introduced 2013, also the assessment of refurbished educational buildings will become an important field for the federal government, the federal states and the municipalities in Germany.

Education and educational facilities are an important part of our society. Educational buildings are part of the public life and can act as a link between different social groups with different cultural and social backgrounds. At the same time, educational buildings must adapt continuously to changes in society. The concept for educational buildings must hence offer sufficient flexibility because of the different functional requirements with a view to room types and functions, use times and the different users.

Within the framework of a research project, the BNB criteria were adapted for existing educational buildings. Basis were the BNB-modules “New construction” and “Complete refurbishment” for office buildings. Besides the criteria of these two BNB-modules who were adopted as they stand, some criteria had to be substantively revised to meet the special requirements of refurbished educational buildings.

Education specific aspects

The sustainability assessment for educational buildings pays particular attention to user needs. The aim is to enable the highest possible degree of user satisfaction in the building, flexible, diverse and synergistic use of rooms and areas, spatial qualities inside and outside and, through public accessibility, to have the building anchored and accepted in the neighbourhood. Especially with the **criteria profiles 3.1.5 “Visual Comfort”, 3.1.7 “Outdoor Use Qualities”, 3.1.9 “Indoor Space Quality”, 3.2.1 “Barrier-free Building”, 3.2.4 “Accessibility” and 4.1.3 “Cleaning and Maintenance-friendliness” (vandalism prevention), these aspects are brought more into focus.** Outdoor areas of educational buildings are regarded as an integral part of the building structure because they should not be separated from the teaching function. For educational buildings the barrier-free accessibility has to be realised for the entire building so that all rooms are reachable and usable. Being able to obtain space, high-quality materials and equipment boosts identification with and appreciation of the building and also helps to prevent vandalism and preserve long-term value.

In order to take the enormous diversity of building types into account, there are also some criteria as 2.1.1 “Building-related Lifecycle Costs” or 6.1.4 “Traffic Connections”, which define differentiated requirements for different use types as schools and universities.

The Educational Buildings system variant does not foresee any quantitative assessment of space efficiency - this is the only structural difference - because the circulation areas are used as recreational areas and increasingly for informal learning so that their dimensions are usually more generous.

Refurbishment specific aspects

Besides the specific educational demands there are also specific requirements concerning existing buildings which the BNB module variant for refurbished educational buildings is taking into account in particular with the criteria of the Life cycle analysis (1.1.1-1.1.5, 1.2.1), **the 2.1.1 “Building-related Lifecycle Costs” and 2.2.2 “Adaptability”**.

Assessing complete refurbishment measures, the eco-balance assessment is influenced in a positive way when the construction is saved. The assessment standard is considering the fact, that an existing building generally won't reach the energy efficiency of a new building. The old building substance, which remains in the building, is **only recognized in the “end of life” life cycle phase**.

Measures with buildings worth listing must be performed in a manner that complies with the needs of such buildings and thus constitute an important aspect of sustainable construction. This must also be considered in sustainability assessments. So for listed buildings the opportunities to improve the energy efficiency is even more limited. Therefore, these buildings can get additional points in the cases of a low thermal transmittance coefficient of the **opaque outer walls or a high ceiling height. Moreover, within the assessment of the 2.1.1 “Building-related Lifecycle Costs” of listed buildings, special conditions can be claimed by deducting the project-specific costs of the costs of manufacture**. Also the adaptability of listed buildings is limited and therefore the criterion offers special rules for some indicators, if fulfilling was not possible - or only with a disproportionate effort - because of conditions of preservation.

CRITERIA TABLE – EDUCATIONAL BUILDINGS SYSTEM VARIANT				
COMPLETE REFURBISHMENT BNB MODULE BNB_UK (UK: UNTERRICHTSGEBÄUDE KOMPLETTMODERNISIERUNG)				
Sustainability criteria			Factor of relevance	Percentage share of overall result
ECOLOGICAL QUALITY				22.5%
Effects on Global and Local Environment				
UK	1.1.1	Global Warming Potential (GWP)	3	3.750%
UK	1.1.2	Ozone Depletion Potential (ODP)	1	1.250%
UK	1.1.3	Photochemical Ozone Creation Potential (POCP)	1	1.250%
UK	1.1.4	Acidification Potential (AP)	1	1.250%
UK	1.1.5	Eutrophication Potential (EP)	1	1.250%
BK	1.1.6	Risks to the Local Environment	3	3.750%
BK	1.1.7	Sustainable Material Extraction/Biodiversity	1	1.250%
Demand of Resources				
UK	1.2.1	Primary Energy Demand	3	3.750%
UN	1.2.3	Drinking Water Demand and Quantity of Wastewater	2	2.500%
BK	1.2.4	Land Consumption	2	2.500%
ECONOMIC QUALITY				22.5%
Life Cycle Costs				
UK	2.1.1	Building-related Life Cycle Costs	3	13.250%
Economic Efficiency and Value Stability				
UK	2.2.2	Adaptability	2	9.000%
SOCIO-CULTURAL AND FUNCTIONAL QUALITY				22.5%
Health, Comfort and User Satisfaction				
BN	3.1.1	Thermal Comfort	3	2.500%
BN	3.1.3	Indoor Air Quality	3	2.500%
BN	3.1.4	Acoustic Comfort	2	1.667%
UN	3.1.5	Visual Comfort	2	1.667%
UN	3.1.6	Influence of the User	2	1.667%
UN	3.1.7	Outdoor Use Qualities	2	1.667%
BN	3.1.8	Safety	1	0.833%
UN	3.1.9	Indoor Space Quality	3	2.500%
Functionality				
UN	3.2.1	Barrier-free Building	2	1.667%
UN	3.2.4	Accessibility	2	1.667%
BN	3.2.5	Mobility Infrastructure	1	0.833%
Ensuring Design Quality				
BK	3.3.1	Design and Urban Quality	3	2.500%
BK	3.3.2	Art in Architecture	1	0.833%
TECHNICAL QUALITY				22.5%
Technical Execution				
UN	4.1.1	Sound Insulation	2	4.500%
BK	4.1.2	Heat Insulation and Protection against Condensate	2	4.500%
UN	4.1.3	Cleaning and Maintenance-friendliness	2	4.500%
BN	4.1.4	Dismantling, Waste Separation and Utilisation	2	4.500%
BN	4.1.5	Resistance to Natural Disasters	1	2.250%
BN	4.1.6	Maintenance Friendliness of Building Systems	1	2.250%
PROCESS QUALITY				10.0%
Management and Design				
UN	5.1.1	Project Preparation	3	1.200%
UN	5.1.2	Integrated Design and Planning	3	1.200%
BN	5.1.3	Complexity and Optimisation of Planning	3	1.200%
BN	5.1.4	Invitation to Tender and Contract Awarding	2	0.800%
BN	5.1.5	Preconditions for Optimum Utilisation and Management	2	0.800%
BK	5.1.6	Stock Taking	3	1.200%
BK	5.1.7	Demolition Planning	1	0.400%
Building Construction				
BN	5.2.1	Building Site/Building Processes	2	0.800%
BN	5.2.2	Quality Assurance of Building Construction	3	1.200%
BN	5.2.3	Controlled Commissioning	3	1.200%
LOCATION PROFILE				
Location Profile				
BN	6.1.1	Risks at the Micro-Site	2	-
BN	6.1.2	Conditions at the Micro-Site	2	-
BN	6.1.3	Image and Character of Location and Quarter	2	-
BN	6.1.4	Traffic Connections	3	-
UN	6.1.5	Vicinity to Use-specific Services	2	-
BN	6.1.6	Supply Lines/Site Development	2	-

Source: BBSR

4. INSTRUMENTS OF SUSTAINABLE BUILDING

All criteria profiles of the Educational Buildings system variant of the BNB system – as well as all other system variants – and more detailed information can be downloaded from the Sustainable Building Information Portal www.bnb-nachhaltigesbauen.de as a general platform.

Furthermore, various fundamentals, information and tools are available for the integrated design, planning and assessment of sustainability aspects in the construction sector. In addition, application tools are available to make it easier to calculate, record and comprehensively document sustainability aspects. The most important are:

- eBNB (Internet-based assessment and documentation tool)
- Data and databases such as ÖKOBAUDAT (www.oekobaudat.de) or WECOBIS (www.wecobis.de)
- eLCA (eco-balance instrument)
- Brochures on different system variants
- System for sustainability requirements in design competitions (SNAP)
- Procurement tools (sustainability compass)

The BMUB's Sustainable Building Information Portal www.nachhaltigesbauen.de provides general information and basics on sustainable building and all necessary guides and tools, construction material and building databases along with information about research projects and events.

5. FUTURE-PROOF PLANNING OF EDUCATIONAL BUILDINGS

Well planned educational buildings support the teaching process and promote the sense for building culture. Being defining components in the neighbourhoods and spaces for learning and living for a variety of people, school- and university buildings have a high social relevance. Therefore, especially for educational buildings, a high quality is very important. A holistic planning process is basis for reaching this high standard. To minimise the impact on the global and the local environment, the energy consumption and the life cycle costs while meeting all user requirements, more than a highly insulated building envelope and optimised MEP-systems are required especially for existing buildings. Because of the interactions of the different relevant topics sustainable building is a complex task. In order to find the best strategies and solutions all stakeholders need to work together. The Assessment System for Sustainable Building for refurbished educational buildings is providing a holistic criteria catalogue.

REFERENCES

- [1] Federal Ministry for the Environment, Nature Conservation, Building and Nuclear Safety (BMUB), 2016. Guideline for Sustainable Building, 2nd Place of Publication, Berlin
- [2] Assessment System for Sustainable Building (BNB) [online]. Retrieved from: <http://www.nachhaltigesbauen.de/> [Retrieved on 30.09.2016]
- [3] eLCA; Retrieved from: <https://www.bauteileditor.de/> [Retrieved on 30.09.2016]

Sustainable Building Assessment System for Research- and Laboratory buildings - Austrian and Swiss Perspective on the BNB Applicability

Alexander PASSER^a

^a Graz University of Technology, Austria, alexander.passer@tugraz.at

ABSTRACT

Green Public Procurement (GPP) calls for the use of the public authorities purchasing power to foster environmentally friendly goods and services. As the building sector is a top priority in terms of maximizing energy efficiency, accounting for up to 40% of global and European energy consumption, the goal of the International Energy Agency (IEA) is to achieve an 80% reduction in global emissions by 2050.

Within the paper the applicability of GPP for the buildings' design process is elaborated. The different stages in the procurement process for buildings are explained and the interdependencies of the complex process of design and construction of buildings and related sustainability performance are discussed.

On the base of two international case studies, the applicability of building sustainability assessment methods is briefly discussed. These methods ensure a holistic life cycle perspective within all phases of design and construction, which can easily be implemented in the procurement process. However only with the commitment from the purchaser as well as from involved design team the implementation of sustainable building projects is possible.

Keywords: green public procurement, sustainability assessment, sustainable design process, BNB

1. PUBLIC PROCUREMENT AND BUILDINGS

How can the COP 21 agreement against climate change be linked to public procurement?

Well, it has been proven that public authorities are one of the major purchasers of goods and services around the world. Green Public Procurement (GPP) calls for the use of the public authorities purchasing power to foster environmentally friendly goods, services and, in this case, construction works, to make an important contribution towards more sustainable consumption and production. Although GPP is only a voluntary instrument, the vision is to change the market forces due to a different demand-driven innovation policy - „Market Pull“.

In Europe, public authorities spend more than 16% of EU's GDP – nearly 1.8 Trillion Euros – on buying goods such as office equipment and building components, and purchase services such as buildings maintenance and transport services. In that sense, it is obvious that GPP has a key role in the efforts to implement Sustainable Development Goals (SDGs) and become a more resource-efficient, circular economy. The European Commission and a number of European countries have developed guidance documents and recommendations, in the form of national GPP criteria. For the applicability in the procurement process, GPP requires the inclusion of clear and verifiable criteria for products and services i.e. the inclusion of e.g. environmental ones. In the Austrian case, based on the new EC public procurement, repealing Directive EC and national regulations, new legally approved criteria were developed. They include the level of innovation, risk mitigation (both technically and economically) and new positive incentives (synergy effects, additional benefits, etc.).

Within all industry sectors, the building sector is a top priority in terms of maximizing energy efficiency because the most cost-effective energy savings can be found in the residential and commercial buildings. Due to the fact that the building sector accounts for up to 40% of global and European energy consumption, the goal of the International Energy Agency (IEA) is to achieve an 80% reduction in global emissions by 2050. In Europe, the EU Parliament approved a recasting of the Energy Performance of Buildings Directive in 2010 that requires member states to propose measures to increase the number of nearly zero-energy buildings and to encourage best practices for cost-effective transformations of existing buildings into nearly zero-energy buildings (Passer et al. 2016).

Evidence gathered from office buildings across Europe indicates that the most significant contributors to operational environmental impacts are due to lighting, heating, cooling and ventilation services. In Europe their

relative importance primarily varies according to the thermal performance of the building and its climatic location respectively. (EUROPEAN COMMISSION 2016)

Second most significant environmental impacts are related to the production of construction products. These - so called embodied impacts - arise in the life cycle of construction products due to their material extraction, processing and transportation, production, installation into the building or construction works, maintenance and end of life. In this respect, the recycling and re-use of construction materials and products, as well as whole building elements, can contribute to reducing environmental impacts and development of a circular economy. (EUROPEAN COMMISSION 2016)

For the overall life cycle sustainability performance, the buildings service life plays a major role, which can be influenced by other than technical factors too. For example, the building's technical and functional performance as a healthy and attractive working environment can contribute to a longer service life-span and minimise the need for renovations or the building's demolition. Evidence shows that in a healthy building with good indoor air quality and good socio-functional performance, e.g. as daylight comfort, the workforce is more productive and less illness-related absences occur. (EUROPEAN COMMISSION 2016)

In Europe an overall – **holistic consensus has been reached (CEN 2012) that the buildings' performance** assessment shall only be done on the buildings level, including all dimensions of sustainability, namely the environmental, the economic, the socio-cultural as well as the technical and the functional performance of a building, pictured in Figure 1.

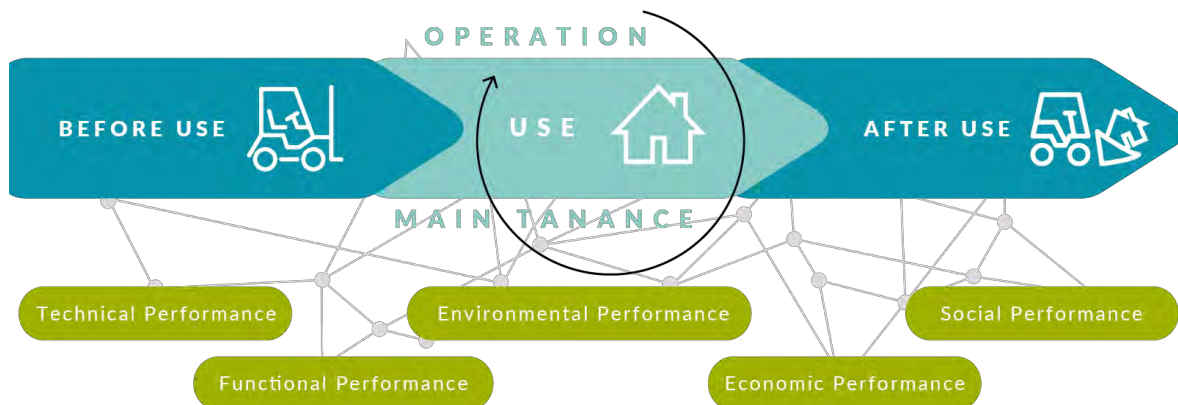

Figure 1: Life cycle of buildings (AGNHB TU Graz)

In the past years a various number of building certification systems like LEED, BREEAM, HQE, DGNB, BNB, SGNI, OGNI and TQB were placed on the market to promote green and sustainable buildings. Recently, an increasing demand for such labels has been noticeable. In these building certification schemes aspects of sustainability (economic, social and environmental as well as functional and technical) are considered very differently. However, as all these building certification schemes are based on assessment criteria, they are applicable for GPP and related activities for public authorities. As the German Assessment System for Sustainable Building (Bewertungssystem Nachhaltiges Bauen: BNB) was developed by the German Federal Building Ministry to be used for public buildings, its applicability from an Austrian and Swiss perspective will be assessed on the case of the Sustainable Building Assessment System for Research- and Laboratory buildings.

2. APPLICABILITY IN THE DESIGN PROCESS

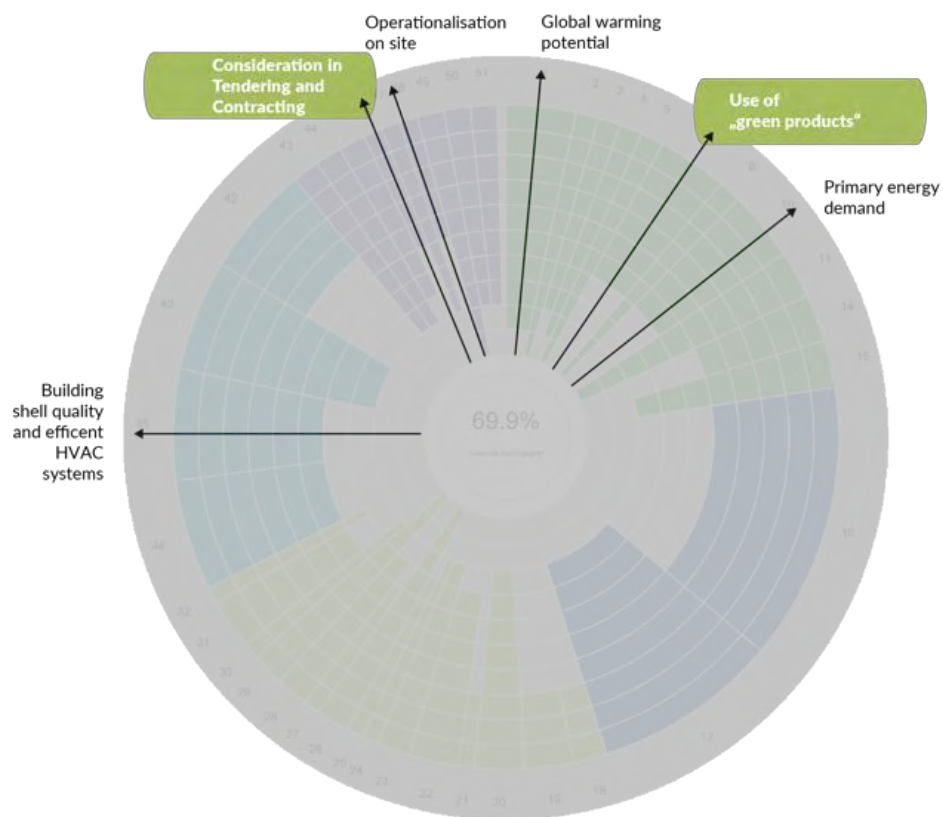

Figure 2: Consequences of GPP for the design and tendering process (AGNHB TU Graz)

Designing and procuring buildings with higher sustainability performance while reducing environmental impacts is a complex process. Figure 2 illustrates the different goals that need to be integrated in the design and procurement process, based on the aimed fulfilment level of different assessment criteria as well as according to the different life cycle phases.

As the implementation level of the goals into the procurement process can have a significant influence on the outcome, the distinct sequence of procurement activities with related contracts are of high relevance. This is because each type of contract brings with it distinct interactions between the procurer, the building design team, the contractors and the future occupants as well as facilities managers. Moreover, they each have advantages and disadvantages in seeking to procure a building with an improved sustainability performance.

According to the EC GPP process (EUROPEAN COMMISSION 2016), depending on the procurement route adopted, some of these contracts may be awarded to the same contractor but in most cases, they are let separately. Some contracts may be integrated in a design and build (DB) or a design, build and operate (DBO) arrangement, with the detailed design process, the main construction contract, the installation or provision of energy services and even facilities management all potentially co-ordinated by one contractor. It is therefore important to identify the main points in the sequence of procurement activities where GPP criteria should be integrated. To this end, these criteria are arranged to reflect the most common procurement activities and are accompanied by a guidance document, which provides general advice on how and when GPP criteria can be integrated into this process. It also suggests, based on experience from projects across the EU, how the procurement sequence could be managed in order to achieve the best results, issues to consider at key stages along the process and specific types of expertise that may help to obtain better outcomes.

Sustainability criteria in the buildings life cycle

Within the different life cycle stages different sustainability assessment criteria need to be defined and checked for a building project. Figure 3 illustrates the possibilities of the definition of project target goals and the related building sustainability certification process. In most building certification schemes the project goals are assessed at the

beginning with the pre-certification process of the buildings design and are awarded with a final certificate after its completion ensuring that all goals and requirements are fulfilled.

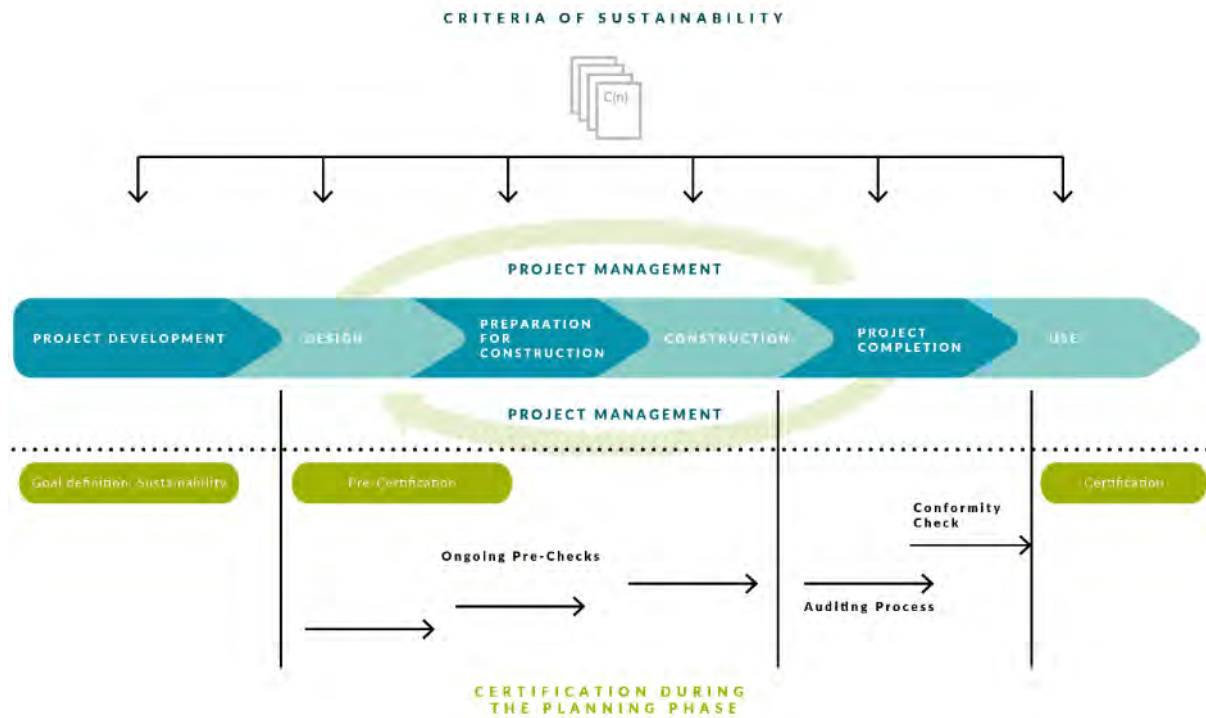

Figure 3: Sustainability criteria in the buildings life cycle (AGNHB TU Graz)

The complex process of design and construction of buildings and related sustainability performance is often checked by the use of a professional sustainability expert (e.g. Auditor, Accredited professional (AP), etc.). This expert checks the fulfillment of the goals defined from the GPP and then communicates with the design team as well with the procurer. Figure 4 illustrates the design process and the parallel process of sustainability performance integration.

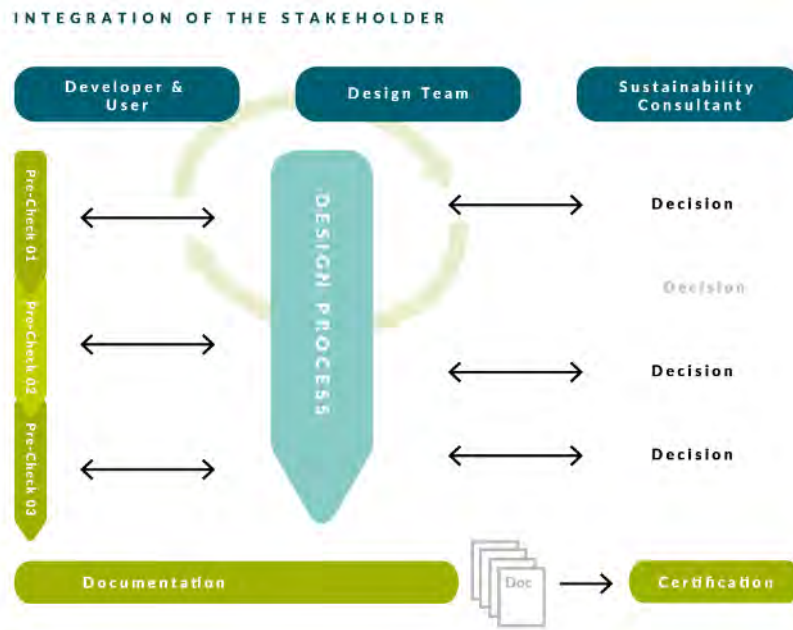

Figure 4: Integration of the stakeholder (AGNHB TU Graz)

3. OUTLOOK - SUSTAINABILITY ASSESSMENT OF BUILDINGS AS PART OF GREEN PUBLIC PROCUREMENT

In a joint activity in the years 2011-2013 BNB, DGNB and ÖGNI developed an assessment method for laboratory buildings based on the BNB assessment method. For the case of two ongoing projects, the applicability and national adaptability of the BNB sustainable building assessment methods in Austria and Switzerland is explained.

MED CAMPUS Graz (Austria)

The building complex as a modern university building, research and teaching facilities centers will have space for around 1700 employees and 4300 students and 68.000m² gross floor area.

From the project's inception, its development was aligned towards a sustainable and healthy campus in the broadest sense, and this has resulted in a GPP process by the inclusion of sustainability performance targets already in the public competition requirements. Before the process inception a target catalogue on the basis of the ÖGNI assessment criteria was developed, which is the Austrian adaptation of the BNB/DGNB method. In an interdisciplinary, iterative design process, the buildings performance was constantly optimized and checked from a sustainability perspective, which led to a precertification at the end of the buildings design. The achievable goals formed the basis for the requirements and the tender specification respectively. For the construction phase, regular updates of the precertification were used as a monitoring tool. For the final certification, on-site measures were performed to finally evaluate the building's real life performance.

GLC ETH Zürich (Switzerland)

As a second case study, the GLC project from ETH Zurich, demonstrates the integration on GPP processes in Switzerland. Due to the general sustainability requirements of ETHZ all building projects must reach a high fulfillment degree (>65%) of the SGNi assessment scheme, which is the Swiss adaptation of the BNB/DGNB method.

All projects from the architectural competition were assessed with the focus of the criteria that can be assessed in early design stages. In the following, a coordinated initial assessment between ETH and awarded design team has taken place, which then acts as an objective agreement with specific planning requirements to be included in the contracts. The next step was the commissioning of the design team. With the preliminary project, the assessment procedures were established, and ETH is only controlling the target agreement. The precertification was conducted with the preliminary project, where ETH provided the auditor function. The design team and their sustainability experts provided the project details for the assessment. After the building completion, the GPP process ends with the final certification and hand over to the users.

OUTLOOK GREEN PUBLIC PROCUREMENT

Due to the reached common understanding for the importance and urgency of sustainability targets to be implemented in the construction sector, green public procurement could foster the efforts of public authorities towards environmentally, economically and socio-culturally high (better) performing built environment. GPP can have many direct and indirect environmental and economic life cycle benefits. Apart from the immediate environmental gains, e.g. through the purchase of a more sustainable product, it can be a crucial market driver to foster a critical mass of sustainable products.

The use of building sustainability assessment systems, such as the BNB method, ensures a holistic life cycle perspective within all phases of design and construction towards diminishing long term implications. The variety of the developed methods and tools allows the procurers to make transparent, scientifically based decisions. However, all tools, data and methods need to be publically available in advance in order to avoid any discrimination.

Findings from both case studies show that that only with the commitment from the purchaser as well as from involved design team the implementation of sustainable building projects are possible.

However more research on the systemic interdependencies of design decisions and related multi criteria decision making process remains an open task. In order to facilitate the applicability in the design process, it is also

necessary to simplify and automate the assessment methods and align it with conventional steps in planning and procurement processes, i.e. through the implementation in Building Information Modeling (BIM).

The awareness of the achieved (higher) sustainability performance and related efforts is an ongoing learning process on its own that has just begun.

ACKNOWLEDGMENTS

The Author would like to thank Andreas Rietz (BBSR) and Thomas Lützkendorf (KIT) for the possibility to contribute to the BMUB workshop on Sustainability assessment of buildings as part of green public procurement based on the German BNB-System. The case studies described in this paper were carried out in the project MED CAMPUS Graz by Medical University of Graz and Bundesimmobiliengesellschaft m.b.H. with the general planer Riegler - Riewe Architects ZT GmbH (architects, commissioned by BIG) and Team TU Graz. The second case study was provided by Christian Stoy (PBK AG) as consultant and Daniel Nötzli (ETH Zürich) for the building project (GLC). We would like to thank all for their support and their inputs.

REFERENCES

- [1] CEN, 2012. ÖNORM EN 15978:2012-10-01- Sustainability of construction works - Assessment of environmental performance of buildings - Calculation method
- [2] EUROPEAN COMMISSION, 2016. EU GPP Criteria for Office Building Design, Construction and Management
- [3] Passer, A. et al., 2016. The impact of future scenarios on building refurbishment strategies towards plus energy buildings. *Energy and Buildings*, 124, pp.153–163

Natural Resources and Sustainability

Eike ROSWAG-KLINGE^a

^a Ziegert Roswag Seiler Architekten, roswag@zrs-berlin.de

ABSTRACT

Modern construction worldwide is based on fossil resources like steel, concrete, oil and gas. In Germany the building sector consumes approx. 50% of all fossil resources used to build, maintain and operate the build environment.

Natural resources like earth and wood offer an enormous potential to reduce building services, enable low-tech buildings and to decrease the carbon footprint of the construction industry.

A new movement towards earth, wood and other natural building materials is evolving globally. In Germany a number of research projects in this field are developing inventive solutions for construction, resulting into the development of standards and a number of innovative pilot projects. Along with Austria and Switzerland, Germany plays a leading role with regard to a new natural build environment.

Keywords: earth, wood and timber, low-tech, lifecycle, natural build environment

1. INTRODUCTION

Around half of the world population lives in buildings erected out of earth as earth is one of the oldest building materials of the human kind. Those constructions are most often simple, non-durable huts being located in developing countries, however, the material is also used in applications such as historic buildings around the world, whereof a number are listed as UNESCO World Heritage. Since the 1980s eco movement, earthen architecture is **developing further in various countries. In Germany, the earthen construction association 'Dachverband Lehm'** established in collaboration with a network of ambitious manufacturers an in-depth technical knowledge for earthen building materials. Recent DIN standards ensure nowadays a very high product quality and enable a wider application.

Timber but also the fast growing grass bamboo, have induced in forested areas a similar tradition as a building material. Especially for timber construction, several pilot projects with innovative, material optimised solutions have recently been erected in Europe, not only exceeding the limit for high-rise buildings but also offering cost and time efficient solutions through prefabrication.

2. LOW-TECH BUILDING SYSTEM OUT OF EARTH AND WOOD

When it comes to the internal environment, natural building materials are characterised through an outstanding humidity buffer capacity, adsorbing around three times more moisture from the air in comparison to conventional materials (e.g. gypsum plaster boards). Applied to the interior, they lead to relative stable and healthy humidity levels indoors ranging between 40% and 60%. In addition, natural building materials are not only low emitting but **are able to adsorb harmful substances such as VOC's from the air. Through these specific material properties they** contribute to an improved indoor environmental quality as established in H-House, a European Research Project. In combination with vapour permeable envelope construction, earth and timber materials allow modern energy efficient and highly airtight buildings to be naturally ventilated. Fitted out with energy efficient building technology and renewable energy resources these building could be build as low energy and as well as plus energy buildings.

ZRS, a Berlin based architectural and engineering practice, has successfully built and monitored a number of residential buildings in and around Berlin, following this low-tech approach. In collaboration with Prof. Hausladen the idea of vapour active, energy efficient, natural construction has been adapted to a multi storey production building for Flexim GmbH in Berlin Marzahn which is currently under construction.

Building regulation rarely assess the ecological footprint of construction. Trough the use of renewable resources in combination with a low-tech approach the impact on the build environment can significantly be reduced.

- 1 Existing situation before dismantling
 - 1.1 Foundation
 - 1.2 Historic timber structure
- 2 Re-erection at new location
 - 2.1 New foundation and floor slab (reinforced concrete)
 - 2.2 New landscape level
 - 2.3 Re-erection of historic timber structure
- 3 Integration low-energy house

Highly-insulated vapour permeable building shell from sustainable raw materials (timber, wood fibre insulation, earth)

 - 3.1 Doubled roof structure, U-value: 0,15 W/m²K
 - 3.2 Exterior wall, U-value: 0,13 W/m²K
 - 3.3 Wooden window triple glazing, U-value: 1,0 W/m²K
 - 3.4 Floor build-up insulated, U-value: 0,1 W/m²K
- 4 Regenerative heat generation
 - 4.1 Hot water collector
 - 4.2 Stratified storage tanks
 - 4.3 Wood boiler
 - 4.4 Surface heating for heat distribution

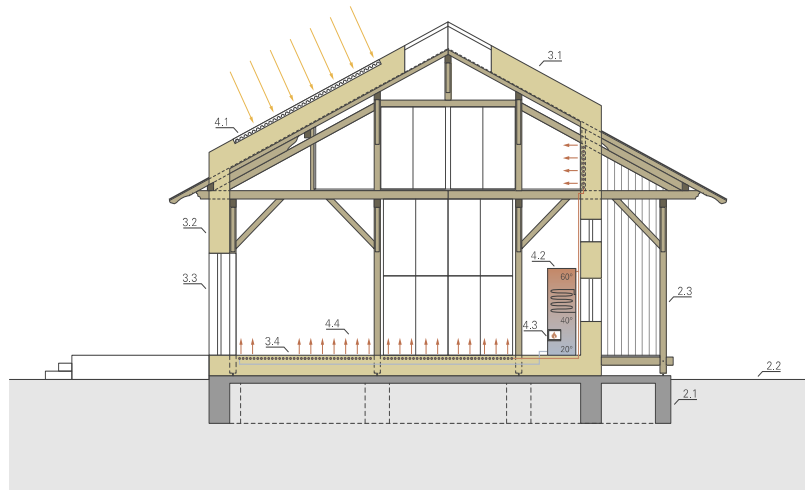

Figure 1: Natural low-tech building system, the peat barn in Schechen, Bavaria, © ZRS-Berlin.de.

3. CIRCULAR CONSTRUCTION WITH EARTH AND TIMBER

Using reversible joints and constructions earth, timber and other natural materials can be reused endlessly while transforming buildings over centuries. This has been a common strategy until the end of the 19th century, before the consumption-oriented period started, where fossil resources were depleted.

A historic peat barn in Schechen, Bavaria has been relocated and transformed three times since its initial construction in the year 1810. In 2006 it was dismantled in Kolbermoor 15 km away from its current location. The integration of a new workshop and two flats was done in timber, earth and natural fibres as a reversible construction, following the historic model, without compromising energy efficiency and airtightness.

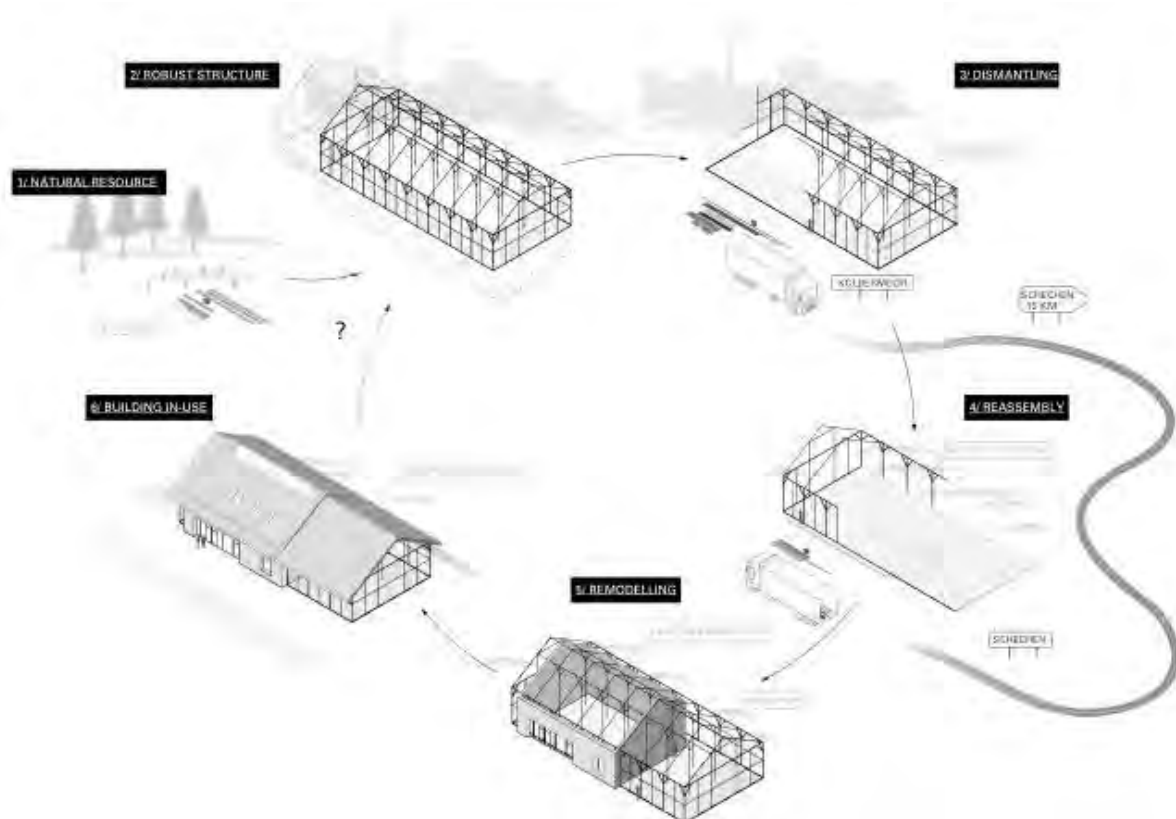

Figure 2: Life cycles of the peat barn in Schechen, Bavaria © ZRS-Berlin.de.

4. FUTURE VISION – DIE NACHWACHSENDE STADT (THE NATURAL REGROWING CITY)

The Berlin based network “Die Nachwachsende Stadt” (NWS) (the natural regrowing city) is researching, designing and building resource positive projects inside the existing urban fabric. The design focuses on social aspects like participation and well being of the inhabitants, general environmental and resource aspects. The NWS is a mixed used city with short distances between working and living spaces.

Projects realised by the network like the Artis carpenter workshop showcases how a clean industry can be integrated into an inner city context. The trade building protects the adjacent residential scheme against noise emitters (noisy street and concert hall) and delivers heating energy to its neighbours. A NWS vision is a mixed-use project at Gotenstraße in Berlin-Schöneberg combining housing with a founding centre for new Berliners with a refugee background. The building is designed as a seven-storey timber structure with visual surfaces as a low-tech low energy building.

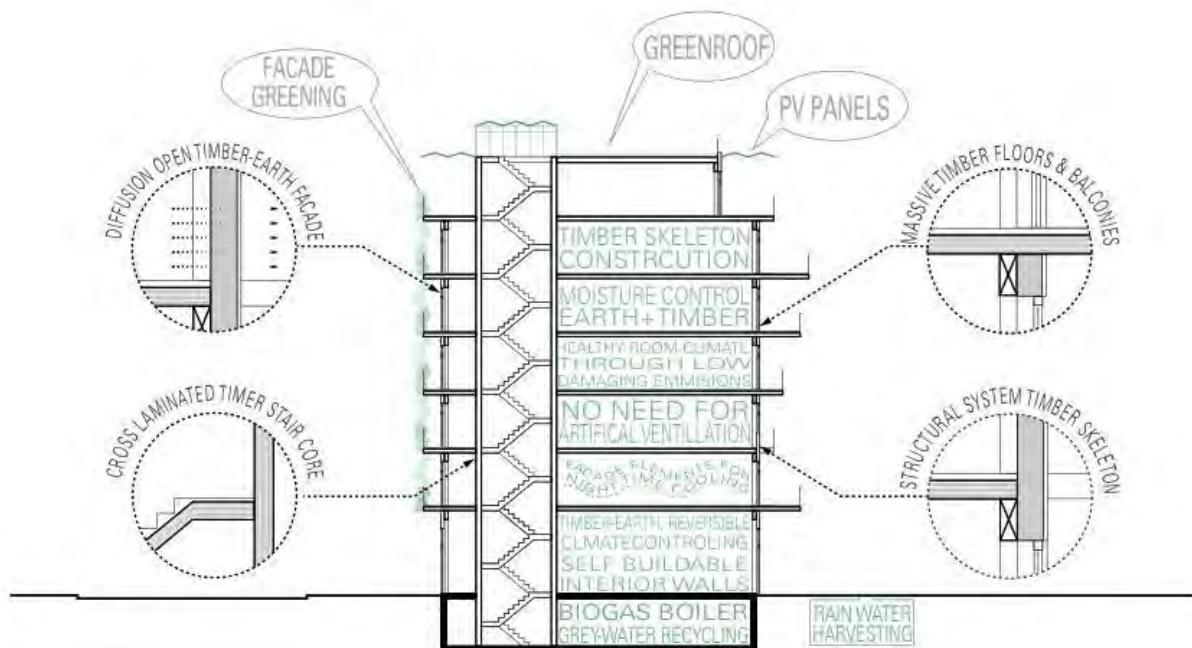

Figure 3: NWS incubator Gotenstraße, Berlin, © ZRS-Berlin.de

5. CONCLUSION AND OUTLOOK

Traditional, natural building methods offer globally an enormous potential to be transformed into a resource positive architecture of the post fossil society. Research and pilot projects as well as an open-minded society are needed to start the transformation process. If high-tech-oriented countries like Germany start to use their engineering potential for a global low-tech idea a dialogue between different cultures is possible and can be the driving force of the urgently required change.

REFERENCES

- [1] <http://eartharchitecture.org/?p=380>
- [2] <http://whc.unesco.org/en/earthen-architecture/>
- [3] <http://h-house-project.eu>

PL·E·N·AR Planning Aid for Energy Efficient and Sustainable Architecture

Günter LÖHNERT^a

^a *sol-id-ar planungswerkstatt, Germany, loehnert@solidar-pw.de*

ABSTRACT

PLENAR is a design guide for structuring of basic principles of building design for the preparation and implementation of an integrated design process. Without this process ambitious projects won't succeed. Main focus is the support of a common, interdisciplinary understanding of planning philosophy regarding energy efficiency and sustainability, among all partners involved in a building project.

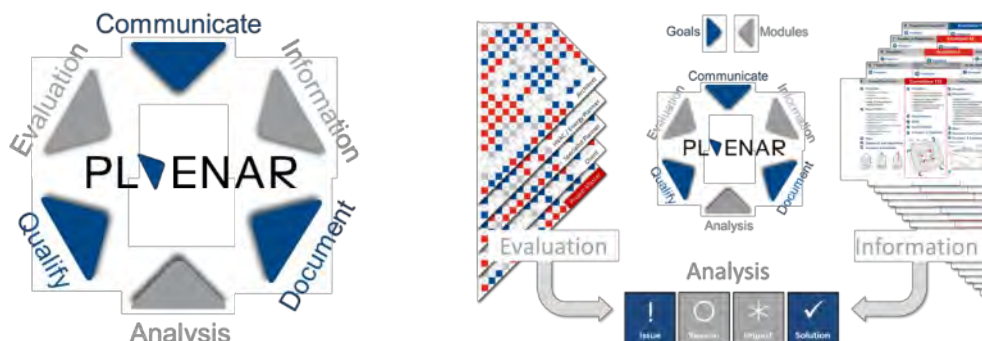

PLENAR consists of three main goals which include

1. Communication among actors involved by well-structured discussion formats
2. Qualification of participants and project goals by interdisciplinary approaches
3. Documentation of results in suitable formats for decision making and QA

Facilitating these goals PLENAR provides correlating application modules including

4. Evaluation: Using a given matrix, interrelations of relevant criteria can be evaluated individually by actors, the next step is to compare and assess the results.
5. Information: A database provides generic information on criteria and their correlations with a focus on energy efficiency and sustainability.
6. Analysis: The individual assessments of the relevant correlations made by the participants are discussed to derive the main goals for the individual project.

The presentation will inform planners, interested customers, and companies about the current state of development to promote the progress towards a professional web-based application which would support assessment systems in particular.

Keywords: integrated design process, sustainable building, energy efficiency, design guidance

1. BACKGROUND – OBJECTIVE - POTENTIALS

The complexity of design processes increases continually. The potential of influence on energy performance, comfort and cost efficiency, as the most essential characteristics of sustainable building design, lies in early design stages. Hence, already in state of demand planning certain conditions have to be settled to define a requirement profile with an entire space allocation plan and holistic project goals.

Therefore, it is necessary that a common understanding of planning philosophy regarding energy efficient and sustainable building is set from the very beginning among all project partners. The early and constructive examination of the most important criteria and their correlations as well as their impact on sustainability quickly

leads to this common planning understanding and guarantees a higher quality of the entire planning process. PLENAR can be used and adapted by all design teams for their individual project.

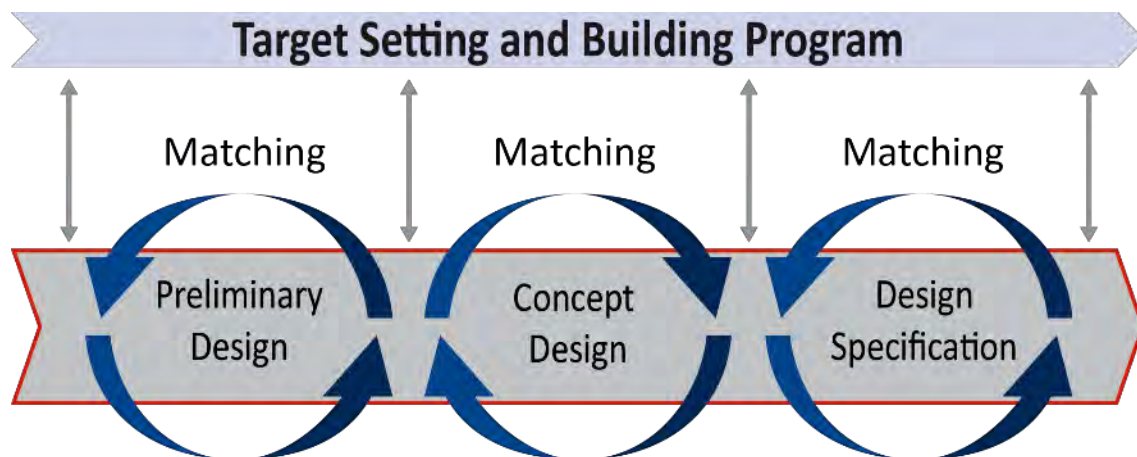

Figure 9: Optimization by iteration loops during an integrated design process

The planning aid PLENAR enables in a short period of time

- An improvement of transdisciplinary understanding on energy and sustainability-oriented relations for all project partners: client, architect, professional planners, user, facility manager and others
- The development of an individual project master as a baseline for the specific project requirement profile and the structuring of the projects integrated design process by selecting and adapting the type and number of relevant criteria
- The development of a project roadmap for the further approaches in the integral design process with concepts to iterations in individual planning stages to optimize the entire planning and implementation process
- The documentation of results as a requirement profile for target agreements and performance specifications as a to-do-list for planners
- The documentation for the building certification as a verification and optimisation for planning objectives when applying assessment systems

2. APPROACH

The design guidance is based on extensive experience of comprehensive project support focussing integrated building design, energy efficiency and sustainability. All correlations (Figure 10) are assessed individually concerning their degree of influence on energy efficiency and sustainability by each actor.

Example: Correlation no. 21 represents the relation between building mass distribution (criteria no. 2) und flexibility (criteria no. 6). The assessment of the actors is determined and compared to a reference (master). Significant deviations to this master, but also among actors, allow a structured discussion. By this way misunderstanding among participants and information gaps can thereby be eliminated. Moreover, the actors will get insight to their role during an integrated design process.

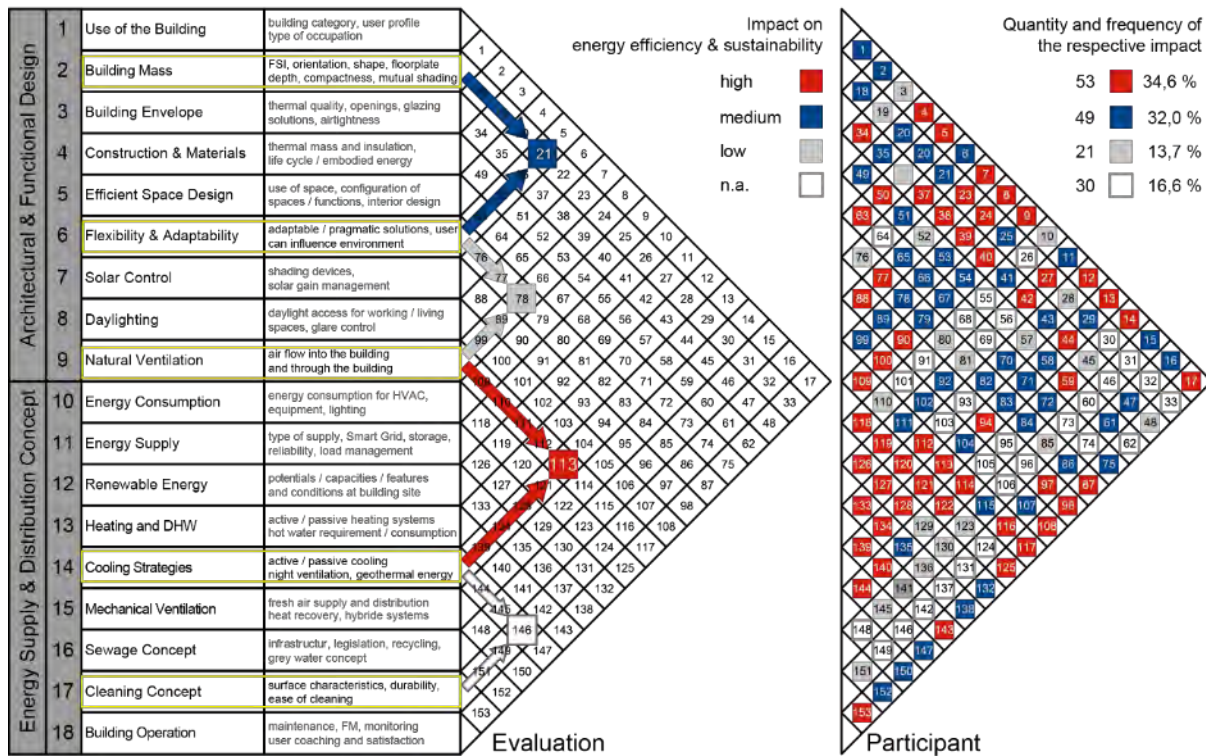

Figure 10: The correlation matrix for an individual application for planning actors

All planning participants, such as architects, energy planners, client and other experts evaluate 153 correlations resulting from 18 criteria, e.g. for office buildings, according to their individual assessment and experience. If possible, all correlations are to be assessed completely with regard to their impact on energy efficiency and sustainability and to be determined in the matrix according to the evaluation level (high, moderate, low or not applicable).

Hence, in the early planning stage each member of the interdisciplinary team has to deal with the same questions. This means, all project participants gain an extensive insight into the planning complexity and, above all, beyond the boundaries of their own planning discipline.

2.1 Evaluation of the individual knowledge

The results are analysed on the basis of the assessments made by the actors, i.e. they will be compared among each another and mirrored to a (master-) reference matrix provided by the design guidance PLENAR. This process gives an overview of the individual knowledge of all actors involved (Figure 11).

With a professional supported and moderated discussion, the different perspectives of the actors can be brought to a common level. Thus, individual expertise is exchanged and expanded for each participant. In the first iteration of the discussion process only the assessments with substantial deviations (deviation of 3 levels) are considered. In a second loop the deviations of level 2 can be discussed on demand as well.

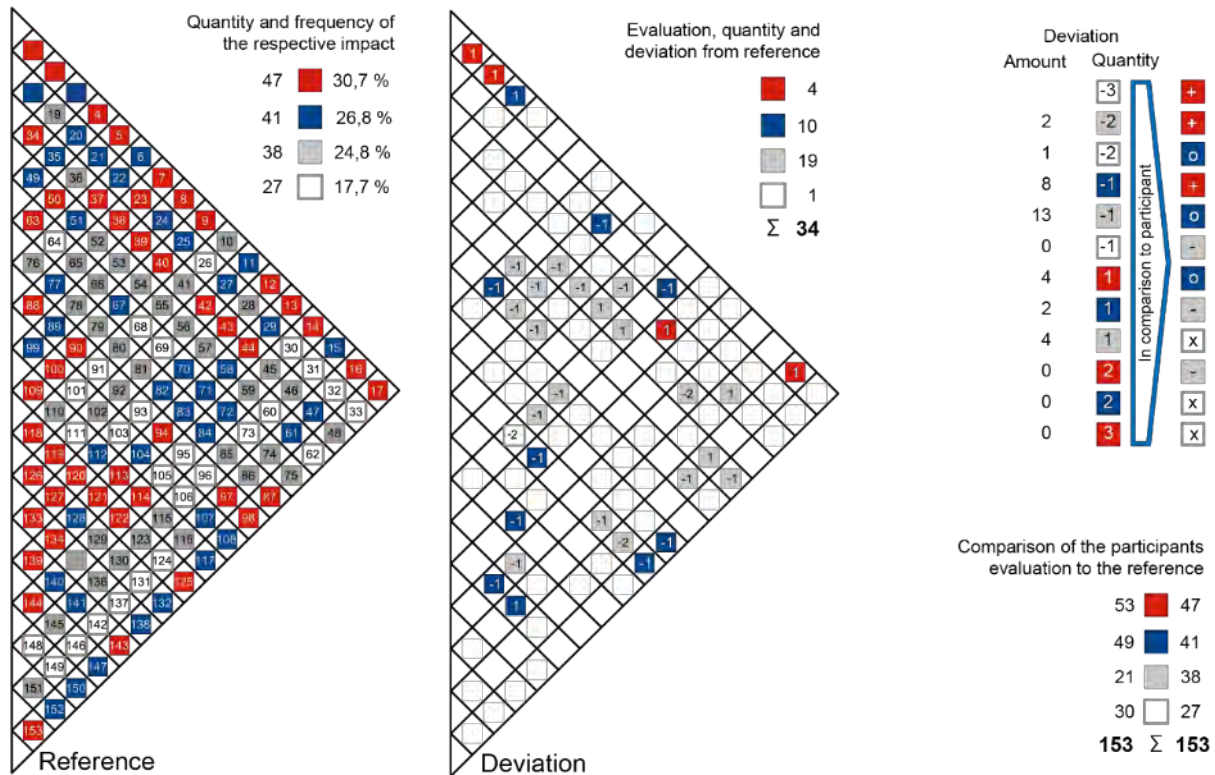

Figure 11: The individual correlation matrix is compared to a reference matrix (master) and evaluated

PLENAR is applicable on different levels. Information level 1 (Figure 12) gives a rough description of the related criterion and its specification and a recommendation for the planning to its user. This level is the basis for evaluating the correlations of individual assessments regarding their respective relevance and the degree of their influence on energy efficiency and sustainability.

Information level 2 describes a variety of information about the potentials of the respective criteria, requirements, risks, standards and guidelines, concepts and examples, such as generally formulated sheets for the requirement and performance specifications (Figure 13). In a discussion, this additional information provides well-founded information to qualify and simplify the planning process.

2.2 Information about the correlations (Level 1)

The database provides **supportive generic information for the interdisciplinary discussion of the actor's** assessments. This is done for all 18 criteria. If the correlation between two criteria has a high impact on energy efficiency and sustainability (e.g. correlation 113 marked in red), corresponding relevant information is provided as well (Figure 12).

This information can also be adapted and documented according to the respective project specific requirements of the construction project. In this way you fulfil the prerequisites for compiling a performance specification sheet for further planning steps.

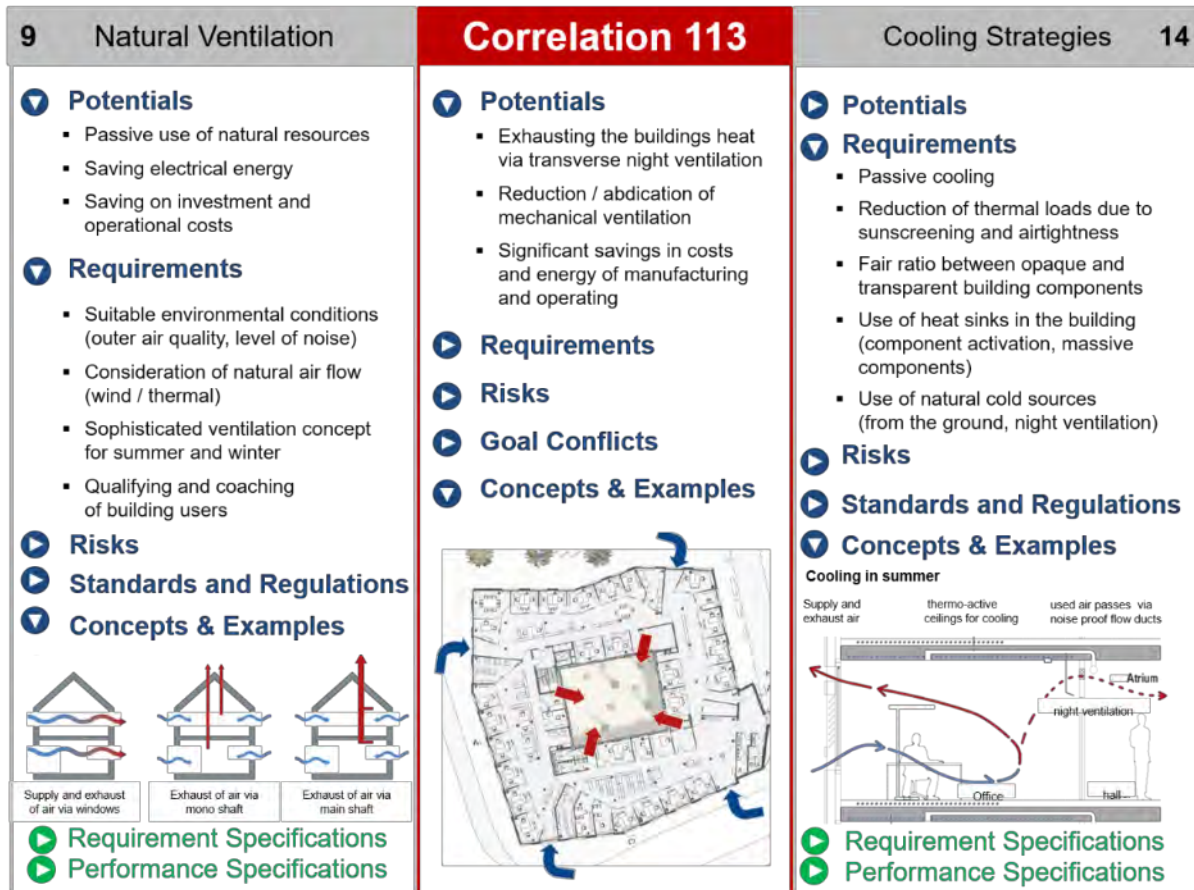

Figure 12: Correlation example 113: Natural ventilation versus cooling strategy

Information: As a communication basis a database provides information on all criteria provided and relevant correlations of high, moderate and low impact. In the discussion different levels of knowledge of the individual actors are balanced and the database is expanded continuously by the feedback of each project implementation. This is true for all building type applications.

Communicate contents and attitudes. Deviations of assessments will be analysed and interpreted in comparison to the chosen reference (generic master, individual project matrix, individual actor's assessment). Important deviations are preferably discussed in a kick-off workshop.

2.3 Profile of requirements and implementation concept (Level 2)

For sustainable design, the requirements profile must be defined with clear project targets and subsequently a complete building program, which is then to be transferred into a performance specification sheet and implementation concept. The starting point and guideline are the confirmed project targets resulting from and addressed in the sustainable building certification system.

The example in Figure 13 shows requirements for a qualified ventilation concept: air quality, user acceptance, low energy demand, low operating costs and noise distribution. The performance specification sheet instructs the relevant measures to be implemented.

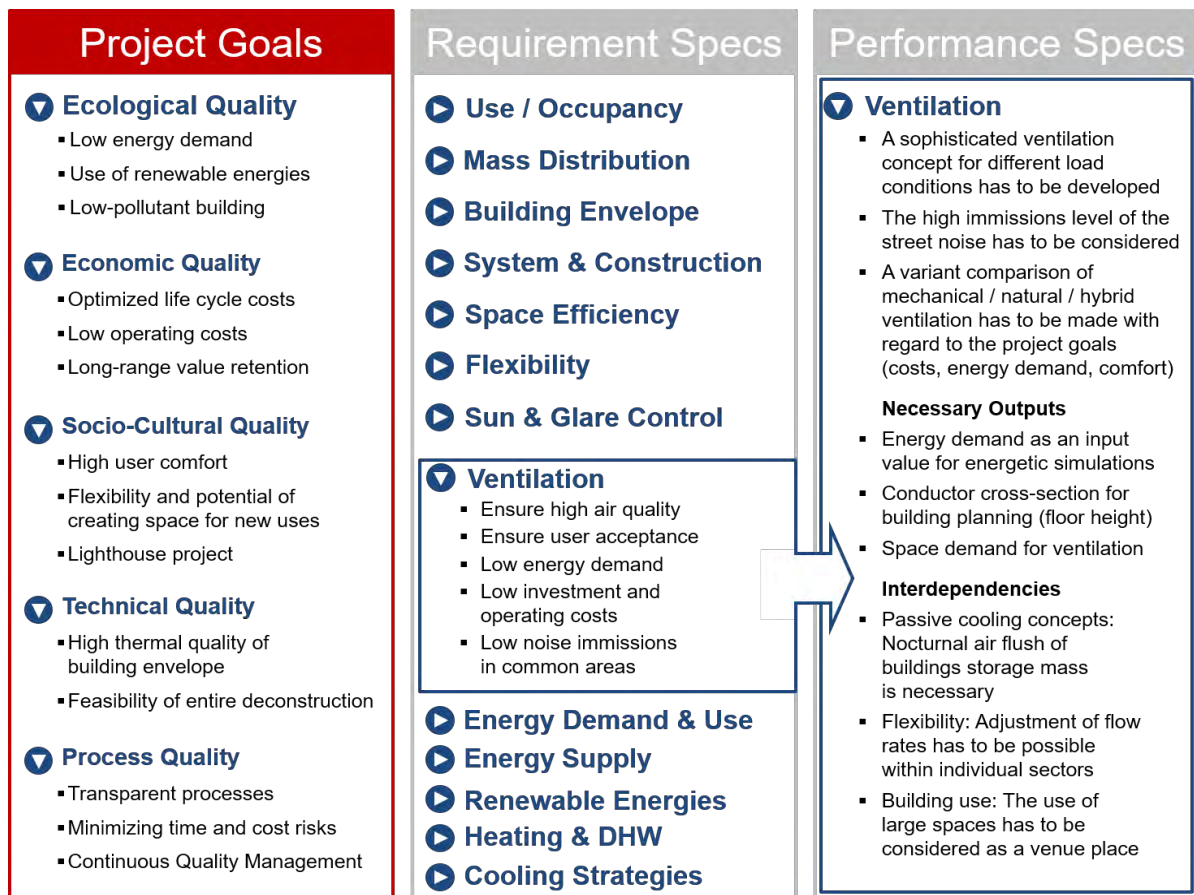

Figure 13: Requirement specs define requests - performance specs determine related steps for a successful realisation

Qualification: The professional exchange for the assessment of correlations and the relevance for the certain project quality both the actors and the entire planning process. As a target agreement, elaborated content and results are documented in a requirement specification and in the performance specification sheet based on it.

Document the integrated design process. With the help of PLENAR, all results of the assessment, the discussion and the specification of the connections for the optimisation of energy efficiency and sustainability can be structured and documented bindingly, for all subsequent planning steps.

2.4 Analysis of effective conclusions

The respective interrelation of tasks, targets, issues and target conflicts, requirements and desires as well as their backgrounds and effects can be analyzed in a subsequent context analysis (Figure 14) in order to develop solutions. In further planning progress, design related specifications are defined and updated or re-defined especially for the current project. As a directive for the objective implementation they are then documented in a comprehensive performance specification manual serving as an instruction book as well.

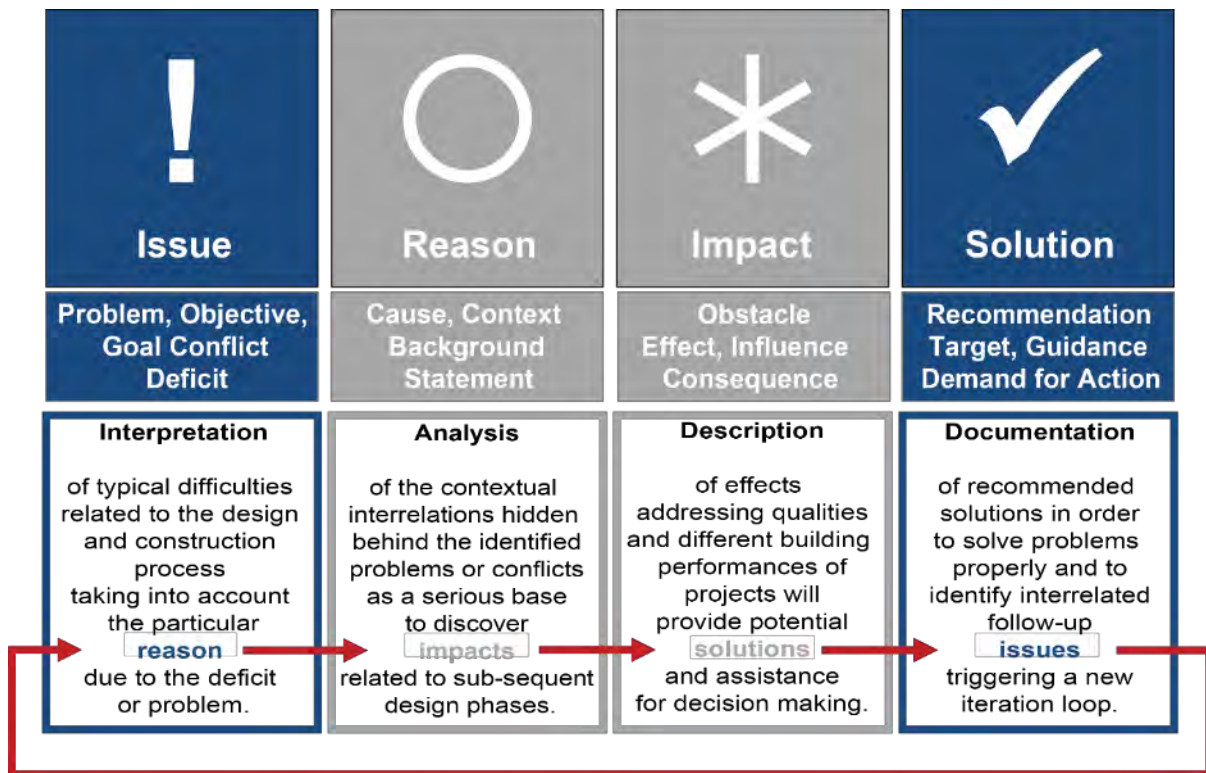

Figure 14: The context analysis is a method for the holistic analysis of correlations in the context of tasks and solutions of all kinds, in order to create a solid basis for the decision-making process.

By using the method of context analysis, tasks, issues, goal conflicts and deficits or problems can be identified in a dialogue with all planning actors. Their backgrounds should be described as well as the respective effects, for example on comfort or operating costs, can be identified systematically. Only this kind of view on the entire context will give the opportunity to deal with questions in a comprehensive way.

For example, solution approaches of the context analysis will also be developed resulting from contradictions and problems with review of the requirement and performance specification sheets or with deviating in goal statements during design progress.

Thereby this method is an important instrument for the elaboration of decision papers and also, based on comprehensive consideration, an element for the integrated planning and implementation process.

3. FUTURE PROSPECTS

In order to provide the tool for planning teams in all kinds of projects, it is to be developed as a web-based application. For individual adaption. As a result, it gives an important contribution to the improvement of the interdisciplinary planning and building culture towards integrated design, energy efficiency and sustainability. In addition to the use of PLENAR as design guidance in building projects, it is also suitable for (interdisciplinary) teaching at universities as well as for further education and training through the academies of architects and engineers chambers.

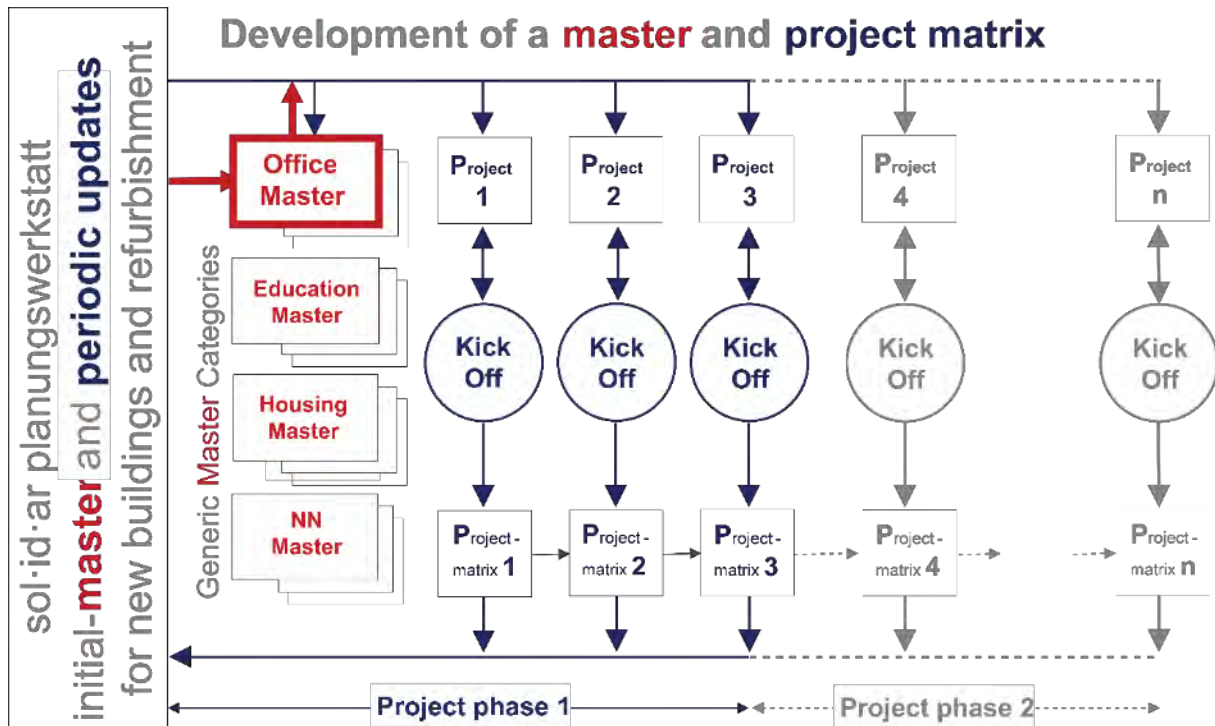

Figure 15: Development of master and project matrix: By applying PLENAR in different projects with different building categories, different masters for different building uses will be created

Moreover, it is also reasonable to use the tool to educate sustainability coordinators and auditors of sustainable building certification systems such as DGNB and BNB in Germany, LEED, BREEAM, etc.

The development for professional applications will provide so-called masters for building categories like office building, housing, education buildings, etc. for both new buildings and refurbishment (Figure 7). Thus, PLENAR qualifies itself frequently by the implementation into design processes and feedback from application practice.

REFERENCES

- [1] Löhnert, G. Planungshilfe aus der Praxis; XIA intelligente architektur 04-06/15
- [2] Löhnert, G. PLENAR Planungshilfe; Deutsches Architektenblatt 07/2015
- [3] Löhnert, G. Train-the-Trainer-Seminar, India, BEEP-Project 12/2014

(10) Smart and Digital Transformation for Sustainable Living Session Organiser: Sino Group

Session 5.14

SESSION OUTLINE

Smart and digital transformation is now and not in the future. With the process of making our world smarter in every aspect of our lives, data from Internet of Things (IoT) and artificial intelligence (AI) for process are the essential enabler. As one of the leading developers, Sino Group has a good number of initiatives in transforming their building portfolio into a better environment for better experience. These initiatives includes providing healthy and sustainable living space in shopping malls, offices, and residential buildings, enhancing user experience through smarter application of technology and apps. Exemplary of implementing technology, Project Moses is making eco homes a reality and connecting with the community through AI and IoT. Specifically in the built environment, AI can help in finding the energy use pattern and allow smart control to match the supply and demand of our resources within our buildings. Lastly, beyond using the technologies, the top-down and bottom-up approaches in making our building development more sustainable for our future generations will be covered.

After the individual presentations, the panel will share their views on how to bring the smart and digital transformation into reality so that we can enjoy a sustainable world for ourselves and our children.

SESSION CHAIR

Jimmy CK TONG, Associate & East Asia Energy Skill Leader, Arup, Hong Kong SAR

SPEAKERS AND PRESENTATION TOPICS

1. **Sino's Smart Initiative**
Eugene LEUNG, Director, Sino Investment
2. Artificial Intelligence in Built Environment
Samson TAI, CTO, IBM Hong Kong
3. Smart Eco Home - Project Moses
Andy ANN, **CEO, NDN Group**
4. Policy, Design, and People: Developing a Sustainable East Asia
Vincent CHENG, Director of Building Sustainability, Arup, Hong Kong SAR

Policy, Design, and People: Developing a Sustainable East Asia

Vincent CHENG^a, Jimmy TONG^b

^a Arup, Hong Kong SAR, vincent.cheng@arup.com

^b Arup, Hong Kong SAR, jimmy.tong@arup.com

ABSTRACT

Urbanization in East Asia is growing at an unprecedented rate. Growing Asian cities sustainably will shape the **world's path to environmental sustainability and benefit future generations. Apart from the challenges of adopting** technologies suited to local climate conditions, the energy needs of high-rise buildings differ from that of low-rise buildings, thus requiring different solutions.

As part of the solution to combat climate extremes, sustainable development of the built environment requires concerted efforts from all stakeholders, including people from the public and private sectors, professionals, and citizens in general. This is not a simple task, as building sustainability is a multi-faceted problem. Collaboration and strong leadership from both public and private sectors to initiate the green movement at all levels are needed. It will require continuous support and actions from government officials to develop the right policies, professionals to innovate in their design practices, and citizens and users to adopt behavioural and lifestyle changes. Specifically:

1. On policy – set priorities for sustainable development policies, set the roadmap and the action plan for long-term strategies, and make institutional arrangements to implement the policies and strategies;
2. On design – redefine building industry practices, especially the standardization of new design strategies for green transformation;
3. On people – change the mindset of people and encourage behavioural change toward more sustainable lifestyles, both at work and at home.

This paper summarizes the above framework and presents specific projects that illustrate its effectiveness. In particular, a case study of green policy development is discussed to show how a top-down approach can drive sustainable development. In addition, a bottom-up approach is illustrated by a building project that demonstrates how buildings can achieve sustainability at an individual level. Finally, a case of fostering low-carbon living through sustainable community-making is presented as an example of behavioural transformation.

Keywords: policy and regulation, smart building, community empowerment

1. ON CONTEXTS OF SUSTAINABILITY IN ASIA

While climate change and decarbonization have been an urgent focus for the world today and many strategies and collaboration opportunities have been proposed in different parts of the world, annual carbon-tracking statistics **suggest that we are still on the “business-as-usual” path. In particular, unprecedented urbanization in Asian** countries and its potential contribution to carbon emissions will become a serious global challenge ahead that we must better understand and manage.

Ever since C40, a leadership group representing 40 major cities around the world, was founded in 2005, it has demonstrated that cities have the power necessary to mitigate climate change, and the mayors of C40 cities have already been using their power to take action to reduce greenhouse gas emissions. Beyond strategies taken at state and city levels, actions can also be further elaborated at the building and individual levels. The possible solutions for this complex climate change problem have to be rolled out in a holistic way, i.e. from various groups including policy decision makers, industry practitioners, and the public.

2. ON POLICY

Policy issues related to sustainable development are complex and multi-faceted. An effective regulatory system is required to control and incentivize behaviours of various stakeholders by distributing rights and responsibilities for sustainable development in a fair way. In Asia, many policy initiatives are happening in China, Japan, South Korea,

and Singapore, most of which are formed under a policy framework with policy priorities clearly identified, possible policy instruments evaluated, and the actions of different institutions and departments coordinated.

Setting policy priorities is very important in driving policy development. As different cities have different unique situations due to geographical, political, and economic contexts, and also citizen preferences, effective policies can only be formed through taking into account and balancing all these factors to find the priorities that are workable. In terms of policy instruments, some examples are regulations, code and standards, tariff and taxes, demonstration projects and public sector procurement, guideline and information provision, as well as education and training. In addition, given the multi-disciplinary nature of sustainable development, different institutions and departments are often involved. Therefore, coordination and clarification of responsibilities is needed to realize the targeted impact from the proposed policies.

In addition to a top-down approach, where policies are driven downstream, feedback aiming to revise or improve the original policy is also important. This can take the form of a bottom-up approach, where industry practitioners can provide valuable feedback to inform policy formation. Both top-down and bottom-up approaches are essential in terms of incorporating building sustainability methodologies into project execution.

Example - HKGBC HK3030 and HKSAR energy saving plan in Hong Kong

In order to adapt to climate change and the increasing local demand for electricity, Hong Kong has established a greenhouse gas (GHG) reduction target of 50% by 2020 and has been exploring options to achieve the objective. In the public consultation paper published by the HKSAR government in 2010, the main method outlined is to target the supply side of energy, which consists of diversifying the energy mix. However, it is also important to consider the demand side of energy. Buildings in Hong Kong consume over 90% of total electricity, and account for over 60% of total GHG emissions. As a result, the Hong Kong Green Building Council (HKGBC) has proposed a 30% reduction of electricity used in buildings by 2030 compared to the 2005 level (HK3030 Campaign). This is **considered to be an aggressive yet achievable target given the government's support and available technology** that can be utilized. This goal will propel Hong Kong towards a more sustainable future.

Based on the technologies used in a number of award-winning green building projects, Hong Kong should be able to achieve higher energy efficiency in buildings by over 50% compared to the 2005 level. Given the increasing building stock and higher energy consumption per capita, the HK3030 Campaign should be able to reduce 58% of electricity consumption when compared to the Business-As-Usual (BAU) consumption.

The HK3030 campaign is proposed to complement the Energy Saving Plan, which was proposed in 2015. The Energy Saving Plan aims to reduce energy intensity by 40% by 2025 through economic, regulatory, educational, and social means. This includes enhancing green performance of government buildings by requiring at least BEAM Plus Gold, reducing electricity use by 50% by 2020, and then further evaluating reduction goals for 2020-2025. On the regulatory side, the Energy Saving Plan outlines methods such as tightening energy related standards and requirements under the energy efficiency ordinances, especially those pertaining to buildings. Additionally, the government hopes to promote energy efficiency efforts by encouraging public educational programs and community campaigns. This will hopefully encourage wider adoption of green building concepts by the private sector as well.

3. ON DESIGN

The successful realization of sustainable neighbourhoods and buildings relies on the adoption of integrated solutions during design, construction, and operation by all practitioners. The multi-disciplinary nature of the building industry requires strong collaboration among parties to gather input from various disciplines to realize the design, e.g. structure, building physics, façade, as well as mechanical, electrical and public health (MEP) and other specialist consultants.

For the structural aspect, the design should provide integrity for the building for a long lifespan and resilience to possible local natural disasters. In order to incorporate different areas of concerns, wind, fire and seismic risks should be considered where appropriate. Furthermore, sustainable material that will provide equivalent strength should be considered and Life Cycle Analysis (LCA) would be a helpful evaluation tool. Building physics brings a fundamental understanding for improving the design of building fabrics and surrounding spaces, and to achieving

buildings that will respond well to the climatic conditions of their chosen site, function efficiently, are pleasant to occupy and hence, economical to run. The building envelope or façade is another key element for sustainable building. A high-performance, low-energy façade greatly impacts the other systems in the building. MEP systems in buildings safeguard the basic requirements on health and safety and provides the most efficient ways to achieve those requirements. Beyond the building itself, the district energy system, renewable energy and micro grid are also popular sustainable elements to incorporate.

Example - Parkview Green in Beijing

Parkview Green is a building structure that includes offices, retail space, and a hotel. It is enclosed by a glass and ETFE plastic glazed envelope that creates a uniform and easily controlled microclimate environment. The air buffer zones **created by this envelope improves the insulation of the building from Beijing's drastic seasonal changes in temperature** – in the winter, the buffer zone enhances thermal insulation, and in the summer, the buffer zones facilitate output of hot-air and induces cold air from the lower entrances of the building.

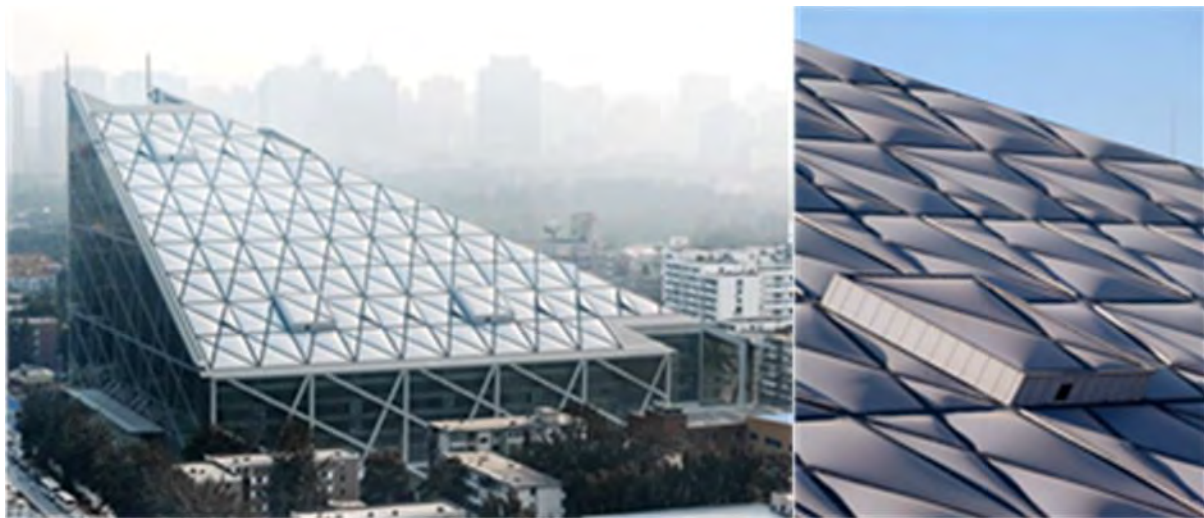

Figure 1: Parkview Green in Beijing, China

Eco-shelter - Parkview Green features a total of four towers, which includes premium-graded offices, a six- star hotel, four floors of retail space—all inside a micro-climate enclosure. The main difficulty in constructing Parkview Green with its current characteristics was to find durable and light glass-like materials to line sloping roofs. At the end, ETFE (Ethy Tetra Fluoro Ethylene) was selected because of its weight, high-corrosion resistance, and resilience towards a large range of temperatures. The **material was used in conjunction with the “through-air”** principle, which naturally ventilated the building through automatic panels in the façade that open and close accordingly. Air ducts were then laid three meters underground, which took air in from the street level to maintain the soil temperature at 15-17 degrees Celsius year round.

Green accomplishments –The technologies used in this project has allowed us to reduce energy use by 50% when compared to similar buildings. As a certified Platinum LEED (Leadership in Energy and Environmental Design) **building, it is one of the world's most sustainable architectural developments that protect its visitors from outdoor air pollution and sandstorms, which are both major threats in Beijing.**

Anti-quake designs – Each part of the building was fitted such that each contact point and adjoining section provides flexibility in sideway movements, which absorbs seismic shocks in the case of an earthquake. This includes the 235 meter cable suspended footbridge, the longest in Asia, which is integrated into two buildings on opposite ends of the bridge. The integration into the buildings help absorb seismic shock and increases the resilience of the bridge against an earthquake.

Fire protection – While it is energy efficient, the building and its enclosed nature brought some fire safety concerns. **As a result, a “melting system” was implemented to the ETFE top, where it melts in the case of a fire to maximize natural ventilation.** There is also a special safety area and path for people and fire trucks to enter and leave the complex safely and efficiently.

Green pyramid – Parkview Green is a pioneering project for sustainable buildings with its façade, sustainable design, and resilient facilities. This will provide occupants and visitors a comfortable and safe experience.

4. ON PEOPLE

As urbanization speeds up in all the major Asian cities, taller buildings are built, and the living space per person is becoming more and more compact. A major challenge is how to maintain a liveable but compact built environment with many vertical cityscapes. The creation of quality living spaces becomes imperative to attract people to live in the city.

Designing buildings for urban residents affects neighbourhood development as well, due to factors such as people movement from outdoor to indoor spaces, wind environment or availability, daylight accessibility, and the urban **heat island and street canyon effect**. **In order to build a sustainable community, responsiveness to people's living environment is very important and it can be achieved through evaluating the micro-climate in the area of development.** A micro-climate study covers wind and natural ventilation availability, sun shading and solar heat gain, daylight accessibility and glare, thermal comfort and odour and pollutant dispersion. Beyond the design phase, **post-occupancy evaluation and energy audits are essential to provide feedback in order to further improve people's living environment.**

Space should be designed not only for current use, but also for positive behaviour change that leads to a sustainable future. Occupant behaviour greatly impacts energy use through lighting and ventilation, and also through the choice of ecologically-friendly products. One example of using technology to facilitate behaviour change is through smart metering. Lastly, many demonstrations for Lifestyles of Health and Sustainability (LOHAS) living are available, and sample eco-home exhibitions are used for educational purposes.

Example - Huilanwan Sunrise Village in Taiwan

The vision of this project is to provide a space for life to unfold — where residents are united as a community through exchanging ideas, sharing beliefs, and committed to a community created on the basis of a healthy and sustainable lifestyle (LOHAS).



Figure 2: Huilanwan Sunrise Village in Taiwan

Health – Huilanwan Sunrise Village hopes to encourage a healthy lifestyle by integrating concepts of urban farming and allowing residents to plant and harvest their own food. Additionally, local restaurants provide healthy food options and all nutritional information on food is displayed on either the packaging or the menu. The village also has fitness amenities such as a gymnasium, swimming pool, and indoor jogging path.

Wellness – Wellness does not only pertain to physical health, but to mental health as well. Huilanwan Sunrise Village encourages activities that will enhance both physical and mental health through establishing groups such as the sailing or flying club. The activities are designed to encourage integration with nature and social interaction between residents. The pedestrian path that spans between and around buildings is also designed for pedestrians to maximize their exposure to nature and to other people.

Sustainability – Computer simulations have allowed developers to maximize daylight and natural ventilation through building design, orientation, and landscape, and to enable all visitors to enjoy the advantages of sustainable design. Green roofs are installed to reduce the urban heat island effect and decrease solar radiation influence on higher floors in buildings, and enhanced natural ventilation is used to improve energy efficiency with regards to electricity used for indoor ventilation. In the summer, buildings are cooled through maximized wind flow and surrounding water features. On the other hand, outdoor spaces are able to retain more heat in the winter through protection from surrounding buildings. Other strategies used to enhance the sustainability of the project include solar PV, rainwater recycling, BMS, energy efficient lighting, and A/C. Together, these measures are expected to conserve 58,000 kWh of energy, 60,000 tonnes of water, and reduce CO₂ emissions by 30,000 tonnes annually when compared to the building of similar scale in Taiwan.

5. CONCLUSION

In the past century, the world has experienced the fastest urban development ever in the history of mankind. In order to reverse the huge negative impact of development, a paradigm shift is necessary. Green transformation in the building industry is required. This comes not only from the top-down policy approach, through building **practitioners' actions, but also through market forces from bottom-up as well as occupants' responses.** Environmental sustainability has huge economic potential, especially in Asia where cities are growing, but different markets have their unique opportunities and challenges. It is therefore important to understand the key drivers and barriers for each market. In general, the building market can be categorized into new buildings and existing buildings, each of which has its own characteristics. The new building sector has fewer constraints, whereas the existing building sector faces more limitations in terms of sustainable improvement. To retrieve or re-energize the aged building assets and reduce the operating costs, building-specific survival strategies must be developed. Effective sustainable development can be achieved through combining different approaches.

ACKNOWLEDGEMENT

Based on Building Sustainability in East Asia: Policy, Design and People: Vincent S. Cheng and Jimmy C. Tong, John Wiley & Sons, 2017, ISBN 9781119277002.

REFERENCES

- [1] C40.org. (2016). C40. [online] Available at: <http://www.c40.org/> [Accessed 5 Aug. 2016].
- [2] **National People's Congress of China. (2016). China's NPC Approves 13th Five-Year Plan. The People's Congresses Journal.**
- [3] Ren, J., Du, J. (2012). Evolution of Energy Conservation Policies and Tools: The Case of Japan. Energy Procedia (17), pp. 171-177. doi:10.1016/j.egypro.2012.02.079
- [4] Kang, S.I., Kim, H., Oh, J. (2012). Korea's Low-Carbon Green Growth Strategy. OECD Development Centre Working Papers. doi:10.1787/5k9cvqmvzbr-en
- [5] Ministry of the Environment and Water Resources, Ministry of National Development. (2014). Sustainable Singapore Blueprint 2015. [online] Available at: <http://www.mewr.gov.sg/ssb/files/ssb2015.pdf> [Accessed 5 Aug. 2016].
- [6] Environment Bureau, (2015). Hong Kong Climate Change Report 2015. [online] Hong Kong Special Administrative Region. Available at: <http://www.enb.gov.hk/sites/default/files/pdf/ClimateChangeEng.pdf> [Accessed 5 Aug. 2016].
- [7] **Hong Kong Green Building Council. (2012). "HK3030" - A Vision for A Low Carbon Sustainable Built Environment in Hong Kong by 2030.** Hong Kong Green Building Council.
- [8] Yau, R., Tong, J., Ng, T., Nugroho, E. (2014). Market Drivers on the Transformation of Green Buildings in Hong Kong – The Green Buildings Roadmap. In: Proceedings of World Sustainable Building 2014. Barcelona.

- [9] **Environment Bureau. (2015). Energy Saving Plan for Hong Kong's Built Environment 2015~2025+. Hong Kong Special Administrative Region.**
- [10] Wan, K.K.W., Chan, M.H., Cheng, V.S.Y. (2012). Considerations of Sustainable High-rise Building Design in Different Climate Zones of China. *International Journal of High-Rise Buildings* (1), pp. 301-310.
- [11] Tong, J., Tse, J., Yau, R. (2015). Opportunities and Challenges of Zero Carbon Buildings, *ZCB Zero Carbon Building Journal* (3), pp. 76-81.

(11) Environmentally Responsive Buildings and Human Interactions Session Organiser: Somfy Asia-Pacific Co. Limited

Session 3.14

SESSION OUTLINE

Smart and digital transformation is now and not in the future. With the process of making our world smarter in every aspect of our lives, data from Internet of Things (IoT) and artificial intelligence (AI) for process are the essential enabler. As one of the leading developers, Sino Group has a good number of initiatives in transforming their building portfolio into a better environment for better experience. These initiatives includes providing healthy and sustainable living space in shopping malls, offices, and residential buildings, enhancing user experience through smarter application of technology and apps. Exemplary of implementing technology, Project Moses is making eco homes a reality and connecting with the community through AI and IoT. Specifically in the built environment, AI can help in finding the energy use pattern and allow smart control to match the supply and demand of our resources within our buildings. Lastly, beyond using the technologies, the top-down and bottom-up approaches in making our building development more sustainable for our future generations will be covered.

After the individual presentations, the panel will share their views on how to bring the smart and digital transformation into reality so that we can enjoy a sustainable world for ourselves and our children.

SESSION CHAIR

Anders HALL, International Business Development, Somfy International; Chairman, Marketing & Communication, ES-SO (EU Solar Shading Organisation)

SPEAKERS AND PRESENTATION TOPICS

1. Research and Experiences on Sustainability by ES-SO
Anders HALL, International Business Development, Somfy International; Chairman, Marketing & Communication, ES-SO (EU Solar Shading Organisation)
2. The **Architect's View on a Design of More Sustainable and High Performing Facades** – and It Works!
Mark CURZON, Director of Architecture, Fender Katsalidis Mirams Architects
3. Case Study - Understanding the key learnings from the use of Automated Solar Shading in Sustainable Buildings
Alistair GRICE, Commercial Specification Manager, Somfy Oceania
4. Connected Homes: A More Comfortable, Secure and Sustainable Life in the Future
Jean-Pierre DUMAS, Managing Director, iHome Systems

(12) High Performance Buildings and Sustainable Neighbourhoods in Sweden

Session Organiser: Sweden Green Building Council

SESSION OUTLINE

The Swedish construction sector's extensive activities in the environmental sphere are of international interest. Sweden is also famous for their pursuit of sustainable development in the field of urban building and planning. In this session, five cases of best practice high-performance buildings and three projects for sustainable neighbourhoods in Sweden are presented.

SESSION CHAIR

Bengt WÄNGGREN, CEO and Founding Chairman, Sweden Green Building Council; Member of the Board, World Green Building Council

SPEAKERS AND PRESENTATION TOPICS

Five Cases of Best Practice High-Performance Buildings in Sweden

1. LIDL Växjö
Johan AUGUSTSSON, Property Director, LIDL Sweden
2. Greenhouse Augustenborg
Jenny HOLMQUIST, Environmental Strategist, MKB Fastighet
3. Solallén
Björn BERGGREN, Senior Consultant/ Phd Student, Skanska/ Lund University
4. BRF Viva
Charlotta SZCZEPANOWSKI, Sustainability Director, Riksbyggen
Anders JOHANSSON, Project Manager, Riksbyggen
5. IKEA Hubhult
Bengt WÄNGGREN, CEO and Founding Chairman, Sweden Green Building Council

Three Projects for Sustainable Neighbourhoods in Sweden

1. Citylab
Tomas GUSTAFSSON, Program Director for Citylab Action, Sweden Green Building Council
2. C/O City
Emilie ZETTERSTRÖM, Communications Officer - Sustainability and Innovation, The City of Stockholm
3. Decode
Åsa NORMAN, Sustainability Consultant, Tyréns
Sarah BRAGÉE, Department Manager of Strategic Analysis, Tyréns

(13) PolyU Green Deck: A Catalyst for a Green and Vibrant Community Session Organiser: The Hong Kong Polytechnic University

SESSION OUTLINE

Located at Hung Hom since 1957, The Hong Kong Polytechnic University (PolyU) has been witnessing the changes and development in this area over the past 60 years. The far from satisfactory urban planning model, rapid growth in population and economic activities in nearby districts have brought along many teething problems: heavy traffic, air and noise pollution, poor connectivity, lack of open space and many others. Not only the 30,000+ staff and students of PolyU suffer, the physical and mental well-being of nearby communities and the daily commuters have also been adversely affected. PolyU, a university which cherishes a sustainable future, is committed to finding an innovative solution to revitalize the districts.

With **“To learn and to apply for the benefit of mankind”** as its motto, PolyU is committed to blazing new trails and bringing positive changes to society. In order to solve the problems faced by Hung Hom old district and to revitalize the nearby districts, PolyU initiated the Green Deck idea in 2012 and engaged a consultant in mid of 2013 to conduct a feasibility study. With the encouraging findings, the University has embarked on extensive community engagement exercise and a wide variety of related research.

Over 100 PolyU academics have been involved in a number of related practical research in the past few years and the research findings has confirmed that the Green Deck is an obvious choice for a sustainable future.

Chairman of Green Deck Task Force and PolyU research teams will share their findings and insights with conference participants on this social innovative project.

SESSION CHAIR

Alex LUI Chun-wan, Chairman, Green Deck Task Force, The Hong Kong Polytechnic University, Hong Kong SAR

SPEAKERS AND PRESENTATION TOPICS

1. From Grey to Green
Alex LUI Chun-wan, Chairman, Green Deck Task Force, The Hong Kong Polytechnic University, Hong Kong SAR
2. Improving Neighbourhood Sustainability with Landscaping in the Context of Climate Change: A Case Study of the Proposed Green Deck in Hong Kong
Edwin CHAN, The Hong Kong Polytechnic University, Hong Kong SAR
3. Noise Mitigation Potential of PolyU Green Deck Proposal
TANG Shiu-keung, The Hong Kong Polytechnic University, Hong Kong SAR
4. Effect of Green Deck on Local Air Quality
LEE Shun-cheng, The Hong Kong Polytechnic University, Hong Kong SAR
5. Proposed Green Deck Project: A Framework for Engaging Stakeholders
Esther YUNG Hiu-kwan, The Hong Kong Polytechnic University, Hong Kong SAR
6. **“Smart Green Resilient” Integrative Urban Environment**
Wilfred LAU, Director, Arup, Hong Kong SAR

From Grey to Green

Alex LUI Chun-wan^a

^a Green Deck Task Force, The Hong Kong Polytechnic University, Hong Kong SAR, cwalexlui@gmail.com

1. INTRODUCTION

In 1948 at the time when Sir Patrick Abercrombie prepared the Preliminary Planning Report of Hong Kong, Hung Hom was already a small residential neighborhood of medium density (200-1200 persons per acre) along the eastern shore of Kowloon Peninsula north of Tsim Sha Tsui. Large areas of reclamation were proposed in the harbor along the east coast of Kowloon Peninsula to be used for residential development in the south and industrial development in the north. Over the next half century, these reclamations were realized step by step, and finally becoming the present East Tsim Sha Tsui, Hung Hom and Whampoa. **The Abercrombie's plan was prepared to guide city development in the next 50 years. At that time, the total population in Hong Kong was estimated to be about 1.5 million; and this plan had proposed an increase of 0.5 million to make a total of 2 million. One very interesting feature in this report was about the proposal of a cross-harbor tunnel from the center of Hong Kong Island to the tip of Kowloon Peninsula. This concept was also realized in 1972 by the completion of the Hong Kong-Hung Hom Cross Harbor Tunnel, linking Hung Hom on the Kowloon side to Wanchai on the side of Hong Kong Island. In 1974, two years after its completion, the tunnel's average daily traffic volume had reached almost 40,000 vehicles.**

Looking back from today, the Hong Kong population **projected in Abercrombie's plan was under by a long way.** The 2001 Hong Kong Census has identified a total population of 6,708,389, 3.5 times higher than the projection. Hong Kong has transformed from a medium size city into a high density Metropolis. Today, Whampoa is largely residential, much of Hung Hom, a high density mixed development neighborhood and East Tsim Sha Tsui, a major urban commercial center. To support urban growth of the city, Hung Hom not only accommodates more people, it has provided homes for three major urban facilities, viz. the Hong Kong Polytechnic University (PolyU), the Hung Hom MTR Station and the Kowloon entrance to the Hung Hom Cross Harbor Tunnel. These facilities co-existing in a high density environment would create many opportunities if treated appropriately, or if not, many problems. Unfortunately today, the Hung Hom neighborhood around PolyU is facing many deeply rooted problems of enormous proportions resulting from 50 years rapid urban development with little consideration on contextual implications, such as heavy traffic, polluted air, lack of amenities, broken down connectivity and depressed neighborhoods. Aiming to turn this negative situation around to become a sustainable and vibrant area, a Green Deck is proposed to be constructed over the cross-harbor tunnel toll plaza so as to achieve the following objectives:

- To improve district air quality and community health
- To extend community connectivity and access to the harbor
- To enhance local amenities and environmental quality
- To revitalize depressed urban centers and upgrade local economy

2. AIR QUALITY AND COMMUNITY HEALTH

With about 120,000 vehicles passing through the Hung Hom Cross Harbor Tunnel Toll Plaza daily, the tunnel design capacity of 78,000 vehicles per day has long been exceeded. The air quality in and around the toll plaza has remained to be extremely poor during most parts of the day due to constant traffic congestions in the toll plaza and vehicles slowly converging and moving into the tunnel tubes. A roadside monitoring station 400m away from the Cross Harbor Tunnel entrance facing PolyU has found nitrogen dioxide (NO₂) and particulate matters (PM) concentrations exceeding the standards of the Hong Kong Air Quality Objectives. This study also cites much higher potential cancer risk for the bus waiting crowds due to long bus queues with running engines. The current environment is a street cannon situation, with unfavorable wind and pollutant dispersions, thus people on the street are exposed to relatively high road-side pollutant concentrations.

It is anticipated that incorporating the proposed Green Deck with air treatment facilities, all pollutants will have a significant decrease. The improvement of PM and carcinogenic compound in the area would be from 30% to 60% and the Hong Kong Air Quality Objectives can be met. Consequently, the cancer risk of different target groups

has 30% to 70% reduction. After Green Deck being built, the overall cancer risk would be decreased over 50%. Furthermore, the proposed bus waiting lounges in the Green Deck would further protect passengers from exposure to polluted air. Other studies have also supported that a clean and green environment can lower the risk of chronic illness including cardiovascular and respiratory diseases, obesity, depression and anxiety. In the long term, healthcare expenditure can be reduced as people may visit clinics and hospitals less often and length of stay in hospitals can also be shortened. A green environment with nicely built walking and bicycle paths, does not only enhance the connection of different areas, but also facilitate people to walk and exercise regularly.

In Hong Kong's sub-tropical climate, the summer is long, wet and hot, reaching above 30 degrees Celsius quite easily during the day. The existing toll plaza will then become an enormous heat island causing agonizing discomfort to large crowds of people who pass through this area and adds to the cooling loads of buildings in the vicinity. The Green Deck would introduce urban greening to improve the environmental quality within urban areas by mitigating urban heat island (UHI) effect and improve thermal comfort by moderating micro-climatic conditions and providing shading. It can bring other benefits including the ability to attenuate noise levels, improve air quality, reduce urban storm water runoff and enhance stress recovery.

3. DISTRICT CONNECTIVITY THROUGH PEDESTRIAN / VEHICULAR SEPARATION

Since the Hung Hom MTR Station and the Hung Hom Cross Harbor Tunnel are located in close proximity, the volumes of vehicular, rail and pedestrian traffic in this area are all very heavy. Nearby neighborhoods are split up by roads, trunk roads, toll plaza and railroads into isolated islands leaving almost no rooms for pedestrians. Street environment has also deteriorated and become confusing to pedestrians. District connectivity amongst **neighboring communities in Hung Hom, Homantin, King's Park and East Tsim Sha Tsui is almost broken down.** There are two old pedestrian footbridges spanning across the toll plaza linking MTR Station to PolyU, which connect to outside areas, and they are heavily utilized especially during morning and evening peaks. A recent study has found the congestion on the northern footbridge is particularly alarming. During morning peaks, **congestion restricts on pedestrian flow (Level of Service, 'LOS' D) and thus becomes undesirable. Evening peak conditions are even worse since pedestrians had to follow a high density crowd while moving slowly on the bridge ('LOS' E). Steep stairs are provided on the footbridges for passengers to transfer from bus to train, and vice versa.** In a highly congested condition with large crowds moving through, these stairs could give rise to accidents especially for accident prone children and elderly.

Upon completion of the proposed Green Deck, which includes a green park on the upper deck and a pedestrian concourse in the intermediate level, pedestrian circulation would be elevated above vehicular and rail traffic, thus it would greatly improve the current situation. The upper deck and the intermediate level of the proposed Green Deck would have significant effect in diverting pedestrians. Simulated pedestrian flows show that during both morning and evening peaks, the **corresponding service standard would improve significantly ('LOS' B).**

The physical environment for pedestrian circulation would also improve considerably since the upper and intermediate levels of the proposed Green Deck would provide multiple points of pedestrian entry for multi-directional connections among the surrounding neighborhoods. The intermediate level would be all weather protected and with accesses to many social facilities which may be located on this level. As such, the proposed Green Deck would **provide area wide connectivity to the Hung Hom, Homantin, King's Park, East Tsim Sha Tsui communities, the MTR station and the Hung Hom/East Tsim Sha Tsui harbor front.**

4. ENHANCING LOCAL AMENITIES AND SATISFYING SOCIAL NEEDS

As most large scale social projects, the Green Deck would have many stakeholders. Due to the high concentration of activities and movements, other than people who live, work and study locally, large crowds of people move through this area every day by using the MTR station, bus stops, and also passing through streets, walkways, and footbridges. For the tens of thousands of these people, there is a lack of public amenities to serve them. For example, very limited urban space is devoted to serve the pedestrians. There is not even a district wide pedestrian signage system. Within 1 km of the proposed Green Deck site, there is no public information center, no sizeable parks, no significant community facilities or libraries. Long queues of bus passengers stand in lines under small canopies in the open engulfed in polluted air waiting for their buses every day.

A recent study has found that a significant proportion of residents were dissatisfied with the neighborhoods' air quality (29.6%), noise level (25.9%), and greenery (22.1%). Furthermore, the top three of areas which needed to be "greener" were Cross-Harbor Tunnel Toll Plaza (49.2%), MTR Hung Hom Station and Hong Kong Coliseum (44.5%), and Whampoa & Hung Hom (43.8%). Most people indicated that forest and botanical gardens (49.8%), tame grassland (38.5%) and sports and recreation facilities (38.5%) were the most needed in the neighborhoods.

The Green Deck would provide a landscaped park of about 43,000 m², which would consist of pleasant footpaths and a variety of outdoor and semi-outdoor venues for passive and active recreation, with a number of indoor facilities for sports and cultural activities all for public use. The intermediate level would further make available about 30,000 m² indoor space for bus waiting lounges and a variety of community facilities for different uses such as meeting, exhibition or retail.

Another study commends the 3-layer concept of the Green Deck: an upper level as an open green park; a middle level for circulation, meeting/exhibition, retail and mechanical functions, and a lower zone for the existing Cross Harbor Tunnel Toll Plaza. Thus, the Green Deck will in effect be a layering of three different programs with different purposes and functions to satisfy various social needs among different user groups such as locals, commuters, tourists, business people, students and the driving community.

The same study also identifies vital connections, which would be re-established by the Green Deck among various currently fragmented urban fabrics in this area and further extended out to neighboring communities as foot paths and bicycle tracks in a pleasant park like and other attractive settings, thus enticing the adoption of a walking and cycling habit by the local communities.

5. REVITALIZING DEPRESSED URBAN CENTERS AND UPGRADING LOCAL ECONOMY

A feasibility study was commissioned by PolyU in 2014, and the cost of construction of the proposed Green Deck was estimated at \$5 billion at 2014 price level. Despite the high cost, the overall direct and indirect benefits are long term and substantial.

It is argued that the Green Deck would revitalize a depressed urban center covering parts of Hung Hom, East Tsim Sha Tsui, and Homantin, which are currently disconnected, underutilized and stagnant for many years, affecting the lives of hundreds of thousands people. Numerous studies, local and overseas, have found desirable view and environment would lead to higher values in properties. In this light, the proposed Green Deck would have a catalytic effect on neighborhood improvements, upgrading both the physical conditions of the neighborhood and the values of thousands of properties in the vicinity. Government revenues would also be increased due to higher rates to be charged on these properties and future land sales.

The Hung Hom MTR Station deck and East Tsim Sha Tsui are currently underutilized prime urban sites with efficient infrastructural access and adjacent to the proposed Green Deck, thus positioned to potential substantial gains. In a conference at PolyU in December 2015, the Hong Kong Tourism Board proposed to develop a new conference center on the Hung Hom MTR Station deck, taking advantage of the location and the hotel, retail, entertainment facilities in East Tsim Sha Tsui, to support the constrained convention tourism due to a lack of suitable urban venues.

Tourism is one of the four pillar industries for Hong Kong employing nearly 80,000 people. However lately, tourism development is losing steam due to a lack of new attractions. The proposed Green Deck would be a unique attraction in its own right, and it would bring about an agglomeration effect to a cluster of other nearby attractions such as the clock tower, the Avenue of Stars, Tsim Sha Tsui promenade, the Science Museum and the History Museum.

The tangible and intangible benefits brought about by the Green Deck are widely spread and difficult to be accurately valued. A recent study identifies that urban green infrastructures are underrated. Since environmental and social goods are usually not traded in the market. By only evaluating the economic benefits, the total benefits of the investment would be underestimated as the non-marketed goods are neglected. Thus, from the social point of view, the proposed Green Deck could be beneficial to the public.

6. CONCLUSION

Through public consultation in the past few years, the proposed Green Deck has been receiving overwhelming supports from the society. Due to the high initial construction cost, what it would need is a strong political will and a vigorous government leadership for its implementation.

REFERENCES

- [1] Abercrombe, Patrick., September 1948. *Preliminary Planning Report of Hong Kong*. Hong Kong: Government Printer.
- [2] **Chan, Edwin H.W. et. al., 2014. 'A Framework for Stakeholder Engagement to Formulate the proposed Green Deck Project at Cross Harbor Tunnel', paper presented in Task Force on the Green Deck Committee Meeting, The Hong Kong Polytechnic University, 2 September 2014 .**
- [3] **Chan, Edwin H.W. et. al., 2015. 'Costs and Benefits Analysis on the Thermal Effect on the Green Deck to the Surrounding Outdoor Environment', paper presented in Task Force on the Green Deck Committee Meeting, The Hong Kong Polytechnic University, 19 January 2016 .**
- [4] **Chau, C.K. et. al., 2016. 'Investigating the Effects of Greenery on Temperature and Thermal Comfort in Urban Parks', paper presented in Task Force on the Green Deck Committee Meeting, The Hong Kong Polytechnic University, 19 January 2016 .**
- [5] Demand Study for New Convention and Exhibition Facilities in Hong Kong, 2014. commissioned by the Working Group on Convention and Exhibition Industries and Tourism under the Economic Development Commission.
- [6] **Dennis Lau & Ng Chun Man Architects & Engineers (HK) Ltd., 2014. 'Campus Masterplan Studies of The Hong Kong Polytechnic University - Landscape Deck Over Cross Harbor Tunnel Toll Plaza'.**
- [7] Fan, I., & Yim, J., Hong Kong tourism industry, Hong Kong Trade Development Council, Retrieved from http://www.hktdc.com/resources/MI/Article/ef/2011/04/346536/1303354802473_hsb1_l0420en.pdf. [Retrieved on 16 August 2011]
- [8] Hong Kong Legislative Council LC Paper No. CB (1)912/13-14(06), Ref: CB1/PL/TP; Panel on Transport Meeting on 28 February 2014, para. 3, p. 2.
- [9] Hong Kong Second Comprehensive Transport Study, Final Report, 1989. Hong Kong University Libraries, Hong Kong, May 1989, fig. 3.16. p. 45.
- [10] **Hsu, Mark S.C. et. al., 2016. 'Cost-Benefit Analysis of the Green Deck Development', paper presented in Task Force on the Green Deck Committee Meeting, The Hong Kong Polytechnic University, 21 March 2016.**
- [11] **Hui, Eddie C.M., 2015. 'The Effect of the Green Deck on the Local Real Estate Market', paper presented in Task Force on the Green Deck Committee Meeting, The Hong Kong Polytechnic University, 2 September 2014.**
- [12] **Hung, W.T., 2015. 'A Study on the Proposed Green Deck at Cross Harbor Tunnel (CHT) – Assessment of Pedestrian Circulation and Vehicular Traffic Emissions', paper presented in Task Force on the Green Deck Committee Meeting, The Hong Kong Polytechnic University, 30 June 2014.**
- [13] **Jachna, Timothy.J. et. al., 2016. 'Programme for the Green Deck', paper presented in Task Force on the Green Deck Committee Meeting, The Hong Kong Polytechnic University, 21 March 2016.**
- [14] **Lee, S.C. et. al., 2014. 'Effect of the Green Deck on Local Air Quality', paper presented in Task Force on the Green Deck Committee Meeting, The Hong Kong Polytechnic University, 30 June 2014.**
- [15] **Niu, J.L. et. al., 2014. 'Ventilation Strategies for Bus Passenger Waiting Areas and Boarding Passages', paper presented in Task Force on the Green Deck Committee Meeting, The Hong Kong Polytechnic University, 2 September 2014.**
- [16] **Wong, Frances K.Y. et. al., 2016. 'The Health and Social Impact of the Green Deck Project on the Population Living in the Neighborhood, paper presented in Task Force on the Green Deck Committee Meeting, The Hong Kong Polytechnic University, 21 March 2016.**

Improving Neighbourhood Sustainability with Landscaping in the Context of Climate Change: A Case Study of the Proposed Green Deck in Hong Kong

Edwin CHAN Hon-wan^a, CHAU Chi-kwan^b, Esther YUNG Hui-kwan^c, Conrad PHILIPP^d, HAN Jianbo^e

^a The Hong Kong Polytechnic University, Hong Kong SAR, edwin.chan@polyu.edu.hk

^b The Hong Kong Polytechnic University, Hong Kong SAR, chi-kwan.chau@polyu.edu.hk

^c The Hong Kong Polytechnic University, Hong Kong SAR, esther.yung@polyu.edu.hk

^d University of South Australia, conrad.philipp@unisa.edu.au

^e The Hong Kong Polytechnic University, Hong Kong SAR, blacksunset1116@hotmail.com

ABSTRACT

Climate change harms environmental, social and economic sustainability at the community level. Building green open spaces proves to be a useful measure to cool their surrounding areas. This paper aims to preliminarily build a model to help decision-makers strategically use landscapes to mitigate warming climate. In this article, the cooling capacity of green open spaces was identified and evaluated. Then the thermal benefits were identified and defined. Afterwards from the operationalised definitions, formulas were developed to quantify the benefits. Lastly, a case study of a proposed green platform called Green Deck was conducted to show how the model works. The results show a significant capability of landscaping works to enhance sustainability through combating climate change at the neighbourhood level. A strategic thinking path for government is also raised to improve the decision-making of landscape works.

Keywords: landscaping, climate change, cost-benefit analysis

1. INTRODUCTION

Climate change and urban heat islands (UHIs) are the major causes of warming climate in Hong Kong. At the neighbourhood level, heat stress caused by warming microclimate is supposed to impact on both human health condition and human behaviour performance. Thus, cooling the microclimate is one of the main objectives to improve the community livability and sustainability. As a form of landscape, green urban parks are effective to **mitigate the warming temperature by cooling its surrounding areas, which are called 'park cool islands' (PCIs)**. Based on PCI theories, this paper aims to preliminarily build a model to help decision-makers strategically use **landscapes to mitigate warming climate. Firstly, using literature review, equations about PCIs' thermal benefits** to their neighbourhood areas were formed. Then, the calculated benefits were used in benefit analysis, a partial use of the cost-benefit analysis, to develop a mathematic model to evaluate their monetary values. Afterwards, a case **study of a planned overhead platform called 'Green Deck' was conducted with the model. Lastly, the results of the case study** were discussed, and some policy and research recommendations were given.

2. PREDICTION OF PARK COOL ISLAND

A PCI is the neighbourhood area of a green park which has a lower temperature than other parts of the city. In this research, a PCI is described by two dimensions, its size and the magnitude of the decrease in temperature.

At the decision-making stage, the size of a PCI can only be estimated by the size of the park. Although some studies using remote sensing and other measure technologies have revealed that the scope of a PCI is not linearly **related to the size of the park. Jauregui's conclusion that the cooling effect of a park can reach one-park width** beyond its boundary has often been cited and validated and is also used in this research.

The magnitude of the decrease in temperature differs with different geographic contexts. The maximum intensity of a PCI in Hong Kong has been calculated as approximately 1.4°C. Thus, the average park cool island intensity was assumed as 0.7°C, which was rounded off as 1°C in this research. As the intensity inside a park is stronger than it outside the park, 1.5°C is used, as a rounded-off value of 1.4°C.

3. BENEFIT ANALYSIS AND CASE STUDY

3.1 Method basis: Cost-benefit analysis (CBA)

Cost-benefit analysis (CBA) is a widely used policy decision-making tool. Using CBA in an environmental project can ensure the goal of ecologically sustainable development. Thus, in this research CBA can well reveal whether a green open space can improve its neighbourhood sustainability.

CBA has the capability to evaluate the monetary values of the well-beings that are not traded on the market. This capability relies on two methodology paths, contingent valuation and revealed preference. In this research, the revealed preference method, in which data mainly derive from the official databases and professional works, was used.

The steps of CBA were given by Hanley & Spash. Although only the benefit analysis was used in this research. These essential steps were still obeyed.

3.2 Identify the benefits

In the first step, the benefits of this research should be defined. The benefits were defined as the benefits brought by the PCI of a park.

Secondly, based on the literature review, four kinds of such benefits were identified. They are health benefits, saved energy consumption, increased productivity and increased recreational activities.

The warming weather causes various diseases. Consequently, more morbidities and mortalities would emerge. Besides impacts on human health, the increasing temperature also causes changes in human behaviour. Building users will use more energy to keep the indoor environment thermally comfortable. In the workplaces, a higher temperature may cause lower productivities. The hot weather also prevents people from going outside for recreational purposes. The baseline temperature of the influences on productivity and park use are both 25°C. The change patterns of the four benefits are summarised in Table 1.

Item	Change Pattern	
Morbidity	4.5% with 1°C change	
Mortality	(Rate) 6.86 with 1°C change	
Electricity Consumption	Residential	20.2% with 2°C change pre year
	Commercial	6.1% with 2°C change per year
Gas Consumption	Residential	4.8% with 2°C change (Positive) per year
Productivity	4% with 2°C change	
Recreational Activity	$y = -3.6393x + 141.89$ y = number of park users x = change of temperature	

Table 1: Change pattern of each item adaptable to Hong Kong

Based on Lin's equation, the increased recreational rates due to the thermal effect of a park under each certain temperature were calculated and shown in Table 2.

Daily Mean Temperature	Increased Recreational Activity Rate	Annual Number of Days
27°C	12.5%	30.3
28°C	13.7%	32.8
29°C	15.0%	37.9
30°C	16.7%	30.6
31°C	18.8%	3.8
32°C	21.5%	0.2

Table 2: Increased recreational rates due to the thermal effect of a park

3.3 Model development

Then the economic impact of each of these benefits was modelled by benefit analysis. The equations are shown in Table 3.

Benefit		Economic Impacts	Formulas	Factors in the Formula
Health Benefit	Reduced Morbidity	Hospital Admission Fees	$BMB = NRMB \times (HF + RAD)$	NRMB=reduced number of morbidity; HF=average hospitalisation fee; RAD=cost of a restricted active day
		Restricted Active Days		
	Reduced Mortality	Loss of Statistical Value of Life	$BMT = NRMT \times SVL$	NRMT=reduced number of mortality; SVL=statistical value of each life
Saved Energy Consumption		Saved energy fees	$BEC = \sum(REC \times UPE)$	REC=reduced energy consumption of each kind of building; UPE=unit price of energy of each kind of building
Increased Productivity		Increased GDP	$BIP = \sum(IPR \times NDP) \times NW \times GDP/C \times D$	IPR=increased productivity rate under certain temperature; NDP=number of the days under certain temperature; NW=number of the influenced workers; GDP/C*D=GDP per capita per day
Increased Recreational Activity		Increased recreational value	$BRV = \sum(IPUR \times NDR) \times NU \times RV$	IPUR=increased park user under certain temperature; NDR=number of the days under certain temperature; NU=predicted average number of park users; RV=recreational value of a park to each of its users

Table 3: Formulas to quantify the thermal benefits

3.4 Case study resulting

The last step of CBA was conducted using a case study. An overhead platform called the Green Deck was chosen. The key neighbourhood information of this research, summarised in Table 4, were acquired from the databases of JLL, WCWP, Esri, Census and Statistics Department, and Campus Development Office of The Hong Kong Polytechnic University.



The Green Deck	The Park Cool Island		Area of Frequent Park Users
			
Area of the Green Deck	43,000m ²	Area of PCI	426,568m ²
Population in PCI	8,122	Employees in Poor Air-Conditioned Environment	532
Total Gross Floor Area of Commercial Buildings	507,156m ²	Average Daily Park User	9,250

Table 4: Basic information of the green deck and its neighbourhood area

The bus drivers, logistics workers and construction field workers were assumed to work in a poorly air-conditioned environment.

The study about park using pattern in Hong Kong shows that 59% frequent users prefer to using parks within 15-minute walk. Thus, a **circle area with 800 metres' radius and centred at the centre of the Green Deck was used** to present where the predicted frequent users of the Green Deck may be located. The attractiveness from other nearby parks and using frequency of the frequent users are also accounted in estimating the average daily park user number.

Some other key data for the research were also found from the academic works and official sources. These figures and their reference sources are listed in Table 5.

Name of Figure	Figure
Median Monthly Wage	HK\$177,600
Hospital Admission Fee	HK\$1,110
GDP per Capita	HK\$311,359.8
Energy Consumption of Commercial Buildings	135.48kWh/m ² /yr
Energy Fee for Commercial Buildings	HK\$1.2/kWh
Annual Number of Days under 25°C above	186
Discounted Rate	4%
Recreational Value of Green Parks	HK\$13.2

Table 5: Other key figures for the research

The results of the benefit analysis are summarised in Table 6.

Benefit	Stakeholder	Annual Benefit in Current Value	Benefit of Present Value over 50 Years
Reduced Morbidity	Neighbourhood Population/ Government/ Business Sector	HK\$5,899	HK\$126,509
Reduced Mortality	Neighbourhood Population	HK\$175,990,430	HK\$3,780,658,908
Saved Energy Consumption	Building Users	HK\$2,555,993	HK\$54,908,318
Increased Productivity	Business Sector	HK\$1,688,121	HK\$36,264,530
Increased Recreational Activities	Neighbourhood Population	HK\$2,279,445	HK\$48,967,458

Table 6: Results of benefit analysis

4. DISCUSSIONS

The model developed above can be used as a tool to help governments from a financial perspective to predict that how much a landscape project enhances the three pillars of sustainability at the community level in facing climate change. The results could be further used for strategic policy decision-making by answering three questions. Firstly, whether landscapes are needed to combat climate change? Secondly, where is the most efficient location? Thirdly, **how to adjust the social policies to maximum the green landscapes' thermal benefit?**

The most direct information that the thermal benefits shows is that they can enhance all the three pillars of sustainability. The neighbourhood environment can be reflected by health benefit. The environmental sustainability is also benefited from the reduced energy consumption. For economic sustainability, **the industrial's performance can be improved by the fewer workers' sick absences, the less energy consumption and the higher productivity.** For social sustainability, the poverty can be reduced by the less morbidity and mortality and the less energy consumption fee. It will also increase the social integration at the community level by increasing recreational activities. Thus, based on the local government sustainable development strategies and the monetary value given by the model, the government can judge whether to use green open spaces to mitigate the climate change. As some of the benefits can enhance two or three kinds of sustainability, the relationship between each kind of sustainability and each benefit will be the direction for further research.

It is shown that land use is the main factor that can influence the result from the model. The land use in this paper mainly contains three sorts, residential area, commercial area and industrial area. According to this research, residential areas enjoy the most kinds of thermal benefits, including health benefits, saved energy consumption, and increased recreational activities. Thus, residential areas may be the priority to use green landscapes to combat climate change. While, commercial areas, which are assumed to mainly accommodate workers in the well air-conditioned building, enjoy fewer kinds of benefits. These benefits are health benefits and saved energy consumption. Thus, commercial areas may be medium favouring this mitigation effort. The industrial areas, which are assumed to provide poorly air-conditioned workplaces to workers, enjoy only one kind of benefit, which is increased productivity. Thus, this kind of place may be the least suitable place to use green landscape to mitigate climate change. However, it requires more case studies and sensitive analysis to judge whether this order is correct and reasonable in the future studies.

In this study, we also found some other factors related local public policy and policy performance might have a determinant impact on the value of the thermal benefits. Thus, in the operation stage of the landscapes, some public policies can be adjusted to help the landscapes bring larger benefits. For instance, the power rate can be regionally increased to encourage a lower dependence on air conditioners. Another example is the gross floor area and land utilisation policies can be modified to make the most use of the thermal benefits.

An additional discussion is about the Green Deck. Such kind of overhead landscape is an innovative measure to make the urban areas greener and resilient to the warming climate. It broadens the vertical greenery practices. It also breaks the size limitation of the green roofs. And from this research, it is shown that the Green Deck can bring

considerable monetary value. In the future, the comparison between the Green Deck and the conventional practices are expected to be studied.

5. CONCLUSIONS

In this paper, a model was built to help decision-makers strategically use landscapes to mitigate warming climate. The cooling effect of green landscapes can bring four kinds of benefits to their surrounding communities, including health benefit, saved energy consumption, increasing productivity and increased recreational activities. These benefits were modelled into four equations to measure the monetary value of each benefit. With the result from this model, governments can deal with warming climate by making decisions about whether to use green landscapes, where is the best location, and how to adjust related policies to make the best use of such kind of thermal effect. However, before really forming a practical decision-making tool, further some research is still required.

REFERENCES

- [1] Barbier, E. B., Markandya, A. & Pearce, D. W., 1990. Environmental Sustainability and Cost-Benefit Analysis. *Environmental and Planning A*, 22, 9, 1259-1266.
- [2] Cao, X., Onishi, A., Chen, J. & Imura, H., 2010. Quantifying the Cool Island Intensity of Urban Parks Using ASTER and IKONOS Data. *Landscape and Urban Planning*, 96, 4, 224-231.
- [3] Carson, R. T., Flores, N. E., Martin, K. M. & Wright, J. L., 1996. Contingent Valuation and Revealed Preference Methodologies: Comparing the Estimates for Quasi-Public Goods. *Land Economics*, 72, 1, 80-99.
- [4] Census and Statistics Department, 2012. 2011 Population Census-Fact Sheet for Tertiary Planning Units 213 and 215-216. [Online]. Retrieved from: <http://www.census2011.gov.hk/en/district-profiles/tpu/tpu213.html> [Retrieved on 26 September 2016].
- [5] Census and Statistics Department, 2015. 2014 Report on Annual Earning and Hours Survey. [Online]. Retrieved from: <http://www.statistics.gov.hk/pub/B10500142014AN14B0100.pdf> [Retrieved on 24 September 2016].
- [6] Census and Statistics Department, 2015. Hong Kong Energy Statistics: 2014 Annual Report. [Online]. Retrieved from: <http://www.statistics.gov.hk/pub/B11000022015AN15B0100.pdf> [Retrieved on 24 September 2016].
- [7] Chan, E. Y. Y., Goggins, W. B., Yue, J. S. K. & Lee, P., 2013. Hospital Admissions as a Function of Temperature, other Weather Phenomena and Pollution Levels in an Urban Setting in China. *Bulletin of the World Health Organization*, 91, 8, 576-584.
- [8] Chen, W. Y. & Jim, C. Y., 2008. Cost-Benefit Analysis of the Leisure Value of Urban Greening in the New Chinese City of Zhuhai. *Cities*, 25, 5, 298-309.
- [9] Chow W. T. L., Pope, R. L., Martin, C. A. & Brazel, A. J., 2011. Observing and Modeling the Nocturnal Park Cool Island of an Arid City: Horizontal and Vertical Impacts. *Theoretical and Applied Climatology*, 103, 1, 197-211.
- [10] Declat-Barreto, J., Brazel, A. J., Martin, C. A., Chow, W. T. L. & Harlan, S. L., 2013. Creating the Park Cool Island in an Inner-City Neighborhood: Heat Mitigation Strategy for Phoenix, AZ. *Urban Ecosystems*, 16, 3, 617-635.
- [11] DLN, 2014. Campus Masterplan Studies of the Hong Kong Polytechnic University: Landscape Deck over Cross Harbour Tunnel Toll Plaza. DLN, Hong Kong.
- [12] Environmental Bureau, 2015. Hong Kong Climate Change Report 2015. [Online]. Retrieved from: <http://www.enb.gov.hk/sites/default/files/pdf/ClimateChangeEng.pdf> [Retrieved on 14 September 2016].
- [13] Fung, W., Lam, K., Hung, W., Pang, S. & Lee, Y., 2006. Impact of Urban Temperature on Energy Consumption of Hong Kong. *Energy*, 31, 14, 2623-2637.
- [14] Green Power, 2012. Report on Urban Heat Island Effect in Hong Kong. [Online]. Retrieved from: http://www.greenpower.org.hk/html/download/concern/gp_urban_heat_island_report_2012.pdf [Retrieved on 25 September 2016].
- [15] Hanley, N. & Spash, C. L., 1993. *Cost-Benefit Analysis and the Environment*. Edward Elgar, Cheltenham; Northampton.
- [16] Hospital Authority, n.d. Fee and Charges. [Online]. Retrieved from: https://www.ha.org.hk/haho/ho/cs/v3/serviceguide_feechg-en.htm [Retrieved on 24 September 2016].

- [17] Jauregui, E., 1990. Influence of a Large Urban Park on Temperature and Convective Precipitation in a Tropical City. *Energy and Buildings*, 15, 3-4, 457-463.
- [18] Kjellstrom, T., Kovats, S., Lloyd, S. J. & Tol, R. S. J., 2009. The Direct Impact of Climate Change on Regional Labor Productivity. *Archives of Environmental & Occupational Health*, 64, 4, 217-227.
- [19] Lam, K. S., Hung, W. T. & Fung, W. Y., 2004. Tender AM02-316: Provision of Service for Characterizing the Climate Change Impact in Hong Kong. [Online]. Retrieved from: http://www.epd.gov.hk/epd/english/climate_change/files/Climate_Change_Report_final.pdf [Retrieved on 21 September 2016].
- [20] Lin, T. P., 2009. Thermal Perception, Adaptation and Attendance in a Public Square in Hot and Humid Regions. *Building and Environment*, 44, 10, 2017-2026.
- [21] Lo, Y. H. A., 2009. An Exploratory Study of the Multiple Value and Roles of Urban Green Spaces in Hong Kong. Thesis (M.Phil). The University of Hong Kong.
- [22] McGeehin, M. A. & Mirabelli, M., 2001. The Potential Impacts of Climate Variability and Change on Temperature-Related Morbidity and Mortality in the United States. *Environmental Health Perspectives*, 109, Supplement 2, 185-189.
- [23] Michelozzi, P., Accetta, G., de Sario, M., D'Ippoliti, D., Marino, C., Baccini, M., Biggeri, A., Anderson, H. R., Katsouyanni, K., Ballester, F., Bisanti, L., Cadum, E., Firsberg, B., Forastiere, F., Goodman, P. G., Hojs, A., Kirchmayer, U., Medina, S., Paldy, A., Schindler, C., Sunyer, J. & Perucci, C. A., 2009. High Temperature and Hospitalizations for Cardiovascular and Respiratory Causes in 12 European Cities. *American Journal of Respiratory and Critical Care Medicine*, 179, 5, 383-389.
- [24] Patz, J. A., Githeko, A. K., McCarty, J. P., Hussein, S., Confalonieri, U. & de Wet, N., 2003. Climate Change and Infectious Diseases. In: McMichael, A. J., Campbell-Lendrum, D. H., Corvalán, C. F., Ebi, K. L., Githeko, A. K., Scheraga, J. D. & Woodward, A. (eds). *Climate Change and Human Health: Risks and Responses*. World Health Organization, Geneva.
- [25] Planning Department, 2003. Hong Kong 2030 Planning Vision and Strategy: Economic and Financial Assessments: Assessment Methodology Formulation. [Online]. Retrieved from: http://www.pland.gov.hk/pland_en/p_study/comp_s/hk2030/eng/consultants/pdf/Tpaper4.pdf [Retrieved on 24 September 2016].
- [26] Ren, Z., He, X., Zheng, H., Zhang, D., Yu, X., Shen, G. & Guo, R., 2013. Estimation of the Relationship between Urban Park Characteristics and Park Cool Island Intensity by Remote Sensing Data and Field Measurement. *Forests*, 4, 4, 868-886.
- [27] Scott, M. J., Wrench, L. E. & Hadley, D. L., 1994. Effects of Climate Change on Commercial Building Energy Demand. *Energy Sources*, 16, 3, 317-332.
- [28] Seppänen, O., Fisk, W. J. & Lei, Q. H., 2006. Effect of Temperature on Task Performance in Office Environment. [Online]. Retrieved from: <http://escholarship.org/uc/item/45g4n3rv> [Retrieved on 21 September 2016].
- [29] Spronken-Smith, R. A. & Oke, T. R., 1998. The Thermal Regime of Urban Parks in Two Cities with Different Summer Climates. *International Journal of Remote Sensing*, 19, 11, 2085-2104.
- [30] The Hong Kong Polytechnic University, 2015. Green Deck—An Innovative Solution to Enhance the Environment. [Online]. Retrieved from: <http://www.polyu.edu.hk/cpa/greendeck/> [Retrieved on 20 September 2016].
- [31] The World Bank, 2016. GDP per Capita (Current US\$). [Online]. Retrieved from: <http://data.worldbank.org/indicator/NY.GDP.PCAP.CD> [Retrieved on 5 January 2016].
- [32] Wong, K. K., 2009. Urban Park Visiting Habits and Leisure Activities of Residents in Hong Kong, China. *Managing Leisure*, 14, 2, 125-140.
- [33] Yu, C., Pan, W., Zhao, Y. S. & Li, Y. G., 2015. Challenges for Modeling Energy Use in High-Rise Office Buildings in Hong Kong. *Procedia Engineering*, 121, 513-520.
- [34] Yu, X. & Hien, W. N., 2006. Thermal Benefit of City Parks. *Energy and Buildings*, 38, 2, 105-120.

Noise Mitigation Potential of PolyU Green Deck Proposal

TANG Shiu-keung^a

^a The Hong Kong Polytechnic University, Hong Kong SAR, shiu-keung.tang@polyu.edu.hk

ABSTRACT

The Green Deck project is a proposal of PolyU. In this project, a big deck with greenery on its top and some special functional floors underneath is proposed to cover the current Cross Harbour Tunnel toll area. It has many benefits and the noise reduction at locations far from the deck is one of them. However, the noise underneath the Green Deck in the current toll area and the bus terminal area will be increased by the reverberation due to the deck. Also, since the toll areas and the bus terminal area cannot be concealed, strong sound radiations from the openings are expected. This will seriously increase the noise levels at nearby areas, especially the entrance and the podium of PolyU. It is proposed to use micro-perforated sound absorbers as louvres together with strong sound absorptive ceiling to mitigate the strong sound levels underneath the deck. The micro-perforated louvres will be installed along the boundaries of the Green Deck facing PolyU. It can be made transparent so as to allow for sufficient daylight penetration. A numerical ray-tracing study is carried out to investigate how far the noise mitigation proposal can help reducing the noise levels under the deck. Results show that the Green Deck with the above noise mitigation measure can lower down the noise levels at PolyU and the nearby establishments by 3 to 20 dBA. The noise level underneath the deck will remain high, but it can be kept at a level which is comparable to the current situation without the deck.

Keywords: adaptable design, sound insulation, noise control

1. INTRODUCTION

Recently, there is a proposal on the building up a Green Deck which will cover the toll area of the Cross Harbour Tunnel. The proposed deck is large and is expected to be able to foster strong connectivity between various areas surrounding the toll area. The current conceptual design of the Green Deck is shown in Figure 1.

In principle, the deck will cover the traffic within the toll area of the Cross Harbour Tunnel and will provide some acoustical protection to the surrounding building if one sticks to the principle of noise reduction due to obstruction of the direct-line-of-sight. However, this deck tends to tunnel the sound sources, resulting in the accumulation of acoustical energy under the deck. This energy will then radiate out of this semi-enclosed under-deck cavity at the openings. These openings then act as large horns which radiate sound powerfully into the surroundings. Such radiation can be so powerful to result in significant rise in noise levels at locations even several kilometres away. It appears that some openings are directed towards PolyU and/or near to PolyU, the MTR station and the buildings flanking Hong Chong Road (and even Austin Road). Such accumulation of sound energy also results in very high noise level under the deck. This will affect all the vehicle drivers in this area.



Figure 1: Conceptual design of the green deck

The major objectives of this study are to estimate the effect of the Green Deck as it is currently proposed and to explore appropriate noise mitigation measure. Since the design of the deck is not in its final stage, the mitigation measure proposed later in this report is indicative and can be used as a reference for the final design.

2. NUMERICAL SIMULATIONS OF GREEN DECK'S EFFECTS ON NOISE

The site in concern is too big so that the finite-element or boundary-element methods are not applicable because of computer resources constraint. The ray tracing method is commonly used in this circumstance.

2.1 The ray-tracing modelling

In this study, numerical modelling using ray tracing algorithm implemented in ODEON v.8 is carried out for the octave bands from 125Hz to 4kHz (Traffic noise frequency range). The ray-tracing technique is originally used in optics. In acoustics computation, the sound energy radiated out from a source is assumed to be carried by rays which move in a straight line until they hit a reflecting surface. The energy of a ray will be reduced according to the sound absorption properties of the surface it hits. Each ray has an initial energy which is the total sound energy emitted by the source divided by the number of rays used for computation. ODEON is a piece of software which combines the ray-tracing algorithm with image source methods for more reliable results and faster calculation (hybrid model). In ODEON v.8, the reflection based scattering method and the oblique Lambert are adopted for better handling of scattering.

Figures 2a and 2b show the computational models in the ODEON for the cases without and with the Green Deck respectively. The numbered blue dots represent the check points where noise levels are calculated.

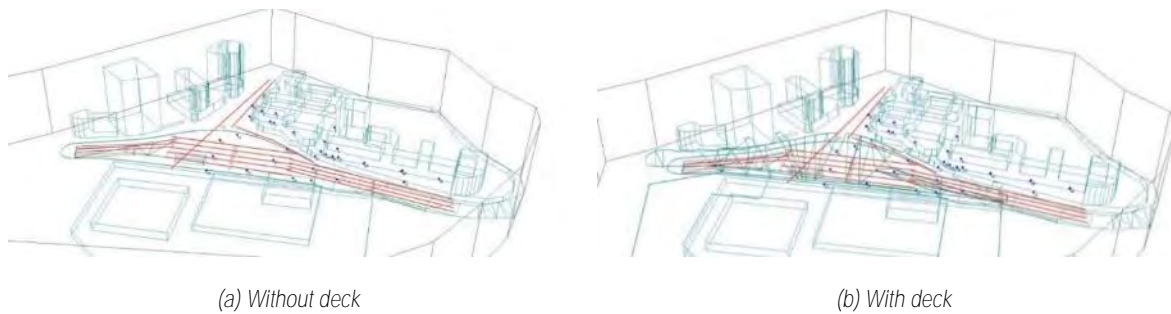

Figure 2: Computational models in ODEON

Source	Location	Sound Power (dB)
L1	At Cross Harbour Tunnel Entrance	120
L2	At Cross Harbour Tunnel Entrance	120
L3	Hong Chong Road towards Ho Man Tin	100
L4	Hong Chong Road towards Ho Man Tin	100
L5	Hong Chong Road towards Ho Man Tin	100
L6	Hong Chong Road towards Ho Man Tin	100
L7	Cross Harbour Tunnel Toll Gate Area	98
L8	Cross Harbour Tunnel Toll Gate Area	98
L9	Cross Harbour Tunnel Toll Gate Area	98
L10	Cross Harbour Tunnel Toll Gate Area	98
L11	Cross Harbour Tunnel Toll Gate Area	98
L12	Hong Chong Road towards Toll Gate	98
L14	Hong Chong Road (near lane to PolyU)	98
L15	Hong Chong Road (near lane to PolyU)	98
L16	Hong Chong Road (near lane to PolyU)	98
L17	Hong Chong Road (near lane to PolyU)	98

Table 1: Traffic noise powers (constant for all frequencies)

For simplicity, the traffic, which is the major source of sound, is assumed to be made up of a number of line sources of finite length (5 m each), but of different powers because of the differences in the traffic flow volume and expected

average vehicle speed. Tables 1 and 2 summarize the input data to ODEON. The data in Table 2 look a bit arbitrary, but this is no big problem as we are predicting the noise level difference between the cases with and without the Green Deck.

Surface	Material	Sound Absorption Coefficient					
		125Hz	250Hz	500Hz	1kHz	2kHz	4kHz
Roads, outdoors	Rough concrete	0.02	0.03	0.03	0.03	0.04	0.07
Windows, Curtain wall	Glass, large panes of heavy plate glass	0.18	0.06	0.04	0.03	0.02	0.02
External wall, PolyU tiles	Marble or glazed tiles	0.01	0.01	0.01	0.01	0.02	0.02
Buildings façade	smooth painted concrete	0.01	0.01	0.02	0.02	0.02	0.05
Poly podium ceiling	smooth concrete painted or glazed	0.01	0.01	0.02	0.02	0.02	0.02

Table 2: Sound absorption coefficients of surfaces

2.2 Change of noise levels due to the green deck

In order to make the noise reduction relevant to traffic noise, the normalized traffic noise spectrum in EN1793-3 is adopted to produce a single A-weighting rating. This is a common method to study the performance of frequency-sensitive noise attenuating devices. Table 3 illustrates the rise in noise levels after the installation of the Green Deck. Negative figures devote noise reduction.

Check Point	Location	Noise Level Increase (dB)						
		125Hz	250Hz	500Hz	1kHz	2kHz	4kHz	Weighted*
1	CD podium	4.4	4.1	4.0	3.9	3.5	2.4	3.4
2	DE courtyard	5.9	5.6	5.7	5.9	5.8	5.0	5.5
3	DE podium	4.9	4.6	4.6	4.5	4.1	3.0	4.0
4	DE façade	6.3	5.8	5.7	5.5	4.8	2.7	4.8
5	Library façade	2.6	2.2	2.2	2.0	1.4	0.3	1.5
6	Library entrance	-0.3	-0.8	-0.8	-0.7	-0.8	-0.8	-1.0
7	Library	5.5	4.5	4.3	4.0	2.8	0.4	3.2
8	Lawn	3.3	2.6	2.5	2.3	1.7	0.5	1.8
9	P Podium	9.3	8.3	8.1	7.8	6.6	3.6	6.9
10	P Façade	1.4	0.8	0.7	0.5	0.0	-0.7	0.1
11	PQ podium	9.8	8.5	8.2	7.6	5.9	2.5	6.4
12	PQ façade	1.8	1.5	1.4	1.2	0.8	-0.1	0.8
13	OT podium	6.2	5.2	5.0	4.5	3.4	0.8	3.7
14	OT façade	1.5	1.2	1.1	1.0	0.7	0.3	0.6
15	OT podium	2.7	2.3	2.0	1.7	1.0	0.2	1.2
16	TU Podium	4.1	3.6	3.4	3.0	2.0	0.5	2.4
17	TU façade	1.2	0.8	0.5	0.2	0.2	0.2	0.1
19	Entrance to podium	9.8	8.5	8.2	7.7	6.0	2.7	6.5
20	P podium	9.1	8.0	7.7	7.3	5.8	2.9	6.3
21	Footbridge	13.6	12.7	12.4	12.0	10.5	6.9	10.8
22	PolyU Entrance, Bridge	10.3	9.5	9.3	9.0	7.8	5.1	8.1
23	Footbridge	10.8	9.9	9.6	9.2	7.7	4.9	8.2
24	Bus stop area	14.9	13.9	13.6	13.2	11.5	7.2	11.8
25	Bus stop area	16.1	15.1	14.9	14.4	12.7	7.9	12.9
26	Bus stop area	11.9	11.1	10.9	10.5	9.3	6.5	9.6
27	Bus stop area	10.9	10.0	9.8	9.4	7.9	4.5	8.3
28	MTR Exit D bridge	14.2	13.3	13.1	12.9	11.9	9.5	12.1
29	MTR Exit D bridge	13.6	12.6	12.3	12.1	10.8	7.7	11.1
30	MTR Exit D bridge	11.7	10.8	10.6	10.3	9.0	6.4	9.4
31	Entrance to podium, around security desk	3.3	2.5	2.4	2.2	1.7	1.0	1.8

32	Hong Tai Path	2.1	1.9	1.7	1.6	1.1	0.4	1.2
33	Hong Tai Path	4.6	4.2	4.0	3.9	3.3	1.9	3.4

Table 3: Rise in noise levels after installation of green deck
*Weighted by normalized traffic noise spectrum

The highlighted check points in Table 3 are within PolyU. One can observe that there is a considerable level of noise level increase at locations on PolyU podium facing the proposed Green Deck. Overall, the presence of the Green Deck, as it currently designed, will increase the noise levels on PolyU podium by ~ 5dBA on average, which agrees with the conclusion of the empirical approach in Section 2. At location at PolyU entrance landing connecting to the footbridge (Check point #22), the noise level will increase by 8 dBA. Under the Deck, the noise level increase can be above 12 dBA. The corridor connecting PolyU and the HungHom MTR station needs careful design to shield off noise.

3. NOISE MITIGATION MEASURE PROPOSAL

To reduce the noise levels, it is proposed to add louvres and sound absorption to the Green Deck and surroundings. Louvres with 50% opening are proposed to be installed along Hong Chong Road. Conventional porous sound absorbers, like fibreglass, are not so suitable to be used in this region because of the high large particulate concentration. Micro-perforated panel absorbers are proposed as they can be cleaned if necessary and are transparent. Sound absorbers are added to the bottom of the deck and on the external wall of Hung Hom Station facing Hong Chong Road. Footbridges linking Hung Hom Station, the cavity under the Deck and PolyU are proposed to be fully enclosed so as to further reduce the noise intruding into PolyU podium level.

In the Odeon model, louvres are added along the edge of the Green Deck along Hong Chong Road from Cheong Wan Road to the deck's ending near Core Q (Figure 3). The louvers drop from the bottom of the deck to 9.8 m level. Figure 4 shows the schematics of the proposed noise mitigation measure. The MPAs are located on the inner side of the louvers along the deck. Table 4 shows the absorption coefficients of the metal louvres and MPA with 50mm air spacing adopted in the simulation.

In addition, 2-inch thick fibreglass panels are proposed to be installed as the sound absorbers under the proposed Green Deck and on Hung Hom Station external wall next to the cavity under the Green Deck. Sound absorption material that have the equivalent absorption coefficients, can be used in construction. Further, the footbridges linking PolyU, the cavity under the Green Deck and the Hung Hom station are enclosed by rigid walls in the simulation model.

Surface	Material	Sound Absorption Coefficient					
		125Hz	250Hz	500Hz	1kHz	2kHz	4kHz
Roads, outdoors	Rough concrete	0.02	0.03	0.03	0.03	0.04	0.07
Windows, Curtain wall	Glass, large panes of heavy plate glass	0.18	0.06	0.04	0.03	0.02	0.02
External wall, PolyU tiles	Marble or glazed tiles	0.01	0.01	0.01	0.01	0.02	0.02
Buildings façade	smooth painted concrete	0.01	0.01	0.02	0.02	0.02	0.05
Poly podium ceiling	smooth concrete painted or glazed	0.01	0.01	0.02	0.02	0.02	0.02
Micro-perforated panel absorbers (MPA)	Micro-perforated member mounted with 50mm air gap with attaching surface	0.00	0.05	0.15	0.50	0.60	0.40
Fibreglass, 2-inches thick	2 inches thick 48kg/m ² fibreglass blanket without backing	0.17	0.86	1.00	1.00	1.00	0.98

Table 4: Sound absorption coefficients of material surfaces in the simulation



Figure 3: Mark-up plan of green deck and vicinity

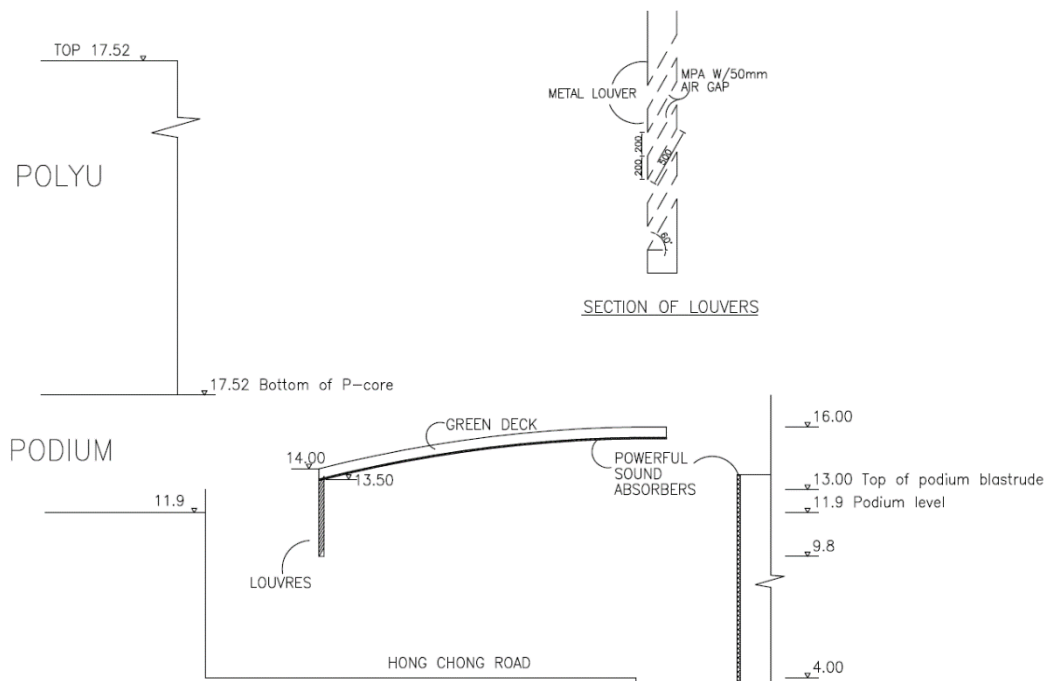

Figure 4: Schematics of the proposed noise mitigation measure

More checkpoints are added in order to understand the noise levels at higher levels of the PolyU façades and the areas near to the Hunghom MTR station and the Hong Kong Coliseum. Figure 5 illustrates all the checkpoints adopted.

With the proposed mitigation measure, the noise levels at checkpoints in PolyU are at least not worse than those **the 'no deck' condition**. **The sound absorbers under the deck are reducing the sound energy from under the deck**, resulting in a slight decrease in the noise level to all check points under the deck. At higher height, the noise reduction can be as high as 16 dBA. The noise reductions at the checkpoints nearby the Hunghom MTR station and the Hong Kong Coliseum range from 3 to 20 dBA (Figure 6).

The footbridges between Hung Hom Station Exit A and PolyU are now enclosed and thus isolated from the cavity under the Green Deck, resulting in a very impressive reduction of noise levels at those checkpoints.

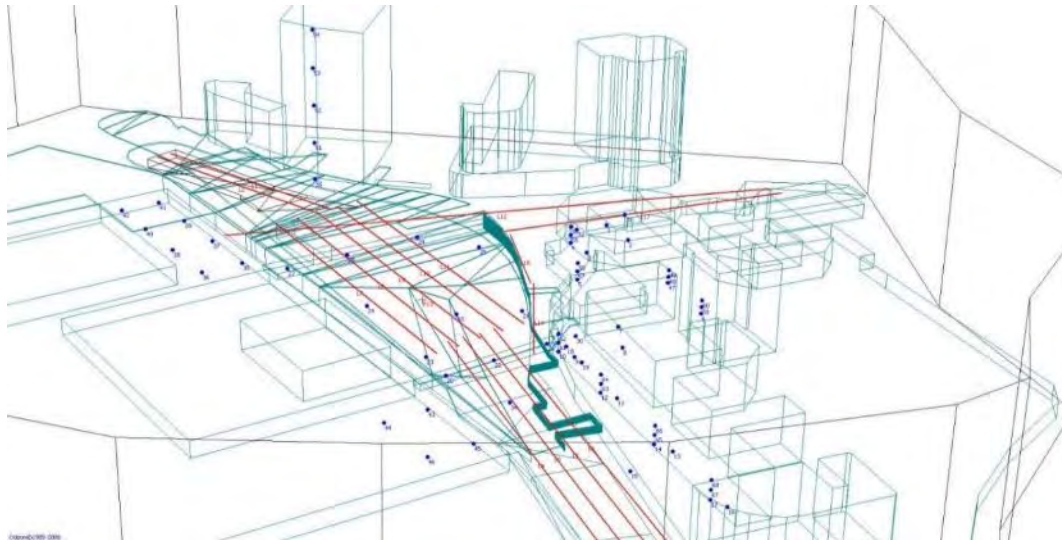

Figure 5: Additional checkpoints on PolyU façades and at open area around Hunghom station

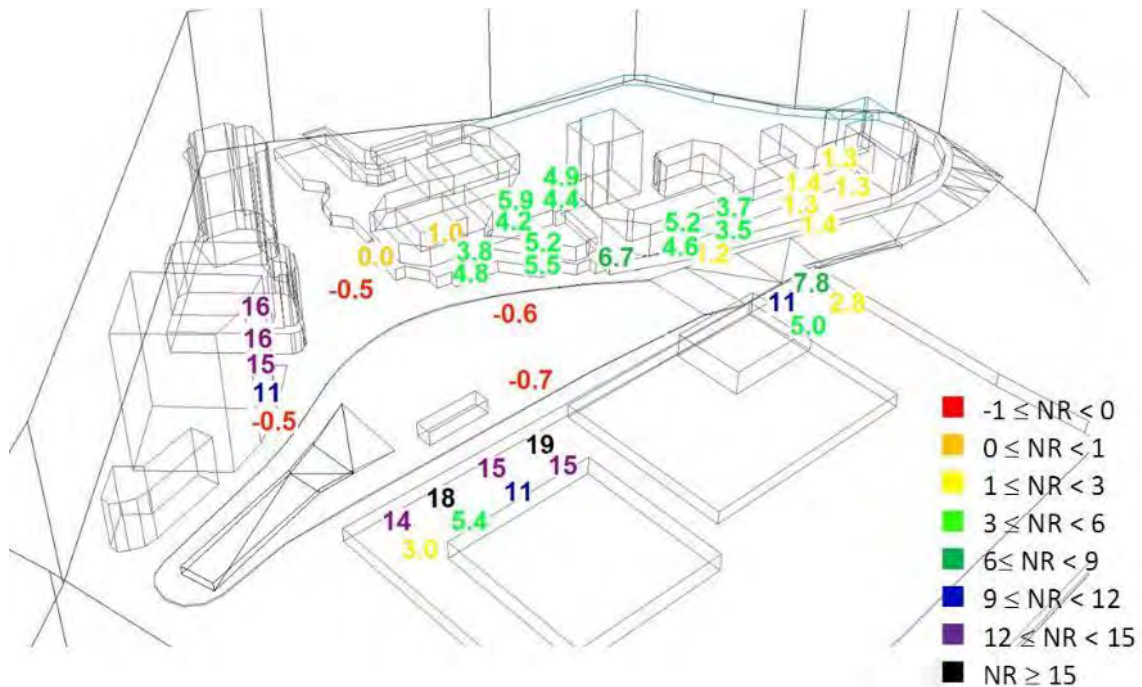

Figure 6: Traffic noise reduction (NR) after installation of the proposed measures

4. CONCLUSIONS

Noise levels at various locations on PolyU podium and entrance facing the Cross Harbour Tunnel toll gate areas are simulated using a ray-tracing algorithm. The present simulation results confirm the potential of high noise levels on PolyU podium facing the proposed Green Deck. The noise level at PolyU entrance will increase by 8 dBA, while some locations along the PQ, CD and DE cores will receive a noise level - 5 to 6 dBA above the present Figures. The noise levels underneath the deck will also be very high. A 12 dBA increase in the noise level is obtained under the deck.

It is proposed to use louvres together with micro-perforated sound absorbers and powerful sound absorbers as the noise mitigation measure. The louvres and the sound absorbers are proposed to be lined along the Green Deck's near edge (along Hong Chong Road) while the other sound absorbers are proposed to be lined beneath the deck and on the wall of Hung Hom Station (along Hong Chong Road). The noise level at PolyU entrance, which will be the worst location affected by the Green Deck in term of noise, is estimated to be ~5.4dBA higher than the current condition in the absence of the noise mitigation. However, with the proposed noise mitigation measures, the Green Deck would be able to reduce the current traffic noise level at PolyU by ~3dBA on average, while the noise levels

under the Deck remain nearly unchanged. The noise reductions at locations nearby the Hunghom MTR station and the Hong Kong Coliseum are found to be within 3 to 20 dBA.

ACKNOWLEDGMENTS

This study was supported by a grant from The Hong Kong Polytechnic University.

REFERENCES

- [1] DNL, Campus Masterplan studies of the Hong Kong Polytechnic University – Proposed Green Deck.
- [2] C.M.Harris, Handbook of Noise Control, McGraw Hill, 1979.
- [3] H.Tachibana, S.Sakamoto and A.Nakai, Scale model experiment on sound radiation from tunnel mouth. Proceedings Inter-Noise 1999.
- [4] <http://www.odeon.dk/development-room-acoustics-software>
- [5] BS EN 1793-3 Road traffic noise reducing devices – test methods for determining the acoustic performance – part 3. Normalized traffic noise spectrum (ISO 1998).
- [6] M.Garai and P.Guidorzi, “European methodology for testing the airborne sound insulation characteristics of noise barriers in situ: Experimental verification and comparison with laboratory data,” Journal of the Acoustical Society of America 108, 1054 – 1067 (2000).
- [7] Y.G.Tong and S.K.Tang, “Plenum window insertion loss in the presence of a line source – a scale model study,” Journal of the Acoustical Society of America 113, 697 – 708 (2013).

Effect of the Green Deck on Local Air Quality

LEE Shun-cheng^a, Yuan Gao^b

^a The Hong Kong Polytechnic University, Hong Kong SAR, ceslee@polyu.edu.hk

^b Chu Hai College of Higher Education, Hong Kong, belindagao@chuhai.edu.hk

ABSTRACT

During one month sampling in the Hong Kong Polytechnic University roadside monitoring station, we found that roadside air pollution is very serious which chronically affect human health; especially the people have long-term activities along the roadside. Many students and staffs of the Hong Kong Polytechnic University have to be exposed the roadside pollution because they need to walk through a crowded pedestrian bridge. The results show the gaseous pollutant, hourly average nitrogen dioxide (NO₂) concentration have ~10% of the total period of sampling time (1133 hours) exceed the proposed new local standard (200 µg/m³). From the particulate matters (PM), HK AQO proposed 100 and 75 µg/m³ as PM₁₀ and PM_{2.5} 24-hr average standard and seldom days have been reported exceed the local standard. But the Hong Kong roadside PM₁₀ and PM_{2.5} average concentration level is ~50% to 68% higher than WHO AQG (50 and 25µg/m³).

In order to evaluate the effect of green deck on local air quality, the comparison test has been conducted in roadside and PQ podium during the morning and evening peak hours. All pollutants have significantly decreased. PM₁₀ concentration has reduced around 48% and 38% in PQ podium than the value measured in roadside monitoring station in morning and evening peak hour. The OVOCs species, i.e. formaldehyde and acetaldehyde, are ~11-17% and ~27-29% reduced. Total VOCs concentration is reduced ~30% in PQ podium. The concentration of BTEX has ~30% to 60% reduction.

The risk assessment was conducted to evaluate the chronic health impact for HK PolyU staff. Formaldehyde exposure via inhalation is 1.34E-06, which was higher than acceptable criteria 1.00E-06. The other carcinogenic pollutants, i.e. acetaldehyde and benzene, exposure level were within the acceptable level.

Keywords: air pollution, risk assessment, carcinogenic compounds

1. INTRODUCTION

Air pollution at roadside is very serious in Hong Kong. Many studies have demonstrated that vehicular emission is one of the major sources of air pollutants, such as fine particulate matters (PM_{2.5}), Volatile Organic Compounds (VOCs), Oxygenated Volatile Organic Compounds (OVOCs) and Nitrogen Oxidize (NO_x). The high pollutant levels at roadside draw much public attention. Recently, The International Agency for Research on Cancer, (IARC) has defined PM_{2.5} as a carcinogenic pollutant, as PM_{2.5} contains many kinds of chemical species cause severe impact to human health. In addition, the many carbonyls pollutants are also seriously effect on human health, since it contains many carcinogenic chemicals. The heavy traffic flow in Hung Hum Cross harbor tunnel contributes large amount of pollutants and affect the people nearby. During the morning and afternoon peak hours, many PolyU students, staffs and passengers have to take much longer time to walk through the congested footbridge and hence prolong the exposure time to air pollutants. Green deck project is proposed by PolyU to build a green deck to decrease the human exposure to the air pollutants from traffic as well as to alleviate air pollution at roadside by using new material with NO_x removal ability for building green deck. Understanding on the chemical speciation and levels of pollutants are very important for the Green deck project. From previous study, we found that the annual roadside PM_{2.5} value is around 19% higher than the proposed Hong Kong PM_{2.5} standard and ~75% higher than the National Ambient Air Quality Standards (NAAQS) PM_{2.5} standard. In this study, a monitoring program will be conducted to investigate the concentrations and chemical speciation of different pollutants (VOCs, NO_x, PM and carbonyls) near the cross harbour tunnel.

2. METHODOLOGY

2.1 Site description

Roadside monitoring station

The roadside monitoring station has established by the Hong Kong Polytechnic University (HKPU) and the site is between P core and Q core ground. It is located in a street canyon in a residential and commercial area, facing Hong Chong road, leading to the busiest cross-harbour tunnel in Hong Kong. The station is about 400 m away from the tunnel entrance. Besides restaurant/household cooking, industrial or other anthropogenic sources were not found in the vicinity (photo 2.1.1). This monitoring station was used to simulate non-green deck situation.

Podium monitoring station

The site is located in HKPU campus (P core and Q core podium). Photo 2.2.1 shows the location of PQ podium monitoring site. It is a temporary site we choosing for effect of green deck on air quality estimation. The green deck will be built in the same floor of PQ podium and facing the Hong Chong road. The PQ podium is a better place for air quality effect for roadside monitoring station and green deck. The location was selected to simulate green deck scenario.



Photo 1: The roadside monitoring station



Photo 2: The podium monitoring station

2.2 Instrument description

Particulate matters and gases

The real-time PM₁₀, and PM_{2.5} monitoring data were collected by KIMOT with one hour per data. CO, NO_x, NO₂ data was collected by TSI and Thermo gas analyzer with 1 min per data.

2.3 Carcinogenic compounds analysis

Volatile organic compounds (VOCs)

Andersen Instruments Inc. Series 97-300, Ambient Volatile Organic Canister Sampler (AVOCS) will be used to collected whole air samples into pre-cleaned and pre-evacuated 2-liter SUMMA stainless steel canisters at uniform flow-rates. Sampling and analysis of the samples, e.g. GC-MSD/FID/ECD analysis, was conducted in accordance with the USEPA Method TO-14 (USEPA, 1997) with slight modifications.

Oxygenated volatile organic compounds (OVOCs)

OVOCs in air will be collected by drawing air through a cartridge impregnated with acidified 2,4-dinitrophenylhydrazine (Waters Sep-Pak DNPH-silica), which was very reactive toward carbonyls. Ozone scrubber was connected before DNPH-silica cartridge in order to prevent the interference of ozone. The sampled cartridges were plugged at both ends and placed inside of glass screw-capped vials. They were further placed into a tin can for protection during shipment and storage. The exposed cartridges were stored inside a refrigerator and returned to the Air laboratory in a cooler chilled with blue ice. The cartridges were then analyzed by extraction and HPLC

according to the U.S. EPA TO-11A method. Analysis was done by the laboratory of The Hong Kong University of Science and Technology.

2.4 Risk assessment

The risk assessment was conducted for the HKPU students, staffs and the people waiting for the buses by followed equation:

$Risk = CDI \times PF$, where CDI is Chronic Daily Intake, which is calculated via intake rate, exposure time, and human weight. PF is potency factor which could be investigated from US Environmental Protection Agency (EPA) standard.

If the value larger than 1×10^{-6} , means people surrounded suffer the health risk.

3. RESULTS AND DISCUSSION

3.1 Effect of green deck on local air quality

Particulate matters

Figure 1 shows the comparison of PM10 concentrations at non-green deck situation and green deck situation **during morning peak hours. The PM10 concentrations with green deck ranged from 40.0 to 102.8 $\mu\text{g}/\text{m}^3$ with the mean value of 57.7 $\mu\text{g}/\text{m}^3$, while the mean concentration of PM10 was 29.9 $\mu\text{g}/\text{m}^3$ with non-green deck.** It was found that there was a significant decline of PM10 concentrations with green deck situation compared to the values with non-green deck. The mean reduction rate of PM10 concentrations with green deck situation was around 48.2% during morning peak hours. The comparison of PM10 concentrations during evening peak hours gives the similar **result (Figure 2). The mean concentration of PM10 was 70.5 $\mu\text{g}/\text{m}^3$, which was ~38.3% lower than that with non-green deck situation during evening peak hours.**

Carcinogenic compounds

The Volatile Organic Compounds (VOCs) and Oxygenated Volatile Organic Compounds (OVOCs) were measured. From definition of different countries, e.g. U.S., Canada, European Union, Volatile Organic Compounds (VOCs) are organic chemicals, which have low boiling point, and high vapor pressure, which evaporates from natural sources and anthropogenic sources, e.g. painting and coating. VOCs including many different species, Oxygenated Volatile Organic Compounds (OVOCs) are the product of VOCs via photochemical reaction. The chemical characteristics of some VOCs and OVOCs are dangerous to human health and have cancer risk, which was called by carcinogenic pollutants, e.g. benzene, formaldehyde, acetaldehyde. Formaldehyde is the one of the important carcinogenic pollutants defined by the U.S. Environmental Protection Agency (EPA), the guideline of many U.S. states for ambient formaldehyde concentration should be lower than **3-30 $\mu\text{g}/\text{m}^3$ (U.S.EPA), based on** the acute or chronic exposure. U.S. Occupational Safety & Health Administration (OSHA) have defined that chronic formaldehyde intake rate should be lower than 0.2 mg/kg/day, the HKPU roadside level have almost reached this health guideline (US EPA).

Table 1 shows the concentrations of main carcinogenic compounds measured with non-green deck and green deck situation during morning and evening peak hours. It can be seen in Table 1 that the benzene, formaldehyde and acetaldehyde concentrations with green deck situation were 0.97, 7.57 and 3.18 $\mu\text{g}/\text{m}^3$, respectively, which were much lower than that with non-green deck situation where the values were 1.45, 9.10 and 4.48 $\mu\text{g}/\text{m}^3$ during morning peak hours. As shown in Figure 3.3 and Figure 3.4, the concentrations of carcinogenic compounds determined were decreased with green deck situation in both morning and evening peak hours. The reduction rates of concentrations for benzene, formaldehyde, and acetaldehyde were 33%, 16.8%, and 29.0% during morning peak hours and 33%, 11.0% and 27% during evening peak hours.

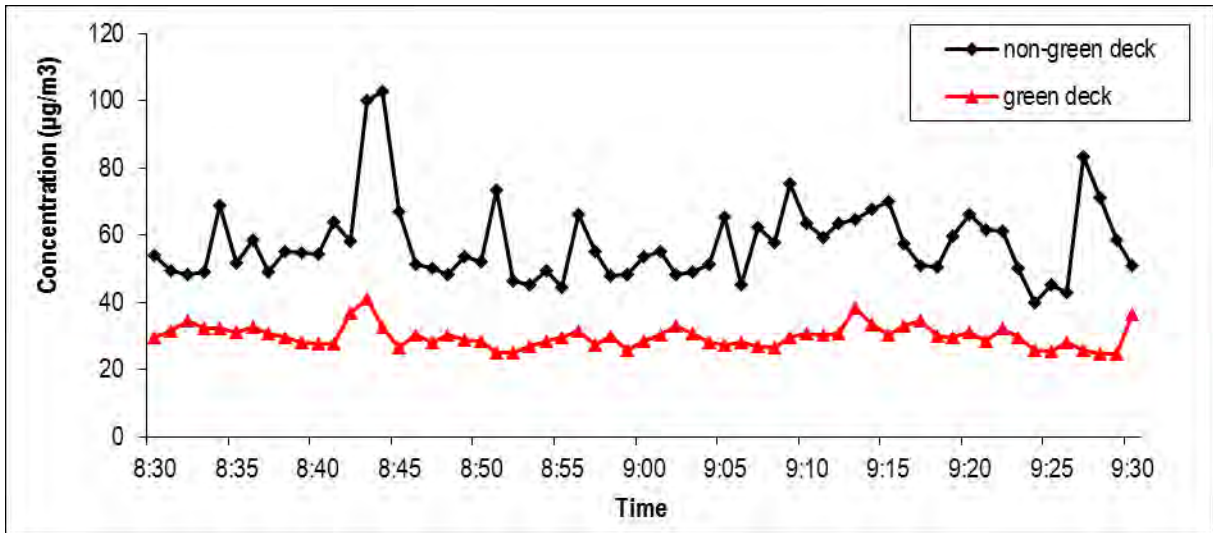

Figure 1: Comparison of PM10 concentrations with non-green deck and green deck situation during morning peak hours

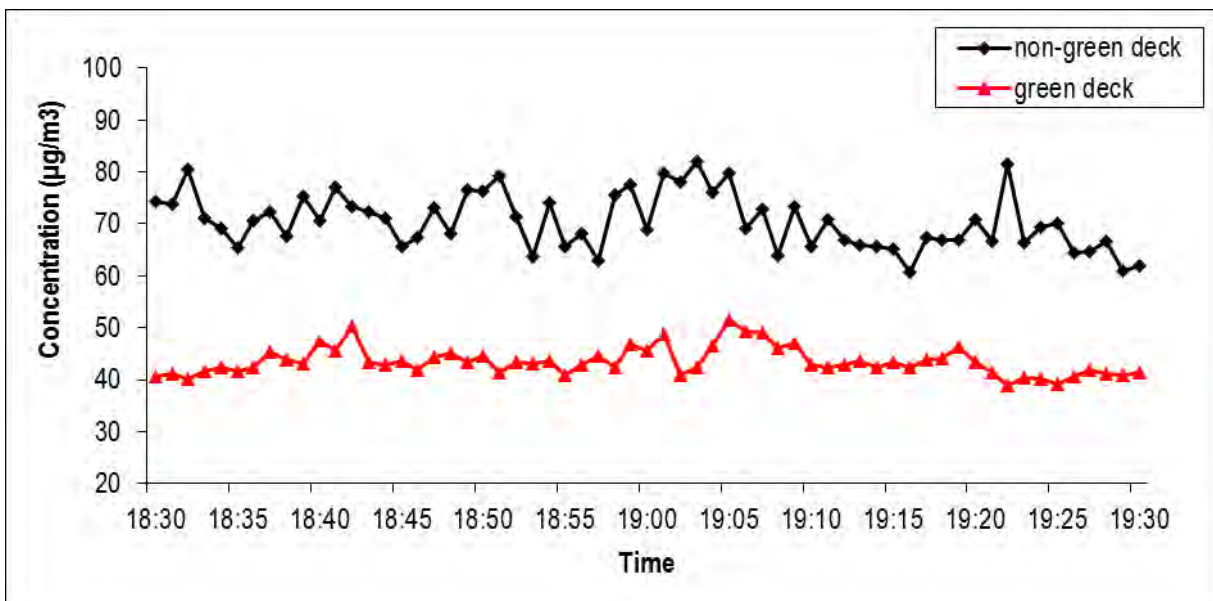

Figure 2: Comparison of PM10 concentrations with non-green deck and green deck situation during evening peak hours

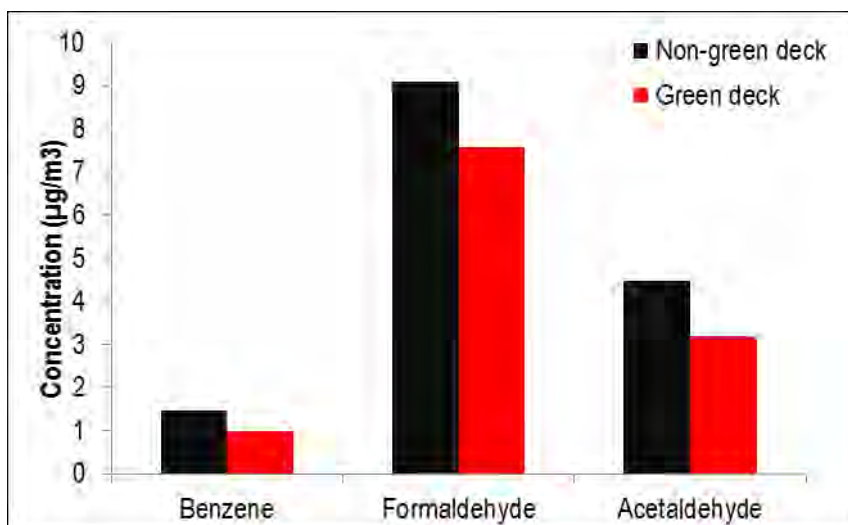

Figure 3: Comparison of concentrations of carcinogenic compounds with non-green deck and green deck situation during morning peak hours

Morning peak hours

Evening peak hours

Sampling site	Non-green deck	Green deck	Improvement	Non-green deck	Green deck	Improvement
Benzene	1.45	0.97	33%	1.65	1.11	33%
Formaldehyde	9.10	7.57	17%	9.17	8.17	11%
Acetaldehyde	4.48	3.18	29%	3.85	2.82	27%

Table 1: Comparison of concentrations of carcinogenic compounds at roadside station and podium monitoring station during morning and evening peak hours ($\mu\text{g}/\text{m}^3$)

3.2 Cancer risk calculation of carcinogenic compounds in green deck and non-green deck

From the toxicological point of view, benzene exhibits cancer risk and can cause aplastic anemia and polycythemia. According to the U.S. EPA's weight-of-evidence classification system for carcinogenicity, benzene, formaldehyde and acetaldehyde is designated as human carcinogen (Group A) with sufficient evidence of carcinogenicity in humans.

The following generic equation is used to calculate the chronic daily intake (CDI):

$$CDI = \frac{\text{Concentration (mg/m}^3\text{)} \times \text{Intake rate (m}^3\text{/day)} \times \text{Exposure (days/life)}}{\text{Body weight (kg)} \times 70(\text{yr/life)} \times 365(\text{day/yr})}$$

where the average body weight and the intake rate for adults are 70 kg and 20 m³/day as the US EPA recommends. The exposure duration is $(0.5 \text{ hr/day} \times 260 \text{ day/yr} \times 40 \text{ yr/life}) / (24 \text{ hr/day}) = 216.7 \text{ days/life}$ for bus-waiting people and HKPU staff; $(0.5 \text{ hr/day} \times 260 \text{ day/yr} \times 4 \text{ yr/life}) / (24 \text{ hr/day}) = 21.7 \text{ days/life}$ for HKPU students.

According to U.S. EPA Integrated Risk Information System (IRIS), the CPF for formaldehyde, acetaldehyde and benzene is 0.0455, 0.0077 and 0.0273 (mg/kg/day)–1, respectively.

Based on the above equations, the cancer risk for HKPU students and bust-waiting people, HKPU staff in non-green deck and green deck scenario was estimated and listed in Table 2 and Table 3. Regarding the health's risk assessment, bus-waiting people and the HKPU staff has much higher cancer risk than HKPU students, because of long exposure time. For the cancer risk of bus-waiting people and HKPU staff in Table 3 the findings revealed that the cancer risk of formaldehyde exposures via inhalation was higher than acceptable criteria of 1.00E-06. The cancer risks of benzene and acetaldehyde were within an acceptable level. It is indicated that cancer risk from formaldehyde was larger than the cancer risk from benzene and acetaldehyde. But the cancer risk in green deck and non-green deck scenario for bus-waiting people and HKPU staff is higher than U.S. EPA acceptable level. But the cancer risk with green deck situation has 30% to 70% reduction.

HKPU Students			
	Non-green deck	Green deck	Reduction
Benzene	1.96E-08	7.33E-09	-62.60%
Formaldehyde	1.34E-07	9.01E-08	-32.76%
Acetaldehyde	8.9E-09	5.93E-09	-33.37%
Cancer Risk	1.63E-07	1.03E-07	-36.39%

Table 2: Cancer risk for HKPU students

Bus-waiting people and HKPU staff			
	Non-green deck	Green deck	Reduction
Benzene	1.96E-07	7.33E-08	-62.60%
Formaldehyde	1.34E-06	9.01E-07	-32.76%
Acetaldehyde	8.90E-08	5.93E-08	-33.37%
Cancer Risk	1.63E-06	1.03E-06	-36.39%

Table 3: Cancer risk for bus-waiting people and HKPU staff

4. CONCLUSION

In order to evaluate the effect of green deck on local air quality, the comparison monitoring has been conducted in roadside and podium during the morning and evening peak hours to simulate the non-green deck and green deck scenarios. All pollutants have significantly decreased. PM10 concentration has reduced around 48% and 38% in green deck situation than the value measured with non-green deck situation in morning and evening peak hour. The carcinogenic compounds, which including benzene, formaldehyde and acetaldehyde, have 10% to 60% improvement with green deck situation. Based on the estimation, the improvement of particulate matters and carcinogenic compounds is over 30% to 60%.

The cancer risk calculation was conducted to evaluate the chronic health impact for buses-waiting people, HKPU staff and HKPU student. The results shows that bus-waiting people and the HKPU staff has much higher cancer risk than HKPU students, because of long exposure time. The cancer risks of benzene and acetaldehyde were within an acceptable level, except for formaldehyde. It is indicated that cancer risk from formaldehyde was larger than the cancer risk from benzene and acetaldehyde in the Hong Kong roadside. In addition, cancer risk of bus-waiting people and HKPU staff is higher than U.S. EPA acceptable level with two scenarios (green deck and non-green deck scenarios). But the cancer risk with green deck situation has 30% to 70% reduction. After green deck being built, the cancer risk will be decrease over 50%.

REFERENCES

- [1] Tucker SP [2002]. Formaldehyde Backup Data Report for method 2016 Issue 2, National Institute for Occupational Safety and Health, DART, Cincinnati, OH. Unpublished report for evaluation of method mainly with Supelco S10 LpDNPH samplers.
- [2] OSHA [1985]. Formaldehyde: Method 52. In: OSHA Analytical Methods Manual, Salt Lake City, UT: U.S. Department of Labor, Occupational Safety and Health Administration, OSHA Analytical Laboratory.
- [3] Lipari F, Swarin S [1982]. Determination of Formaldehyde and Other Aldehydes in Automobile Exhaust with an Improved 2,4-Dinitrophenylhydrazine Method. *J. Chromatogr.* 247: 297-306.
- [4] Dollberg DD, Smith DL, Tharr DG [1986]. Lab/Field Coordination. *Appl. Ind. Hyg.* 1:F44-F46. [10] ACGIH [2001]. 2001 Threshold Limit Values® and Biological Exposure Indices. American Conference of Governmental Industrial Hygienists, Inc., Cincinnati, OH.
- [5] ACGIH [1991]. Documentation of Threshold Limit Values and Biological Exposure Indices, Sixth ed. Formaldehyde, pp. 664-688. American Conference of Governmental Industrial Hygienists, Inc., Cincinnati, OH.
- [6] Kennedy ER, Fischbach TJ, Song R, Eller PE, Shulman SA [1995]. Guidelines for Air Sampling and Analytical Method Development and Evaluation, Cincinnati, OH: National Institute for Occupational Safety and Health. DHHS (NIOSH) Publication No. 95-117.
- [7] Waters Corp. [1994]. Waters Sep-Pak XPoSure Aldehyde Sampler Care and Use Manual, Waters Corp., Milford, MA, p. 31.
- [8] Alberta Environment 2006., assessment report for Formaldehyde for developing ambient air quality objectives.
- [9] Hong Kong Environmental Protection Department http://www.epd.gov.hk/epd/english/environmentinhk/air/air_quality_objectives/files/proposed_newAQOs_eng.pdf

Proposed Green Deck Project: A Framework for Engaging Stakeholders

Esther YUNG Hiu-kwan^a, Edwin CHAN^b, Sheila CONEJOS^c

^a The Hong Kong Polytechnic University, Hong Kong S.A.R. (China), esther.yung@polyu.edu.hk

^b The Hong Kong Polytechnic University, Hong Kong S.A.R. (China), bsedchan@polyu.edu.hk

^c The National University of Singapore, Singapore, bdgsmac@nus.edu.sg

ABSTRACT

Identifying the key actors/ stakeholders and their real interests is vital in the decision making of urban development projects. **Taking stock of stakeholders' influence in urban development projects' decision making, a Stakeholder Engagement Framework** was developed for the planning of the Green Deck project in Hong Kong where no client brief has been prepared for this public project; and was only carried through research consultancy initiatives. The aim of this research study is to involve the public right at the planning stage through engagement exercises. The paper also highlights the Stakeholder Analysis Matrix which helped in identifying the level of importance and influential power of each stakeholder so as to empower their full capacity through appropriate engagement exercises. This study sums up the role and involvement of key stakeholders as well as, community consultation as a potent tool in the decision making and strategy formulation of urban development projects.

Keywords: stakeholder engagement, green deck project, Hong Kong

1. INTRODUCTION

The successful implementation of any sustainable design project can only be achieved through a cooperative effort from government, business sectors and public sectors, so that the key sustainable design criteria from the stakeholders are incorporated into the design process as early as possible. Transparency, legitimacy, commitment, communication and meaningful involvement are the key principles of public engagement that lead to better and more legitimate decisions (Tabbush & Ambrose-Oji, 2011; Kelly et al., 2004 in Cascetta and Pagliaraa, 2013; Yang, 2014).

Yang (2014) purports that the growing number of researches conducting stakeholder analysis in urban planning clearly shows **that stakeholders have an influence in urban development projects' decision making**. Lawson and Kearns (2010) suggests that identifying the real interests of stakeholders, as well as merely identifying the key participants (Jones, 2003) is vital in the decision making of urban development projects. Therefore, stakeholder engagement is considered a viable planning decision making process for the proposed Green Deck project in Hong Kong where no client brief has been prepared for this public project; and was only carried through research consultancy initiatives.

The aim of the research study is to develop a framework for stakeholder engagement for the proposed Green Deck Project with the following objectives:

- To identify and prioritize the stakeholders to determine their level of importance and influential power regarding the project;
- To ascertain the community activities that would facilitate and encourage public engagement for the Green Deck project;
- To develop a framework for public engagement mechanisms with involvement of the different stakeholders in the early stage of a project

2. THEORETICAL FRAMEWORK OF STAKEHOLDER ENGAGEMENT

2.1 Public engagement in planning

Public participation or engagement can be defined as 'a process by which people, especially disadvantaged people, can exercise influence over policy formulation, design alternatives, investment choices, management, and monitoring of development interventions in the communities' (The World Bank, 1992: p. 2). As indicated in Table 1, Arnstein (1969) defines public participation as **"the redistribution of power that enables the have-not citizens... to be deliberately included in the future"** (Arnstein, 1969: p. 216). If policy-makers and planners seek public

participation, it is necessary, indeed axiomatic, that there would be distribution of power (Arnstein 1969). According to this view, unless citizens have a genuine opportunity to affect outcomes, participation is mainly regarded as 'therapy' and 'manipulation' of participants (Arnstein 1969).

Citizen Control	These two highest levels allow the have-nots to have major decision-making or full managerial power.	Degree of Citizen Power
Delegated Power		
Partnership	Allows the have-nots to negotiate and engage in trade-offs with traditional power holders.	Degree of Tokenism
Placation	Ground rules allow the have-nots to advise, but retain for the powerholders the continued right to decide.	
Consultation	Allow the have-nots to hear and to have a voice. However, "they lack the power to insure that their views will be heeded by the powerful".	Non-participation
Informing		
Therapy	Real objective is not to enable people to participate in planning or conducting programmes, but to enable powerholders to "educate" and "cure" the participants.	

Table 1: A ladder of citizen participation (Arnstein, 1969, 217-224)

Rio Earth Summit Agenda 21 makes it clear that participation of the community is essential for urban development to be environmentally, economically and socially sustainable (United Nations, 1992). This is supported by Tabbush & Ambrose-Oji (2011) suggesting that public engagement brings forth better decision making as it take into account **the local communities and other stakeholders' knowledge and opinions. In fact they further state that decisions** are more legitimate when it involves the concerned public.

2.2 Issues in public engagement

The success of public participation depends on the power to influence decision-making (Abbott, 1996; Arnstein, 1969, 1975). In addition, a wide range of stakeholders has emerged in recent years. Different interests, aims, and goals often arise. Conflicts also arise between and among stakeholder groups, about who knows best regarding what criteria and principles should be followed (Cotter, Boyd & Gardiner, 2001; Fowler, 1981). This largely creates the challenge in deriving consensus among the different stakeholders. Moreover, culture adds an extra dimension to the complexity of public participation in which the role of culture in establishing the identity of people and the success of urban landscapes (Zukin, 2000; Hayden 1995). Furthermore, Yung & Chan (2011) identifies the following issues in public participation related to the planning and conservation in Hong Kong. It includes different preferences between the general public and the government, inadequate knowledge for the public to evaluate planning and conservation projects, conflicts of interest from the different stakeholders, lack of effective mechanisms and supportive government framework, power disparity and propaganda and mobilization of interest groups.

2.3 Study area

The Cross Harbour Tunnel in Hong Kong is one of the most congested tunnel plaza in the world where it is used by about 120,000 vehicles per day, has adversely affects the air quality of the district. With this scenario, the Hong Kong Polytechnic University has come up with an idea to tackle this long standing problem – a green deck over cross harbor tunnel plaza. The Green Deck Project is proposed over the existing Toll Plaza and the Tunnel Portal of Hung Hom Cross Harbour Tunnel. This project will encompass the construction of a deck which stretches from the northern tip of the Hong Kong Polytechnic University (PolyU) campus to the Tsim Sha Tsui East Harbour Front. The deck will also intend to connect the podium of the PolyU campus with that of the MTR Hung Hom Station and the Coliseum. The project is envisioned to reinforce the urban renewal and be a major environmental improvement to the existing location. The Green Deck Project will provide a sustainable and green environment in the neighborhood precinct which is a scarcity for Hong Kong.

3. METHODOLOGY

3.1 On-street community survey

Aside from literature review, an on-street community survey was conducted among local pedestrians, PolyU students and staffs as well as the local residents and passers-by within the vicinity of the study area. The purpose of this stage is to identify the stakeholders involved in the public engagement process based on their level of importance, influence and determining their needs and concerns. The community survey questionnaire was developed as a tool in determining the sentiments of the identified key stakeholders who will be the users of the Green Deck Project. The survey questionnaire provides a brief background of the proposed project and has 9 questions, however, only the results of questions 7 and 8 are discussed in this paper since both are relevant in the **development of the Stakeholder Engagement Framework. Question 7 pertains to the public/ stakeholders' suggested public engagement activities while Question 8 refers to the stakeholder identification and prioritization as what the public/ stakeholders perceived.**

The on-street community survey was undertaken with the help of student helpers in three districts in Hong Kong which are directly involved in the project due to its proximity; namely Hung Hom, East Tsim Sha Tsui and Ho Man Tin. Each district has a survey station/corner manned by a team of three to four student helpers. A table and a roll-up banner showing the concept plan, photos and brief information about the Green Deck project was displayed along each survey station/corner. A laminated photo of the existing site, the proposed site development plan of the Green Deck project are supplementary information attached to the questionnaires.

3.2 Stakeholder analysis

A stakeholder analysis was conducted based on the community survey results. The stakeholder analysis is a process and an approach that aids the decision making and the strategy formulation of urban development projects (Jones, 2003; Lawson and Kearns, 2010; Yang, 2014). It is a tool used in identifying and prioritizing key actors/ stakeholders for involvement (Gupta, 1995; Jepsen and Eskerod, 2008; World Health Organization, 2015) for the successful implementation of a the project. In the stakeholder analysis process, the stakeholder identification refers to the list of stakeholders and identifying their interests regarding the urban development project; while stakeholder prioritization signifies the analysis of stakeholders' level of importance and influence on the urban development project.

4. RESULTS AND DISCUSSIONS

4.1 Personal characteristics of the key stakeholder respondents

The personal characteristics of the key stakeholder respondents in each district are presented in Table 2 & 3. Out of the 590 on-street community surveys conducted, 63.56% of the respondents are the users of the proposed project and 95.59% respondents who are local residents.

Characteristics	East Tsim Sha Tsui District	Hung Hom District	Ho Man Tin District	Total (3 Districts)
Total No. of Respondents	241 (40.85%)	180 (30.51%)	169 (28.64%)	590 (100%)

Table 2: Total number of respondents in the three district

Gender: • Male • Female	281 (47.63%) 307 (52.03%)	Sector: • Government • Community, NGO • Developer • Dev. & Const. Experts • Business • End Users (PolyU Staff and Students)	12 (2.03%) 19 (3.22%) 10 (1.69%) 4 (0.68%) 36 (6.10%) 508(86.10%)
Age: • 18 & below • 19-45 • 46-64 • 65 above	72 (12.20%) 370 (62.71%) 121 (20.51%) 27 (4.58%)	Status • Residents • Tourists	564 (95.59%) 11 (1.86%)

Education:	23 (3.90%)	No. of Visits in the proposed area:	221 (37.46%)
• Primary	191 (32.37%)	• Very rarely	142 (24.07%)
• Secondary	373 (63.22%)	• 2-3 days a week	208 (35.25%)
• Tertiary		• Everyday	

Table 3: Personal characteristics of the three districts

4.2 Stakeholder analysis matrix

A stakeholder matrix (Tabbush & Ambrose-Oji, 2011) which indicates the level of importance and influence on the decision-making process will guide the formulation of the public engagement framework. This matrix was used throughout the study to help prioritize the stakeholders based on their importance and influence as well as in determining the different engagement actions applicable to each prioritized stakeholders. As indicated in Figure 1, a public engagement action that will consistently satisfy the stakeholders classified under the 'high importance but low influence' axis can be developed while another public engagement action the will engage closely and actively the stakeholders distinguished under the 'high importance and high influence' axis. In addition, a public engagement action that will provide continuous information to stakeholders under the 'low importance but high influence' axis while another public engagement activity that may monitor the stakeholders under the 'low importance and low influence' axis.

A. HIGH IMPORTANCE. LOW INFLUENCE KEEP SATISFIED	B. HIGH IMPORTANCE. HIGH INFLUENCE ENGAGE CLOSELY AND INFLUENCE ACTIVELY
C. LOW IMPORTANCE. LOW INFLUENCE MONITOR with MINIMUM EFFORT	D. LOW IMPORTANCE. HIGH INFLUENCE KEEP INFORMED

Figure 1: Stakeholder matrix (Tabbush & Ambrose-Oji, 2011)

4.3 Identification of stakeholders

Stakeholders in urban development are individuals or organisations who can affect or be affected by the achievement of a project. Analysing stakeholders is an indispensable process for urban development. Although various methods have been used in theory and practice for stakeholder analysis, the main aims are to identify stakeholders and their interests, prioritise these stakeholders, and subsequently, make appropriate decisions. The identified list of stakeholders are:

- Government Sector- the different departments such as the Planning Department, Building Department, Transport Department, Lands Department and Environmental Protection Department, etc.
- Community- the NGOs (e.g. Friends of the Earth, Designing Hong Kong, etc.), district councillors, and other concern groups (religious, and social groups, conservationists, etc.).
- Development and construction experts- the Architects, Planners, Contractors, Developers and other allied professionals.
- Developers
- The End Users –the PolyU staff and students, TST and East TST passersby, commuters, residents, visitors, workers, etc.
- Business Sector- the retails and restaurants owners and tenants, financial groups, etc.

4.4 Prioritization of stakeholders

Based on the community survey's stakeholder analysis matrix as shown in Figure 2, the government sector is still considered by the respondents as the sector with the 'highest importance and highest influence'. The development and construction experts as well as the developers came next as the second and third sectors which also have 'high importance and high influence'. These two sectors have moved its level from the 'low importance but high influence' in the previous survey to the 'high importance and high influence' matrix grid. Another sector which retained its 'high importance yet low influence' status is the end users.

Noteworthy also is the community sector which was identified as the sector with 'low importance but high influence' from the previous survey, has gone up to the 'high importance and low influence' level together with the end users. Lastly, the sector which was considered with 'low importance and low influence' in the previous survey are now identified by the key stakeholders as a sector with 'high importance but low influence' and joined the ranks of the end users and community sectors. With these results, appropriate public engagement strategies can be provided to the sectors under the two levels such as the 'high importance but low influence' (i.e. the User and Community, and Business sectors) and the 'high importance and high influence' levels.

The sectors with 'high importance and high influence' must be engaged closely and actively in the planning and implementation of the proposed project. While the User and Community, and Business sectors with 'high importance yet low influence' must not only be kept satisfied in terms of providing public engagement activities regarding the proposed project, but should also be capitalized through public participation to increase their influence to move the project forward.

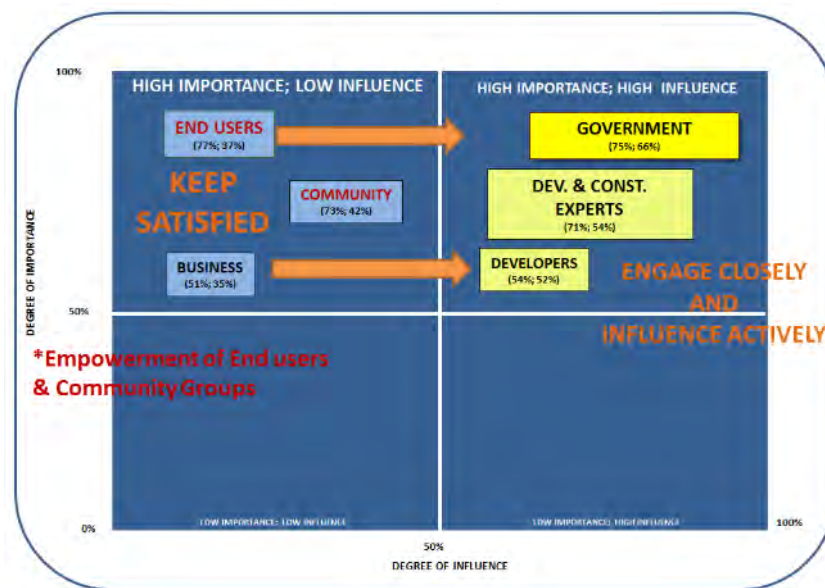

Figure 2: Stakeholder matrix analysis

4.5 Suggested community and experts participation activities

As shown in Figure 5, all sectors and stakeholders have identified unanimously the public engagement activities which are grouped in A, B, C and D. Group A is intended to inform and notify the stakeholders about information regarding the project. In Group B, the stakeholders are encouraged to attend the activities relating to the project. While with Groups C and D, they are more active consultation and involvement opportunity for the stakeholders. While the public engagement activities that are grouped in B and C were agreed by the six sectors except for the **Developers & Construction Experts** which they didn't have a say on these activities. The public engagement activities were grouped according to the level of engagement from passive to active engagements. Nevertheless, all these public engagement activities are the top five public engagement activities identified by the sectors to be important to consider for the implementation of the Green Deck project.

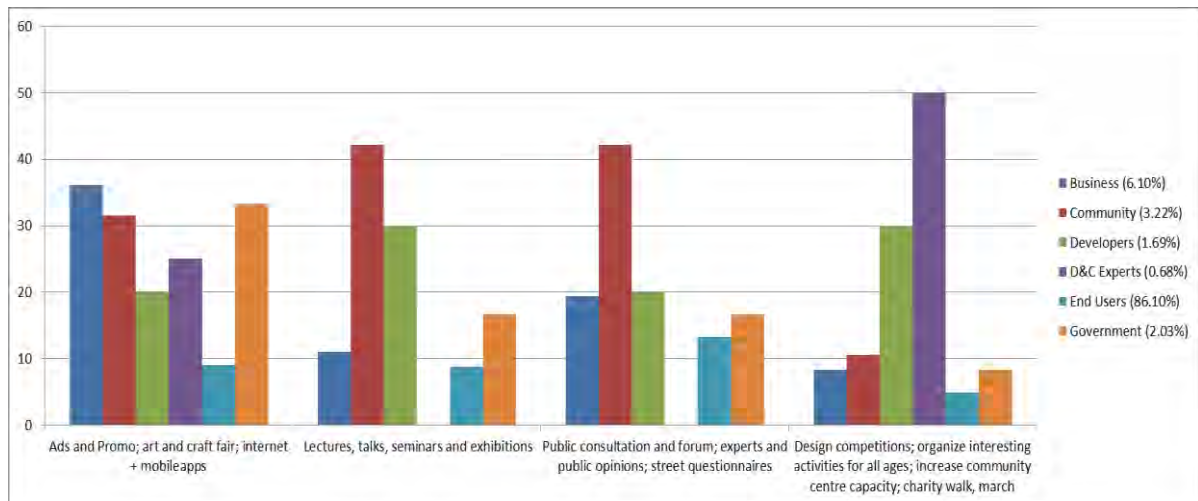

Figure 3: Top five suggested community and experts participation activities

5. CONCLUSION

This paper presented the need for stakeholder engagement, highlights the stakeholder analysis and the various strategies for engaging stakeholders as specified in the stakeholder Engagement Framework. This research implicates the development of a framework that engaged stakeholders of the proposed Green Deck project which can be applied to strengthen and promote the ties of key stakeholders for the betterment of the project. The relevance of stakeholder engagement in the urban development process has a major influence on the project outcome in terms of plans, ideas and future directions. This study also sums up the role and involvement of key stakeholders as well as, community consultation as a potent tool in the decision making and strategy formulation of urban development projects. Furthermore, the study also raises the importance of empowerment of end users and community groups. Further research is needed to identify the ways to empower certain stakeholder groups. Lastly, the principles of transparency, legitimacy, commitment, honesty, communication, meaningful involvement and respect in all interactions can be applied for the successful implementation of urban development projects that are basically rooted from the people, for the people and by the people.

REFERENCES

- [1] ABBOT, J. 1996. Sharing the city: Community participation in urban management, London: Earthscan Publications.
- [2] ARNSTEIN, S. R. 1969. Ladder of citizen participation. Journal of American Institute of Planners, 35,216-224.
- [3] ARNSTEIN, S. R. 1975. Public participation in technology assessment – working model for public participation. Public Administration Review, 35, 70-73.
- [4] BARTHOLOMEW, P. & FREEMAN, R. 2010. Levels of learner voice participation. In RUDD, T., COLLIGAN, F. & NAIK, R. (eds.) Learner Voice: a handbook from Future lab. Bristol: Future lab.
- [5] CASCETTAA, E. & PAGLIARAA, F. 2013. Public engagement for planning and designing transportation systems. Procedia - Social and Behavioral Sciences, 87, 103-116.
- [6] COTTER, M., BOYD, B. & GARDINER, J. 2001. Heritage landscapes: Understanding place and communities, Lismore, Southern Cross University Press.
- [7] FOWLER, P. J. 1981. Archaeology, the public, and the sense of the past. In: BINNEY, M. & LOWENTHAL, D. (eds.) Our past before us. London: Temple Smith.
- [8] GUPTA, A. 1995. A stakeholder analysis approach for inter-organizational systems. Industrial Management & Data Systems, 95 (6), 3-7.
- [9] HAYDEN, D. 1995. The power of place, Cambridge, MA, The M.I.T. Press.
- [10] [HONG KONG COUNCIL OF SOCIAL SERVICE. 2012. Social Indicators of Hong Kong: Per capita area of public open space (sq. meters). From http://www.socialindicators.org.hk/en/indicators/environmental_quality/23.13 Retrieved June 14, 2014
- [11] JEPSEN, A.L. & Eskerod, P. 2008. Stakeholder analysis in projects: challenges in using current guidelines in the real world. International Journal of Project Management 4 (2), 1-9.

- [12] JONES, P.S. 2003. Urban regeneration's poisoned chalice: is there an impasse in (community) participation-based policy? *Urban Studies*, 40 (3), 581–601.
- [13] **LAWSON, L & KEARNS, A. 2010. Community empowerment' in the context of the Glasgow housing stock transfer.** *Urban Studies*, 47 (7), 1459–1478.
- [14] TABBUSH, P. & AMBROSE-OJI, B. 2011. Principles of Public Engagement. Forest Research <http://www.forestresearch.gov.uk/peopleandtrees>. Retrieved June, 2014, from
- [15] UNITED NATIONS 1992. AGENDA 21. United Nations Conference on Environment & Development. Rio de Janeiro, Brazil: UN.
- [16] WORLD BANK 1992. Participatory development and the World Bank: Potential directions for change. Washington, DC: The World Bank.
- [17] WORLD HEALTH ORGANIZATION. 2015. Retrieved March, 2015, from <http://www.who.int/hac/techguidance/.../stakeholder%20analysis%20ppt.pdf>
- [18] YANG, R.J. 2014. An investigation of stakeholder analysis in urban development projects: Empirical or rationalistic perspectives. *International Journal of Project Management*, 32 (5), 838–849.
- [19] YUNG, E. H. K. & CHAN, E. H. W. 2011. Problem issues of public participation i built-heritage conservation: Two controversial cases in Hong Kong. *Habitat International*, 35, 457-466.
- [20] ZUKIN, S. 2000. Whose culture? Whose city? In: LE GATES, R. T. & STOUT, F. (eds.) *The city reader*. London; New York: Routledge.

“Smart Green Resilient” Integrative Urban Environment

Wilfred LAU^a

^a Arup, Hong Kong SAR,

ABSTRACT

A high density city like Hong Kong relies on a complex web of systems and services to sustain and thrive. Whilst the proposed Green Deck is an exemplar of integrating infrastructure system with a pleasant urban environment, yet contemporary systems thinking is bereft of a converging mechanism to deal with land use, urban design, mobility and infrastructure in a holistic manner. SGR (Smart Green Resilient) offers one such approach, providing the necessary direction to synchronize multiple urban development aims into a wide-ranging yet integrated **objective to meet the challenges of the “new normal”**. **This talk will discuss integrative urban environment to illustrate the innovative Smart Green Resilient philosophy which was developed from extensive participation in East Asia’s urbanization, serving as a conceptual framework to future proofing our city.**

vi. Paper Sessions

Track 1: Smart Initiatives & Advanced Building Systems

Session 1.3 Advanced Building Elements

Filter Façade

Ferdinand OSWALD^a

^a Institute of Architecture Technology, Graz University of Technology, Austria, ferdinand.oswald@at.tugraz.at

ABSTRACT

The Filter Façade has the goal of reducing air conditioner split units usage in buildings by increase the comfort of interiors of residential high rises in subtropical climate regions with natural ventilation. It describes how to Optimize Building Renovation of Residential High Rise in Subtropical Region by modifying existing building structure to optimize natural ventilation.

Keywords: optimized building renovation of residential high rise in subtropical region

1. INTRODUCTION

Over recent decades, residents living in modern residential buildings in tropical metropolises are increasingly using split-system air conditioners. The use and energy consumption of such systems in those regions are enormous, and especially the latter is a serious disadvantage in operating air conditioning systems. It is assumed that the additional energy consumption of seven-million metropolis Hong Kong alone will rise to 6.8 GWh per annum due to the use of ventilation systems. The South Eastern Chinese coastal region with its 150 million inhabitants requires an energy quantity of 145 GWh per year to cool their apartments with air conditioners. At the same time, these split-system air conditioners continue to heat up the urban environment with their warm exhaust air, discharging 40% of required cooling energy in the form of heat into the ambient air, thus also exacerbating negative effects of the urban heat island. According to statistical calculations, the worldwide urban population will almost double by 2050, increasing from 3.5 billion to 6.3 billion. Subsequently, energy required for cooling will almost double by 2050 as well. Given that the urban population cannot do without air conditioning, this forecasted growth is bound to pose a huge challenge to energy production and the carbon footprint. For future conurbations in sub-tropical regions, therefore, it will be of crucial importance to seek specific solutions for problems such as overburdened energy grids and local climate change. Reducing the use of split-system air conditioners is an urgent issue. It seems possible to increase comfort and reduce mechanical ventilation at the same time with the help of specifically natural ventilation systems for residential housing in tropical regions. Results from specific research projects and scientific measurement furthermore produced evidence that specific natural cross ventilation can optimize human behaviour for periods of up to 85 % of the year (e.g. Hong Kong) see Figure 1

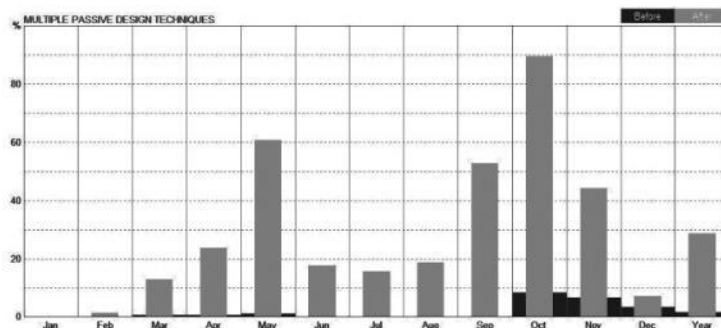

Figure 1: Percentage of comfort throughout the year and per month achieved through natural ventilation in Hong Kong, data from psychrometric chart

2. OPTIMIZED MODIFYING OF EXISTING HIGH RISERS

The floor plans of most residential high rises in tropical and sub-tropical regions do not allow for cross ventilation. This problem is demonstrated for the example of the Tung Lam residential high rise of the frequently used HARMONY type in Figure 2. Ventilation of the flats is possible through façade openings only but even the wind catchers (vertically disposed wind swords with an angle of 45° to the front end wall) do not work as expected. Cross ventilation across the corridors is impossible with this type of building, since walls of the flats confine the corridors on both sides. This results in blocking of the air flow at the access corridor.

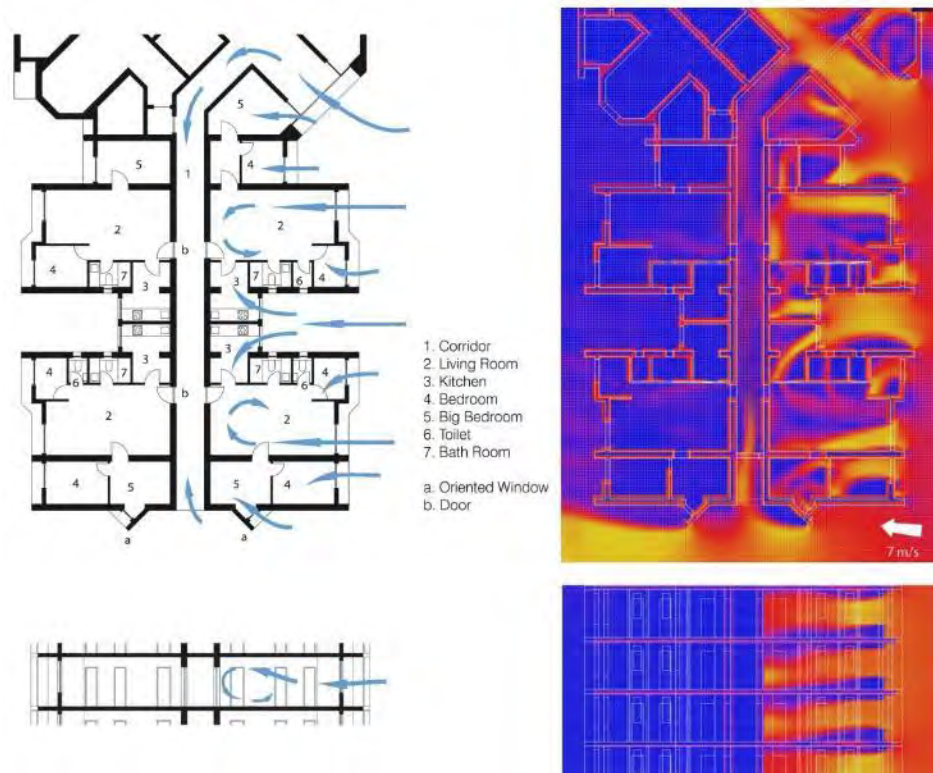

Figure 2: Study of the air flow with the floor plan section of the HARMONY type Tung Lam residential high rise in Hong Kong. Sketch of the air flow and Computational flow simulation with colour coding of speeds: low – medium – high velocities in blue – red – yellow. Simulation software VASARI.

Left: floor plan, top: vertical cross section

2.1 Modification

In a first step it was concluded that openings from the flats towards the access corridor will be a remedy. Possible openings can be the entry doors of the units but also additional skylight windows near the roof of the flats, favourably with adjustable cross section. Such configurations have proven to be effective in other buildings (e.g. Urban Tulou). Furthermore, the ineffective wind catchers were replaced by conventional bay windows with openable side wings. The most important measure was a change of the floor plan by an additional channel across the access corridor between the living units. For this purpose, the adjacent rooms in each unit must be slightly downsized. These modifications will allow cross ventilation from the façade openings to the windward units, and via the access corridor towards the leeward flats. All modifications are illustrated in the following Figure 3.



Figure 3: Modified Building: Study of the modified building structure of the HARMONY type Tung Lam residential high rise in Hong Kong,

However, with this configuration the addressed problem will appear: air from the windward apartments enters the corridor and then, instead of leaving through the openings of corridors, penetrates the apartments opposing the corridor (Figure 4). This would transfer potential contaminants from the windward apartments to the leeward apartments.

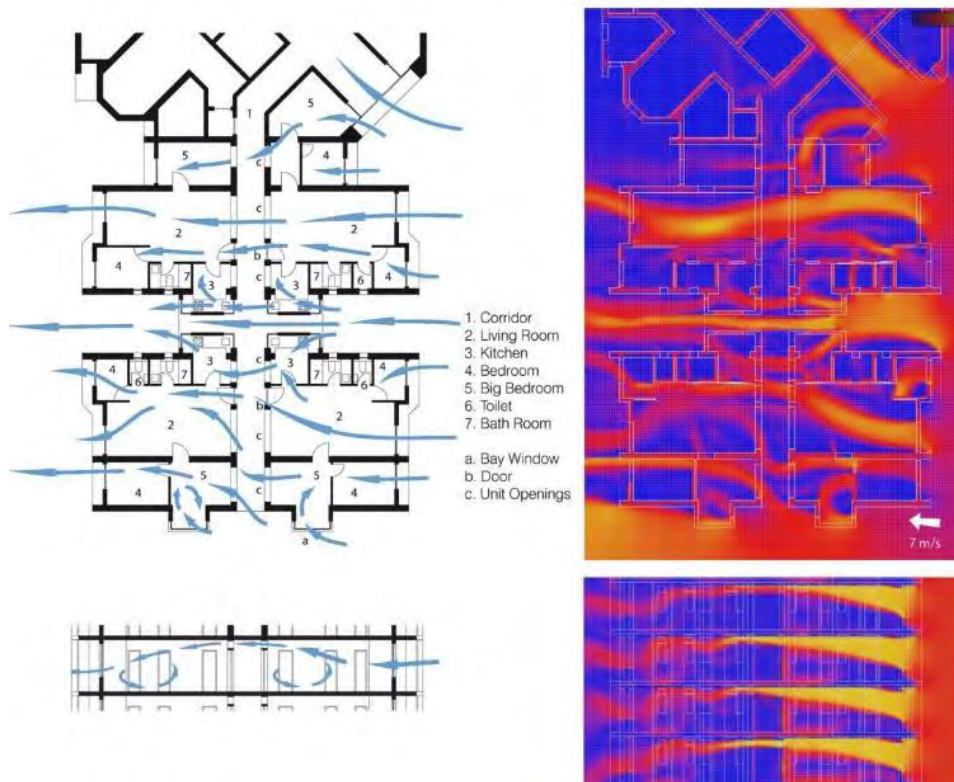

Figure 4: Modified Building: Study of the air flow with the floor plan section of the HARMONY type Tung Lam residential high rise. Left: lines of the air flow in the floor plan. Right: Computational simulation of the air flow with colour coding of wind speeds: low – medium – high velocities in blue – red – yellow. Simulation software VASARI.

In order to counteract this unpleasant behaviour the following concept optimization was developed.

2.2 Concept optimization

The openings of the windward apartments to the corridor are closed while the openings of the opposing apartments remain open. As can be seen in Figure 5, the simulation indicates that the flow field is strongly affected by this relatively simple modification. The ventilation of the windward apartments is ensured by inflow through the **windward façade and suction from rooms adjacent to the additional “channel” between the apartments.** Corner ventilation via the bay window with openable lateral wings supports the ventilation of the windward front-end unit.

The altered flow conditions provide enough airflow towards the corridor. Therefore, the leeward apartments are well ventilated by inflow through the corridor openings while the outflow is forced through the side windows adjacent to the “channel”.

This concept will be evaluated with CFD and wind tunnel experiments in a proposed research project “Optimized Natural Ventilation”. VASARI was used to show up the conceptual idea of the proposed study. This tool or its follow-up product may be used for the following project in a preliminary manner to get a first impression.

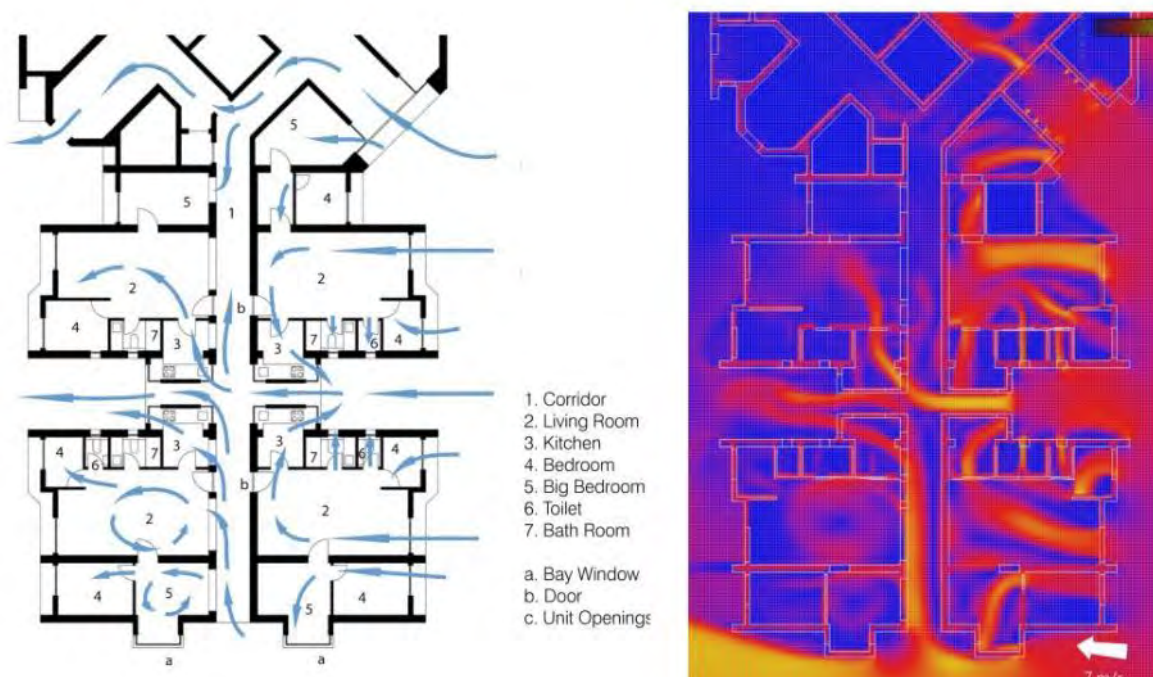

Figure 5: Optimized Modified Building: Study of the air flow with the floor plan of the HARMONY type Tung Lam residential high rise. Left: lines of the air flow in the floor plan. Right: Computational simulation of the air flow with colour coding of wind speeds: low – medium – high velocities in blue – red – yellow. Simulation software VASARI.

3. PROJECT OPTIMIZED NATURAL VENTILATION

The aims of the research project “Optimized Natural Ventilation” are to promote conceptual and methodological principles in developing architectural concepts to guarantee increased comfort by means of natural ventilation in residential buildings, not just in tropical and sub-tropical regions. The project will deliver underlying basic information enabling the development of specific openings for large cities. In addition, criteria accounting for problems such as air pollution and noise load will also be fulfilled. The project aims to identify optimum airflow dynamics and the highest possible air change rate (ACH) with account for urban environment, floor plan and façade of a residential building. Concepts will be assessed and results compared with wind tunnel experiments and computational fluid dynamics, thus establishing the best combinatorial models. The hypothesis is that there exist optimized conditions for natural ventilation for residential rooms accounting for the urban building arrangement, floor plan configuration and façade openings.

Hong Kong is regarded as a vanguard of innovative implementations in residential housing throughout continental China, providing widespread basic knowledge and innovative developments to other Chinese metropolises. The derived results will be applied on-site on a 1:1 scale mock-up in realistic conditions, as well as tested and compared

to the elaborated basics by measurements. Implementation will be realised in the course of cooperation`s between European and Asian institutions.

A further step will be to apply the results from this project to future research activities. A strategy for commercial exploitation of the project results will be an cooperation with OEMs of window and filter systems. Those companies have the aim and possibilities to develop and certify the opening systems for the markets in Asia and Europe.

REFERENCES

- [1] **Siwei Lang: “Progress in energy-efficiency standards for residential buildings in China”, in: Energy and Buildings 36/12 (2004), pp. 1191–1196.**
- [2] Population development in cities 2050. Source: McKinsey 2013.
- [3] Office of Dissemination, China Statistics Press, National Bureau of Statistics of China, China Statistical Yearbook 2011, Beijing 2012, pp. 93.
- [4] **Wang L.: „ Applying Natural Ventilation for Thermal Comfort in Residential Buildings in Singapore “, in: Architecture Science Review Volume 50.3 (2007), pp. 224-233.**
- [5] Weather Tool 2001, © Autodesk, Inc. 2010; Weather data Download, U.S. Department of Energy, report on the data (STAT) and ASHRAE Design Conditions Design Day Data file (DDY).
- [6] Research Project in Cooperation with the Hong Kong Housing Authority © Ferdinand Oswald, Institute of Architecture Technology, TU Graz, Austria 2013.
- [7] Oswald, F., Reduce A/C - Reducing the utilisation of air conditioning in high-rise buildings in subtropical and tropical climate regions, 2015, Graz, Austria, (p 681) p. 548-568.

The Impact of Double Skin Façade on the Energy Consumption of Office Buildings under the Tropical Brazilian Climate

Sabrina Andrade BARBOSA^a, Kenneth IP^b

^a University of Brighton, United Kingdom, s.andradebarbosa@gmail.com

^b University of Brighton, United Kingdom, k.ip@brighton.ac.uk

ABSTRACT

Double skin façade (DSF) is an attractive architectural element in modern office buildings that, while giving a transparent appearance to buildings, can potentially be able to moderate the indoor thermal conditions and reduce energy demands. Developments in warmer climate countries such as Brazil are beginning to consider the application of DSF technology as a solution to improve thermal and energy performance in their buildings. Building upon the experience of a comprehensive research programme on the study of the thermal performance of office buildings with DSF, from which key design parameters affecting the thermal behaviour of DSF have been identified and evaluated, this study aims to examine the impact on energy consumptions. Using an office building model with an optimised DSF, this study assesses the energy consumptions when the building is fully air conditioned or operated under a mixed mode ventilation strategy. Models with similar characteristics but with single skin façade are also studied for comparison. Computational models developed for this study are evaluated using the dynamic simulation program IESVE which integrates building fabric thermal behaviour and environmental systems operating under the climatic conditions of the Brazilian city Rio de Janeiro. The results indicate that natural ventilation can provide the necessary thermal comfort in over 34% of the year in the building model with DSF under mixed mode ventilation strategy, that can potentially reduce 21% of annual cooling energy when compared to the fully air conditioned model. However, energy savings due to the addition of DSF alone are relatively small - 15% in full air conditioned model and 6% in mixed mode ventilation model. The benefit to thermal energy consumption is therefore marginal. However, comprehensive whole life evaluation is needed to provide a holistic assessment when other beneficial contributors, such as lighting, smart glazing and integrated PV are taken into consideration.

Keywords: double skin façade, tropical climate, building energy simulation

15. INTRODUCTION

Increasing environmental awareness and the need to reduce the energy consumption have encouraged researchers to focus on more efficient building envelopes. In this context, there is a growing interest in double skin facade (DSF) as a potential passive system to reduce energy consumption with the attraction of its modern **transparent envelope. Although benefits such as ‘energy consumption reduction’, ‘increased ventilation and thermal comfort’, and ‘visual and aesthetic quality enhancement’ are reported in the literature, there is still little knowledge and experience available about the DSF’s operation, especially during hot seasons and under hot climates** (Ghaffarianhoseini et al., 2016). Moreover, majority of the existing studies have focused on the DSF cavity **as an ‘isolated’ structure, which is often treated as a local feature without taking into account its thermal interaction** with the user space (Barbosa and Ip, 2014).

DSF consists of an additional external skin, usually made of glass, applied external to the conventional building façade so forming an air cavity between the two layers. Although DSF was developed as an effective enhancement to traditional façades for colder climates, its application has been reported as a potential technology for reducing cooling loads in hot climates such as in China (Zhang et al., 2010), Spain (Torres et al., 2007), Singapore (Chou et al., 2009), United Arab Emirates (Radhi et al., 2013) and Malaysia (Rahmani et al., 2012). Overcoming climatic variations has instigated recent investigations of additional features such as sun protection devices, modification of façade geometry, adaptive ventilation schemes and integration of photovoltaic systems (Agathokleous and Kalogirou, 2016).

Previous comprehensive research on the thermal performance of office buildings with DSF for tropical climate conditions (Barbosa and Ip, 2014; Barbosa et al., 2015a; b, Barbosa and Ip, 2016) has investigated the influences of architectural configurations and climatic conditions on the thermal performance of buildings with DSF and predicted the annual thermal acceptance levels of optimized naturally ventilated models with DSF under Brazilian climate conditions. Building upon these outcomes, this paper extends the study to incorporating mechanical

ventilation. Using a building model under the climate of Rio de Janeiro, this study investigates the impact to the energy consumptions of using full air conditioning or mixed mode ventilation when applied to the cases with or without DSF.

1.1 DSF operation and energy consumption

The DSF can be considered as a type of thermal chimney that can promote natural ventilation in the building due to solar induced thermal buoyancy and pressure variations that resulted from the effects of wind around the building. The stack effect that occurs within the DSF is driven by the temperature difference between the warmer cavity air and the outside cooler air (Gratia and De Herde, 2007a; Kim and Sohn, 2009). The difference in temperatures is not only related to the model configurations - such as glazing type and area, presence of shading devices within the cavity and its materials - but also significantly to the level of solar radiation incident on the outer layer of the DSF.

Another important parameter that contributes to the resulting air movement within a naturally ventilated building is the wind effect. When wind approaches a building, it creates a distribution of static pressures on its exterior surface, the magnitude of which depends on the wind direction, wind speed, air density and surrounding obstructions (ASHRAE, 2009).

In naturally ventilated buildings with DSF, fresh cooler outdoor air is normally drawn through openings from the opposite façade, which passes through the user space before being extracted into the DSF cavity. In air conditioned buildings, the windows are sealed. Use of DSF can reduce the cooling load by reducing the direct solar gain and buoyancy driven air movement in the cavity continuously removes the heat trapped within it (Chan et al., 2009).

Different architectural configurations have been tested to determine the reductions in energy demands of buildings with DSF, such as cavity depth (Rahmani et al., 2012), application of different materials properties on the façade layers (Chan et al. 2009, Mingotti et al., 2013), position and angle of shading devices (Gratia and De Herde, 2007b) and opening size (Chou et al., 2009). Recent review of studies on the performance of DSFs, mainly based on temperate climates, has concluded that the technology can potentially reduce the air conditioning consumption up to 50% when compared to conventional facades, as such DSF has been recognised potentially as an effective option for reducing the energy use in buildings (Sanchez et al, 2016).

2. METHODOLOGY

1.1 Models description

In this study, an optimized DSF base case model has been developed based on the outcomes of previous research on the performance of the DSF under tropical climate conditions. Its consists of an 11 storey open plan office building with dimensions of 12m x 16m and 3.5m floor-to-floor height. A fixed clear glass vertical DSF cavity was applied to the north face forming an air cavity of 1m.

The model considered the design parameters that maximize the annual acceptable comfort levels in the occupied space (Barbosa et al., 2015a) such as closure of the cavity bottom and its extension 3.5m above the roof of the building to avoid poor ventilation on the top floors. North windows, placed at the top of the walls, were sized to achieve similar flow rates across all floors levels. South windows, positioned at the bottom of the walls, were fully open. A concrete shading device was positioned within the cavity and a white masonry wall was used on the inner layer of the DSF. The longest sides, facing north/ south orientations, were modelled with horizontal windows sized to achieve balanced flow rates across all floors and air buoyancy force is enhanced by concrete shading device within the cavity. The model also considered the influence of the surrounding environmental conditions on the thermal performance of the DSF of a naturally ventilated building such as orientation and predominant wind (Barbosa et al., 2015b). Building upon the base case model, four case study models have been established, which consider the use of full air conditioning or mixed mode ventilation with single skin façade (SSF) or DSF, as illustrated in Figure 1.



Figure 1: Section of models used on the simulations

For the models 1 and 2 with DSF, a clear single glazing outer layer was applied to the north face forming an air cavity of 100 cm extending 3.5 m above the roof. The cases with SSF were modelled with an external concrete shading device. Table 1 shows the building model fabric material properties and the description of internal heat gains applied during the office hours for the whole year. Full internal gains were applied from 8 a.m. to 12 a.m. and from 1 p.m. to 5 p.m. and half capacity was considered for one hour during the lunch time, before and after working hours.

Building envelope	U value
Roof	0.18 W/ m ² K
Ground floor	0.28 W/ m ² K
Opaque part of façade (Thickness = 0.27m)	0.61 W/ m ² K
Window (12mm clear single glass)	3.9 W/ m ² K
Double skin	
Clear single glass (shading factor = 0.87)	5.04 W/ m ² K
Shading device (Absorptance = 0.14)	
Use of the building	Total gain
Internal heat gains (People + Equipment + Lighting)	36.9 W/ m ²

Table 1: Building model fabric materials characterisation and description of internal heat gains

Inter-program comparison technique was used in this study as a viable means to validate the physical phenomena involved in the dynamic thermal behaviour of the DSF. Simulation models with similar geometry and fabric materials as well as internal heat gains and external boundary conditions, within the range of the operating parameters, were created and applied to another proprietary industry accepted CFD software Flovent (Mentor, 2014). Results of a **series of 'snapshot' steady state quantitative outcomes and airflow profiles across the floors of the** base case model were generated and compared to those obtained from the IESVE software, which showed close agreements. In the absence of a fully validated dynamic CFD simulation tool for a whole building, these consistent quasi-dynamic results were deemed to provide adequate evidence of confidence for the purpose of this preliminary study.

1.2 Modelling process and simulation analysis

The building's dynamic behaviour in conjunction with the prescribed ventilation strategies were simulated using the integrated simulation software IESVE (2016). The tropical climate of Rio de Janeiro city (latitude 22.9° S, longitude 43° W) was selected for this study. The climate diagnosis through the psychrometric analysis (Schuch and Ono, 2010) indicated that the city was uncomfortable for 64% of the year, mainly due to the occurrence of high temperatures and relative humidity with annual averages of 27°C and 80%, respectively. In terms of wind speed, the city experiences lower than 4m/ s for 81% of the year.

Both DSF and SSF have been considered to highlight the benefits and constraints of the application of the second facade layer on the building. Fan coil air conditioning system has been implemented during the working hours. When air conditioning is used, the windows are fully closed and no natural ventilation is allowed. Mixed mode ventilation with operation strategy based on comfort criteria has also been studied.

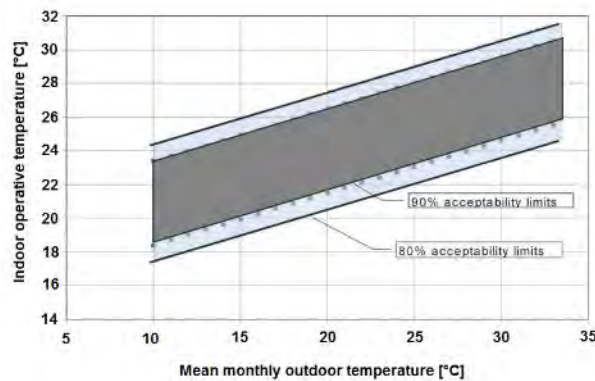

Figure 2: Acceptable operative temperature ranges for naturally ventilated spaces from ASHRAE 55 (2013)

The graph of thermal acceptability in Figure 2 (ASHRAE 55 2013) shows the concept of the adaptive approach in which there are variations in acceptable indoor comfortable (operative) temperatures under different mean outdoor temperatures and acceptable limits. Thus, people in warm climate zones tend to tolerate higher indoor temperatures than people living in cold climate zones. Considering the range of outdoor temperatures in Rio de Janeiro, 27°C was defined as the maximum temperature allowed within the offices during the working hours.

For the mixed model ventilation cases, the windows were set to open when the room temperature is lower than 27°C and the outside air temperature is at least 2°C below the room air temperature.

The results are used to evaluate the impact of the application of the second layer on the building facade on the cooling energy demand. Moreover, it compares the energy consumption of a full air conditioning model with mixed mode ventilation option.

3. RESULTS

Figure 3 shows the sum of the cooling plant sensible loads for all rooms in the building over the months of the year during the working hours of cases 1 (fully air conditioning model with DSF) and 2 (mixed mode ventilation model with DSF), respectively. For the building with DSF, the mixed mode case consumes 21% less energy than the fully air conditioned case. This difference is up to 49% during the winter months, which indicates the potential of natural ventilation in meeting the thermal comfort.

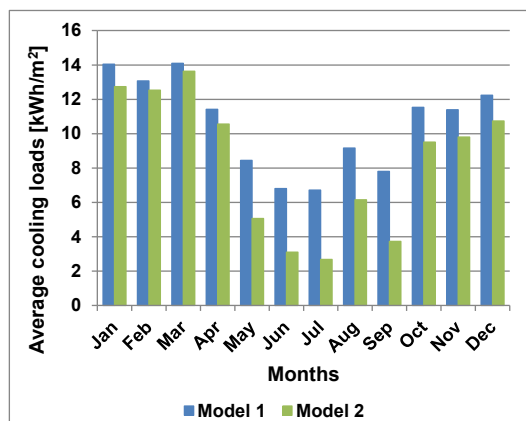

Figure 3 – Comparison of cooling loads of DSF models 1 (fully air conditioned) and 2 (mixed mode ventilation)

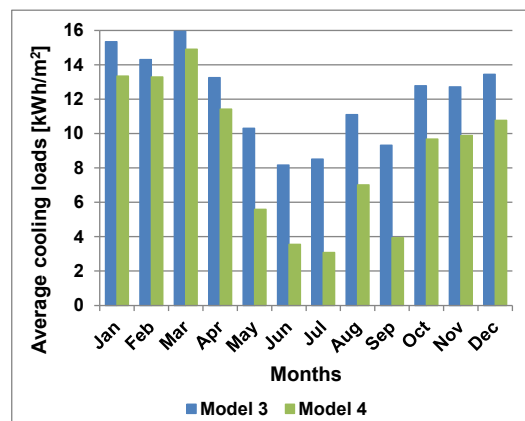

Figure 4 – Comparison of cooling loads of SSF models 3 (fully air conditioning) and 4 (mixed mode ventilation)

Comparing the cooling loads of cases without the double skins, the results show that the mixed mode case consumes 27% less energy than the fully air conditioned case, as shown in Figure 4. The results illustrate that thermal acceptance can be achieved for significant part of the year without requirements of air conditioning under

this climate condition. Such strategy gains energy and environmental benefits, resulting in improved indoor air quality, reduction in operational costs and higher occupant satisfaction.

For the models with full air conditioning, the case with DSF consumes 15% less energy than the case with SSF. This can be explained by the reduced solar gains as the double skin provides an additional filtration to solar heat gains. The moderation of temperature difference between the cavity and the room can also contribute to the lower energy consumption. For mixed mode ventilation models that allow natural ventilation, the results showed that the energy consumption for the building with DSF is on average only 6% lower than the SSF case. The building thermal performance is therefore not substantially enhanced with the application of the second skin, which can be partly due the overheating promoted by the DSF, especially during the hot days. Furthermore, the radiation emitted by the heated shading device can increase the heat gains into the building especially when windows are open.

Air conditioning is not required in about 34% of the working hours in a building with DSF adopting mixed mode ventilation. However, it increases to 41% in the model with SSF (Figure 5). Although the DSF works as a thermal chimney promoting air movement under low wind speeds, the solution was unable to significantly improve the **building's thermal performance**. Therefore, if the building thermal performance only is considered, the conventional less costly and simpler single skin façade (SSF) is more appropriate to be implemented in this tropical climate.

4. CONCLUSION

This study examines the energy consumption of a building with or without an optimized DSF under tropical climate. The models are tested under fully air conditioned and mixed mode ventilation strategies. The results indicate that for the building with DSF, indoor comfort conditions can be met by using naturally ventilation in nearly 34% of the time in the year. Conceptually there is potential energy saving opportunity which should be considered before committing to full air conditioning. Energy savings of 21% can be achieved in mixed mode ventilation systems when compared to fully air conditioning buildings with DSF. However, when considering models with and without DSF, the energy savings are small – 15% in fully air conditioned model and 6% in mixed mode ventilation model. Prior to adopting DSF, simpler and less costly options such as shading devices, strategic openings and fabric materials should therefore be considered.

Within the constraint of necessary assumptions, simplifications and limitations of simulation tools currently available, results of this research have demonstrated that thermal acceptability in a naturally ventilated building with DSFs under Brazilian climates is similar to its single skin counterpart; the benefits of the thermal performance alone can therefore not sufficiently justify such an expensive design feature. However, application of DSF is still at its infancy and, with the advances in technologies, its full potentials are yet to be explored. With the likely increasing use of glazed façades in office buildings in Brazil, there is a clear necessity to develop guidelines and performance data related to DSF and to develop detailed methodology for its evaluation. Comprehensive whole life evaluation is recommended to provide a holistic assessment when other beneficial contributors such as lighting, smart glazing and integrated PV are taken into consideration.

REFERENCES

- [1] Ali Ghaffarianhoseini, A., Ghaffarianhoseini, A., Berardi, U., Tookey, J., Li, D. H. W. And Kariminia, S. 2016. Exploring the advantages and challenges of double-skin façades (DSFs). *Renewable and Sustainable Energy Reviews*, 60, 1052–1065.
- [2] Barbosa, S. and Ip, K. 2014. Perspectives of double skin façades for naturally ventilated buildings: A review. *Renewable and Sustainable Energy Reviews*, 40, 1019-1029.
- [3] Zhang, Y., Wang, J., Chen, H., Zhang, J. & Meng, Q. 2010. Thermal comfort in naturally ventilated buildings in hot-humid area of China. *Building and Environment*, 45, 2562-2570.
- [4] Torres, M., Alavedra, P., Guzmán, A., Cuerva, E., Planas, C., Clemente, R. & Escalona, V. Double skin façades - Cavity and exterior openings dimensions for saving energy on Mediterranean climate. *Building Simulation*, 2007 Beijing, China.
- [5] Chou, S. K., Chua, K. J. & Ho, J. C. 2009. A study on the effects of double skin façades on the energy management in buildings. *Energy Conversion and Management*, 50, 2275-2281.
- [6] **Rahmani, B., Kandar, M. Z. & Rahmani, P. 2012. How Double Skin Façade's Air-Gap Sizes Effect on Lowering Solar Heat Gain in Tropical Climate? World Applied Sciences Journal 18, 774-778.**

- [7] Agathokleous, R. A., Kalogirou, S. A. 2016. Double skin facades (DSF) and building integrated photovoltaics (BIPV): A review of configurations and heat transfer characteristics. *Renewable Energy*, 743-756.
- [8] Barbosa, S., Ip, K. & Southall, R. 2015a. Thermal comfort in naturally ventilated buildings with double skin façade under tropical climate conditions: The influence of key design parameters. *Energy and Buildings*, 109, 397-406.
- [9] Barbosa, S., Ip, K. & Southall, R. 2015b. Influence of key site parameters on the thermal performance of double skin façades in naturally ventilated buildings in a tropical climate. In: 31st International PLEA Conference, Bologna. Ass. Building Green Futures, Bologna.
- [10] Barbosa, S. and Ip, K. 2016. Predicted thermal acceptance in naturally ventilated office buildings with double skin façades under Brazilian climates. *Journal of Building Engineering*, 7, 92–102.
- [11] Gratia, E. & De Herde, A. 2007a. Greenhouse effect in double-skin façade. *Energy and Buildings*, 39, 199-211.
- [12] Kim, Y.-M., Kim, S.-Y., Shin, S.-W. & Sohn, J.-Y. 2009. Contribution of natural ventilation in a double skin envelope to heating load reduction in winter. *Building and Environment*, 44, 2236-2244.
- [13] ASHRAE 2009. *Handbook—Fundamentals*. Atlanta, GA: American Society of Heating, Refrigerating and Air Conditioning Engineers.
- [14] Chan, A. L. S., Chow, T. T., Fong, K. F. & Lin, Z. 2009. Investigation on energy performance of double skin façade in Hong Kong. *Energy and Buildings*, 41, 1135-1142.
- [15] Mingotti, N., Chervidyakarn, T. & Woods, A. W. 2013. Combined impacts of climate and wall insulation on the energy benefit of an extra layer of glazing in the façade. *Energy and Buildings*, 58, 237-249.
- [16] Gratia, E. and De Herde, A. 2007b. The most efficient position of shading devices in a double-skin façade. *Energy and Buildings*, 39, 364-373.
- [17] Sanchez, E., Rolando, A., Sant, R. And Ayuso, L. 2016. Influence of natural ventilation due to buoyancy and heat transfer in the energy efficiency of a double skin facade building. *Energy for Sustainable Development*, 33, 139–148.
- [18] IESVE 2016. *Integrated Environmental Solutions*. Integrated Environmental Design Solutions Ltd.
- [19] MENTOR 2014. *Computational Fluid Dynamics (CFD) software*. 10.1 ed. <http://www.mentor.com/products/mechanical/products/FloVENT> : Mentor Graphics Corporation.
- [20] M., Schuch, C.A., Matuso, K.H., Budag, Ono, E.T. 201. *Analysis Bio*. Laboratory of Energy Efficiency in Buildings.
- [21] ASHRAE 2013. *ASHRAE 55 - Thermal Environmental Conditions for Human Occupancy*. Atlanta: Ame.

Climate-Adaptive and Optimized Building Envelope Designs in East Asia

Kevin WAN^a, Timothy LOK^b, Antony HO^c, Vincent CHENG^d

^a Arup, Hong Kong SAR, kevin.wan@arup.com

^b Arup, Hong Kong SAR, timothy.lok@arup.com

^c Arup, Hong Kong SAR, antony.ho@arup.com

^d Arup, Hong Kong SAR, vincent.cheng@arup.com

ABSTRACT

Large scale, multi-use commercial developments are trending in major cities development in East Asia. With more mega scale buildings constructed, the impact on energy consumption and carbon emissions would be great. Climate-adaptive designs and optimized building energy strategies would be imperative to enhance the building adaptability to the local climates and improve the overall building energy efficiency. Next generation of the energy interactive building design provided a platform to address complicated combination and optimize different building design parameters on the impact towards the building energy consumptions.

Optimized envelope design strategies could be an effective approach to shelter building to its own climates and create pleasant indoor environment. Interactive and parametric optimization at early stage design will allow for the identification of design parameters in which the design team can take into consideration. A generic commercial office building is identified and in two locations with distinct climate zones in East Asia are chosen. With the energy interactive optimization, a clear combination of design parameters can be identified. An annual thermal load decrease of 8.2% and 6.5% as compared to the ASHRAE 90.1-2007 envelope baseline for Hong Kong and Seoul respectively.

Keywords: adaptable design, climate responsive architecture, facade optimization, building energy use

1. INTRODUCTION

The scientific work by the Inter-governmental Panel on Climate Change (IPCC) have raised public concerns about energy use and revealed the impact towards the environment (Solomon et al., 2007). It is generally acknowledged that the drivers of climate change were due mainly to the anthropogenic activities in raising the greenhouse gas concentration in the atmosphere. High-rise office building development is one of the fastest growing areas in the building sector especially in major cities in East Asia (Jiang, 2005). On a per unit floor area basis, energy use in large office building development with full air-conditioning can be 70-300 kWh/m², 10-20 times that in residential buildings (Jiang, 2006). With more tall buildings constructed (with 20 stories or more), the impact on energy consumption and carbon emissions are expected to growth (2% increase of carbon dioxide annually between 1971 and 2004) (UNEP, 2007).

Energy efficiency and sustainability issues are important considerations during the architectural design, and at all stages of the evaluation procedures. Two important issues that building architects and engineers need to identify is climatic responsive design and identifying the most effective strategy that the building should adopt to ensure true energy savings (Wan et al., 2012). The new generation of high-performance envelopes has transformed the way in which architects approach building design with a shift in emphasis from built form to performance and from structure to envelope. In the realm of high-performance buildings, the envelope has become the primary site of innovative research and development (Velikov and Thun, 2013). Climate responsive design and energy interactive design approaches are believed to be key to drive for the next generation smart building envelope designs.

2. NEXT LEVELS OF SUSTAINABLE BUILDING ENVELOPE DESIGNS

Buildings, energy and the environment are key issues faced by building professions worldwide, and energy is a key element in the overall efforts to achieve sustainable development (Jiang 2005 & 2006). Sustainable building designs provide a good solution to enhance the overall building energy performance. Overall thermal transfer value (OTTV) has been used as a conventional indicator to evaluate the building envelope performance particularly in subtropical climates due to its effectiveness in the consideration of the three major envelope heat gain components: (i) conduction through opaque walls, (ii) conduction through window glass and (iii) solar radiation through window glass (Hui, 1997). Previous sustainable building design experiences focuses on optimizing each design parameter

individually, where the sensitivity of each design parameter is generally known. However, the dynamic interaction of all the different design parameter is less studied, providing an opportunity for improvement in the design process through the simultaneous optimization of different parameters.

2.1 Conventional sustainable building designs

The aforesaid design approach provides a useful guideline for the architect or designer to have an idea about the impact of key design parameters to the thermal performance of the building facade. Through considering the thermodynamics and the energy flux between the external built environment and the internal loads, a basic understanding of the thermal behaviour of the building envelope is established, but the overall building energy usage cannot be fully establish. Accounting for the interactions between the multiple design parameters, simultaneously optimizing multiple envelope design parameters and establishing the energy building consumption at the zone level would be extremely useful and desired the building design process.

2.2 Energy interactive building designs

Architectural design would have close interaction with the indoor climate and the environment (Givoni, 1998). Defining the values of the input parameters is often a difficult task and there is no one way solution to address all design concerns (Lam et al., 2008). Maximizing the window opening would enhance the daylight penetration but imposing the solar heat gain and increase the building cooling load. Balancing the window-to-wall ratio and the darkness of the glazing as well as optimizing the length of the extended building shading are complicated and every combination would have different implication towards the building energy consumptions. Along with the blooming of computation power, interactive building design approach is realized via the integrative and open-source platform (Figure 1). EnergyPlus have been chosen as the energy simulation software and there are a few **compatible optimization solvers for EnergyPlus including Grasshopper's Galapagos, OpenStudio, GenOpt, and JEPlus. Grasshopper's Galapagos was chosen for its simplicity and user friendliness. The parametric optimization tool is integrated with the five components as below:**

- Rhinoceros
- Plugin: Grasshopper
- Plugin: Honeybee and EnergyPlus
- Optimization solver component: Galapagos

A 3D building geometry is developed on the platform of the parametric optimization tool and the key building envelope design parameters are defined, such as the window U-value, solar heat gain coefficient (SHGC), wall U-value, window-to-wall ratio (WWR), and shading depth. A building description file for Energyplus (.idf file) including the building envelope and system details would be generated. Building energy simulations will be carried out and the zone cooling energy and heating energy use based on a combination of the design parameters would be visualized on the 3D model in parallel. The parametric optimization could also analyse the interaction between parameters by the genetic algorithm and optimize the best combination of the parameter values towards the zone energy consumption. The methodology would be further discussed in the next section.

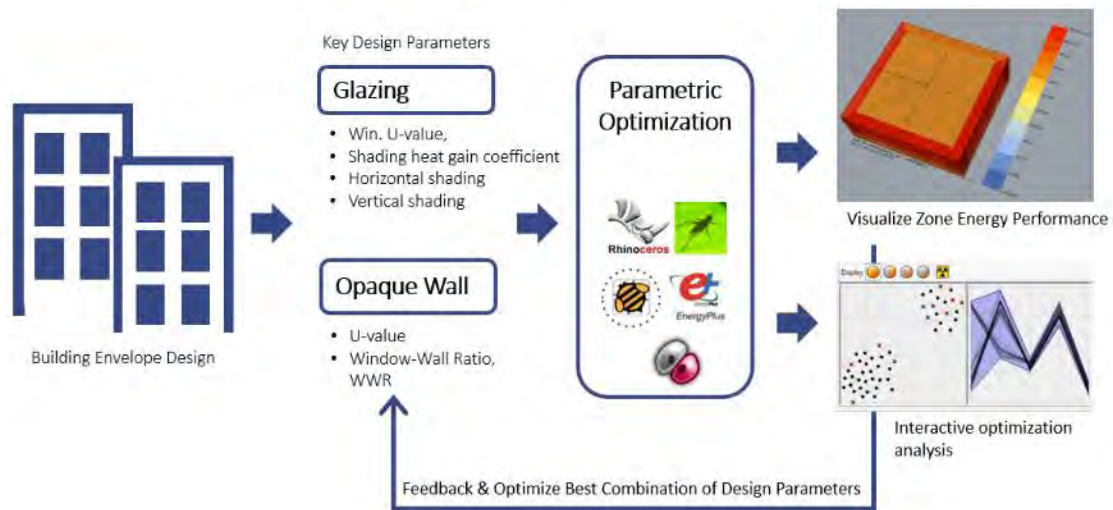

Figure 1: Energy interactive design approach

3. METHODOLOGY

Simulated Annealing (SA) was chosen as the optimization solver for this study, where it follows one solution candidate's iterative jumps across the solution space to approximate for the global optimum point (Kirkpatrick et al., 1983). Each iterative jump and its legitimacy are affected by the temperature of the system, where the candidate should converge towards the global optimum. The design approach focuses on the building envelope parameters, which are mentioned in Section 2.2. These parameters are limited to a certain range, reflecting actual building designs. A step function is also introduced to reduce the number of cases and allowing the solver to refine its search.

A generic office building was developed to serve as a baseline reference for comparative energy studies. The a base case is a 35x35m, 20 stories building with perimeter zone of 4m depth, an interior zone of 6m depth, and an internal core area of 15x15m. The interior zone and perimeter zone are set as open office area and the interior core, for simplicity, is set as corridor area. The bottom and uppermost floor are simulated for their thermal load, with an adiabatic block in between. The building's annual thermal load is calculated by multiplying the bottom floor's thermal load by 19, to reflect the floors replaced by adiabatic block. A range is set for each design parameters for envelope through experience of a typical office building, with a step introduced to reduce the number of possible iterations while maintaining a fine enough resolution to observe differences (Table 1). The indoor loads and ventilation requirements references ASHRAE 90.1-2007 and ASHRAE 62.1-2007 (Table 2) (White et al., 2007; Stanke et al., 2007). The equipment load uses 20W/m² (EMSD, 2007) a typical load density as found in office buildings.

Key Design Parameters for Envelope	Range	Step
Window-to-Wall Ratio	0.3 – 0.8	0.05
Window SHGC	0.2 – 0.9	0.05
Window U-Value (W/m ² ·K)	1.5 – 6.0	0.5
Wall U-Value ((W/m ² ·K)	0.4 – 2.0	0.2
Horizontal Shade Depth (m)	0 – 1.0	0.25
Vertical Shade Depth (m)	0 – 1.0	0.25

Table 1: Key design parameters for building envelope

Design Parameters	Open Office	Corridor
Lighting Power Density (W/m ²)	12	5
Equipment Power Density (W/m ²)	20	0
Occupancy Density (prs/m ²)	0.05	0
People Outdoor Air Rate (L/s·person)	2.5	0.3
Area Outdoor Air Rate (L/s·m ²)	0	0.3

Table 2: Building internal load and ventilation requirements

	Hong Kong	Seoul
ASHRAE Climate Zone	2 – hot climate	4 – mixed climate
Cooling Set-Point	23°C	26°C
Heating Set-Point	22°C	20°C

Table 3: Climate zone and set-points

In this study, two major financial cities within Asia with two distinct climate zones are chosen, them being Hong Kong and Seoul. The cooling and heating set-points of the buildings are based on the local energy codes (EMSD, 2012; MOLIT, 2015). Hong Kong is located in ASHRAE climate zone 2, with a hot climate, where cooling is dominant. Seoul is located in ASHRAE climate zone 4, with a mixed features of hot summer and cold winter, where heating is slightly dominant.

The air conditioning system is defined as an Ideal Air Load system, thus it is possible to simulate the annual cooling energy load and annual heating energy load. The optimization study aims to reduce the total annual thermal load, which would thus reduce the energy consumption of the HVAC system, normally found to be over 40% of the total building energy consumption.

4. BASELINE CASE

A baseline case is developed for each of the city, where the indoor set-point and internal load are set as described in Section 3. The baseline building envelope are developed based on ASHRAE 90.1-2007 (White et al., 2007) and summarized in Table 4. Table 5 shows the simulated annual cooling and heating load of the building located in the two studied cities.

Design Parameters	Hong Kong	Seoul
Window-to-Wall Ratio	0.4	0.4
Window SHGC	0.25	0.4
Window U-Value (W/m ² ·K)	3.97	2.84
Wall U-Value (W/m ² ·K)	0.70	0.37
Horizontal Shade Depth (m)	-	-
Vertical Shade Depth (m)	-	-

Table 4: Baseline envelope configuration

Building Energy Component	Thermal Energy Use	
	Hong Kong	Seoul
Annual Cooling Load (kWh)	7,633,743	552,250
Annual Heating Load (kWh)	608,866	5,504,085
Annual Thermal Load (kWh)	8,242,609	6,056,335
Thermal Load (kWh/m ²)	336.4	247.2

Table 5: Summary of the thermal load for the simulated baseline

5. OPTIMIZATION RESULTS

The optimization solver will generate large amounts of cases as it searches for the optimal solution. The results are plotted on a multi-dimensional graph (Figure 2), where the first three axis depicts the simulation output, them being the annual thermal load (total), annual cooling load (cooling), and annual heating load (heating). The six remaining axis depicts the building envelope parameters. Each line shown on the plot depicts one design scenario, where the intersection of each axis describing the results (first three axis) or the input parameters (remaining seven axis). The colour scheme of the plot follows that of the annual thermal load, with blue being lower value and red being higher value.

5.1 Building envelope optimization for Hong Kong

Hong Kong's thermal load is dominated by cooling load. It is also well known that the external solar radiation is a dominating factor in heat gain through building facade. This echoes to the local OTTV calculation where the shading coefficient have a heavier weighting factor than wall U-value. From the results plot, a lower annual thermal load is achieved when the following factors are met:

- Minimize envelope U-value to minimize heat transfer from outdoor to indoor in hot summer months
- Lower window SHGC to reduce solar heat gain
- Reduce WWR to reduce solar heat gain through window.
- **Window's U-value** is also higher than that of the wall, thus reducing WWR will also reduce heat transfer
- Maximize shading depth to reduce solar heat gain through window

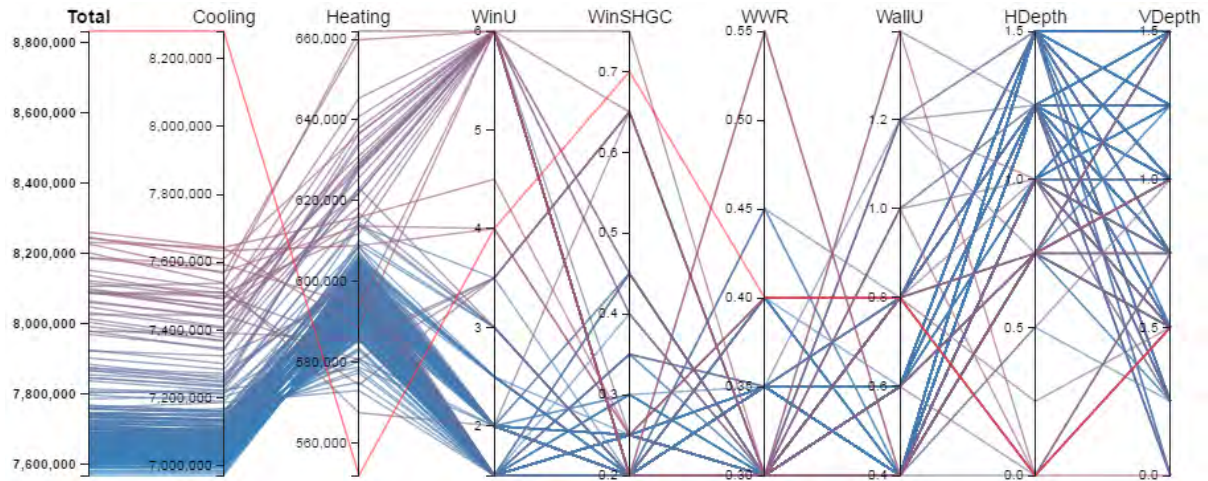

Figure 2: Optimization results – Hong Kong

The optimal case was found to have the below configuration, which resulted in thermal loads as shown in Table 6. Noting that the HVAC system takes up approximately 40% of the annual energy consumption of the building, an 8.2% decrease in annual thermal load will approximately lead to a 3% decrease in annual total energy consumption. Other than finding the optimal case, the solver also populated the solution space with numerous different cases. This allows for the consideration of different envelope designs which may yield similar reduction in annual thermal load.

Figure 3 shows the top 10% results of the optimization run, where the annual thermal load decrease from the baseline case ranges from 7.7% to 8.2%. An observation from the above plot is that the solver prefers a longer **horizontal shading depth over a longer vertical shading depth**. This can be explained by Hong Kong's high solar angle over the year, thus a longer horizontal shading depth would block out more solar radiation.

Design Parameters (Hong Kong)	Design Values
Window-to-Wall Ratio	0.3
Window SHGC	0.2
Window U-Value (W/m ² ·K)	1.5
Wall U-Value (W/m ² ·K)	0.4
Horizontal Shade Depth (m)	1.5
Vertical Shade Depth (m)	1.5

Table 6: Optimal envelope configuration of Hong Kong

Building Energy Component	Thermal Energy Use	% Difference
Annual Cooling Load (kWh)	6,972,526	-8.7%
Annual Heating Load (kWh)	594,896	-2.3%
Annual Thermal Load (kWh)	7,567,422	-8.2%
Thermal Load per Area (kWh/m ²)	308.9	

Table 7: Optimized case energy simulation results of Hong Kong

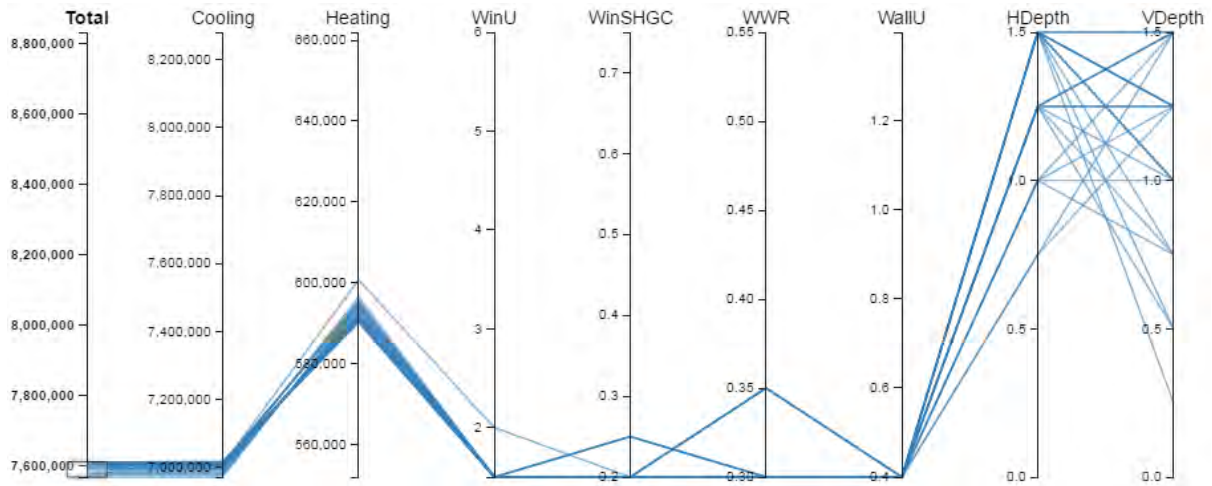

Figure 3: Optimization results – Hong Kong (Top 10% Results)

5.2 Building envelope optimization for Seoul

In Korea, the annual thermal load is dominated by the heating load. An optimal building design is required to balance the building cooling and heating load in different seasons. From the results plot (Figure 4), a lower annual thermal load is achieved when the following factors are met:

- Minimize envelope U-value to reduce heat loss during winter
- High SHGC to allow for higher solar heat gain during winter, even though there will be an increase of cooling load during summer
- Minimize shading to maximize solar heat gain during winter
- A balanced WWR to minimize heat transfer through the window but also to allow for incoming solar radiation

The optimal case was found to have the configuration as shown in Table 8 and the thermal loads results as shown in Table 9.

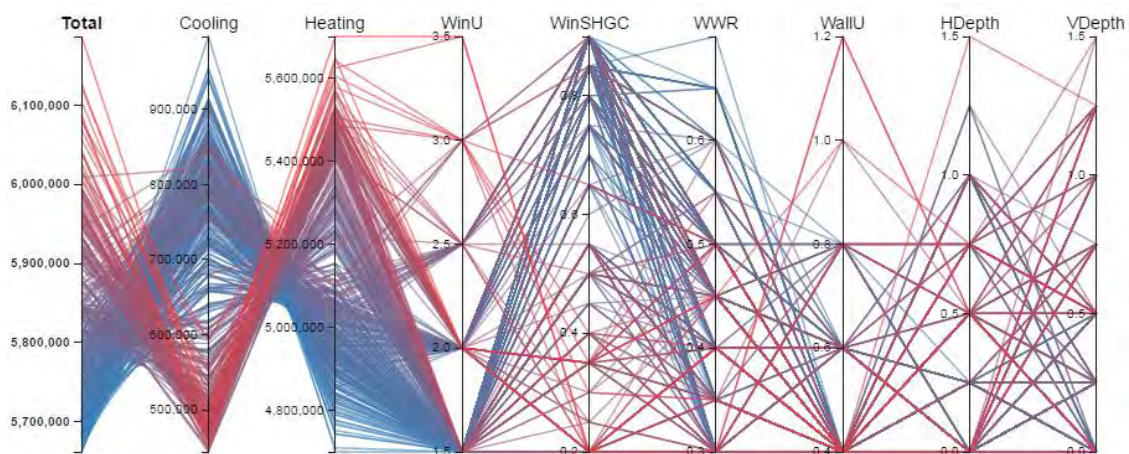

Figure 4: Optimization results – Seoul

Design Parameters (Seoul)	Design Values
Window-to-Wall Ratio	0.45
Window SHGC	0.9
Window U-Value (W/m ² ·K)	1.5
Wall U-Value (W/m ² ·K)	0.4
Horizontal Shade Depth (m)	0
Vertical Shade Depth (m)	0.45

Table 8: Optimal envelope configuration of Seoul

Building Energy Component	Thermal Energy Use	% Difference
Annual Cooling Load (kWh)	865,187	56.7%
Annual Heating Load (kWh)	4,796,533	-12.9%
Annual Thermal Load (kWh)	5,661,720	-6.5%
Thermal Load per Area (kWh/m ²)	231.1	

Table 9: Optimized case energy simulation results of Seoul

The optimal case would greatly increase the annual cooling load. As the study case only reports the thermal load, special care should be taken when choosing for the optimal case, where energy cost saving should also be taken into account.

Observing the top 10% results, where the annual thermal load decrease ranges from 6.0% to 6.5%, the factors leading to a lower annual thermal load can be clearly showcased. It is also observed that there are leeway in the selection of window SHGC and of shading depth. There are also no strict restriction in choosing a WWR. The plot also shows that the cooling load can be significantly decreased while maintaining a high overall decrease of annual thermal load. By lowering the WWR and slightly increasing the shading depth, the cooling load can be decreased while not significantly compromising the heating load nor annual thermal load.

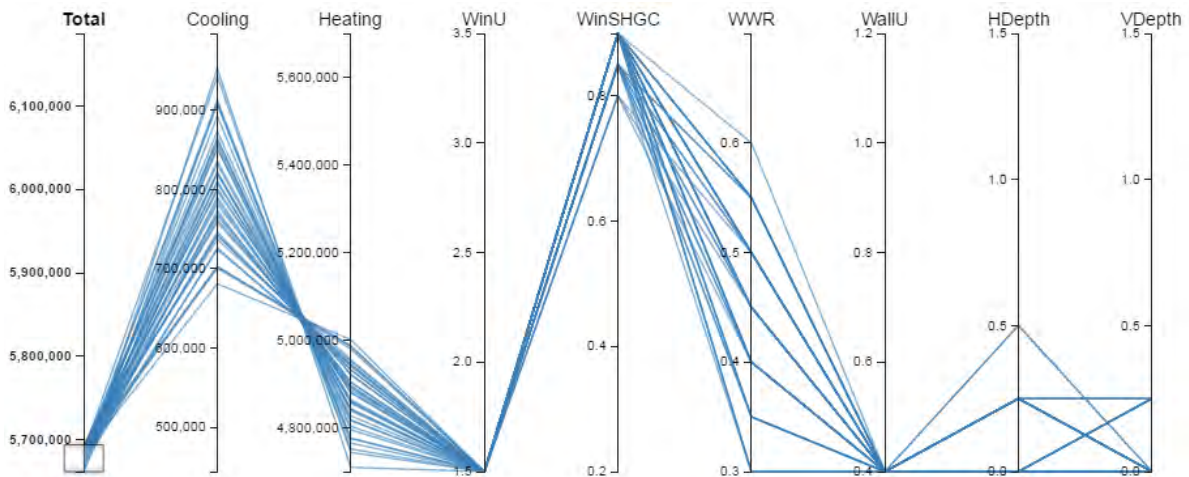

Figure 5: Optimization results – Top 10% results – Hong Kong

6. CONCLUSION

Interactive and parametric optimization at early stage design will allow for the identification of design parameters in which the design team can take into consideration. With the initial settings in the above two cases, clear design parameters can be found after utilizing the optimization solver within Grasshopper. The optimal case found by the solver returned results with annual thermal load decrease of 8.2% and 6.5% as compared to the ASHRAE 90.1-2007 envelope baseline for Hong Kong and Seoul respectively.

Over 200 cases were generated by the solver during each run, giving the design team numerous design iterations where similar savings may also be achieved. The optimization parameters are not limited to those in the above study. Internal load, other envelope properties, nearby surrounding building shading effects, and HVAC settings can all be simultaneously studied. As each parameter will dynamically affect each other and the overall thermal load, by utilizing the increasing computational power available, numerous optimized design options can be

generated for better designs. It is believed that energy interactive design approaches would be the driver for future sustainable and climate responsive designs.

REFERENCES

- [1] EMSD, 2007. Guidelines on Performance-based Building Energy code.
- [2] EMSD, 2012. Code of Practice for Energy Efficiency of Building Services Installation.
- [3] Franca T., 2013. Design and Construction of High-Performance Homes - Chapter 1.3: Building Envelopes, Renewable Energies and Integrated Practice. Routledge Taylor & Francis Group. London and New York.
- [4] Givoni B., 1998. Climate considerations in building and urban design. John Wiley & Sons, Inc. New York.
- [5] Hui, S. C. M., 1997. Overall thermal transfer value (OTTV): how to improve its control in Hong Kong, In Proc. of the One-day Symposium on Building, Energy and Environment, 16 October 1997, Shangrila Hotel, Kowloon, Hong Kong, HKIE BS Division/CIBSE/ASHRAE/PolyU, pp. 12-1 to 12-11.
- [6] Jiang Y., 2005. Current building energy consumption in China and effective energy efficiency measures. *HV&AC*, 35(5), 30-40 [in Chinese].
- [7] Jiang Y., 2006. Current trend of building energy use and major conservation issues in China. *Green Building*, 7, 10-15 [in Chinese].
- [8] Kirkpatrick S., Gelatt C.D., Vecchi M.P., 1983. Optimization by Simulated Annealing. *Science*, 220(4598), 671-680.
- [9] Lam J.C., Wan K.K.W., Yang L., 2008. Sensitivity analysis and energy conservation measures implications. *Energy Conversion and Management*, 49(11), 3170-3177.
- [10] MOLIT, 2015. Energy Saving Design Standard of Building. [Korean Translation].
- [11] Solomon S, Qin D, Manning M, et al. 2007. Climate Change 2007: The Physical Science Basis. Contribution of the Working Group I to the Fourth Assessment Report of the Intergovernmental Panel on Climate Change. Cambridge: Cambridge University Press.
- [12] Stanke D.A., Hedrick R.L., Alevantis L.E., et al. 2007. ANSI/ASHRAE Standard 62.1-2007 Ventilation for Acceptable Indoor Air Quality.
- [13] UNEP, 2007. Buildings and Climate Change: Status, Challenges and Opportunities. Nairobi, United Nations Environmental Programme.
- [14] Wan K.K.W., Chan M.H., Cheng V.S.Y., 2012. Considerations of Sustainable High-rise Building Design in Different Climate Zones of China. *International Journal of High-Rise Buildings*, 1(4), 301-310.
- [15] White J.W., Calm J.M., Schwedler M., et al. 2007. ANSI/ASHRAE/IESNA Standard 90.1-2007 Energy Standard for Buildings Except Low-Rise Residential Buildings.

Folded Cardboard Sandwiches for Load-bearing Architectural Components

Stephan SCHÜTZ^a

^a Bauhaus-Universität Weimar, Germany, stephan.schuetz@uni-weimar.de

ABSTRACT

The high resource demand of the building sector clearly indicates the need to search for alternative, renewable and energy-efficient materials. This work presents paper-laminated sandwich elements with a core of corrugated paperboard that can serve as architectural components with a load-bearing capacity after a linear folding process. Conventional methods either use paper tubes or glued layers of honeycomb panels. In contrast, the folded components are extremely lightweight, provide the material strength exactly where it is statically required and offer many possibilities for design variants. After removing stripes of the paper lamination, the sandwich can be folded in a linear way at this position. Without the resistance of the missing paper, the sandwich core can be easily compressed. The final angle of the folding correlates with the width of the removed paper stripe. As such, this angle can be described by a simple geometric equation. The geometrical basis for the production of folded sandwich elements was established and many profile types were generated such as triangular, square or rectangular shapes. The method allows the easy planning and fast production of components that can be used in the construction sector. A triangle profile was used to create a load-bearing frame as supporting structure for an experimental building. This first permanent building completely made of corrugated cardboard was evaluated in a two-year test to confirm the efficiency of the developed components. In addition to the frame shown in this paper, large-scale sandwich elements with a core of folded components can be used to fabricate lightweight ceilings and large-scale sandwich components. The method enables the efficient production of linearly folded cardboard elements which can replace normal wooden components like beams, pillars or frames and bring a fully recycled material in the context of architectural construction.

Keywords: adaptable design, green construction technology, folded components, corrugated cardboard sandwich, architecture, construction

1. INTRODUCTION

Future-proof architectural constructions must possess many characteristics. They should be constructed solid and durable as well as inexpensive and sustainable, while the quantity of used material and production energy has to be as low as possible. Components made of corrugated cardboard can make an important contribution in this context because of many ecological advantages like low embodied energy, excellent recycling rate and residue-free production process. However, they are currently rarely used in the architectural field. Only in some cases they are used as core material in walls or as thermal insulation panels.

As corrugated cardboard materials are rarely used in the construction sector, only a small selection of literature and projects can be found. Lu et al., Nordstrand and Abbès et al. provide an approach to the issue of stability of corrugated sandwich panels. The strength values of the presented material (compressive strength, tensile strength, bending) as well as the use of folded components are discussed in detail by Schütz. Tian and Lu, Ayan and Pohl explore the structural and architectural use of corrugated cardboard. Eekhout et al. present basic approaches and implemented architectural projects. Basic knowledge on folded paper objects are presented by Jackson and Zeier. Miura and Sakamaki analyse folding in a deeper way and folded lightweight structures are presented by Hilmar.

In this paper, five hypotheses are postulated. First, an exact zone of folding is definable by removing a strip-like part of the inner face material (e.g. with a CNC controlled milling machine). Second, the width of this zone relates to the resultant angle of the folded component and this relation can be described with a simple equation. Third, the profiles are solely producible by longitudinal folding. Fourth, the paper removal on both sandwich surfaces allows more sophisticated profiles with convolutions in two directions and leads to a huge amount of design varieties. Fifth, the production of folded multipart elements with load-bearing capacity is possible.

2. MATERIAL

The core of the sandwich plate consists of corrugated and flat paper layers that are glued with Sodium silicate (CAS 1344-09-8) to form a block. The sinusoidal corrugated layer has a wave separation of 8 to 9,5mm and a wave height of 4 to 5,3mm (coarse wave A). The core consists of 100% recycled paper with a weight of 110g/m². **This paper has a thickness of 140 to 159µm and the weight of a block is 65kg/m³ with a tolerance of 15%.** The block is cut into flat panels of 5 to 100mm thickness. The surfaces of the panels are covered with so-called kraft paper by using PVA-glue. This paper consists of about 30% recycled material, has a weight of 280g/m² and a paper **thickness of 348µm.** **The maximum size of the sandwich panels is 3130 x 1260mm.** The here presented methods and results refer to sandwich panels with a material thickness of 30mm and linear folds.



Figure 1: Corrugated cardboard sandwich (left) and core material (right)

3. METHODS

The folding of a flat element generates a zero line that divides the material into an inner zone of compression and an outer zone of elongation. In a homogeneous material like a metal sheet, the zero line runs through the geometric centre. This can be seen in the left section of Figure 2.

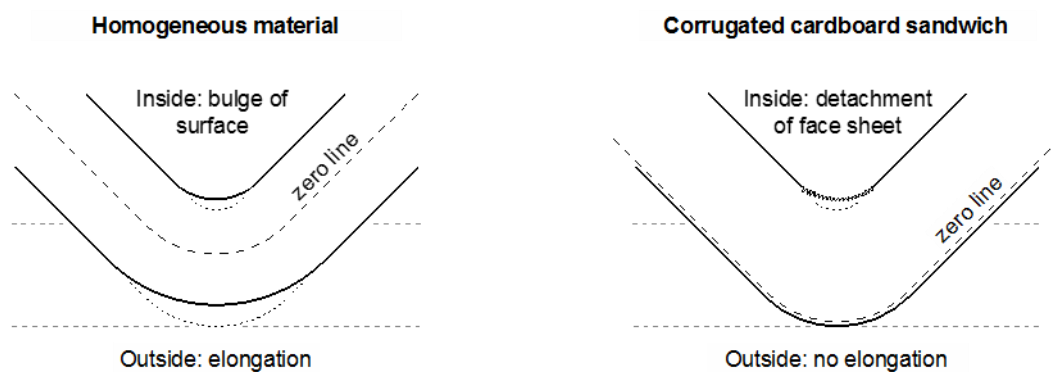

Figure 2: Folding of homogeneous material (left) and corrugated cardboard sandwich (right)

Corrugated cardboard sandwiches are inhomogeneous, therefore the structure of core and cover material should be considered separately. The surface paper has a high tensile strength and flexibility due to bending. The core is very pressure-resistant under vertical load but it is very sensitive to lateral compression. This feature turns out to be a great advantage in this case. The zero line migrates close to the outer surface paper and just a zone of compression remains at the inside. This can be seen in the right section of Figure 2. The resultant curve describes a circular arc segment, which results in a unique aesthetic appearance. During the folding process, the inner surface is compressed in such a way that it separates itself from the core structure. To avoid this detachment a stripe-like part of the inner surface paper is removed. Then, the folding process runs effortlessly and the longitudinal edges of the remaining papers touch each other. This indicates the end of the folding process. Figure 3 shows the section through a corrugated cardboard plate before and after the folding process. It clarifies the relation between starting angle α_1 and resultant angle α_2 .

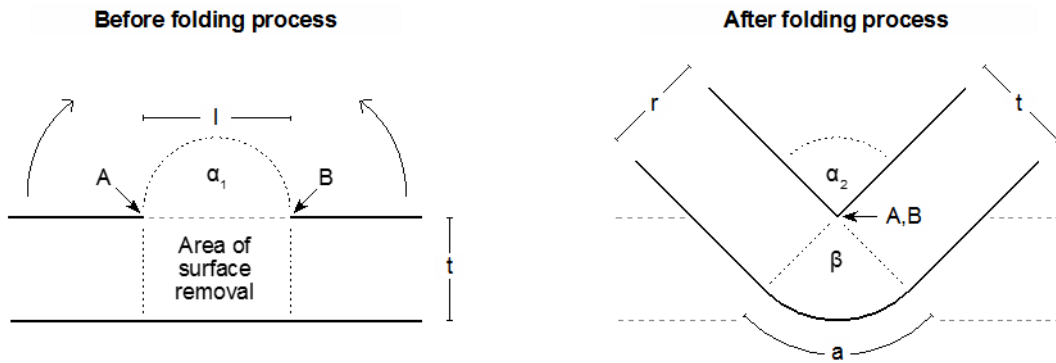

Figure 3: Unfolded corrugated cardboard sandwich (left) and folded element (right)

This folding process can be described geometrically by an equation. Their derivation is as follows. The material thickness t corresponds to the radius r . The width l of the removed paper defines the distance \overline{AB} between the longitudinal edges of the remaining surface paper. The folding process to the resultant angle α_2 creates the internal angle β . The arc length a corresponds to l as well as A and B are congruent. If a final angle α_2 is given, the strip-like paper removal can be calculated by using the formula of the circular arc:

$$a = \pi \cdot r \cdot \frac{\beta}{180^\circ}$$

Equation 1

Since r is known by the given material thickness t , the angle β remains as the only unknown parameter. Because a is equal l , the final formula reads as follows:

$$l = \pi \cdot r \cdot \frac{(180^\circ - \alpha_2)}{180^\circ}$$

Equation 2

The equation shows, that the width of the paper removal is inversely proportional to the resulting angle. More material must be removed to obtain a smaller angle. The geometric coherences relate only to the inner angle and the arc length. That is why the equation can be used for any material thickness.

4. RESULTS

A load-bearing architectural component like a beam or a pillar is producible by multiple folding of a formerly flat plate into a profile. The following example of a pillar is based on an equilateral triangle and shows the application of the presented formula. Figure 4 shows the folding process schematically.

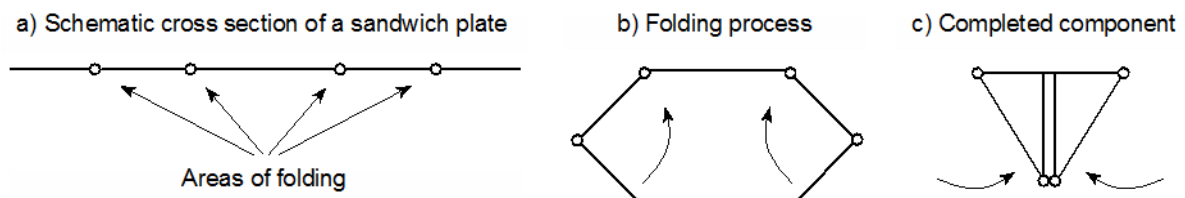

Figure 4: Folding process of a triangular pillar

The profile is made of a honeycomb plate with a thickness of $t = 30\text{mm}$. The dimensions are $w = 308\text{mm}$ and $h = 223\text{mm}$. One half of this symmetric profile is considered for identification of the areas of paper removal. This is shown in Figure 5.

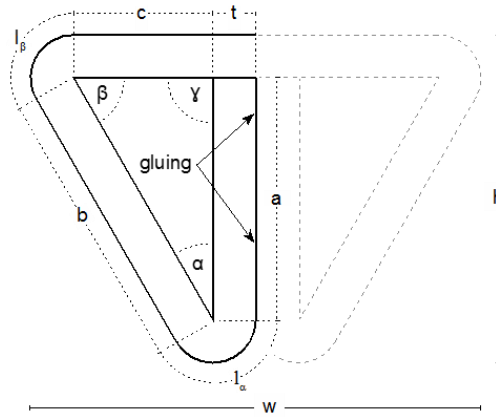

Figure 5: Half section of the described pillar with single segments

The half of the profile is a right triangle with the opposite side a , the hypotenuse b and the adjacent side c . These lengths are calculated by using the angle laws and the given dimensions for w (width) and h (height) as well as t (material thickness) of the desired profile. The two surfaces that touch each other after folding are glued with standard PVA glue. The total developed view of the component is composed of a sequence of lengths whose sum must to be doubled. The two important areas of paper removal are l_{α} and l_{β} . Both can be calculated with Equation 2. The total length of the developed view l_{total} is calculated with the following equation:

$$l_{total} = 2 \cdot (t + c + l_{\beta} + b + l_{\alpha} + a)$$

Equation 3

With the method presented here a variety of different types of profiles can be produced. Figure 6 shows the horizontal section through a selection of pillar-profiles based on basic geometrical shapes. In principle, hollow profiles (see Figure 6a, 6b, 6c) and double material profiles (see Figure 6d, 6e, 6f) can be distinguished.

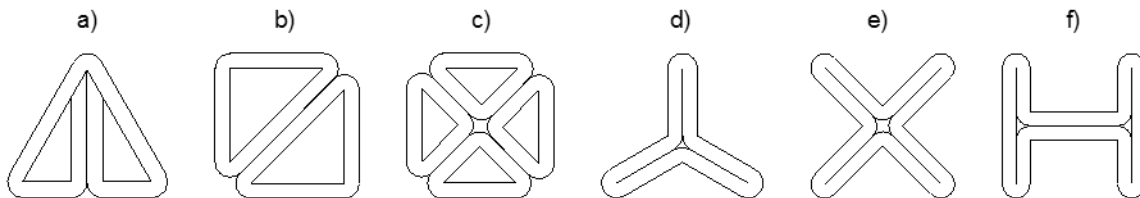

Figure 6: Hollow profiles (a, b, c) and double material profiles (d, e, f)

The profiles shown above can be used as role models for ceiling structures. Figure 7 shows the vertical section through two individual beams (see Figure 7a, 7b) as well as a ribbed slab (see Figure 7c). This is enabled by continuous folding and gluing of the substructure. The extension to a large-size ceiling sandwich is possible by gluing of an additional plate on the bottom side (see Figure 7d).

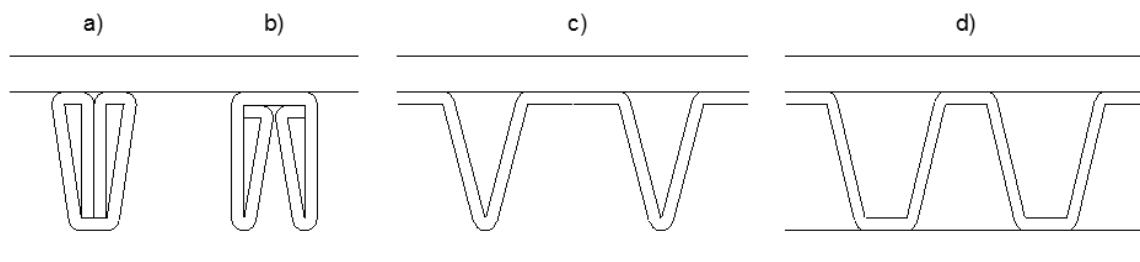

Figure 7: Single horizontal beams (a, b), a ribbed slab (c) and a sandwich ceiling (d)

The profile shown in Figure 5 is the starting point of a framework that serves as load-bearing structure of an experimental building, which is entirely made of corrugated cardboard panels. The building is called "Open Source: Cardboard" and combines the advantages of folded elements for construction and flat sandwich panels for thermal insulation. With a length of 5.05m, a width of 3.36m and a height of 3.58m, the permanent pavilion offers space for at least six student workplaces. Figure 8 shows the views and the interior.



Figure 8: South facade (left), north facade (centre) and interior (right)

5. DISCUSSION

The results confirm the hypotheses made above and show the simple planning and production of load-bearing folded corrugated cardboard elements. The profiles possess aesthetic curves in the area of folding and thus a continuous surface. Thereby, open cut edges are avoided what facilitates stability and uniform appearance. The production is simple with a standard two-axe milling machine.

Now, a hitherto rarely considered material can be used in in the construction sector. It has a great potential to replace normal wooden beams and pillars as well as ceilings. A beam with a length of 300cm and a height of 22cm carries a load of 400 kg with only little deformation. Beside the here presented profiles, other hybrid components can be created by the addition of thin wooden plates. This opens up an entirely new field of research.

The method provides an enormous variety of profile variants whose shape not only depends on static aspects but also on aesthetic design specifications. The way of calculation and the principle of production are comprehensible and the used material is cheap. Even complicated folds are feasible and allow the production of multi-folded supporting elements. Two ways of production can be distinguished. First, the simpler so-called wrapped profile with material removal on just one side and second, the zigzag profile with processing on both surfaces. The profiles are adaptable to almost any every construction principle with elongated load transfer and also slab-like elements are producible. As seen in Figure 8, the successful application of folded cardboard sandwiches as load-bearing elements was proven in a two-year evaluation between July 2014 and July 2016.

Despite all the advantages, some problems should not go unmentioned. Not all types of sandwich board can be folded in the manner described herein. The core material must be compressible in direction of the folding force effect. The surface material should be elastic enough to bear the bending due to folding without breaking. Future research should explore other materials that provide similar material properties like corrugated cardboard panels. The maximum dimensions of the described sandwich panels are the reason for limitations in the length and profile size of the folded parts. Additions by overlapping are possible but that increases the production costs. The double material profiles as well as the ribbed slab and the sandwich ceiling require a paper removal on both surfaces. This should not pose a big problem with using modern CNC machines, however, it also increases the production costs. Finally, also the basic properties of the paper material should be considered. Its sensitivity against water or fire remains even though the facing material is resistant against such influences. This still causes problems in building approval of such components.

6. CONCLUSION AND OUTLOOK

I reported the efficient design and production of load-bearing components that are made of folded corrugated cardboard panels. A simple design strategy allows the easy planning and the fast production. An evolutionary step could be the production without milling. In this case the core material of the sandwich is covered partly in the production process. An advanced research field could be the prefabrication of large-scale walls and ceilings for architectural projects. Here, the folded sandwich components can serve as core material as well as stiffening components. Hybrid constructions with wooden parts are also conceivable in this context. All in all, the method enhances the capability of corrugated cardboard sandwiches and offers a new way of construction to the architectural sector.

REFERENCES

- [1] Abbès, B.; Guo Y.Q. (2009): Analytic homogenization for torsion of orthotropic sandwich plates: Application to corrugated cardboard, in: *Composite Structures* 2010/92, p. 699-706, Elsevier Publishing.
- [2] Ayan, Ö. (2009): Cardboard in architectural technology and structural engineering: A Conceptual approach to cardboard buildings in architecture, doctoral thesis, ETH Zürich, Switzerland.
- [3] cf.: Cardboard building at West Borough Primary School by Cottrell & Vermeulen Architecture, <http://www.cv-arch.co.uk>, retrieved: 23.09.16.
- [4] cf.: <http://architizer.com/projects/opensource-cardboard>, retrieved: 23.09.16.
- [5] cf.: Thermal insulation made of corrugated cardboard - GAP facade by GAP solution GMBH, <http://www.gap-solutions.at>, retrieved: 23.09.16.
- [6] Eekhout, M. (2008): *Cardboard in Architecture* – edited by Mick Eekhout, Amsterdam, IOS Press.
- [7] Hilmar, W. (1996): Falten im Leichtbau, in: *ARCH+ 131*, p. 82-95 Aachen, Arch+ Verlag GmbH.
- [8] Jackson, P. (2005): Falten und Entfalten in Kunst und Design, in: *Masters of Origami at Hangar 7 – Die Vielfalt der Falte Kunst*, Berlin, Hatje Cantz Verlag.
- [9] Jackson, P. (2011): *Folding Techniques for Designers – from Sheet to Form*, London, King Publishing.
- [10] Lu, T.J.; Chen, C. and Zhu, G. (2001): Compressive Behaviour of Corrugated Board Panels, in: *Journal of Composite Materials* 2001/35, p. 2098-2126, Sage Publishing.
- [11] Miura, K.; Sakamaki, M. (1996): Mathematik der Form, in: *ARCH+ 131*, p. 22-26, Aachen, Arch+ Verlag GmbH.
- [12] Nordstrand, T. (2003): Basic testing and strength design of corrugated board and containers, doctoral thesis, Lund University, Lund.
- [13] Pohl, A. (2009): Strengthened corrugated paper honeycomb for application in structural elements, doctoral thesis, ETH Zürich, Zürich.
- [14] Schütz, S. (2015): Von der Faser zum Haus - Das Potential von gefalteten Wabenplatten aus Papierwerkstoffen in ihrer architektonischen Anwendung, doctoral thesis, Bauhaus-Universität Weimar, Weimar.
- [15] Tian, Y.S.; Lu, T.J. (2005): Optimal design of compression corrugated panels, in: *Thin Walled Structures* 2005/43, p. 477-498, Elsevier Publishing.
- [16] Zeller, F. (2013): *Papier – Versuche zwischen Geometrie und Spiel*, 6th ed., Bern, Haupt Verlag.

Multistorey Frame System for Energy Efficient Buildings

Petr HAJEK^a, Ctislav FIALA^b, Vlastimil BILEK^c, Michal ZENISEK^d, Jan RUZICKA^e, Jaroslav HEJL^f, Lenka LAIBLOVA^g, Martin VOLF^h

^a Czech Technical University in Prague, Faculty of Civil Engineering, Czech Republic, petr.hajek@fsv.cvut.cz

^b Czech Technical University in Prague, Faculty of Civil Engineering, Czech Republic, ctislav.fiala@fsv.cvut.cz

^c ZPSV a.s., Uhersky Ostroh, Czech Republic, bilek@zpsv.cz

^d Czech Technical University in Prague, Faculty of Civil Engineering, Czech Republic, michal.zenisek@fsv.cvut.cz

^e Czech Technical University in Prague, Faculty of Civil Engineering, Czech Republic, jan.ruzicka@cvut.cz

^f Czech Technical University in Prague, Faculty of Civil Engineering, Czech Republic, hejl@askprojekt.cz

^g Czech Technical University in Prague, Faculty of Civil Engineering, Czech Republic, lenka.laiblova@fsv.cvut.cz

^h Czech Technical University in Prague, University Center for Energy Efficient Buildings, Czech Republic, martin.volf@cvut.cz

ABSTRACT

A combination of concrete and timber elements can lead to advantageous structural and environmental solutions. Especially in the case of multi-storey buildings concrete floor structures could significantly improve acoustic and fire safety building performance and at the same time they can ensure horizontally rigid floor structures from the perspective of spatial rigidity. Subtle HPC precast frame thus represents effective alternative to timber-based framework by providing possibility to build higher buildings, while allowing the other structures to be based on wood. Technical parameters of HPC structural frame and environmental qualities connected with the higher use of renewable materials can result in construction of multi-storey energy efficient buildings.

Results of long-term research project and development of a new optimized precast construction system based on high performance concrete is presented. The system is particularly aimed for building construction in passive or zero-energy standard. High performance concrete used for the superstructure enables lowering of concrete consumption up to 50 - 70%. Developed structural concepts have been proved by theoretical and experimental results. The paper presents in more detail a construction of the experimental RC frame and a LCA study of developed subtle HPC frame, which is compared with standard solution.

Keywords: high performance concrete, precast frame, wooden envelope

1. INTRODUCTION

Nowadays, there is an increasing tendency to build multistorey wooden based buildings usually from CLT (cross laminated timber) panels or using timber frames. However, there are limitations in a space rigidity of multistorey timber structures, in acoustic performance of timber floor structures and in a fire safety. The combination of light concrete frame with concrete floor structure and wooden based other parts of structure (envelope, partitions, roof structure) could solve some of these problems. Significant advantages of subtle elements are material and energy savings during production, transport, manipulation and construction on building site. Accumulative properties of RC structures can contribute to thermal stability of buildings indoor environment. This will mainly help buildings that need cooling in summer. On the other hand, concrete frame provides stronger load bearing structure in comparison to timber structure. In the same time such composite structures will be more resilient and better prepared for extreme situations in a changing environment.

Figure 1 presents a concept of concrete subtle frame for construction of houses in passive energy standard. The concept is based on a combination of subtle load bearing HPC frame with building envelope and other parts like partitions, roof structure etc. mainly from wood or other biobased materials.

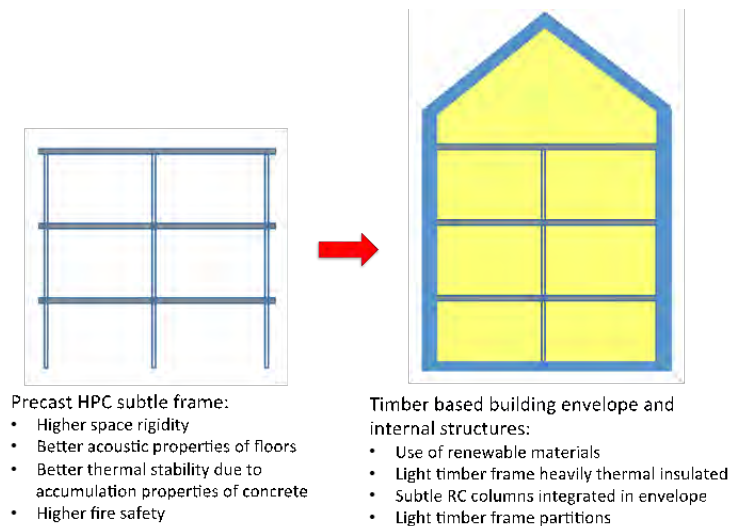

Figure 1: Concept of structural system for multi-storey energy efficient buildings from precast HPC frame and timber based other structural parts

Developed structural frame from high performance concrete (HPC) is aimed for 2 to 6-storey residential and civil buildings (health and social care, education, temporary housing, administration). The combination of timber and concrete can enhance utilization of renewable structural materials also for construction of larger buildings. Concrete floor structures offer advantages in comparison with whole timber structures in the field of acoustics, fire safety, accumulation of thermal energy and spatial rigidity.

2. CONCEPT OF EXPERIMENTAL OSEEB RC FRAME

Experimental structure has been built within the third year of the research project TA03010501: “Optimized subtle frame for energy effective buildings” (OSEEB). The aim of the project was to develop a universal and variable load bearing structure for energy efficient buildings that meets the criteria of sustainable development. The concept of load bearing structure is based on a subtle HPC precast system. The principal aim was to minimize the amount of used material by lightening of the structure using shape optimization of structural elements from high performance concrete. Because of lower self weight of the lighter structure a load on footing bottom, demand on transport and consequent environmental impacts are decreased. Ground plan of the experimental load bearing frame is apparent from Figure 2.

Structural details of the OSEEB system are designed to minimize thermal bridges and to enable maximal variability of ground plan, structural height and full height etc.

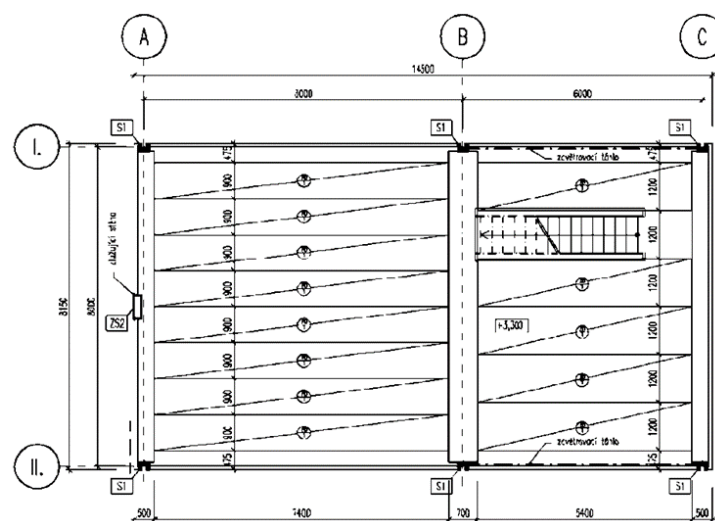

Figure 2: Ground plan of the experimental OSEEB frame

Implementation of experimental frame should show technological consequences and will enable testing of individual structural components on real structure. Structural elements are slab girders and floor panels, subtle multi storey columns, and foundations structural elements – precast pocket footings (alternatively from recycled concrete) and foundation sills. Development of the structural components was accomplished within previous years of the research project. Optimization process resulted in final shapes of cross sections, methods of lightening of structural elements and their mutual connection systems. Experimental structure will be also used for monitoring of structural performance under the long term load.

2.1 Description of experimental OSEEB frame structure

Precast experimental OSEEB frame is designed as two storeys, basementless structure with ground plans dimensions of 8.15 x 14.5m with pitched roof from timber beams. Maximal height of the ridge is 9.3m above the terrain level, the structural height of the 1st floor is 3.8m, the structural height of the 2nd floor is 2.9m and the height of the attic is 2.9m.

Load bearing structure has two bays with axial columns distance of 8 x 8m and 8 x 6m. Main vertical load bearing elements are two storeys C shaped columns from high performance fibre concrete with cross section of 180 x 250mm; main horizontal load bearing elements are prestressed slab girders with notches for embedding of floor panels. Girders and floor panels have equal height of 300 mm in order to create flat soffit and free plan in larger spanned floor structures. Floor panels are lightened by lightening elements from secondary raw materials (recycled material Stered), alternatively from light weight building materials (liapor concrete). Floor panels are from HPC with standard reinforcement or prestressed. For larger spans there is the option of cross fastening of floor slab by post tensioning method. Cables for post tensioning are anchored into side girders. HPC columns are designed from concrete class FC70/85, steel B500B, alternatively B550B, girders, bracings and floor panels from concrete class minimally FC60/75 reinforced by tensioned cables Y1860S7 with diameter of 15.7mm and reinforcement B500B. Columns are embedded into footings from recycled concrete with dimensions of 1.8 x 1.8m and 2.0 x 2.0m and height of 1.05m. Girders are connected to columns by Peikko corbels, longitudinal side beams (bracings) are mounted on girders notch and connected by shear spikes in order to ensure horizontal rigidity of individual components connections.

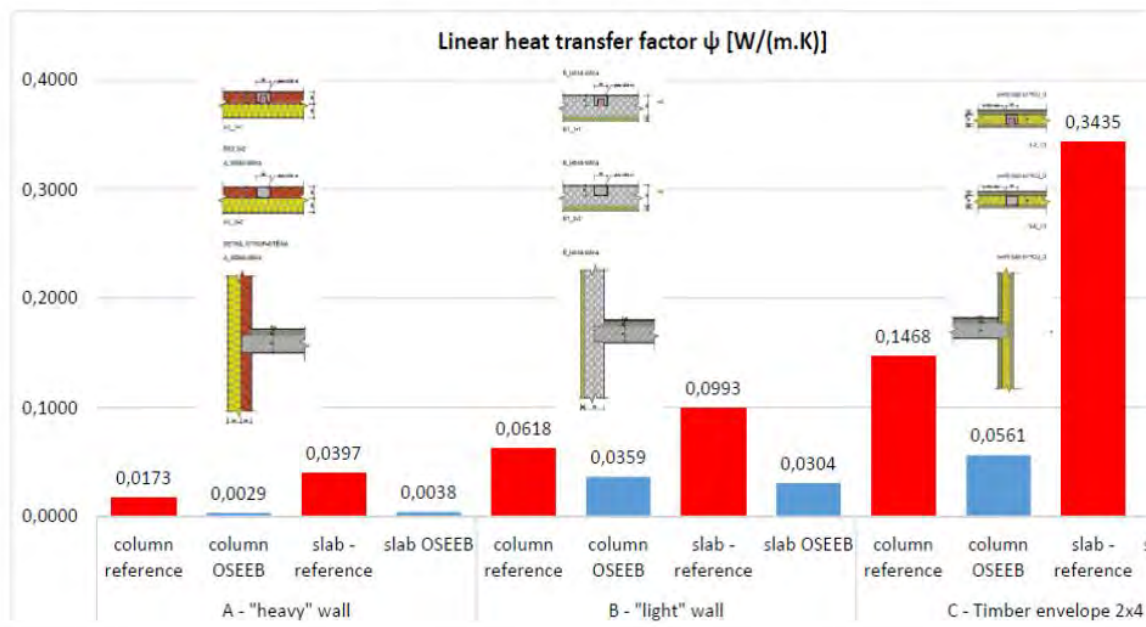

Figure 3: Comparison of linear heat transfer factor ψ for assessed variants of building envelope

2.2 Energy optimization of buildings using OSEEB

The aim of building energy optimization of OSEEB was to eliminate risks of thermal bridges, to minimize heat transfer of main structural parts placed in the building envelope and structural solution enabling continuous layer for air tight and water vapour barrier. Following structural details have been optimized: (i) Columns in the building envelope, (ii) Horizontal beams and slab, (iii) Column footing. Three material variants of building envelope as ceramic blocs with ETICS, foamed concrete with ETICS and timber building envelope based on 2 x 4 system have been taken into account. All variants were designed for the same thermal performance of $U = 0.15 \text{ W/m}^2\text{K}$ meeting requirements for low energy and passive buildings in the Czech conditions.

Linear heat transfer factor ψ [W/m.K] was determined according to Czech standards for selected structural variants and compared to common design and size of columns (300 x 300mm) and beams (250 x 700mm). Minimal columns cross-sections and flat horizontal beams of the same height as the slab enable integration into building envelope and minimizing of thermal bridges. Inner side of the column in the part designed as “C” profile is filled with thermal insulation, which again helps to reduce thermal bridges. The results of optimization and comparison to common solution are shown in Figure 3. Significant reduction of thermal bridges is obvious.

3. CONSTRUCTION OF EXPERIMENTAL OSEEB FRAME

Experimental structure OSEEB – Optimized subtle frame for energy effective buildings – was built in UCEEB (University Centre for Energy Efficient Building, CTU in Prague) in Bustehrad area. Precast structural elements of OSEEB frame were produced in company ŽPSV at the end of the year 2015. The company AZS 98 provided precast pocket footings and foundation sills from recycled concrete and company Peikko delivered connecting corbels. The erection of frame started after land remediation by placing the precast pocket footings in February 2016 (Figure 2), installation of above-ground parts of the structure took place during March and April 2016, see Figure 4 to 9. Firstly, subtle two-storey columns were assembled followed by stiffening wall and foundation sills (Figure 5). Subsequently, flat girders and longitudinal stiffeners were fitted to columns by Peikko’s corbels (Figure 6). After temporary securing of girders against torsion, the floor panels were installed - prestressed elements per module 8m and non-prestressed panels per module 6m. (Figure 8).



Figure 4: Precast pocket footing



Figure 5: Assembling of subtle columns, stiffening wall and foundation sills



Figure 6: Structure of the 1st floor



Figure 7: Assembling of transverse bracing on girder fitted on Peikko's corbel



Figure 8: Structure of experimental frame with unfinished ceiling above 2nd floor



Figure 9: Finished load bearing structure of experimental OSEEB frame

Peripheral girders at ceiling levels provide rigidity of the frame in longitudinal and transverse direction. Girders are connected to columns by Peikko corbels and by shear spikes in order to ensure force transmission in the plane of the ceiling from all load combinations. After assembling of floor structures, the shear spikes and joints between panels and girders were sealed by concrete grout SikaGrout. Experimental OSEEB frame structure was finished in April 2016 (Figure 9). In the first stage, the both floor structures were implemented as laterally non-prestressed, followed by a first static load test. After performing load test, the floor structure of the span 8 x 8m above 2nd floor was additionally prestressed and static load test was repeated.

4. LIFE CYCLE ASSESSEMENT OF SUBTLE FRAME

A set of environmental information data on concrete components and related processes has been collected and determined within the research performed at the Faculty of Civil Engineering, Department of Building Structures of the Czech Technical University in Prague. These data are based on regionally available materials and are based on source data provided by companies producing and/or selling their products mainly on the Czech market. The data have been stored and organized in CONCRETE LCA^{Tool 3.0 CZ}.

A simple two-storey experimental building with a ground plan of 8.15 x 14.5m was chosen for life cycle analysis (LCA) study covering environmental assessment and comparison of two selected concrete frame structure alternatives (Figure 2 and 9). The house is designed with a very universal layout enabling design of many feasible structural and material alternatives.

4.1. Description of concrete frame structures alternatives

The complex (LCA) was performed for two various RC frame structures that were designed for afore mentioned building. This analysis focuses primarily on load-bearing structures and does not cover building envelope, partitions and surface finishes. The analysis covers transport of the raw material to the prefa plant, concrete production, transport of prefabricated elements to the building site, demolition and deposition of the concrete at the end of the **structures lifespan. The RC frame structure's alternatives are as follows:**

- V1 reference precast RC frame structure from concrete C30/37 and C40/50 with columns dimensions of 400 x 400mm, girders 550 x 650mm, stiffeners 190 x 600 mm and hollow core prestressed panels with thickness of 265 mm.
- V2 subtle HPC frame structure from concrete HPC70/85 with subtle columns as shown in Figure 6, girders dimensions of 500 x 300mm, 700 x 300mm, stiffeners 470 x 300mm and floor structure panels as described in chapter 2.1. HPC for floor panels and columns is reinforced by dispersed steel fibers (1% vol.).

4.2. Inventory of input data and LCA results

In the following analysis the expected life span of frame structures was considered for all alternatives equally 100 years. Construction life phase covers: amount of used concrete (precast elements), amount of individual components needed for concrete production, amount of the reinforcement divided according to a type of reinforcement and related transport to construction site. End of life phase calculates with the amount of waste from demolition, amount of demountable components that can be reused and related transport.

Aggregated impact data for specific life cycle phases construction are presented for primary raw materials consumption and primary energy consumption in Figure 10. It is evident that environmental impacts in the construction phase are significantly higher in comparison with end of life phase. In Figure 10 shows the influence of individual components such as cement, aggregate, water, admixtures etc. on primary energy consumption. It is apparent that main environmental impact is due to cement and steel reinforcement. Transport, construction process, aggregates and admixtures cause minor effect.

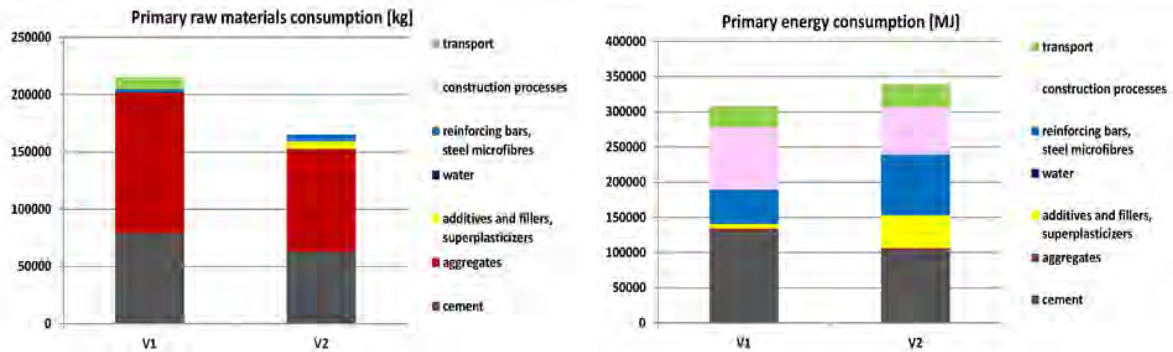

Figure 10: Aggregated data - Primary raw materials and primary energy consumption

Figure 11 presents the final comparison of assessed alternatives. 100% is represented by V1 (precast RC frame structure from C30/37 and C40/50). The environmental values of both variants of frame are comparable in primary energy consumption and emissions criteria. In total 20% of raw material consumption and 11% water consumption can be saved by utilizing V2 alternative, structure as optimized subtle HPC frame.

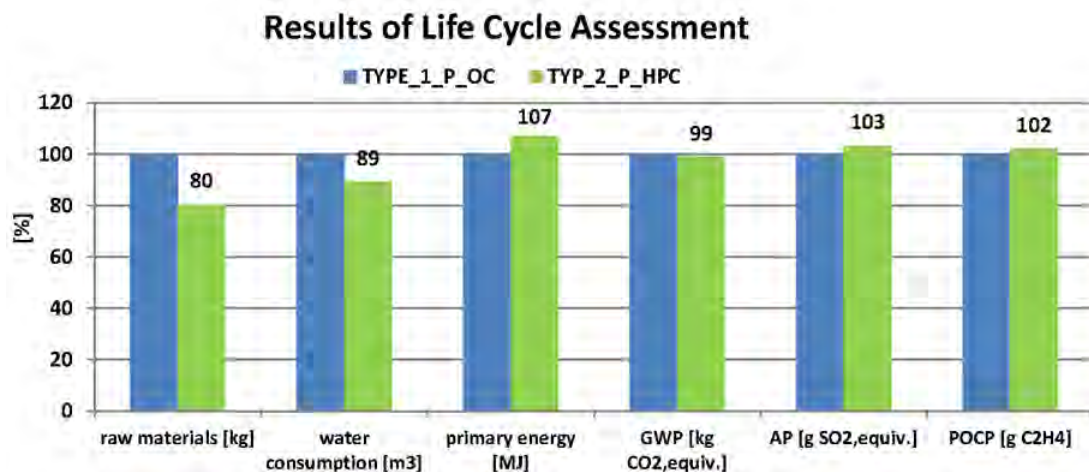

Figure 11: Aggregated data of assessed variants frame (GWP – Global warming potential, AP – Acidification potential, POCP – Photochemical ozone creation potential)

5. CONCLUSION

Two alternatives of RC frame structures have been analysed and compared. The results of analysis proved expectation that subtle HPC frame structure is the environmental friendly alternative from two assessed alternatives. The results show that the high quality of mechanical and environmental performance of new silicate composites creates the potential for wider application of High Performance Concrete in building construction in the future. The further advantage of subtle HPC frame can appear in areas with regulated size of built-up area (e.g. in dense inhabited town areas). With higher demands on thermal insulation parameters of building envelopes increases also their thickness. The possible integration of subtle columns in building envelope can thus save valued inner space. The construction of an experimental frame validates the feasibility of the project and production technology of elements and installation of frame structure.

ACKNOWLEDGEMENT

This outcome has been achieved with the financial support of the research project granted by Technology Agency of the Czech Republic grant TA03010501. Authors would like also to express thanks for all support provided by **companies ŽPSV a.s., Peikko a.s. and AZS 98, s.r.o.**

REFERENCES

- [1] Fiala, C. (2011) Optimalizace betonových konstrukcí v environmentálních souvislostech, Publisher of Czech Technical University, p. 102, ISBN 978-80-01-04663
- [2] Hajek, P., Fiala, C. and Lupisek, A. (2016) High Performance Concrete for Environmentally Efficient Building Structures, Key Engineering Materials ISSN: 1662-9795, Vol. 691, pp 272-284, Trans Tech Publications

Session 2.3 Advanced Building Elements

Remarkable Energy Retrofit for Existing Buildings by Advanced Fan Technology: Electronically Commutated Motor Plug Fan

Isaac TSANG Siu-chung^a, Tony LEE^b, LAM Tsz-kin^c, Andrew MAK^d, YAO Ting^e

^a Swire Properties Ltd., Hong Kong SAR, isaactsang@swireproperties.com

^b Swire Properties Ltd., Hong Kong SAR, tonylee@swireproperties.com

^c Swire Properties Ltd., Hong Kong SAR, tklam@swireproperties.com

^d Trane Hong Kong, Hong Kong SAR, andrew.mak@jec.com

^e Swire Properties Ltd., Hong Kong SAR, yaoting@swireproperties.com

ABSTRACT

In Hong Kong, as of January 2013, 75.8% of commercial buildings and 90% of composite buildings were built before 1995 (ESP, 2015). The opportunities of energy consumption reduction for old existing buildings cannot be neglected to achieve deep energy saving target for Hong Kong by 2025 as per Energy Saving Plan launched by Hong Kong Special Administrative Region Environment Bureau. This paper presents a case study of adopting electronically commutated (EC) motor plug fan technology for replacing belt driven fan for AHU in an existing building.

EC motor plug fan technology offers high operation efficiency in HVAC air side system and be widely adopted in new building development in recent years. This advanced technology however was not common in existing building retrofit due to some hurdles such as initial cost, payback, spacing, installation approach and timing. This case study aimed to investigate the feasibility as well as performance of only replacing an old belt driven fan with external variable frequency drive (VFD) control by 4 nos. of EC motor plug fan with installed controlled electronics, but not involving the other operable components inside the air handling unit. It was estimated that more than 40% of fan energy reduction could be achieved, based on the hourly fan operation data via BMS, onsite fan power measurement and testing and commissioning (T&C) results of new fan installation. The life cycle cost and payback were also considered thus providing a full picture of this HVAC airside retrofit.

Keywords: existing building retrofit, electronically commutated motor plug fan, energy saving

1. INTRODUCTION

Fan uses nearly 40% of all electricity in HVAC systems of a commercial office building (Yik et al., 1998). Thus, adopting high efficiency fan technology is a good opportunity to achieve energy saving target for building. Recently, EC motor plug fan is one of the most effective fan improvement technologies available. There are some different types of EC motor plug fan available in the market, the most common one is a backward curved centrifugal impeller directly mounted on a brushless direct current (DC) motor. Its variable speed control can be achieved by varying the DC voltage delivered to the motor. This fan technology has significant advantage in terms of energy efficiency compared to alternating current (AC) motor belt driven fan, which is one of most typical HVAC applications in existing buildings, required on-going maintenance and frequent replacement of belts, pulleys and bearings. Failure to do so will lead to increased inefficiencies and motor and bearing failures which increase cost even further. For the purpose of improving energy efficiency and operation performance, this case study investigates the feasibility and effectiveness of adopting EC motor plug fans for replacing belt driven fan in an existing office building.

2. CASE STUDY

In this case study, a typical office floor (area: 1490 m²) of a 22-year-old Hong Kong Island building was selected for fan retrofit. Air-conditioning system of variable air volume (VAV) powered by air handling unit (AHU) is adopted in this office floor. Static pressure control logic is applied for varying supply air volume. An old AHU belt driven fan of rated power 22 kW with external variable-frequency drive (VFD) control was replaced by 4 nos. of EC motor plug fan of rated power 5.05 kW (Figure 1). Table 1 lists the detail technical information of fans.



Figure 1: (a) Belt driven fan and (b) EC motor plug fan

	Rotation Speed Control	Rated Input Power (kW)	Design Air Flow Rate (l/s)	Design Static Pressure (Pa)
Belt Driven Fan	External VFD (Previously set 25Hz to 45Hz)	22	10500	1125
EC Motor Plug Fans	Embedded rotation speed control (Set max. 85% speed)	20.2 (4 × 5.05 kW)	11200 (4 × 2800 l/s)	1200

Table 1: Technical information of fans

The retrofit work was commenced in early November of 2015. The old fan motor, fan blower, and its associated supporting frame were removed. The 4 nos. of new backward curved centrifugal EC motor plug fan were installed with new supporting steel frame, and an electrical panel for power supply to 4 nos. of fan was newly installed. The original building management system (BMS) control signal (0-10V) was split into 4 nos. of signal with 4 wires connecting to the new fans. Synchronized rotation speed operation was adopted in new fan system. Differential pressure sensor for air flow measurement and Modbus connection for high level interfacing between the new fans and existing BMS were installed for this case study, which provide useful operation data for fan performance analyses. The maximum rotation speed control of 85% of full speed was set for new fan system to deal with the predicted cooling demand according to the previous operation experience.

To facilitate the performance analyses, the portable power analyser and sound pressure level meter were utilised for the pre-retrofit on-site measurements in July and August of 2015 and post-retrofit new EC motor plug fans T&C in early 2016. Operation data of belt driven fan (pre-retrofit) and new EC motor plug fan (post-retrofit) which includes AHU air flow rate, fan input power, VFD control frequency and fan rotation speed were collected from BMS. Different data sources are summarized in Table 2.

	Data Collected by BMS (Recorded every 15 minutes)	Data Measured by Portable Measurement Device (Measured every 5 minutes)
Belt Driven Fan	<ul style="list-style-type: none"> AHU air flow rate VFD control frequency 	<ul style="list-style-type: none"> Fan input power and Harmonics (by power analyser) Noise (by sound pressure level meter)
EC Motor Plug Fans	<ul style="list-style-type: none"> AHU air flow rate Fan rotation speed Fan input power 	<ul style="list-style-type: none"> Harmonics (by power analyser) Noise (by sound pressure level meter)

Table 2: Data sources

3. RESULTS AND DISCUSSION

Performance of belt driven fan and EC motor plug fans are compared in three aspects: electricity consumption, Harmonics and noise. Payback analysis is also conducted in this part.

3.1. Electricity consumption comparison

Belt driven fan input power and VFD control frequency were measured on-site and collected from BMS before the fan retrofit. Control setting from 25Hz to 45Hz was adopted to suit the cooling demand of office floor. Figure 2 displays the relationship between fan input power and VFD control frequency. Electricity consumption of belt driven fan in July and August of 2015 is calculated by this equation with the BMS data of VFD control frequency. Compared with the electricity consumption of belt driven fan in July and August of 2015, electricity consumption of EC motor plug fan measured in July and August of 2016 is approximately 40% lower (Table 3) without considering the variations of weather condition and user demand between year 2015 and 2016.

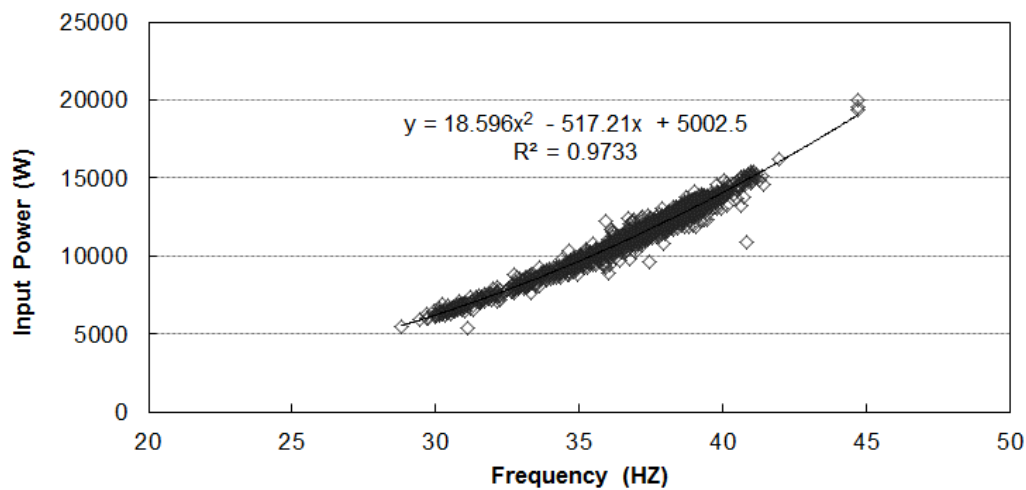

Figure 2: Belt driven fan input power vs frequency

Belt Driven Fan Electricity Consumption		EC Motor Plug Fan Electricity Consumption		Electricity Reduction after Retrofit
1 July 2015 to 31 July 2015	3595.99 kWh	1 July 2016 to 31 July 2016	2093.54 kWh	41.78%
1 August 2015 to 31 August 2015	3213.43 kWh	1 August 2016 to 31 August 2016	1936.71 kWh	39.73%
Total	6829.42 kWh	Total	4030.25 kWh	40.81%

Table 3: Energy consumption of fans

Based on data measured and collected from BMS in July and August of 2016, relationship between input power and air flow rate of EC motor plug fans is identified as shown in Figure 3. Annual consumption of belt driven fan and EC motor plug fans based on year 2015 operation profile were calculated by regression equations shown in Figures 2 and 3 respectively. Figure 4 shows the comparison result. It can be observed that, with the same quantity of air supply, EC motor plug fans require less energy in every month. This is mainly contributed by higher efficiency of EC motor plug fan. For belt driven fan with VFD, efficiency of VFD and belt drive can significantly influence the total fan efficiency. The VFD losses are typically 2% to 5% at the nominal torque and speed, and 10% to 30% at 25% torque and speed. The efficiency of a belt drive is 90% at medium power application (3 – 15 kW), but it can easily slip to 60% to 70% if the gear adjustment is incorrect (Breljih, 2012). For EC motor plug fan, the DC rotation speed control technology can maintain a relatively high efficiency from the rotation speed of 10% to 100%. The direct mounted impeller design can offer almost 100% of efficiency in transmission from motor to impeller.

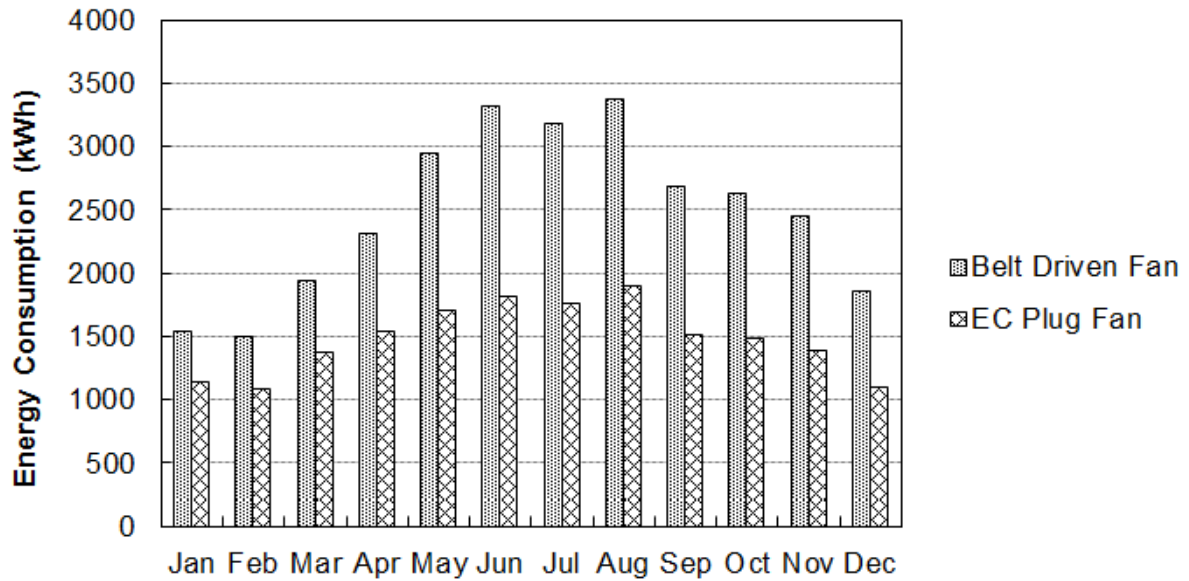

Figure 3: EC motor plug fan input power vs air flow rate

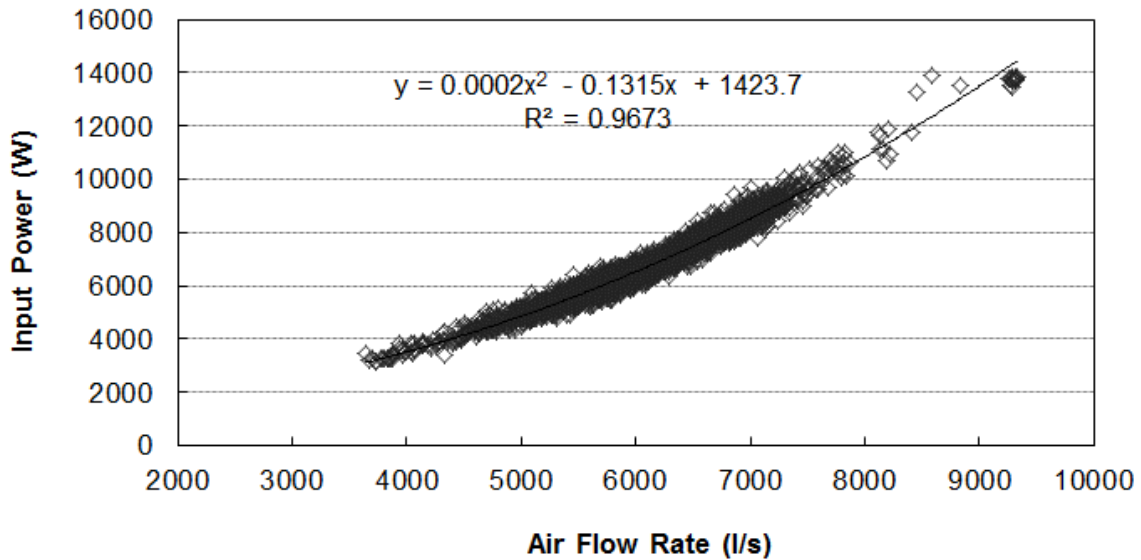

Figure 4: Energy consumption comparison: Belt driven fan vs EC motor plug fan

Based on year 2015 operation profile, electricity consumption estimation of fans in every month is summarised in Table 4. Adopting EC motor plug fans could save potential 40% of belt driven fan electricity consumption annually. This estimation assumes the both fan technologies operating under an identical real case operation profile (year 2015). These electricity saving estimations for July and August are slightly higher than that energy saving measurements identified in shown in Table 3 for approximate 4%.

2015	Belt Driven Fan (kWh)	EC Motor Plug Fan (kWh)	Saving
Jan	1534	1131	26.3%
Feb	1490	1089	26.9%
Mar	1939	1371	29.3%
Apr	2307	1541	33.2%
May	2944	1700	42.2%
Jun	3313	1809	45.4%
Jul	3175	1756	44.7%
Aug	3375	1891	44.0%
Sep	2679	1510	43.6%
Oct	2623	1486	43.3%
Nov	2455	1379	43.8%
Dec	1849	1101	40.5%
Total	29537	17766	40.15%

Table 4: Energy consumption of fans

3.2. Harmonics comparison

Harmonics induced by belt driven fan with VFD and EC motor plug fan were measured by portable power analyser before and after the retrofit. The measured variation range of current and total harmonic distortion (THD) for different fans are shown in Figure 5 and Figure 6. As Code of Practice for Energy Efficiency of Building Services Installation suggested when the design THD of current for a circuit at or below 40 A, THD should be lower than 20% (BEC, 2015). Obviously THD of current for the measured three-phase circuit connecting to both belt driven fan and EC motor plug fan is out of recommended range. It is thus suggested to install a harmonic filtering device to mitigate the THD when VFD or EC motor plug fan is adopted. For the fifth harmonic which may cause a counter electromotive force in motors acting in the opposite direction of rotation, current distortion induced by EC motor plug fans maintains 35% or below when the motor operates under the loading of 50% or less (single phase current of 15A or less). This conditionally meet the requirement of Code of Practice for Energy Efficiency of Building Services Installation that the maximum fifth harmonic current distortion at the VSD input terminals during normal operation within the variable speed range is less than 35% (BEC, 2015), given condition that the normal operation is larger than 50% of design loading. Harmonic filtering device is again recommended for low loading operation.

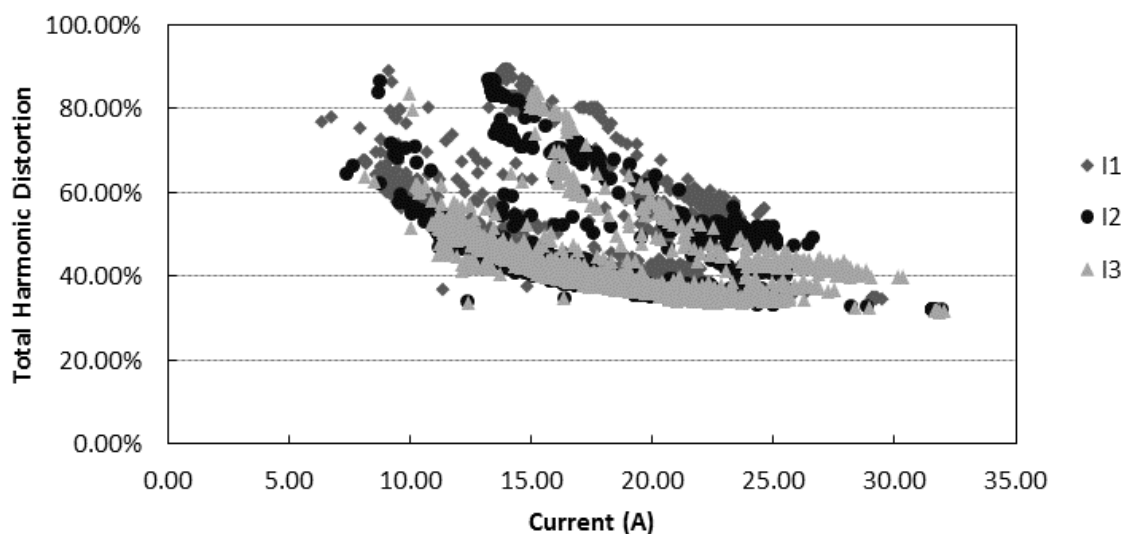

Figure 5: Belt driven fan with VFD Total harmonic distortion of current

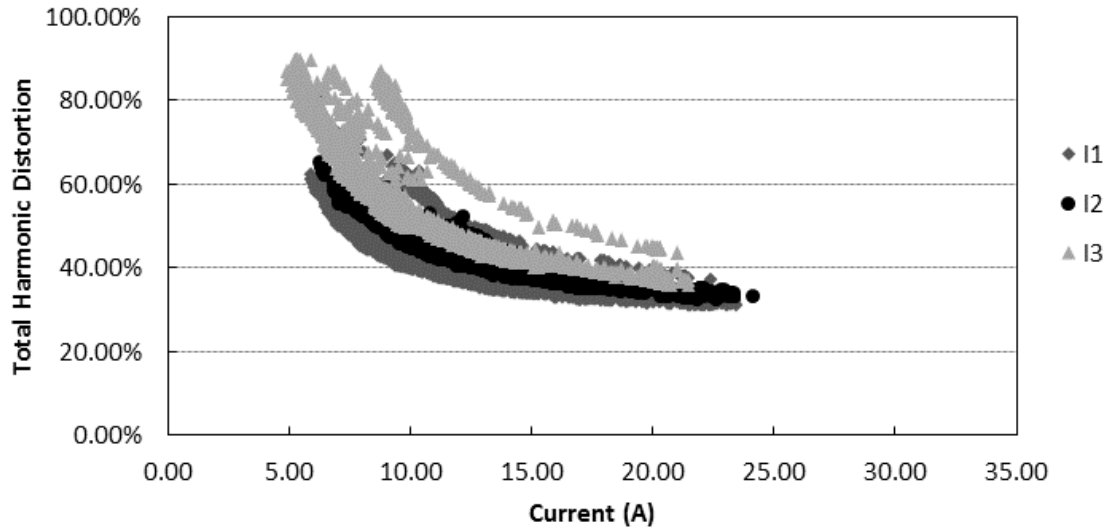

Figure 6: EC motor plug fan total harmonic distortion of current

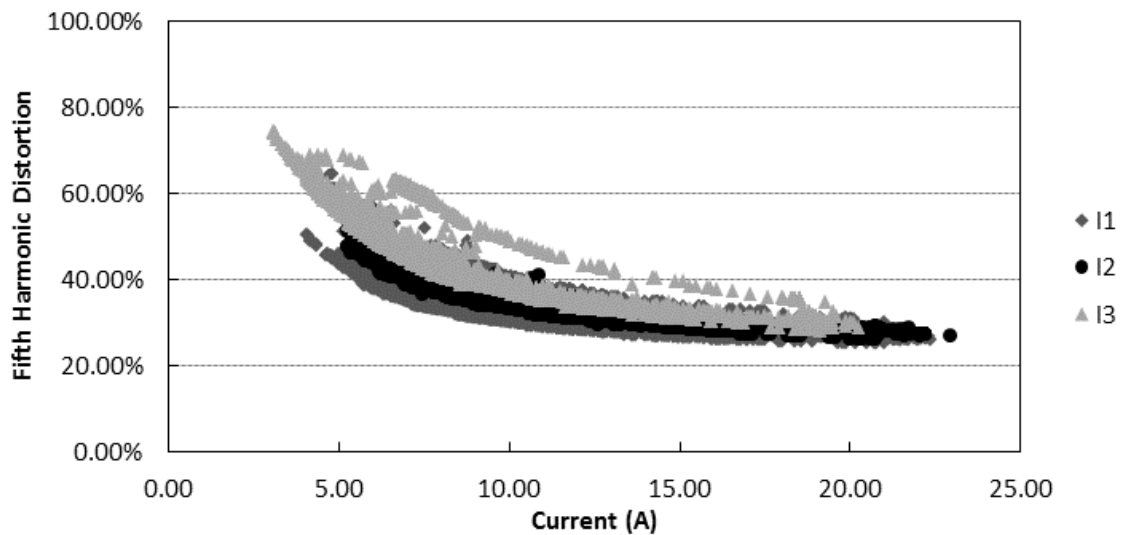

Figure 7: Fifth harmonic current distortion of EC motor plug fan

3.3. Noise test

To ensure the operation of EC motor plug fans will not affect office working environment, noise tests were conducted before and after the retrofit. Testing results are shown in Table 6. The highest sound pressure level under the normal air outlet was measured at a test point, which is located under one of the air outlets nearest to the AHU. According to BEAM plus Existing Building (version 1.2, 2012), NC 40 is suggested for office type premises. For this AHU, air flow rate demand is in the range of 2500 - 8000 l/s during a year. Thus, the sound pressure level of office space can meet the requirement in most time of the year with EC motor plug fan.

	Belt Driven Fan			EC Motor Plug Fan		
Frequency	45Hz	30Hz	Off	-	-	-
Rotation Speed	-	-	-	2444rpm (94.0%)	1850rpm (71.2%)	1235rpm (47.5%)
Air Flow Generated	Approx. 8000 l/s	Approx. 4800 l/s	-	Approx. 9900 l/s	Approx. 7000 l/s	Approx. 2500 l/s
dB(A)						
Inside AHU Room (1m away from inlet)	71	62	48	74	71	50
Worst Case Test Point	46	41	37	48	45	37

Table 6a: Testing results

	Octave Band Center Frequency (Hz)								Noise Criterion
	63	125	250	500	1000	2000	4000	8000	
	Sound Pressure Levels (dB)								
Belt Driven Fan at 45Hz Worst Case Test Pt.	56.3	51.2	47.6	41.5	38.7	38.2	0.0	0.0	NC 40
EC Motor Plug Fans at 2444rpm Worst Case Test Pt.	59.7	55.3	49.1	45.0	41.0	37.0	0.0	0.0	NC 40

Table 6b: Testing results

3.4. Payback analysis

To answer the question whether the EC motor plug fan is worth the investment for building retrofit, a payback analysis was conducted. Table 7 shows the analysis result. Payback period for individual fan retrofit in this case study is relatively long (over 8 years). Weekend/ night-time installation, which aims to minimise the disturbance to office tenant, is also one of the reasons of high initial cost in this particular case. It is expected the cost of retrofit could be reduced by capturing the benefits of economy of scale, while engaging a large scale retrofit work with a significant quantity of fan replacement.

Item	Cost (HKD)
Fan and sensor supply	Approx. 80,000
Removal of belt driven fan	Approx. 20,000
EC plug fan installation	Approx. 80,000
EC plug fan control panel	Approx. 40,000
Test and Commissioning	Approx. 5,000
Total investment	Approx. 225,000
Electrical cost saving per year (1.4 HKD/kWh)	16,685
Maintenance cost saving per year (no belt and bearing replacement)	Approx. 9,000
Simple Payback	8.8 years

Table 7: Payback

4. CONCLUSION

This study investigates the performance and feasibility of adopting EC motor plug fan technology for replacing belt driven fan in an existing office building. It is found that EC motor plug fan can achieve more than 40% energy saving over belt driven fan yearly. Its modular and compact design makes installation easy. Its maintenance cost is lower because it is not necessary to frequently replace belts and bearings. Thus EC motor plug fan could be a good choice for new buildings or existing buildings which targets to achieve high performance in energy efficiency.

ACKNOWLEDGEMENTS

The case study presented in this paper was supported by Swire Properties Limited and Trane Hong Kong. We thank our colleagues who provided insight and expertise that greatly assisted the study.

REFERENCES

- [1] BEAM Society Limited, 2012. BEAM Plus Existing Buildings Version 1.2. [pdf] Hong Kong: BEAM Society Limited. Available at: <<http://www.beamsociety.org.hk/files/download/download-20130724174504.pdf>> [Accessed July 2012].
- [2] Brelih, N., 2012. How to Improve Energy Efficiency of Fans for Air Handling Units. REHVA Journal, 5 – 10.
- [3] Electrical and Mechanical Services Department, 2015. Code of Practice for Energy Efficiency of Building Services Installation. [pdf] Hong Kong: Electrical and Mechanical Service Department. Available at: <http://www.beeo.emsd.gov.hk/en/pee/BEC_2015.pdf> [Accessed 11 December 2015]
- [4] Hong Kong Special Administrative Region Environment Bureau, 2015. ENERGY SAVING PLAN for Hong Kong's Built Environment 2015~2025+. [pdf] Hong Kong: Environment Bureau. Available at: <<http://www.enb.gov.hk/sites/default/files/pdf/EnergySavingPlanEn.pdf>> [Accessed 14 May 2015]
- [5] Yik, W.H., et al., 1998. A Detailed Energy Audit for a Commercial Office Building in Hong Kong. HKIE Transactions, 5(3), 84 – 88.

Low Temperature Radiant Cooling Design and Application in Tropical/ Sub-Tropical Countries

Paul CHAN Yim-Cheong^a

^a Wong & Ouyang (Building Services) Ltd., Hong Kong SAR, cyc@wobse.com

ABSTRACT

Radiant cooling design has been practiced in many countries in the form of chilled beams or chilled ceiling and intakes chilled water temperature at around 16°C to avoid condensation under normal indoor conditions. With such **'high temperature' radiant cooling equipment, it cannot meet the high cooling load requirements** for tropical/sub-tropical countries like Hong Kong making this cooling design not popular in these countries.

Currently with the new emerging technology, a new breed of 'low temperature' radiant cooling products are now available in the market where intake chilled water temperature can be as low as 7°C without condensation problem when working with a special fresh air system. Indoor Environmental Quality (IEQ) is also much enhanced due to **it's silent operation, capable of providing full fresh air to the indoor space, no draft and evenness of temperature distribution.**

With this 'low temperature' design, performance of these radiant cooling products is greatly enhanced to meet cooling demand for hot and humid countries like Hong Kong. Cooling energy saving can be up to 40 % reduction compared to conventional convective air-conditioning design. Fan and pump power can also be greatly reduced since it is basically a passive system with much reduced chilled water flow rate.

This paper will discuss the design, energy performance, indoor Environmental Quality, E&M spatial advantages, **cost, maintenance requirements and applications/ limitations of this range of 'low temperature' radiant cooling system** compared to conventional AC design.

Keywords: adaptable design, energy saving, indoor environmental quality

1. CONVENTIONAL AC DESIGN

Heat transfer can be in the form of conduction, convection, radiation or a combination of all the three forms. In conventional air conditioning design, convection process has generally been adopted in that the air conditioning system absorbs heat by convection or circulating cool air in an indoor space. The cool air rises while it absorbs heat and returns through air ducts or plenum back to the cooling coils of the AC equipment where it is cooled down again before being re-circulated back to the space to repeat the cooling process.

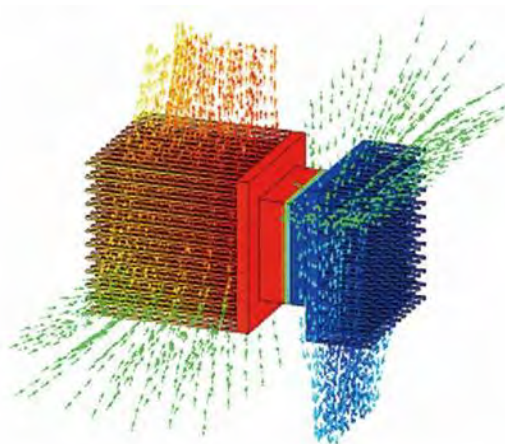

Figure 1: Convection air conditioning design

This convective heat transfer process uses the following equation:

$$Q = h \cdot A \cdot (T_s - T_f)$$

Equation 1

In conventional AC design the heat transfer between different fluids is more commonly expressed as:

$$Q = \dot{m} C_p \cdot (T_1 - T_2)$$

Where, Q = heat transferred per unit time; h_c = convective heat transfer coefficient; A = heat-transfer area of the surface; T_s = temperature of the surface; and T_f , T_2 = temperature of the fluid, \dot{m} is the mass flow rate of the fluid, C_p is the heat capacity of the fluid.

Equation 2

This conventional AC design basically mixes cool supply air with the indoor air to form a cool reservoir of air where heat is absorbed and removed by the cooling process as mentioned above. Since invented by the famous American Dr Willis H Carrier more than 100 years ago, this AC design has widely been adopted by engineers and designers. However, nowadays with increasing demand of better IEQ and conservation of energy, the following disadvantages of this kind of convective AC design attract more and more comments:

- Over 80 % of indoor air has to be re-circulated that means odour, suspended dust particles, air contaminants, bacteria, virus, etc. will also be re-circulated back to the indoor space that deteriorate the air quality or put more reliance on air filter performances/ maintenance hence increasing life cycle cost;
- Air is a poor conductor and the whole indoor space has to be cooled down making this AC design method inherently energy inefficient;
- Large fan power is required to re-circulate and treat the bulk volume of air in the space;
- Very often air draft, uneven distribution of air and temperature, fan/ air borne noise, water dripping are experienced that cause nuisance to occupants;
- Large air handling equipment and air ducts are involved that occupy valuable indoor space.

2. RADIANT COOLING PRINCIPLES AND DESIGN

Radiant cooling however does not depend on circulating cool air but rather it uses differences in surface temperature of objects to effect heat transfer. According to law of radiation, any object with surface temperature above 0-degree K will continuously radiate and absorb heat energy via electromagnetic wave to/ from surrounding in the speed of light.

The convective AC design will also cool down 'surfaces' of the indoor area that will enable 'radiant cooling' to take place but the effect is minimal as heat absorbed through this process is very slow and limited.

We should also note that the media in which this heat transfer process is taking place does not have a direct effect of the process. For example sun ray travels through vacuum and the very cold 'Outer Space' before reaching our body but we still feel the 'intense heat' of the sun. We feel the 'heat' because radiation heat transfer takes place via the difference in surface temperature of the sun (around 5800 K) and our body (around 306 K).

Hence with the application of radiant cooling for indoor space, condition of indoor air can be seen as 'transparent' or it's effect can be considered 'minimal' that gives this design much more rooms for indoor environmental quality (IEQ) control and energy performance improvements.

Radiant heat transfer equation:

$$\text{Stefan-Boltzmann law } Q = e \cdot \sigma \cdot A \cdot (T_r^4 - T_c^4)$$

where, Q = net radiated power; e = emissivity; σ = Stefan Boltzmann constant;

A = radiating area; T_r = temperature of the radiator; T_c = temperature of the surrounding

Equation 3

Emissivity for an ideal radiator (black body) has a value of 1.

Hence Q is proportional to the object surface area, emissivity and difference in surface temperature in the 4th order of power.

In radiant chilled ceiling design, metallic ceiling is preferred for more effective heat transfer. Chilled water temperature down to 7°C can be supplied to the cooling coil of the chilled ceiling panel to enable maximum evenness of ceiling surface temperature, more effective/ responsive performance under various load conditions.

The following criteria and assumptions are adopted in this 'Low Temperature' chilled ceiling design:

- Supply chilled water temperature lowest is 7°C and chilled ceiling surface temperature to be maintained at 2 degree above dew point temperature of the indoor condition at all times (minimum ceiling surface temperature is 16°C)
- Indoor humidity shall be controlled at 55 % RH or below with fresh air at 11°C RH 100 % under an outdoor condition of 33°C RH 90 %
- Fresh air supply rate from 10 l/s per person to 20 l/s per person and indoor CO₂ concentration to be controlled below 800 ppm at all times
- Chilled ceiling area coverage from 40 % to 50 % depending on the building usage, population density, façade design, building orientation, and equipment load
- Fresh air will control the indoor humidity and CO₂ concentration through low pressure air ducts and variable speed drive PA fan unit. Chilled ceiling will handle most of the sensible heat loads including solar, equipment and people load.
- An air tightness test in accordance with CIBSE Technical Memoranda (TM23: 2000) should be carried out to ensure air tightness of the indoor environment

3. LOW TEMPERATURE CHILLED CEILING CONSTRUCTION AND INSTALLATION ARRANGEMENT

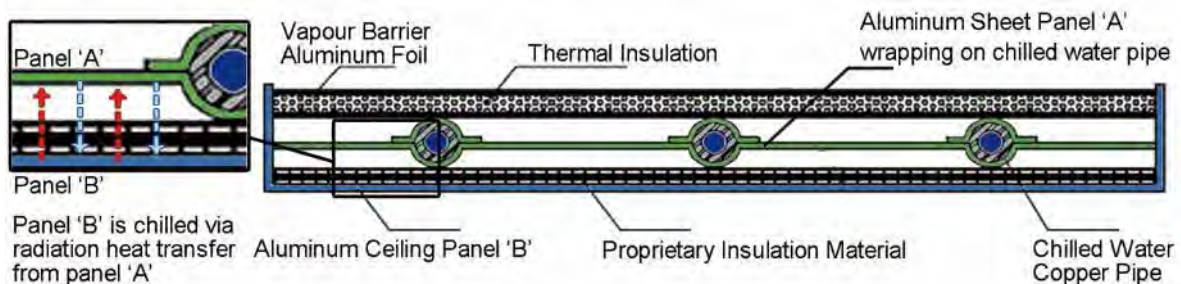

Figure 2: Radiant cooling panel construction detail

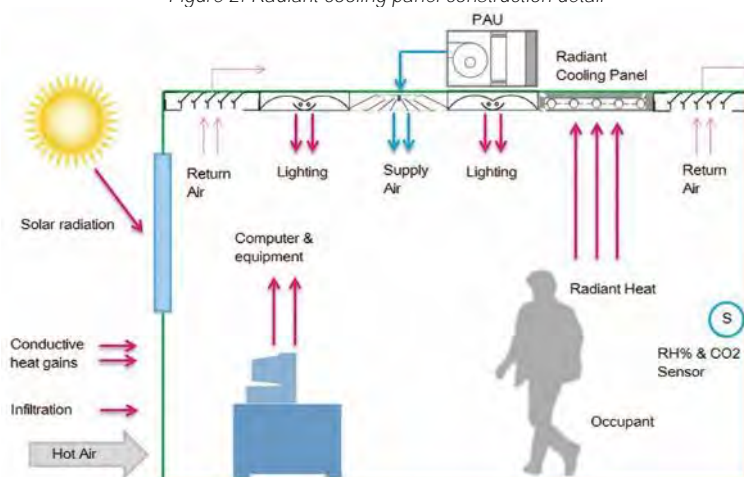
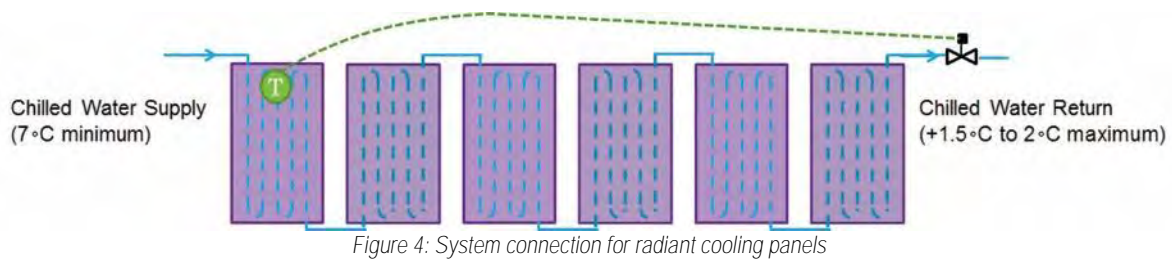

Figure 3: Cooling load components



4. CASE STUDY OF A LOW TEMPERATURE CHILLED CEILING PROJECT IN HONG KONG

This is an existing 30-storeys office building in Hong Kong that was being renovated into a modern office. The existing building constraints are that the floor to floor height is only 3000 mm with flat slab structure and there is no further space on roof to accommodate additional chillers and cooling towers to increase chiller loading.

The client is Hong Kong Hang Seng Bank and its brief is to create a modern work place with flexibility in staff mobility, an excellent IEQ and low energy performance to achieve a minimum LEED 'Gold' certification, a finished ceiling height of 2400 mm and a raised floor for power and IT cabling.

The Total Gross Floor Area of the building is around 30000 m² with population density in future of up to 110 persons / floor (about 7 m²/ person). The existing façade is single glazed with tinted glass where shading coefficient and energy performance are only up to standards some 25 years ago. The existing chiller capacity is 1100 TR and to meet future cooling demand the chiller capacity has to be increased to around 1600 TR using conventional fan coil system.

In view of the low existing floor height, conventional fan coil system can only achieve a maximum of 2200 mm finished ceiling height that is largely below **client's expectation for this modern office. To meet client's brief and to overcome the site constraints, an innovative low temperature chilled ceiling design was proposed.**



Figure 6: Existing structural ceiling level



Figure 7: Original office (Fan coil unit)



Figure 8: New office (Chilled ceiling)

4.1 Design of chilled ceiling and fresh air system

Figure 9 below shows a typical chilled ceiling (in pink colour) layout plan used both in open plan office and meeting rooms. The chilled ceiling panel sizes can be standard 600x600 mm or made in different dimensions and shapes to suit interior designer's requirements.

The system is designed into different chilled ceiling zones to meet different user's requirement. Independent temperature sensors and humidity sensors are installed to control the room IEQ conditions by modulating supply chilled water temperature/ flow rate and fresh air supply temperature/ quantities. Dew point temperature sensor is incorporated in the chilled panel to cut off chilled water supply to avoid condensation.



Figure 9: Typical ceiling plan

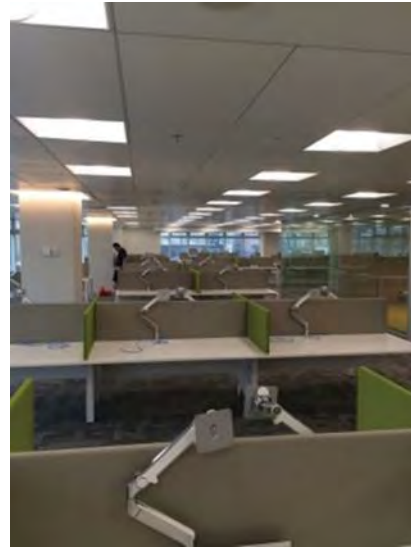

Figure 10: Open plan office

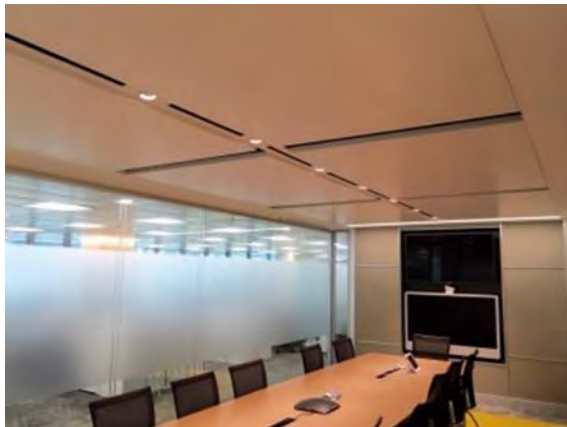

Figure 11: Meeting room

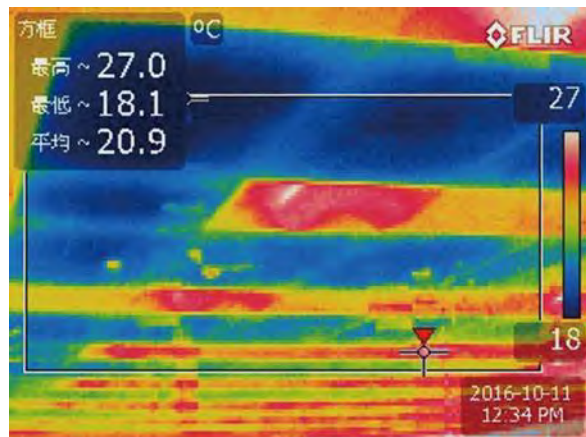

Figure 12: Thermal scan image of chilled ceiling

The above results show that performance of this chilled ceiling design **can meet all requirements in the client's** brief with satisfaction by most of the end users. Total chiller load is predicted to be around 900 TR upon full occupation such that additional chillers are not necessary to meet the new cooling load demand.

4.2 Merits of chilled ceiling versus conventional AC systems

	VAV/ AHU System	Fan Coil System	Chilled Ceiling System
1. IEQ			
• Space Temperature	23°C±1°C	23°C±1°C	23°C - 27°C
• Relative Humidity	55 % - 70 %	60 % - 75 %	50 % - 55 %
• Heating/ Cooling	Both but not common/ not well accepted	Both but not common/ not well accepted	Both and relatively comfortable so expected to be welcome by market
• CO ₂ Concentration	Average 900-1000 ppm	Average 1000-1400 ppm	Average 600 ppm
• Recirculation Air	80 %	80 to 90 %	Flexible and can be full fresh air
• Acoustic	Medium NC 38	Noisy NC 40 average	Extremely quiet typically under NC 30
• Air Draft Problem	Exist	Exist	Very Minimum
• Temperature uniformity	Average	Fluctuating	Very Even
2. Energy Performance			
• Cooling Load	200 W/m ²	180 W/m ²	100 W/m ²
• Water Pump Power	'A' kW	'A' kW	0.75 x 'A' kW
• Air Fan Power	'B' kW	0.4 x 'B' kW	0.25 x 'B' kW
3. Operation and Maintenance			
• Ease of Operation	Complicated	Less Complicated	Medium Complicated
• Maintenance Cost	High	High	Low
4. Plant Spatial Requirement			
• Requirement	High	Medium	Low
5. Cost			
• Capital Cost	High	Low	Medium (Due to limited suppliers)
• Running Cost	High	Medium	Low

5. COOLING LOAD PROFILE

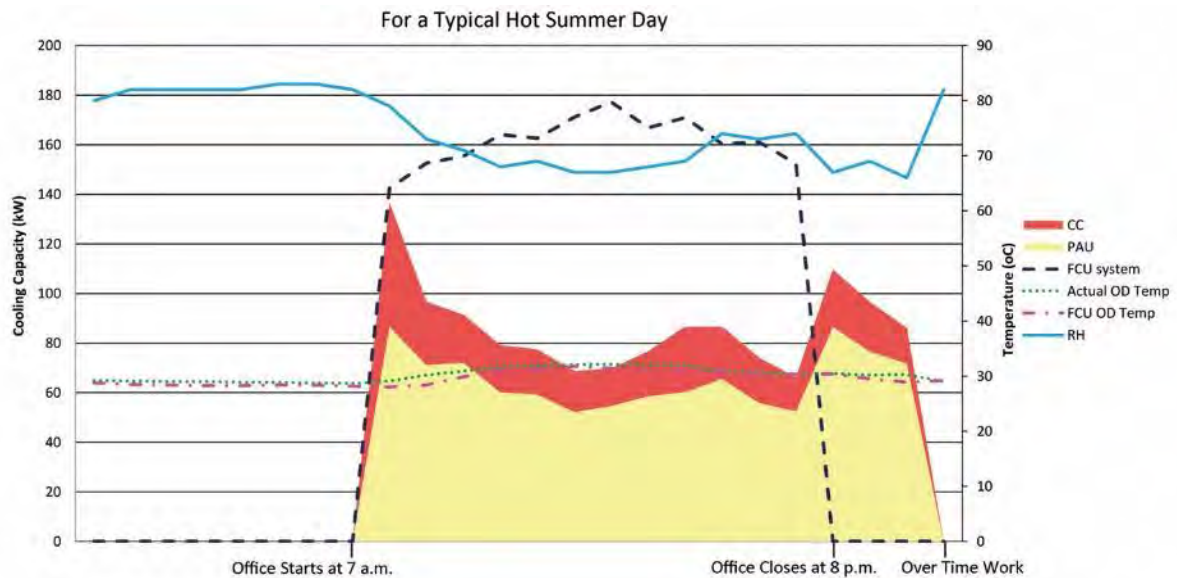

It is noted that the cooling load profile for a Chilled Ceiling System is a reverse of a conventional VAV or Fan Coil System that can significantly improve the electrical demand profile of a building.

6. LIMITATIONS

The following limitations of this radiant cooling design are observed:-

- Suppliers of proven products in the market are few resulting that initial cost is relatively high. There are limited design professionals in the trade so that this design technology cannot be proceeded on a large scale basis.
- Unfamiliarity by the end users on the system further deters development of this low energy cooling design **in the market. To ease this problem perception of thermal comfort as elaborated in Ole Fanger's Predicted Mean Vote (PMV) index can be used to holistically review this system to confirm level of thermal comfort should achieve very high score to most people.**
- Due to complexity of the indoor radiation cooling process, no formulated or validated calculation is available at present to verify cooling load calculation such that most parts of the design have to rely on past project data and references.
- New control strategy is adopted so that FM team needs to adapt and be trained to avoid operation problems like condensation.
- There may be higher water spill risk as more water pipes are installed but this problem can easily be resolved by specifying a reliable pipe connection system.

7. CONCLUSION

This innovative low temperature radiant cooling design can save up to 50 % of the cooling energy, 30 % of the pump power and 75 % of the fan power compared with conventional AC system. Furthermore the IEQ provided by **this system can be much improved as confirmed in our case study project. It's application can almost cover all** types of building including offices, hotel, hospitals, health care/ elderly centres, transportation facilities, airports, exhibition spaces, theatre, concert halls, factories and luxurious residence.

Following recent signatory of the two world most powerful countries - **China and USA for the 'Paris Accord'**, energy conservation will regain top of the agenda of most developed/ developing countries for years ahead. It is hoped that with the continual development of the product and support from the market, this innovative low energy radiant cooling system can become the most promising design for indoor environmental control system of most building projects in the near future.

Hybrid Air-conditioning System Efficiency for Districts in the Tropics

HSIEH Shanshan^a, Jimeno FONSECA^b, Arno SCHLUETER^c, François Maréchal^d

^a ETH Zurich, Future Cities Laboratory, Singapore ETH Center, Singapore

^a ETH Zurich, Chair of Architecture and Building Systems, Switzerland

^a Industrial Process and Energy Systems Engineering Group, Ecole Polytechnique Federale de Lausanne, Switzerland, hsieh@arch.ethz.ch

^b ETH Zurich, Future Cities Laboratory, Singapore ETH Center, Singapore

^b ETH Zurich, Chair of Architecture and Building Systems, Switzerland, fonseca@arch.ethz.ch

^c ETH Zurich, Future Cities Laboratory, Singapore ETH Center, Singapore

^c ETH Zurich, Chair of Architecture and Building Systems, Switzerland, schlueter@arch.ethz.ch

^d Industrial Process and Energy Systems Engineering Group, Ecole Polytechnique Federal de Lausanne, Switzerland, francois.marechal@arch.ethz.ch

ABSTRACT

Hybrid air-conditioning systems in buildings have a high potential to utilize resources in an efficient and sustainable manner in districts. The goal of this study is to compare the performance of hybrid air-conditioning systems at building and district scale in the tropics. For this, we gather operational data of an office with a hybrid air-conditioning system in Singapore and analysed the energy saving potential of separating latent and sensible cooling processes at the district scale. The effect was quantified with a virtual case study composed of 11 office buildings in Singapore. We compared decentralized and centralized options for the supply of High-temperature and Low-temperature chilled water. For the case study, the cooling consumption per area at the district scale can be potentially reduced by 24% in comparison to the current supply system at the building scale. A further study is necessary to determine optimal operation strategies and associated costs of hybrid air-conditioning systems at the district scale.

Keywords: district cooling, hybrid air-conditioning systems, energy supply systems

1. INTRODUCTION

Conventional air-conditioning systems in hot and humid climates remove the latent and sensible heat of buildings with a low temperature of condensation close to 6 °C. By separating latent and sensible heat removal process, hybrid air-conditioning systems can increase the temperature of condensation to approximately 17.5 °C for sensible heat removal. This strategy increases the energy efficiency of cooling equipment (Chua et al., 2013) (Mujahid Rafique et al., 2015).

Various hybrid Air-conditioning systems are proposed and implemented in many recent studies (Kojok et al., 2016; Mandegari and Pahlavanzadeh, 2009). For example, Kojok et al. present a thorough review on five configurations of hybrid cooling systems. Within these, the combined desiccant-vapor compression cooling system is recommended for the hot and humid climate.

Ventilation units of hybrid air-conditioning systems could be either centralized or decentralized. A centralized ventilation system consists of centralized air handling ducts distribute the cooled and dehumidified air to the indoor spaces. Instead of centralized air distribution, a decentralized system consists of air handling units installed in the vicinity of the space to be cooled, the dehumidified air is sent to indoor space directly. In the past, centralized and decentralized ventilation units of hybrid-air-conditioning have been proposed in office buildings in Singapore (Meggers et al., 2013; Rysanek et al., 2016), Hong-Kong (Fong et al., 2011) and Shengzhen, China (Zhao et al., 2011).

This paper explores the energy saving potential of hybrid air-conditioning systems for offices at the district scale. For this, we gathered real operation data of the hybrid air-conditioning system of (Schlueter, 2015) and compared configurations with decentralized and centralized options for the supply of chilled water in a district in Singapore. The district consists of 11 office buildings connected to a district cooling network of close to 2 km of length.

2. METHODOLOGY

2.1 Relative office cooling load

The decentralized hybrid air-conditioning system studied in this paper consists of decentralized air handling units (DOAS), fan coil unit (FCU), and passive chilled beams (PCB). The DOAS and FCU provide latent cooling to outdoor and recalculated indoor air respectively. The humidity target is 8 g/kg (Murray et al., 2015). While the PCB circulate cold water to remove sensible heat from the room. Chilled water for both latent and sensible heat removal is provided from the same chiller plant at around 7.6°C. The latent cooling coils in the DOAS and FCU use the chilled water directly from the plant, while the PCB runs water at ~17.5 °C, which the cooling energy is extracted from the chilled water stream (7.6°C) with heat exchangers.

The hourly thermal load of the system, $Q_{cooling}$, is acquired through the building management system (BMS) of an office of 550 m² of gross-floor area for a period of 4 weeks in July.

2.2 Supply system energy consumption

The energy consumption of the cooling equipment is calculated with Equation 1, where $Q_{cooling}$ is the office cooling load. The result was normalized to the GFA to facilitate the further extrapolation of results to the district scale.

$$W_{el} = Q_{cooling} \times COP_{chillerplant}$$

Equation 16

In Equation 1. $COP_{chillerplant}$ represents the efficiency of the chiller plant or Coefficient of Performance.

$COP_{chillerplant}$ is calculated according to Equation 2., where g is the exergetic efficiency. The second term on the right side of the equation is the carnot efficiency, where T_e is the temperature from the chiller evaporator, and $T_c = 26.5$ °C is the temperature of the condenser assumed as constant throughout the day.

$$COP_{chillerplant} = g \times \frac{T_e}{T_c - T_e}$$

Equation 2

Beside the cooling energy consumption, the total energy consumption also consists the pumping energy consumption for district network, and energy used from fans for building ventilation. The total energy consumption is normalized to the Gross Floor Area (GFA) for further extrapolation of results to the district scale.

The fan power for building ventilation depends on the building level system control strategies, therefore, the fan power of the decentralized hybrid air-conditioning system studied in this paper is acquired from the BMS data.

The pumping power in the district cooling network is calculated with Equation. 3. The head of pressure is calculated with Darcy-Weisbach equation (Menon, 2011) assuming commercial welded steel with a roughness of 0.046 mm. The friction factor, f_D , is approximated with the Swamee-Jain equation (Menon, 2011). In Equation. 3., P is resulting pumping power requirement in W, \dot{v} is the volumetric flow rate in m³/s, ρ is the water density in kg/m³, D is the pipe diameter in m, and L_{eq} Equation is the network length equivalent in m. The L_{eq} Equation is approximated as 1.2 times of the network distance to account for other friction losses from bends, valves and other components. The shaft efficiency and motor efficiency is assumed to be 0.7 and 0.9 respectively.

$$P = \dot{v} \rho g \Delta h = \dot{v} \rho g \times f_D \frac{8}{\pi^2 g D^5} \cdot L_{eq}$$

Equation 3

2.3 Supply system configurations

There are two ways to improve the efficiency of the cooling system from the cooling energy supply side according to Equation 2. One is to increase the chiller evaporator temperature, T_e , and another is to use machines with higher exergetic efficiency, g . For this reason, we explore the efficiency improvement from supplying sensible cooling with chillers operating at higher temperature, and from using large scale centralized chillers in the district cooling network.

The chillers at the building and district scale are assumed to respectively operate at an exergetic efficiency of 0.3 and 0.6, since the large scale chillers could operate at higher exergetic efficiency (Meggers et al., 2012)

We decide to set up three configurations with combinations of high-temperature (HT) and low-temperature (LT) chillers at building and district scales to compare the energy efficiency of the current supply system (base case). Configuration 1 consists only building level chillers, these chillers supply cold water for sensible cooling at high temperature and latent cooling at a lower temperature. Moving to the district scale, configuration 2 has a district cooling connection with centralized HT chillers, and LT chillers in buildings. Configuration 3 is the opposite of configuration 2, centralized LT chillers are installed at the district scale and HT chillers are installed at the building scale.

The supply (T_{supply}) and return (T_{return}) temperatures in the base case are retrieved from the office operational data. For the other three configurations, the T_{supply} and T_{return} are determined with assumptions explained in the following. In configuration 1, the LT chillers are operating at the conventional temperature range for air dehumidification, while the HT chillers only supply cold water to the PCB for sensible cooling, which operates at an average temperature of 18 °C. District scale chillers have lower supply temperatures and higher return temperatures to account for cooling energy losses in the pipelines, therefore, imposing larger cooling loads to the chillers (Tredinnick and Phetteplace, 2016). 10% heat loss is assumed in this study.

	Building scale chillers			District scale chillers	
	LT				
Base Case					
Config.1 (Building)		LT	HT		
Config. 2 (HT DC)		LT			HT
Config. 3 (LT DC)			HT	LT	
COP*	6.2	5.3	10.5	8.6	17.0
T_{supply} / T_{return} [°C]	7.6 / 17.2	7.6 / 11	16 / 20	6.6 / 14	15 / 21
LT: Low Temperature chillers, HT: High Temperature chillers, DC: District Cooling.					
Assumptions:					
<ol style="list-style-type: none"> 1. The chiller plants are well modulated, therefore operates at constant COP in each hour. 2. The pipe hydraulic diameter is 1.58 m for HT DC network and 1.26 m for LT DC network, assuming water speed in the pipe is 3m/s. 3. Pump capacities are sized for the maximum flow rate, and the pumping energy is calculated assuming a Darcy's roughness coefficient of 0.046 mm (welded steel). 					

Table 1: Supply system chiller configurations and operational conditions of the current cooling system (base case) and three alternative configurations.

2.4 Case study

A case study with 11 office buildings in the central business district of Singapore is set up to assess the performance of the hybrid air-conditioning system at the district scale. Similar to the existing district cooling pipeline situated at the Marina bay area in Singapore, one centralized chiller plant supplies cooling load for all 11 office building. The building GFA ranges from 90,900 to 653,000 m². The total district network length is 2.3 km. Since the district is situated in a tropical climate with steady patterns of temperature and relative humidity through the

year, it is assumed that all of the office buildings has the same weekly load profiles. Additionally, the chillers are sized for the peak cooling load over a week.

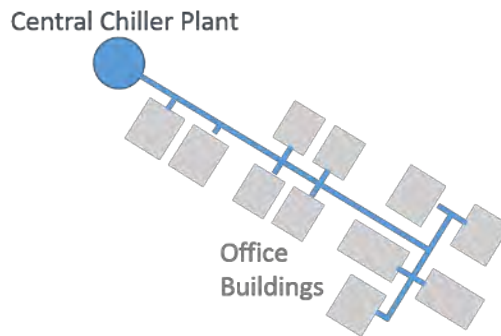

Figure 1: Case study site with 11 office buildings connection to a district cooling network with a centralized chiller plant.

Chillers sizes [W/m ²]	Building		District		Total
	LT	HT	LT	HT	
Base Case	0.076				0.076
Config. 1 (Building)	0.038	0.049			0.087
Config. 2 (HT DC)	0.038			0.054	0.092
Config. 3 (LT DC)		0.049	0.042		0.091

LT: Low Temperature chillers, HT: High Temperature chillers

Table 2: Chiller size in each supply system configuration.

3. RESULTS

3.1 Relative cooling loads

The average weekly office cooling load acquired from 4 weeks of office BMS operational data is shown in Figure 2. The latent heat ratio is 40%, with an average cooling load of 3.16 kWh/m² per week, which equals to 0.05 kWh/m² per hour of office operation.

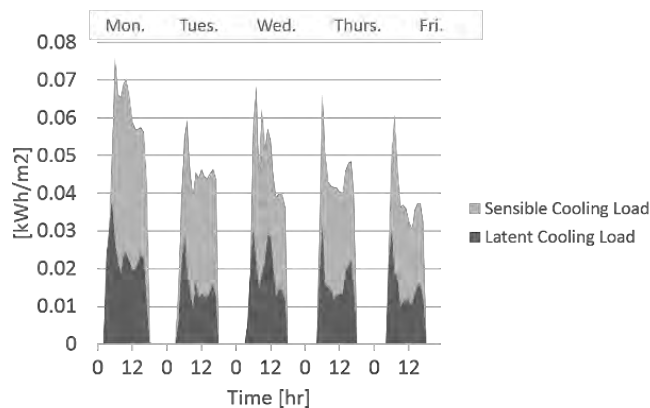

Figure 17: Average hourly office cooling load in July in Singapore.

3.2 Cooling energy consumption

The resulting total cooling energy consumptions for each configuration are calculated using the methods and assumptions described in section 2.2 and 2.3. The cooling energy consumptions of different supply system configurations are shown in Table 3. Figure 3 shows the hourly energy consumption over a week of the base case and configuration 3, the configuration with the lowest total energy consumption.

	Total energy consumption [kWh/m ² /week]	Sensible cooling	Latent cooling	Pumping**	Fan
Base Case	0.72	42.8%	28.0%	-	29.2%
Config.1 (Building)	0.63	28.9%	37.7%	-	33.4%
Config.2 (HT DC)	0.59	19.9%	40.2%	4.4%	35.5%
Config.3 (LT DC)	0.55	32.8%	27.0%	2.3%	37.9%

Table 18: Cooling energy consumption of each supply system configuration

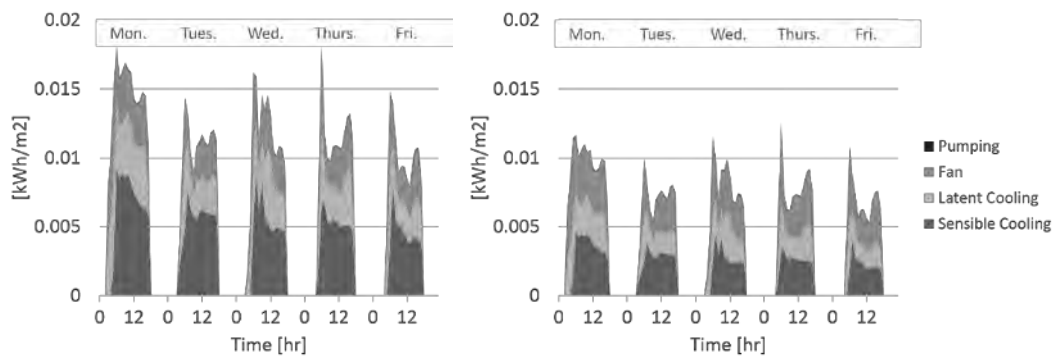

Figure 3: Hourly energy consumption of the base case (left) and configuration 3 (LT DC) (right).

4. DISCUSSION

The office building studied in this paper presents a latent cooling load ratio of 40%, which is higher than the conventional cooling system design capacity, which is around 25% (Mujahid Rafique et al., 2015). For the case study, the cooling energy consumption is reduced by 11% in configuration 1 (Building) comparing to the base case. Within the 11% reduction, the major part is coming from the 40% energy saving in sensible cooling load attended by HT chillers. The energy consumption for sensible cooling is lower than the energy consumption for latent cooling since HT chillers operate at better efficiency.

Besides, using high temperature chillers enables more renewable energy integration. As opposed to using electricity from grids as the main energy source, high temperature chillers could be supplied by various renewable sources with good efficiency, such as absorption chiller using solar thermal energy or waste heat (Udomsri et al., 2011).

When operating the supply system at the district scale, configuration 2 and 3 respectively reduce 19% and 24% of the energy consumption comparing to the base case. Configuration 3 with a LT network has lower consumption than configuration 2 with a HT network. The reason is that the benefit of replacing LT chillers in buildings with a LT network is slightly higher than replacing HT chillers in buildings. Also, the pumping energy requirement for LT network is lower because building latent loads are lower than sensible loads, therefore, the required flow rate is smaller.

The resulting centralized LT chiller plant of configuration 3 is equipped with 11.2 MW capacity. Since the district only consists of office buildings with identical load profiles, the LT centralized chiller plant operates most of the time at part load. If the district cooling network is connected to buildings with different load profiles, the chiller plant could operate at higher loads or operate outside the current operation periods. For example, the load profiles from

residential buildings, which the cooling demand starts from 5pm to 7am (Chow et al., 2004), could complement well with the office cooling load. The installed chiller capacities are better utilized when connecting buildings with different load profiles to a district network, this way, the cumulative chiller loads are increased but no additional capacity expenditures on chillers required. This load sharing benefit is not applicable to the building scale chillers since the current centralized district cooling scheme does not allow transferring surplus capacities from various buildings back to the cooling network.

On the other hand, central chiller plants could be complemented with thermal storages, which is normally not feasible at the building scale due to space restrictions and costs. Thermal storage could shift the peak cooling consumption away from the peak cooling load period, which provides system flexibility (Powell et al., 2013) and financial benefits when peak energy tariffs are high.

5. CONCLUSIONS

This study presents the energy efficiency improvement opportunities from the supply system side when sensible and latent cooling energy is utilized separately in the building operation systems. 11 % reduction in total energy consumption compare to the base case is achieved in configuration 1, which supplies cooling energy with HT and LT chillers at the building scale. Furthermore, the consumption is reduced by 26% when connecting buildings to district energy network. This is the advantage of utilizing large scale chiller with higher exergetic efficiency. Additionally, HT chillers could be powered efficiently from renewable energy sources, e.g. solar thermal, which enables more renewable energy penetration.

Beside better energy efficiency performances, centralized chiller plant also presents several benefits that normally are not applicable to building scale chillers. The first benefit is the opportunity to connect to more building types with different cooling load profiles (e.g. residential buildings), this way, more cooling loads could be produced from the same chiller plant without additional capital investment. The extra capacity in the building level chillers are not sharable in the framework of the current district cooling network with centralized production, however, it is possible when implementing a cooling network with bi-directional energy flows. Secondly, the possibility to utilize thermal storage to produce cooling energy at the period with lower tariff could reduce operational expenses. In addition to cost savings during operation, thermal storage could provide system flexibility and financial benefits.

Despite the advantages of hybrid air-conditioning systems, hybrid air-conditioning systems require specialized control systems to ensure efficient operation. Further studies could lie on determination of the optimal chilled water supply temperatures and quantification of benefits from the storage and load sharing schemes mentioned above. The first part could be done by pinch analysis, which is a process integration technique to determine the minimum amount of hot and cold utilities and temperature level requirements. The second part could be done by computational models, which can be used to perform a detailed dynamic simulation of control strategies applicable **to the system's configurations addressed in this study. Key configurations of interest include integrating thermal storage units, residential buildings, renewable energy and bi-directional flows in a thermal network.**

ACKNOWLEDGMENTS

he authors would like to acknowledge Dr. Adam Rysanek for his generous assistant on providing knowledge of the decentralized hybrid-air conditioning systems and the retrieving system operational data.

REFERENCES

- [1] Chow, T.T., Au, W.H., Yau, R., Cheng, V., Chan, A., Fong, K.F., 2004. Applying district-cooling technology in Hong Kong. *Appl. Energy* 79, 275–289. doi:10.1016/j.apenergy.2004.01.002
- [2] Chua, K.J., Chou, S.K., Yang, W.M., Yan, J., 2013. Achieving better energy-efficient air conditioning – A review of technologies and strategies. *Appl. Energy* 104, 87–104. doi:10.1016/j.apenergy.2012.10.037
- [3] Fong, K.F., Lee, C.K., Chow, T.T., Fong, A.M.L., 2011. Investigation on solar hybrid desiccant cooling system for commercial premises with high latent cooling load in subtropical Hong Kong. *Appl. Therm. Eng.* 31, 3393–3401. doi:10.1016/j.applthermaleng.2011.06.024
- [4] Kojok, F., Fardoun, F., Younes, R., Outbib, R., 2016. Hybrid cooling systems: A review and an optimized selection scheme. *Renew. Sustain. Energy Rev.* 65, 57–80. doi:10.1016/j.rser.2016.06.092

- [5] Mandegari, M.A., Pahlavanzadeh, H., 2009. Performance assessment of hybrid desiccant cooling system at various climates. *Energy Effic.* 3, 177–187. doi:10.1007/s12053-009-9059-5
- [6] Meggers, F., Pantelic, J., Baldini, L., Saber, E.M., Kim, M.K., 2013. Evaluating and adapting low exergy systems with decentralized ventilation for tropical climates. *Energy Build.* 67, 559–567. doi:10.1016/j.enbuild.2013.08.015
- [7] Meggers, F., Ritter, V., Goffin, P., Baetschmann, M., Leibundgut, H., 2012. Low exergy building systems implementation. *Energy* 41, 48–55. doi:10.1016/j.energy.2011.07.031
- [8] Menon, E.S., 2011. Chapter 8 - Pipeline Hydraulic Analysis, in: *Pipeline Planning and Construction Field Manual*. Gulf Professional Publishing, Boston, pp. 123–175.
- [9] Mujahid Rafique, M., Gandhidasan, P., Rehman, S., Al-Hadhrami, L.M., 2015. A review on desiccant based evaporative cooling systems. *Renew. Sustain. Energy Rev.* 45, 145–159. doi:10.1016/j.rser.2015.01.051
- [10] Murray, P., Rysanek, A.M., Pantelic, J., Mast, M., Schlueter, A., 2015. On Decentralized Air-conditioning for Hot and Humid Climates: Performance Characterization of a Small Capacity Dedicated Outdoor Air System with Built-in Sensible and Latent Energy Recovery Wheels. *Energy Procedia* 78, 3471–3476. doi:10.1016/j.egypro.2015.12.332
- [11] Powell, K.M., Cole, W.J., Ekarika, U.F., Edgar, T.F., 2013. Optimal chiller loading in a district cooling system with thermal energy storage. *Energy* 50, 445–453. doi:10.1016/j.energy.2012.10.058
- [12] Rysanek, A.M., Murray, P., Pantelic, J., Mast, M., Schlueter, A., 2016. Simulation Analysis of a Low-Exergy Decentralized Air-conditioning System for Hot and Humid Climates: Towards a Pilot Implementation in Singapore. Presented at the 14th Conference of International Building Performance Simulation Association, Hyderabad, India.
- [13] Schlueter, A., 2015. 3-for-2: Less energy, more space [WWW Document]. Eidgenössische Tech. Hochsch. Zurich. URL <https://www.ethz.ch/en/news-and-events/eth-news/news/2015/03/3-for-2-less-energy-more-space.html> (accessed 10.14.16).
- [14] Tredinnick, S., Phetteplace, G., 2016. 8 - District cooling, current status and future trends A2 - Wiltshire, Robin, in: *Advanced District Heating and Cooling (DHC) Systems*, Woodhead Publishing Series in Energy. Woodhead Publishing, Oxford, pp. 167–188.
- [15] Udomsri, S., Martin, A.R., Martin, V., 2011. Thermally driven cooling coupled with municipal solid waste-fired power plant: Application of combined heat, cooling and power in tropical urban areas. *Appl. Energy* 88, 1532–1542. doi:10.1016/j.apenergy.2010.12.020
- [16] Zhao, K., Liu, X.-H., Zhang, T., Jiang, Y., 2011. Performance of temperature and humidity independent control air-conditioning system in an office building. *Energy Build.* 43, 1895–1903. doi:10.1016/j.enbuild.2011.03.041

Evaluation of Saving Energy of SOFC and Battery Combined System

Takeshi SASE^a

^a Building Research Institute, Japan, sase@kenken.go.jp

ABSTRACT

Fuel Cells have been utilized for residential use recently. Because they are very effective saving energy, generating not only electricity but also hot water. Especially SOFC (Solid Oxide Fuel Cell) has been utilized because of its higher efficiency of generating electricity than PEFC (Polymer electrolyte fuel cell).

The authors have found that it has high efficiency 42% at full capacity but it decreases on smaller scale. To overcome this shortcoming, the authors have made the system, combining SOFC and battery. This system accumulates overflowed electricity into the battery, operating SOFC on the full scale, and emits electricity from the battery when the electricity load is beyond SOFC capacity.

The authors have evaluated its efficiency of generating electricity, saved energy compared with the traditional method, which provide electricity and hot water by the Commercial power and the gas boiler, and the only SOFC on various electricity and hot water scale patterns. They have found that it is more effective by generating electricity and accumulating overflowed electricity and emitting it generally. But it is not more effective than the only SOFC when it is operated on smaller electricity scale. The proposed system loses some electricity during accumulating it into the battery, emitting it from the battery, and translating it between direct and alternate current.

It is suggested its efficiency and effectiveness could be improved by reducing this electric loss.

Keywords: SOFC (Solid Oxide Fuel Cell), battery, saving energy

1. INTRODUCTION

Fuel cells have been utilized for residential use to save energy. At first PEFC (polymer electrolyte fuel cell) have been used, recently SOFC (Solid Oxide Fuel Cell), which have higher efficiency, have been introduced for not only for commercial use but also for residential use.

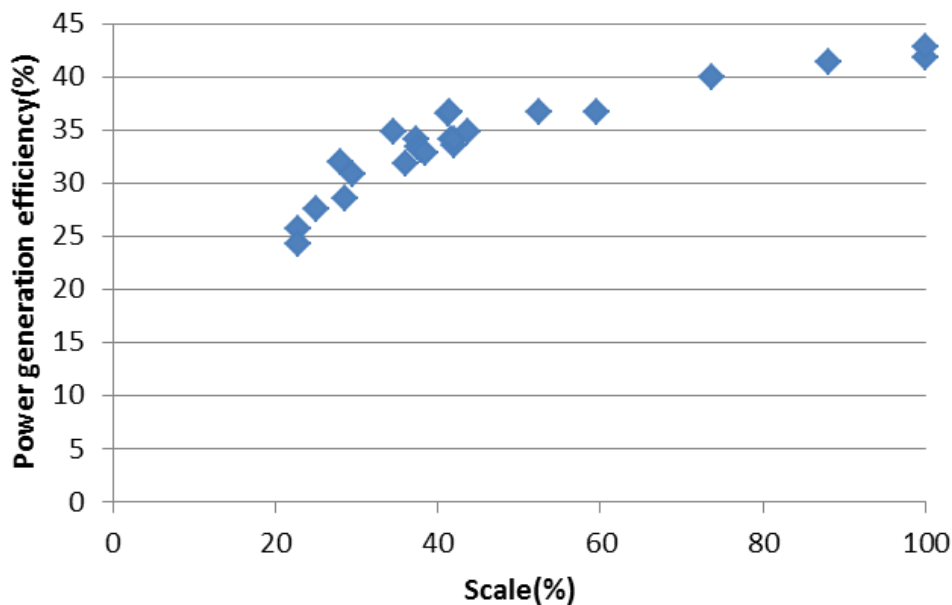

Figure 1: Power generating efficiency of SOFC

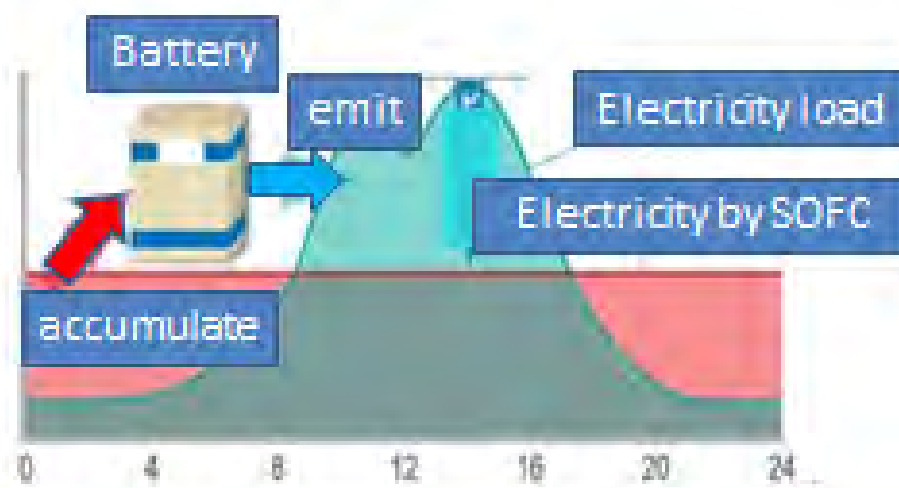

Figure 2: Operation of SOFC and battery

It is said that SOFC efficiency of generating electricity is high (about 42%) at the full scale but it decreases at small scale.

To overcome this shortcoming, the authors combined SOFC with battery. SOFC is operated at full scale if the battery is not full, accumulating overflowed electricity. On the other hand, Battery emits electricity when the electricity load is beyond SOFC capacity. The authors have examined efficiency and effectiveness of this system.

2. EVALUATING TESTS FOR EFFICIENCY System and loads for evaluating tests

Figure 3 shows the system combining SOFC (producing from 50 to 700W electricity, with hot water tank 90 Litter) and Battery (The full capacity 7.2 kWh, the Rated Voltage 2.5W) and locations of various sensors, such as electricity, gas, temperature and flow sensors.

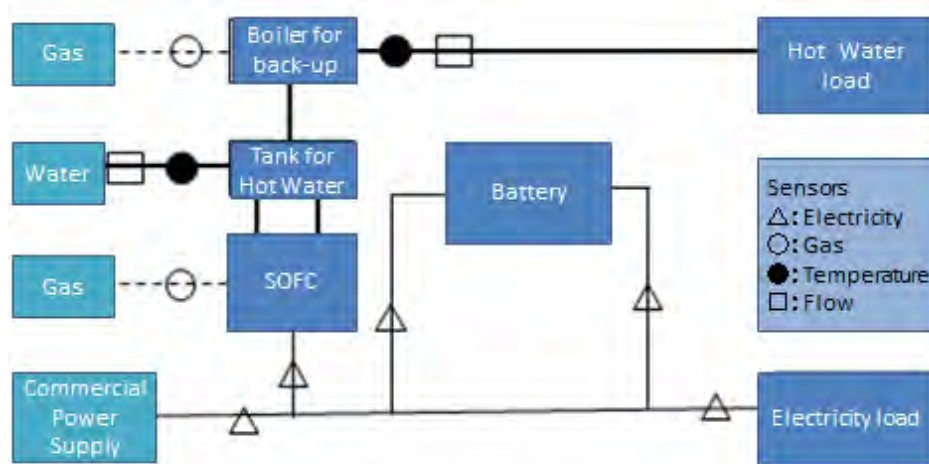

Figure 3: System of SOFC and battery

Test electricity loads are set based on the Japanese Standard Energy-Saving Building Guideline (10.96kWh/ day) and the full capacity of SOFC (16.8 kWh/ day). 4 Types of loads are set, which are large one with 2 peaks (16.27 kWh/ day), large one with gentle slope (16.27 kWh/ day), medium one (the Japanese Standard Energy-Saving Building Guideline 10.96kWh/ day) and small one (6.58 kWh/ day).

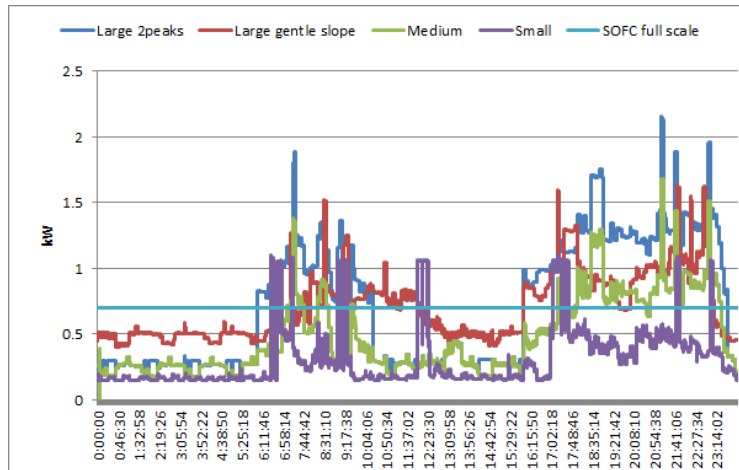

Figure 4: Test loads of electricity

Test hot water loads are set based on the Japanese Building Supplying Hot Water Guideline. Modified M-1 mode (650,550,470,380,380,240 Litter/ day) is allocated with 2 large electricity loads. Modified M-1 mode saving type (522,454,387,306,166 Litter/ day) is allocated with Medium and Small electricity loads. The Efficiency and effectiveness of this system are examined with various electricity and hot water loads in this way.

Hot water loads(L/day)	
Modified M1 mode	Modified M1 mode (Saving type)
650	522
550	454
470	387
380	324
380	306
240	166

Table 1: Test loads of hot water

2.2 Electric power supply of this system with various loads

The authors have examined efficiency and effectiveness of this system with various electricity and hot water loads mentioned on the above.

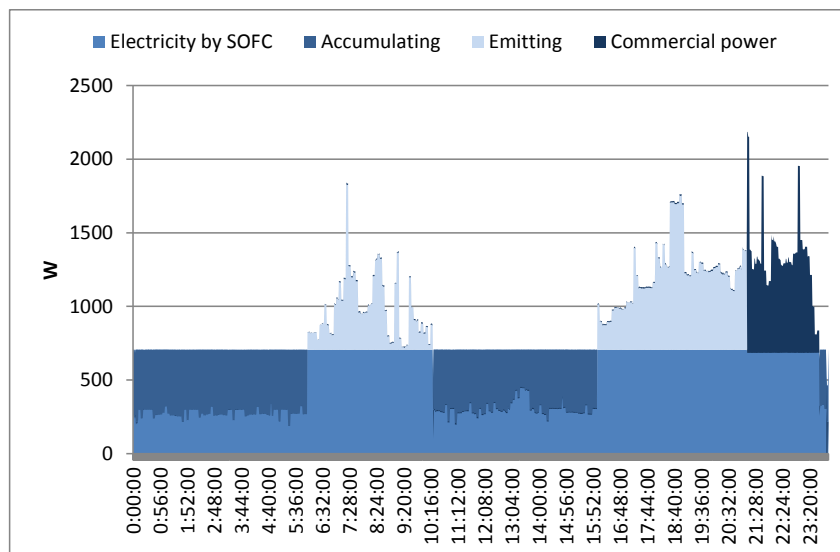

Figure 5: Supply of electric power (large 2peaks)

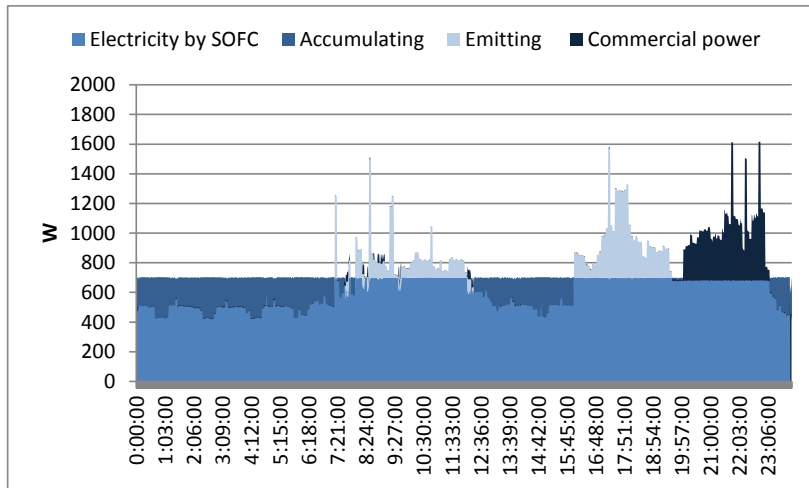

Figure 6: Supply of electric power (large gentle slope)

Figure 5 shows supply of electric power by this system with large electricity load with 2 peaks and Figure 6 shows that with large electricity load with gentle slope. In both cases, the batteries accumulate overflowed electric power while the load are low, operating SOFC on the full scale and emit electric power from the batteries while the loads are higher than the full capacity of SOFC. Also in both cases, the commercial powers are supplied after the batteries run out of accumulated electricity.

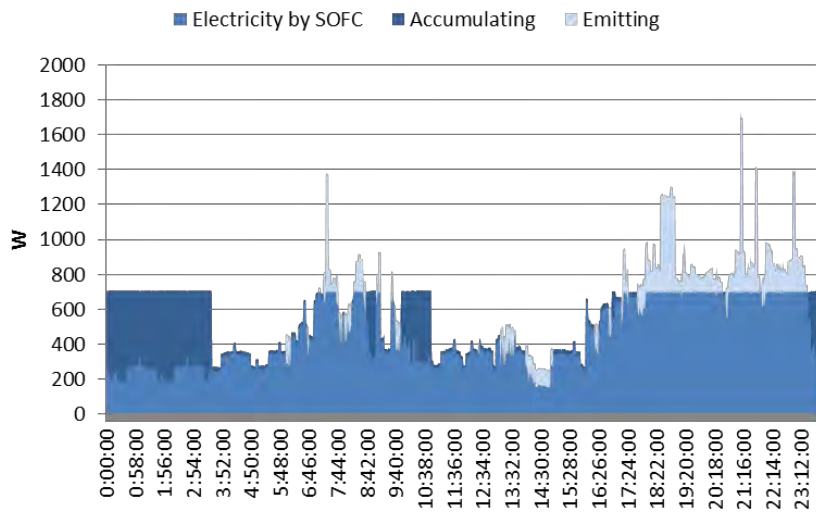

Figure 7: Supply of electric power (medium load)

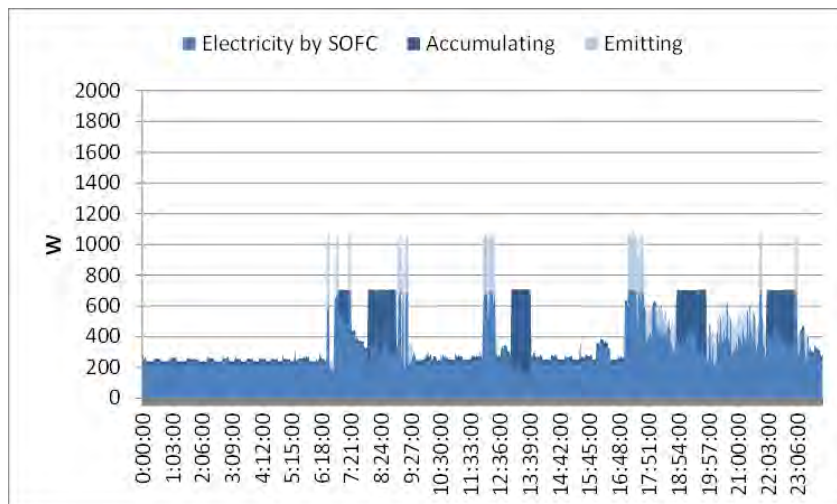

Figure 8: Supply of electric power (small load)

Figure 7 shows supply of electric power by this system with medium electric load and Figure 8 shows that with small electric load. As shown in Figure 5 and Figure 6, the battery accumulates overflowed electricity while the load is low and emits electricity from the battery while the load is higher than the full capacity of SOFC.

On the other hand, in Figure 7 and Figure 8, the batteries accumulate electricity until they get full. In both cases, the SOFCs operate according with the electric load after they get full, not on the full scale.

So the authors have seen different patterns of electric power supply between large electric loads and medium, small load.

2.3 Evaluation of energy saving of this system with various loads

The authors have evaluated the rate of energy saving of this system as below. The total load is provided as below.

$$E_t = E_e + E_w$$

E_t : Total load (kWh)

E_e : Electric load (kWh)

E_w : Hot water load (kWh)

The supplied energy to this system to provide the above load E_t , is described as below.

$$S_1 = G_1 + G_{1b} + E_1$$

S_1 : Total supplying energy to this system (kWh)

G_1 : Gas usage by SOFC (kWh) (Gas calorific value 45MJ/ m³)

G_{1b} : Gas usage by the back-up boiler (kWh) (assumed 85%)

E_1 : Commercial power usage (kWh) (with The Japanese Guideline. Transferred as 9760kJ/ kWh)

The supplied energy to the traditional energy providing system, which is by the commercial power and the gas boiler, is described as below.

$$S_2 = G_{2b} + E_2$$

S_2 : Total supplying energy to the traditional system, which is by the commercial power and the gas boiler (kWh)

G_{2b} : Gas usage by the traditional gas boiler (kWh) (assumed 85%)

E_2 : Commercial power usage (kWh) (with The Japanese Guideline. Transferred as 9760kJ/ kWh)

Energy saving rate is evaluated, comparing total supplying energy S_1 with this system and S_2 with the traditional energy providing system, which is by the commercial power and the gas boiler.

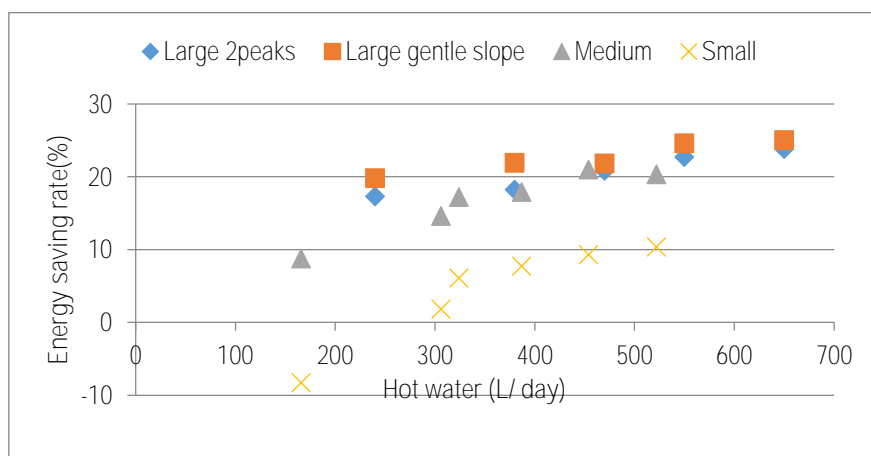

Figure 9: Energy-saving rates with various loads

Figure 9 shows energy saving rates with various loads. In all loads, energy saving rates are higher in larger hot water loads. It is typical with fuel cells. In general energy saving rates with large 2 peaks, large gentle slope and medium loads are beyond 15%, with small load are below 10%. So this system has advantage with more than medium electricity load.

2.4 Evaluation of energy saving of this system with only SOFC

The authors combined SOFC with battery to overcome the shortcoming that SOFC efficiency of generating electricity is high (about 42%) at the full scale but it decreases at small scale.

So the authors have evaluated energy saving of this system with not only the traditional providing system, which is by the commercial power and the gas boiler, but also with only SOFC.

The authors have known the general trend of energy saving of this system on 2.3. So the authors have compared energy saving of this system with only SOFC with not every type of load but only large electricity load with 2 peaks and medium load.

The supplied energy to only SOFC to provide the above load E_t , is described as below.

$$S3 = G3 + G3b + E3$$

S3: Total supplying energy to only SOFC(kWh)

G3: Gas usage by SOFC (kWh) (Gas calorific value 45MJ/ m³)

G3b: Gas usage by the back-up boiler (kWh) (assumed 85%)

E3: Commercial power usage (kWh) (with The Japanese Guideline. Transferred as 9760kJ/ kWh)

Energy saving rates are evaluated compared with the traditional energy providing system, which is by the commercial power and the gas boiler, both for SOFC with the battery and only SOFC.

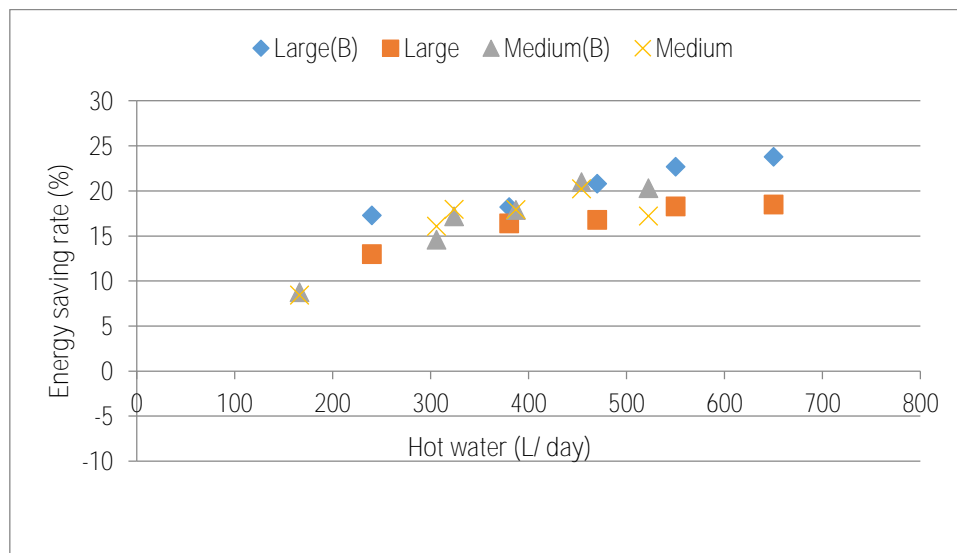

Figure 10: Energy-saving rates (SOFC + battery vs SOFC)

Figure 10 shows the results of this evaluation. This system, combining SOFC and the battery, has higher energy saving rate than only SOFC with large 2peaks electricity load, especially with heavier hot water loads. But it has no higher energy saving rate than only SOFC with medium electricity load.

2.5 Battery's traits

If this system, combining SOFC and the battery, could accumulate, emit electricity and translate it between direct and alternate current perfectly with no electricity lost, it could always have higher energy saving rates than only SOFC. But in reality, it always has some electrical loss during accumulating, emitting and translating electricity. So **it is important to know the battery's traits and evaluate these losses to make this system more energy saving.**

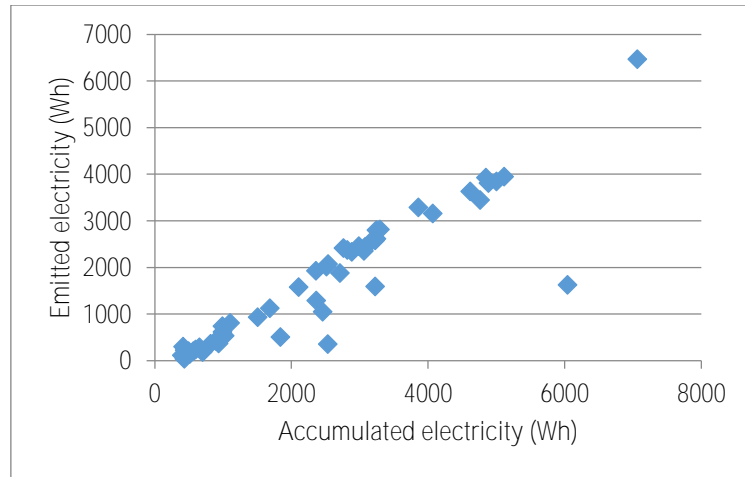

Figure 11: **Battery's** trait (emission vs accumulation)

Figure 11 shows correlation between accumulated electricity into the battery and emitted electricity from it. It is suggested they are proportional in general. But there are some exceptions, which are lower than proportional dots. Moreover, the direct line to connect dots does not pass the Zero point, crossing X line with positive. It suggests effective efficiency is low, where accumulated electricity is small.

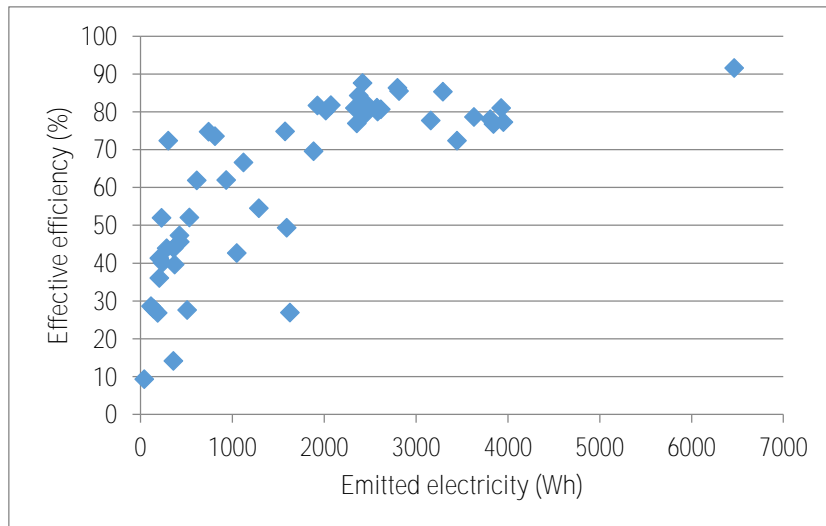

Figure 12: **Battery's** trait (effective efficiency vs emission)

Figure 12 shows correlation between emitted electricity from the battery and effective efficiency. The effective efficiency is stable, around 80%, where emitted electricity is over 2000. But dots are scattered and below 80% where is emitted electricity below 2000.

This means at least 20% electricity is lost during accumulating and emitting process. And it is suggested that more than 20% electricity is lost, where emitted electricity is below 2000. Moreover, it is suggested it is difficult how much electricity is lost in this part because dots are scattered vastly.

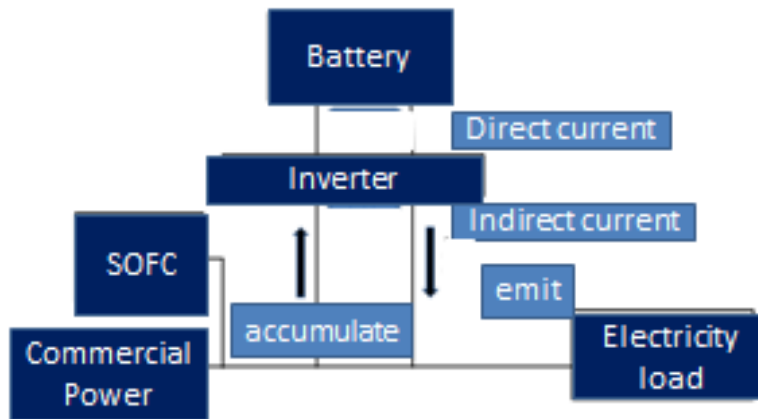

Figure 13: Mechanism of SOFC + battery system

Figure 13 shows the mechanism of this system, combining SOFC and the battery. This shows the flow of electricity from SOFC, the commercial power to the battery and it from the battery to the electricity load.

The electricity from SOFC, the commercial power is indirect current and it is converted to direct one in the inverter and accumulated into the battery as direct one. On the other hand, the electricity from the battery is direct current and it is converted to indirect one in the inverter and delivered to the electricity load.

It is suggested some electricity is lost during this converting process. This loss is included in Figure 9 and 10.

3. CONCLUSION

The authors have evaluated its efficiency of generating electricity, saved energy compared with the traditional method, which provide electricity and hot water by the Commercial power and the gas boiler, and the only SOFC on various electricity and hot water scale patterns. They have found that it is more effective by generating electricity and accumulating overflowed electricity and emitting it on larger electricity scale. But it is not more effective than the only SOFC when it is operated on smaller electricity scale.

The proposed system loses more than 20% electricity during accumulating it into the battery, emitting it from the battery, and translating it between direct and alternate current. Especially more than 20% electricity is lost, where emitted electricity is small. Moreover, it is suggested it is difficult how much electricity is lost in this part because dots are scattered vastly.

It is suggested its efficiency and effectiveness could be improved by reducing this electric loss.

REFERENCES

- [1] Yasunori Akashi, 2013, Energy Saving Effects of Solid Oxide Fuel Cell Co-Generation System : Part 3 Examination of the Optimal Specification for Collective Housing according to Energy Demand, Building National Conference, Sapporo, 8/ 30 – 9/ 1

Session 3.3 Advanced Building Systems - Energy Generation (1)

Analysis of Fourth-Generation District Energy Systems with Renewable Energy Cogeneration by Using Rational Exergy Management Model

Birol KILKIS^a

^a Baskent University, Turkey, email

ABSTRACT

Recent 4th-generation district energy systems envision optimum bundling of different energy resources and conversion systems with main emphasis on sustainability and renewable energy use. Because renewable energy sources generally have low exergy and some of them are interrupted, they must be stored, time and exergy matched with low-exergy demands. The complex nature of the source and demand hybridization requires new exergy focused controls based on *Rational Exergy Management Model*. This need actually defines the main concept of smart metropolis. In this paper a new algorithm for optimizing the exergy bundling of renewable energy and conversion systems in cogeneration format with low-exergy metropolis demands is described with the objective of minimizing the CO₂ emissions. A second algorithm for the control of the hybrid system, which is tested in a smaller scale in a LEED Platinum building Ankara has been adopted and projected to typical metropolis. New definitions like Net-Zero Exergy Metropolis, Net-Zero Carbon Metropolis are also described. The paper concludes that the Second Law of thermodynamics leading to the exergy concept is the primary player in developing smart metropolis and minimizing their carbon foot print.

Keywords: sustainable neighbourhood, cogeneration, rational exergy management model

1. INTRODUCTION

Districts have several tasks to accomplish with highest reliability and best sustainability while facing time-dependent loads of different forms and exergy. Figure 1 shows typical hourly variation of thermal and power loads of a District. According to this figure, peaks of different loads are not coincident and every different load has a different profile. Consequently, not only the magnitudes but also the load proportions change with time. Large variations of different load proportions are particularly important for cogeneration systems, because they deliver heat and power almost at a constant ratio over their regular operational range. All these factors make it necessary to employ more than one energy conversion system and to bundle various energy sources, preferably by utilizing different sustainable systems. This makes it essential to extensively use TES (Thermal Energy Storage) systems and –if feasible to employ- electrical storage systems, besides grid exchange. One also needs to know the availability of renewable energy systems on an hour-by-hour basis for a sustainable and near-zero design and operation. In addition, controls, systems, and equipment primarily respond to comfort cooling and heating loads, which impose time-dependent temperatures: not only the magnitudes and proportions of loads change but at the same time demand temperatures for thermal equipment and systems change continuously. For example, in a HVAC system supply temperatures are proportionately controlled with respect to outdoor air temperature, which affect the system and equipment performance. Finally, the factors that affect part-load efficiency of the equipment must be also considered in order to yield accurate hourly equipment energy demand data.

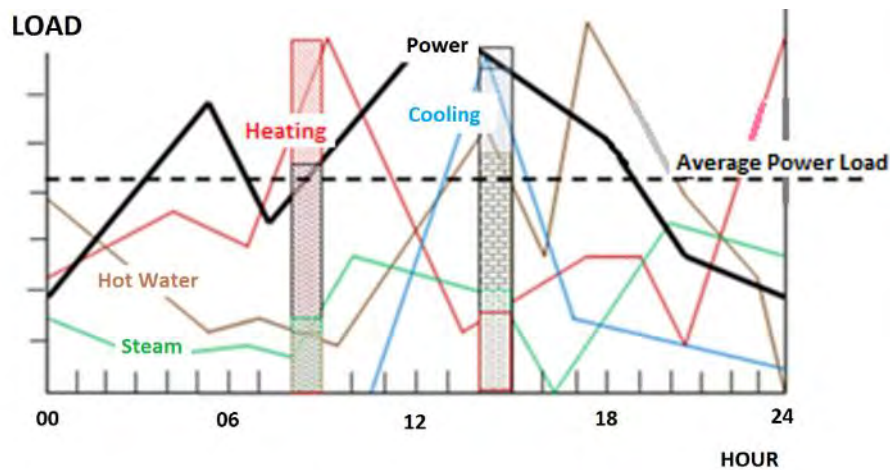

Figure 1: Typical Daily Load Profiles in a District

On the other hand, Districts are becoming a vital partner of the built environment and get multi-dimensionally connected to the cities forming a nexus of economy, energy (exergy), and environment. For example, Districts send their trash to biogas plants in the nearby cities and receive power and energy in return. For a sustainable future, the most recent trend is to connect Districts to 4DE (Fourth Generation) district energy systems in the built environment, where low-temperature heat (for DHW, LowEx heating), high-temperature heat (for conventional space heating, process heat), moderate-temperature cold (space cooling), low-temperature cold (process cold) and power generated with conventional and renewable energy systems and resources are exchanged at various exergy levels. Solar energy is used to generate power in the built environment widely. However, when it comes to harvest solar and wind energy, Districts face serious limitations due to air traffic safety. Generally new District construction and their operation may impose serious environmental risks. In spite of all these complexities, U. S. Department of Energy (DOE) has recently defined Zero-Energy Building (ZEB) in an over simplistic format by using only the First-Law of Thermodynamics. In their definition, energy supplied-received balance is simply based on an annual single cumulative basis of all kinds of energy with different exergy values without taking into account the exergy variations and associated CO₂ emissions, which are hidden in the Second-Law. This issue was first addressed by [5] by developing new definitions for net or near building in terms of exergy (NZEXB, nZEXB). In fact, according to Marszal and Heiselberg, the definition of net or near zero building is quite complicated.

2. THEORY

Several European countries are in the process of developing and implementing their road maps for near-zero energy buildings (nZEB) according to the relevant EU Directive for High Performing Buildings. There are several definitions for nZEB concept and all models, definitions, and implementations are based on the First-Law, which only deal with the quantity of the energy exchange between the building, grid, and the district. Current practice is primarily focused on electric power exchange. Today, Denmark is the only EU country that factors-in the thermal energy exchange. Thermal energy at different states and temperatures mean a wide variation of the thermal energy quality (exergy). **Other shortcomings of the current NZEB or nZEB definitions, which may be inferred from Kılış, Ş. are:**

- Thermal energy exchange definitions must distinguish different forms of heat like steam, hot water, service water, cold water etc.
- Quality of energy exchange needs to be embedded in the nZEB definition.
- The quality of energy exchanged in calculating the harmful emissions must be taken into account by a new definition.

More importantly, the temperatures of the heat received from and supplied to a district system must be taken into account in determining the supply and demand exergy balance as shown in Figure 2. For example, an exergy exchange deficit occurs in the grid-connected building if the building delivers 30°C water to the district but receives 40°C water from the district in the same amount over a given period of time. A similar deficit occurs for cooling, because exchange temperatures of the chilled water are different.

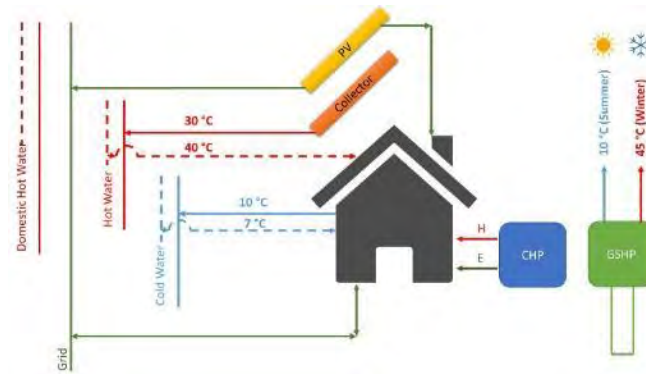

Figure 2: Supply and return temperatures between a sustainable building and de system

Therefore, the unit exergy of each 1 kW-h of the supply heat, ϵ_{sup} according to the ideal Carnot Cycle must be considered. Equation 1-a may also be used for destroyed exergy and demand exergy. Equations 1-a, 1-b, 2, and 3 establish the energy, environment, and economy nexus, respectively.

Energy

$$\epsilon_{sup} = \left(1 - \frac{T_{ref}}{T_{sup}} \right) \times (1 \text{ kW} \cdot \text{h})$$

Equation 1-a: Unit exergy

$$E_x = \epsilon_{sup} \times Q_{sup}$$

Equation 1-b: Energy and exergy

$$\psi_R = 1 - \frac{\sum \epsilon_{des}}{\epsilon_{sup}}$$

Equation 1-b: Rationality of energy use

Equation 1-a through 1-c establish the energy and exergy metric of the nexus. For a green district and subscribing building the annual average of ψ_R must be greater than 0,70.

Environment

$$\sum CO_2 = \left[\frac{c_l}{\eta_l} + \frac{c_m}{\eta_m \eta_T} (1 - \psi_R) \right] Q_H + \frac{c_m}{\eta_m \eta_T} E$$

Equation 2-a: Environment

Equation 2-a, which is derived from the Rational Exergy Management Model (REMM) establishes the environment metric of the nexus. At below, EDR is the Ratio of Emissions Difference. The CO_{2base} term is the standardized emission rate calculated with practical defaults for 0,5 kW-h thermal and 0,5 kW-h electrical load per hour

($C=1$). See Equation 2-c, where CO_{2base} is 0,63 kg CO_2 / kW-h, which is derived from Equation 2-a. EDR must be close to one.

$$EDR = 1 - [CO_{2on-site} / CO_{2base}]$$

Equation 2-b: Emissions are based on REMM

$$\sum CO_2 = \left[\frac{0,2}{0,85} + \frac{0,2}{0,35} (1 - 0,2) \right] 0,5 + \frac{0,2}{0,35} 0,5$$

Equation 2-c

Economy

$$PES = \left[1 - \frac{1}{\left(\frac{CHPH\eta + CHPE\eta}{RefH\eta + RefE\eta} \right) \times \frac{(2 - Ref\psi_R)}{(2 - \psi_R)}} \right] \times 100$$

Equation 3: Economy

Equation 3 provides the economy metric, where PES must be greater than 35% in order to qualify for a green status. In order to satisfy the above metrics, a complex design example for achieving NZEXAP status is shown in Figure 3 (Kilkis, B., 2012). In this design the combined heat and power system (CHP) is supported by renewable energy systems including solar collectors, PV systems, and their derivatives, and remote green electricity power from wind. Buildings and large complexes need to use radiant heating and cooling systems and thus may easily qualify for Low-Exergy Building status, while they employ moderate working temperatures. Thus solar energy may be directly utilized in their HVAC systems. Hot water, chilled water, and ice tanks shave the peak loads, shift the loads to converge to the supply profiles, and match the thermal exergy levels of various supplies and demands in the complex.

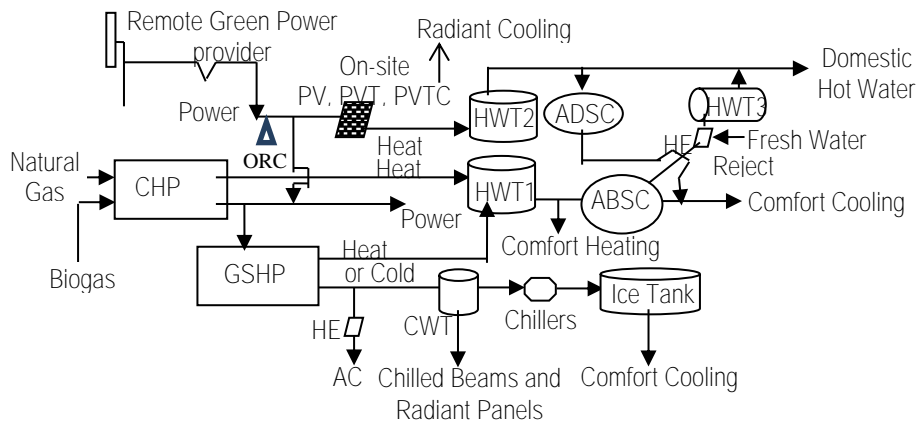

Figure 3: NZEXAP tri-generation plant design

3. OPTIMIZATION OF 4DE SYSTEMS

Figure 5 shows a typical daily power load profile at different (c) values with respect to P_P (Peak power load). (c) is the ratio of the selected capacity of a cogeneration plant to the peak power load. For example, if a tri-generation system in Figure 5 is selected with a capacity equal to P_P , then it will only operate for about only two hours at a capacity near to its full capacity. At the same time because most CHP engines are not allowed to operate below 40% capacity, it will remain idle for about 9 hours in a typical day. Unless cascaded, the CHP unit at part load will have reduced efficiency. It is obvious that NZEXAP or nZEXAP conditions may only be satisfied and energy, environment, and economy nexus be established by a careful selection of the tri-generation plant. Therefore, the capacity(ies) of CHP systems must be carefully optimized and cascaded, if necessary.

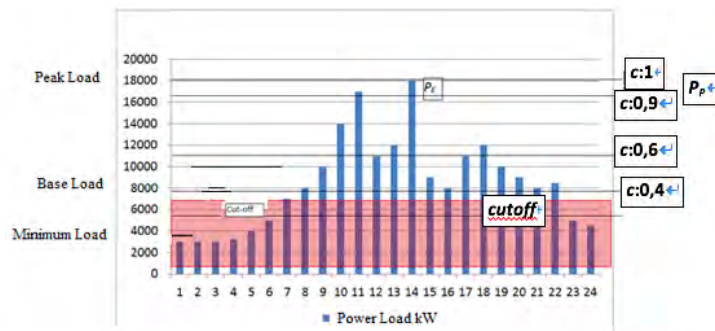

Figure 5: Typical hourly change of power demand

3.1 Objective function and its simplification

The primary objective is to maximize the performance of a CHP system under the energy, environment, and economy nexus. Main parameters are First-Law efficiency (η), (c) value, Operating Factor (IF), Rational Exergy Management Efficiency (ψ_R), CO₂ emissions, and economic return. Terms (j) and (l) are correlation parameters.

$$OF = f(\eta, c_i, IF, \psi_R, CO_2)$$

Equation 4-a: Maximize

(c) for natural gas it is 0,2 kg CO₂/ kWh-h. IF depends on (c) that is shown in Figure 6, where $IF = f(c)$ [8].

$$OF = \left[\frac{0,6 + j(IF - 0,6)^l}{0,9} \right] + \left[\frac{IF}{0,9} \right] + \left[\frac{0,088}{\left(\frac{c_i}{\eta} \right) (1 - \psi_R)} \right]$$

Equation 4-b

Where,

$$\eta_l = \left[\frac{0,6 + j(IF - 0,6)^l}{0,9} \right]$$

Equation 5

After taking the upper limit of $\psi_R \leq \eta_{EX}$ conditional inequality, assuming $C = 1$, and using the upper limit of the $\eta_{EX} \leq 0,9 \cdot \eta_l$ conditional inequality, Equation 4-b reduces to a single-variable expression.

$$OF = f^*(c)$$

Equation 6-a: Maximize

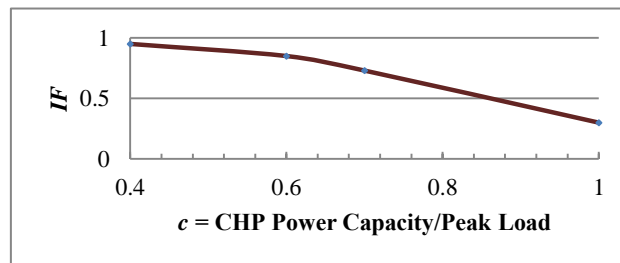

Figure 6: Approximate change of IF with (c)

Provided that for gas engines (c) must be greater or equal to 0,4, Equation 6-b gives the initial solution:

$$\frac{dOF}{dc} = 0$$

Equation 6-b

Constraints of the nexus:

$$\eta_l \geq 0,80,$$

$$0,4 \leq c \leq 0,75, 0,7 \leq IF \leq 1,$$

$$\psi_R \geq 0,6, CO_2 \leq CO_{2base}.$$

Once the optimal (c) value is determined, the CHP system may be cascaded, in optimal numbers and individual capacities depending upon the daily-averaged hourly load profiles. In general, the first cascade is allocated to the minimum continuous load (24 hours a day), the second one is sized such that it operates about 16 hours a day between its full capacity and 60% capacity, and the remaining one(s) are sized for peaking purposes such that they operate about 8 hours a day between full capacity and 75% capacity. Extreme caution must be exercised for these practical set of capacities and cascading schemes. Instead, they must be selected after an hourly load-based economic analysis, with an objective of achieving a simple return period of at most four years.

3.2 Automation

Without a dedicated general automation system, a 4DE system will not operate successfully. A novel automation system was developed for the ESER LEED Platinum Building in Ankara Turkey, keeping in mind that the same algorithm is expandable to the district level. A green and hybrid electromechanical system consists of several energy sources, energy conversion systems, and varying time based performance values, as a requirement of the system. Eser Green Building is also designed and constructed as a high performance green building and has various green and hybrid systems incorporated within its electromechanical structure. The building has platinum certification from LEED. Winter and summer operation diagrams of ESER Green Building are given in Figure 1 and Figure 2. It is almost impossible for these different systems to work together in harmony and supply various energy and power demands of the building and achieve the desired energy savings with the use of the existing Building Management Systems. An automation algorithm for high performance buildings, based on exergy balance between **supply and demand** was developed. This software is called as “Rational Exergy Automation (AEO) Program”. The main objective of the algorithm is to deliver exergy from on-site sustainable systems and other equipment to various demand points with maximum supply and demand exergy balance. Increasing the balance reduces exergy destructions and thus compound CO₂ emissions. The method is based on Rational Exergy Management Model (REMM).

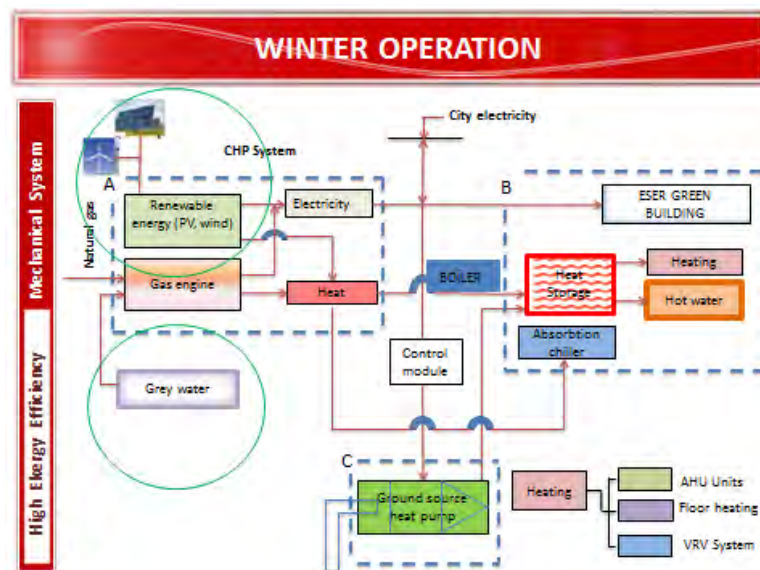

Figure 7: Winter operation scheme for the district

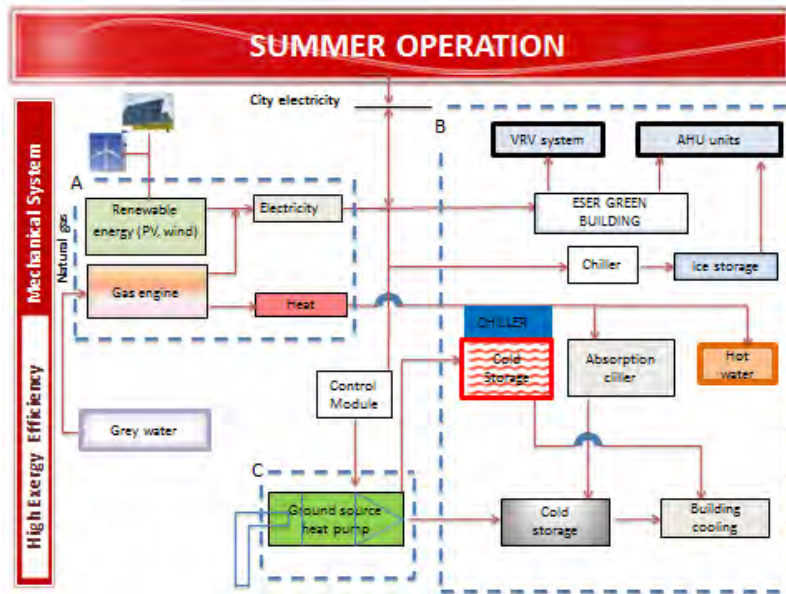

Figure 8: Summer operation scheme for the district

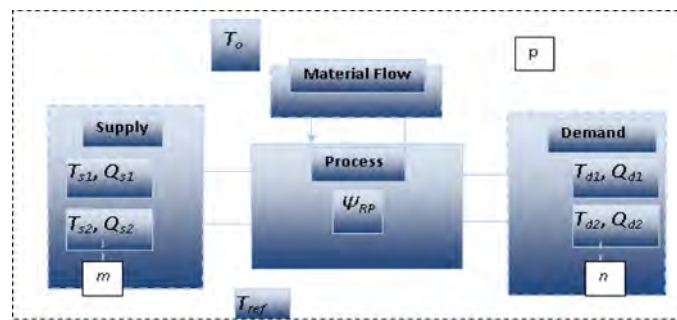

Figure 9: Basic REMM Block

$$\bar{\Psi}_R = \frac{\sum \Psi_{ij} \times \frac{Q_{ij}}{\eta_{ij}}}{\sum \frac{Q_{ij}}{\eta_{ij}}}$$

Equation 7

Equation 7 gives the overall REMM efficiency of the district with m supply points and n demand points. If there are a colocation of sub-districts, then p is the number of sub-districts.

4. CONCLUSIONS

In this paper the importance of exergy rationality in net-zero or near-zero buildings connected to 4DE systems was discussed and new definitions were made. It has been shown that net-zero or near-zero exergy building definitions are more realistic and definitive compared to the DOE definition. In the same token, CO₂ emissions need to be calculated according to both First and Second Laws of thermodynamics. In this respect a new zero carbon definition was also made, which supersedes previous definitions, being developed only in terms of the First-Law.

5. SYMBOLS

- c Ratio of the selected CHP power generation capacity to the peak power demand
- c_i Unit CO₂ emissions of any fuel combustion (i), kg CO₂/kW_h-h
- C Power to heat ratio of CHP, dimensionless
- $CHPE\eta$ Partial electrical power generation efficiency of CHP, dimensionless

$CHPH\eta$	Partial thermal power generation efficiency (including steam) of CHP, dimensionless
CO_2	Carbon dioxide emission, kg CO_2
EDR	Ratio of carbon CO_2 emissions difference to the base emission, dimensionless
E_x	Exergy, kW or kW-h
IF	Operating factor, dimensionless
OF	Objective function, dimensionless
PES $REMM$)	Primary energy savings percentage (According to Rational Exergy Management Model,
Q	Thermal load, kW-h
$RefE\eta$	Reference value for partial power generation efficiency of CHP, dimensionless
$RefH\eta$	Reference value for partial thermal generation efficiency of CHP, dimensionless
T	Temperature, K

Greek Symbols

$Ref\psi_R$	Reference value of ψ_R , 0,2
η	First-law efficiency, dimensionless
η_{EX}	Second-law efficiency, dimensionless
η_T	Power transmission and distribution efficiency (Equation 2-a)
ψ_R	Rational exergy management efficiency, dimensionless
ϵ_{dem}	Unit demand exergy, kW/ kW, or kW-h/ kW-h
ϵ_{des}	Unit destroyed exergy, kW/ kW, or kW-h/ kW-h
ϵ_{sup}	Unit supplied exergy, kW/ kW, or kW-h/ kW-h

Subscripts

E	Electric
H	Thermal
l, m	Local power plant, distant power plant, respectively
P	Peak
ref	Reference
sup	Supply

Superscripts

j, l	Correlation parameters in Equation 4-b
--------	--

Abbreviations

ABS	Absorption chiller
AFT	Adiabatic flame temperature, K
AC	Air conditioning
ADS	Adsorption chiller
CHP	Combined heat and power
CWT	Cold water tank
DHW	Domestic hot water
DOE	US Department of Energy
HVAC	Heating, ventilating, air-conditioning
HE	Heat Exchanger
HWT	Hot water tank
IT	Ice tank
LowEX	Low-exergy
Mtoe	Megaton of oil equivalent (According to First Law)
MtoEX	Megaton of oil equivalent exergy (According to Second Law)
nZCB	Near-zero carbon building
NZCB	Net-zero carbon building
NZEXD	Net-zero exergy District
NZEXB	Net-zero exergy building
nZEXB	Near-zero exergy building
<i>OF</i>	Objective function
ORC	Organic Rankine cycle
PV	Photo-voltaic
PVT	Photo-voltaic-thermal
PVTC	Photo-voltaic-thermal-cooling
PHVT	Photo-thermal-voltaic-heat
REMM	Rational Exergy Management Model
TES	Thermal energy storage

REFERENCES

- [1] **Kılış, B. and Ş. Kılış, Cogeneration with Renewable Energy Resources** (in Turkish), 373 pages, TMD Pub. No. 32, Doğa Yayıncılık, İstanbul, Turkey, 2016.
- [2] **Goran, G., Kılış, Ş., Krajacic, G., and Duic, N., Campus and Community Micro Grids Integration of Building Integrated Photovoltaic Renewable Energy Sources - Case Study of Split 3 Area, Croatia - Part A**, Thermal Science, January 2016.
- [3] Kilkis, S., Energy System Analysis of a Pilot Net-Zero Exergy District, Energy Conversion and Management, 87. p.p. 1077-1092, 2012.
- [4] U.S. DOE., 2015 Energy Efficiency and Renewable Energy, a Common Definition for Zero Energy Buildings, September 2015.
- [5] **Kılış, Ş., A net-zero building application and its role in exergy-aware local energy strategies for sustainability**, Energy Conversion and Management, Volume 63, November 2012, pp. 208–217, 10th International Conference on Sustainable Energy Technologies (SET 2011), 2012.
- [6] Marszal, A. J. and P. Heiselberg, Zero Energy Building Definition- a literature review. Joint Project- Task 40/Annex 52 Net Zero Buildings, SHC, 2011.
- [7] Kilkis, S., Sustainable Development of Energy, Water and Environment Systems Index for Southeast European Cities, Journal of Cleaner Production,
- [8] **Kılış Şan, Kılış Şiir, 2015, Benchmarking Districts Based on a Sustainability Ranking Index**, Journal of Cleaner Production, p.p. 1-12, 2015.
- [9] Kilkis, B., 2016, An Economic Analysis Tool for Tri-generation Systems in Net-Zero Exergy Buildings (NZEXB), Proceedings on usb, XII th Int. HVAC+R Symposium, TTMD, 31 March- 2 April 2016.
- [10] **B. Kilkis, Şefik B. , and A. Gülbeden, An Exergy-Based Automation System in ESER LEED Platinum Building**, Proceedings on usb, XII th Int. HVAC+R Symposium, TTMD, 31 March- 2 April 2016.

The Application of Solid Oxide Fuel Cells in Buildings for Electricity, Heating and Cooling Tri-generation Using Bio-gas from Food Waste

WANG Qiancheng^a, CHEN Bin^b, NI Meng^c, Valeria Isabel ALVARADO ROMAN^d, XU Haoran^e, QIN Weicong^f, WANG Yitian^g

^a Department of Building Real Estate, The Hong Kong Polytechnic University, Hong Kong SAR, wangqiancheng1996@163.com

^b Department of Building Real Estate, The Hong Kong Polytechnic University, Hong Kong SAR, chenbinxjtu@gmail.com

^c Department of Building Real Estate, The Hong Kong Polytechnic University, Hong Kong SAR, bsmengni@polyu.edu.hk

^d Department of Civil and Environmental Engineering, The Hong Kong Polytechnic University, Hong Kong SAR, valeria.alvarado.viar@gmail.com

^e Department of Building Real Estate, The Hong Kong Polytechnic University, Hong Kong SAR, xuhaoran0731@gmail.com

^f Department of Building Real Estate, The Hong Kong Polytechnic University, Hong Kong SAR, jackqwc@hotmail.com

^g Xi'an Shaangu Power Co., Ltd, Xi'an, Mainland China, yitian2892@163.com

ABSTRACT

Organic waste has been a major concern in Hong Kong in terms of environmental aspect. Waste-to-Energy system might be an effective solution. By using the bio-gas generated by the Waste-to-Gas system as fuel for SOFC-TG, most of the organic waste could be recycled. The solid oxide fuel cell-based trigeneration energy system (SOFC-TG) is a promising energy solution for green residential buildings. Cooling, heating, and electricity generating can be achieved at a high efficiency with SOFC-absorption cooling trigeneration configuration in the context of Green building and high performance building. The fuel flexibility is a distinguished advantage of SOFC system operating at high temperature, making the bio-gas produced from wastes an attractive alternative to commercial nature gas (e.g. TownGas, Inc) as the fuel for SOFC-TG system in residential building application. This study focuses on the integration of SOFC-TG system with the Distributed Waste Treatment (DWT) system for simultaneous waste treatment and energy recovery. A case study is used for systematic energy analysis to evaluate its feasibility in HK. Series of surveys were arranged to discuss the potential development and constraints for the system.

Keywords: solid oxide fuel cell, tri-generation, waste-to-energy/ waste-derived energy

1. INTRODUCTION

The environmental problem and energy crisis are recognized as the serious global issues after 2015 United Nations Climate Change Conference. Hong Kong, as one of the most densely populated regions, creates 14,300 tons landfilled waste per day (AU, 2015), and consumes 162,356 tera-joules electric power ("Hong Kong Annual Digest of Statistics," 2016). Establishing the building integrated Distributed Waste Treatment (DWT) and Distributed Energy Resource (DER) system offers a promising method for effective waste treatment and energy generation simultaneously.

The organic waste such as food waste contributes to 37% of total landfilled waste but only 6.9% of the food waste was recycled (AU, 2015). Sending the organic waste to the landfill stations not only increases the environmental burdens, but also waste the valuable organic components, as they can be used as useful resources for energy generation or other products. The distributed anaerobic digestion system can treat the organic waste and generate biogas which can be used as a fuel for Solid Oxide Fuel Cell (SOFC) (Chen and Ni, 2014). SOFC is a promising energy conversion device with an efficiency (about 50%) higher than conventional heat engines (typically below 40%). The SOFC-based multi-generation system combining electrochemical power generation and waste-heat recovery can achieve a much higher energy efficiency (i.e. 70 - 95%). The biogas-and SOFC-based tri-generation system with heating, cooling and electricity generation is recognized as one of possible building integrated energy system for its high energy efficiency, low operating cost, quiet operation and low noxious-gas emission.

Although Waste-to-energy (WtE) is an active research area, the building-integrated WtE (BIWTE) system for Distributed Waste Treatment (DWT) and energy generation has rarely been studied to fill this research gap, this study focuses on the integration of SOFC-based trigeneration system with the DWT system for simultaneous waste treatment and energy recovery. The power consumption data of Hotel Icon is used as a case study for systematic energy analysis to evaluate its feasibility in HK. In addition, series of surveys were arranged to discuss the potential development and constraints for the system.

2. WASTE-TO-ENERGY SYSTEM

The proposed BIWTE system consists of a waste-to-gas DWT system and an SOFC-based tri-generation sub-system proposed by Chen et al (Chen & Ni, 2014). The waste-to-clean biogas system consists of the adapted waste-to-biogas system (Curry and Pillay, 2012); and the biogas treatment system (De Arespacochaga et al., 2014), as shown in Figure 1. The two main sources of waste in the system proposed are food waste (FW), from restaurants such as Green or The Market at Hotel ICON, and the hypothetical sludge in anaerobic digestion from an on-site wastewater treatment.

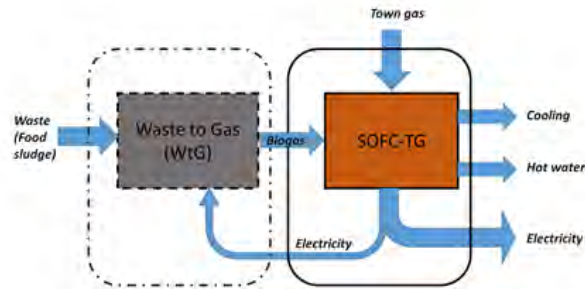

Figure 1: Schematic of the waste to power system based on SOFC-trigeneration

The waste-to-biogas system refers to the anaerobic digestion system for the urban environment by Curry and Pillay (2012). Yet, some modifications were integrated from the original design, such as the excess liquid from the dewatering process is aerated and solely sent to the sewage urban system instead of being recirculated or being used as fertilizer. In addition, the H_2S removal system proposed by the author will be substituted by the system of De Arespacochaga et al. (2015). The biogas treatment system is taken as the original one; including the polishing system configuration based on adsorption technologies by De Arespacochaga et al. (2014).

2.1 Waste-to-Gas (WtG) system

Food waste management has been of great concern for Hong Kong authorities. In 2013, Hong Kong generated 1.36 million tonnes of food waste, of which 1.33 million tonnes (98%) were disposed of at landfills (Audit Commission 2015). Hong Kong is a densely populated city with limited land resources. Thus, alternatives for food waste treatment have been encouraged by Hong Kong Government. The idea of the hypothetical sludge, in anaerobic digestion from an on-site wastewater treatment, is based on existing systems in high performance buildings [e.g. Solaire in the USA (ASHRAE 2008), Business Complex (Kimura and Funamizu, 2012), OHSU Center for Health and Healing (SPU and USMB, 2008), Ikebukuro Sunshine City, and Tokyo Dome (Udagawa 1994) in Japan]. In general, the buildings with on-site wastewater treatment use septic tanks to contain the sludge till a mobile sludge removal vehicle takes it out from the building (Matsuo 2000); or sent back to the city through the sanitary system (ASHRAE 2008). Yet, some buildings in Japan stabilize the sludge in night soil treatment facilities where biosolids are recycled for biogas yield for energy, compost, agriculture, and cement manufacturing (Gaulke, 2007). In this system both types of waste are utilised for anaerobic digestion due to their biogas yield potential.

2.2 Waste-to-Gas (WtG) system

Curry and Pillay (Curry & Pillay, 2012) studied food waste as a sole substrate for anaerobic digestion. The study reviewed the technologies for biogas production from food waste, from which the experimental estimation of 367 m^3 /tonne volatile solids (VS) was recommended by the Environmental Protection Agency (EPA) for mixed food waste biogas generation (65% CH_4 and 35% CO_2). In other study, the biogas generation could reach 1063 m^3 /tonne VS (Prabhu & Mutnuri, 2016). Additionally, the energy value for food waste biogas with 65% methane is considered as 6.25 kWh/m^3 (Curry & Pillay, 2012).

This study proposes the co-digestion of food waste with sewage sludge for biogas generation. Anaerobic co-digestion is a process where two or more substrates with complementary characteristics are mixed for combined

treatment. Prabhu and Mutnuri (Prabhu & Mutnuri, 2016) studied the co-digestion of food waste and sewage sludge. The results of the study showed that for pilot scale digestion a mixing ratio of 1:2 and loading rate of 1g VS/Ld gave the maximum biogas production of 742 ml/gVS Ld with a methane content of 50%, followed by 2 g VS/Ld with biogas yield of 539 ml/gVS Ld. The loading rates are within the range recommended in literature review of 1-5 kgVS/m³ (Curry & Pillay, 2012).

Co-digestion of FW with sludge has several advantages such as higher CH₄ yield at a proper mixing ratio, an accelerated methane production rate, handle two different waste streams, and reduce the costs of food waste management (Prabhu & Mutnuri, 2016; Schiettecatte, Tize, & De Wever, 2014). For example, the FW co-digestion in the pilot project of East Bay Municipal Utility District (EBMUD) in California, USA experienced a three-fold CH₄ yield, better performance from the machines, and costs savings from on-site electrical and thermal generation (Gill-Austern, 2011).

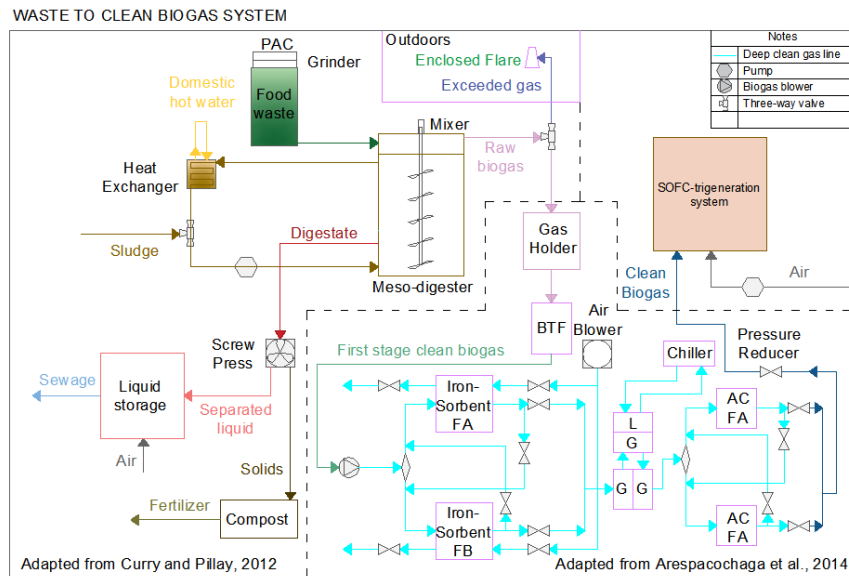

Figure 2: Schematic of the Waste-to-Energy (WtE) system

Researchers (Heo, Jeon, Lee, Kim, & Lee, 2003) studied different food waste and activated sludge co-digestion ratios in a single-stage anaerobic co-digester. The food waste used by the author was simulated Korean food waste which is similar in characteristics with Hong Kong food waste (Zhao & Deng, 2014). The highest methane production rate, with hydraulic retention time (HRT) of 10 days, was present for the ratios of 50:50 and 30:70 with 1.150 and 0.601m³CH₄/m³day, respectively. The organic loading rate varied from 3.14 to 2.60 kgTVS/m³ day. The design of the anaerobic digester in this paper is based on the considerations mentioned above, the daily amount of food waste generated by the hotel is 4300 kg, assuming the food waste mainly comes from 528 consumers (5 kg per person per day) and 1,100 staff (1.5kg per person per day). The required activated sludge for co-digestion ranges from 6.02 Ton/day to 4.3 Ton/day. Ideally the mixing ratio should be kept 50:50, but the food waste supply might fluctuate at the Hotel ICON. Thus, the anaerobic digester is designed with maximum flow allowed, while the methane production rate considers a range of the probable mix ratios possible. The volume of the reactor considers a maximum flow of 8.6 Ton/day and HRT of 10 days. The total working volume with a maximum flow would be 86 m³ ~90 m³. The methane production rate ranges from 98.9 to 51.7 m³CH₄/day. The methane content ranges from 63.3 to 70.4%. Thus, the total biogas production rate varies from 156 to 73.42 m³ biogas/day.

The space required for the installation is based on Tsang et al 's calculations (Tsang, 2013) of a 70 m³ anaerobic digester. The system in this paper is about 22% larger than the system in Tsang's work. Thus, the space required for the anaerobic digester is 44 m², biogas holder is 31 m², food waste tank is 7.5 m², enclosed flare is about 6m², and auxiliary equipment around 10 m². The total space required would be around 100 m² including indoor and outdoor components.

2.3 Biogas treatment system

The biogas produced by the waste-to-biogas system includes several gases that could affect the performance of the SOFC. In particular, H_2S concentration should be reduced to avoid any SOFC deterioration. The biogas **treatment system based on Arespachochaga's work (de Arespachochaga et al., 2015)**, is a previously studied option to clean the biogas and make it more compatible for SOFC. The results showed that after the polishing system the clean CH_4 concentration ranged around 55.1-57.8%. Thus, based on that assumption, the biogas treatment system with the best conditions can provide 108.33 L biogas/min with 62.62 L CH_4 /min, and with the less optimum conditions it can provide 51 L biogas/min with 28.09 L CH_4 /min to the SOFC system. An important consideration for the performance of the SOFC is that the cleaned biogas might include around 7.5-12.5% of N_2 and 1.8-2.9% of O_2 .

2.4 SOFC-TG system

Solid Oxide Fuel Cells (SOFCs) as an efficient energy converter, are superior over other types of fuel cells, in case of biogas feeding operation. Its fuel flexibility benefits from its ability of internal reforming at its high operating temperature (600-800°C), with proper catalysts such as Nickel.

Biogas produced from waste treatment, compose of about 60% CH_4 is a good fuel option for SOFC, with necessary pre-treatment such as desulfuration and drying process. Compared to other biogas exploitation systems such as direct combustion systems (Bruno, Ortega-López, & Coronas, 2009), stationary/mobile internal combustion engines (Basrawi, Yamada, Nakanishi, & Katsumata, 2012; Colmenar-Santos, Zarzuelo-Puch, Borge-Diez, & García-Diéguez, 2016), upgrading system to natural gas grid, SOFC has advantages such as high energy efficiency, low carbon emission, silent operation, etc. These features make the SOFC suitable for distributed cogeneration system for residential applications.

Pilot biogas-powered SOFC plants were installed and demonstrated to be successful. In Chabloz, Switzerland, farm biogas was used to power a 1 kWe SOFC, for more than 5000 hours starting from 2001 (Basrawi et al., 2012). In 2008, Acumentrics (Westwood, USA) launched two 5 kWe biogas-fed SOFCs (BIO-SOFC project, LIFE06 ENV/E/000054) in Barcelona and Stockholm ("Laymen's Report,"). Another biogas-powered SOFC pilot plant was installed at Mataró which collected wastewater from different towns and villages in the Maresme region of Barcelona, Spain (de Arespachochaga et al., 2015).

Bloom Energy, the leading SOFC power module supplier, claim that their SOFC system can directly fed with natural gas, or even biogas for 10 years life-span (Devlin, 2013). The electricity efficiency can reach 56 - 60%, while the overall energy efficiency can be improved to over 80% for cogeneration.

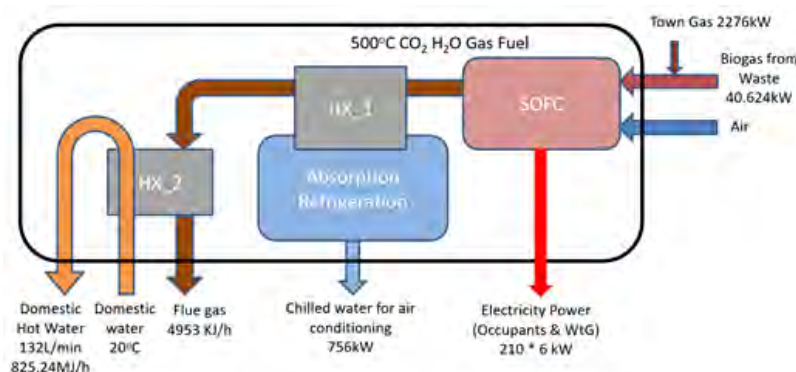

Figure 3: Schematic of the GtE system (SOFC-trigeneration)

In distributed systems, the high temperature waste heat from SOFC can be recovered by refrigeration cycles, turbine, or hot water generators, to achieve a higher system efficiency (even above 90%). Besides, in distributed applications, the need for cooling, hot water and electricity can be partly fulfilled by the tri-generation system at the most time. In this study, a tri-generation system is developed based on 6 units of 210KW SOFC server (ES-5700) from Bloom Energy. The fuel gas to power the SOFCs are the cleaned biogas produced from the Waste to Gas process as introduced in Section 2.1. The configuration of the Gas to Power process are partly adapted from Chen et al's work, as shown in Fig. 3 to briefly described belloved.

According to the energy utility analysis from HOTEL ICON's management data, a nominal 1210KW electricity power is in demand with a conservative regard to its monthly fluctuation see Figure 4 (ICON, 2016). The SOFCs mainly use the Town gas (a heat value at 17.27MJ/m³) from commercialized pipeworks of Town gas. Inc as the fuel to provide an equivalent 2276KW energy flow into the SOFCs. The composition of Town gas can be referred to Table 1 ("Gas Production of Towngas,").



Figure 4: Hotel ICON's electricity demand report, with a monthly average 1210 KWh (ICON, 2016)

Town Gas Characteristics	CO ₂	CH ₄	H ₂	N ₂ +O ₂
Volume fraction	16.3% – 19.9%	1.0% – 3.1%	28.2% – 30.7%	46.3% – 51.8%

Table 1: Town gas characteristics ("Gas Production of Towngas,")

It is important to note that the by-product of waste treatment process: biogas could be another option to power the SOFCs at an optimistically estimated flow rate of 108.33 L/min. The equivalent energy inflow of biogas can be calculated as 40.62 KW. In view of the small amount of biogas production compared to the overall fuel demand by SOFCs, the biogas here only act as an assisting fuel (1.75% of the total fuel heat value), due to the enormous electricity demand by the hotel. The authors hold the view that the waste treatment of residential buildings could be distributed by the combination of WtG and GtE process as demonstrated by this study, though the waste amount cannot fully sustain the hotel power operation, even when the high efficiency SOFC is used. However, in this concept of distributed waste treatment, implicated waste treatment issue are expected to be cut, such as labour cost in waste collection, transportation cost, land source in high density cities where landfill is the prevailing solution to waste treatment, i.e. Hong Kong.

In this study, an absorption refrigeration system (Broad X Non-electric Chiller) manufactured by Broad Group ("Broad Air Conditioning, Borad X Non-electric Chiller (Model Selection & Design Manual),") is chosen to server for the first stage waste heat recovery of the SOFC flue gas. The 500oC flue gas consists of H₂O and CO₂ would exchanging heat with the absorption chiller, leveraged a 756KW cooling capacity in form of chilled water. **Consequently, HOTEL ICON's cooling demand can be relieved with 756KW using this absorption chiller. The** outflow temperature of flue gas after this first stage heat recovery would be reduced to 160oC. Then the second stage heat recovery will further cools down the temperature to 60°C, generating domestic hot water at a rate of 132L/min.

3. POTENTIAL DEVELOPMENT AND CONSTRAINTS

To investigate the feasibility of combing system in Hong Kong, series surveys are conducted involving experts and potential users. The viewpoints of respondents are noted to discuss technical and legal constraints and the potential market in Hong Kong business environment.

3.1 Technology obstacles and potential market

Some technical defects obstacles limit the actual performance of Waste-to-biogas system combining with the SOFC-TG system. Extra-supports should be provided to control the concentration of sulfide to maintain normal operation and realize satisfactory lifespan of the system. In addition, the fluctuation of power supply and consumption should be considered seriously. Further study is requisite in the simulation tests of combining system.

Moreover, space limitation and unaffordable reinstallation cost extend pay-off period, which might reduce the **clients' interest. Majority of respondents prefer projects with short pay-off period** (less than five years) due to the lucrative purpose and insufficient supporting funds. On the other hand, the development of DER has raised the importance of waste-to-biogas and new generation fuel cells. Considering the optimistic prospect, majority of respondents have indicated their interests in the application of this system.

3.2 Government supporting and legal constraints

With the advancement of environmental awareness, series of ordinances such as Building Energy Efficiency Ordinance, Building (Energy Efficiency) Regulation, and BEAM-Plus standard were established by Hong Kong government to ensure the rational energy utilization. The Waste Reduction Framework Plan is introduced to encourage the Waste-to-energy. It is agreed that this system could improve energy efficiency and waste recycling performance of buildings and it might obtain financial support funds from the government and social organizations.

Power generation in private sector is cramped by legal restrictions in Hong Kong (Chen and Ni, 2014). Nevertheless, the progressive liberalization of private power generation has achieved a desirable result in mainland China and some European Countries, where established policies to support the BIWTE. Respondents suggested that the operators of this system should obtain the permission from the government in the current legal environment.

4. CONCLUSION

The SOFC-TG and Waste-to-Gas (WtG) system is a possible contribution for remitting environmental and energy crisis. This study is set to investigate the potential development of the combining system from both technical and social concern in hope of searching for available solutions of food waste problem and resource exhaustion. Hotel is selected as the main object of this study for its stable organic waste output and energy demand and the Hotel ICON is analysed as a case study to investigate the application condition in Hong Kong. Based on the current situation, the waste-to-gas system can treat around 4300kg daily organic waste and product 108.33 L/min biogas, the equivalent energy inflow of biogas can be calculated as 40.62 KW. With the fuel of biogas and town gas, the system can realize satisfactory efficiency (50%-80%). However, within the surveys with potentials users and technical experts, the overcoming of technical, legal and social constraints of the combining system is indispensable. If the above aspects are addressed, the SOFC-TG with WtG system is promising for building integrated application in Hong Kong and even around the world.

REFERENCES

- [1] AU, I. E. W. K. (2015). Development of Waste-to-Energy Facilities in Hong Kong (E. P. Department, Trans.).
- [2] Basrawi, M. F. B., Yamada, T., Nakanishi, K., & Katsumata, H. (2012). Analysis of the performances of biogas-fuelled micro gas turbine cogeneration systems (MGT-CGSs) in middle-and small-scale sewage treatment plants: Comparison of performances and optimization of MGTs with various electrical power outputs. *Energy*, 38(1), 291-304.
- [3] Broad Air Conditioning, Broad X Non-electric Chiller (Model Selection & Design Manual). Retrieved 30/09, 2016, from <http://www.broad.com/index.html>
- [4] Bruno, J. C., Ortega-López, V., & Coronas, A. (2009). Integration of absorption cooling systems into micro gas turbine trigeneration systems using biogas: Case study of a sewage treatment plant. *Applied Energy*, 86(6), 837-847. doi: <http://dx.doi.org/10.1016/j.apenergy.2008.08.007>
- [5] Chen, J. M. P., & Ni, M. (2014). Economic analysis of a solid oxide fuel cell cogeneration/trigeneration system for hotels in Hong Kong. *Energy And Buildings*, 75, 160-169. doi: <http://dx.doi.org/10.1016/j.enbuild.2014.01.053>

- [6] Colmenar-Santos, A., Zarzuelo-Puch, G., Borge-Diez, D., & García-Diéguez, C. (2016). Thermodynamic and exergoeconomic analysis of energy recovery system of biogas from a wastewater treatment plant and use in a Stirling engine. *Renewable Energy*, 88, 171-184.
- [7] Curry, N., & Pillay, P. (2012). Biogas prediction and design of a food waste to energy system for the urban environment. *Renewable Energy*, 41, 200-209.
- [8] de Arespacochaga, N., Valderrama, C., Peregrina, C., Mesa, C., Bouchy, L., & Cortina, J. L. (2015). Evaluation of a pilot-scale sewage biogas powered 2.8 kWe Solid Oxide Fuel Cell: Assessment of heat-to-power ratio and influence of oxygen content. *Journal of Power Sources*, 300, 325-335. doi: <http://dx.doi.org/10.1016/j.jpowsour.2015.09.086>
- [9] Devlin, P. (2013). Demonstrating the Business Case for Biogas-Fueled Stationary Fuel Cell Power Systems at Wastewater Treatment Facilities. *Proceedings of the Water Environment Federation*, 2013(3), 105-117.
- [10] Gas Production of Towngas. Retrieved 30/09, 2016, from <https://www.towngas.com/Eng/Corp/AbtTG/HKBus/Production.aspx>
- [11] Gaulke, L. (2007). On-site wastewater treatment and reuses in Japan. *Water and Energy Abstracts*, 16(3), 30-30.
- [12] Gill-Austern, D. (2011). From Waste to Energy.
- [13] Heo, S.-J., Jeon, Y.-J., Lee, J.-H., Kim, H.-T., & Lee, K.-W. (2003). Antioxidant effect of enzymatic hydrolyzate from a Kelp, *Ecklonia cava*. *Algae*, 18(4), 341-347.
- [14] Hong Kong Annual Digest of Statistics. (2016). Retrieved 30/09, 2016, from <http://www.censtatd.gov.hk/hkstat/sub/sp140.jsp?productCode=B1010003>
- [15] ICON, H. (2016). Hotel ICON's energy utility report.
- [16] Laymen's Report. Retrieved 29/09, 2016, from http://ec.europa.eu/environment/life/project/Projects/index.cfm?fuseaction=home.showFile&rep=file&fil=LIFE06_ENV_E_000054_LAYMAN.pdf
- [17] Prabhu, M. S., & Mutnuri, S. (2016). Anaerobic co-digestion of sewage sludge and food waste. *Waste Management & Research*, 0734242X16628976.
- [18] Schiettecatte, W., Tize, R., & De Wever, H. (2014). Comparison of costs for three hypothetical alternative kitchen waste management systems. *Waste Management & Research*, 0734242X14554646.
- [19] Tsang, Y. (2013). Feasibility of a food waste to energy system in high-rise buildings. HKU Theses Online (HKUTO).
- [20] Zhao, Y., & Deng, W. (2014). Environmental impacts of different food waste resource technologies and the effects of energy mix. *Resources, Conservation and Recycling*, 92, 214-221.

Building and Community Energy Retrofit Housing in Wales

LI Xiaojun^a, Phil JONES^b, Jo PATTERSON^c

^a Cardiff University, United Kingdom, junglix@cardiff.ac.uk

^b Cardiff University, United Kingdom, jonesp@cardiff.ac.uk

^c Cardiff University, United Kingdom, patterson@cardiff.ac.uk

ABSTRACT

This paper presents a modelling-led approach applied to low carbon innovative housing retrofit practice in Wales, UK. The research has investigated the implementation of combinations of existing and emerging low carbon technologies through a system based approach to optimise the use of energy at the point of generation at both building and community scales. A performance prediction model has been developed to examine the effectiveness of different strategies in relation to energy and carbon reduction. Simulation results of individual building have shown, the retrofits with a net carbon reduction by up to 110% indicating a zero-energy or energy positive performance. **Based on this, further investigation is carried out in retrofitting the whole community towards a 'zero-energy' or 'energy positive' community through a micro-grid connection and storage.** The simulation results show an energy positive performance can be achieved for community 1 under the proposed retrofit scenarios.

Keywords: building energy simulation, energy positive community, renewable energy supply

1. INTRODUCTION

To meet the target of an 80% reduction in the UK's carbon emissions by 2050 (HM Government, 2008), it is crucial to reduce the carbon emission associated with the domestic sector, which accounts for some 29% of the UK's total energy consumption (DECC, 2014a). The housing stock in the UK is replaced with a proportion of only around 1% a year (TRCCG, 2008), it is estimated that 70% of the UK's housing stock that will exist in 2050 has already been built (Wright, 2008). Therefore, it will be necessary to retrofit existing housing, as the CO₂ emission target reductions will not be achieved through new build alone. A growing interest in nearly zero energy or zero energy housing (NZEH or ZEH) has been shown in the past decade, where a number of cases studies worldwide have demonstrated the feasibility. Norton et al. present the design, construction and performance of a three-bedroom Habitat for Humanity net-zero energy home in a cold climate, which generate 24% more energy than it consumed in the first year of operation (Norton et al., 2008). Musall et al. summarizes the research of the International Energy Agency's Annex 52 "Towards Net Zero Energy Buildings", including a comprehensive collection of more than 280 zero energy buildings worldwide, with both existing and new build (Musall et al., 2010). Serghides et al. report that the refurbishment of an old Single Family House in Cyprus into a nearly Zero Energy Building is financially viable (Serghides et al., 2015). In general, the idea is to minimize the need for building energy use through effective energy-efficient strategies before adopting renewable energy technologies to meet the reduced energy requirement, to achieve a nearly zero or zero energy balance between demand and supply, import and export. Energy positive performance could be achieved when more energy is exported compared with that imported over a whole year.

However most near-zero or zero performance has been investigated for new build housing. This paper presents an energy modelling-led approach to investigate energy retrofit housing in Wales, UK, for individual buildings, and community scale with the integration of a micro-grid connection and battery storage. The investigation considers combinations of existing and emerging low carbon technologies through a system based approach, combining reduced energy demand, renewable-energy supply and energy storage.

2. LOW CARBON RETROFIT TECHNOLOGIES

Through proper retrofit strategies, energy use and the resulting carbon emissions of the houses can be reduced significantly. Energy retrofit technologies are designed to reduce energy demand, especially space heating, which comprises around 66% of the domestic energy usage in the UK (DECC, 2014b). Fabric insulation is generally considered to be the most effective strategy. A large number of domestic houses in the UK were built with cavity walls, 60% of which did not have thermal insulation by 2004 (EHCS, 2004). Cavity wall insulation can reduce up to 40% heat loss through the walls (EST EEBPH, 2003). Older houses have solid walls and require external or

internal wall insulation to improve their performance. It is estimated that upgrading an old poorly insulated house to post-1990 standards through roof and wall insulation can reduce heat loss by 50%-80% (Roberts, 2008). However, there are concerns that the insulated wall performance may not be achieved in practice due to construction details and poor workmanship (HM Government, 2015). Insulating existing ground floors can prove disruptive and is only likely to be viable during major refurbishment programmes (Shorrock et al. 2005). Loft insulation is generally easy to apply as a cost-effective measure. Although many lofts already have some level of **insulation, loft 'top-ups' can cost effective, bringing them to a minimum of 270mm loft insulation, the level required** to meet the current Building Regulations in the UK for new build (DECC, 2014c). Improving air tightness can also reduce heat loss from ventilation (Everett, 2007), and can be an ancillary benefit from upgrading the building fabric, particularly windows and doors. Ideally, upgrading the building envelope should be accompanied by improving the heating system, either downsizing the current system, or switching to a more energy-efficient system, with modern boilers achieving over 90% efficiency (Everett, 2007).

Other popular technologies to reduce energy demand include LED lighting, energy-efficient appliances, and Mechanical Ventilation Heat Recovery (MVHR). Most LED light lamps can save over 80% electricity compared to conventional incandescent lamps do (DoE, 2014), and last longer with less maintenance. A notable improvement of energy efficiency has been shown in the appliance market due to technical progress. For example, the average electricity use of an A+++ Panasonic fridge freezer is only 175kWh/yr, while that of an A+ fridge freezer of the same size is 313 kWh/yr. However, the energy use of appliances can vary greatly with occupant behaviour. Mechanical Ventilation Heat Recovery (MVHR) has the potential to reduce heating losses by pre-heating supply air using heat recovered from stale air leaving the property, and improve indoor air quality by providing constant fresh filtered air. It works well in an airtight house, however, for a property with poor airtightness, or if the system is not correctly installed or commissioned, it can increase heating and auxiliary energy demand (White, 2016).

Renewable energy supply can be used to meet the reduced energy demand. The current average annual solar resource in the UK is estimated to be 101W/m² (Burnett et al. 2014), or 2.4 kWh/m²/day. The electricity generated from Solar PV can be stored using batteries, maximising its use onsite, and only surplus power exported to the grid.

3. METHOD

A series of energy retrofits have been studied in Wales (Jones et al. 2016). At the start of each retrofit, a survey was carried out to investigate the current conditions of the property. A combination of energy saving measures were then proposed, combining fabric measures, renewable energy and energy storage, through a systems based approach. A low carbon design approach will firstly reduce internal heat and power loads, followed by passive design, and finally applying efficient heating, lighting and ventilation services, combined with the integration renewable energy supply and storage. Energy simulation models were developed for three houses in order to predict the optimised performance of the houses with appropriate packages of energy saving measures. The best option for each house was identified, in terms of energy consumption, carbon emission and operating cost savings.

These models were then expanded to a community scale, in order to examine their performance in relation to further reducing energy use through micro-grid connection and community scale energy storage. At a community scale, the average household energy performance could be better or worse than that of single build due to a combination of different building types (terrace, semi-detached, detached) and orientations according to the layout. However, there are advantages of sharing renewable energy supply and storage systems, compared to individual building integrated systems, especially where some building may not have an optimal orientation in relation to solar energy systems. Installing PV on both sides of a pitched roof with east-west orientation may even lead to increased energy generation due to the larger PV area.

The simulation tools employed in the research include HTB2 and VirVil SketchUp (Jones et al., 2013). Both HTB2 and VirVil SketchUp were developed at the Welsh School of Architecture, Cardiff University. HTB2 is typical of the more advanced numerical models, using as input data, hourly climate for the location, building materials and construction, spatial attributes, system and occupancy profiles, to calculate the energy required to maintain specified internal thermal conditions (P.T. Lewis, D.K. Alexander, 1990). Due to its advantages of flexibility and ease of modification, it is well suited for use in the field of energy efficiency and sustainable design of buildings, which is rapidly evolving. The software has been developed over thirty years, and has undergone a series of extensive testing and validation, including the IEA Annex 1 (Oscar Faber and Partners, 1980), IEA task 12 (Lomas,

1994) and the IEA BESTEST (Neymark et al., 2011). VirVil SketchUp is an extension development of HTB2 for urban scale modelling. By linking SketchUp with HTB2, it can carry out dynamic thermal simulation for multiple buildings in a community or urban scale, with consideration to overshadowing impacts from the neighbourhood. Based on the output from thermal simulation, hourly energy models were developed to integrate energy demand, supply and storage at both building and community scales.

4. SIMULATION RESULTS

The retrofits are all located in South Wales, UK. Table 1 summarizes the energy saving technologies employed in the retrofits of three houses (Retrofits 1, 2 and 3), which formed part of the Low Carbon Research Institute (LCRI) SOLCER Retrofit project (funded by the European Regional Development Fund (ERDF)). Table 2 summarizes the proposed optimisation strategies for the three communities. The three communities are based on existing layouts for Retrofit House types 1, 2 and 3.



	Retrofit 1	Retrofit 2	Retrofit 3
			
Basic information	2000's, 3-bed filled cavity wall 86m ² semi-detached, southeast facing, with gas heating.	Pre-1919, 2-bed 74m ² solid wall, mid-terrace south facing, with gas heating.	1950's, 3-bed 80m ² cavity wall semi-detached southeast facing, with gas heating.
Energy-efficient strategies	a. loft insulation; b. LED lighting; c. new gas boiler and hot water tank.	a. rear external wall insulation, front internal wall insulation; b. loft insulation; c. LED lighting.	a. external wall insulation; b. loft insulation; c. LED lighting.
PV	4.5 kW _p PV roof.	2.6 kW _p PV roof.	3.97 kW _p PV roof.
Energy storage	Lead acid battery with 18kWh storage.	Lithium battery with 2.0 kWh storage.	Lithium battery with 10kWh storage.

Table 1: Information summary of the retrofits

	Community 1 (retrofit 1)	Community 2 (retrofit 2)	Community 3 (retrofit 3)
House age and building type	2000s, Semi-detached Detached Mid-terrace	Pre-1919, Middle terrace End terrace	1950s, Semi-detached Detached Mid-terrace
Total floor area	4969 m ²	9200 m ²	10064 m ²
The energy efficient components	The performance of all properties upgraded to that of retrofit 1: Wall U-value (0.26 W/m ² .K), Window U-value (2.0 W/m ² .K), 300mm loft insulation, LED lighting, Efficient system boiler.	The performance of all properties upgraded to that of retrofit 2: Wall U-value (0.38 W/m ² .K), Window U-value (2.0 W/m ² .K), 300mm loft insulation, LED lighting, Efficient combi-boiler.	The performance of all properties upgraded to that of retrofit 3: Wall U-value (0.20 W/m ² .K), Window U-value (2.0 W/m ² .K), 300mm loft insulation, LED lighting, Efficient combi-boiler.
PV	312 kW _p PV roof.	389 kW _p PV roof.	452 kW _p PV roof.
Battery (Community scale)	Lithium battery: 290 kWh	Lithium battery: 220 kWh	Lithium battery: 360 kWh
Further optimisation strategies	PV applied on both roofs for east-west oriented houses.	PV area tailored according to roof size, to reduce roof losses due to standardised module sizes as shown in Table 1.	PV applied on both roofs for east-west oriented houses.

Table 2: Information summary of the communities

4.1. Retrofits 1, 2 and 3 results

Figure 1 presents the overall annual savings of the three retrofits. The electricity savings are between 55% and 90% with the higher saving associated with more electricity demand met by PV supply. Gas savings are highest for retrofit 2, where insulation has been applied to solid wall pre-1919 houses. CO₂ emission reductions are in excess of 70% for all three retrofits, and exceeding 100% for retrofit 3, indicating an energy positive performance. All retrofits have high cost savings indicating an income generation from exporting electricity to the grid. The results also indicate the reduced contribution to (gas) heating from lighting following the application of LEDs. Where the PV is used to contribute to DHW (immersion) heating for retrofit 1 which has a hot water tank, further gas savings of 17% are predicted (the other two retrofits have combi-boilers with no hot water storage). Table 3 summarizes the predicted annual performance of the retrofitted properties. An electricity self-sufficient ratio of more than 85% can be achieved by retrofit 1 and 3, indicating their majority of electricity use can be met by PV energy supply and storage.

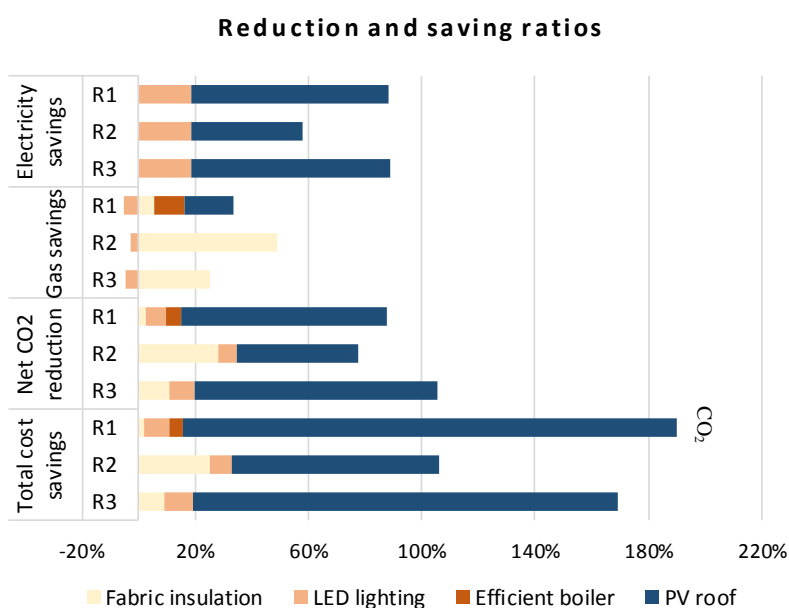

Figure 1: Summary of the predicted performance optimisation of the three retrofits

	Retrofit 1	Retrofit 2	Retrofit 3
Total electricity generation by PV	4493 kWh/yr (52 kWh/m ² /yr)	2572 kWh/yr (35 kWh/m ² /yr)	3916 kWh/yr (49 kWh/m ² /yr)
Electricity generation by PV per kW _p	998 kWh/kW _p /yr	989 kWh/kW _p /yr	986 kWh/kW _p /yr
Electricity from grid	281 kWh/yr (3 kWh/m ² /yr)	1021 kWh/yr (14 kWh/m ² /yr)	268 kWh/yr (3 kWh/m ² /yr)
Electricity to grid	1279 kWh/yr (15 kWh/m ² /yr)	1519 kWh/yr (21 kWh/m ² /yr)	1992 kWh/yr (25 kWh/m ² /yr)
Electricity export to import ratio	4.55	1.49	7.43
Electricity self-sufficient ratio	90%	49%	86%
Electricity demand	1983 kWh/yr (23 kWh/m ² /yr)	1983 kWh/yr (27 kWh/m ² /yr)	1983 kWh/yr (25 kWh/m ² /yr)
Heating demand	4245 kWh/yr (49 kWh/m ² /yr)	3856 kWh/yr (52 kWh/m ² /yr)	3201 kWh/yr (40 kWh/m ² /yr)
Gas supply	3798 kWh/yr (44 kWh/m ² /yr)	4284 kWh/yr (58 kWh/m ² /yr)	3557 kWh/yr (45 kWh/m ² /yr)
Net operating carbon emission	302 kg/yr (4 kg/m ² /yr)	667 kg/yr (9 kg/m ² /yr)	-126 kg/yr (-2 kg/m ² /yr)

Table 3: The predicted energy performance of the properties after retrofit

4.2. Community scale results

Table 4 presents the predicted energy performance of the communities. The potential of PV generation is shown through the visualisation of solar radiation on the roofs, with red indicating the most solar radiation, orange the second most, and green the least. Both red and orange roofs have been considered for PV installation. This explains why there is more electricity generation per household in community 1, compared with the single case in table 3, as PV is considered on both sides of the pitched roofs for almost half the number of buildings, i.e. those with an east-west orientation. Community 1 is 90% self-sufficient in electricity use, and with an annual net CO₂ emission of 588kg/household, indicating an energy positive performance over the year. For community 2, there is an increase of PV generation compared to the performance of the individual Retrofit 2, as a result of the increased PV area per household from further optimisation (see Table 2), contributing to a smaller average net carbon emission. For community 3, it generates proportionally less electricity per household, but uses more electricity and gas, compared with the single build Retrofit 3 (see Table 3). This is due to most buildings in community 3 without an optimal orientation as that of the single build, and only a couple of buildings have both sides of roofs considered for PV installation (see red and orange roofs in Table 3).

	Community 1	Community 2	Community 3
Visualisation of solar potential on the roofs 			
Total electricity generation by PV	5319 kWh/household/yr (61 kWh/m ² /yr)	3103 kWh/household/yr (42 kWh/m ² /yr)	3377 kWh/household/yr (43 kWh/m ² /yr)
Electricity generation by PV per kW _p	980 kWh/kW _p /yr	991 kWh/kW _p /yr	940 kWh/kW _p /yr
Electricity from grid	315 kWh/household/yr (4 kWh/m ² /yr)	1021 kWh/household/yr (14 kWh/m ² /yr)	790 kWh/household/yr (10 kWh/m ² /yr)
Electricity to grid	2444 kWh/household/yr (28 kWh/m ² /yr)	2055 kWh/household/yr (28 kWh/m ² /yr)	2059 kWh/household/yr (26 kWh/m ² /yr)
Electricity export to import ratio	7.76	2.01	2.61
Electricity self-sufficient ratio	90%	49%	60%
Electricity demand	1983 kWh/household/yr (23 kWh/m ² /yr)	1983 kWh/household/yr (27 kWh/m ² /yr)	1983 kWh/household/yr (25 kWh/m ² /yr)
Heating demand	3281 kWh/household/yr (38 kWh/m ² /yr)	4682 kWh/household/yr (63 kWh/m ² /yr)	4162 kWh/household/yr (52 kWh/m ² /yr)
Gas supply	2394 kWh/household/yr (28 kWh/m ² /yr)	5203 kWh/household/yr (70 kWh/m ² /yr)	4625 kWh/household/yr (58 kWh/m ² /yr)
Net operating carbon emission	-588 kg/household/yr (-7 kg/m ² /yr)	587 kg/household/yr (8 kg/m ² /yr)	340 kg/household/yr (4 kg/m ² /yr)

Table 4: The predicted energy performance of the communities

5. CONCLUSION

The paper has described case studies of a systems approach to low carbon innovative housing, including three retrofits in South Wales, UK. The results indicate that, the combination of reduced energy demand, renewable energy supply and battery storage could reduce net carbon emission by 88%, 78% and 110% for the three retrofits, demonstrating that a near-zero energy and for one case energy positive performance, can be achieved.

There can be added benefits from a community performance compared to an individual house performance due to the increased area of PV applied to different orientations and building type variations (detached, semi-detached, terrace). For some east-west oriented houses, PV applied to the whole roof rather than the south facing side can significantly increase the total electricity generation. Community 1 has the potential to achieve an energy positive performance.

REFERENCES

- [1] Brown, C., Perisoglou, E., Hall, R. et al. 2014. Transpired solar collector installations in Wales and England. *Energy Procedia* 48, pp. 18-27.
- [2] Burnett, D., Barbour, E., Harrison, G.P. 2014. The UK solar energy resource and the impact of climate change. *Renewable Energy* 71, pp.333-343.
- [3] DECC. 2014a. Overall energy consumption in the UK since 1970. In: *Energy consumption in the United Kingdom*. London: DECC.
- [4] DECC. 2014b. Domestic energy consumption by end use 1970 to 2013: Table 3.04.
- [5] **DECC. 2014c. SAP 2012: the Government's Standard Assessment Procedure for Energy Rating of Dwellings**. Watford: BRE.
- [6] DoE. 2014. LED Basics. Solid-State Lighting R&D Multi-Year Program Plan. U.S. Department of Energy.
- [7] EHCS. 2004. EHCS Standard Tables, EE5a: Wall and Loft Insulation by Tenure. English House Condition Survey.
- [8] EST EEBPH. 2003. Cavity Wall Insulation in Existing Housing. Energy Saving Trust, Energy Efficiency Best Practice in Housing.
- [9] Everett, B. 2007. Saving energy-how to cut energy wastage. In: Elliott, D. (Ed.), *Sustainable Energy, Opportunities and Limitations*. Palgrave Macmillan, pp. 108–134.
- [10] HM Government. 2008. Climate Change **act 2008 (c.27)**. UK: **Her Majesty's Stationary Office Ltd**.
- [11] HM Government. 2015. SOLID WALL INSULATION: Unlocking Demand and Driving Up Standards. London: Department for Business, Innovation and Skills.
- [12] Jones, P., Lannon, S., Li, X., et al. 2013. Intensive building energy simulation at early design stage. Presented at: Building Simulation 2013 (BS2013): 13th International Conference of the International Building Performance Simulation Association, Chambéry, France, 25-28 August 2013.
- [13] Jones, P., Li, X., Patterson, J., et al. 2016. Preparation for an energy positive community in the UK: Modelling-led innovative housing practice in Wales. PLEA 2016 Los Angeles, Cities, Buildings, People: Towards Regenerative Environments, Volume 2, pp 1095-1100.
- [14] Lewis, P.T., Alexander, D.K. 1990. HTB2: A flexible model for dynamic building simulation. *Build Environ* 25 (1), pp.7-16.
- [15] Lomas, K. J., et al. 1994, Empirical validation of detailed thermal programs using test room data, Volume 1: Final Report, International Energy Agency.
- [16] Musall, E., et al. 2010. Net zero energy solar buildings: an overview and analysis on worldwide building projects. In: Eurosun, International Energy Agency Solar Heating & Cooling Task40/ECBCS Annex52. Austria, 2010.
- [17] Neymark, J., et al. 2011, IEA BESTEST Multi-zone non-airflow in-depth diagnostic cases, 12th IBPSA, Sydney, 14-16 November 2011.
- [18] Norton, P., et al. 2008. The NREL/Habitat for Humanity Zero Energy Home: A Cold Climate Case Study for Affordable Zero Energy Homes. Golden: National Renewable Energy Laboratory.
- [19] Oscar Faber and Partners. 1980, IEA Annex 1 Computer Modelling of Building Performance: Results and Analyses of Avonbank Simulation, Oscar Faber and Partners, St Albans, UK.
- [20] Roberts, S. 2008. Altering existing buildings in the UK. *Energy Policy* 36, pp. 4482-4486.
- [21] SERGHIDES, D. K., DIMITRIOU, S., KATAFYGIOTOU, M. C. & MICHAELIDOU, M. 2015. Energy Efficient Refurbishment towards Nearly Zero Energy Houses, for the Mediterranean Region. *Energy Procedia*, 83, 533-543.
- [22] Shorrock, L. D., et al. 2005. Reducing Carbon Emissions from the UK Housing Stock. Watford: BRE.
- [23] TRCCG (Three Regions Climate Change Group). 2008. Your Home in a Changing Climate. Retrofitting Existing Homes for Climate Change Impacts.
- [24] White, J., Gillott, M. C., Wood, C. J., Loveday, D. L. & Vadodaria, K. 2016. Performance evaluation of a mechanically ventilated heat recovery (MVHR) system as part of a series of UK residential energy retrofit measures. *Energy and Buildings*, 110, 220-228.
- [25] Wright, A. 2008. What is the relationship between built form and energy use in dwellings? *Energy Policy*, 36(12), 4544–4547.

Geothermal District Heating Investigation of Retired Oil/Gas Wells as Higher-temperature Renewable Heat Sources

GUO Hongshan^a, Forrest MEGGERS^b, KIM Min-gun^c

^a Princeton University, United States of America, hongshan@princeton.edu

^b Princeton University, United States of America, fmegggers@princeton.edu

^c The Hill School, United States of America, kkim@thehill.org

ABSTRACT

Presented in this paper is our investigation on the potential of using existing natural gas and oil wells in the USA to provide high quality geothermal heat. Geothermal heat is renewable energy that can be used from higher temperature sources for direct heating. In the USA and other less thermally active regions, it is most commonly harvested from shallow ground heat exchangers leveraging seasonal average seasonal temperature to maximize heat pump performance. Drilling deeper would provide higher temperatures, but for most projects the drilling and heat pump are significant costs - up to 90% of the total cost of a geothermal system for wells beyond 600m. The state of Pennsylvania has 66,000 active natural gas and oil wells with depths typically greater than 1000m, so how much might we harvest from these wells? Analyzing the recently released data from National Geothermal Data System (NGDS), we found bottom temperatures of 17,467 Pennsylvanian wells with 95% having depths from 1000m to 2500m and 70% having temperatures above 80 °F (**26.6°C**) that could be used in low temperature, low exergy, district heating systems. In this context, linking them to a district heating system would therefore be providing essentially free heat without any drilling costs. This study aims to characterise the geothermal potential that can be exploited and identify potential locations for pilot projects. This is done using criteria including spatially varied demographic profile, heating demand and variable heat loss through possible distribution pipelines. We identified a possible 10% of the heating demand in the state of Pennsylvania could be covered by the 17,476 oil/gas wells should they all become dedicated to geothermal post active-production stage. Cities like Pittsburgh could have a substantial portion of their heating demand supplied. Finally, upon decommissioning, many of these wells often become pathways for methane leakage as sealing is required, but not well incentivised - which would be addressed by further utilisation in our proposed district concept.

Keywords: geothermal, district heating, distributed energy systems

1. INTRODUCTION

Our attention towards geothermal systems is very polarized in the current market. There are emphasis on harvesting the geothermal energy in the form of power generation, eliciting Enhanced Geothermal Systems (EGS) that only counts at the depths deeper than 2km, or on the other side, Ground-source heat pump(GSHP) systems for residential purposes that rarely goes beyond 600ft(182.88m). The in-between is rarely addressed since it is in an awkward area where the temperature recovered is relatively warm while the costs can be exceedingly high. At a depth beyond 600 feet, the majority of the costs can be attributed to drilling, which can make up to 90% of the total costs of the system, mounting to a total of \$500,000 for a system with 1000 feet system. A possible way of reaching the desired depth without investing heavily on the capital cost for geothermal systems is to enlist the boreholes that are out-of commission. This paper sets out to provide an estimate of such geothermal potential from existing oil/gas wells that have been recently made public by the National Geographic Database System(NGDS).

2. BACKGROUND

The state of Pennsylvania has a long history of harvesting oil and gas from the underground. The Marcellus Shale basin was, in fact, found among the conventional boreholes that were thought to have been depleted once. First recognized by the USGS in 2003, the actual capacity of Marcellus Shale basin is expected to reach a mean undiscovered natural gas resource of 84,198 billion cubic feet according to the USGS fact sheet, essentially helped achieving the longed energy independency for the United States.

It is also known, however, that abandoned/depleted wells, despite being plugged with concrete, can be the source of fugitive emissions. This was brought to the attention of researchers when first identified by a PhD thesis in

Princeton University. Her research indicated that even wells that are considered sealed can still have emissions coming out from the bottom of the wells.

Many studies have been done to ensure the proper sealing of the abandoned/inactive boreholes, mostly treating them as a problem to be fixed. But what about taking an active step back and looking at the problem proactively and try to harvest the heat that is available at the bottom of the boreholes? Similar thoughts were pursued by [13] in 2006 using mine water to cool buildings, exploiting the underground mine water's temperature for better performance of geothermal heat pumps.

3. METHODOLOGY

3.1 Visualizing geothermal potential

To visualize the potential that is available from the 17,467 boreholes, a simple extrapolation of the temperature at different depths using linear regression and a resolution of every 100m and plotted in Figure 1.

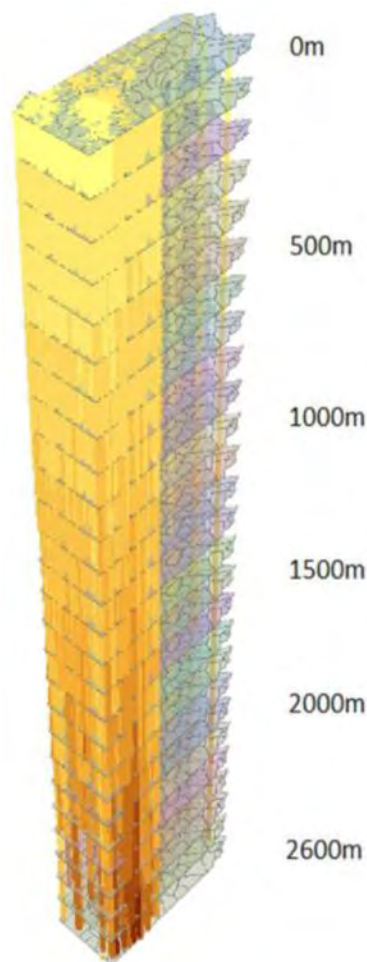

Figure 1: Geothermal potential visualization from 17,467 boreholes through linear extrapolation in ArcScene in Pennsylvania, United States

As the geothermal potential is visualized in three dimensions in ArcScene, aside from the quantitative results that could have been obtained from the data analysis of the temperature profiles in the well logs, the increase of temperature along depths of the boreholes became qualitatively more apparent as the general temperature increase beyond 1,000 meters beyond 20 Celsius can be easily observed - not enough for enhanced geothermal system (EGS), but more than adequate for considering using the geothermal heat for heating rather than power generation. But exactly how much heat can be generated from the 17,467 wells? It is important to identify the available heat that can be harnessed from the boreholes.

3.2 Identifying the available heat

To estimate the supply temperature from boreholes, three cases were established based on different assumptions were used to cover the industry convention, academic estimation and ideal production conditions: For Case 1, the heat extraction rate from the boreholes was assumed to be 50W/m, which would allow the calculation of the flow rates for different boreholes. Case 2 builds on the estimation of the heat extraction from the geothermal heat flow estimation from Pollack et al. at 87 MW/m² to obtain the temperature available from boreholes with the flow rates obtained from Case 1. Case 3 then combines the assumptions from Case 1 and 2 with the 2Sol Coaxial Borehole Heat Exchanger from 2Sol and propose an idealized model that idealize the temperature extracted from the boreholes. The accumulated resulting available heating power can be found in Table 1.

	Case 1	Case 2	Case 3
Heat Extraction Rate	50W/m	87W/m ²	87W/m ²
Heat Exchanger Type	Double U-Tube	Double U-Tube	2Sol CoAxial
Flow Rate (L/s ⁻¹)	7	7	7
Total Heating Power Available (Q _{tot} in GW)	2.47	0.61	0.05

Table 1: Assumptions used to estimate supply distances for three different cases

The available heat numbers are then put into ArcMap for spatial analysis to identify the suitability of the different estimation methods as well as the temperature availability at ground surfaces using the volumetric flow rate and return water temperature as suggested by [7]. We may therefore obtain the heat map of Pennsylvania for the three different cases under the scenario of supplying different temperatures across different counties as shown in Figure 2. This can be used to further analyze the potential of heat supplied to specific households using the overlap with demographic map. To estimate the supply distances, a number of assumptions were made to obtain reasonable accuracy of estimations. As the boreholes would provide up to 13.25 kW of heat, the distribution pipes were assumed to be of a medium sized 80 mm nominal distribution pipes buried with a ground temperature of 8 Celsius. The media pipes are assumed to be placed vertically with the return pipe located closest to the group surface, giving lower heat loss comparing to having the forward pipe on tops or horizontal setup. Assuming the thermal conductivity to be 0.0265 W/(mK), which would give an average heat loss of 18.08W/m according to [4] from Danfoss, which is consistent with [5].

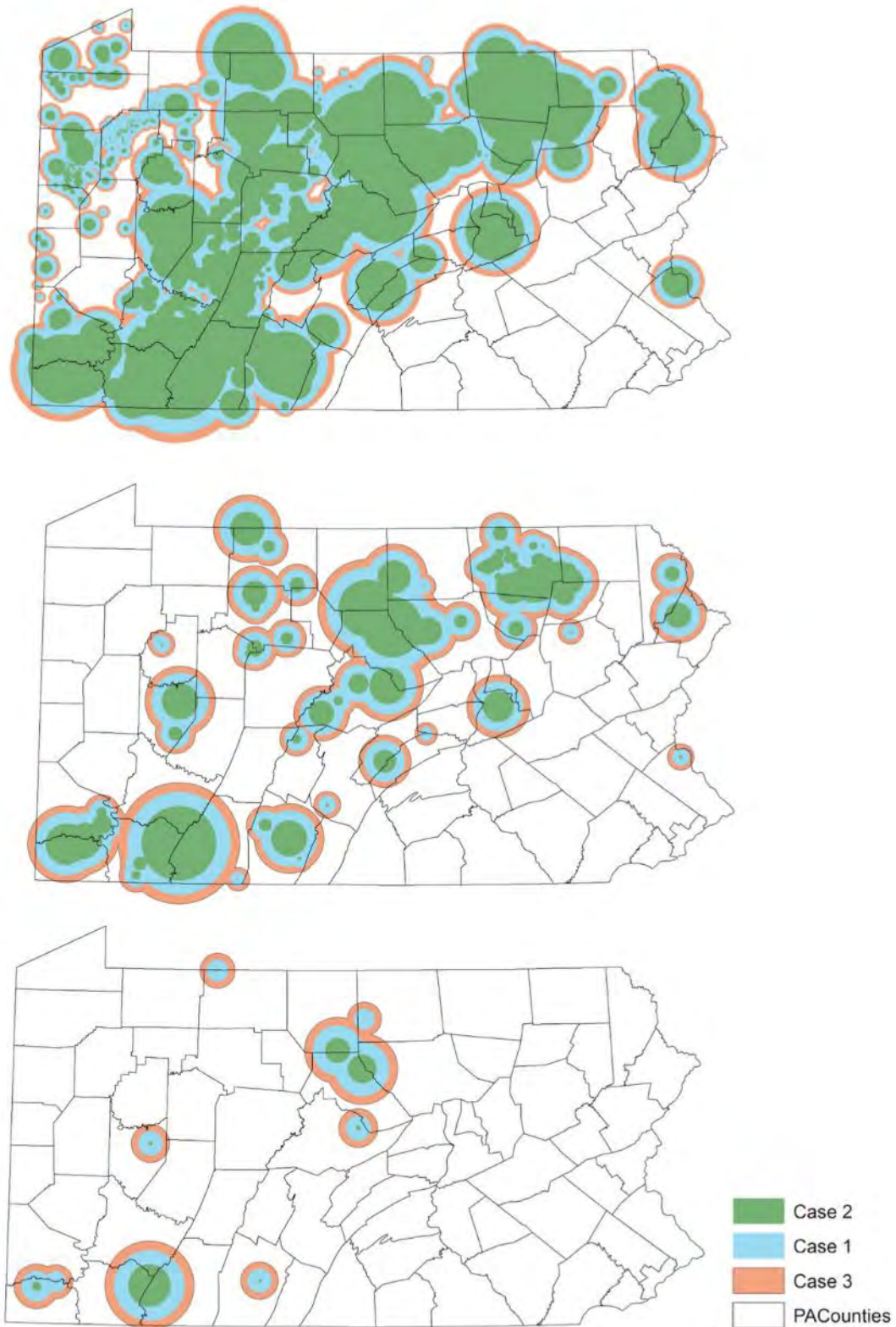

Figure 2: Coverage of supply temperature at 17 °C for heat pump assisted heating (top), 30°C for LowEx direct district heating (middle) and 45 °C for direct district heating(bottom)

3.3 Estimating households covered

To better understand the scope of the problem, the demographic profile of Pennsylvania from the 2010 US census is used to compare against the supply distances from Case 2 to determine the possibility of coverage of the supplied areas. Of the total households of 4,777,003 in Pennsylvania, the total amount of households that can be supplied with different temperature availabilities are therefore determined as indicated in Figure 3:

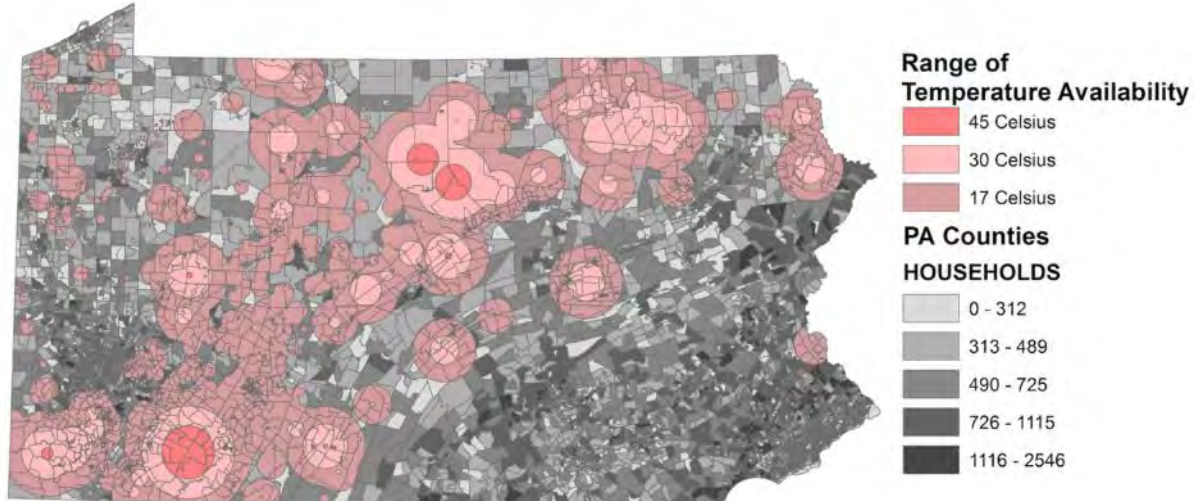

Figure 3: Potential households coverage map using different supply criteria assuming Case 2 scenario.

To put it into a more quantitative interpretation, the information in Figure 3 can be summed up into Table 4.3 as the following:

Supply Temperature (°C)	17	30	45
Percentage of Total Households (%)	858,487	199,019	15,043
Primary Energy Saved (TBTU)	30.3584	6.78	0.53
Million Dolalrs Saved (Million US\$)	632.458	141.25	11.04

Table 2: Comparison of performance under three supply criteria assuming Case 2 scenario.

4. RESULTS AND ANALYSIS

Using simplified assumptions on the power output from the boreholes and the heat loss along assumed distribution lines, it is estimated that using one-fifth of the boreholes (once they are depleted of oil/gas) available in Pennsylvania, up to 17% of the population of Pennsylvania can be supported using small-scale heat pumps, or a 5% of households can be heated without any additional costs of electricity using LowEx district heating. This is a preliminary investigation done to estimate the scope of the project so a few assumptions were made to simplify the analysis, and require further analysis. Further research would include and not limit to: More refined modeling of the distributional losses along the pipelines to provide better power generation and electricity costs estimates such that better return of investment (ROI) can be obtained; better sub-surface extraction estimation techniques that is more tolerant towards different subsurface geological conditions. It would also be valuable to include considerations of the costs that will incur to layout the distribution pipelines to obtain a reasonable ROI for the consideration of investors as well as local authorities.

Despite these limitations, the supply range that was achieved in this paper does come from a mere fifth of all boreholes that are currently active in Pennsylvania. With the increasing number of boreholes that are to be developed in the Marcellus Shale, this number could be continuously on the rise. It is important that we continue to look for means to benefit from the wells beyond production and estimate the potential that is buried underground to gain access to free heat while ensuring no fugitive emissions are escaping from the abandoned wells.

REFERENCES

- [1] Robert B Barsky and Lutz Kilian. Oil and the Macroeconomy Since the 1970s. *Journal of Economic Perspectives*, 18:115–135, December 2004.
- [2] John A Harper. **The Marcellus Shale-An Old "New" Gas Reservoir in Pennsylvania. Technical report, May 2008.**
- [3] Mary Kang. CO₂, Methane, and Brine Leakage through Subsurface Pathways: Exploring Modeling, Measurement, and Policy Options. PhD thesis, Princeton University, May 2014.
- [4] Halldor Kristjansson and Benny Bøhm. Optimum Design of Distribution and service Pipes. In *th International Symposium District Heating and Cooling*, pages 1–11, Hanover, May 2006.
- [5] Tomislav Kurevija, Domagoj Vulin, and Vedrana Krapec. Influence of Undisturbed Ground Temperature and Geothermal Gradient on the Sizing of Borehole Heat Exchangers. In *World Renewable Energy Congress*, pages 1–8. University of Zagreb, Zagreb, Croatia, 2011.
- [6] **Henry N Pollack, Suzanne J Hurter, and Jeffrey R Johnson. HEAT FLOW FROM THE EARTH'S INTERIOR: ANALYSIS OF THE GLOBAL DATA SET.** *Reviews of Geophysics*, 31(3):267–280, August 1993.
- [7] Jasmin Raymond, Serge Mercier, and Luc Nguyen. Designing coaxial ground heat exchangers with a thermally enhanced outer pipe. *Geothermal Energy*, pages 1–14, April 2015.
- [8] Jose Antonio Sanchez. Enhancing the quality of ground coupled heat. PhD thesis, January 2014.
- [9] You Shuang, Li Xiangyu, Gao Yu, and Tang Wendi. Methodology of Shallow Geothermal Energy Projects. *Energy Science Journal*, pages 169–175, December 2014. An Assessment The Open Fuels
- [10] United States Geological Survey. Assessment of Undiscovered Oil and Gas Resources of the Appalachian Basin Province, 2002. Technical report, January 2003.
- [11] United States Geological Survey. Assessment of Undiscovered Oil and Gas Resources of the Devonian Marcellus Shale of the Appalachian Basin Province, 2011. Technical report, August 2011.
- [12] Robert A Vargo and Kenneth L Frye Jr. **An Examination of Pennsylvania's Oil and Gas Industry. Technical report, March 2005.**
- [13] George R Watzlaf and Terry E Ackman. Underground Mine Water for Heating and Cooling using Geothermal Heat Pump Systems. *Mine Water and the Environment*, pages 1–14, March 2006.
- [14] Paul F Ziemkiewicz and Y Thomas He. Evolution of water chemistry during Marcellus Shale gas development: A case study in West Virginia. *Chemosphere*, 134(C):224–231, September 2015.

Session 4.3 Advanced Building Systems - Energy Generation (2)

Exergoeconomic Assessment of a Building Integrated Photovoltaic (BIPV) System: A Case study of Yasar University, Izmir, Turkey

Arif HEPBASLI^a, Emrah BIYIK^b, Mustafa ARAZ^c, YAO Runming^d, Mehdi SHAHRESTANI^e, Emmanuel ESSAH^f, SHAO Li^g, Armando C. OLIVEIRA^h, Teodosio DEL CAÑOⁱ, Elena RICO^j, Juan Luis LECHÓN^k

^a Yasar University, Turkey, arifhepbasli@gmail.com

^b Yasar University, Turkey, emrah.biyik@yasar.edu.tr

^c Yasar University, Turkey, mustafa.araz@yasar.edu.tr

^d The University of Reading, United Kingdom, r.yao@reading.ac.uk

^e The University of Reading, United Kingdom, m.shahrestani@reading.ac.uk

^f The University of Reading, United Kingdom, e.a.essah@reading.ac.uk

^g The University of Reading, United Kingdom, l.shao@reading.ac.uk

^h University of Porto, Portugal, Turkey, acoliv@fe.up.pt

ⁱ Onyx Solar Energy S.L., Spain, idc@onyxsolar.com

^j Onyx Solar Energy S.L., Spain, erico@onyxsolar.com

^k Onyx Solar Energy S.L., Spain, jlechon@onyxsolar.com

ABSTRACT

The present study deals with the performance assessment of a building integrated photovoltaic (BIPV) system through exergoeconomic analysis method. The system was installed at Yasar University in Izmir, Turkey within the framework of a EU/ FP7 funded project, the so-called REELCOOP (REnewable ELectricity COOperation). Some preliminary experimental, modelling and numerical simulation studies have been performed by a research team from the University of Reading, which is one of the partners. Accordingly, the best design was chosen for the BIPV system to be installed at Yasar University. The PV glass was designed and manufactured by another partner, Onyx Solar, with glass/ glass configuration and mono-crystalline PV technology, through 6" (156 mm) pseudo-square cells. The BIPV system consists of a total of 48 Crystalline Silicon (c-Si) modules in 4 rows and 12 columns, with a gap of 150 mm between the modules. The façade area is totally 57.6 m² with a cell area of 42.8 m² while the total peak installed power is 7.44 kW with a peak power per PV unit of 155 W_p. Exergoeconomic evaluation methodology is a combination of exergy analysis and economic aspect analysis. Based on the literature survey, some limited studies on exergetic assessment of BIPV/ T (PV/ Thermal) systems have been done while no studies on exergoeconomic analysis and evaluation of a BIPV system using long term actual operational data have **appeared in the open literature to the best of the authors' knowledge. This was the primary motivation** behind this contribution.

In this study, the BIPV system was introduced first. The exergy, cost, energy and mass (EXCEM) method was then applied to the BIPV system considered. Finally, the results obtained were presented. Exergoeconomic parameters based on energetic and exergetic terms range from 0.001 to 0.714 W/ €, and 0.001 to 0.664 W/ €, with daily average values of 0.315 and 0.293, respectively.

Keywords: exergy, exergoeconomic, building integrated photovoltaic, BIPV, sustainability

1. INTRODUCTION

Photovoltaic (PV) technology is rapidly-growing compared to other renewables. There are various organizations worldwide, which support the research and development of PV technologies for improving efficiency and reliability and lowering manufacturing costs in order to make solar electricity cost-competitive with other sources of energy.

According to the International Energy Agency, the share of renewables in electricity generation is expected to rise up to 25% of the total power generation in 2018. PV generated electricity is also estimated to double its share by 2018 compared to 2011. In this regard, Building Integrated PV (BIPV) systems play an important role in generating electricity. BIPVs are defined as PV modules, which can be integrated in the building envelope (into the roof or **façade) by replacing conventional building materials (tiles e.g.). Therefore, BIPVs have an impact of building's** functionality and can be considered as an integral part of the energy system of the building.

Performing exergy analysis of various energy-related systems has been very popular in recent years. Exergy may be defined in various ways and indicates the maximum work potential of a system under certain conditions. All systems with different conditions from the environment contain exergy. Exergy analysis aims at quantitatively evaluating the exergy destructions and losses within a system. Instead of energy analysis, exergy analysis results in a more clear and true values when examining thermodynamic systems. It should be noticed that exergy is always evaluated with respect to a reference (dead) state, which is arbitrary.

Exergoeconomics (thermoeconomics) is a combination of exergy analysis with economic constraints). The main aim of exergoeconomic analyses is to provide cost-effective ways for improving the performance of energy systems. In the scientific literature, different exergoeconomic approaches can be seen while exergy, cost, energy and material (the so-called EXCEM) method proposed by Rosen and Scott in 1987 is one of them. Within the framework of a European Commission project, the so-called REELCOOP, it is aimed at significantly enhancing research cooperation and knowledge creation on renewable electricity generation, involving Mediterranean partner countries, while at the same time developing and testing new renewable electricity generation systems. One of three novel prototype systems to be developed and tested in the project is prototype 1, which is related to a BIPV system. In this context, based on some preliminary experimental, modeling and numerical simulation studies done at the University of Reading, the best design was chosen for the BIPV system to be installed at Yasar University. The PV glass was designed and manufactured by Onyx Solar with glass/ glass configuration and mono-crystalline PV **technology, through 6"**(156 mm) pseudo-square cells.

In this context, the main objective of this contribution is to analyse a BIPV system considered here by using the EXCEM method, which is used to investigate costs and thermodynamic losses for devices in energy systems.

2. LITERATURE REVIEW

Since the study deals with the exergoeconomic analysis, which is a combination of exergy and economics, previous exergetic and exergoeconomic studies on BIPV systems are briefly reviewed in the following.

As far as studies on exergetic analysis and assessment of BIPV systems are concerned, Joshi et al. studied the performance characteristics of a PV and PV/T system based on energy and exergy efficiencies, respectively. They proposed relations for the energy, power conversion (electrical), and exergy efficiency of a PV system. Abid and Hepbasli assessed the exergetic performance of PV modules of a PV-wind hybrid system installed on the roof of Mechanical Engineering Department, King Saud University Riyadh, Saudi Arabia. There were twenty polycrystalline PV panels with a dimension of 0.9 m x 1.48 m and a rated power output of 200 W at a rated voltage of 24 V. The energy efficiency values varied between 34.09% and 52.14% while the corresponding exergy efficiencies ranged from 0.16% to 15.23%, respectively. Vats and Tiwari evaluated energetic and exergetic performance of a building integrated semitransparent photovoltaic thermal system integrated to the roof of a room. They compared six different PV modules through energy and exergy efficiencies. They concluded that the crystalline silicon (c-Si) PV modul was suitable for producing electrical power while the thin amorphous silicon (a-Si) PV cell was suitable for space heating. Saloux et al. analyzed PV and PV/ T systems using the exergy method. They defined electrical current and voltage reduction factors and used to express the exergy as well as its destruction in a PV/ T system. Shukla et al. assessed the performance of building integrated semitransparent photovoltaic modules for roof and facade in terms of energy, exergy and power generation. The experimental setup consisted of two modules, each of 75W rating, which was conducted on a clear sky day at roof and façade of Energy Centre building, MANIT Bhopal, India. The energy efficiency varied between 11- 18% at roof and 13-18% at facade throughout the day. The maximum electrical efficiency values of the modules were 85% on the roof and 72% at the façade. Shukla et al. also reviewed studies on energy and exergy analyses of building integrated photovoltaic modules to evaluate the electrical performance, exergy destruction and exergy efficiency with photonic method. They concluded that exergy assessment of BIPV systems was highly dependent on the daily solar radiation and radiation intensity while the building integrated photovoltaic module temperature had a great effect on the exergy efficiency.

As far as exergoeconomic analysis of BIPV systems is considered, no study utilizing the actual operational data **has appeared in the open literature to the best of the authors' knowledge although there is only one study** on the exergoeconomic and enviroeconomic analyses of semitransparent and opaque PV modules based on different kinds of solar cells. In this regard, Gaur and Tiwari proposed the modified EXCEM method. They calculated annual electricity and net present values for the composite climatic conditions of New Delhi, India. It was reported that

irrespective of the solar cell type, the semitransparent PV modules shown higher net energy and exergy loss rates compared to the opaque ones. Among all types of solar modules, the one based on c-Si had minimum energy and exergy loss rate values.

3. SYSTEM DESCRIPTION

The BIPV system installed at Yasar University, Izmir, Turkey has a total peak power of 7.44 kW and consists of a total of 48 Crystalline Silicon (c-Si) modules in 4 rows and 12 columns, with a gap of 150 mm between the modules and the wall, as illustrated in Figure 1. There are shading effects that were considered, as the Southeast façade lies on the lower part of the building. The façade area is totally 57.6 m² with a cell area of 42.8 m² while the total peak installed power is 7.44 kW with a peak power per PV unit of 155 W_p. The peak power is reduced after the inverter and the balance of the system losses to 6.8 kW.

The installation of the BIPV system was completed on 8 February 2016 and since then, the performance of the system has been monitored through Sunny Portal while a total electrical energy of 3103 kWh has been produced as of 21 August 2016.



Figure 1: A schematic and picture of the BIPV system installed

4. ENERGY, EXERGY AND EXERGOECONOMIC ANALYSES

4.1 Energy analysis

Solar cell (or module) power conversion efficiency (η_{pc}) can be defined as follows [14,17]:

$$\eta_{mod} = \frac{V_{max} I_{max}}{GA} \quad (1)$$

Equation 1

where V_{max} is the voltage at the maximum power, I_{max} is the current at the maximum power, G is the global irradiance (or solar radiation intensity), and A is the surface area.

The traditional linear expression for PV electrical efficiency is given as [17-20]

$$\eta_{T,elec} = \eta_{ref} [1 - \beta_{ref}(T_{mod} - T_{ref})] \quad (2)$$

Equation 2

with

$$\beta_{ref} = \frac{1}{(T_0 - T_{ref})} \quad (3)$$

Equation 3

where η_{ref} represents the efficiency of the PV module under standard test conditions, T_{ref} is the reference temperature (°C), T_{mod} is the PV module temperature (°C) and T_0 is the high temperature at which the PV modules electrical efficiency drop to zero. According to the manufacturer information, the temperature coefficient (β_{ref}) is equal to 0.0045 K⁻¹.

In addition, the influence of the total irradiation level on the electrical efficiency of the PV modules is considered using the following equation.

$$\eta_{irr-A} = \alpha \eta_{ref} \quad (4)$$

Equation 4

where η_{irr-A} stands for the electrical efficiency of the module under irradiation level equal to 'A' (W/ m²) and the PV module temperature equal to 25 °C. According to the manufacturer information, the irradiation coefficient (α) values are as follows: 92, 97, 99, 102 and 100% for irradiation levels of 100, 200, 400, 700 and 1000 W/ m², respectively.

4.2 Exergy analysis

In the literature, there are various approaches to exergetic assessment of the BIPV modules, as reviewed in Ref. while the relations used in the calculations are presented as follows [8,9,17,18]:

Since electricity and work are the same on energy and exergy bases, the overall energy and exergy efficiencies for such devices are the same.

The exergy efficiency of a system can in general be given as

$$\psi = \frac{\dot{E}x_{PV}}{\dot{E}x_{sol}} \quad (5)$$

Equation 5

where $\dot{E}x_{PV}$ is the exergy rate of the BIPV system, which is mainly electrical power output of the system. Since the thermal energy gained by the system during the operation is not desirable in case of PV system, this becomes a heat loss to the system and hence needs to be subtracted in order to calculate the exergy of a PV system.

$$\psi = \frac{V_{max} I_{max} - \dot{E}x_Q}{\dot{E}x_{sol}} \quad (6)$$

Equation 6

with

$$\dot{E}x_Q = \dot{Q}_{c,r} \left(1 - \frac{T_{amb}}{T_{mod}}\right) \quad (7)$$

Equation 7

$$\dot{E}x_{sol} = GA\Psi_{ex,sol} \quad (8)$$

Equation 8

where $\dot{E}x_{sol}$ is the exergy rate from the solar irradiance in W/ m², $\dot{Q}_{c,r}$ is the convective and radiative heat transfer coefficient from photovoltaic cell to ambient, which is found using

$$\dot{Q}_{c,r} = h_{ca} A (T_{mod} - T_{amb}) \quad (9)$$

Equation 9

with

$$h_{ca} = 5.7 + 3.8V_{wind} \quad (10)$$

Equation 10

where V_{wind} is the wind velocity (m/ s).

$\Psi_{ex,sol}$ is the exergy of solar radiation (thermal radiation) and may be calculated by using one of the following relations, respectively [21-24]:

$$\Psi_{ex,sol,Peiela} = 1 + \frac{1}{3} \left(\frac{T_0}{T_{sol}} \right)^4 - \frac{4}{3} \frac{T_0}{T_{sol}} \quad (11a)$$

Equation 11A

$$\Psi_{ex,sol,Spanner} = 1 - \frac{4}{3} \frac{T_0}{T_{sol}} \quad (11b)$$

Equation 11B

$$\Psi_{ex,sol,Nobusawa} = 0.95 \quad (11c)$$

Equation 11C

$$\Psi_{ex,sol,Jeter} = 1 - \frac{T_0}{T_{sol}} \quad (11d)$$

Equation 11D

where T_{sol} is the solar radiation (sun) temperature with 6 000 K.

By substituting $\dot{E}x_e$ in Eq. (7) (along with Eqs. (9 and (10)) and $\dot{E}x_{sol}$ in Eq. (8) (along with Eq. (11a)) into Eq. (6), the exergy efficiency of the BIPV system becomes

$$\psi = \frac{V_{max} I_{max} - A(5.7 + 3.8V_{wind})(T_{mod} - T_{amb})[1 - (T_{amb}/T_{mod})]}{GA[1 + \frac{1}{3} \left(\frac{T_0}{T_{sol}} \right)^4 - \frac{4}{3} \frac{T_0}{T_{sol}}]} \quad (12)$$

Equation 12

4.3 Exergoeconomic analysis

For a thermal system operating normally in a continuous steady-state steady-flow process mode, the energy and exergy loss rates can be obtained through the following equations [7,25]:

$$\dot{L}_{en} = \sum_{inputs} \dot{E} - \sum_{products} \dot{E} \quad (13)$$

Equation 13

and

$$\dot{L}_{ex} = \sum_{inputs} \dot{E}x - \sum_{products} \dot{E}x \quad (14)$$

Equation 14

where the summations are over all input streams and all product output streams. For the BIPV system considered, the following energy and exergy loss rates may be written [15]:

$$\dot{L}_{en} = \sum \tau_{glass} \alpha_{mod} \beta_{mod} G(t) A_{mod} - \sum \eta_{mod} G(t) A_{mod} \quad (15)$$

Equation 15

$$\dot{L}_{ex} = \sum \tau_{glass} \alpha_{mod} \beta_{mod} G(t) \Psi_{ex,sol,Peiela} A_{mod} - \sum \eta_{mod} G(t) \Psi_{ex,sol,Peiela} A_{mod} \quad (16)$$

Equation 16

where τ_{glass} is the transmittivity of the glass, the absorption factor of the module and β_{mod} is the packing factor (the fraction of absorber plate area covered by the solar cells) of the module.

Another parameter, \dot{R} is defined as the ratio of thermodynamic loss rate \dot{L} to capital cost K as follows:

$$\dot{R} = \dot{L} / K \quad (17)$$

Equation 17

The value of R generally depends on whether it is based on energy loss rate (in which case it is denoted \dot{R}_{en}), or exergy loss rate (\dot{R}_{ex}), as follows:

$$\dot{R}_{en} = \dot{L}_{en} / K \quad (18)$$

Equation 18

and

$$\dot{R}_{ex} = \dot{L}_{ex} / K \quad (19)$$

Equation 19

Values of the parameter \dot{R} based on energy loss rate, and on total, internal and external exergy loss rates are considered. In investigating sets of \dot{R} -values, maximum (\dot{R}_{max}), minimum (\dot{R}_{min}), mean (\dot{R}_m), standard deviation ($SD(\dot{R})$) and coefficient of variation ($CV(\dot{R})$), which is the ratio of standard deviation to mean, are considered.

5. RESULTS AND DISCUSSION

The daily power generation distribution of the BIPV system on 23 July 2016 is illustrated in Figure 2 with respect to irradiation. As can be seen from the figure, the daily power generation is in accordance with the irradiation profile.

Variations of the average BIPV surface temperature and the ambient temperature during the day are plotted in Figure 3 where the maximum power of 434 W/m² is obtained at 10 p.m while a power of 2864 W is seen at 10.15 p.m.

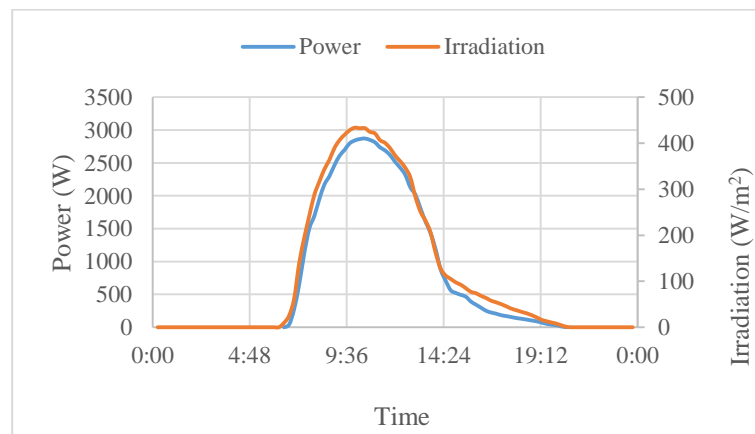

Figure 2: Daily power generation and irradiation distribution on 23th of July

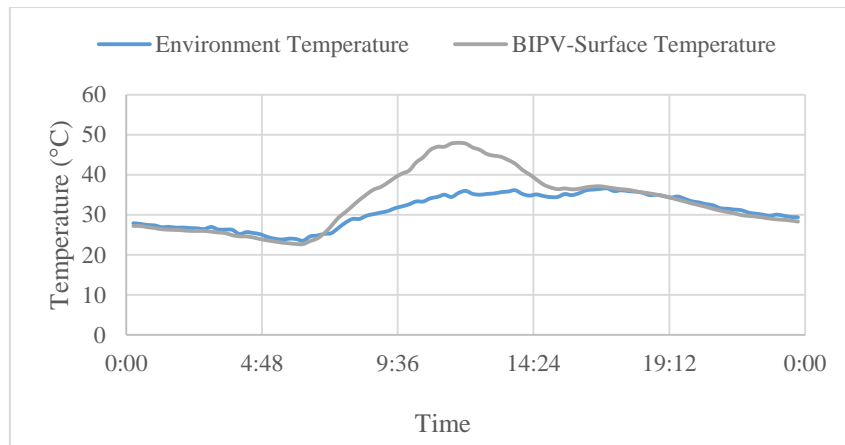

Figure 3: BIPV surface temperature vs. ambient temperature

Figure 4 shows the variation of power conversion and exergy efficiencies based on cell and module (total) areas. It is clear from the figure that there is a good agreement between the power conversion and exergy efficiencies while the difference in the efficiencies based on cell area and module area are about 4%. Exergy efficiency values range from 7.26% to 12.91% and 9.78 to 17.37 based on total and cell areas over a period of 7 a.m. to 8 p.m., respectively.

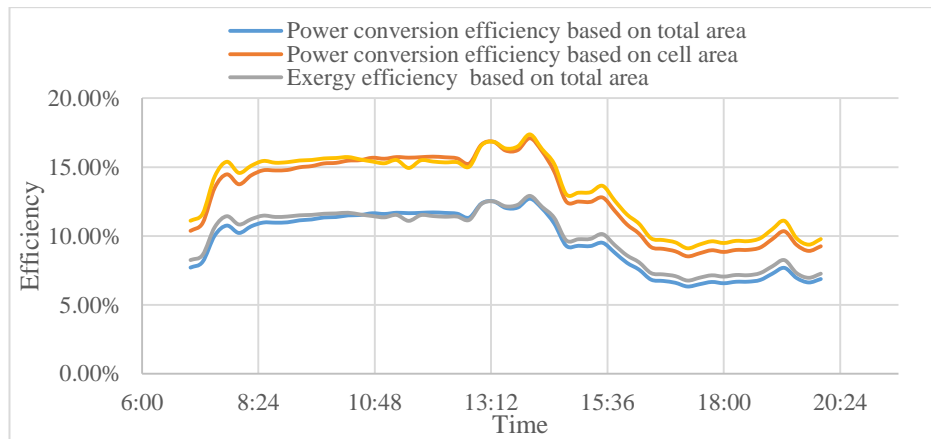

Figure 4: Energy and exergy efficiency distributions

Exergoeconomic parameters based on energetic terms (\dot{R}_{en}) and exergetic terms (\dot{R}_{ex}) are calculated and the results are shown in Figs. 5 and 6. As can be seen from the figures, \dot{R}_{en} lies in the range of 0.001 – 0.714 W/ € with a daily average of 0.315 W/ € while \dot{R}_{ex} varies between 0.001. and 0.664 W/ €, with a daily average of 0.293 W/ €.

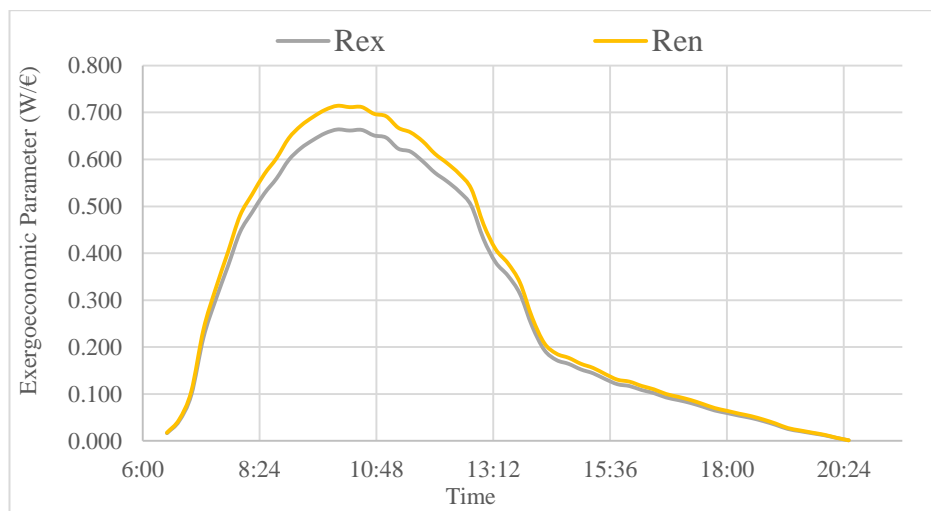

Figure 5: Daily variation of exergoeconomic parameter based on energy and exergy terms

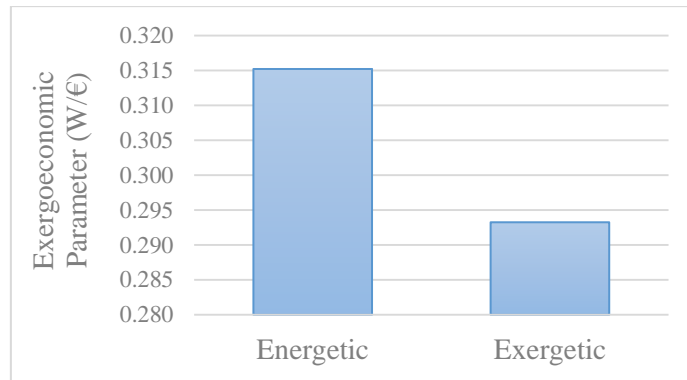

Figure 6: Comparison of the daily averages of energy and exergy based exergoeconomic parameters

6. CONCLUSIONS

In this study, a BIPV system installed at Yasar University, Izmir, Turkey, which also achieved TS EN ISO 50001:2011 (Energy Management System Standard) certification as the first university in Turkey on 5 January 2016, was considered. The performance of the BIPV system was evaluated using an exergy-based economic analysis methodology, which is based on the quantities exergy, cost, energy and mass (the so-called EXCEM method).

The main conclusions we have drawn from the results of the present study may be summarized as follows:

- Exergy efficiency values are obtained to be in the range of about 7.3% to 12.9% and 9.8 to 17.4 based on total and cell areas over a daily period considered, respectively.
- Exergoeconomic parameters based on the energetic terms are calculated to vary between 0.001 and 0.714 W/ € with a daily average of 0.315 W/ € while those based on the corresponding exergetic terms are in the range of 0.001 to 0.664 W/ €, with a daily average of 0.293 W/ €.
- The authors expect that this study would be beneficial to the researchers, designers and manufacturers, who are interested in applying exergy-based economic analysis methods to BIPV systems.

ACKNOWLEDGMENTS

The presented work was developed within the framework of project "REELCOOP-Research Cooperation in Renewable Energy Technologies for Electricity Generation", co-funded by the European Commission (FP7 ENERGY.2013.2.9.1, Grant agreement no: 608466). The authors would also like to thank Prof Andrew Baldwin for his kind invitation to publishing this paper under the title "SBE16 Top Papers" in the Conference Proceeding of WSBE17 Hong Kong.

REFERENCES

- [1] ENERGY.GOV. Photovoltaics. <http://energy.gov/eere/sunshot/photovoltaics>, Accessed on 21 August 2016.
- [2] International Energy Agency, 2013, Renewable Energy Medium-Term Market Report – Market Trends and Projections to 2018.
- [3] Kong X, Lu S, Wu Y. A review of building energy efficiency in China during "Eleventh Five-Year Plan" period. Energy Policy 2012;41:624–35.
- [4] Bloem JJ, Lodi C, Cipriano J, Chemisana D. An outdoor Test Reference Environment for double skin applications of Building Integrated PhotoVoltaic Systems. Energy Build 2012;50:63–73.
- [5] Hepbasli, A. Low exergy (Lowex) heating and cooling systems for sustainable buildings and societies, Renewable & Sustainable Energy Reviews 2012;16(1):73-104.
- [6] Shokati N, Ranjbar F, Yari M. Exergoeconomic analysis and optimization of basic, dual-pressure and dual-fluid ORCs and Kalina geothermal power plants: A comparative study. Renew Energy 2015;83:527-542.
- [7] Rosen MA, Scott DS. A methodology based on exergy, cost, energy and mass for the analysis of systems and processes. In: Proceedings of the meeting of international society for general systems research, Vol. 8.3, Toronto, 20–22 May; 1987. p. 1–13.

- [8] Joshi, AS, Dincer, I, Reddy, BV. Energetic and exergetic analyses of a photovoltaic system. Proceedings of the Canadian Society for Mechanical Engineering (CSME) Forum 2008, Paper No: 1569103179, Ottawa, Canada, 2008.
- [9] Joshi, AS, Dincer, I, Reddy, BV. Thermodynamic assessment of photovoltaic systems. *Solar Energy* 2009;83:1139–1149.
- [10] Abid, M, Hepbasli, A. Dynamic exergetic analysis and evaluation of photovoltaic modules, *Energy Sources, Part A: Recovery, Utilization, and Environmental Effects* 2015;37:2271–2284.
- [11] Vats, K, Tiwari, GN. Energy and exergy analysis of a building integrated semitransparent photovoltaic thermal (BISPVT) system, *Applied Energy* 2012;96:409-416.
- [12] Saloux, E, Teyssedou, A, Sorin, M. Analysis of photovoltaic (PV) and photovoltaic/thermal (PV/T) systems using the exergy method. *Energy and Buildings* 2013;67:275-285.
- [13] Shukla, AK, Sudhakar, K, Baredar, P. Exergetic analysis of building integrated semitransparent photovoltaic module in clear sky condition at Bhopal India. *Case Studies in Thermal Engineering* 2016;8:142–151.
- [14] Shukla, AK, Sudhakar, K, Baredar, P. Exergetic assessment of BIPV module using parametric and photonic energy methods: a review. *Energy and Buildings* 2016;119:62-73.
- [15] Gaur, A, Tiwari, GN. Exergoeconomic and enviroeconomic analysis of photovoltaic modules of different solar cells. *Journal of Solar Energy*. Hindawi Publishing Corporation. Volume 2014, Article ID 719424, 8 pages, <http://dx.doi.org/10.1155/2014/719424>.
- [16] REELCOOP, Research Cooperation in Renewable Energy Technologies for Electricity Generation report. 2015, Seventh Framework Programme of the European Union.
- [17] Shukla, A.K., Sudhakar, K., Baredar, P. Exergetic analysis of building integrated semitransparent photovoltaic module in clear sky condition at Bhopal India. *Case Studies in Thermal Engineering*. 2016, 8:142–151.
- [18] H.A. Zondag, Flat plate PV-thermal collectors and systems-a review, *Renewable sustainable energy review*. Doi: 10.1016/J.rser.2005.12.012.
- [19] Evans, DL. Simplified method for predicting photovoltaic array output. *Sol. Energy* 1981;27:555–560.
- [20] Hart, GW, Raghuraman, P. Simulation of Thermal Aspects of Residential Photovoltaic System, MIT report DOE/ET/20279-202.
- [21] Petela, R. Energy of heat radiation. *J. Heat Transfer* 1964;86:187–192.
- [22] Spanner, DC. Introduction to Thermodynamics. London: Academic Press, 1964.
- [23] Nobusawa, T. Introductory Text of Exergy. Tokyo: Ohmsha (in Japanese), 1980.
- [24] **Jeter, SM. Maximum conversion efficiency for the utilization of direct solar radiation. *Solar Energy* 1981;26:231–236.**
- [25] Rosen MA, Dincer I. Exergoeconomic analysis of power plants operating on various fuels. *Applied Thermal Engineering* 2003;23:643-658.

Variations of Systematic Solutions for 24-Hour Operating Sustainable Small-Scale Commercial Buildings

Bumpei MAGORI^a, Tomonari YASHIRO^b, Yu MORISHITA^c

^a Institute Industrial Science, the University of Tokyo, Japan, magori@iis.u-tokyo.ac.jp

^b Institute Industrial Science, the University of Tokyo, Japan, yashiro@iis.u-tokyo.ac.jp

^c Institute Industrial Science, the University of Tokyo, Japan, ymorishi@iis.u-tokyo.ac.jp

ABSTRACT

Purpose - Our research purpose is developing the Small Commercial Building Design Model (SCBDM). Our design model should be adopted for small-scale commercial stores (24-hour convenience store) in order to achieve to find efficiency of all installed technologies, energy use and demand, energy conservation and energy creation. Our research target of small size buildings have different environmental situations, so every project must select some common and different technologies.

Development/ Methodology / Approach - All of the developed and designed projects have already been built and their operations are running without facility manager at each location. All of the pilot sustainable stores have visualization systems and AI control systems that provide optimized indoor temperature and humidity, IAQ, the control of HVAC devices, lighting, and their 24-hour optimization by machine learning. This paper displays both the common and locally integrated sustainable technologies implemented in the pilot projects, illustrating their economic benefits through actually monitored energy conservation and degrees of the usage of renewable energy.

Findings -

- Developed SCBDM (small commercial building design model) could be arranged to give conditions and scope of sustainable technologies. The model needs a feedback information system as EMS.
- We show three EMS (energy management system) levels for energy conservation and energy creation.
- Key developed technologies include information feedback EMS, AI control systems, and selection of design models arranged and organized by sustainable technologies.

Originality/ value - Designed and developed AI control system achieves energy reduce and unman system control.

Keywords: *sustainable, IoT (internet of things), machine learning, AI (artificial intelligence), EMS (energy management system), energy conservation, environment efficiency, optimized control, CO₂ reduction*

1. INTRODUCTION/ TECHNICAL AND SOCIAL BACKGROUND

There are a large number of small-scale commercial buildings, ranging in size from 200m² to 300 m² in Japan and in Asia. In addition to these, the number of 24-hour operating stores are increasing in large cities as well as in small suburban towns. However, most of these stores do not use sustainable technologies, renewable energy or control systems that are suitable to their environmental contexts.

For example, in regards to existing EMS most large-scale buildings have some sort of EMS, but most small-scale buildings do not. However the importance of BESM (building energy management system) is quickly being recognized, and the market for these systems is expected to grow to 155,300,000,000 Japanese yen by 2020. This prediction¹ is a growth of 70.8% (2013 ratio) for the market scale.

1.1 Research questions and purpose/ Design and development pilot model buildings in Japan

Our research questions the applicability of sustainable technologies to small buildings with large energy consumptions, **aiming to develop a “Small Commercial Building Design Model (SCBDM)” that achieves high-economic performance and high-efficiency energy use through integrating to various locations.**

The development of SCBDM has been planned and built over a nine-year collaboration between the construction division of Lawson's Japanese convenience store company that operates about 9000 24-hour stores in Japan and the University of Tokyo.

All of the developed and designed projects have already been built and are running without facility manager at each location. All of the pilot sustainable stores have visualization systems and AI control systems that provide optimized indoor temperature and humidity, IAQ, the control of HVAC devices, lighting, and 24-hour optimization by machine learning. This paper displays both the common and locally integrated sustainable technologies implemented in the pilot projects, illustrating their economic benefit through actually monitored energy conservation and the degree of usage of renewable energy.

2. RESEARCH PURPOSE

Our research purpose is developing the Small Commercial Building Design Model (SCBDM). Our design model should be adopted to small-scale commercial stores and achieve to grape efficiency of all installed technologies, energy use and demand, and energy conservation and energy creation.

2.1 Arranging each attribute related to energy conservation and energy creation

Before comparing the design modeling, we arranged the conditions for each sustainable store and each attribute that relate to energy conservation and energy creation. All equipment and systems are optimized for energy efficiency by using visualization and AI control systems that we have developed. The targets that should be optimized for energy efficiency are HVAC, refrigerator units, and energy creation equipment and system (PV, solar heating panel, biomass generator, etc.) Table 1 is giving conditions and attribute for our sustainable store design model.

	Items	contents
Giving conditions of each site	Climate area code for energy conservation	I-VI areas code (old codes) 1~8 areas code (new codes) Cold and hot district
	Store building type	Tenant type
		Independent type
	Direction	Front direction
	The surrounding circumstances	The physical relationship of the neighborhood
	The store area	The total floor area (the air conditioning area), the parking area
	Business hours	24 hours per 365 days
energy classification	Electricity (gas and others)	
Energy conservation and Energy creation	Building technologies of building	Insulation (envelope)
		Solar radiation control (canopy)
		Solar radiation control (window)
		Daylight utilization
		Natural ventilation utilization
	Energy conservation technologies of building services	High-efficiency heating and cooling equipment system
		Lighting system
		Ventilation system
		Greening (watering)
		Geothermal heating and cooling
		Groundwater use watering
		Optimized control
	Energy creation equipment and system	PV
Solar panel		
Biomass power generation		
Snow utilization		
Other Natural energy		

Special equipment for small 24hour convenience store	High-efficiency refrigerator
	Separate style compressor
	Refrigerator with a door
	Water spray for compressor
Energy conservation for operation	Visualization system
	Evaluate, improvement and optimize for operation conditions
	Adjustment for settings
Optimized cleaning and maintenance	
User's actions	User actions for energy conservation

Table 1: Related giving conditions and attribute for sustainable items

2.2 Research themes and solution policies

Almost all typical small commerce buildings are not related to sustainable items. Most buildings only focus on cold district style. Table 2 shows three R & D items and solutions for sustainable energy conservation and energy creation.

NO	Main R & D items	Solutions (Methodology)
1	Information of given conditions is not utilized for energy conservation and creation technologies	R & D, EMS for feedback Information about adoptable technologies in variable location and operation conditions
2	Nobody finds M & E system condition and efficiency in operational time.	R & D, monitoring energy conservation and evaluating efficiency
3	Stake holders don't have about external environmental information, maintenance information and building user information.	R & D EMS grasps external environmental information, maintenance information and building user information for steak holders.

Table 2: R & D items and solutions

3. RELATION BETWEEN ATTRIBUTES OF THE STORE AND THE ENERGY SAVING EFFECT OF ENERGY CONSERVATION AND THE ATTRIBUTES OF ENERGY CREATION

Table 3 shows the differences of given conditions, attributes of energy creation, and the energy saving effects. The leftmost line describes 'the typical store'. The next column describes 'the typical store with visualization,' which includes existing stores that have installed visualizations systems. 'The typical store with visualization and optimized control' includes existing stores that have installed both visualization systems and optimizing systems for existing typical equipment. Finally, 'the sustainable developed store' column describes new stores that are planned and designed to include installed sustainable technologies. All projects and the design models were developed between 2008 to 2015.

3.1. Energy conservation effects through visualization systems in existing stores

The visualization system gives us real time information about energy use, outdoor and indoor temperature and humidity, the operation condition of M & E equipment and systems situation. We understand by installing a visualization system to a typical existing store, we were able to reduce the total energy use by ▲ 3~5%.

Every staff member has control of the settings for indoor temperature. Cleaning the filters of the air-conditioning system reduces air-conditioning energy by ▲ 9%. Controlling the indoor and equipment lighting illuminance is found to reduce lighting energy by ▲ 42% (about ▲ 17kwh/day). Controlling daylight and lighting shows us an important technology for energy conservation.

3.2. Energy conservation effects of using a visualization system and an optimizing control system

In order to observe the effects of a visualization system and an optimized control system (AI control system), we installed the systems in an existing store and its M & E equipment. We targeted the interior and exterior lights, HVAC, settings of AC temperature, refrigeration temperature, and demand control of electric power. The optimized controlling of M & E in an existing building is able to reduce total energy use by ▲ 10.3%. In addition, controlling

the solar radiation, and natural ventilation gives us a ▲ 14% reduction of total energy use. This process includes analyzing information from sensing data and feedback control.

3.3. Sustainable store effect

Location, circumstance, district, site area, and direction for architecture is very important for energy conservation and creation. Our R & D and design model achieve efficiency and a reduction of ▲ 30~70% of total energy use.

All existing small commercial stores and small 24-hour stores do not have maintenance staff, necessitating our design model and AI control system.

4. THE NECESSITY OF A MULTI-PURPOSED INFORMATION MODEL

Our visualization system as an information system could get variable information from buildings by using local sensors. The sensor cost and data storage cost become much cheaper after one decay. We can monitor and control the building despite being far from the control center. The most important information is related to each building's targets and how to get high quality information for our management and stakeholders. Table 4 shows us EMS scope, targets, and purpose.

		O: adaptation					--: No relation					
	Items	general existing store with visualization system			general existing store with visualization and AI control	Sustainable store						
		HO	MI	TA	MI	EB	UR	TO	UM			
Giving conditions of each site	Climate area code for energy conservation	All district	IV(6)	IV(6)	IV(6)	IV(6)	IV(6)	II(2)	IV(6)	IV(6)		
	Store building type	○	○	○	○	○	○	○	○	○		
	Direction	All direction	North	West	South west	West	East	East	North	South		
	The relationship of surrounding circumstances	Relationship of the neighborhood	North neighborhood building, east wall	West neighborhood East-West Open	South-East neighborhood Others open	West neighborhood East open	East neighborhood East open	No neighborhood	South and West wall	No neighborhood		
	The store area	The total floor area (the air conditioning area), the parking area, etc.	from 100 to 200	121(93)	175(104)	153(111)	175(104)	200(140)	200(140)	200(140)	200(140)	
	Business hours	24 hours per 365 days	○	○	○	○	○	○	○	○	○	
	energy classification	Electricity (gas and others)	Electricity water	Electricity water	Electricity water	Electricity water	Electricity water	Electricity water	Electricity water	Electricity water	Electricity water recycle oil	
	Energy conservation and Energy creation	Architectural sustainable technologies of building	Insulation (envelope)	Standard type	Standard type	Standard type	Standard type	Standard type	High spec insulation	High spec insulation	High spec insulation	High spec insulation
			Solar radiation control (canopy)	Standard type	Standard type	Standard type	Standard type	Standard type	Thermal barrier Thermal insulation	Thermal barrier Thermal insulation	Thermal barrier Thermal insulation	Thermal barrier Thermal insulation
			Solar radiation control (window)	Standard type	Standard type	Standard type	Standard type	Standard type	Insulation Sunlight Shading	Insulation Sunlight Shading	Insulation Sunlight Shading	Insulation Sunlight Shading
Energy conservation technologies of building services		Daylight utilization	—	—	—	—	—	Indirect sunlighting	—	—	—	
		Natural ventilation	—	—	—	—	—	Natural Ventilation	—	Natural Ventilation	—	
		High-efficiency heating and cooling equipment system	Standard type	Standard type	Standard type	Standard type	AI control	Ceiling radiation Well HP AI control	Well HP AI control	Wall radiation Heat pipe AI control	Ceiling radiation Air HP AI control	
		Lighting system	Standard type	Standard type	Standard type	Standard type	Lighting control	LED Lighting control	LED Lighting control	LED Lighting control	LED Lighting control	
		Ventilation system	Standard type	Standard type	Standard type	Standard type	Standard type	Natural Ventilation	Standard type	Standard type	Standard type	
		Greening (watering)	—	—	—	—	—	—	—	Greening Splay	—	
		Geothermal heating and cooling	—	—	—	—	—	Well	Well	Geothermal heat pipe	—	
Energy creation equipment and system	Groundwater Use watering	—	—	—	—	—	Water splay	Snow water	—	—		
	Optimized control	—	—	—	—	Lighting Air condition	radiation panel system Heat pump	FCU, Snow storage system	radiation panel system Heat pump	radiation panel system Heat pump		
	PV system	Installed	Installed	Installed	—	Installed	Installed	Installed	Installed	Installed		
	Solar panel	—	—	—	—	—	—	Floor heating	—	—		
	Biomass power generation	—	—	—	—	—	—	—	—	Biomass generation		
Special equipment for small 24 hours convenience store	Snow utilization	—	—	—	—	—	—	Snow air condition system	—	—		
	Other Natural energy	—	—	—	—	—	—	—	Gravity ventilation	—		
	High-efficiency refrigerator	Standard type	Standard type	Standard type	Standard type	AI control	—	—	—	—		
Energy conservation for operation	Separate style compressor	—	—	—	—	Installed	Installed	Installed	Installed	Installed		
	Refrigerator with a door	—	—	—	—	—	—	—	—	Installed		
	Water spray for compressor	—	—	—	—	—	Well water splay system	—	—	—		
User's actions	Visualization system	—	Energy, indoor and outdoor temp humidity	Energy, indoor and outdoor temp humidity	Energy, indoor and outdoor temp humidity	Energy, indoor and outdoor temp humidity	Energy, indoor and outdoor temp humidity	Energy, indoor and outdoor temp humidity	Energy, indoor and outdoor temp humidity	Energy, indoor and outdoor temp humidity		
	Evaluate, improvement and optimize for operation conditions	non	Installed	Installed	Installed	Installed	Installed	Installed	Installed	Installed		
User's actions	Optimized clearing and maintenance	Standard manual	Standard manual	Standard manual	Standard manual	condition monitoring	Standard manual	Standard manual	Standard manual	Standard manual		
	User actions for energy conservation	—	—	—	—	—	—	—	—	—		
Energy conservation rate 2010 ratio		2010 average	▲3~5%			▲10~14%		about ▲30%	about ▲50%	about ▲60%	about ▲70%	

Table 3: Comparison table for energy conservation and creation effect related sustainable technologies

All store level EMS are able to compare the amounts of energy use daily, monthly, and annually. The construction division member of headquarters could understand and control the average levels of energy. Store level EMS is able to compare the energy use of each store as it relates to characteristics of the space, operation, maintenance conditions. The EMS for each technology is also able to understand energy use and efficiency of each equipment and systems under real site operation.

Scope and Level of EMS	Targets and purpose
EMS for management of All store in Japan	Compare operation efficiency and amount of energy
EMS for each Stores	Information below Space/ service/ operation/ maintenance/energy use environmental issues
EMS for each technology	Electric equipment and systems/ HVAC equipment and systems/ Energy creation equipment and systems/ Control system/ Aging degradation

Table 4: Scope and level of EMS relate to each targets

4.1 Information model of the small commerce store and its design model and decision making model by using real time data

Figure 1 shows the basic information model and the flow (process).

First, we retrieve the real data (data collection) by using sensors. Using this information, we form an analysis. The quality of the interpretation is highly relevant to the quality of information gathered. Action and control are automatically selected.

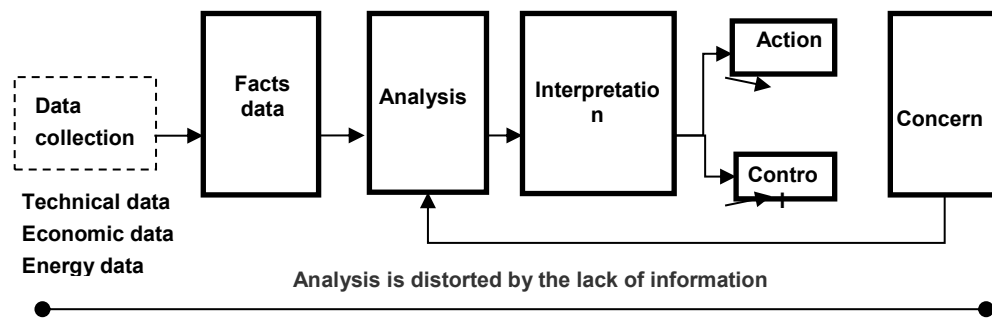

Figure 1: Well informed decision making model by using quantitative information

5. THE OUTCOME OF THIS RESEARCH AND DEVELOPMENT

5.1 The case study of sustainable store in cold direction (No.1)

This building was completed in November of 2013, and is the first of its kind. It has a storage system for snow, which generates air-conditioning energy. It achieved a 50% reduction in energy use compared to a typical store of similar size. Table 5, Figure 2 shows us the main sustainable systems.



Figure 2: Installed design system (description)

NO	Items	Contents
1	Snow storage cold and hot air-condition system	In winter. The snow storage the local snow in storage tank and use the energy in summer. The storage tank is a recycle container
2	Solar heating system for hot water supply	Hot water is using floor heating near in the cushier area.
3	Geothermal heat pump system	Geothermal heat pump is for radiation panel and FCU system.
4	PV panel on the roof	Generation and energy storage, and disaster prevention electricity
5	High insulation glass	Low-E glass windows in the front the store
6	The high insulation of the roof	High performance insulation for roof and wall materials
7	LED lighting and illumination control	LED and AI day light and schedule control
8	Energy saving type design refrigerator	High insulation, protect freezing control, window heater control
9	Refrigerator with natural ventilation	Developed refrigerator system using natural ventilation in winter
10	Water splay for refrigerator outdoor compressor	Storage snow water use as cooler splay for refrigerator in summer
11	Frozen case use CO ₂ refrigerant	Non-Freon CO ₂ refrigerant and high efficiency system
12	AI control and energy management system	Automatic optimized control energy management system by using environmental sensors

Table 5: The main technologies and systems of sustainable store in cold direction

5.2 The case study of sustainable store (No.2)

This building was completed in November of 2014. It achieved a 60% reduction in energy use compared to a typical store of similar size (2010 average energy use ratio). Table 6, photo1~3 show us the main sustainable systems.



Photo 1: Designed technologies, the exterior of front side



Photo 2: Designed technologies, the interior



Photo 3: Designed technologies, the exterior of back side

NO	Items	Contents
1	Duplication of store front glass	Pair glass front and double skin with exhaust air system
2	Tent film style double skin system on the wall	Double skin is made from white tent texture. The developed double skin reflects solar radiation and cooling wall surface temperature.
3	PV panel and double skin protection solar radiation system on the roof	PV generator and double skin effect for the roof
4	Wall planting	The parts of envelope are planting with water splay. The wall temperature become cooling.
5	The high insulation of the roof and wall Prefabrication methodology	High performance insulation for roof and wall materials
6	Natural ventilation and optimizing air condition operation	AI control seasonal, outdoor temperature and humidity by opening and closing the windows for ventilation
7	Geothermal heat pump and air-condition system	Under grand temperature become almost 17°C. Geothermal heat pump system made cooling and heating energy for FCU and radiation panel.
8	Storage type radiation panel system	Heat storage type radiation cooling and heating system.
9	Earth tube system	Earth tube system getting outdoor air and under grand heating as fresh air for control indoor air quality.
10	Gravity ventilation system	Outside store signage pole became gravity ventilation system for natural ventilation.
11	PV and battery system	PV and battery is used with energy storage and electric power demand control.
12	Frozen case use CO ₂ refrigerant	Non-Freon CO ₂ refrigerant and high efficiency system
13	Dehumidification air conditioner	Dehumidification air conditioner control indoor air humidity.
14	LED lighting and illumination control	LED and AI day light and schedule control
15	AI control and energy management system	Automatic optimized control energy management system by using environmental sensors

Table 6: The main technologies and systems of sustainable store in cold direction

6. CONCLUSION/ FUTURE ISSUES

- Developed SCBDM (Small Commercial Building Design Model) could be arranged to give conditions and scope of sustainable technologies. The model needs a feedback information system as EMS.
- We find three EMS levels for energy conservation and creation.
- Key developed technologies include information feedback EMS, AI control system, and the selection of a design model arranged and organized by sustainable technologies.

7. FUTURE ISSUES

- Showing our EMS feedback model technologies and its open protocol software.
- Getting as much information as possible about a store, and return the benefits to the building service, user services, and other stakeholders services.
- Reporting of the applied example to other building types.

REFERENCES

- [1] Bumpei magori, Development research of real-time monitoring and optimized control for energy conservation and CO2 reduction of existing buildings, wsb14barcelona.org/programs/pdf/poster/P-126.pdf
- [2] Collaborative research from 2008 to 2015 with LAWSON, Inc. and Yashiro lab and Magori lab, Institute Industrial Science, the University of Tokyo.
- [3] 株式会社富士経済、報告書「2014 エネルギーマネジメントシステム関連市場実態総調査」
- [4] 馬郡文平, 野城智也, 森下有場所単位でのインテグレーション・システムとしてのエネルギーマネジメントシステムに関する研究 (IoT と建築生産に関する研究), 第 32 回建築生産シンポジウム 2016 年 7 月

Study on the Potential of Converting Former Military Bunkers into Energy Storage Facilities

Joachim SCHULZE^a

^a *Technical University Darmstadt, Germany, schulze@stadt.tu-darmstadt.de*

ABSTRACT

Building a sustainable future calls for a strong re-evaluation of energy production and consumption patterns. With **the release of the so called 'energy concept' in 2010, the German government has made a clear commitment to sustainability**, by officially anticipating a future energy supply system depending almost exclusively on renewable energy and utterly turning away from fossil energy carriers. The remodeling process involved will take decades and a number of defined issues are yet to be solved. Among others, dealing with the fluctuation of renewable forms of energy, such as sun and wind power, is one of the key challenges. Apart from the extension of the power grid, it is inevitable to provide capacities for energy storage to face this problem. These are able to buffer times when energy production exceeds or falls beneath the current demand. A more or less unnoticed approach is the possibility of reactivating unused building complexes to serve as medium scale storage units, in this case former military bunkers going back to the Second World War and the Cold War. Altogether about 3000 of these facilities **still exist in Germany, of which many are vacant to the present day inter alia because their specifications don't** match the requirements of residential or office use. Nevertheless, it is worthwhile to take effort in finding solutions to preserve these buildings since demolition is an elaborate task when dealing with walls up to three meters thick. Apart from that, the construction of new buildings can be prevented, which results in less energy consumption. The research covers the historical background of the bunkers in Germany and continues by defining relevant bunker types using cluster analysis. Finally, these bunker types are evaluated in terms of how their structural properties fit the requirements of two selected systems of energy storage.

Keywords: conversion, military bunker, energy saving

1. INTRODUCTION

For the next decades the German energy supply system will be undergoing a fundamental remodelling process. The so-called **"energiewende"** has officially been underway since the turn of the century and was further boosted by the nuclear catastrophe of Fukushima. The main goal is to become fully independent of fossil energy carriers like coal, gas or nuclear power and to rely solely on renewable forms of energy. This is a major step stone on the way to a sustainable future and the reason why the German government is taking great effort to support this endeavour. Amongst others, targeted funding is supposed to accelerate and support research in topics regarded as substantial for the success of the overall project. One of these thematic fields is energy storage. As stated in the abstract, energy storage facilities are needed to handle the discontinuous energy production of the renewable energy carriers, notably wind and sun power. A great deal of research in this field deals with raising the efficiency and the capacity of existing systems or developing new types of storage. In terms of size, the focus lies primarily on large-scale units in the range of several megawatt hours. But also small to mid-size plants can contribute to the overall need for storage capacity. In this case, apart from the option of constructing new buildings, it is worthwhile to examine the possibility of building conversion. Generally speaking, this can save resources, energy and help maintain buildings that are culturally or historically worth preserving. For a number of reasons the military building sector is of interest for this type of building transformation. First of all, Germany has a large stock of military facilities predominantly bunkers dating back to the Second World War and the Cold War. Numbers range at about 3000 preserved buildings. Secondly, these bunkers are equipped with a series of special structural properties such as exterior walls with a width of several meters, closed shell or large volume capacity that could meet the requirements of certain systems of energy storage. Finally, an existing conversion project in Hamburg demonstrates how a large-scale **"flakbunker" erected in 1943 can be transformed into a thermal energy storage unit. It was part of the International Building Exhibition in Hamburg dedicated to the topic of future sustainable city development.** Since completion in 2013, the bunker has been supplying up to 3000 households in the quarter with heating energy. Apart from being an interesting case study, this project proves that the basic approach discussed in this paper has the chance of being realized.

2. HISTORICAL GENESIS OF BUNKERS IN GERMANY

2.1 The second world war

As an introduction, it is necessary to sum up the historical events, which led to the construction of such a great number of bunkers in Germany. This is helpful for comprehending the different types of bunkers that are described and evaluated later. Although bunker construction can even be traced back to the First World War the initial impulse for bunker construction was given in the summer of 1940. In this year the first British bombardment of Berlin took place. Due to this incident the National Socialists ruling over Germany proclaimed a large-scale bunker construction program that was supposed to provide safety for the civilian population, military facilities and important traffic hubs in case the bombardments should continue. This program had top priority and the construction of the first bunkers almost immediately began in 1940. Officially the program was subdivided into three phases with the first phase lasting from 1940 to 1941 and completing 839 bunkers. The subsequent second phase lasted from summer 1941 to summer 1943 and the third phase basically continued until the end of the war in 1945. Beside the official program a number of bunkers were constructed for specific military or propaganda purposes. These are of particular interest because of their comparably large size and will be discussed in section 4.3.

2.2 The cold war

After the end of the war in 1945 many bunkers had resisted the bombardments and were supposed to be demolished by order of the Allies. But due to the fact that many refugees in the destroyed cities had no other choice but to use the bunkers as living space the so-called directive 22 was often not followed. Many bunkers were left untouched or simply made unsuitable for warfare purposes by cutting holes in the walls. With the dawning of the Cold War paradigms shifted again. Because the threat of nuclear war was omnipresent, the German government set up a civil defence program, which also included the use of bunkers. In comparison to the construction program carried out during the Second World War the civil defence initiative did not bring about many new bunkers. Instead, approximately 600 existing bunkers were retrofitted and then maintained. Furthermore, some special purpose large-scale underground bunkers were constructed, which are also worth mentioning and will be covered in section 4.6. After the end of the Cold War and the German unification the civil defence program was officially terminated in the year 2007. As a result, many bunkers maintained or constructed during the civil defence program lost their function and are vacant up to this day.

3. BUNKER TYPES AND ENERGY STORAGE SYSTEMS

3.1 General approach

When thinking about determining the potential of bunkers regarding their suitability for the conversion into energy storage facilities, two key elements are of importance. On the one hand, there is the existing building structure of the bunker defined by parameters like space, material and construction and on the other hand, there are the requirements of a technical system of energy storage addressing these properties in one way or another. Qualitatively one can evaluate the suitability of a selected bunker by simply confronting the existing structure with the requirements of an energy storage system. As a result the potential of a chosen bunker is dependent on to what extent requirements and conditions match. This procedure is meant to be applied on the level of bunker types. The goal is to point out those types within the bunker typology, which have the highest degree of suitability and are worthy of further inspection e.g. in a case study.

3.2 Bunker typology

The first step in the potential analysis is to set up a bunker typology and thereby to get an overview on the existing types. Methodologically, cluster analysis is applied, grouping or distinguishing types by architectural / constructive features that are measured by nominal¹ as well as ordinal² scales. The starting point is an existing typology defined by Foedrowitz, who just differs between two very basic types: bunkers constructed above (overground bunkers) and bunkers constructed below (underground bunkers) the surface. Cluster analysis then goes by divisive analysis technique, building up the typology hierarchically, but in reverse order. This means that the two predefined bunker types are gradually split up into a number of sub-types. The outcome of this method is a typology consistent of eight bunker types, which can be subdivided into two layers (Table 1). Each layer represents a step of clustering. The precision of the defined bunker types increases with each one of these steps. Essentially layer two originates

bunker types that are precise enough to commence with the evaluation method mentioned in the previous section, naming those types that have the highest potential.

overground bunkers	1 small-scale serial bunkers of phase one
	2 mid-scale and partly standardised bunkers of phase one and two
	3 large-scale bunkers with extraordinary features
underground bunkers	4 embedded underground bunkers
	5 exposed underground bunkers
	6 tunnel-like underground bunkers

1 Nominal scales measure whether a certain feature exists or not. E.g. types one, two and three are differentiated whether they are associated to phase one or phase and two or not and if they are serial, partly standardised or not.

2 Ordinal scales enable a rank order that is based on the degree of a certain feature. E.g. types one and two and three are ranked as small-, mid- and large-scale according to their size.

Table 1: Bunker typology [source: author]

3.3 Energy storage systems

Apart from knowing the properties of the bunker types it is essential to be aware of the demands laid down by the energy storage systems. This paper focuses on two selected systems of electrical energy storage: flywheel and compressed air storage. Both are relevant, since flywheels are already in use for saving renewable energy and compressed air storage is predicted to evolve to one of the leading systems in this field in the near future. Flywheels are prefabricated cylindrically shaped modules with an overall weight of about 2 t, a diameter of approximately 1 m and a height of 2 m (manufacturer data) that rotate a mass at high speed to store energy kinetically. Usually they are deployed in large numbers to increase storage amount and performance. Compressed air storage systems save energy by compressing and decompressing outside air up to 72 bars. Currently there are only two existing plants in service: one in Elsfleth, Germany and one in Alabama, USA. Both rely on artificial salt domes voids that are located beneath the facility to act as storage space for the compressed air. As stated in section 3.1, each storage system has a set of substantial structural requirements. These are derived from a thorough system analysis based on literature review and then assigned to four categories, dependant on the way they affect the building. These are dimensions, spatial structure, load-bearing structure and shell. Essentially, flywheel storage installation is dependent on the spatial structure and the dimensions of a building. First of all, sufficient space on ground floor level is mandatory to place a significant numbers of units. Secondly, the designated space should at best be free of columns or the like and, to ensure maintenance, the clear room height must at least be twice the height of the flywheel. In addition, the ground floor level should be equipped with adequate openings to allow the flywheels modules to be brought into the building. In contrast, the demands of compressed air storage revolve around all four categories. To begin with, the basic precondition is ample volume capacity and dependent on building dimensions. It determines the amount of potential energy that can be stored. Next are the requirements associated to the load-bearing structure, which are somewhat challenging. They result from the extraordinary surface loads induced by air compression ranging between 800 kN/m² (8 bars) and 3200 kN/m² (32 bars). Therefore, in any case, the load-bearing structure ought to be designed for surface loads. Furthermore, it should be constructed of reinforced concrete and preferably be form active, e.g. circular cross-sections. Especially form activity can substantially increase load-bearing capacity and is the main reason why newly built storage tanks are usually cylindrically or spherically shaped. Linked to this aspect is the favouring of sub-terrain buildings. Not only shape but also earth pressure can help compensate surface loads. Furthermore, this can buffer the heat, which inevitably arises during the air compression process. The last aspect concerns air leakage. Either way, the building shell should have little to no openings at all. Air tightness is a different issue. Very likely it will have to be ensured subsequently by taking measures in the course of the conversion. One possibility is airtight foils, which are commonly used in the field of passive house construction.

4. POTENTIAL OF BUNKER TYPES

4.1. Small-scale serial bunkers of phase one

Bunker 1	Bunker 2
size	size
17 * 20 * 12 [m]	18 * 18 * 39 [m]
volume capacity	volume capacity
app. 4100 [m ³]	app. 12 000 [m ³]
shell thickness	shell thickness
2 [m]	2 [m]

Table 2: Bunker specifications referring to section 4.2 [source: author reference to [10]]



Figure 1: Outside view [source: author] and section of a variant "winkel" bunker [source: 11]

This type of bunker is of interest for two reasons: standardisation and high quantity. There are three versions named "winkel", "zombek" and "diemel". Variant "winkel" is shown in Figure 1 and totals to a number of 200 built. Regulations at the time limited it to 500 people and a diameter of just 10 m, which results in an estimated volume capacity of merely 1000 m³. Regarding potential, this bunkers properties do not fit any of the necessary system requirements. First of all, the small volume capacity negates compressed air storage, especially because other WW II bunker types have greater capacities up to 12 000 m³. Secondly, the lack of space on the ground floor combined with insufficient clear room height and access possibilities excludes flywheel systems.

4.2. Mid-scale and partly standardised bunkers of phase one and two

A great deal of the bunkers situated in Germany can be assigned to this type. All are multi storey buildings and constructed of reinforced concrete. In the most cases they are equipped with two opposite entrances, two separate staircases and basically have no windows. Overall size gradually increased from 1941 to 1945, whereas the thickness of the shell continuously ranged between 1 m and 2.50 m. Table 2 lists the specifications of two selected bunkers shown in Figure 2, which can be considered as representative for this type of bunker. Taking these characteristics into account, flywheel storage can be excluded due to the same reasons named in the previous section, whereas the considerable increase in volume capacity up to 12 000 m³ makes compressed air storage a conceivable option. Moreover, there is a very durable and more or less closed shell, which contributes to the level of potential. The decisive question is the amount of pressure that the bunker shell can withstand. Technically, the energy density achievable ranges from app. 0.35 kWh/m³ (8 bars) to 0.75 kWh/m³ (32 bars), totalling in 2.5 MWh to 5.2 MWh of electrical energy that could be stored. This corresponds to the daily energy consumption of 250 to 520 single-family houses. Ultimately, only a case study can clarify this issue, which would also include the evaluation of material samples from walls and ceilings. Nevertheless, two aspects can give some indication. First of all, research shows that the concrete strength of the bunker walls has gone from level C30 to C55 due to 70 years of subsequent hardening. Secondly, the amount of steel reinforcements used at the time is significantly higher than what the German DIN norm requires today. Table 3 demonstrates that bunkers walls with a thickness of two meters contain up to six times more steel reinforcement.

Total cross section surface of steel reinforcements		
1		
norm wall	30	[cm ² /m]
2		
bunker wall	193	[cm ² /m]
Factor: 2 / 1 = 6.4		

Table 3: Comparison of steel reinforcement [source: author reference to [14][15]]

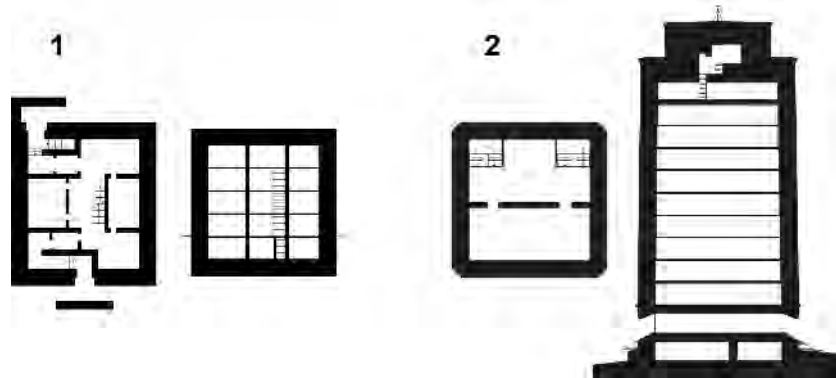

Figure 2: Standard floors plans and sections of bunkers [source: author reference to [10]]

4.3. Large-scale bunkers with extraordinary features

Good examples for this type of bunker are the so-called **“flakbunkers”**, which were already mentioned in the introduction. Altogether, eight slightly different variants were built in Hamburg, Berlin and Vienna. Today only five remain. The others were torn down after the war. In terms of spatial structure they are comparable with the other phase one and two bunkers but are much larger and have a shell up to 3.50 m in thickness. As a result, the suitability for compressed air storage is somewhat higher when compared to the mid-scale bunkers. Analogous to the previous bunkers flywheels can be excluded.

4.4. Embedded underground bunkers

This is the first bunker type covered that originates from the cold war. These one or two storey bunkers were always integrated in the basement of another building e.g. a public school or an administration office, not least on account of protection and camouflage. The floor plans are subdivided into a rather large number of small sized corridors and rooms and can most likely be compared to those of a hospital. Walls and ceilings are not as thick as those of WW II facilities and often only the ceiling slab was exceptionally heavy. Due to their ordinary spatial structure, the comparably slim ceilings respectively walls and the fact that they are connected to another building make these bunkers incompatible with the two energy storage systems portrayed.

4.5. Exposed underground bunkers

The so-called **“warnamt”** bunkers are one of the few examples for this bunker type. Altogether ten were newly built during the Cold War period. The office for public warning was established as a part of the civil defence program and had the task to alert the public and to carry out safety measures prior to, during and after an attack. The bunkers acted as control centres. From a structural point of view and considering size they are comparable with the mid-scale bunkers described in section 4.2. The main difference is that the shell was constructed with a thickness of three meters. This aspect and the sub-terrain position increase suitability for compressed air storage. Again, flywheel storage cannot be applied.

4.6. Tunnel-like underground bunkers

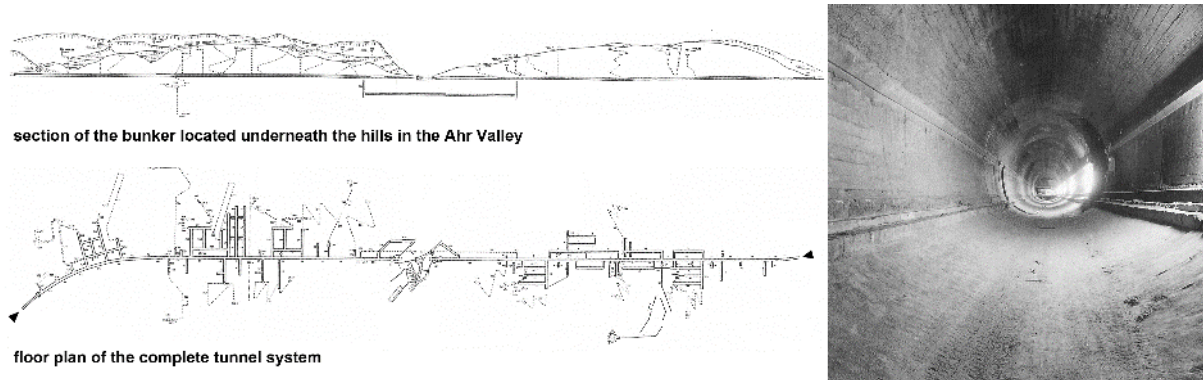

Figure 3: Plan of the government bunker and indoor image after disassembly

The tunnel-like underground bunkers are a very divertive type. On the one hand, there are facilities dating back to the WW II, which were built during the third phase of the construction program initiated by the National Socialists. Generally, these bunkers are more or less ruinous today because resource use was strictly limited at the end of the war. This can be verified by a study done on a number of such bunkers located in and around the town of Salzgitter. On the other hand, there are bunkers constructed during the Cold War period. Until this day, information concerning these facilities is rather scarce because they were highly confidential and not open to public. Many served military purposes and acted as depots for ammunition, fuel or other supplies. One example for a bunker that is sufficiently documented and accessible is the German government bunker built between 1952 and 1972. It was fully protected and was suppose to serve as a retreat where government service could continue in the case of nuclear warfare. Constructed in the tube of an uncompleted railway tunnel it consisted of 19 km of tunnels after completion. Today the bunker is almost entirely disassembled with only the naked concrete tunnel walls remaining (Figure 3). This bunker type has the highest degree of suitability. The ovoid profile of the main tunnel is app. 8 m in height and app. 6 m in width, which enables the deployment and maintenance of flywheel units. The overall length of 19 km also allows a very large number of modules to be placed. But especially for compressed air storage conditions match such as sub-terrain position, ample volume capacity, closed shell and form activity. With a usable volume capacity of app. 250 000 m³ and applied pressures ranging from 8 bars to 32 bars it would be possible to store app. 87.5 MWh to 187.5 MWh of electrical energy.

5. CONCLUSION

Initially, this paper demonstrates that former bunkers have a potential for the conversion into energy storage facilities. Altogether, four of the six defined types are equipped with a series of structural features that favour this task. In the most cases these are limited to compressed air storage. Put into order, the degree of suitability gradually increases from the mid-scale and partly standardised bunkers of phase one and two, to the exposed underground bunkers, to the tunnel-like underground bunkers, which have an exceptionally high degree of suitability and can provide comparably large storage amounts. Regarding application, a bunker storage unit could save the midday surplus production of photovoltaic systems and provide this energy in the evening when household demands reach a peak. Thereby, not only the quantity of renewable energy used is increased but also the load on the power grid can be relieved, contributing to the energy independence of neighbourhoods. But the approach shown in this paper is not limited to bunkers. It can also be applied on other types, e.g. industrial buildings. Especially from a global perspective this could be of interest, since brownfield conversion is a reoccurring question in urban planning worldwide and is associated to many aspects essential for the development of sustainable cities.

REFERENCES

- [1] Bundesministerium für Umwelt, Naturschutz und Reaktorsicherheit, Bundesministerium für Wirtschaft und Technologie [eds.], 2011. Energiekonzept für eine umweltschonende, zuverlässige und bezahlbare Energieversorgung. Berlin
- [2] Bundesministerien für Umwelt, Naturschutz und Reaktorsicherheit, für Wirtschaft und Technologie und für Bildung und Forschung, Projektübersicht. Retrieved from: <http://forschung-energiespeicher.info> [Retrieved on 31 Mai 2016].
- [3] Foedrowitz, M., 1998. Bunkerwelten. Berlin

- [4] Internationale Bauausstellung [eds.], 2010. Energieatlas - Zukunftskonzept Erneuerbares Wilhelmsburg. Hamburg
- [5] Lubbe, C., 2013. Bunker aus dem Kalten Krieg. Stuttgart
- [6] Stein, P. and Vollnhals, S., 2011. Grundlagen clusteranalytischer Verfahren. Duisburg
- [7] Sterner, M., and Stadler, I., 2014. Energiespeicher - Bedarf, Technologien, Integration.
- [8] Doetsch, C. and Budt, M., 2012. Adiabates Niedertemperatur Druckluftspeicherkraftwerk zur Unterstützung der Netzintegration von Windenergie. Oberhausen
- [9] Passivhausinstitut, Aktiv für mehr Behaglichkeit: Das Passivhaus. Retrieved from: <http://www.passiv.de> [Retrieved on 03 March 2016].
- [10] Bundesanstalt für Immobilienaufgaben, Exposés. Retrieved from: <https://www.bundesimmobilien.de> [Retrieved on 03 Feb 2015]
- [11] Foedrowitz, M., 1998. Luftschutztürme und ihre Bauarten 1934 bis heute. Wölfersheim Berstadt
- [12] Fricke, J. und Borst, W.L., 1981. Energie. München
- [13] Bundesanstalt für Immobilienaufgaben [eds.], 2015. Bunker beleben. Berlin
- [14] Kern, G., 1961. Bauliche Instandsetzung von Schutzbunkern - Allgemeine Betrachtungen zu den Richtlinien. Zivilschutz, 9, 304 - 307
- [15] Beer, K., 2015. Bewehren nach DIN EN 1992-1-1 (EC2) - Tabellen und Beispiele und Konstrukteure für Bauzeichner. Wiesbaden
- [16] Angerer, H., 2000. Flakbunker. Hamburg
- [17] Bundesamt für Bauwesen und Raumordnung und Stiftung Haus der Geschichte der Bundesrepublik Deutschland [eds.], 2006. Der Regierungsbunker. Tübingen
- [18] Rychlak, M., 2007. Ehemalige unterirdisch Luftschutzstollen im Stadtgebiet Salzgitter – Abschlussbericht. Salzgitter

An Evaluation of Building Integrated Wind Energy

Mehmet Koray PEKERICLI^a, Ali Murat TANYER^b

^a METU, Turkey, koray@metu.edu.tr

^b METU, Turkey, tanyer@metu.edu.tr

ABSTRACT

Microgeneration of energy is one of the major research areas in the sustainability field. While there are multi-faceted benefits in the generation of energy locally, the scales of economy and underestimation of difficulties in practical application hinders the uptake. Microgeneration through wind energy is no exception. While the history of wind energy proliferation shows an increasing trend of bigger and higher capacity installations in remote locations, architects and planners kept on envisioning the integration of single miniaturized turbines on buildings as the future of smart cities. Including few iconic examples, the application of wind turbines on building roofs has not proved success. In this paper, a review of microgeneration issues and potential technologies for a breakthrough will be presented. The authors aim to propose a distributed wind energy harvesting system embedded in building facades that also works as a ventilation device at different modes.

Keywords: high performance buildings, wind energy, microgeneration

1. INTRODUCTION

When the electrical energy distribution was at its infancy, the power stations were all located close to the demand, i.e., Bankside Power Station in London (currently Tate Modern **Gallery**), **Silahtarağa Power Station in İstanbul** (currently santralistanbul Modern Art Gallery). These industrial buildings were an important part of the cityscapes at that era, dominating the skies with their tall chimneys and long spanning voluminous interior spaces. Exclusively running on fossil fuels, these power generation stations were serving a rather limited demand (of only illumination and basic appliances). Increasing populations and ever-expanding uses of electricity led to higher demand, requiring higher capacities. In addition, sustainability issues regarding the supply of energy source (i.e., coal), and increasing pollution within city boundaries caused inconvenience and discomfort. As a result, the power stations were moved closer to the sources of energy, such as coal mine regions, hydro/wind potential locations, and later custom build nuclear power plants at strategical locations. Such move brought the cost of energy loss (up to 10%) during transmission to the demand. However, throughout the 20th century this issue was not much of a concern until the awareness of Global Warming has become an influential matter. During the search for a sustainable energy generation method, harvesting wind power for electricity has become one of the major strategies. **Basic concepts of wind energy can be seen in Herbert et al.'s work, and the history in Kaldellis and Zafirakis's work.**

Microgeneration is the small-scale generation of heat and electric power by individuals, small businesses and communities to meet their own needs. It came out of a need, when distant locations and communities were yet to be connected to the main energy grid. Most small towns and villages had their own microgeneration strategy based on local resources and skills. Ever-reaching network of the energy grid has led to the demise of microgeneration throughout 20th century, until its re-birth just at the turn of 21st century. The current take on microgeneration is focused on its increased efficiency (via reduced transmission lines, and more efficient conversion technologies, i.e., co-gen, tri-gen) and reduced carbon dioxide (CO₂) emissions (due to higher use of renewable energy sources, i.e., solar, wind, bio-mass).

It is possible for a building to supply/produce its own energy without the need to be supported by fossil fuels. For this, first of all, the energy demand has to be reduced. Green buildings or zero energy buildings (ZEB) are two of the recent initiatives that help designers reduce the energy demand. These incentives support the use of energy from renewable resources including building integrated energy generation solutions.

Microgeneration applications of solar energy as a building integrated solution is a straightforward one, i.e., covering roof surfaces, utilizing backyards, and creating temporary structures. However, the integration of wind energy solutions has always been problematic. While the wind energy in urban areas has a sensational enigma to it with its relatively large installations (i.e., visually dominant and attractive revolving turbines), it has yet been proven that these solutions are worth the effort. There are few iconic examples for integrating the wind turbines to the building

architecture (i.e., Bahrain WTC, London Strata Building, etc.), but these are one-off and problematic applications. Nevertheless, governments are still subsidizing these microgeneration initiatives via grants and tax returns.

The issue with wind energy microgeneration integration into buildings stems from the fact that conditions required for conventional horizontal axis wind turbines are difficult to satisfy in urban areas since these conditions are mutually exclusive with the needs for user comfort. In addition to that, these wind turbine installations generate vibration and noise, cause structural loads, and pose risk to the surrounding environment. Many major building integrated wind power turbines are plagued with user complaints, under-performance, and technical problems. These issues stem from the fact that earlier proposals were trying to import scaled down versions of industrial wind turbines onto building tops. However, it is reported that building tops have chaotic wind regimes with strong turbulence, leading to failing applications. Research shows that due to this situation such investments rarely pay-back within their lifetime. Also it was shown that majority of micro wind turbines installed in the UK did not receive sufficiently high wind resource to make them economic.

In this paper a sea-change in the integration of wind turbines to buildings in urban environments is called for. The authors would like to call this new approach nano-generation. While urban environments do not provide the necessary conditions for conventional horizontal axis wind turbines, there are still wind energy harvesting opportunities that can be exploited via other methods. High rise buildings in dense urban environments create a chaotic, turbulent flow of air between large vertical surfaces. Contemporary building technology and architecture calls for separate building skins that improve the internal conditions of facilities. The authors claim that it is possible to create complex building skins with embedded airfoils that generate small amounts of energy, continuously. Harvesting from a distributed network of such energy generators, building façades can be a positive contributor to **a facility's energy ledger book. The inspiration for this application was taken from the emerging re-generative braking technology applied in most hybrid and electric vehicles.** This technique converts the kinetic (or potential) energy of the vehicle to electrical energy via existing drivetrain and motor, and stores it in battery. In reality, all wind turbines can be considered some sort of regenerative brake devices which brake the wind. However, the analogy of the buildings to electric vehicles stems from the fact that in buildings the existing ventilation infrastructure can be re-thought and utilized to allow both the intake of air into spaces, and generate energy when possible. In a similar fashion to electric vehicles, a building façade can be designed to have a distributed network of ventilation devices, which in certain modes (i.e., when they are not active, or diverted) can be used for generating energy by letting the airflow pass through. The façade and the integrated distributed nano-generation technology can be developed using parametric design tools and also become a reflection of creative architectural concepts.

2. CURRENT STATE IN BUILDING INTEGRATED WIND ENERGY

Microgeneration through wind turbines mounted on buildings has serious issues due to the fact that calculation of actual wind patterns is a difficult and expensive task. According to Walker this is particularly important since these installations reside within the surface roughness layer, thus being under strong influence of the surrounding buildings. Urban wind patterns have a complex structure, which is investigated by researchers mostly for pollution dispersal and pedestrian comfort reasons. Investigation of wind speed calculation methods in urban environments for wind energy purposes was done previously. Moreover, due to a continuous development in urban environment, the wind patterns change character in time. Therefore the exploitation of wind power in urban environments is very different in comparison to rural or off-shore implementations.

Wind energy microgeneration strategies in urban environments almost exclusively rely on scaled down applications of conventional wind turbines used in remote wind farms. These turbines inherently rely on constant and sustained flow of air, thus well researched and executed wind farm investments in rural or off-shore implementations. The rooftop wind turbines do not have the efficiency of remote wind farm installations due to turbulence and chaotic behavior of air movement in urban areas, leading up to ten-fold reduction in their efficiencies. Research points at the need for the investigation of low-speed wind turbines for urban areas.

There are several studies previously done, focusing on the urban wind energy generation problem. For instance **Sharpe and Proven proposed an "innovative 'true' building integrated wind turbine" based on Darrieus turbine form.** While horizontal axis wind turbines have proven higher efficiencies at constant and relatively high wind speeds; vertical axis wind turbines can fulfill the energy generation purposes at high wind turbulence, wind fluctuations, and high directional variability. Vertical axis wind turbines had been widely used since 2nd century BC until the 20th century in Iran and Afghanistan and their suitability of urban wind energy generation was investigated by Müller

et al. Castelli et al. and Balduzzi et al.. These analyses showed that for higher efficiencies, the installations require to be on the highest buildings in the urban environment Grant et al. proposed a ducted wind turbine that used pressure differentials created by wind flow around a building, increasing the efficiency and reducing risks via safety enclosures.

The common element for these studies are their insistence on installing miniaturized but still relatively large wind turbines on buildings. It has been many times proven that the wind regime on building surfaces has a chaotic and unexpected nature. These findings support the proposed solution which aims to utilize the whole building surface for harvesting the wind energy.

3. A PROPOSAL: 'REGENERATIVE' VENTILATION

One of the highest energy cost items in medium-large buildings stem from heating, ventilation, and air conditioning systems (HVAC). These systems take fresh air, condition it to achieve the correct temperature and humidity, and mix it with the indoor air. Most of these systems are composed of large and centralized equipment, carrying the air into spaces via ducts. Carrying of air into spaces is called ventilation, which uses electric power 4.1% of whole energy consumption. While the other energy cost items (such as heating and cooling) have a decreasing trend for the next decades (see Figure 1), the ventilation energy costs are predicted to linger. This is due to the fact that the technology for ventilation has already achieved maturity and no major changes are expected in its efficiency. An investigation of ventilation types and their efficiencies are discussed . A major criticism of centralized HVAC systems is that it is difficult to adjust the local climatic conditions. These installations are designed with the assumption of full occupancy. However, most buildings operate much below their full occupancy targets. As a result, most of the building spaces are ventilated for no useful reason. This is one of the major reasons for the wasted energy in medium-large buildings. A new trend in building technology aims to detect the presence and movements of users and condition the environments locally. This trend sets the case for the focus of research on ventilating buildings locally.

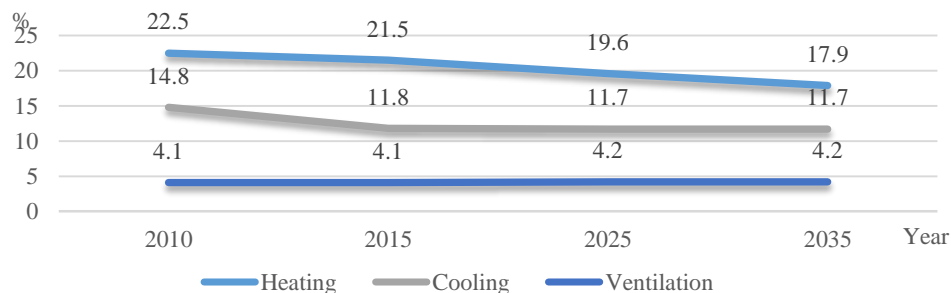

Figure 19: Projection of building services energy loads – data from DOE

In this study an analogy between electric vehicles and buildings is offered. In a hybrid/ electric car, the energy stored in batteries is used to power the drivetrain and create movement. During slow-downs, instead of conventional braking (which convert kinetic energy to heat), the drivetrain motors are used for charging the batteries by creating resistance on the wheels due to induction load. This is called re-generative braking. The use of regenerative braking in transportation predates hybrid/electric vehicles. Studies show the use of regenerative braking in railway locomotives as early as 1970s. An important advantage of regenerative braking is due to the ability to use existing drivetrain and hardware that moves the vehicles to slow them down and generate energy. One of the most difficult technical hurdles in regenerative braking is the ability to store the generated energy quickly and efficiently. Super capacitors are a partial solution for this problem since they can be charged with high currents and offer a virtually maintenance free storage option for regenerative braking systems. Automotive manufacturer firm Mazda invented a simple regenerative braking technology on gasoline engine cars based on super capacitors. This technology eliminates the need for large batteries for such a system and increases fuel efficiency since the load of alternator is reduced by the utilization of energy stored in super capacitors (see Figure 2). However, super capacitors store only a limited amount of burst energy, which can be directed to other systems and relieve the load of alternator and main batteries in these cars, thus achieving fuel efficiency.



Figure 20: Super capacitor integrated automotive regenerative braking system overview

Another innovative application of regenerative braking is proposed by Volvo, where a high-mass flywheel in vacuum is connected to rear wheels of a car (Flybrid® KERS - Kinetic Energy Recovery System). The flywheel is accelerated during slow-downs and continues to spin for a long time due to lack of friction and high-mass. When needed, the kinetic energy stored in the device is transferred to the wheels to improve acceleration performance. This system is more complex and costly since it requires extra hardware and controllers for operation. While it is a regenerative braking technology, it sets itself apart from the rest of the solution provided by other makers. Regardless of their implementation methodology, most of the regenerative braking technologies improve the energy efficiency performance of vehicles at a fraction. However, these techniques are still investigated and there are continuous research and development activities ongoing for their improvement.

A similar relationship can be created between buildings ventilation and naturally occurring winds around building façade. The winds around building facades has a temporal and chaotic character. The pressure zones around a building changes according to season, time of day, or temporary climatic events. Regardless of the existence of wind around buildings, centralized ventilation systems continually use energy to divert fresh air indoors. In this paper it is proposed that the ventilation inlets can be spread throughout building facades and operated on a need-base. These ventilation inlets can be integrated to each façade such that they can (1) run on electrical energy and provide air indoors, (2) make use of positive outdoor pressure and let air in while generating power via ventilation fans, and (3) shift the air route, bypassing indoors and generating energy via ventilation fans. This system can potentially reduce the energy wasted on building ventilation via the reduction of overall ventilated areas, positively generated energy in suitable conditions, and excess energy generation in no-ventilation scenarios.

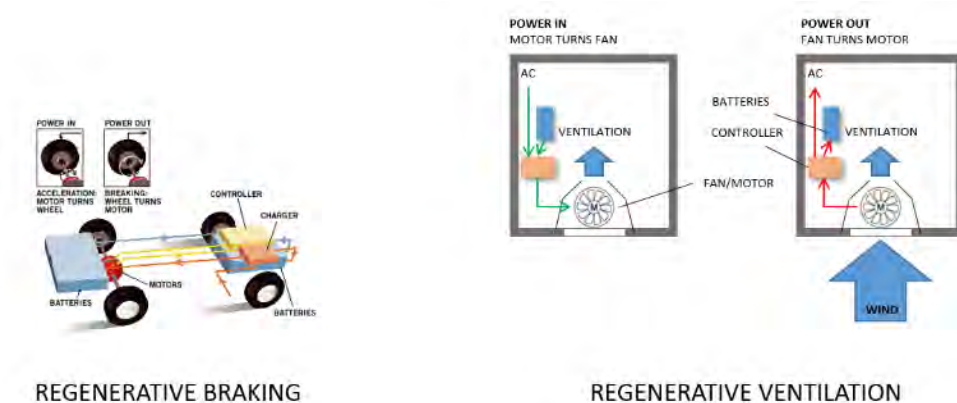

Figure 3: The regenerative braking analogy

The whole system can be devised as a contained solution, where the wind turbine, gearbox, and energy storage device can reside as a single field replaceable unit. Excess energy generated by the units can be fed back to building via purpose-built lines, or transferred across a closed circuitry which is connected to each ventilation unit throughout the building. This way the naturally occurring winds around the building can be utilized for continuously running the localized ventilation systems across the building.

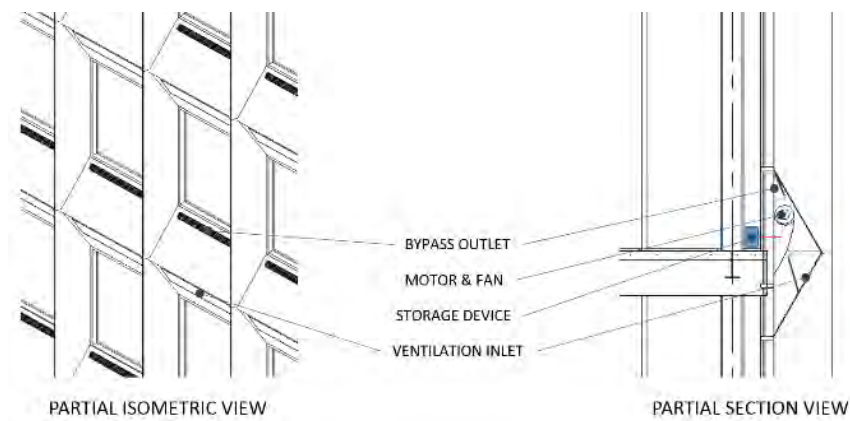

Figure 4: A partial isometric and section views of the proposed façade

As seen in the Figure 4 the proposed system is a façade skin that embodies the ventilation and energy generation device as a single unit. At each floor these units are matched to the windows, letting the façade wind in (through operable ventilation inlet) and ventilating the indoors or just letting the wind out through bypass outlet. According to different operating conditions, energy is generated or used by the system according to the availability of façade wind conditions or internal ventilation needs (Figure 5). The whole system should be controlled by a central building management system (BMS), which collects and interprets data from a sensor network spread throughout the building. According to user occupancy data and interior air quality, the BMS can operate the integrated diversion flaps in these units to either ventilate indoors by means of wind energy or electricity, or to let the air bypass the system to generate energy.

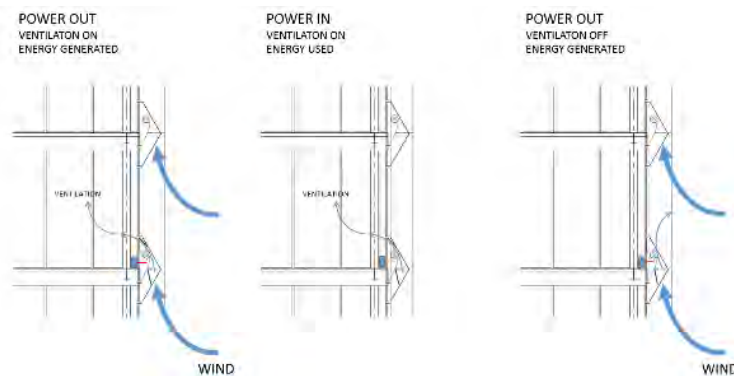

Figure 5: Three states of regenerative ventilation device

The proposed solution allows the conditioning of the external air by means of local heating and cooling coils and also micro-humidifiers. This is not a finished/complete design, but only a tool to describe the need and the potential. There is more research that needs to be done to investigate the practicality of the approach via the investigation of the suitability of the temporal wind conditions and the influence of units on air flow through the building surface as a whole system.

The researchers intend to have a design proposal for the integration of nano-generation into building façades and other elements for distributed energy generation at the end of this research project.

4. CLOSING REMARKS

This research project is an exploratory study aiming to investigate the possibility of harvesting wind energy from whole building surface by means of small distributed wind turbines which also work for the ventilation of indoors. There are no results yet; the project is still at its literature review stage. The proposal needs to be discussed further and more research related efforts need to be investigated. The upcoming tasks are determined as further literature review, collecting data on surface wind patterns from case buildings, and investigation of computational fluid dynamics for further role in the test of this proposal. With the aid of these efforts the study will focus on developing a prototype device and calculate its effectiveness at a built environment setting. The results from these experiments will identify the performance characteristics of the proposed solution.

REFERENCES

- [1] Herbert, G.J., et al., A review of wind energy technologies. *Renewable and sustainable energy Reviews*, 2007. 11(6): p. 1117-1145.
- [2] Kaldellis, J.K. and D. Zafirakis, The wind energy (r) evolution: A short review of a long history. *Renewable Energy*, 2011. 36(7): p. 1887-1901.
- [3] Peacock, A., et al., Micro wind turbines in the UK domestic sector. *Energy and Buildings*, 2008. 40(7): p. 1324-1333.
- [4] Mithraratne, N., Roof-top wind turbines for microgeneration in urban houses in New Zealand. *Energy and Buildings*, 2009. 41(10): p. 1013-1018.
- [5] James, P., et al., Implications of the UK field trial of building mounted horizontal axis micro-wind turbines. *Energy Policy*, 2010. 38(10): p. 6130-6144.
- [6] Walker, S.L., Building mounted wind turbines and their suitability for the urban scale—A review of methods of estimating urban wind resource. *Energy and Buildings*, 2011. 43(8): p. 1852-1862.
- [7] Ledo, L., P. Kosasih, and P. Cooper, Roof mounting site analysis for micro-wind turbines. *Renewable Energy*, 2011. 36(5): p. 1379-1391.
- [8] Sharpe, T. and G. Proven, Crossflex: Concept and early development of a true building integrated wind turbine. *Energy and Buildings*, 2010. 42(12): p. 2365-2375.
- [9] Pope, K., I. Dincer, and G. Naterer, Energy and exergy efficiency comparison of horizontal and vertical axis wind turbines. *Renewable Energy*, 2010. 35(9): p. 2102-2113.
- [10] Müller, G., M.F. Jentsch, and E. Stoddart, Vertical axis resistance type wind turbines for use in buildings. *Renewable Energy*, 2009. 34(5): p. 1407-1412.
- [11] Castelli, M.R., A. Englaro, and E. Benini, The Darrieus wind turbine: Proposal for a new performance prediction model based on CFD. *Energy*, 2011. 36(8): p. 4919-4934.
- [12] Balduzzi, F., et al., Feasibility analysis of a Darrieus vertical-axis wind turbine installation in the rooftop of a building. *Applied Energy*, 2012. 97: p. 921-929.
- [13] Grant, A., C. Johnstone, and N. Kelly, Urban wind energy conversion: The potential of ducted turbines. *Renewable Energy*, 2008. 33(6): p. 1157-1163.
- [14] DOE, U., 2011 Buildings Energy Data Book. 2012. p. 286.
- [15] Varodompun, J. and M. Navvab, HVAC Ventilation strategies: The contribution for thermal comfort, energy efficiency, and indoor air quality. *Journal of Green Building*, 2007. 2(2): p. 131-150.
- [16] Yang, Z. and B. Becerik-Gerber, Modeling personalized occupancy profiles for representing long term patterns by using ambient context. *Building and Environment*, 2014. 78: p. 23-35.
- [17] Gilmore, D., Fuel economy goals for vehicles with regenerative braking energy storage systems. *International Journal of Vehicle Design*, 1992. 13(2): p. 125-133.
- [18] Schacher, R., REGENERATIVE BRAKING EQUIPMENT FOR CLASS RE 6/6 LOCOMOTIVES OF SWISS FEDERAL RAILWAYS. *Brown Boveri Review*, 1973. 60(12).
- [19] Saito, T., Y. Kibi, and A. Ochi. Super Capacitor for Energy Recycling Hybrid Vehicle. in *SAE CONFERENCE PROCEEDINGS* P. 1996.
- [20] Teymourfar, R., B. Asaei, and H. Iman-Eini, Stationary super-capacitor energy storage system to save regenerative braking energy in a metro line. *Energy Conversion and Management*, 2012. 56: p. 206-214.
- [21] Dixon, J.W. and M.E. Ortuzar, Ultracapacitors+ DC-DC converters in regenerative braking system. *Aerospace and Electronic Systems Magazine, IEEE*, 2002. 17(8): p. 16-21.
- [22] Weissler, P. Mazda introduces supercapacitor-type regenerative braking. 2013 [cited 2016 03.02]; Available from: <http://articles.sae.org/11845/>.
- [23] Volvo Car Group. Volvo Car Group and Flybrid Conduct UK Testing of Flywheel KERS Technology. 2014 [cited 2016 02.03]; Available from: <https://goo.gl/mn0FMQ>

Session 5.3: Smart Initiatives in SBE (1)

The New Smart Cities | Cities Built from Scratch and Old Cities Transformed into Smart Cities. Sustainable Growth

Ana Claudia Figueiredo OLIVEIRA^a, Carlos Alberto Assunção ALHO^b

^a Lisbon Faculty of Architecture, Portugal, anaclaudiafigueiredooliveira@gmail.com

^b Lisbon Faculty of Architecture, Portugal, carlosalho10@gmail.com

ABSTRACT

Cities are the habitat of the knowledge-based economy. Cities produce and attract human capital and are today giant interface of communication, cities possess the critical mass for production and diffusion of knowledge, innovation and integration of human networks, which enable sustainable growth. At the same time cities are the true heart of innovation. The aim of this paper is to create architectural interventions on these new cities for the creation of spaces that all human beings can feel comfortable as they are inside old cities and with modern and sustainable contents. The new type of city concept focus on not develops only buildings and beautiful construction. They will produce concepts of community for inhabitants and not only a network with technologies. All the data from these spaces will be incorporated inside an Open Community Data, where the citizens participate actively on decisions, and empowering citizens in a construction of a participatory e-society. **According to Jeff Speck “a walk has to be useful, safe, comfortable, and interesting if you’re going to get people out of their cars and into the sidewalks”. Architecture has to produce feelings and sensations to inhabitants. A city is not an object as a simple “fridge”. The focus on public spaces and common areas inside buildings, how they connect with each other it is an objective and the technologies that we use, we apply, we see and we find are points that we can’t forget.** The aim of this research is to determine some architectural concepts that will help cities, but especially planners and architects, their role, their tools and their strategies. The paper argues the future sustainability of spaces maintenance and their strategic plan applied on these New Smart Climate Smart Cities where will be produce outcomes on techno-economic scenario analysis and on the socio-economic impacts.

Keywords: climate smart cities, green architecture, cities.

1. INTRODUCTION

“Smart Cities” are part of our modern society and are strong models on our generation, but as everything, we have the positive face and the negative face, it always depends on how spaces are used. These spaces are a reflection of the enormous technological advances provided by years and years of studies promoted by the human being, that in certain actions go beyond the physical barrier allowing the people to live in a space at the beginning of virtually, without borders. Like many inventions changed the history, the Smart Cities are revealed as a tendency for new generations marking determining and creating a new type of culture.

At the end, what are real Smart Cities? What are Smart Cities? Across the world, the stride of migration from rural to urban areas is increasing. By 2050, about 70 per cent of the population will be living in cities, and India is no exception. It will need about 500 new cities to accommodate the influx according to this statement human beings are trying to react to the law of supply and demand, and trying to find a way to be able to solve a future problem. **Cities are modern creations ...where information technology is the principal infrastructure and the basis for providing essential services to residents.** The origins can be at some especial lines. The concept of smart cities originated at the time when the entire world was facing one of the worst economic crises. In 2008, IBM began to work on 'smarter cities' concept as part of its Smarter Planet initiative. By the beginning of 2009, the concept had **captivated the imagination of various nations across the globe...** On article of November 11th of 2014, on the SustainableCitiesCollective, Nina Bianchi and Kat Hartman, describe Smart Cities as a skeptical image of a **“remote-control city...”** The definition says **A city can be defined as ‘smart’ when investments in human and social capital and traditional (transport) and modern (ICT) communication infrastructure fuel sustainable economic development and a high quality of life, with a wise management of natural resources, through participatory action and engagement...**

Smart City means efficiency, but efficiency is where human beings are also involved in its development. Smart Cities are characterized as «innovation ecosystems» could offer ample opportunities for sustainable, user-driven «intelligent services»...” **If these spaces are well designed, they can become multicultural areas and knowledge zones and development where citizens will want to live with quality of life.** However, the economic pressures have led some errors in planning and management. A city cannot provide only this feeling. No other city in South Korea, has attracted more attention than Songdo, the skyscraper-intensive, apparently eco-friendly ‘smart city’ built along reclaimed waterfront land in Incheon, home of the country’s largest international airport called Songdo International City, so called because of the ‘ubiquitous’ data-gathering technology”.

In recent centuries, and from 70’s by Michael Graves and his concept of Re-design cities, or even the city model of Corbusier and several authors as Paolo Portoghesi were big influences on urban design. Colin Rowe also has been present as another influential but more focused on the American’s city design. Léon Krier, Rodrigo Perez, Peter Eisenman, Daniel Libeskind and recently Norman Foster, are major influencers in these new concepts of Smart Cities.

Maria Teresa Bilotta expose on her article on December 22th of 2014 that Songdo is the first Smart City in the world. It is a sustainable city, **Green and full of technology and innovation.” Songdo is a city that contains a Central Park as a mark point, a semi imitation New York Central Park and with 10 years of development.** However, according Antony M. Townsend, in his Smart Cities book Songdo was originally conceived as «a weapon for fighting trade wars» the idea was «to entice multinationals to set up Asian operations at Songdo»... with lower taxes and less regulation...”. It is true that Songdo since its inception introduced the concept of a Free Economic Zone, an area with different regulation of the rest of the country, but it’s not working like was planned and it presents many different problems, but at the end it is trying to arrive to a green space more Korean than international.

2. METHOD

The first and new theory is based on logic with the concept and the implementation of Green Architecture and elements that create the Quality and Happiness inside cities and logic of Sustainable Urban and sustainable Energy applications. This initial question arises a sub - question to identify response that is characterized by knowing which the limit it has to be present on the sustainable design method to be used. On December 17th of 2014, the Guardian, by Steven Poole said, “...The truth about smart cities: ‘In the end, they will destroy democracy...” and further underlines also “...The smart city is, to many urban thinkers, just a buzz phrase that has outlived its usefulness: ‘the wrong idea pitched in the wrong way to the wrong people’. So why did that happen – and what’s coming in its place?...” This research is in direction of the improvement of these cities to be projected and built today, improving its existence, its sustainability and the type of intervention with a new systems. There are situations that are not identifiable, as Alain de Botton described Beautiful houses not only fail as guarantee of happiness, as can also be accused of failing to improve the character of those who live there...”, may not only be the image of buildings but can describe the development of a city. Nevertheless, Alain de Botton identifies a reality. **We have to ask what should be exactly the look of beautiful building ...” and this is a concept that goes in different scientific directions that has to be developed in another study case.**

Zygmunt Bauman, on his book Trust and Fear at the Cities says submit ourselves to the limits of our faculties: we know very well that we will never come to dominate completely the nature and our body also will never be immortal or also immune to the relentless course of time. Thus, we do not have, because another remedy that is not content with what exists. This is a finding that has no reason to discourage us or break the will to live, but rather should serve us encouragement and infuse us energy. While we cannot completely extirpate the pain, we can, in some cases, eliminate it in part and in others relieve it. The question is to know about it persist, again and again, without faint...” in cities opinions can be diverse and at the same time opposite as well.

These new Smart Cities provide ‘proxemics’ levels that are identified and can be supported by the planning. Proxemics studies the spatiality behaviour of man, the relationships between individuals in a spatial frame and between individuals or groups and the space itself... In the theoretical-methodological frame of ethology, there is a series of central concepts as space, spatiality, distance, contact, territoriality, aggressiveness and defence. The biggest part of conceptual tools of the discipline builds on **the fundamental ideas of space and distance.”** by Ciprian F. Ardelean in The Grammar of social space: An Anthropological approach to human Proxemics.

The third theory is focused in “Netizen” people, the concept of Net addiction As many as 10 per cent of Internet surfers are pathologically addicted to the Web, and although it can disrupt their lives, many doctors and mental health practitioners are unaware of the dangers, according to an article by psychiatrists at the Be’er Ya’acov Mental Health Centre and Tel Aviv University...”. This is a global problem that the planners have responsibility since the beginning of the projects. Excessive connection can be harmful to the human being when the objective is to be a helpful tool. The centralized waste treatment systems remove waste storage on the streets and reduce spending fuel expenses. Touch screens within the housing and the information energetic spent on mobile applications indicative of productivity and consumption alert inside homes, services and are productive but when this pass the proxemics level, “shut down” the real results.

The third concept theory is that inside a city need to exist an improvement of non-standard urban elements. As time goes by, people start looking for unique things, handmade, special places and mysterious places. WCCD the new international standard on city data, published in May 2014, create a database of indicators for City Services and Quality of life by the International Organization for Standardization (ISO). The ISO 37120 defines and established definition and methodologies for a set of indicators to steer and measure the performance of city services and quality of life in 17 different themes. This new data analysis could create a positive approach in some cities but could create a negative approach and give more emphasis to the Standard level.

2.1 Sample preparation

A list of questions and analysis at experts ideas connected with the Smart Cities State of Art create this new type evaluation to apply in existing cities and in Future Cities.



Figure 1: Songdo building at night Sharp I - transformed image by the author, Ana Oliveira

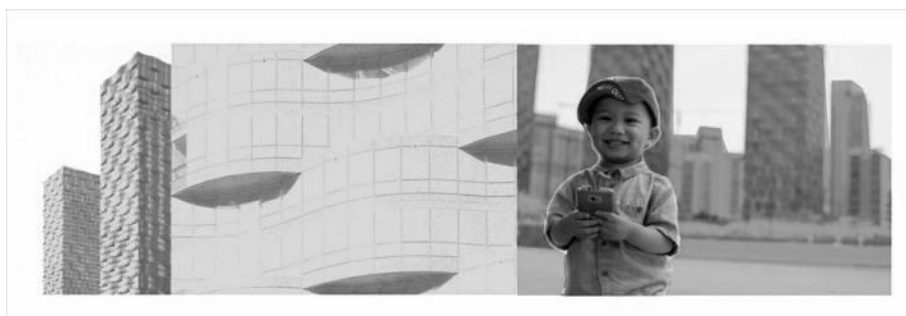

Figure 2: Songdo building Sharp I - transformed image by the author, Ana Oliveira

A daily analysis was developed during two years and a questionnaire was integrant part of this study complemented by a direct focus at the territory.

2.2 Experimental procedure

This idea was based on interviews on experts, where were identified needs on Smart Cities and the influences of the technology on Smart Cities. Experts: CIKUTOVIC, Marco - AES Gener, Engineering Manager – Chile; DIAS, Solemain - Chadwick International School - support Director, Brazil, DUMELIE, Geoff - Chadwick International School - Village School Counselor – Canada; HAN, Jisop - Opus Design and KPF - Director design – South Korea; JACKSON, Emma - Metroland Media Group - Canada; KIM, May - Collins International - Real State advisor – Korea; MORE, David G. - Gale International - Project Manager – England; Polycarp, Clifford - Green Climate Found - Director Manager – India, helped to create this analysis. Different ways of knowing the city and different ways of living the city were identified.

In general, everyone accept that the results from the Data are very important, but the extreme of not giving space for Nature, off line status or shut down options are inside the needs of the population. Green was the selected colour to implement on Equipment's, Green is a Sustainable colour in all opinions.

An orientation basis on the demonstration of how architecture on city's can be changed according to the real importance and action in which the Green Architecture can produce big results in our days was another conclusion. People need a connection between life and real Nature. For a sustainable intervention, and a sustain-able business this level of thought is an integrant part of the Project Plan Implementation.

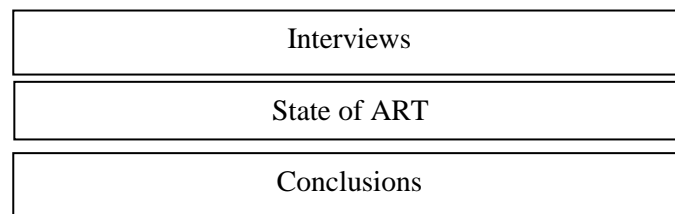

Figure 3: Flowchart illustrating the sample process.

2.3 Results and discussions

As a base on good results, all inhabitants need to be informed and guided to produce results from the initial planning of interventions inside Smart Cities. The solutions pass on improvements on the communication with universal language because cities are not static they are Organic. People expect that cities focus on Quality and not turn into ghost towns. All this concepts with Green Architecture can be applied in Old Cities without the needing a total demolishment.

For choosing a new technology implementation it's important to know how people live and how people relate to cities. Jan Gehl explain "... Cities are the places where people meet to exchange ideas, trade, or simply relax and enjoy Themselves ... The compact city - with development grouped around public transport, walking, and cycling - is the only environmentally sustainable form of city... the city must Increase the quantity and quality of well-planned beautiful spaces are human in scale, sustainable, healthy, safe, and lively ... Cities ... They provide the structure that Enables cities to come to life, and to Encourage and accommodate diverse Activities, from the quiet and contemplative to the noisy and busy. The human city ... Creates pleasure for visitors and passers-by, as well as for those **who live, work, and play there every day** ... "Jan says: "**We shape cities, And They shape us** ... " At the end, technologies are used for creating more quality on the way of living, if we create the opposite we are not arriving to the objectives. Symbols in **a city are an automatic human reaction...**" Jan Gehl also notes the following walking, stopping, resting, staying and conversing. Unpredictability and un-planned, spontaneous actions are very much part of what makes moving and staying in city space such a **special attraction.**"



Figure 4: Home Touch Panel – South Korea – Songdo – by the author Ana Oliveira



Figure 5: Home Touch Panel – South Korea – Songdo - by the author Ana Oliveira

What is inside the buildings in the interior or in the exterior spaces produces influence on human beings. The architect Peter Zumthor also transmits in his book Atmospheres. I enter the building see the room and - in the fraction of a second - have this feeling about it. We have perceive atmosphere through our emotional sensibility - a form of perception that works incredibly and Which We humans evidently need to help us survive ... I have no idea why that is so, but it's like that with architecture too ...".

Population, cities, governments, companies will benefit with this new concept of planning and using the city with more quality, more health and more happiness. Could Happiness be measured by data results? In the future we will have this answer and this new theory will help in some results.

3. CONCLUSIONS

All of the Smart Cities are not following the original sustainable spaces concepts, it is important to change that. To transform and create a Sustainable City, the amount of money needed pass the Private Sector level and demand the Government intervention. A project like this, will work only with a strong Community involvement and it has to be very productive. All Smart Cities have to improve and to maintain inhabitants, because only with this focus, the space will be prepared to make and produce results to create mechanism with new technologies or ether to transform Spaces into Sustainable and autonomous areas. The importance of the proxemics, the limits of **communication, the constant "ALWAYS ON LINE" status and the search for non-standard urban elements** are problems to solve on the next ten years.

REFERENCES

- [1] PURI, Anuj, What are smart cities?, The Hindu, [Accessed: 15-Aug-2015].
- [2] BIANCHI, Nina, What Makes a City 'Smart,' Anyway?, USA, sustainablecitiescollective, [Accessed: 11-Nov-2014].
- [3] **HAJDUK, Slawomira, The concept of a Smart City in urban management, Business, management and education, ISSO 2029-7491 / EISSN 2029-6169, 2016, 14(1): 34–49, [Accessed: 18-Oct-2011].**
- [4] MARSHALL, Colin, Welcome to Paju Book City, the Republic of Korean town inspired by Hay-on-Wye, The Guardian, [Accessed: 08-Jan-2015].
- [5] **BILOTTA, Maria Teresa, Songdo, South Korea: the world's first smart city - in pictures, The Guardian. M. T. B. in Songdo, [Accessed: 06-Jan-2015].**
- [6] TOWNSEND, A., Smart Cities, Big Data, Civic Hackers, and the quest for a new Utopia, USA: W. W. Norton & Company, 7 Oct 2013
- [7] **POOLE, Steven, The truth about smart cities: 'In the end, they will destroy democracy, The Guardian, 17 Dec 2014**
- [8] BOTTON, Alan, The Architecture of Happiness, 1 vols. D.Quixote, 2009.
- [9] BAUMAN,Z., Trust and Fear **at the Cities, Relógio D'Água Editores – translation Miguel Serras Pereira., 1 vols. Antropos, 2005.**
- [10] ARDELEAN, Ciprian F., The Grammar of Social Space: An Anthropological Approach to Human Proxemics, 2014
- [11] SCHIAVENZA, Matt, Enough With the Word 'Netizen', China, 25 Sep 2013
- [12] GEHL, Jan, Cities for People 1st ed., vol. 1, 1 vols. Washington, Covelo, London: Island Press, 2010.
- [13] ZUMTHOR,P., Atmospheres, 1 vols. BIRKHAUSER, 2006

Enhanced Engineering Services for Electrical & Mechanical System via Integrated Building Management System, Remote Monitoring Unit, and Geographic Information System

LEE Che-kit^a, Sammy YEUNG Sau-kuen^b, HU Jinshan^c, CHAN Kin-hong^d, FUNG Ka-yan^e

^a Electrical and Mechanical Services Department, Government of the HKSAR, Hong Kong SAR, cklee@emsd.gov.hk

^b Electrical and Mechanical Services Department, Government of the HKSAR, Hong Kong SAR, skyeung@emsd.gov.hk

^c Electrical and Mechanical Services Department, Government of the HKSAR, Hong Kong SAR, jshu@emsd.gov.hk

^d Electrical and Mechanical Services Department, Government of the HKSAR, Hong Kong SAR, chankh@emsd.gov.hk

^e Electrical and Mechanical Services Department, Government of the HKSAR, Hong Kong SAR, kyfung@emsd.gov.hk

ABSTRACT

The Electrical and Mechanical Services Department (EMSD) of the Government of the Hong Kong Special Administrative Region provides operation and maintenance engineering services for electrical and mechanical systems in various government venues and public transport infrastructures.

To enhance manpower utilization, optimize building services system performance, and to achieve greater energy saving, various building management systems (BMS) of government venues are being integrated and connected to a Geographic Information System (GIS) platform, which will map all the critical assets being operated and maintained by EMSD.

Critical traffic infrastructures such as traffic signal systems, footbridge lifts and escalators, ventilation and lighting systems in public transport interchanges, and submersible pumps in subways/underpasses will also be mapped onto the GIS via remote monitoring units (RMU). The integrated BMS/GIS/RMU platform enables real time detection of equipment fault and prompt alert to maintenance staff, and provides a user-friendly geographical interface to facilitate quick deployment of technical workforce.

This paper gives an overview of the use of the integrated BMS/RMU/GIS platform which helps reduced fault response time and fault rectification time, achieve energy saving, and improve reliability of critical transport infrastructure for the benefits of the general public.

Keywords: integrated building management system, geographic information system, green building management

1. INTRODUCTION

Hong Kong is a densely populated cosmopolitan city with the urbanized areas covering less than 30% of this small city of 1,100 square kilometre. The city is characterized by sophisticated infrastructure systems and tall buildings, both of which rely on reliable operation of modern electrical and mechanical (E&M) systems. The Electrical and Mechanical Services Department (EMSD) of the Government of the Hong Kong Special Administrative Region provides operation and maintenance engineering services for E&M systems in various government venues and public transport infrastructures.

2. OPERATION AND MAINTENANCE OF E&M SYSTEMS IN GOVERNMENT VENUES

Building management system (BMS) is widely used in modern buildings to control and monitor the E&M systems such as air-conditioning systems, mechanical ventilation systems, lighting systems, security systems, lifts and escalators, etc. BMS substantially improves the efficiency of building management and reduces the operation and maintenance cost as it provides an easy way to assess the performance of the various systems, simplifies the operation, helps in planning operation and saves energy via more accurate control and operation schedule.

Though BMSs are providing a lot of benefits, they are scattered in a variety of buildings. For property maintenance agents who maintain a large number of buildings, monitoring such scattered BMSs is still time and manpower consuming, as a resident maintenance team is required for each building or the team needs to travel between buildings to operate and maintain the BMSs. On the other hand, continuous monitoring of the E&M systems is usually only possible at the consoles of the BMSs usually located in the control rooms of the buildings. Alarms identified by BMSs have to reach the management staff and repair teams via some reporting mechanism. For

maintenance agents with a large portfolio of buildings, this may cause delay in responding to alarms occurring concurrently in different buildings.

EMSD is maintaining a large number of government buildings which are widely distributed all over Hong Kong. Many of these buildings are equipped with BMSs. The work load to cater for BMSs in these buildings is quite heavy. As an example, the headquarters of a government department consist of a cluster of four buildings, each with their own BMS. Consoles of the BMSs are located in BMS rooms of the four buildings. The maintenance staff, particularly those on night shift, have to travel between buildings which is manpower consuming and very often the response to alarms is not as prompt as desired.

2.1. Integrated Building Management System (iBMS)

In view of this, EMSD developed an integrated BMS (iBMS) in order to enhance the efficiency and performance of operation and maintenance work and to relieve staff work load. The iBMS enables control and monitoring of the E&M systems of the four buildings within the headquarters complex via a single platform using either computer, tablet, smart phone at any location by operators with proper authority.

The major challenge to the integration was to exchange massive real time data of commands and system status between the central iBMS and the BMSs smoothly. To address this issue, optic fibre network was installed to connect the iBMS with the four BMSs. The second issue to be solved was that the four BMSs were using different protocols. Thus, a BMS upgrading work was conducted. BACNet communication modules were installed so that all the BMSs will work with the same protocol. As BACNet is an open protocol, it enables future integration of other systems. With optic fibre and the open protocol of BACNet, an iBMS server was installed and the connection with the BMSs were established in 2015.

All the E&M equipment including air-conditioning system, mechanical ventilation system, lighting control system, electrical system, lift system, emergency generator, etc. can be monitored and controlled via the console of the iBMS. Energy consumption of the systems is also monitored and recorded. In addition to the integration, the iBMS also provides web based access. With proper authority, operation and maintenance staff can use the iBMS anywhere with Internet access. Management staff and repair team can also monitor the system to obtain information of system performance and alarms directly. Furthermore, as a further step towards a smart city, the iBMS is integrated with a GIS platform installed in the headquarters of EMSD for map-based asset management. System status and alarms are visualized on the GIS platform. Management staff can get an in-depth understanding on the system performance which enables prompt and accurate decision making. The system architecture diagram is shown in figure 1.

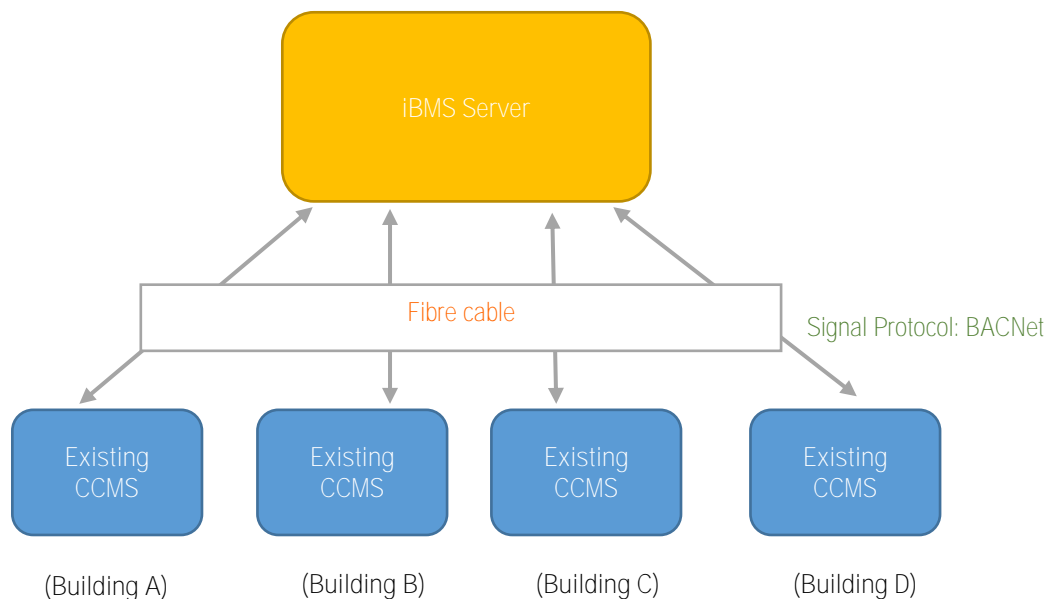

Figure 1: System architecture of the integrated BMS (iBMS)

Since the implementation of the iBMS, the operation and maintenance work has become more effective. As the control and monitoring of the E&M equipment can be carried out through one central console, the maintenance team does not need to travel between buildings. Manpower is saved and staff can carry out maintenance work more efficiently and effectively. Operation and control of E&M systems of the four buildings become easier as these can now be done using the same interface.

The iBMS also enables a faster response to equipment faults and even allows pre-diagnosis to be carried out. By setting the auto escalation mechanism, alarms can be sent directly to management staff and repair team whenever they are triggered. Alarms will be shown in iBMS, the GIS and alarming SMS will be sent to mobile phones of the maintenance staff. Reporting time is saved. As the iBMS can be accessed anywhere, the repair team can check the system status and conduct a pre-diagnosis. Proper manpower, parts and tools can be well prepared which significantly enhance the efficiency of repair work.

iBMS also helps in energy saving. With the iBMS, energy consumption is monitored and recorded continuously. The trend analysis provides data-driven insight to optimize E&M system operation. On the other hand, the energy consumption data also helps identify abnormal energy consumption pattern due to equipment failure, e.g., a faulty control valve which cannot be properly closed wastes energy and causes overcooling.

The remote monitoring provided by the iBMS also helps in maintenance management. With the understanding of the system status and load, management can suitably mobilize maintenance workforce and prioritize the work.

3. OPERATION AND MAINTENANCE OF PUBLIC TRANSPORT INFRASTRUCTURE

Over 90% of Hong Kong's 7.3 million population use public transport regularly. Every day, over 12.6 million passenger journeys are made on the public transport systems which include railways, buses, minibuses, trams taxis and ferries. The efficient mobility provided by the public transport systems, and also to the users of around half a million of private cars, depend on a well-developed and properly maintained transport infrastructure and its associated road side facilities, enabling people in Hong Kong to move around and reach their destinations easily, quickly and safely despite its high density.

3.1. Traffic signal control system

A central traffic signal control system covering over 1,800 signalized junctions is operating round the clock throughout the year for the allocation of the right-of-ways properly at road junctions for safe movement of vehicles and pedestrians.

The planning, upgrading and replacement of all traffic signal systems are initiated and undertaken by the Transport Department of Government of the Hong Kong Special Administrative Region, whilst EMSD looks after their maintenance.

Apart from equipment aging and system expansion, traffic signal systems and associated equipment distributed throughout the roads of Hong Kong are exposed to all kinds of weather phenomena – from the dry, cool winters to the wet and hot summers, from tropical cyclones to torrential rain and thunderstorms. They are also prone to direct damage by traffic accidents. Underground cables are sometimes damaged by road excavation works. With a view to improving the reliability and performance of the equipment, which is of paramount importance in ensuring road safety, EMSD started to implement in 2013 an asset management system, and has subsequently accredited under the ISO 55000 series of international standards in 2014. Under the ISO 55001 asset management system, critical analysis of past failures/complaint cases and associated risk analysis were performed. The maintenance team identified and implemented a number of improvement measures, including the implementation of a two-tier monitoring system to ensure timely feedback of repair status to complainants, enhancement of fault data collection and analysis, taking immediate action to investigate repeated junction controller failures, etc.

3.2. Geographic information system

As there are a huge number of traffic signal assets distributed over the territory of Hong Kong, a geographic information system (GIS) platform was developed for better management of the asset information. All asset information of traffic signal system was converted into a manageable database. A live monitoring feature with three condition levels was developed for indicating the equipment status. The integration of the asset databases

with GIS has greatly improved the user-friendliness and life cycle maintenance of the asset management system, enabled faster response to equipment failure and enhanced the effectiveness in maintenance management and replacement planning of these assets.

3.3. Remote Monitoring Unit (RMU) for transport infrastructures

Upon the successful use of GIS for asset management of traffic signal system, EMSD has extended the GIS-AM protocol to other transport infrastructures under her maintenance. Unlike traffic signal system, most of these infrastructure systems are operating in standalone mode without any remote monitoring tools. To acquire the desired information from the remote facilities, we have adopted wireless solution as mobile network technology is very mature nowadays.

EMSD has developed a remote monitoring unit based on customized System-on-Chip (SoC) module with mobile network module integrated to enable mobile transmission of the equipment operation data. The RMU has different interface ports for various monitoring purposes, and can monitor on/off status and measure analogue signal. The measured signal is digitized for transmission to the server via mobile network.

The RMU is now applied to transport infrastructures including footbridge lifts and escalators, ventilation systems at public transport interchanges, and submersible pumps in subways and underpasses.

4. INTEGRATION OF iBMS/RMU/GIS

Live equipment status from iBMS and remote conditions of transport infrastructures are now integrated under a single GIS platform, as shown in figure 2. Different types of systems or infrastructures are displayed in different layers of the GIS. Staff responsible for different systems can select individual layers of interest, while management staff or staff in the fault call centre can select multiple layers for territory-wide overview of the infrastructure conditions.

The integrated iBMS/RMU/GIS platform enables real time monitoring of system healthiness, and sends early warning of equipment fault to maintenance staff. This integrated platform also provides a user-friendly geographical interface to facilitate quick deployment of technical workforce to resolve problems. All these help reduce the fault response time and fault rectification time and improve the reliability of critical infrastructure systems. Furthermore, the integrated platform also facilitates optimization in energy usage in building and infrastructure systems.

Graphical Display of Geographical Information System (GIS) of
Transport Infrastructures and Government Buildings



Architecture of Geographical Information System (GIS)

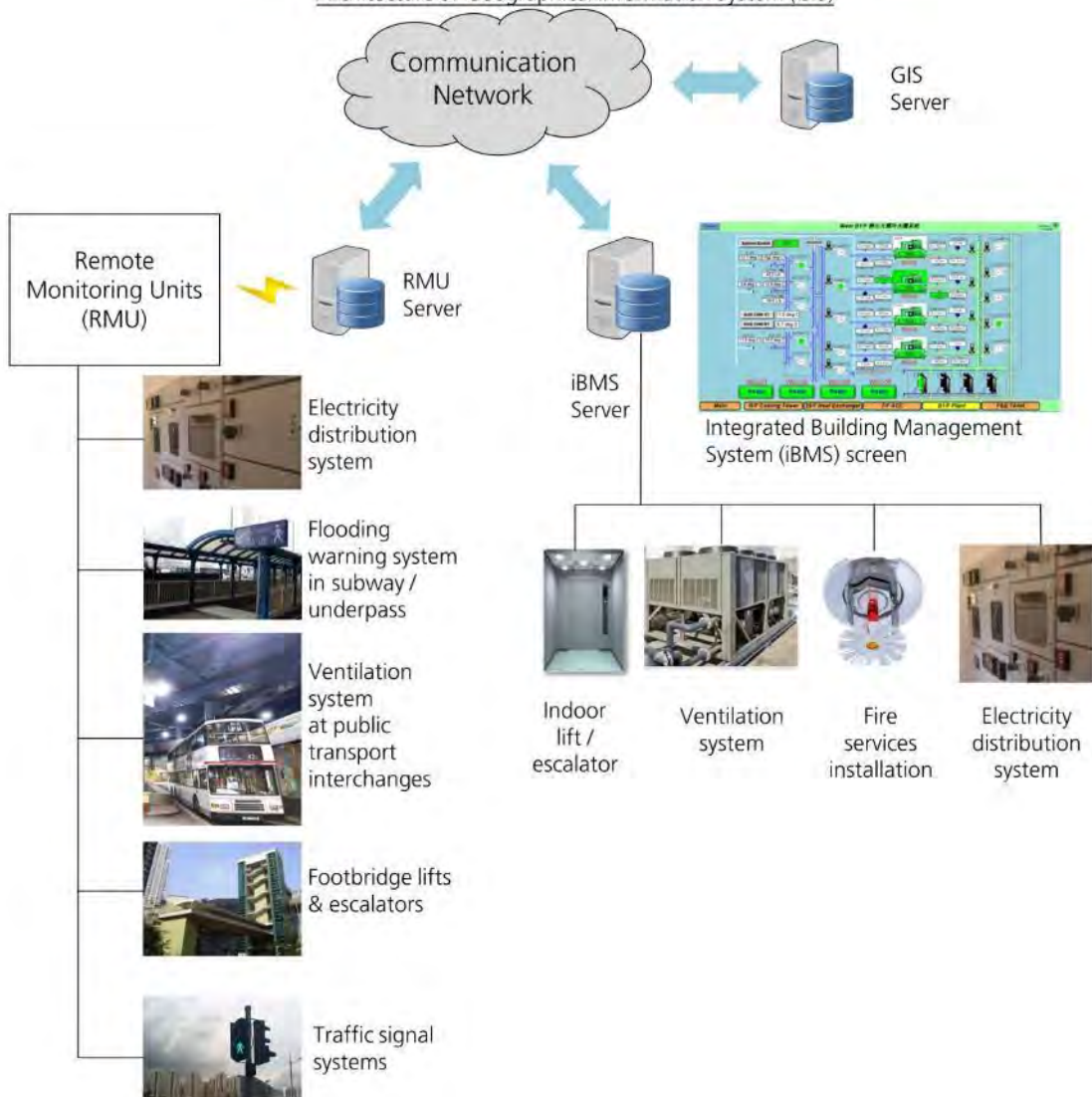

Figure 2: Integration of iBMS, RMU and GIS

5. CONCLUSION

As a positive step in transforming Hong Kong towards a smart city, EMSD has built an integrated iBMS/RMU/GIS which enables easy visualization of the real-time status of a wide range of E&M systems distributed around Hong Kong; provides critical information to facilitate decision making and quick deployment of suitable workforce and support to resolve problems; as well as facilitates optimization in energy usage in buildings and infrastructure systems.

REFERENCES

- [1] Transport Department, Hong Kong, (2015). Annual Transport Digest 2015. Hong Kong.

Decarbonising the City: Micro Energy Grids

Richard WANG^a, Derek CHAN^b, Vincent CHENG^c

^a Arup, Hong Kong SAR, richard.wang@arup.com

^b Arup, Hong Kong SAR, derek.chan@arup.com

^c Arup, Hong Kong SAR, vincent.cheng@arup.com

ABSTRACT

With the prevailing global challenges facing energy providers to provide secure, affordable, profitable, resilient and sustainable forms of energy a trend towards finding the optimum solution is developing.

In response to these challenges the concept of Microgrids supplied by distributed energy resources has seen steady increase in research and development funding, technological advances and real world adoption. With this trend towards the adoption of Microgrids for distributing power there also exists the opportunity to harness the energy cascade principle to provide co and tri-generation, providing Heating and Cooling in a district configuration to provide a Micro Energy Grid (MEG). When controlled as a single entity with real time feedback and control to respond to the local consumption, large savings in carbon emission associated with the generation of energy are possible alongside reductions in peak energy demand leading to reduced reliance on centralized energy generation.

This paper sets forth the opportunities and barriers for implementation through technical, regulatory and business case analysis of large scale, smart distributed energy resources drawing on experience from large scale projects across Asia

Keywords: smart micropower generation, distributed energy system, decarbonisation

1. INTRODUCTION

Carbon dioxide emission is widely recognized as the major contributor to global climate change. Whenever fossil fuel such as gas, coal, oil are burnt, carbon together with other greenhouse gases are released into the atmosphere creating a cascading effect leading to climate change.

Climate change has progressed rapidly with the urbanization of the developed countries since a city is major contributor of carbon emissions such that urban activities constitutes over 80% of anthropogenic carbon dioxide emissions produced globally each year due to the enormous consumption of energy resources (While & Whitehead, 2013).

Recently steps have been taken to 'decarbonise' the supply of electricity, that is in essence to reduce the amount of carbon produced for each Kilowatt-hour (kWh) of electricity produced. Moves towards renewable energy sources, natural gas and nuclear energy away from cheap and polluting coal are being undertaken globally.

At the recent Conference of **Parties 21 held in Paris ('COP 21')** over 190 nations put forward their commitment to reducing carbon emissions with the stated goal of limiting global temperature rise to less than 2 degree. Amongst these China has committed to a reduction in energy intensity (as a unit of Gross Domestic Product (GDP)) of 15% whilst the carbon intensity reduction target announced in the 13th 5 year plan calls for an 18% reduction, thusly it can be concluded that the 3% gap will be made up primarily of a growth in renewable (and nuclear) energy sources.

Naturally, as China moves towards a service economy with a continued targeted GDP growth of 6.5-7%, away from the previous manufacturing led growth engine a reduction in energy intensity is foreseeable. However, alongside the issue of carbon emissions is a further pressing concern, namely the current environmental challenges of air, water and soil pollution. Air pollution in particular presents a challenge which can be directly correlated to the generation of electricity. A recent study by Greenpeace found coal fired power plants to be responsible for over 250,000 premature deaths in in 2011 (Greenpeace, 2013) alone.

A further factor influencing development of the energy business in China is the increased rate of urbanisation, such that 53% of Chinese citizens lived in urban areas in 2013, compared to 22% 30 years earlier (Climate Nexus, 2015). It is expected that 68.6 % of china's estimated population will live in urban areas by 2050, causing the

development of new cities with an expected 221 new cities by 2020 (Worlds Resource Institute). Increasing population and new cities development calls for the idea of sustainable urban development. **China's** National Development Reform Commission (NDRC) announced a National Pilot Program on Low-Carbon Provinces and Cities. In addition to these pilot regions, many other cities, such as Qingdao, Wuxi and Suzhou have also undertaken a variety of approaches to building low carbon cities.

As a response to the need to develop a low-carbon, less polluting solution for the provision of energy against the backdrop of growing urbanisation and the emergence of new technologies, ours is a world moving towards a smarter (in the technological sense) society, driven by real time information and decisions made based upon data and information gathered from interactions. With these drivers, there exists the opportunity to revisit our thinking on how we provide and use energy in our cities, one such approach is the application of Micro Energy Grids.

For this study a community expected to be developed in China was selected. Buildings in the community were categorized in terms of functions and annual demands were computed for individual building types. Sustainable energy supply strategies were selected to form a micro energy grid for the community. Cost-effectiveness study was performed by varying the system capacity, development size and discount rate and subsidies. This study is based in the China, but the community micro energy grid model is generic enough to be applicable to other countries.

2. DEFINING A MICRO ENERGY GRID

A microgrid is defined as development or district scale distribution system containing distributed electricity generation (DG) and loads, which is controlled to balance supply and demand within the microgrid, the operation of which can be separated totally from the main distribution systems (i.e. the utility grid) or connected to it. A Micro Energy Grid (MEG) is where the concept of an electrical microgrid are expanded to further capture the improvements in efficiency through the harnessing the by-products of generation (namely heat) to produce cooling and heating for distribution to the district.

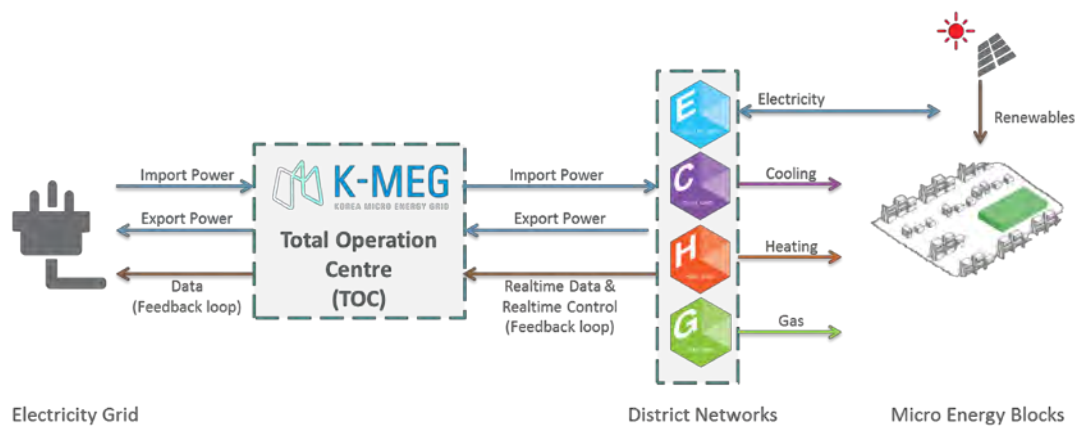

Figure 1: Micro energy grid (MEG) concept schematic

3. BENEFITS OF A MICRO ENERGY GRID

There are a number of benefits realized through the development of MEG:

- Improved efficiency against traditional power supply: The process of generating electricity in a thermal power plant generates large amounts of waste heat. In a typical power plant this heat is rejected to the atmosphere via cooling towers or via the use of sea water. Further, large centralised thermal power plants tend to be located away from urban centres (and therefore the main loads) due to impacts on local air quality, this leads to large transmission networks across which electricity is lost. Given these limitations, a typical utility grid supply only delivers around 40% efficiency for each unit of fuel input. Through locating DG sources within a development, making use of cleaner fuels to reduce air quality issues **and the 'energy cascade' principle whereby waste heat from the process of electricity generation is utilised**, the overall system efficiency can be increased to upwards of 80%, a sizable improvement over the traditional approach. A further consideration is the ability to reduce water stress, as water used to remove

heat from the steam cycle can be harnesssed and reused within the MEG for space heating or heating of hot water for domestic or industrial use.

Depending on the types of building to be sited in a particular development, there exists the opportunity with MEG to share resources, for example utilising roofs of residential buildings to site PV panels which feed into the grid and power office buildings. This sharing of resources, coupled with control of the supply infrastructure allows the optimisation of operations.

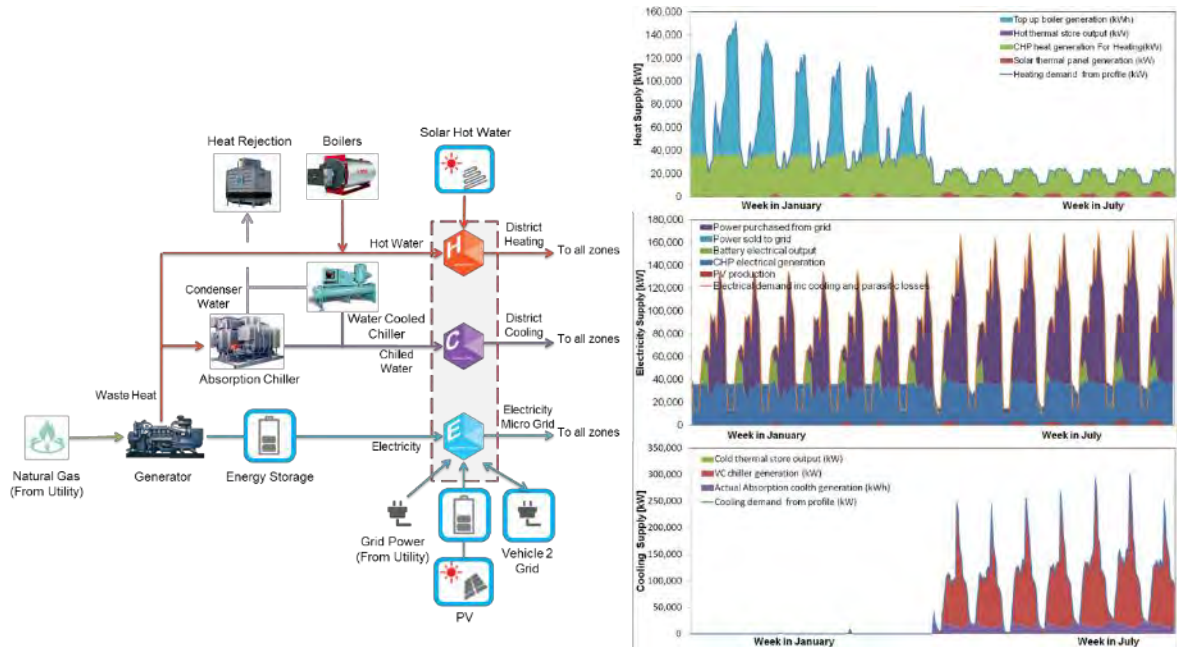

Figure 2: Typical MEG system schematic showing energy cascade (l), Flows of energy in a reference project during peak winter and peak summer weeks (r)

- Reduced installed utility capacity: Each building within a development will have a distinct operating schedule, for example when combining the schedules of a hotel and office it is fair to assume that whilst one is occupied, the other shall be less so. This variance in scheduling is reflected in the energy demands of each building type. When considering multiple building types as a combined entity, as is the case with a MEG, the concurrent demands of each space total less than the combined peak demand of each. By sizing the required equipment to serve the district based upon these concurrent loads, the amount of plant, distribution etc. to be installed can be significantly reduced.

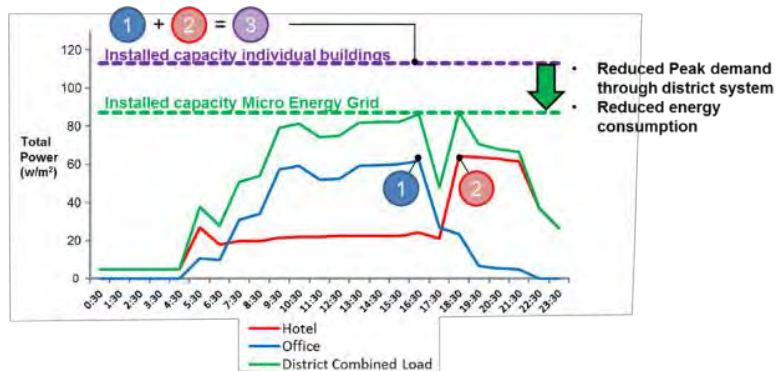

Figure 3: Reduction in installed utility capacity

- Support distributed energy including waste-to-energy, industrial process etc.: When planning district developments there are a number of infrastructure elements which must be considered, including how to deal with waste (organic, inorganic, sewage etc.) and in certain cases whether industrial type buildings will be provided. Where these elements are to be provided the MEG concept offers benefits. The benefit is derived from generating energy from waste, for example Anaerobic Digestion of organic waste to produce

Biogas which can be used for electricity generation, thus increasing the ability of the MEG to be self-sufficient.

- Enables demand response: Demand response (DR) is the ability to control the loads, or demand for energy from an end source to reduce the total amount required at a given time. The concept of DR is one which although possible with a centralised, traditional system is trickier as it involves the retrofitting of Smart meters and the means to control end uses. The process becomes easier to install and importantly to manage on smaller scales, where control over loads and the ability to respond to changes in demand is faster given the smaller distribution network and lag times on signals and response.
- Embraces the smart city, empowering users: A core principle of the MEG approach is the use of real time data to inform the operation of the system and to provide detailed information to end users. An important aspect of the Smart city is educating users through information, allowing them to better understand their behaviour (in this instance, their consumption) and providing them with options and recommendations to adapt, potentially saving energy, carbon and money.
- Resiliency of supply: A key feature of a microgrid and by extension a MEG is the **ability to operate in 'Island' mode**. This would occur when the utility network is unavailable and the MEG would switch to being fully serviced by its own interconnected supplies. Referencing the ability to control the demand of the MEG, if required loads may be shed across the MEG to balance supply and demand. This feature comes in to its own when availability of the local utility supply is not guaranteed or in areas where natural disasters are liable to impact upon power supply.

4. CASE STUDY

The micro energy grid model was applied to a community in Qingdao, China to identify the benefits of the micro energy grid compared to the conventional energy supply model and to evaluate the business feasibility of the micro energy grid model. The community is composed of 18 zones and comprised of 76 separate building plots located in Shandong province, China. Each zone is designated as a distinct building type including residential, education, office, retail, healthcare, community and hotels. The total floor area of the community is 3.2 million m² to be constructed in 2 phases. Based on the study of the energy and carbon emissions related regulations, three KPIs **were identified and targets were set to align with the national and local government's overall target; 1) Energy consumption reduction of 25%; 2) Carbon emission reduction of 26%; 3) Renewable Energy Generation of 2%.**

4.1 Technical analysis and carbon emissions savings

Extensive energy modelling was performed to determine the demands of electricity, heating and cooling over the course of the year. To cater for these loads and meet these sustainability targets a new approach was sought, namely the development of the MEG concept. Numerous technologies were assessed against 6 key criteria, technical and environmental performance, commercial viability, occupant satisfaction, proven technology, space required, and applicability.

The selected technologies included the use of a 36MW natural gas fired tri-generation system which would provide base power, heating (in winter) and cooling (in summer) to the district. The tri-generation system would be **supplemented with 20 MW of batteries (for electrical storage), 5MW of distributed PV's and 6,700 m² of solar hot water panels**, in turn connected to the district networks. The renewables systems were designed to allow **sharing of resources across building types, for example power from PV's would be fed back to grid from residential blocks** during the day for use in commercial blocks. Figure 2 above shows the MEG system schematic and energy balance.

The combined carbon emission factor (including power from grid, natural gas and MEG generated) for the MEG system was calculated to be 0.64 kgCO₂/kWh, a 25.7% reduction when compared to traditional energy supplied from local utilities in Shandong Province.

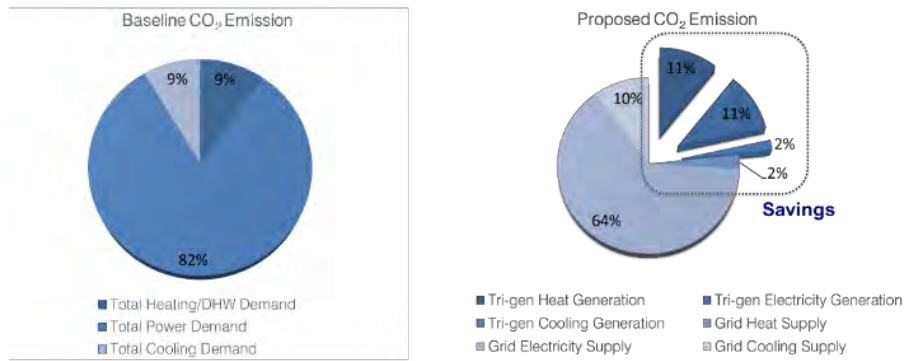

Figure 4: Carbon emissions savings for the project

4.2 Economic analysis – providing the business case

In order to review the business case of the MEG masterplan, lifecycle economic analysis was developed. This analysis takes into account the costs and revenues associated with the MEG including development, replacement, operation and maintenance and energy cost; set against, government subsidies (in the form of feed in tariffs or direct subsidy) tariff revenues which including avoided costs of not needing to install individual building level system equipment. The objective of the MEG to be a viable business relies on the basis that the end users shall not be paying an excessive cost for energy. As such, the basis of analysis was to maintain the tariff levels similar to existing utilities, however allowing for the avoided system costs as outlined above. Inflation and increase in fuel costs were both taken to reflect the China average of 3% for the purposes of analysis.

The economic analysis is performed considering three different aspects of factors impact: financial conditions, system capacity and development size. Financial conditions considered in this study are the government incentive and the investment discount rate of the project. The baseline discount rate used to calculate net present value (NPV) and payback time was 10% as this is a typical interest rate for large scale infrastructure development projects. A range of 3 ~ 15 % was used as part of a sensitivity analysis. To consider the impact of system sizing, three different tri-generation capacities and three different battery sizes were simulated in the micro energy grid model. In summary, the simulation was carried out for multiple combinations of each parameter shown in Table 1.

Scenario	Discount Rate [%]	Government Subsidy [cents/kWh]	NPV [US million \$]	IRR [%]	Discounted Payback [Yrs]
Scenario 1.1	3%	0.0	1082.96	10.4	16
Scenario 2.1	5%	0.0	445.28	10.4	18
Scenario 3.1	7%	0.0	173.07	10.4	23
Baseline case: Scenario 4.1	10%	0.0	10.66	10.4	51
Scenario 5.1	12%	0.0	-34.98	10.4	>60
Scenario 6.1	15%	0.0	-68.17	10.4	>60
Scenario 1.2	3%	3.7(0.25)	1291.45	12.3	13
Scenario 2.2	5%	3.7(0.25)	579.65	12.3	14
Scenario 3.2	7%	3.7(0.25)	265.90	12.3	16
Scenario 4.2	10%	3.7(0.25)	69.50	12.3	22
Scenario 5.2	12%	3.7(0.25)	10.63	12.3	38
Scenario 6.2	15%	3.7(0.25)	-35.34	12.3	>60
Scenario 1.3	3%	5.2(0.35)	1374.85	13.4	12
Scenario 2.3	5%	5.2(0.35)	633.40	13.4	13
Scenario 3.3	7%	5.2(0.35)	303.04	13.4	15
Scenario 4.3	10%	5.2(0.35)	93.04	13.4	18
Scenario 5.3	12%	5.2(0.35)	28.87	13.4	24
Scenario 6.3	15%	5.2(0.35)	-22.21	13.4	>60

Table 1: Economic sensitivity analysis

The results of the economic analysis showed that the project could satisfy the clients' requirements for a feasible project and as such could be further developed.

5. IMPLEMENTATION CHALLENGES FACED

Throughout the development of MEG projects, a number of challenges have been faced. In particular the allowable scale of distributed energy was encountered as a potential roadblock, with local codes and requirements of State Grid limiting on-site power generation to 6 MW, which would in many cases directly impact the viability of deploying a MEG as generating capacity is capped. To overcome this limitation close negotiation is needed with State Grid (or local electrical grid provider), for which the support of the project sponsor is key.

A further challenge faced is the uncertainty of subsidies and feed in tariffs provided by national, provincial and local governments. For the project to be economically viable an element of Government support is required, as with any nascent technology. Securing agreement and long term commitment to rates is something which must be considered and negotiated on a project basis.

6. CONCLUSION

The following conclusions are made for this study.

- The micro energy grid for a community is very effective on reducing peak energy demand and carbon emissions by optimizing energy supply to meet the energy demand in real time. The micro energy grid is financially feasible with the combined use of a tri-generation system, energy storage, and renewable energy sources applying demand response strategy.
- The sizing of the tri-generation and energy storage plays an important role in the micro energy grid concept, since the majority of the energy and carbon savings and revenue are generated from the tri-generation. The operation mode of tri-generation shall be determined considering the size and stability of base load as well as load types to maximize its energy efficiency and carbon reductions.
- Demand response is an effective means for the peak shift in the micro energy grid which reduces power generation and optimizes power balance. The size of demand response is determined by the load profiles of peak to base load ratio and energy storage capacity.
- The discount rate and government subsidy are the key factors affecting the financial feasibility of the community micro energy grid since they affect the operation cost and revenues. For the micro energy grid in China to be financially viable, the government subsidy is a necessity. Therefore, negotiation of tariff of purchased power and maintenance cost of utility network are important for the successful implementation of the community MEG.

REFERENCES

- [1] Climate Nexus (2015). China's Climate and Energy policy [Online]. Available at <http://climatenexus.org/learn/international-actions/chinas-climate-and-energy-policy>
- [2] Greenpeace (2013). Health Impact of China's Coal Plants [Online]. Available at <http://energydesk.greenpeace.org/2013/12/12/map-health-impact-chinas-coal-plants/>
- [3] While, A. and Whitehead, M. (2013). Cities, Urbanisation and Climate Change. Urban Studies, 50(7), 1325-1331.
- [4] World Resources Institute. Major Chinese City Plans Future around Low Carbon Development [Online]. Available at <http://www.wri.org/our-work/top-outcome/major-chinese-city-plans-future-around-low-carbon-development>

A Multi-Disciplinary Approach in Developing Sustainable Built Environment: A Case Study in Hong Kong Kowloon East Development Project (KEDP)

Schuman LAM^a, Edwin CHAN Hon-wan^b

^a The Hong Kong Polytechnic University, Hong Kong SAR, 14900559r@connect.polyu.hk

^b The Hong Kong Polytechnic University, Hong Kong SAR, bsdchan@polyu.edu.hk

ABSTRACT

This paper intends to illustrate the importance of integrating built environment, business environment and human environment for developing a sustainable neighbourhood where smart mobility, smart economy and smart living would be realized. Global concepts of Transit-Oriented-Development (TOD) and Smart City would be applied for **developing Hong Kong's Kowloon East District into a second central business district (CBD2) where an integrated live-work-play thriving domain will act as a complementary to the existing Central Business District (CBD) in Hong Kong Island.** Afterwards, a comparative study on Singapore Marina Bay Project is conducted to validate this multi-disciplinary approach. The Importance of TOD and virtual infrastructure in value-added of Hong Kong's local economy and culture will be mentioned. In this pursuit, economic growth plays an initiative agent for energizing social and environmental sustainability. This study aims to provide local decision makers including private, public and academic sectors an overview of a productive chain of collaboration among different operational sectors after assessing and discussing and studying the case, so that they will gain a better notion of the possible need for integrating different forces to reach a common goal benefiting to all the stakeholders.

In the community scale, the objective is to regenerate the old industrial district where new business, entertainment and international culture (food, youth and festival), entrepreneurship and sustainable built environment activate the development of this dynamic and prosperous district.

In the regional scale, due to Hong Kong's recent decline in world competitiveness ranking, the agenda of KEDP acts as a pilot test for transforming Hong Kong into a Smart Human E-City and for strengthening her competitiveness in the world at the same time.

In the global scale, as stated by the United Nation, global warming and rapid urbanization leading inequity in society which are the global city problems everyone is facing now and onwards. By adopting this recommended integrating **framework, it is going to create a new vision in Hong Kong's city planning practice to build an active and liveable environment for the locales to master a sense of belongings with the end goal for enhancing quality of urban life.**

Keywords: transit-oriented-development, smart neighbourhood, sustainable neighbourhood, quality of life, integration of urban system

1. INTRODUCTION

Hong Kong is an important trading and financial hub in the global economy. Thus, the current Hong Kong competitive economic model heavily relied on the four industries: finances, trading, logistics and tourism. Some have questioned the ability of Hong Kong to shift toward innovation and entrepreneurship from its current key industries. On the other hand, the rise of other world cities, and especially Singapore, have been threatening the competitiveness of Hong Kong in recent years. However, we firmly believe the development of the new East Kowloon District (CBD2) can offer a unique opportunity to enhance the attractiveness and competitiveness of **Hong Kong as "Asia's World City"**. The character of the CBD2 will be incorporated through the built environment, business environment and human environment in order to create a vibrant, dynamic and multi-functional district catalysed by these effective components: 1) TOD and information technology; 2) local-international economic growth; and 3) entrepreneurship and E-Youth culture. In such case, this CBD2 is going to provide a dynamic and fresh environment for local and non-local young at heart and global-minded people to foster creativity and entrepreneurship via physical (TOD) and virtual (ICT) connectivity and robust economic activities. We stress on using the space smartly with an orientation towards social, economic and environmental sustainability.

Transit-oriented development (TOD) is defined as a high-density, mixed-use development within walking distance (a 1/2 mile) of a transit station. TOD provides a range of benefits including increased transit ridership, reduced regional congestion and pollution, and healthier, more walkable neighbourhoods where economic and social capital would be flourished also. Therefore, in this paper, Mass Transit Rail (MTR) stations of Kwun Tong, Ngau Tau Kok, Kowloon Bay and Kai Tak are the transit stations regenerated, invigorated, connected and sustained by this multi-disciplinary environment. Whereas, virtual connectivity such as Information & Communication Technologies (ICT) is employed in various aspects of the city management and services delivery in order to connect and integrate those relevant systems effectively and smartly for enhancing quality of life in the context of social, economic and environmental sustainability. **In addition, the concept of smart city is being used. According to Boyd Cohen, "Smart City has six aspects: smart economy, smart mobility, smart environment, smart governance, smart people, and smart life. He also stated that a "smart city" is one that exploits technology and innovation to make efficient use of resources and reduce the size of the ecological footprint, and still a people-oriented city.**

2. CBD2 CONCEPT: INTEGRATION OF BUILT ENVIRONMENT, BUSINESS ENVIRONMENT AND HUMAN ENVIRONMENT

We propose a plan of dividing the East Kowloon District (former Kai Tak Airport: 320 hectares; Kwun Tong and Kowloon Bay: 168 hectares) into 5 function zones (Figure 1). They are 1) Low-Carbon Green Zone; 2) Industrial Heritage Rehabilitation Zone; 3) Modern Residential Commercial Zone; 4) Multipurpose Sports Centre; 5) Premium Tourist, Residential and Commercial Business Zone supporting by well-connected MTR transit nodes including Kowloon Bay, Ngau Tau Kok, Kai Tak and Kwun Tong, ride sharing services and walkable green foot bridges/green decks, universal accessible biking paths and sustainable green public open spaces. Here TOD is the major connectivity linking all the created function zones in order to harness their complement among each zone in the CBD2 and even to other CBDs in terms of cultural, social, economic and environmental performance. In the urban scale (Figure 2), local ferry route is added at Pier 1 to connect workforce from CBD2 to the CBD in central (HK Island). At Pier 2, new ferry route is added for connecting tourists and workforce to the CBD and shopping centres at Tsim Sha Tsui (Kowloon Island). For another serious consideration, along the promenade from Kwun Tong all the way to Tsim Sha Tsui, a walkable, bikeable and rideable (mini e-car) sustainable green lane is an effective activity-based sustainable development plan. For connecting Kowloon Bay (Low-carbon Green Zone) to the Kai Tak International Cruise Terminal (Premium Tourist Residential and Commercial Business Zone), a green deck (a hybrid of public open space and fly bridges) is built for pedestrians to enjoy a walking journey full of cultural exhibitions and creative street performance.

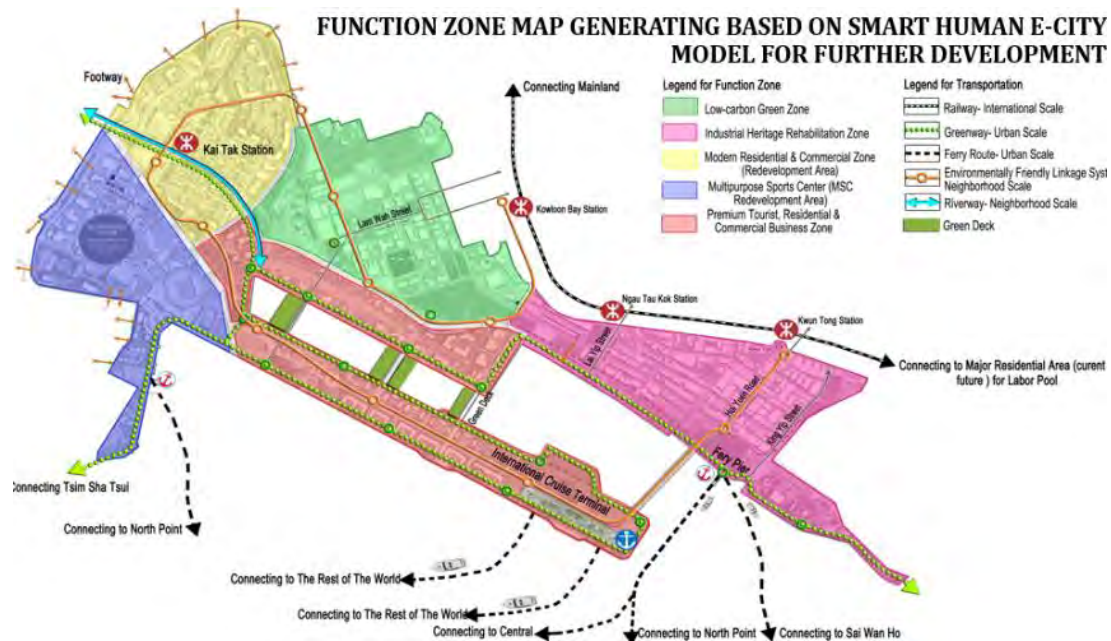



Figure 2

In the international scale (Figure 3), multiple cruise ship routes linking to the world by sea, MTR nodes linking to the inter-city-train to Mainland China all the way to Europe and South East Asia on land, and international airports nearby Hong Kong to the World by air.



Figure 3

At the same time, in order to achieve economic growth sustainably in the area and strengthen the competitiveness of Hong Kong's economy in the world vigorously, a dynamic and sustainable virtual infrastructure would be in formation where technology, information, knowledge, monetary and internet of things data can be accessible and shared easily so that this proposed function zones can interact and work with the world 24/7 and enhance the utmost capacity of the physical environment significantly and swiftly. With this efficient communication media

where value-added youth culture and international cultural accessibility will add fresh energy and diversity in nurturing sustainable human environment. At its best, smart mobility, smart economy and smart living would be reachable, and tourism and retail-wholesale-oriented economic activities would be fostered and robust in the CBD2 for the purpose of sustain its business environment.

3. CURRENT PREFERABLE CONDITIONS FOR THE CBD2

- Physical environment
 - Convenient connectivity in different scales: International scale, Urban scale and Neighborhood scale.
 - Wi-Fi infrastructure is well developed in HK with high speed.
 - Storage and manufacturing buildings provide vast space for building data center and facilitate international trade.
- Business environment
 - Free trade and investment policy
 - Well-implemented rule of law with strong enforced rules and regulations
 - Free capital inflow and outflow
 - Low taxation policy and a simple tax system
 - Well-functioning financial markets
 - Close proximity to markets in Asia
 - Gateway to mainland China for business
 - Labour market of highly-skilled workers
 - Well-developed infrastructures
 - Large pool of advanced producer services
 - International lifestyle and diversity
- Human environment
 - The studied area has a large portion of young people
 - Most of the residents are relatively well-educated
 - The distribution of the wealth is relatively equal

4. TIMELINE FOR IMPLEMENTATION

In light of the above preferable conditions, this CBD2 is loaded with many of the necessary factors to overcome its current disadvantages as an old industrial town. Whereas, the old industrial town outdated characters might be just the reason for revitalizing the out-dated industrial area and lies the opportunity for a prosperous future in the long run. Below is a timeline for illustrating how this multi-disciplinary approach is implemented (Figure 4).



Figure 4

5. COMPARATIVE STUDY: (SINGAPORE VS HONG KONG)

Items	Singapore New CBD 2030 (Marina Bay Development:360 hectare)	Hong Kong CBD2 2030 (Kowloon East Waterfront Development:488 hectare)
Historical Background	Singapore is a city-state, a British colony and then a state of Malaysia before its independence to become the Republic of Singapore in 1965. A prominent international financial centre and a port city lived by 74.1% Chinese, 13.4% Malay, 9.2% Indian and 3.3% others. With close tie to adjacent Malaysia and neighbour of Indonesia.	Hong Kong SAR is a special region of the People's Republic of China (PRC) , a British colony before its handover back to the PRC in 1997. A prominent international financial centre and a port city lived by 93.6% Chinese and 6.4% others. With close tie to adjacent PRC and neighbour of Guangdong cities of PRC (one country two system)
Population (Million)/ Area (2016)	5.6/ 719.2 square km	7.3/ 2,755 square km
Literacy Rate	96.8 (2015)	95.7 (2014)
Density	7,797/ square km	6,544/ square km
GDP at current market price (US\$ Million) GDP/ capita (2015)	\$402,457.9 \$72,711	\$307,300 \$42,100
Transportation	A TOD-Led City, transporting people by Land: MTR and BRT (Regional), by Air and by Sea (International).	A TOD-Led City, transporting people by Land: MTR and BRT (Regional), by Air and by Sea (International).
Project vision/ goal	Becoming a world winning global city with connectivity to the world. Creating a new iconic CBD (adjacent to the existing CBD), an international investment hub featuring tourism, state-of-the-art-infrastructure, parks and cultural venues, contemporary high-rise commercial towers.	Becoming a global city connecting to the world efficiently. Transforming Kowloon East into the CBD2 of Hong Kong to support economic growth and to strengthen global competitiveness.
Issues/ strength*	- old shipping ports with filthy open sewer. - resource-poor (natural and human). - land-scarce: by comparing to HK, more land has been developed which reflected on the density figure. * Efficient internet accessibility (internet users: 82.1/ 100 person; secure internet servers: 932/ 1 million persons; mobile subscriptions: 146 plans/ 100 persons.	- outdated built environment including the filthy open sewer and inefficient connectivity - old industrial-oriented business environment - low skill labour human environment needs to be upgraded to meet the challenge of the digital world. * plenty of natural and human supply from the cities of PRC. - land-scarce for development because 75% of the land are zoned for preservation (nature). * Efficient internet accessibility (internet users: 84.95/ 100person; secure internet servers: 905/ 1 million persons; mobile subscriptions: 229 plans/ 100 persons.
Function zone	Marina South: as the new CBD extension for office and some residential developments, a new lively and mixed-use residential district. Marina Centre (Marina Bay Sand) for commercial, tourism, retail malls, convention and cultural development. Marina East for residential use mostly. A true green, walkable and bikeable sustainable urban living	Area including Kwun Tong (old industrial area), Kai Tak (new development) and Kowloon Bay (commercial section): 1) Low-Carbon Green Zone; 2) Industrial Heritage Rehabilitation Zone; 3) Modern Residential Commercial Zone; 4) Multipurpose Sports Centre; 5) Premium Tourist, Residential and Commercial Business Zone
Performance	- Marina Bay Sand has become the major tourist point of interest and a new icon of Singapore. - in recent years, Singapore has gained more world recognition than Hong Kong - the ranking of quality of life organized by different world institutes positioned Singapore over Hong Kong.	- not available yet because this is only a proposed idea as a pilot test.

Table 1: Urban development project in Asia (case study for comparison)

6. EXECUTIVE SUMMARY

After examining the two new water-front development projects in Asia, one can easily find the similarity of the two: especially the goals of the development projects and their local constraints. They both use a multi-disciplinary approach to integrate their business environment, physical environment and human environment through sectioning the total development area into different function zones in order to achieve the project goals. The vision of the Marina Bay Development is an inclusive, highly liveable, economically vibrant and green home, with the six key focuses in housing, economy, recreation, identity, transport and public spaces, for all the Singaporeans. In this regard, the business environment, built environment and human environment are addressed. So far, **Singapore's Marina Centre has gained excellent review by those world organizations which shows Singapore's world ranking leaping over Hong Kong for the past years.** Frankly, the success of Marina Bay Sand Project at the Marina Centre sets as a valid justification for the multi-disciplinary function zone planning framework suggested in this paper. The CBD2 would become the sustainable community where entrepreneurs, small business enterprises (SME), the government and the value-added international culture would be fully developed to their utmost capacity. If **Hong Kong envisions to become the "Asia's World City" and continue to lead not only in economic and social** in Asia, but also culture, technology and environment, this notion of developing an integrated multi-function-zone will serve the trajectory for guaranteeing her world competitiveness in future.

REFERENCES

- [1] MITOD (2016). By Conducting the Plan MITOD Section of This Action Guide, Users Will. "Have You Taken Our Survey?" Welcome to the Mixed-Income Transit-Oriented Development National Action Guide. Accessed September 18, 2016. <http://www.mitod.org/>.
- [2] Martin Schipany (2016). Interview with climate strategist Boyd Cohen. And he saw that it was "smart" - Interview with climate strategist Boyd Cohen. Available at: <https://www.wien.gv.at/english/transportation-urbanplanning/interview-boyd-cohen.html> [Accessed September 29, 2016].
- [3] Department of Statistics, Singapore, <http://www.singstat.gov.sg/statistics/latest-data> [Accessed January 2, 2017]
- [4] Developing the Business and Financial District in Marina Bay, National University of Singapore, http://lkyspp.nus.edu.sg/wp-content/uploads/2016/05/Marina-Bay_case-study.pdf [Accessed January 2, 2017]
- [5] To make Singapore a great city to live, work and play, Urban Redevelopment Authority, Singapore Government, <https://www.uragov.sg/uol/master-plan/view-master-plan/master-plan-2014/Growth-Area/City-Centre/Marina-Bay-Marina-South> [Accessed January 2, 2017]
- [6] Census and Statistics Department, <http://www.censtatd.gov.hk/hkstat/sub/so150.jsp> [Accessed January 10, 2017]
- [7] Social Indicators of Hong Kong, <http://www.socialindicators.org.hk/en/node/62> [Accessed January 2, 2017]
- [8] HKTDC Research, <http://m.hktdc.com/business-news/article/Market-Environment/Economic-and-Trade-Information-on-Hong-Kong/etlhk/en/1/1X000000/1X09OVUL.htm> [Accessed January 10, 2017]
- [9] Vision (2016). Another Premier CBD of Hong Kong, 2016. Energizing Kowloon East. Available at: <http://www.ekeo.gov.hk/en/vision/vision/index.html> [Accessed September 30, 2016].
- [10] About EKEO, http://www.ekeo.gov.hk/en/green_map/building/index.html [Accessed September 30, 2016]
- [11] Future Ready Singapore, Singapore Government, <https://www.edb.gov.sg/content/edb/en/why-singapore/about-singapore/facts-and-rankings/rankings.html> [Accessed January 10, 2017]
- [12] Urban Planning Framework in Singapore, Singapore Government, http://eresources.nlb.gov.sg/infopedia/articles/SIP_1565_2009-09-09.html [Accessed January 10, 2017]

Sy(e)nergies Between Mega Event Buildings and The Surrounding Neighbourhoods

Simone MAGDOLEN^a

^a Munich University of Applied Sciences (MUAS), Germany, simone.magdolen@hm.edu

ABSTRACT

Hosting major sports events such as Olympic Games is an ambivalent topic in today's society. In the last years there have been several examples for a rejection by the residents for hosting such Games. Taking this into consideration the paper focusses on the role of the constructions for major sports events, stadia and arenas in particular. Despite the fact that the organizers of mega sport events are more and more under pressure to report on the sustainable performance of their venues, they indisputably have a high resource and energy demand and therefore high costs. At the same time the events lead to numerous successes for the construction sector of the host cities. Additionally, the venues are identity donors and have iconizing effects on the cities and specifically the immediate vicinity. The potential for benefits and sy(e)nergies with the surrounding neighbourhood is diverse but so far less exploited. Up to now, most stadia are isolated, individual buildings. In fact they offer an enormous potential for the use of renewable energy sources and could be both, energy provider and energy storage for the surrounding neighbourhood. Therefore, a case study analysis has been conducted to identify potentials in terms of urban planning and energy. Moreover the study involves an investigation about the ability to connect a stadium with the surrounding neighbourhood to benefit from sy(e)nergies.

Keywords: smart neighbourhood, green infrastructure, energy saving

1. INTRODUCTION

Hosting major sports events such as Olympic Games is an ambivalent topic in today's society. In the last years there have been many examples for a rejection by the residents for hosting the Games. The most recent example is the city of Hamburg where 51.6% voted against a bid for the 2024 Olympic Games in a referendum. It puts Hamburg in a growing line with European and American cities such as Oslo, Stockholm, Krakow, Canton of Grisons, Munich as well as Boston to shun an Olympic campaign [AFP, 2015; Eberts, 2015].

Taking this into consideration the paper focusses on the role of mega event buildings in the neighbourhood. Despite the fact that the organizers of mega events are more and more under pressure to report on the sustainable performance of the venues, they indisputably have a high resource and energy demand and therefore high costs. At the same time, the constructions in combination with mega events such as Olympic Games or Football Championships, lead to numerous successes for the construction sector of the host cities, such as the introduction and improvement of environmental laws and building standards in the field of energy efficiency and sustainability as well as the promotion of energy-efficient and ecological technologies in construction [Essig et al., 2012]. Additionally, the venues are identity donors and have iconizing effects on the cities, specifically on the immediate vicinity [Preuss, 2004].

Back to one of the examples for a rejection of the Games, the city of Hamburg: The highest percentage of rejection is in the immediate vicinity of the planned event locations. It came from the nearby residents in the centre of the city where most of the sports facilities should have been situated (see Figure 1). This can be ascribed to the **formally known "Not in my Backyard" (NIMBY) phenomenon, the opposition by residents to a proposal for a new development because it is close to them.**

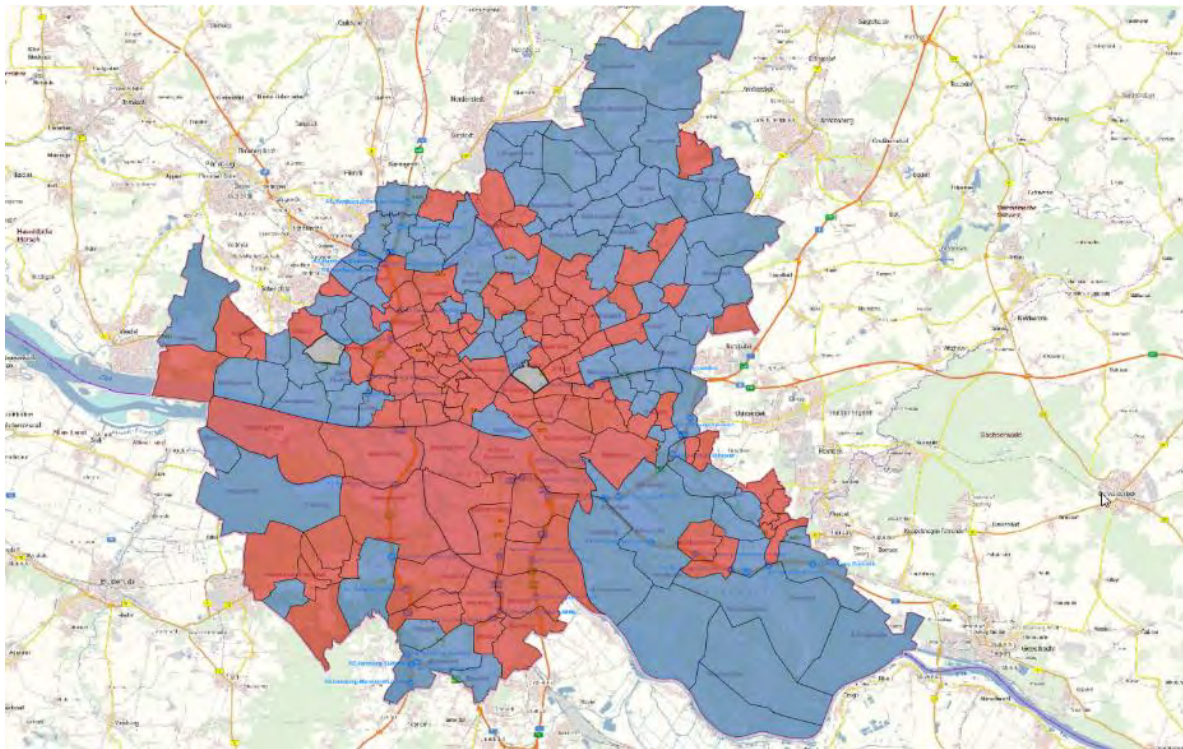

Figure 1: Result of the referendum on hosting the Olympic Games in Hamburg 2024 [Statistisches Amt für Hamburg und Schleswig-Holstein, 2015]

Consequently, the following questions arise: Is having a major sports arena in your neighbourhood so bad? What are the positive aspects and benefits for the surrounding neighbourhood and how can they be strengthened? Far too little attention has been paid to the potential for sy(e)nergies of a stadium with the surrounding neighbourhood which is diverse. Unfortunately up to now, most stadia are isolated, individual buildings. In fact, due to the large roof and facade surfaces and mainly massive construction, stadia offer an enormous potential for the use of renewable energy sources and could be both, energy provider and energy storage for the surrounding neighbourhood.

Therefore, a case study analysis has been conducted to identify potentials in terms of urban planning and energetic aspects. Moreover the study involves an investigation about the ability to connect a stadium with the surrounding neighbourhood to benefit from sy(e)nergies. The goal is to develop a broader understanding of the building typology (stadium) and its role in the neighbourhood. From the point of view of sustainability a stadium should be more than a venue for large sport events, the typology also offers a lot of potentials for improving the social and energetic qualities in the neighbourhood.

2. FROM STADIUM TO NEIGHBOURHOOD

2.1 Status quo: Stadia today

Unlike the ancient Greeks who hold major sport events on earth walls [Essig, 2010], we are hosting them today in big stadia and arenas. A stadium in the modern sense describes a venue of sporting competitions in the form of a playing field or swimming pool surrounded by a stand for the spectators [Karch, Höf, 2008]. As in the early 20th century the athletes had played on uneven lawns with two makeshift goals without nets, the current requirements changed completely. The first stages usually only offered standing places. Covered stands were initially extremely rare, so most competitions were organized under the open sky. In Europe, stadia were characterized by the 400 m running track whereby the stands were a few meters away from the pitch. Over time sports such as handball, basketball, volleyball and hockey tended more and more to move to closed halls. At the same time stadia with 400 m running track increasingly disappeared and there were more and more pure football stadiums built. With the age of television as well as in line with the increase in commercialization of sports events, luminous installed floodlights and the stadium itself increasingly gained importance [Adam, 2010]. In contrast to the stages of the 70's buildings now arise "whose close envelopes capture the visitors 90 minutes, directly adjacent to the pitch" [Karch, Höf, 2008].

Since an accident due to mass panic in Brussels (1985) single seats are prescribed. As with bigger arenas the operating costs explode, big VIP areas are forced more and more. Because of the size as well as more and more functions the building covers, the requirements for infrastructure regarding catering, plumbing, space, etc., increased immensely [Adam, 2010].

Today's stadia are more than just a venue for hosting sports competitions, they are meeting points in today's society, places of action, of exchange, the encounter of different cultures and much more.

2.2 Sustainability of mega event buildings

Undeniably, mega event buildings have a high resource and energy demand. In terms of sustainability, it is still a long way to go before you can consider mega event arenas as sustainable buildings. But the green lights are there: Non-governmental organizations like UNEP (United Nations Environment Programme), Greenpeace or WWF (World Wide Fund for Nature) as well as the organisation committees of sport events have demanded for sustainability impact assessments for venues for a couple of years in order to reduce the impact on the environment and the climate. As a result different sustainable planning concepts and the use of sustainability assessment methods have been adopted by the host cities and organisation teams.

Examples are the venues of the Vancouver 2010 Olympic Winter Games, London 2012 Olympic Summer Games or the Football World Cup of Brazil 2014. In the case of the Games in Vancouver and London the organising committees have certified their new and existing competition venues as well as non-competition facilities by applying existing national assessment schemes to build and operate the buildings to ensure a minimal environmental footprint. Vancouver, for instance, has used the North-American system LEED Canada (Leadership in Energy and Environmental Design) to assess its Olympic sports facilities. For the London Games 2012 the label **"BREEAM for Olympic Park and Venues" was developed by BRE (Building Research Establishment)** within the national sustainability method BREEAM (BRE Environmental Assessment Method) to assure the ecological implementation of the Olympic venues [Essig, 2010]. Considering that the IOC is only demanding for assessing the sustainability performance of the facilities, but not giving out common mandatory indicators and benchmarks, the host cities have fulfilled the assessment with different approaches. Due to the applied diverse tools and instruments, the evaluation results of the venues are not comparable at all.

In addition, by the public rejection of mega events the societies in first world countries stress that the present procedure, exceeding prior arenas with newly built bigger and full service mega event buildings, is not tolerated any more. In particular the nearby residents in the centre of the city where most of the sports facilities should have been situated are the most sceptics.

For this reason this study raises the questions about how a mega event building – a stadium or arena – changes the surrounding neighbourhood and how advantages can be derived from the adjacent location. Accordingly the present study attempts to demonstrate stadium-neighbourhood relationships and synergies as well as their inter-linking considering urban planning, infrastructure and energy.

3. ANALYSIS: STADIA AND NEIGHBOURHOODS

3.1. Locations

First step was to categorize the locations of stadia as there are different scenarios for planning approaches as well as possible synergies: It should be differentiated between in-town and out-of-town stadia. So far the locations of first league football stadia in Germany, England and Spain were analysed (Figure 2).

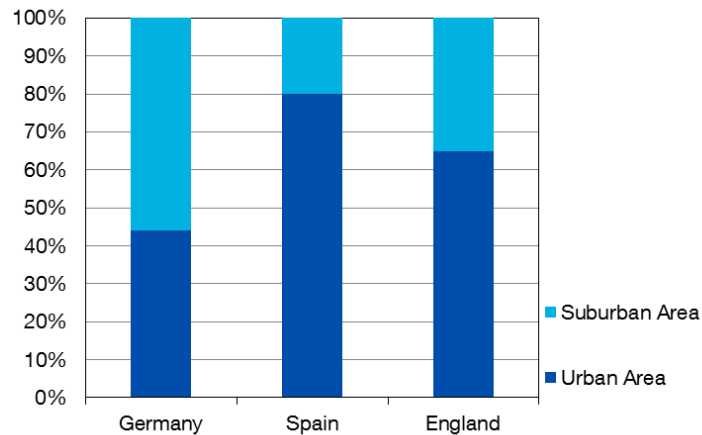

Figure 2: Characteristic location of stadia in Europe

Furthermore, the surroundings can be characterized as mixed/ urban areas, residential or commercial areas. In Germany, most stadia can be found in close vicinity to commercial areas. Moreover, a majority of stadia is located in suburban areas, which is mainly due to the high rate of new constructions for the Football World Championships hold in Germany 2006. While in England most stadia are situated in urban, mixed areas followed by residential areas, in Spain they can most likely be found in mixed areas with urban characteristics (Figure 3).

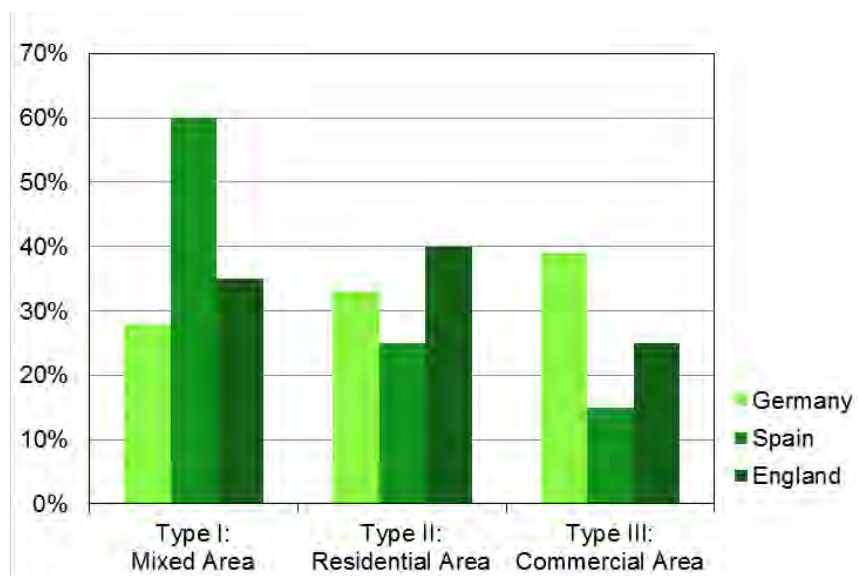

Figure 3: Characteristic surrounding of stadia in Europe

3.2. Neighbourhood related aspects

For identifying the stadium-neighbourhood relationships, case study neighbourhoods are investigated in terms of urban planning characteristics. Exemplary criteria for the study are as follows: Local supply, green spaces as well as the image and density of the district, noise, light pollution, mobility etc. In a following step potentials and synergies will be derived and presented.

3.3. Energy related sy(e)nergies

As was pointed out in the introduction to this paper, a main focus of the study are energy related synergies. Therefore, the energy demand of the case study neighbourhoods is investigated in terms of cumulated energy of the different uses, load profiles as well as share of renewable energy. Notable examples for producing energy in a stadium - for instance through integrating photovoltaic modules in the building shell - are "Mineirão" stadium in Belo Horizonte, Brazil or Weserstadion in Bremen, Germany. However, little is known about the potentials of integrating a stadium in a local smart grid so far.

Thus it will be analysed to which extent energy can be saved by the cross-linkage with the surrounding neighbourhood with the help of intelligent power distribution and renewable energy. The typical energy profile of a stadium shows a high peak load in terms of an event and a lower, but constant base load (see example Figure 4). An example of the stadium Letzigrund in Zurich shows that this base load shouldn't be neglected: 73% percent of the annual energy consumption of the stadium results from times without an event [Stadion Letzigrund Stadionmanagement, 2012]. Therefore, simulations will be performed analysing energy efficiency measures for stadia, for example to proof whether and how energy can be produced on the site of the stadium. Can energy be stored in the neighbourhood in times of no event and reversed to cover the peak loads in times of an event?

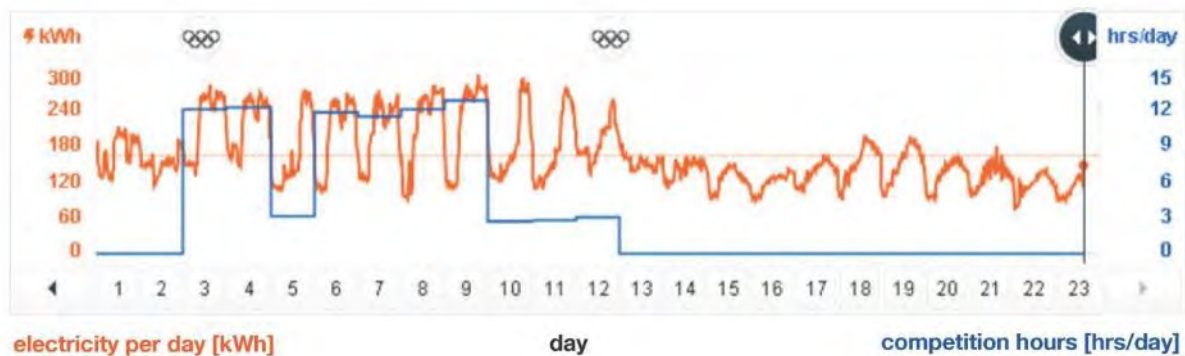

Figure 4: Energy load curve of the Olympic Stadium London 2012 [EDF Energy, 2012]

4. CONCLUSION

This study has raised the questions about how a mega event building – a stadium or arena – changes the surrounding neighbourhood and how advantages can be derived from that. Therefore, stadium-neighbourhood relationships are analysed with a major focus on energy related sy(e)nergies. As stadia are expanding more and **more to massive constructions and becoming important meeting points in today's society**, it is a crucial part to integrate the buildings into the surrounding and to connect them socially, ecologically and economically.

REFERENCES

- [1] Adam, P. N., 2010: Einst Spielplatz, heute Eventarena. In: Schule & Sportstätte, Jg.45, H.2, S.26-27.
- [2] AFP, 2015: IOC lash out after Hamburg rejects 2024 Olympic Games bid. News.com.au. [Online] Retrieved from: <http://www.news.com.au/sport/more-sports/ioc-lash-out-after-hamburg-rejects-2024-olympic-games-bid/news-story/edfc17d0464b1390e3b523f4bceba1dd> [Retrieved on 31 March 2016].
- [3] Eberts C., 2015: Warum Bostons Rückzug schlecht für Hamburg ist. Süddeutsche Zeitung. [Online] Retrieved from: <http://www.sueddeutsche.de/sport/olympische-spiele-warum-bostons-rueckzug-schlecht-fuer-hamburg-ist-1.2585163> [Retrieved on 28 July 2015].
- [4] EDF Energy, 2012: Real-time Energy monitoring at the London 2012 Olympic Stadium. [Online] Retrieved from: <http://www.edfpowerthegameslive.com/venues/olympic-stadium/> [Retrieved on 24 August 2012].
- [5] Essig N., 2010: Nachhaltigkeit von Olympischen Sportbauten. Stuttgart. ISBN 978 3 8396 0168 6
- [6] Essig N., Gantner J., Magdolen S., 2012: London 2012 - ein Ansatz für nachhaltigere Spiele?. Institut für internationale Architektur-Dokumentation GmbH & Co. KG . Munich. [Online] Retrieved from <http://www.detail.de/artikel/london-2012-ein-ansatz-fuer-nachhaltigere-spiele-9132/> [Retrieved on 04 April 2015].
- [7] Karch, P. M., Höf, D.-I. M., 2008: Heimspiel Experimentelle Raumstruktur für das Eintracht Braunschweig-Stadion. [Online] Retrieved from: http://stdb.iqs.bau.tubs.de/stdb/angebot_pdf/angebot_836.pdf [Retrieved 15 July 2012].
- [8] Preuss H., 2004: The Economic of Staging the Olympics: A Comparison of the Games 1972 – 2008. Edward Elgar Publishing. Cheltenham.
- [9] Stadion Letzigrund Stadionmanagement, 2012: Energiecontrolling 2012. [Online] Retrieved from: <http://www.stadionletzigrund.ch/aktuell/2013/04/16/energiecontrolling-2012/> [Retrieved on 28 June 2016].
- [10] Statistisches Amt für Hamburg und Schleswig-Holstein, 2015: Olympia-Referendum in Hamburg am 29. November 2015 – Ergebnisse. [Online] Retrieved from http://www.statistik-nord.de/fileadmin/maps/election_2015_hh_ref2/ [Retrieved on 29 March 2016].

Session 6.3: Smart Initiatives in SBE (2)

Transforming Building Information Modelling to Sustainable Building Asset Management

LEE Che-kit^a, CHAN Ping-sun^b, CHAN Hor-yin^c, YUEN Piu-hung^d

^a The Electrical and Mechanical Services Department, Government of the HKSAR, Hong Kong SAR, cklee@emsd.gov.hk

^b The Electrical and Mechanical Services Department, Government of the HKSAR, Hong Kong SAR, pschan@emsd.gov.hk

^c The Electrical and Mechanical Services Department, Government of the HKSAR, Hong Kong SAR, stevehyc@emsd.gov.hk

^d The Electrical and Mechanical Services Department, Government of the HKSAR, Hong Kong SAR, phyuen@emsd.gov.hk

ABSTRACT

Building Information Modelling (BIM) technology has rapidly emerged in recent years in architecture, engineering and construction (AEC) industry to reduce design and construction efforts through enhanced multi-disciplinary coordination, however, its application in the long building lifecycle of operation and maintenance (O&M) stage is little investigated. Whilst research studies and real-world applications of BIM in building facility management (FM) and asset management (AM) have put emphasis on data exchange between BIM and FM/AM software, this paper presents a novel system framework and our development works for transforming BIM to sustainable building asset management by seamless integration among BIM model, AM system and multiple electronics systems/tools.

Furthermore, the proposed framework provides a visually intuitive way to access heterogeneous O&M information of assets such as photos, attributes, equipment relationships, manuals, drawings, maintenance records, live view of Closed Circuit Television (CCTV) System, real-time sensing data from a Building Management System (BMS) and wireless ad-hoc sensors, as well as location information from a Real Time Location System (RTLS) in one single integrated mobile platform. All these information is accessible simply by asset repository, manoeuvring throughout a BIM model, or even a handheld Radio Frequency Identification (RFID) scanning tool.

Having selected our headquarters building as a showcase project, an integrated BIM-AM System with four key generic user models has been developed to implement the proposed framework. The results have successfully demonstrated the system capabilities in not only facilitating daily O&M works and effective asset management but also responsive incident handling, thus enhancing building sustainability.

Keywords: asset management, smart building, information integration

1. INTRODUCTION

Tracing and identification of building facilities using 2D computer-aided design (CAD) drawings are complicated and inefficient particularly where there are overlapping layered services. Inconvenient cross-reference among different 2D CAD drawings also hinders a clear visualisation of concerned service like duct and pipe works of Heating, Ventilation, and Air Conditioning system. A better visualisation of service drawings is therefore always desirable from O&M perspective. In recent years, BIM, a digital model and process being conceived as an object-oriented CAD system supporting the representation of building elements in terms of their geometric and functional attributes as well as their inter-object relationships, has rapidly emerged in AEC industry to facilitate early coordination among different disciplines, leading to significant shrink of construction schedules and project costs.

However, the approach and application of adopting BIM for sustainable building asset management is yet to be investigated. Whilst there are many research studies and real-world applications of adopting BIM in FM/AM, most of them focus on data population from BIM to FM/AM software [1,2,3,4] either by proprietary add-ins, open BIM standard in IFC format [5], or a spreadsheet / an XML file for Construction Operations Building Information Exchange (COBie) [4,6,7]. Albeit that there are researches involving information exchange between BIM and FM/AM system with BMS integrated [8] and integrating RFID technology with BIM [9], they are in essence not considered as full and seamless integration among BIM, FM/AM software and multiple O&M systems in terms of their integration diversity and extent, as compared with our developed BIM-AM System. Owing to the utmost importance of information accessibility for efficient O&M, asset related information that can be obtained by maintenance engineer should not be limited to static asset attributes of each building element residing in the BIM

model. To close the gap between direct adoption of BIM and day-to-day O&M practice for sustainable asset management, we have investigated the appropriate approach for integrating/interfacing BIM with a variety of O&M systems/tools.

This paper aims to show that, by leveraging the underlying principle of BIM in facilitating effective information exchange and storing in an interoperable and reusable way, a novel framework exploiting BIM in integrating AM and a variety of O&M systems/tools has been successfully implemented with a view to streamlining building O&M. Such a BIM-AM System has been piloted in our headquarters building to evaluate its O&M effectiveness. The pilot results have broken new ground in the application of BIM and could potentially fill a void in the market. The BIM-AM System features multiple O&M tools in a single integrated application, offering real-time O&M information sharing/retrieving and exchange capabilities, thus making system handover and O&M much more efficient and effective. It is envisaged that the BIM-AM System would be an enabling tool for sustainable building asset management.

2. SYSTEM FRAMEWORK

As far as our knowledge goes, full and seamless integration of BIM with an AM system as well as a variety of O&M systems/tools including BMS, CCTV system, RFID scanning tool, and RTLS has not been realized. Figure 1 depicts the proposed system framework in which the dotted line indicates the integration that may have been implemented in some other FM/AM software applications whereas the solid line indicates the full and seamless integration that was first implemented by us in 2014.

Under this framework, AM system is considered as an O&M software application for building asset management, preventive maintenance and corrective maintenance management including workflow for fault reporting, handling and monitoring. One of the most distinctive differences is that the AM system in the proposed framework serves as a middleware to integrate/interface with other systems/tools whereas other research works take BIM as a middleware for information exchange with other systems/tools, thus increasing the integration complexity. This is because direct integrations between BIM and other systems/tools would result in high complexities in the Application Programming Interface (API) developments on BIM software and the systems/tools. Moreover, BIM cannot replace the role of AM system in storing and upkeeping AM-related information as well as performing other comprehensive AM features. Another distinctive difference between our works and other researches is that the visual integration between BIM and AM system is in a seamless and intuitive manner, in the sense that the BIM-AM System allows locating and visualising any particular asset with its real-time asset information by maneuvering freely throughout the BIM model in one single integrated system, instead of mere data exchange between BIM and AM system.

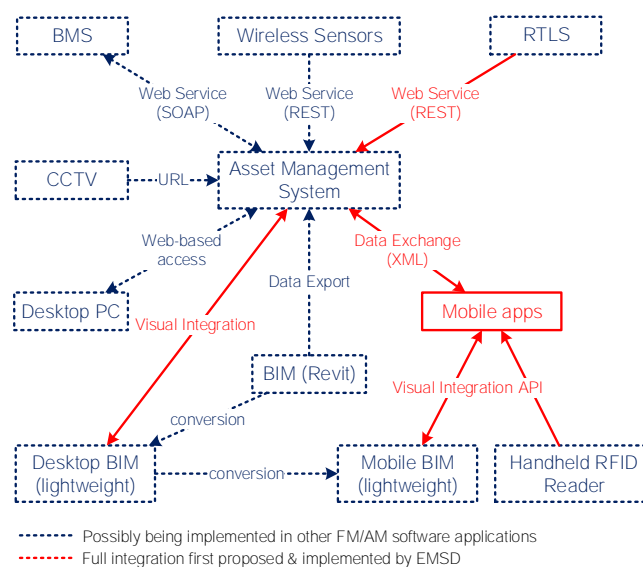

Figure 1: The novel framework for BIM-AM System

2.1. Visually intuitive cross-reference among real-world, BIM model, and static asset information

The BIM-AM System enables visually intuitive cross-reference of real-world physical objects to BIM model and even to asset attributes, maintenance records, asset relationships, system topologies, manuals (including animated repair manuals, if any) and system drawings at a mobile terminal. As shown in Figure 2, a VAV box can be visualised and quickly located in its approximate real-world physical location, enabling easy cross-reference to a BIM model for pre-diagnosis.

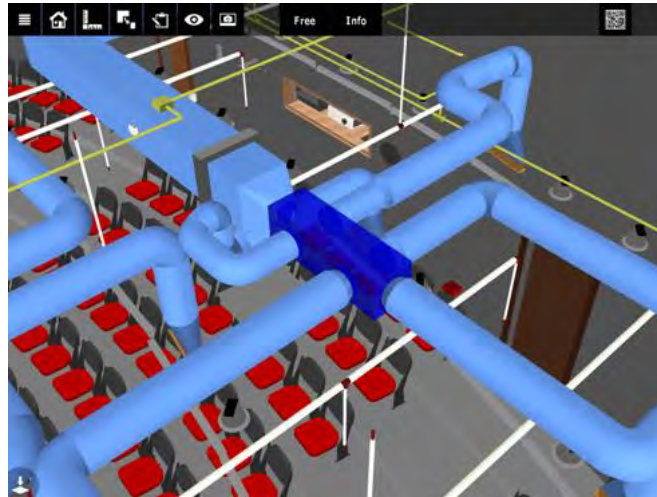

Figure 2: Georeference of a VAV box in a BIM model

System topology generation was purposely developed to visualise the asset relationships within a particular system for further cross-referencing among assets information during fault locating. The system topology as shown in Figure 3 provides a graphical view of the asset relationships of the VAV box within the overall system.

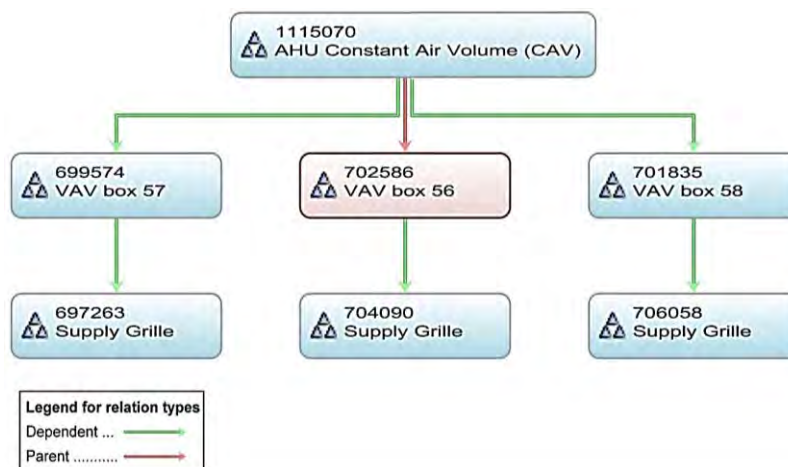

Figure 3: System topology visualising the asset relationships of a VAV box within the overall system

In addition, we have established our BIM-AM asset templates for Mechanical, Electrical, and Plumbing (MEP) installations. Apart from typical system specific attributes, the standardised asset templates also contain the information of asset relationship, wireless tag ID and geometric related attributes for system topology generation, RFID/RTLS application, and BIM visualisation respectively.

2.2. Pre-diagnosis and condition monitoring based on real-time asset information from BMS, wireless ad-hoc sensors, and CCTV system

Integrating BIM-AM System with BMS and fixed CCTV system for accessing real-time remote site information with control functions at a mobile terminal could facilitate efficient offsite pre-diagnosis and possible rectification. Based on the pre-diagnosis, maintenance engineer would be able to bring necessary tools / spare parts to the site in one go. Figure 4 is the mobile screen capture showing the real-time BMS monitoring sensor values of an Air Handling Unit (AHU).

Code	Meter	Reading date-time	Reading value
1028778	DAHU706.TSP2, Return Temp Set PT (EMSD)	10/12/2015 15:22	24
1028779	DAHU706.PSP, Static Pressure Set PT (EMSD)	10/12/2015 15:22	430
1028781	DAHU706.PSP, Static Pressure Set PT (EMSD)	10/12/2015 15:23	445
1028786	DAHU706.TSP2, Return Temp Set PT (EMSD)	10/12/2015 17:50	27
1028787	LTG_RM7153, Rm 7153 Lighting Control (EMSD)	10/12/2015 09:52	1
1028789	LTG_RM7153, Rm 7153 Lighting Control (EMSD)	10/12/2015 09:54	100
1028832	VAV7F_55FDS, VAV Damper Status	16/12/2015 21:23	38.13
1028834	VAV7F_55FLW, VAV Flowrate	16/12/2015 21:23	0

Figure 4: BMS monitoring interface of an AHU in the BIM-AM system

In addition, wireless ad-hoc sensors, such as temperature sensor, humidity sensor, power metre, and wireless camera over WiFi, Bluetooth, and cellular networks, were developed for prompt installation and monitoring. These wireless ad-hoc sensors are considered useful in incident handling, condition monitoring, generation of pre-fault alerts, or energy management. Figure 5 shows the live feed of a wireless camera available at the mobile terminal for monitoring the subject plant room area. In this pilot, web services have been employed for the data communication from BMS and wireless sensors to the AM system and vice versa.



Figure 5: The live feed of a wireless camera in the BIM-AM system

2.3. Efficient locating of fixed and movable assets

Having integrated the mobile terminal platform of BIM-AM System with a handheld RFID scanning tool, maintenance engineer could efficiently and effectively locate critical equipment for further enquiry of asset information even if the equipment is hidden above a false ceiling or underneath a raised floor. Figure 6 shows a mobile screen capture of RFID scanned results listing nearby assets.

ScannerName	HW	SW	Battery 0%		
		29	[Scan]		
			[Search By ID]		
Equipment ID	Description	Location	System Type	Signal	
000258	AHU supply 1.4 - 2.8 m3/s	LOBBYZone 1	HVAC	90%	
000244	Airco Unit	AHU RoomZone 4	HVAC	80%	
000243	Emergency lighting decentrally fed	Common AreaZon...	LIGHT	70%	
000253	Splitting system VAV	Hub RoomZone 5	HVAC	60%	

Figure 6: RFID scanned results listing nearby assets

To extend the locating feature from fixed assets to movable assets such as working platform and biomedical equipment, RTLS over WiFi and Ultra-Wide-Band (UWB) technologies, as shown in Figures 7(a) and 7(b) respectively, were piloted in EMSD HQs building. The latter was adopted and installed because of higher positioning accuracy.

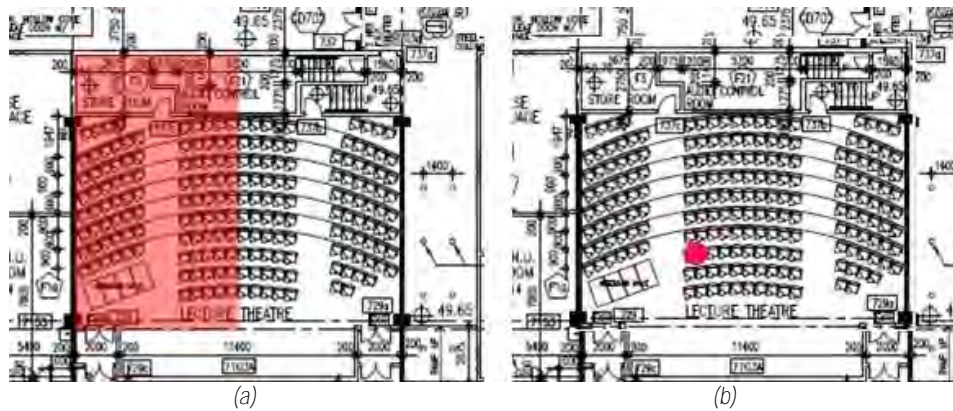

Figure 7: (a) RTLS over WiFi; (b) RTLS over UWB

2.4. Efficient and effective O&M workflow management

Coupled with four key generic user interfaces for client, helpdesk, supervisors and frontline, the BIM-AM System can facilitate efficient and effective O&M workflow in fault reporting, handling and monitoring not only for in-source but also out-source arrangement. As shown in Figure 8, the user interface for the maintenance engineer provides readily accessible asset information, such as asset attributes, maintenance record, equipment relationship, system topology, manual, and system drawing as well as creating service request and cross-referencing to BIM model. Additionally, the System can timely notify users to fill in an electronic pre-work safety check form such that the safety compliance can be easily achieved.

Moreover, the System can cater for highly dynamic and versatile interactions among different parties in the client, maintenance contractor and our organisation by assigning respective features to different parties to facilitate efficient and effective O&M services, supervision and communication at all times.

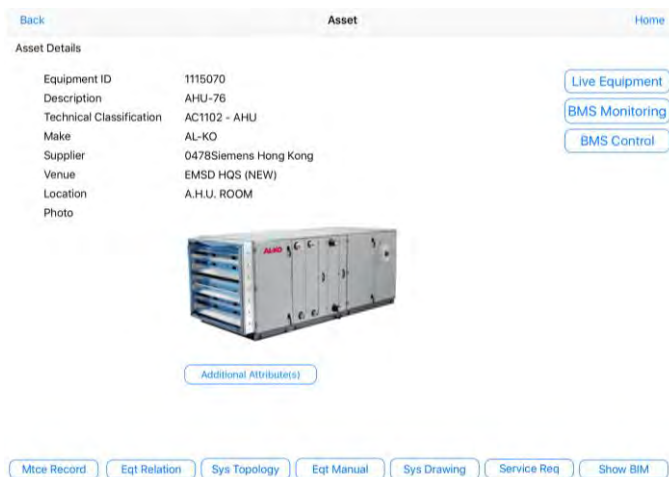

Figure 8: User interface for the maintenance engineer at the mobile terminal

3. DEMONSTRATION

Simulated maintenance showcases using an AHU model, a fire sprinkler system model, an emergency lighting model, and a general lighting model in the BIM-AM System were recorded in videos for demonstration purpose [11]. The results demonstrate that the BIM-AM System can improve productivity in fault response, workflow

management, safety compliance, retrieval and appending of maintenance record, access of asset details, relationships and manuals, and so on. Significant time-saving of more than two hours can be achieved on fault localization in a typical air conditioning fault situation as compared with the current practices. In fiscal year 2015/2016, the total number of maintenance orders was about 639,000 in all buildings maintained by the EMSD. Projecting the potential time-savings without real trials would lead to inconclusive findings, but the benefits of the full rollout are foreseeable.

4. CONCLUSION

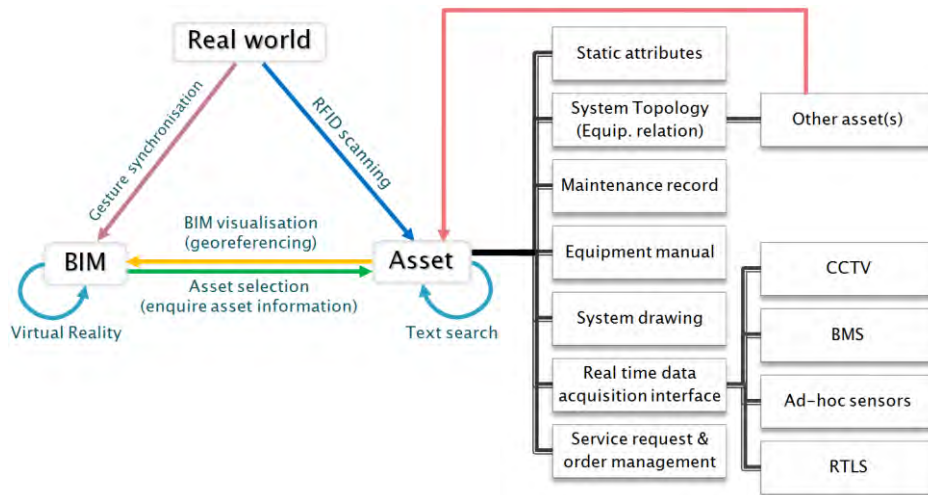

Figure 9: A graphical summary of BIM-AM System features

We have proposed a novel system framework exploiting BIM in asset management and realized the concept in an integrated BIM-AM System featuring multiple O&M systems/tools in one single platform. A graphical summary of the System features is exhibited in Figure 9. The integrated platform has proved effective in streamlining workflow, facilitating responsive incident handling and sustainable asset management. The tool has great potential to bring major benefits including long-term cost savings in the O&M building lifecycle. Though the successes arising from the framework and pilot BIM-AM System are only on a limited scale, we hope the integrated BIM-AM System would not only benefit our services in operating and maintaining about 5,800 government buildings, but also encourage and facilitate the construction industry in Hong Kong to better deploy this new technology for sustainable building asset management, particularly O&M services, ultimately benefitting the public.

REFERENCES

- [1] Schevers, H.A., Mitchell, J., Akhurst, P., Marchant, D.M., Bull, S., McDonald, K., and Linning, C., 2007. "Towards digital facility modelling for Sydney Opera House using IFC and semantic web technology", *Journal of Information Technology in Construction*, 12, pp. 347-362.
- [2] Sabol, L., 2008. *Building Information Modeling & Facility Management*, Washington, DC: Design + Construction Strategies.
- [3] Ding, L., Drogemuller, R., Akhurst, P., Hough, R., Bull, S. and Linning, C., 2009. "Towards Sustainable Facilities Management", in Newton P., Hampson K. and Drogemuller R. (Eds). *Technology, Design and Process Innovation in the Built Environment*. Taylor & Francis, pp. 373 - 392.
- [4] Teicholz, P.M., 2013. *BIM for facility managers*, (IFMA, Ed.), Wiley, Hoboken, N.J.
- [5] Lewis, A., 2013. "Case Study 5: State of Wisconsin Bureau of Facilities Management, Division of State Facilities, Department of Administration", IFMA (Ed.), *BIM for Facility Managers*, Wiley, Hoboken, N.J., pp. 250-293.
- [6] Aldaham, O., Gonzalez, J., Grant, I., Harper, K., Kruger, A., Nannis, S. and Snedeker, L., 2013. "Case Study 1: Mathworks", IFMA (Ed.), *BIM for Facility Managers*, Wiley, Hoboken, N.J., pp. 147-163.
- [7] Beatty, R., Eastman, C. and Kim, K., 2013. "Case Study 2: Texas A&M Health Science Center", IFMA (Ed.), *BIM for Facility Managers*, Wiley, Hoboken, N.J., pp. 164-184.
- [8] Aspurez, V. and Lewis, P., 2013. "Case Study 3: USC School of Cinematic Arts", IFMA (Ed.), *BIM for Facility Managers*, Wiley, Hoboken, N.J., pp. 185-232.

- [9] Motamedi, A., Soltani, M. and Hammad, A., 2013. "Localization of RFID-equipped assets during the operation phase of facilities." *Advanced Engineering Informatics*, pp. 566-579.
- [10] Abiola, A.A., Chimay, J.A. and John, I.M., 2012. "An RTLS-Based Approach to Cyber-Physical Systems Integration in Design and Construction," *International Journal of Distributed Sensor Networks*, vol. 2012, Article ID 596845.
- [11] Videos of Building Information Modelling - Asset Management (BIM-AM), Electrical and Mechanical Services Department, HKSARG [online]. Retrieved from: http://www.emsd.gov.hk/en/engineering_services/project_management_consultancy/highlights_of_work/bim_am/index.html [Retrieved on 30 September 2016].

Meter Online: Information Drives Behavioural Change to Save Building Energy

Eric CHEUNG^a, Simon LAM^b, Simon TSUI^c, Joseph LAI^d, Cary CHAN^e

^a CLP Power Hong Kong Limited, Hong Kong SAR, pccheung@clp.com.hk

^b CLP Power Hong Kong Limited, Hong Kong SAR, simonlam@clp.com.hk

^c CLP Power Hong Kong Limited, Hong Kong SAR, simontsui@clp.com.hk

^d The Hong Kong Polytechnic University, Hong Kong SAR, joseph.lai@polyu.edu.hk

^e Hong Kong Green Building Council Ltd., Hong Kong SAR, cary.chan@hkgbc.org.hk

ABSTRACT

The rising need for reducing building energy use has continued to grow over the world. In Hong Kong, various measures have been developed for curbing energy use and a target has been set to reduce 30% of building electricity consumption by 2030, as compared to the level of 2005. Towards this goal, a range of efforts have been made, including those in practice and on the academic side. A review of the relevant literature, however, reveals that research showing how the use of online energy consumption forecast information could drive changes in occupant or user behaviour is limited. Reported in this paper includes a case study, which was conducted on a residential clubhouse in Hong Kong. Using the Meter Online (MOL), a system developed by CLP Power Hong Kong Limited (CLP) to provide energy consumption forecast information to commercial and industrial customers, the facilities management team of the clubhouse is pre-informed of the energy use of the clubhouse. The challenges in implementing energy saving actions for the clubhouse include the worry of attracting complaints from users about the air conditioning and the lack of technical knowledge of the frontline staff responsible for taking the energy saving actions. In addition to describing how the challenges were tackled and the various steps taken **during the implementation process, the case study shows that 5% of the clubhouse's energy use was successfully saved through changes in the user (operator) behaviour.**

Keywords: energy use, forecast, occupant behaviour

1. INTRODUCTION

The need for saving energy use in buildings, which is a goal of the global community, has continued to rise. In Hong Kong, a range of measures have been developed for curbing energy use and a target has been set to reduce **the city's carbon intensity** by 50-60% by 2020 (Environment Bureau, 2015). In parallel, the Hong Kong Green Building Council (HKGBC) launched the HK3030 Campaign, which aims to reduce 30% of building electricity consumption by 2030, as compared to the level of 2005 (Hong Kong Green Building Council, 2014).

In fact, a wide spectrum of efforts, including those in practice as well as those on the academic side, have been devoted over the years in order to achieve the goal of energy reduction. The ensuing section, which is a review of the recent literature, highlights some key research studies on occupant behaviour in relation to building energy use. Then, an empirical case study is reported. It shows how the energy consumption forecast of a residential clubhouse, which was provided by an online system of the power company, was used to inform decisions on energy saving actions. Not only the process of executing the actions and the hurdles encountered during the process are described, but the efforts made in surmounting the hurdles are also reported.

2. PAST STUDIES

Forming part of the research activities of the International Energy Agency Energy in Buildings and Communities Program Annex 66 (Definition and Simulation of Occupant Behaviour in Buildings), the review of Hong et al. (2016) introduced the recent advances in modelling occupant behaviour (OB) and assessed the impact on building energy use imposed by the barriers to the modelling. The challenges in OB modelling, as identified, include collection of good and adequate data for behaviour understanding and modelling, and quantifying the impact of energy-related occupant behaviour on building energy performance. Using building simulations, Barthelmes et al. (2016) demonstrated the potential impact of occupant behaviour lifestyles and different household compositions on energy use and thermal comfort conditions in a nearly zero energy building. EnergyPlus simulations were carried out, and three different levels of behaviour lifestyles and six types of interactions between inhabitants and building

envelope/systems (e.g. regulation of air-conditioning set-points, ventilation rates, etc.) were considered. The study found that the occupant behaviour lifestyles significantly affect the energy performance of the building; the urgent need of reference models related to human behavioural issues was also revealed.

To develop simulation models for evaluating the energy impact of occupant behaviour (especially occupant presence), Duan and Dong (2014) used occupancy sensors to collect occupancy data from four low income test beds in Texas, compared the data with the American Time Use Survey (ATUS) data, and integrated the real-life data into a validated EnergyPlus house model. The simulations found that instead of monitoring single zone all the time, using the occupancy pattern to determine which room to be controlled can reduce the energy consumption **for cooling by 7%**. **The result indicated that integrating detailed occupant behaviour information into facilities' control systems could achieve significant energy saving.** In South Africa, Masoso and Grobler (2010) used energy auditing equipment to audit the energy use of six randomly selected commercial buildings. Sub-hourly electricity consumption data were logged, with breakdowns of heating, ventilation and air conditioning (HVAC), plug load (office equipment) and lighting. The consumption amounts were also divided into two periods: working hours and non-working hours. It was found that more energy was consumed during the non-working period (56%) than the working period (44%). This dark side of occupant behaviour was largely due to occupants leaving lights and equipment on during off-duty periods.

To statistically determine occupant behaviour patterns associated with energy use for heating and to identify building characteristics that could contribute to the development of energy-user profiles, Santin (2011) used paper questionnaire to obtain detailed data on occupant behaviour and paired them with data on building characteristics obtained from municipalities and architects' firms. **Five underlying groups of behavioural variables were identified** for use in defining the occupant behaviour patterns and user profiles. While the relationships between occupant behaviour and household characteristics were made clear, the study found it hard to establish relationships between energy consumption and behavioural patterns. In a bid to assist in tailoring interventions to the specific characteristics of building occupants, Azar and Menassa (2015) carried out computer simulations and scenario analysis on a typical commercial building. Using an agent-based model and data gathered from the Commercial Building Energy Consumption Survey (CBECS) in the US, the study revealed that extremism have a high impact on building energy performance and could revoke the energy saved from traditional occupancy interventions. **The proposed solutions, including increasing social connectivity of occupants and increasing extremists' acceptance of new energy use behaviours, are promising.**

In the UK, the study of Mulville et al. (2014) explored the energy consumption patterns across the workstations in two office spaces and the potential effect of using feedback to encourage energy reduction through behaviour change. With the use of energy-monitoring devices and field surveys, the baseline data were compared with industry benchmarks to understand the impact of small power. Through the provision of comparative feedback, monitoring was also made to determine the effect of behaviour change interventions. It was concluded that even simple interventions such as an awareness of being monitored can have an impact on end user behaviour. Behind the variation in energy consumption, the key driver was occupant behaviour rather than technical considerations.

The above review, covering some recent and prominent studies, is by no means exhaustive. But a consensus of **the studies' outcomes is that occupant behaviour plays a vital role in energy use of buildings.** Research showing how the use of online information could drive changes in occupant or user behaviour, which has emerged recently (e.g. Cheung et al., 2016), is still limited. In the following, a case study on a residential clubhouse in Hong Kong is reported. It illustrates how appropriate actions could be taken to save energy by referring to predicted energy consumption.

3. ENERGY CHARGE REDUCTION: A CASE STUDY

The clubhouse investigated under the case study is located in a large estate which comprises 32 residential blocks, with a total of over 5000 flats. The final phase of the development was completed in 2011. The daily operating period of the clubhouse is from 7:00 a.m. to 11:00 p.m. Being the person-in-charge of the operations of the whole clubhouse, the facilities management (FM) team comprises an Estate Manager overseeing two branches of staff members, as shown in Figure 1.

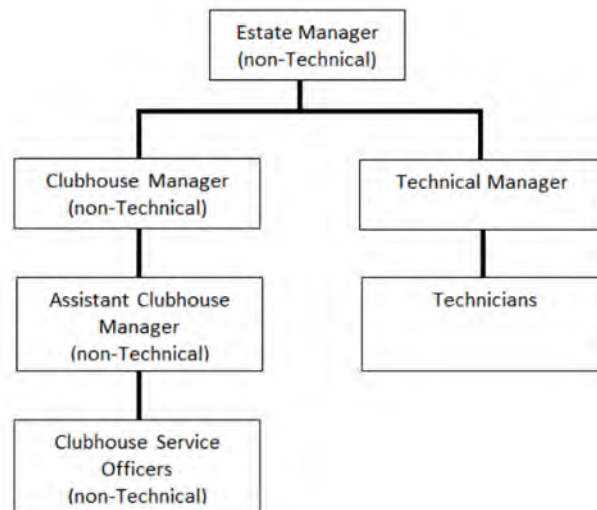

Figure 1: Organization chart of the clubhouse

Air-conditioning systems, lighting installations, lifts and the all-season swimming pool contribute to the major electricity consumption of the clubhouse. Between 2011 and 2014, T5 fluorescent lamps (FLs), compact fluorescent lamps (CFLs) and various types of LED lightings were used to completely replace all the original T8 FLs, halogen lamps, and non-LED lit exit sign. Variable refrigerant flow (VRF) units, split type air conditioners with **'grade one' energy label, and window blinds were used to reduce the chiller's load. Variable voltage variable frequency (VVVF) motor drives were used for the lifts to reduce their energy consumption.** Heat pumps were used to replace the original electric water heaters for the all-season swimming pool. Energy saving reminders were widely posted at prominent areas to remind users to switch off unnecessary lightings and encourage the use of daylight as far as possible. All air conditioning plants are set to maintain the indoor air temperature at 24.5 – 25.5°C. Furthermore, capacitors were also added to improve the power factor so as to reduce the demand charge of electricity.

After the completion of all the above measures, the total annual saving in energy consumption of the whole estate was over 15%. But the Owner Committee (OC) of the estate continued to ask the Estate Manager to further reduce the electricity consumption in order to curb the rise in management fee. Since all the major plants had been replaced with energy efficient ones, very limited energy saving could be achieved by further hardware change. Technically, raising the air conditioning temperature set-point of the clubhouse could be a possible way for energy saving, but less comfort for the clubhouse users is a price to pay and thus it is difficult to get all the users support this energy saving measure. An alternative measure is to replace the existing air cooled chillers with water cooled chillers, but it entails a large capital investment and very complicated modification would be required. Obtaining the support from the OC members to this measure, likewise, would be difficult. In a bid to explore other viable energy saving alternatives, the Clubhouse Manager met with his Account Manager of CLP Power Hong Kong Limited (CLP) - the company supplying electricity to the clubhouse.

The Account Manager initiated to conduct a joint Meter Online (MOL) power consumption forecast experiment with the Clubhouse Manager. The essential part of the experiment was to use MOL power consumption forecast function (i.e. MOL kWh Forecast) to justify extra energy saving actions. In principle, for each day with high forecast consumption, the Clubhouse Manager should reduce the air conditioning supply to the clubhouse, unless there were special bookings. The experiment was carried out from 1 September to 31 October 2014, and CLP helped to do the associated energy saving analysis.

The experiment was an innovative trial that made use of big data to save energy. Showing a great interest in it, the Clubhouse Manager organized a meeting, during which CLP explained to the Estate Manager about the concept and operation of the experiment. The expected outcomes include: the Clubhouse Manager could save energy consumption of the clubhouse, and CLP could learn any practical challenge in establishing a model to drive the implementation of energy saving actions without additional manpower. Realizing this win-win initiative, the Estate Manager agreed to proceed with the experiment.

3.1. Challenges encountered and solutions

Although making swift decisions was a critical success factor to realizing the advantages of the MOL forecast function, the Clubhouse Manager soon recognized that he might not be always available to visit the MOL system and order energy saving actions. Therefore, he delegated his authority to the Assistant Club Manager with the following simple decision rules: (a) If there is no special booking, implement special energy saving actions on all high consumption days as forecast by the MOL (Figure 2); (b) If customer complaint about air conditioning is received during the experiment, terminate all the energy saving actions and resume the air conditioning setting to normal.

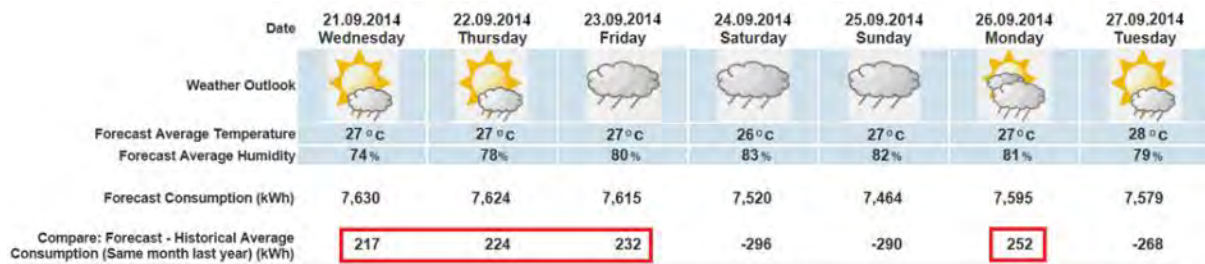

Figure 2: MOL 7-day energy forecast (Arbitrary figure is used for illustration purpose)

Then, the Clubhouse Manager arranged CLP to meet the Technical Manager for introducing the operation concept of MOL kWh Forecast to save energy and the necessity of adjusting the air conditioning plants in due course in order to realize the desired energy saving. The Technical Manager expressed that his technicians might not be available to do the extra plant switching because they had been occupied with their normal duties. He suggested that it would be more efficient if he prescribes the list of plants to be switched off and assign somebody to do the switching. The Clubhouse Manager appreciated the suggestion and agreed with it.

Afterwards, the Clubhouse Manager organized a meeting for CLP to introduce to the Clubhouse Service Officers the concept of using MOL kWh Forecast to save energy and the expected roles of the officers in dealing with the plant switching on high consumption days. The officers worried about their ability to do the switching and the potential customer complaints about insufficient air conditioning for the Clubhouse. In order to relieve their worries: (a) The Clubhouse Manager demonstrated the plant switching works by a joint site meeting with the technicians and the officers; (b) The Clubhouse Manager promised to ignore all the customer complaints associated with the extra energy saving actions when performance appraisals of the officers are made.

The Clubhouse Manager also reiterated the pressure of energy saving to the Clubhouse Service Officers and reminded them that it was a new way of energy saving with free-of-charge technical support offered by CLP. Touched by the enthusiasm and effort of the Clubhouse Manager, the officers indicated their support to the experiment. The Clubhouse Manager further promised that the experiment would be terminated if any customer complaint about the clubhouse's air conditioning is received during the experiment.

The technicians also supported the experiment. Several primary air units (PAUs) were selected to be switched off on high consumption days. They labelled the relevant switches of the PAUs for easy recognition by the Clubhouse Service Officers. The sequence of energy saving actions is summarized by the flowchart in Figure 3.

3.2. Result

The experiment was successful. Almost 7800kWh was saved during the experiment, which was equal to 5% of the total energy consumption in the same period (see Table 1). No customer complaint about the air conditioning for the clubhouse was received throughout the experiment period. The Estate Manager appreciated the innovative spirit of the Clubhouse Manager, Technical Manager and Clubhouse Service Officers, and their keen support to the experiment. The Clubhouse Manager was invited to share his experience in this experiment in a subsequent technical talk, which was attended by professionals in the building industry.

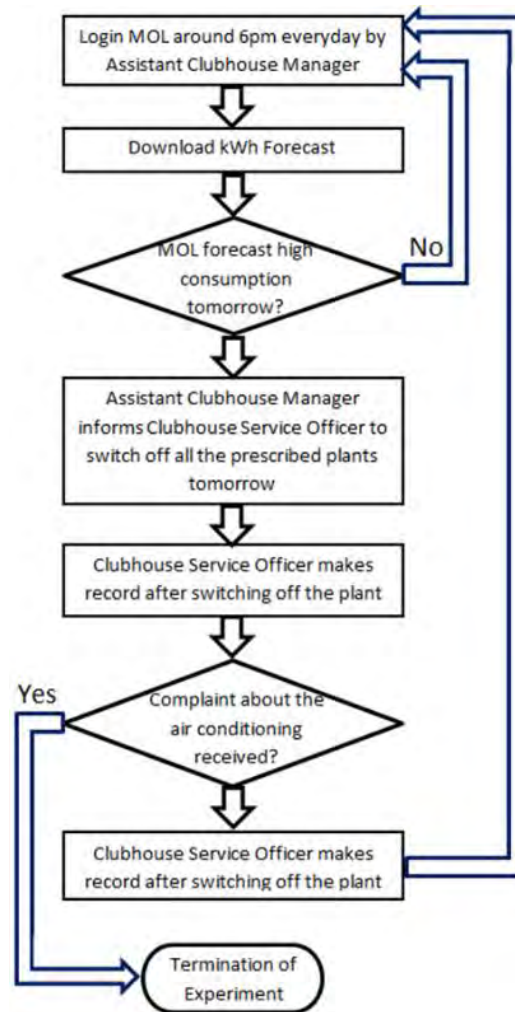

Figure 3: Sequence of energy saving actions

Electricity Account	Result	Forecast Saving by the Energy Saving Actions ^(Note 1)	Actual Saving by the Energy Saving Actions ^(Note 2)
Account Number 123456	Successful	6082 kWh	7779 kWh

Table 1: Energy saving result of the experiment (1 Sep – 31 Oct 2014)

Notes: (1) Forecast Saving by the Energy Saving Actions = \sum All Action Days in the whole experiment period (Forecast Consumption without Actions – Actual Consumption after Actions). (2) Actual Saving by the Energy Saving Actions = Total Energy Consumption during the Test Period – Total Energy Consumption of the same period in 2013.

4. CONCLUSION

Many energy saving measures are widely known. The literature review found that although occupant behaviour has a crucial role to play in saving building energy, research on how online energy consumption forecast could drive users to save energy was very little, if not none. The above case study, centred on a residential clubhouse, illustrates the use of the MOL - an online system that can forecast energy consumption for energy saving purposes. It shows not only the process of putting energy saving measures into actions but also how the problems encountered during the process were overcome. With the concerted efforts of the whole FM team and the energy supply company, a significant amount of energy was saved for the clubhouse. MOL not only provided a scientific means for justifying the energy reduction measures but also effected a genuine behavioural change of the team members in implementing the energy saving actions.

REFERENCES

- [1] Azar, E. and Menassa, C.C. (2015), "Evaluating the impact of extreme energy use behavior on occupancy interventions in commercial buildings", *Energy and Buildings*, Vol. 97, pp. 205-218.
- [2] Barthelmes, V.M., Becchio, C. and Corgnati, S.P. (2016), "Occupant behavior lifestyles in a residential nearly zero energy building: Effect on energy use and thermal comfort", *Science and Technology for the Built Environment*, Vol. 00, pp. 1-16.
- [3] Cheung, E., Lam, S., Tsui, S, Wong, W.K., Lai, J. and Chan, C. (2016), "The Meter Online Service - Application of Weather Information in Support of CLP Electricity Consumption Forecast for Customers", Conference of The Electric Power Supply Industry 2016, Bangkok, Thailand, 23-27 October. (in press)
- [4] Duan, Y. and Dong, B. (2014), "The contribution of occupancy behavior to energy consumption in low income residential buildings", *International High Performance Buildings Conference*, Paper 99.
- [5] Environment Bureau (2015), *Hong Kong Climate Change Report 2015*, Hong Kong.
- [6] Hong Kong Green Building Council (2014), *Market Drivers for Transformation of Green Buildings in Hong Kong, A Roadmap to Deep Energy Reduction: Executive Summary*, Hong Kong.
- [7] Hong, T.Z., Taylor-Lange, S.C., D'Oca, S., Yan D. and Corgnati, S.P. (2016), "Advances in research and applications of energy-related occupant behavior in buildings", *Energy and Buildings*, Vol. 116, pp. 694-702.
- [8] Masoso, O.T. and Grobler, L.J. (2010), "The dark side of occupants' behaviour on building energy use", *Energy and Buildings*, Vol. 42, pp.173-177.
- [9] Mulville, M., Jones, K. and Huebner, G. (2014), "The potential for energy reduction in UK commercial offices through effective management and behavior change", *Architectural Engineering and Design Management*, Vol.10 (1-2), pp. 79-90.
- [10] Santin, O.G. (2011), "Behavioural Patterns and User Profiles related to energy consumption for heating", *Energy and Buildings*, Vol. 43, pp. 2662-2672.

Energy Efficient Optimal Controls and Smart Energy Management of Buildings and Their Energy Benefits in Real Applications

WANG Shengwei^a, SHAN Kui^b

^a The Hong Kong Polytechnic University, Hong Kong SAR, beswwang@polyu.edu.hk

^b The Hong Kong Polytechnic University, Hong Kong SAR, shan.kui@connect.polyu.hk

ABSTRACT

This paper provides a summary on the energy efficient optimal control methods developed and the actual energy benefits when implementing these optimal control strategies in real buildings over the last ten years. The control optimization methods cover most of sub-systems in commercial HVAC systems as well as special indoor environment control systems such as that serving cleanrooms, industrial processes and underground stations.

The various optimization methods implemented in a high-rise building in Hong Kong have achieved an annual saving of about 10 million kWh, of which about half is the contribution of optimal control. The energy savings of implementing optimal control strategies in the buildings of Hong Kong PolyU are projected to be between 15% and 30%.

Beside of the control strategies for commercial buildings, control methods and strategies are also developed for cleanrooms and other special spaces, which often have high or specific requirements on temperature and humidity controls and pressure and airflow balances. To control these variables, the counteractions between different processes often occur in practical applications, resulting in huge amount of energy waste. The implementation of proper and optimal control strategies in a pharmaceutical factory in Hong Kong achieves an annual energy saving of about 40% (around 5 million HKD).

Control and smart energy management methods are also developed for the building demand limiting control for electricity cost saving under current pricing and the demand response (DR) control to the requests of smart grid in the near future. Investigations show that peak power demand limiting in very few hours (2 - 5 hours) within a month could achieve very significant electricity cost saving in certain buildings (up to 25% of demand charge and up to 5% of total building electricity cost).

Keywords: energy saving; optimal control, smart energy management

1. INTRODUCTION

Building energy consumption increases rapidly in recent years due to global climate changing, increasing demand for healthy, comfort and productive indoor environment, etc. The contribution from buildings toward global energy consumption was approximately 40% (Omer 2008). According to the buildings energy data book (2012) provided by the U.S. Department of Energy, buildings account for 73.6% of electricity consumption, 41.1% of total energy use, and 40% of carbon dioxide emissions in 2010. In China, the building sector consumes nearly **20% of China's** total primary energy consumption in 2006, in which electricity occupies 44%. While in Hong Kong, the proportion of the energy consumption of buildings occupies nearly 91% of the total electric energy consumption in 2009.

Most of energy used in buildings is for the provision of heating, ventilation and air conditioning (HVAC), which takes over 50% of building energy consumption on an average (Pérez-Lombard et al 2008). High-level performance of HVAC systems in building lifecycle is critical to building sustainability. However, excessive energy is consumed in buildings and HVAC systems because they often fail to operate as intended.

Generally, energy saving in buildings can be achieved by three approaches: (1) Reduced heating/cooling loads, e.g. passive design of building envelopes; (2) Use of energy efficient components and technologies, e.g. using chillers, pumps, and fans of high efficiency; (3) System Optimization and optimal control.

Proper operation of building energy systems can lead to improved occupant comfort and health, improved energy efficiency, longer life cycle of equipment, reduced maintenance costs, and reduced unscheduled equipment shut down time, etc. This paper provides several real case studies aiming at saving energy in buildings using optimal control techniques.

Remaining of this paper is organized as follows: Section 2 describes the energy saving efforts for the tallest building in Hong Kong. Section 3 provides a briefing on the energy saving project for a clean room factory in Hong Kong. Section 4 shows the energy saving programme in the campus. Section 5 presents a summary on these energy saving projects.

2. CASE 1: THE TALLEST BUILDING IN HONG KONG

2.1. The building and its air-conditioning system

The International Commerce Centre, a 118-storey and 490m super high-rise commercial building, is currently the tallest building in Hong Kong. It has a gross floor area of approximately 321,000 m² except the hotel at the top of the building. It serves as a commerce centre involving commercial offices (mainly occupied by international financial firms), shopping arcades and a six-star hotel.

The central chilling plant consists of six identical centrifugal chillers (each with cooling capacity of 7,230 kW). Plate heat exchangers are employed to deliver cooling from low levels to high floors to avoid extremely high static pressure. Each chiller is interlocked with a constant condenser water pump and a constant primary chilled water pump. Taking into consideration the winter plume abatement purposes, two different types of evaporating cooling towers (named CTA tower and CTB tower, respectively) are used in this building. Each of the CTA towers (total of six) without heating coils has a heat rejection capacity of 5234 kW and each of the CTB towers (total of five) equipped with heating coils has a heat rejection capacity of 4061 kW at the design condition. All cooling towers are an in house type and are equipped with variable speed axial fans. All pumps in the secondary chilled water distribution system are equipped with variable frequency drivers for energy efficiency except that the primary chilled water pumps dedicated to the heat exchangers in Zones 3&4 are constant speed pumps. Each office floor in this building is served by two AHU systems. In each zone, the outdoor air is centrally supplied by several primary air units (PAU). The outdoor air is supplied to each AHU system through a VAV system. VAV dampers are installed to connect the main supply air ducts to deliver supply air into the ventilated zones with diffusers. Return air was drawn back through the ceiling plenum.

2.2. Energy efficient optimal control methods

The major challenge faced in this project is how to reduce building energy consumption and environment impacts while still providing satisfied indoor environment. Since HVAC system design stage (2005) and after the first stage of occupation in 2008, the research team, together with the developer, consultant, facility management team and contractors, has made serious efforts to develop innovative solutions for enhancing the energy efficiency and improving environmental performance. The actual annual saving is about 10 million kWh, of which about half is the contribution of optimal control. Figure 1 shows the total electricity consumption of the building in recent four years. The reduction was about 10.2 million kWh if comparing year 2015 with 2012, with an estimated 8.6 million kWh savings from the air-conditioning system. It shall be mentioned that the average outdoor air temperature in 2015 was 0.7 °C higher than that in 2014, which should have caused an increase in electricity demand.

The optimal control methods that had been applied to this large and complex system covers nearly all sub-systems, including air side sub-systems, chilled water delivery sub-systems, cooling system, and the chiller plant.

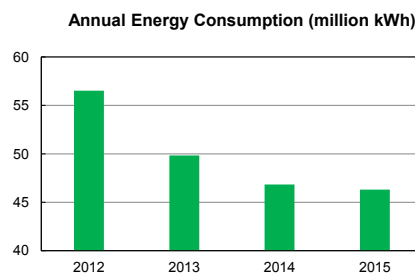

Figure 1: Annual energy consumption in the past four years

2.3. Air side optimal control methods

- Demand Controlled Ventilation (DCV) and free cooling

To solve the over-ventilation or under-ventilation problem in the conventional ventilation controls, a robust DCV control strategy using limited number of sensors based on ASHRAE standard 62.1 was developed and implemented to all office floors in the building (Shan et al 2012). Additionally, a model-based free cooling outdoor air control strategy was combined with the DCV strategy. The test results in operation confirmed that the energy consumption of the PAU can be saved up to 50% under part load compared with the original two stage control and the energy consumption for cooling outdoor air can be reduced by 65% at most. With the CO₂ concentration being maintained below 800 ppm, the excellent indoor air quality was ensured.

- Robust supply air static pressure control for AHUs

Conventional optimal control strategies reset the supply air static pressure based on the opening degrees of all the VAV dampers. However, such methods are not robust because the supply air static pressure set-point will gradually increase to its high limit in case some VAV terminals are abnormal, or with extremely low temperature set-points. A practically applicable fault tolerant control strategy was developed for pressure independent VAV systems (Shan et al 2015). Supported by the test data, the new control strategy is compared with the conventional strategy which was originally implemented in the building. The supply air static pressure is reduced significantly resulting in 33.6% power saving while the space thermal comfort was still maintained (Figure 2).

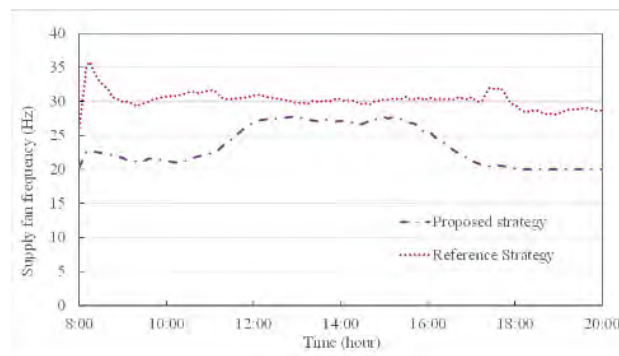

Figure 2: The proposed strategy reduced supply air fan speed significantly

- Other air side control methods

Some other optimal control methods had also been applied to the system, such as robust supply air static pressure control for PAUs, optimal control of AHU supply air temperature, etc.

2.4. Water side optimal control methods

- Optimal control of the secondary water pumps

A cascade controller, as shown in Figure 3, is used to control the operating speeds of pumps distributing water to heat exchangers (fully open the control valves) instead of using the modulating valves while keeping a fixed differential pressure (Wang and Ma 2010). The fully opened valve in the cascade control minimizes the water loop resistance and therefore saves the energy of pumps. The test results proved good control reliability of the strategy as well as the annual energy saving up to 250,000 kWh.

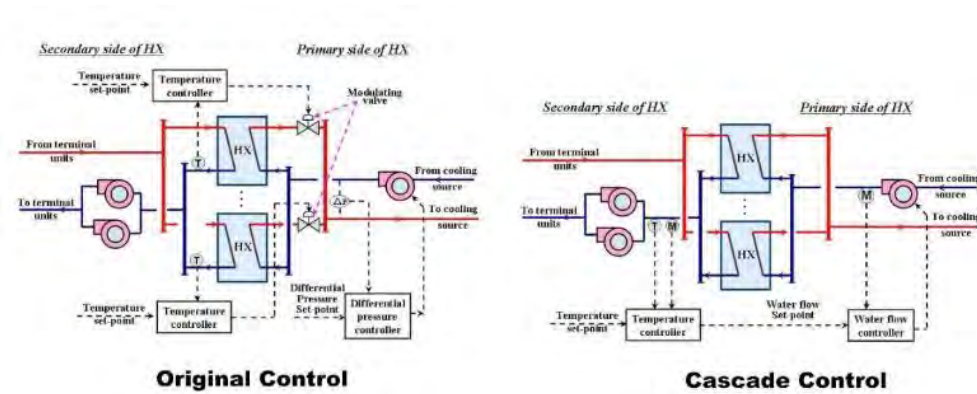

Figure 3: Comparison of the original control and the cascade control

2.5. Chiller plant optimal control methods

- Robust chiller sequencing control

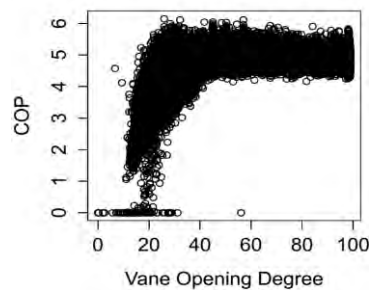

Figure 4: Van Opening is a robust indicator when chiller is of high COP

Chiller sequence control significantly affects the efficiency and operation stability of plants with multiple chillers. However, in real practice, the energy efficiency is commonly sacrificed to avoid uncertainties. Also, the strategies found in literature may be too complicated to be used practically. An effective and robust strategy for centrifugal chiller plants is therefore developed (Shan et al 2016). The strategy innovatively utilizes chillers inlet guide vane openings as the load, and more particularly the energy efficiency indicator (Figure 4). A validation of the use of such an indicator is conducted using the in situ measurements from the chiller plant in a high-rise building. The strategy is compared with two other commonly used strategies through tests. In the ideal condition (no measurement errors), the proposed strategy saves 3% of the energy comparing to the original strategy. When systematic errors exist in the cooling load measurements, energy performance of the plant is not affected when controlled by the proposed strategy.

- Optimal cooling tower control

Usually, the fixed approach control method and fixed set-point control method are used to determine the cooling water supply temperature set-point while the operating number of cooling towers is simply determined based on the operating number of chillers. The conventional method is hard to achieve energy saving under low partial load conditions.

A hybrid quick search method is developed and implemented to minimize the instantaneous total power consumption of the chillers and the cooling tower fans (Ma et al 2009). The required operating number of cooling towers and the water temperature entering the condensers are continuously reset based on the weather conditions and system working conditions. The method also uses a fuzzy approach to predict uncertainties in chiller and cooling tower models to enhance the accuracy of model predictions (Zhu et al 2013).

- Other optimized control strategies

Flow-limiting control for eliminating deficit flow, avoiding low delta-T syndrome and saving pump energy, chilled water supply temperature optimization (Ma and Wang 2009b), differential pressure set-point optimization in the secondary pumps (Ma and Wang 2009a).

3. CASE 2: A CLEAN ROOM FACTORY IN HONG KONG

Comparing with spaces air-conditioned for thermal comfort, cleanrooms often have special requirements on dry bulb temperature, relative humidity, static pressure, or air flow rates. It is a challenging task to achieve those requirements with minimum energy consumption, especially when different parameters interfere with each other. Specifically, the counteraction between cooling and heating often happens in the field, resulting in significant waste of energy.

A method was developed to solve this problem. The concept is to move dehumidification process into from AHU to PAU, so that no hardware modification is required. A trial test was conducted to evaluate the concept of the proposed method prior to detailed development of it. The heating system was all off during the entire test day, and the test started at around 11:00 in the morning. When the test started, the RH started to decrease and the DBT began increase but still within the required limitation. Figure 5 shows the progress in psychrometric chart. Although the progress is slow, the two parameters could be controlled within the required range without the use of heating during the trial test.

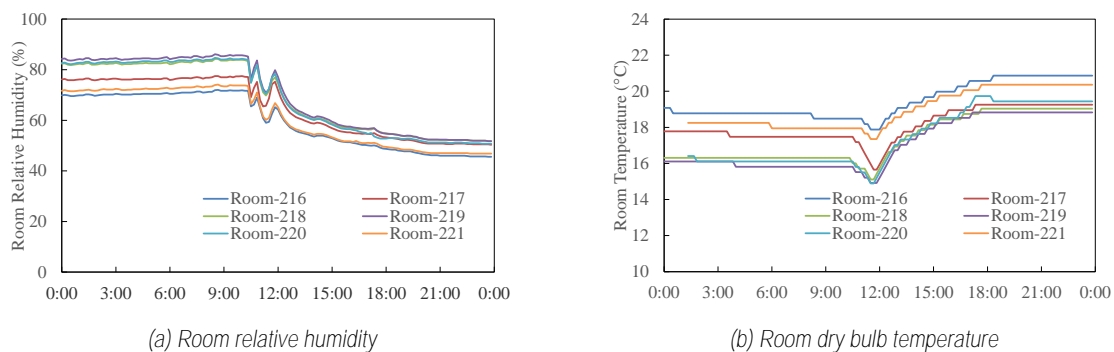

(a) Room relative humidity (b) Room dry bulb temperature
Figure 5: Trial test result of the proposed method to control room RH and DBT with no heating

The full control method was then developed and tested in an air side subsystem in the factory and compared with the original method used. The test was conducted when the ambient dry bulb temperature and relative humidity were 21.8 °C and 75.2%, respectively. Results indicated that the developed method saved 60.2 kW (74.4%) and 62.2 kW (89.8%) in cooling load and heating load, respectively. The annual energy saving was estimated to be about 40% (about 5 million HKD).

4. CASE 3: BUILDINGS IN A UNIVERSITY CAMPUS

We are also engaging in the campus (Hong Kong polytechnic University) energy saving programme to provide energy performance assessment and optimization. Phase 7 buildings being studied consists of a biology clean room lab which has strict requirements on humidity, temperature and air change rate. Great energy saving potential was identified during energy assessment. About 1.0 - 1.5 million kWh energy might be saved by changing the existing operation and control mode as variable speed control, while has no adverse impact on lab environment.

An other assessment on the electricity profile of one campus building indicate that cutting the power demand peaks (Figure 6) in very few hours (2 - 5 hours) in a month could achieve very significant electricity cost saving in certain buildings (up to 25% of demand charge and up to 5% of total building electricity cost).

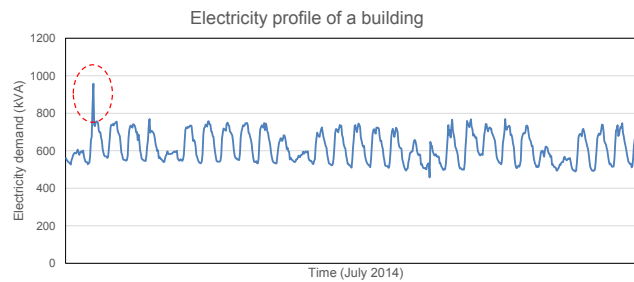

Figure 6: kVA profile in one month

5. SUMMARY

This paper provides a summary on the developed energy efficient optimal control methods and the actual energy benefits of implementing the optimal control strategies in real buildings over the last ten years. These control optimization methods cover most of sub-systems in commercial HVAC systems, as well as special indoor environment control systems for cleanrooms, industrial processes and underground stations, etc.

A set of optimal control methods have had been implemented in the tallest building in Hong Kong. The methods address almost all sub-systems of the large and complex air-conditioning system. According to the electricity bill, the methods applied in the building achieved an annual saving about ten million kWh.

By eliminating the counteraction between heating and cooling, the developed method for a clean room factory had significantly reduced cooling and heating load. The estimated annual energy saving is about 40% (about 5 million HKD).

The control methods are also being applied in several buildings in a campus. During the energy saving assessment stage, the saving potentials of the A/C systems in the buildings studied range between 15-30%. And there is also a potential in reducing electricity bill by cutting power demand peaks.

REFERENCES

- [1] Omer, A.M., 2008. Energy, environment and sustainable development, *Renewable and Sustainable Energy Reviews*, 12(9), 2265–2300.
- [2] Gao D.C., Wang S.W., and Sun Y.J., 2011. A fault-tolerant and energy efficient control strategy for primary–secondary chilled water systems in buildings. *Energy and buildings*. 43(12): 3646–3656.
- [3] Ma Z.J. and Wang S.W., 2009a. An optimal control strategy for complex building central chilled water systems for practical and real-time applications. *Building and Environment*, 44(6), 1188-1198.
- [4] Ma Z.J. and Wang S.W., 2009b. Energy efficient control of variable speed pumps in complex building central air-conditioning systems. *Energy and Buildings*, 41 (2), 197-205.
- [5] Ma Z.J., Wang S.W. and Xiao F., 2009. Online performance evaluation of alternative control strategies for building cooling water systems prior to in-situ implementation. *Applied Energy*, 86(5), 712-721.
- [6] Omer, A.M., 2008. Energy, environment and sustainable development, *Renewable and Sustainable Energy Reviews*, 12(9), 2265–2300.
- [7] Pérez-Lombard, L., Ortiz, J. and Pout, C., 2008. A review on buildings energy consumption information, *Energy and Buildings*, 40(3), 394–398.
- [8] Shan, K., Sun, Y., Wang, S., & Yan, C., 2012. Development and In-situ validation of a multi-zone demand-controlled ventilation strategy using a limited number of sensors. *Building and Environment*, 57, 28-37.
- [9] Shan, K., Wang, S., Gao, D., & Lee, S. W. S., 2015. In-situ validation of a fault tolerant control strategy for VAV systems. *Applied Thermal Engineering*, 87, 362-370.
- [10] Shan, K., Wang, S., Gao, D.-c., & Xiao, F., 2016. Development and validation of an effective and robust chiller sequence control strategy using data-driven models. *Automation in Construction*, 65, 78-85.
- [11] Wang S.W. and Ma Z.J., 2010. Control Strategies for Variable Speed Pumps in Super High-Rise Building. *ASHRAE Journal*. 52(7), 36–43.
- [12] Zhu, N., Shan, K., Wang, S., & Sun, Y., 2013. An optimal control strategy with enhanced robustness for air-conditioning systems considering model and measurement uncertainties. *Energy and Buildings*, 67, 540-550.

Interactive Building-User Systems for Positive Behavioral Change by Enhancing E-Participation of Building Occupants

ZHANG Qianning^a, Stephen LAU Siu-yu^b

^a National University of Singapore, Singapore, zqn2814@gmail.com

^b National University of Singapore, Singapore, akilssy@nus.edu.sg

ABSTRACT

The main deficiency with the Post-Occupancy Evaluation (POE) method discussed in this paper is that feedbacks collected are delayed and exert limited influence on the building being surveyed. Another drawback with this approach is that it fails to take the technological updates, such as ICTs, Web 2.0, big data, etc. into account due to the fact that the POE system is rooted from the 1980s but methods to carry out POE surveys remains almost same recently. Therefore, it is necessary to look beyond POEs and to promote direct e-participation of building users with regard to advanced ICT technologies.

Previous studies have figured out that user-led innovations with the purpose to deepen the level of user controllability of indoor environments are able to improve user perception of comfort and increase the quality of their daily life. The study presents a literature survey on how different factors influence human comfort in indoor environments with respect to user controllability. An app running on iOS and Android is introduced as a platform to display information, to make suggestions about actions can be taken, to collect feedback from users. The concept, the gap, challenges and determining factors of interactive building systems will be discussed.

Keywords: Human-oriented Buildings, Real-time buildings, Interactive building-user system, Behavioral change

1. INTRODUCTION

Post-Occupancy Evaluation (POE) has been applied as a systematic framework to evaluate the built environment according to responses of occupants in the buildings (Brand 1994), which indicated that POE surveys aimed to collect user responses at the operation stage and provide evidence-based design knowledges for the next generation of buildings. The main deficiency with this method is that feedbacks collected are delayed, sometimes simply ignored and exert limited influence on the building being surveyed. Another drawback with this approach is that it fails to take the technological updates, such as ICTs, Web 2.0, big data, etc. into account. The POE system is rooted from the 1980s and methods to carry out POE surveys are normally questionnaires, interviews, observations, recording, etc. (Preiser & Vischer 2005), which remains almost same recently. Meanwhile, conflicts among findings from POE surveys caused by various human behaviors or environment-related factors demonstrated the lack of universality, adaptability and flexibility. Therefore, it is necessary to look beyond POEs and to promote direct feedbacks of real-time, dynamic e-participation of building users with regard to advanced ICT technologies.

With the changing concept of green buildings, the green building rating systems have gradually evolved from tools for buildings to tools for humans. Previous studies has figured out that user-led innovations with the purpose to deepen the level of user controllability of indoor environments are able to improve user perception of comfort and increase the quality of their daily life (Frontczak & Wargocki 2011). Comfort could be enhanced in the perceived built environment by deeper user-building communication and user controllability of buildings.

2. LITERATURE REVIEW

The definition of Post-Occupancy Evaluation (POE) is given by Preiser in 1988 is "the process of evaluating buildings in a systematic and rigorous manner after they have been built and occupied for some time". Evidence gathered in POE is used to identify human-oriented design strategies and to provide feedback for further research, design and evaluation of green buildings (Gou 2012). Generally, the purpose of POE surveys is to test the appropriateness of a design approach, to offer an optimized spatial solution, to understand human perceptions of environment related behaviors, and to provide evidence-based knowledge of the effectiveness of approaches and investments in practice (Wolfgang Preiser 2002). The significance of POE is because of the gap and the fact that, firstly even all the requirements and demands of green building rating systems are met, not all occupants are

satisfied with the working environment (Humphreys 1994; Brager & Dear 1998; Heerwagen 2001; Zhao et al. 2016; Brager & Baker 2009; Gou et al. 2013); secondly, green building certification is a one-time activity, fine-tunings or major renovations of design decisions are given very few opportunities for buildings-in-use (Moezzi & Goins 2011); Moreover, POE surveys are significant to identify the adaptable ranges of comfort differs due to numerous factors such as hours worked per week, time pressure, job stress, psychosocial atmosphere at work, relationship with colleagues, job satisfaction, type of job, education level, pattern of coffee drinking, pattern of smoking, health, menstruation cycle, fitness, self-estimated environmental sensitivity, height and weight, gender, age and country of origin, etc.

However, among all the POE surveys, there are only two systematic POE studies concerning green buildings' occupants: one is the Occupant Indoor Environmental Quality (IEQ) Survey and Building Benchmarking by the Center for the Built Environment (CBE) at the University of California Berkeley in North America (Abbaszadeh et al. 2006); the other is the Post-occupancy Review of Buildings and their Engineering carried out by BUS (Building Uses Studies) Ltd. in the U.K. (Leaman & Bordass 2001).

Furthermore, since the intervention of POE surveys are post occupancy, these approaches are not related to architectural design stages of the buildings researched and information gathered from feedbacks are delayed and sometimes simply ignored. In fact, the building being surveyed is not able to react according to the results of user feedbacks. Complaints might de facto only be taken into consideration for further green buildings to some extent rather than influencing the building at the operation level. This traditional POE and feedbacks are too passive for building occupants to be directly involved. In addition, the link between POE researchers and architects is weak and the results from POE survey fail to get enough attention to guide design strategies (Hadjri & Crozier 2009).

3. DISCUSSION

3.1 The mechanism to encouraging pro-environmental behaviors

Socio-environmental psychology has gained notice by academia since the 1960s when environmental psychology and a variety of disciplines started to intervene in the research field of environmental behavior of human beings, seeking answers to questions such as **"are human behaviors predictable?"**, **"how do human behaviors change?"**, etc. However, findings from empirical research do not support the presupposition (Redcliff & Woodgate 1997) which hypothesized that behaviors were determined by environmental attitudes (Maloney & Ward 1973; Maloney et al. 1975), hence environment-related knowledge - attitudes - behaviors had a linear relationship. As a result, inconsistency between attitudes and behaviors has become one of the emergent focuses in academic research, directing at the relationship among other factors such as norms, values and external factors. In architecture, researches on user behaviors and behavioral changes at the building level has emerged as a new frontier due to the fact that user behaviors have impacts on building performance and addressing the interaction between human factors and green building systems are complementary with market-driven systems in search of sustainability (Kats et al. 2010).

The core of this discussion is the added value of human-oriented buildings, which indicates that the encouragement of **pro-environmental behaviors would not place a burden on occupants' reducing energy consumption** at the cost of less comfort. In addition to green building whose aims are to reduce loads and enhances efficiency, (Yudelson 2008), the concept of human-oriented buildings paves the way, through a holistic integrated approach, for sustainable development at the personal level (International WELL Building Institute 2016).

The study defines those with **pro-environmental behaviors as "green users"**. **How to create green users via behavioral changes** is one of the main research questions. The study proposes a model that one of the contributing factors for green buildings to create green users is a technology-enabled, human-building interaction platform (see Figure 1) based on a participatory mechanism of a e-platform of smart phones and a vote system. The preliminary interdisciplinary model of technology-enabled empowerment on the behavioral change of occupants proposes that behavioral change can be triggered by either the technology-enabled platform directly or via cognitional change triggered by a technological-enabled means. There is a substantial list of theories and models to reveal those contributing factors of environmental behaviors, including the Theory of Planned Behavior (Ajzen & Fishbein 1980), Responsible Environmental Behavior (Marcinkowski 1988; Hines et al. 1987), Value-Belief-Norm (VBN) Theory (Stern 2000), Multi-factor integration model (Bamberg & Möser 2007), Attitude-Behavior-Conditions (ABC) model (Guagnano et al. 1995), Context model for analyzing environmental consciousness and behavior (Brand 1997),

etc. Of these, the VBN theory was put forward by Stern in 2000 (Stern 2000) on the basis of the Norm-activation Theory, which claims that social norms could be converted into pro-social and pro-environmental behaviors of individuals only when it is personalized. The activation of individual norms is influenced by two factors: the awareness of the consequences of the action (AC), and the assumed responsibility for these consequences (AR). When AC and AR are high, individual norms will be activated, leading to the implementation of pro-environment behavior. VBN theory combined this idea with the Value Theory and the New Environmental Paradigm (NEP) in order to explain environment-related behaviors and how they are formed. The starting point of the VBN Theory is that generic values would activate individual norms, resulting in personal (environmental) responsibility through environmental 'beliefs' (NEP), recognizing the relationship between the outcomes of individual negative behaviors and the "beliefs" in reducing threats and consequences through behavioral changes. The VBN theory has been proven in many precedent studies (Nordlund & Garvill 2003; Å et al. 2006; Scherbaum et al. 2008). Other contributing factors to trigger green-intent behaviors are wider collaboration and engagement, design-driven strategies, incentive-driven strategies, etc. For example, in order to create green users, the WELL system (International WELL Building Institute 2016) highlights not only individuals, but more so employers. The concept behind WELL is that eventually it is people (employers) who is managing people (employees), as well as people's behaviors. That is why WELL tends to manage people (employers) who are administrators at the operation level of buildings. Similar trend and development can be noticed in the latest version of the Green Mark rating system where a Green Mark Pearl Award was launched in 2015 to encourage green promises from building owners and tenants.

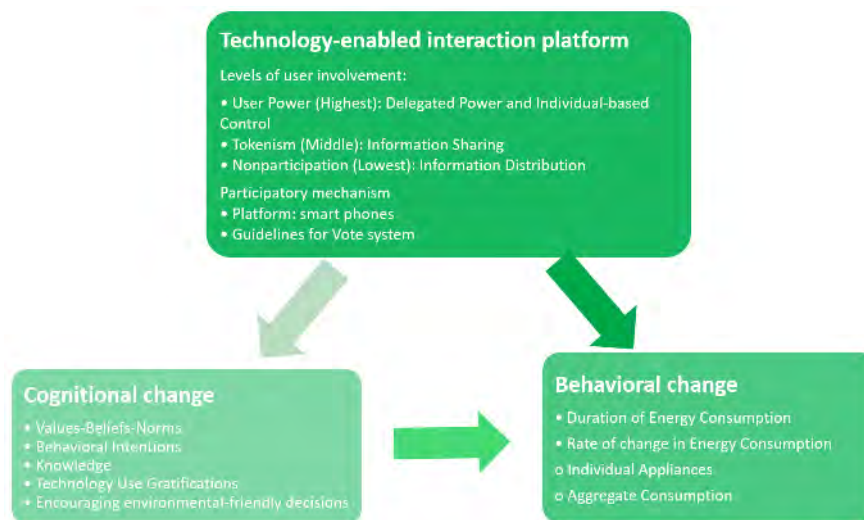

Figure 1: A preliminary interdisciplinary model of technology-enabled empowerment on the behavioral change of occupants

3.2 The “soft” (human-centric) challenges of environmental-responsive building

The shifts in the attention on the “soft” (human-centric) aspect in architectural design are due to the fact that human beings' understanding and cognition on environment, ecology, sustainability, human factors, etc. are subject to dynamic changes, and these thought waves influence green building as an evolving concept. According to a research on the financial benefits of green buildings (Kats et al. 2010), it is indicated that the main return of green buildings are the enhancement of productivity and health benefits. Since enhanced user satisfaction, comfort and productivity will contribute to increased economic benefit, addressing human factors in green buildings would lead to the motivation that drives the green market. Under this circumstance, attitude changes have been made in various building evaluation systems. However, green building certification is a one-time activity, fine-tunings or major renovations of design decisions are given very few opportunities for buildings-in-use (Moezzi & Goins 2011). **In response to the questioning of “How about buildings in use? How about user responses?” the concept of Post-occupancy evaluation (POE) was introduced.** Post-Occupancy Evaluation (POE) has been applied as a systematic framework to evaluate the built environment according to responses of occupants in buildings (Brand 1994), which indicated that POE surveys aimed to collect user responses at the operation stage and provide evidence-based design knowledge for the next generation of buildings. The main deficiency with this method is that feedbacks collected in the occupancy stage are delayed, sometimes simply ignored and exert limited influence on the building being surveyed. Another drawback with this approach is that it fails to take technological updates into account due to the fact that POE system is rooted from the 1980s and methods to perform POE surveys are normally

questionnaires, interviews, observations, recording, etc. (Preiser & Vischer 2005), which remain almost the same despite the advent of advanced technologies, such as Building Informatics and ICTs. The critique is that the POE paradigm barely changes its methodology and core concept. Another drawback of POE is that conflicts among findings from POE surveys widely exist due to varied human behaviors or diverged environment-related factors, **which demonstrated the lack of 'universality, adaptability and flexibility' as evidence-based design guidelines.** Therefore, it is necessary to look beyond POEs by promoting direct feedbacks and communication with real-time, dynamic e-participation of building users with regard to advanced ICT technologies. For example, the control center reacts instantly by switching ventilation modes in mixed-mode buildings, changing the room temperature, lighting levels, etc. as occupant vote system via mobile and real-time management are realized by collecting quantitative indications to realize human-building interaction. This vote informed real-time building is an active system, which is turning POE from a problem-finding process to a problem-solving process, i.e. to close the loop

Human-centric, or human-oriented is the same concept as people-oriented, which is defined as **"skilled at or focused on interaction with people" in the Oxford Dictionary.** Potentials of POE as an ideology and means for improving operational benefits lie on the evolved concept of POE surveys with the intervention of updated technologies with a promising human-building interactive scenario. Concerns of building occupants should be comprehensively collected, demonstrated, analyzed and discussed via interactive mechanism. Previous studies have figured out that user-led innovations with the purpose to deepen the level of user controllability of indoor environments are able to improve user perception of comfort and increase the quality of daily life (Frontczak & Wargocki 2011). Comfort could be enhanced in the perceived built environment by deeper user-building communication and user controllability of buildings.

3.3 The significance of user participation in architecture

The relationship between man and machine and how they could cooperate interactively to contribute to the welfare of humanity continues to be one of main and interdisciplinary topics and challenges of the new era. In building science, **"active" and "passive" have been endowed with different meanings under different contexts. For a building mechanism, passive design approaches and strategies taking advantages of natural resources and elements while an active system is employed with energy consumption (Tang 2013a; Tang 2013b). For occupants, when a building is "active", they are generally given limited or no controllability and adapt to the indoor environment "passively"; when the building is "passive", occupants have to respond "actively" to acclimatized with the indoor environment.** The proposed interactive scenario, a real-time building, aims to break the boundary between passive and active, **and to achieve a dynamic balance of "interactive" instead by the intervention of user e-participatory processes with interdependent individual-based control by users via Internet of Things (IoT) and ICTs.**

Citizen participation has been long and widely discussed in planning, public policy and public administration literature (Davidoff 1965; Arnstein 1969; Fagence 1977; Day 1997; Healey 2006; Forester 1999). The proposed study aims to apply the citizen participation theories at the urban scale in the occupant participation at the building level. Deduced from "public participation" (Cai 2010), **"occupant participation" for buildings-in-use** refers to building occupants involved in building operations and maintenance through direct interaction with building systems. Occupant participation is thus empowered by the interactive vote system introduced in the real-time mechanism. Similarly, occupant participation shall become one of the soft powers of green-intent and human-oriented buildings. **The Sherry Arnstein's "ladder" theory (Arnstein 1969) of public participation divides public participation into eight different steps within three levels from shallow to deep, i.e. non-participation (Manipulation, Therapy), tokenism (Consultation, Placation, Informing) and citizen power (Partnership, Delegated Power and Citizen control).** Traditional collective-based POE surveys are regarded as **"nonparticipation" in this research due to the fact that information from feedbacks are delayed, sometimes ignored, and even when the feedbacks contributes to the database of empirical evidences, the actions and updated design approaches do not have effects on the building being surveyed.** The proposed individual-based real-time buildings may reach the **"user power" level by empowering occupants to control specific buildings via the vote system.** Moreover, based on the Communicative Theory by Jurgen Habermas (Habermas & Habermas 1984), John Forester pointed out that in the process of a design process, designers widely ignored the key content, listening (Forester 1989). Vote system is such a platform that enables buildings to listen to their occupants and communicate directly. Recently, citizen participation theories are trying to adapt new technologies (Foth et al. 2009) such as e-planning and e-participation (Silva et al. 2013; Silva 2010).

The application of the participation theory as a research methodology is combined with the backcasting methodology and the POE methodology to promote user controllability via the direct vote system based on previous research outcomes that individual control of building occupants over the indoor environment has been proven to have a strong positive effect on the overall satisfaction with IEQ (Frontczak & Wargocki 2011), the acceptance of a wider range of conditions (Paciuk, 1990; Leaman and Bordass, 1993; Williams, 1995, de Dear and Brager, 2002) **and higher “forgiveness”** (Deuble & de Dear 2012). The forgiveness factor defined in the Building Use Studies Occupant Survey and Reporting Method (Leaman & Bordass 2001), is hypothesized to be a function of the power of control, constitutes an important aspect of the research. Employing participation theory in architecture could overcome one important barrier of POEs, that of inconsistencies and conflicts which present architects with a dilemma in making a choice (Frontczak & Wargocki 2011). These inconsistencies are caused by the size of surveyed samples to a certain extent. People are individually different but collectively same. However, 100 to 1,000 occupants can be regarded as an individual compared to the entire population. Thus, findings from occupants of **several buildings are more like opinions and perceptions from several “individuals” and they are “individually”** different. The intervention of direct user participation is to turn collective-based feedbacks into individual-based control in buildings at the operation level, and to let occupants speak for themselves.

4. CONCLUSION

User-led, real-time controllability communication and controllability enabled by networked building components with the changing roles of buildings, users and architects could lead to a wider range of perceived comfort and wellness of building users in built environments. Furthermore, levels of user involvement in building controllability, technology-enabled interaction platform, inclusive involvements and user trust are key contributing factors in the human-building interaction.

An app run on iOS and Android to display information, to make suggestions about actions can be taken, to collect feedback from users, is an elegant solution to meeting the goal. An advanced option is to integrate iBeacon to provide location information and help researchers in identifying where (which classroom/ studio/ office/ restroom and so on) the events occurred.

REFERENCES

- [1] Å, L.S., Dreijerink, L. & Abrahamse, W., 2006. Factors influencing the acceptability of energy policies : A test of VBN theory. , 25(2005), pp.415–425.
- [2] Abbaszadeh, S. et al., 2006. Occupant satisfaction with indoor environmental quality in green buildings. Center for the Built Environment.
- [3] Ajzen, I. & Fishbein, M., 1980. Understanding attitudes and predicting social behavior, Prentice-Hall.
- [4] Arnstein, S.R., 1969. A LADDER OF CITIZEN PARTICIPATION. Journal of the [1] American Institute of Planners, 35(4).
- [5] Bamberg, S. & Möser, G., 2007. Twenty years after Hines, Hungerford, and Tomera: A new meta-analysis of psycho-social determinants of pro-environmental behaviour . Journal of Environmental Psychology , 27(1), pp.14–25.
- [6] Brager, G. & Baker, L., 2009. Occupant satisfaction in mixed-mode buildings. Building Research & Information, 37(4), pp.369–380.
- [7] Brager, G.S. & Dear, R.J. De, 1998. Thermal adaptation in the built environment : a literature review. Energy and Buildings, 27, pp.83–96.
- [8] Brand, K.W., 1997. Environmental consciousness and behaviour: The greening of lifestyles. In The International Handbook of Environmental Sociology. Northampton.
- [9] Brand, S., 1994. How buildings learn : **what happens after they're built**, Viking.
- [10] Cai, D., 2010. Min zhu shi yi zhong xian dai sheng huo = Democracy is a modern life style, She hui ke xue wen xian chu ban she.
- [11] Davidoff, P., 1965. ADVOCACY AND PLURALISM IN PLANNING. Journal of the American Institute of Planners, 31(4), pp.331–338. Available at: <http://www.tandfonline.com/doi/abs/10.1080/01944366508978187> [Accessed October 1, 2016].
- [12] Day, D., 1997. Citizen Participation in the Planning Process: An Essentially Contested Concept? Journal of Planning Literature, 11(3).

- [13] Deuble, M.P. & de Dear, R.J., 2012. Green occupants for green buildings: The missing link? *Building and Environment*, 56, pp.21–27.
- [14] Fagence, M., 1977. *Citizen participation in planning*, Pergamon Press.
- [15] Forester, J., 1989. *Planning in the face of power*, University of California Press.
- [16] Forester, J., 1999. *The deliberative practitioner : encouraging participatory planning processes*, MIT Press.
- [17] Foth, M. et al., 2009. The Second Life of urban planning? Using NeoGeography tools for community engagement. *Journal of Location Based Services*, 3(2), pp.97–117.
- [18] Frontczak, M. & Wargocki, P., 2011. Literature survey on how different factors influence human comfort in indoor environments. *Building and Environment*, 46(4), pp.922–937.
- [19] Gou, Z., Prasad, D. & Lau, S.Y.S., 2013. Are green buildings more satisfactory and comfortable? *Habitat International*, 39, pp.156–161.
- [20] Guagnano, G.A., Stern, P.C. & Dietz, T., 1995. Influences on Attitude-Behavior Relationships: A Natural Experiment with Curbside Recycling . *Environment and Behavior* , 27(5), pp.699–718.
- [21] Habermas, J. & Habermas, J., 1984. *The theory of communicative action*, Beacon Press.
- [22] Hadjri, K. & Crozier, C., 2009. Post-occupancy evaluation: purpose, benefits and barriers. *Facilities*, 27(1/2), pp.21–33.
- [23] Healey, P., 2006. *Collaborative planning : shaping places in fragmented societies*, Palgrave Macmillan.
- [24] Heerwagen, J., 2001. Do Green Buildings Enhance the Well-being of Workers? *Environmental Design & Construction*, 3(4), pp.24–30.
- [25] Hines, J., Hungerford, H. & Tomera, A., 1987. Analysis and Synthesis of Research on Responsible Environmental Behavior: A Meta-Analysis . *The Journal of Environmental Education* , 18(2), pp.1–8.
- [26] Humphreys, R.M.A., 1994. An adaptive approach to the thermal comfort of office workers in North West Pakistan. *Renewable Energy*, 5(5–8), pp.985–992.
- [27] International WELL Building Institute, 2016. *WELL Building Standard v1 with May 2016 addenda*, New York.
- [28] Kats, G., Braman, J. & James, M. (Michael J., 2010. *Greening our built world : costs, benefits, and strategies*, Island Press.
- [29] Leaman, A. & Bordass, B., 2001. Assessing building performance in use 4: the Probe occupant surveys and their implications. *Building Research & Information*, 29(2), pp.129–143.
- [30] **Maloney, M.P. & Ward, M.P., 1973. Ecology: Let's hear from the people: An objective scale for the measurement of ecological attitudes and knowledge. *American Psychologist*, 28(7), pp.583–586.**
- [31] Maloney, M.P., Ward, M.P. & Braucht, G.N., 1975. A revised scale for the measurement of ecological attitudes and knowledge. *American Psychologist*, 30(7), pp.787–790.
- [32] Marcinkowski, T.J., 1988. An analysis of correlates and predictors of responsible environmental behavior.
- [33] Moezzi, M. & Goins, J., 2011. Text mining for occupant perspectives on the physical workplace. *Building Research & Information*, 39(2), pp.169–182.
- [34] Nordlund, A.M. & Garvill, J., 2003. Effects of values, problem awareness, and personal norm on willingness to reduce personal car use . *Journal of Environmental Psychology* , 23(4), pp.339–347.
- [35] Preiser, W.F.E. & Vischer, J., 2005. *Assessing building performance*, Elsevier.
- [36] Redclift, M.R. & Woodgate, G., 1997. *The international handbook of environmental sociology*, Edward Elgar.
- [37] Scherbaum, C.A., Popovich, P.M. & Finlinson, S., 2008. Exploring Individual-Level Factors Related to Employee Energy-Conservation Behaviors at Work . *Journal of Applied Social Psychology* , 38(3), pp.818–835.
- [38] Silva, C.N. et al., 2013. Open Source Urban Governance: Crowdsourcing, Neogeography, VGI, and Citizen Science. In *Citizen E-Participation in Urban Governance*. IGI Global, pp. 1–18.
- [39] Silva, C.N., 2010. The E-Planning Paradigm – Theory, Methods and Tools. In *Handbook of Research on E-Planning*. IGI Global, pp. 1–14.
- [40] Stern, P.C., 2000. Toward a Coherent Theory of Environmentally Significant Behavior. *Journal of Social Issues*, 56(3), pp.407–424.
- [41] Tang, C., 2013a. *Building Energy Efficiency Technical Guideline for Active Design*, Malaysia.: Published by the Building Sector Energy Efficiency Project (BSEEP).
- [42] Tang, C., 2013b. *Building Energy Efficiency Technical Guideline for Passive Design*, Malaysia: the Building Sector Energy Efficiency Project (BSEEP).
- [43] **Tom, S., 2008. *Managing Energy And Comfort: Don't Sacrifice Comfort When Managing Energy*. *ASHRAE Journal*, 50(6).**

- [44] Wolfgang Preiser, 2002. The Evolution of Post-Occupancy Evaluation: Toward Building Performance and Universal Design Evaluation. In Learning from Our Buildings. Washington, D.C.: National Academy Press.
- [1] Yudelson, J., 2008. The green building revolution, Island Press.
- [45] Zhao, J. et al., 2016. Occupant-oriented mixed-mode EnergyPlus predictive control simulation. Energy and Buildings, 117, pp.362–371.

Review on Demand Control Ventilation

ZHENG Caidan^a, WANG Yucheng^b

^a Chongqing University, Mainland China, 2585693012@qq.com

^b Chongqing University, Mainland China, 1184073638@qq.com

ABSTRACT

Demand-controlled ventilation (DCV) has become research hotspot in recent years with quality of the air inside building and associated energy use attracting increasing attention. Previous studies put insight into CO₂-based demand-controlled ventilation in which the CO₂ concentrate is used as a parameter indicating indoor air quality (IAQ). **It's questionable with respirable particulate matter (PM) being the primary pollutant in China. It's unscientific to introduce outdoor air in occupied space without comparing the air quality of indoor and outdoor.**

Thus a new strategy about DCV has been developed in which the control indexes are indoor VOC concentration, indoor PM concentration, indoor CO₂ concentration, indoor humiture, outdoor PM concentration and outdoor humiture. The set points of indoor control indexes comply with the requirements of IAQ and energy saving, because the closer between actual design ventilation and the ventilation required for good IAQ, the more energy saving. To implement the strategy, a direct digital control (DDC) along with the location of indoor sensors mounted in the return air duct and the outdoor sensors in the supply fresh air duct. The controller output is determined by comparing these measured concentration with corresponding set point. In this strategy, supply air value will be modulated for more outdoor air if the indoor concentration of VOC and CO₂ exceeds the set point. Especially, as indoor and outdoor PM concentration exceed the set point, other measurement, such as purifier, must be taken. This strategy offers great benefit in terms of IAQ, because it has considered the influence of outdoor pollutants to indoor.

Keywords: IAQ, demand control ventilation, control strategy, **pollutants' concentration**

1. INTRODUCTION

1.1 Indoor air quality

Indoor air quality (IAQ) is a term which refers to the air quality within and around buildings and structures, especially as it relates to the health and comfort of building occupants. IAQ can be affected by gases (including carbon monoxide, radon, volatile organic compounds), particulates, microbial contaminants (mold, bacteria), or any mass or energy stressor that can induce adverse health conditions. A major source of indoor air pollution in developing countries is the burning of biomass (e.g. wood, charcoal, dung, or crop residue) for heating and cooking. The resulting exposure to high levels of particulate matter resulted in between 1.5 million and 2 million deaths in 2000.

Human-generated indoor pollutants and building-generated indoor pollutants can be divided from various buildup pollutants which affected IAQ according to generation source. In non-industrial building, CO₂ levels severe as a proxy for building occupancy and the rate of human-generated indoor pollutants, since the only generation source of CO₂ is human indoor. Building-generated indoor pollutants refer to fumes from copiers and printers, out-gassing from building materials, carpets and furniture, and vapours from cleaning supplies.

1.2 Ventilation design

Two options are offered to maintaining adequate ventilation: the ventilation rate procedure and the indoor air quality (IAQ) procedure. The ventilation rate procedure uses the traditional prescriptive method, i.e. a minimum quantity of cfm per person based on maximum occupancy. In contrast, the IAQ procedure allows designers to vary outdoor air ventilation rate (from 0% to 100% of the design outdoor air) if the pollutant concentration remains below a recommended level.

The specific environment of the building and corresponding ventilation demand must be considered in the traditional ventilation design of HVAC. While the air supply rate is ensured at the beginning of design rather than make changes with the actual indoor personnel load and the actual demand of building, as a result of insufficient

ventilation or overdraft. It not only increase the energy consumption of building, but also cannot ensure IAQ. Similarly, the outdoor flow rate in most of air conditioning system are according to the standards or people number.

The addition of the IAQ procedure to the standard allows for demand control ventilation (DCV) in buildings. If a DCV strategy needs less outdoor air in the heating and cooling seasons than dose the traditional prescriptive method, then the annual energy required to heat or cool decreases. In addition, lower flow rate decreases the fan energy spend on introducing and transporting the air through building. Available data suggest that DCV reduces ventilation, heating, and cooling loads by 10% to 30%. Buildings and spaces with large swings in occupancy, e.g., movie theatres and conference rooms, tend to realize the largest savings. It can save almost 60% energy consumption if the fresh air can vary from the minimum to entire outdoor airflow rate especially in the transition season, and the cooling capacity utilizing variable air volume can be less 20% than constant air volume during all year.

In the following paper, author will describe research status and resisting problems of DCV, then present a novel strategy based on the research findings of previous studies.

2. RESEARCH STATUS

2.1 Literature review

There are 19 test indexes about IAQ covering the physical, chemical, biological, radiological aspects. Temperature, relative humidity, airflow rate are included in physical indexes, while the rest about health are shown in the *Table 1*. To control these contaminants in the limit value is the requirement of good IAQ, while the first investment and maintaining fees will increase sharply because various sensors and control strategy are needed. Persily has studied the relation between CO₂ level and IAQ, proving that the CO₂ concentration can be used as a parameter indicating IAQ.

Parameter type	Number	Species	Reference value	Note
Chemical	1	SO ₂ (mg/m ³)	0.5	1h mean value
	2	NO ₂ (mg/m ³)	0.24	1h mean value
	3	CO(mg/m ³)	10	1h mean value
	4	CO ₂ (%)	0.1	Day mean value
	5	NH ₃ (mg/m ³)	0.2	1h mean value
	6	O ₃ (mg/m ³)	0.16	1h mean value
	7	HCHO(mg/m ³)	0.1	1h mean value
	8	C ₆ H ₆ (mg/m ³)	0.11	1h mean value
	9	C ₇ H ₈ (mg/m ³)	0.2	1h mean value
	10	C ₈ H ₁₀ (mg/m ³)	0.2	1h mean value
	11	B(a)P(mg/m ³)	1	Day mean value
	12	PM10(mg/m ³)	0.15	Day mean value
	13	TVOC(mg/m ³)	0.6	8h mean value
Biological	14	Colonies number (cfu/m ³)	2500	Instrument measurement
Radiological	15	Rn (Bq/m ³)	400	Year mean value

Table1. IAQ control indexes about health

CO₂ concentration in outdoor airflow is lower than occupied space indoor in common situation, so that outdoor airflow dilutes indoor pollutants and enhances IAQ in air-conditioned zones. From this aspect, a high outdoor should be maintained. However extra outdoor airflow requires extra energy for hanging it. From this aspect of energy consumption, a low outdoor airflow is preferred. In orde to compromise the requirement of acceptable IAQ and energy savings, outdoor air flow in an air-conditioning system should be properly controlled. Then, how to control the CO₂ concentration in limit values with the least outdoor airflow rate, as well as CO₂-DCV, is critical. In most cases, the CO₂-DCV strategy is applied by detecting the CO₂ contrentration in return air or based on flow rate per person. In the first condition, it may result in poor air quality inside certain zones in a multi-zone building.

To solve the poor air quality in a multi-zone building, many scholars have made great efforts. Nabil Nassif proposes a robust CO₂-based DCV strategy to maintain the CO₂ concentration in supply air a low enough to meet the new ventilation requirements of ASHRAE Standard 62.1 2010 in all zones and improve energy efficiency, and provides insight into the performance of a typical VAV system under different operating and ventilation requirement conditions, as shown in Figure 1. The results show that it can save 23% energy consumption compared to the traditional design, and the saving will be lower as the actual occupancy is getting closer to the design value.

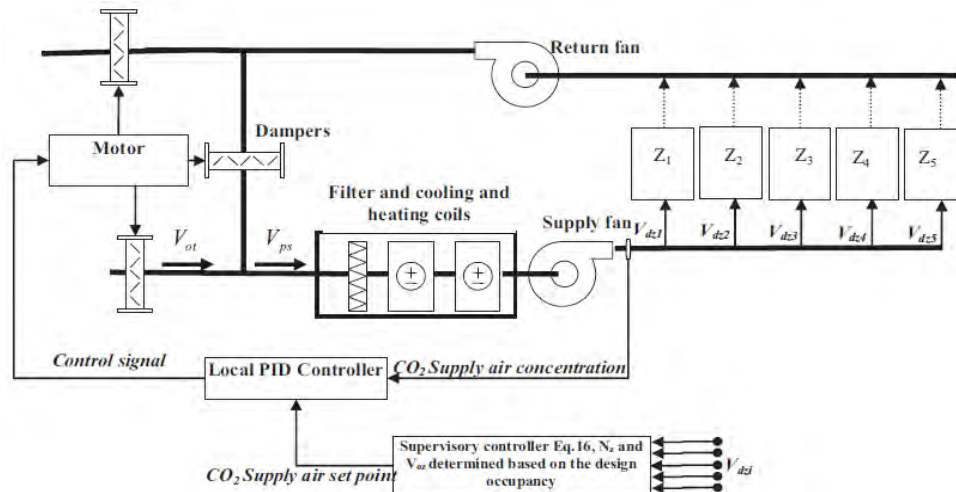

Figure 1. Control strategy with a typical VAV system

Tao Lu, Xiaoshu Lü, Martti Viljanen have presented a novel and dynamic control strategy for hourly scheduled buildings which utilized schedules by setting a base ventilation rate for unoccupied periods and calculating ventilation rate dynamically at each occupied period by solving the CO₂ mass balance equation to keep indoor CO₂ near the set point during the occupied period, as shown in Figure 2. The result proves that it can save about +26% of energy related to ventilation air compared to proportional control.

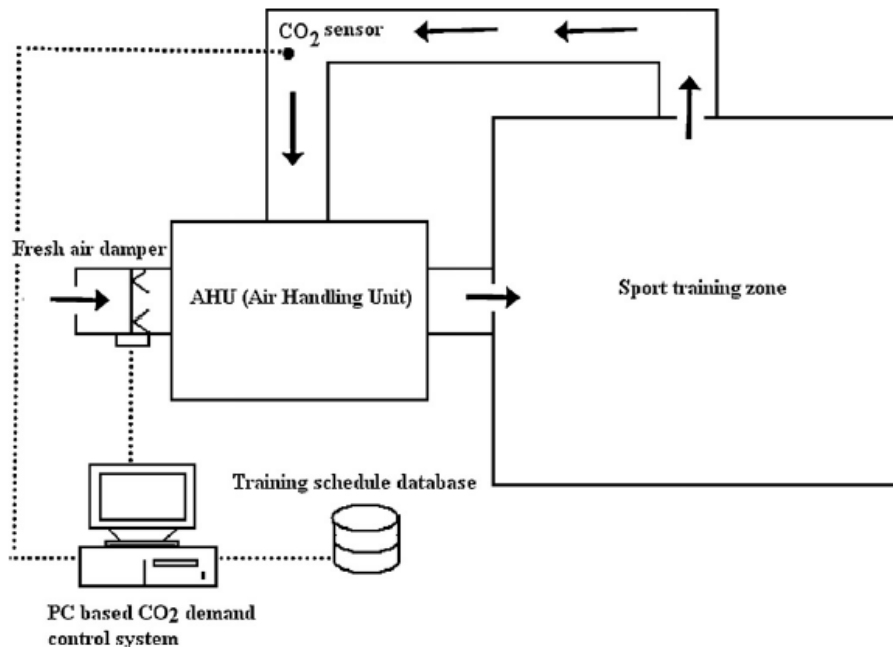

Figure 2. New strategy of DCV-CO₂

As mentioned above, the CO₂-DCV strategies have proved effective. While these strategies require many sensors. In a large building, the number of CO₂ sensors and flowmeters needed could be huge. That may significantly increase the initial investment considering the price of the sensors and meters as well as the cost for installation, maintenance and integration into a building management system. Kui Shan, etc presents a new strategy using a limited number of sensors for (DCV) of multi-zone office buildings.

As we know, the control algorithm affects directly the quality of the control system as well as the success or failure of the whole system. In CO₂-DCV system, proportional, exponential controls and genetic algorithms are the most discussed and popular ones among control algorithm. In terms of proportional and exponential controls, both approaches modulate ventilation between a lower set point of indoor CO₂ and an upper set point that represents the equilibrium concentration of CO₂ corresponding to the target per-person ventilation rate of a space, the difference between two lies in the modulation of ventilation rate which is proportionally for proportional control but exponentially for exponential control. Exponential control is able to adjust ventilation rate more quickly to changes in CO₂ concentration by using a standard proportional-plus-integral (PI) or proportional-integral-derivative (PID) control algorithm. From the energy conservation point of view, exponential control adds little additional benefit compared to proportional control generally. Congradac and Kulic set genetic algorithms to optimize the return damper position such that indoor CO₂ concentration can be kept close to the desired level as possible and at the same time the lowest value of the valve (the lowest energetic use) can be accomplished.

2.2 Existing problems

CAI Kun presented three mainly reasons by investigation and study which cannot get extensive application of CO₂-DCV: 1) it cannot reflect the air volume requirement of building-generated indoor pollutants, 2) it will result in energy waste that inaccuracy in control leads to over-ventilation, 3) it is too expensive about sensor maintenance and calibration. Steven has present multi-parameter DCV strategy to control the concentrations of TVOC, PM, CH₄, and relative humidity. So it must maintain lower air volume rate at low concentration of CO₂. While in this condition, **it must add sensors to detect other parameter's concentration.**

In practice, the design ventilation rate is calculated based on the assumption of a CO₂ equilibrium condition (steady state) and occupant density that might be different from actual one, which could distance indoor CO₂ concentration from the CO₂ set point. While the potential energy saving is affected by the factor how closely the actual design ventilation rate achieves the ventilation required for the actual occupancy in the space.

So far, all strategies are operated under the assumption that it's enough clean for outdoor air, while with the economic development, concentrations of some contaminants in outdoor air, such as particulate matter (PM), SO₂ and NO₂ are higher than indoor air. In practice, introducing outdoor air only decrease the large PM concentration, e.g. PM₁₀ rather than PM_{2.5} by low efficient filter. So, it's necessary to make compare between indoor and outdoor air, then design control strategy to maintain IAQ.

3. NEW STRATEGY ABOUT DCV

3.1 Control indexes

In recent studies, VOC is the major factor of sick building syndrome (SBS) so that the VOC can represent the building-generated indoor pollutants. As mentioned above, IAQ control indexes can be VOC concentration, CO₂ concentration, humidity. As for office and residential building, outdoor PM is the main source of indoor. So PM concentration and humidity outdoor must be tested. So the control indexes are indoor VOC concentration, indoor PM concentration, indoor CO₂ concentration, indoor humidity, outdoor PM concentration and outdoor humidity.

The set point of control indexes must comply with the requirements of IAQ and energy saving. The closer between actual design ventilation and the ventilation required for good IAQ, the more energy **can we saving. It's worth to study in making the limit value of control indexes' concentrations. These limit values are Refer to Table 1.**

3.2 Implication of strategy

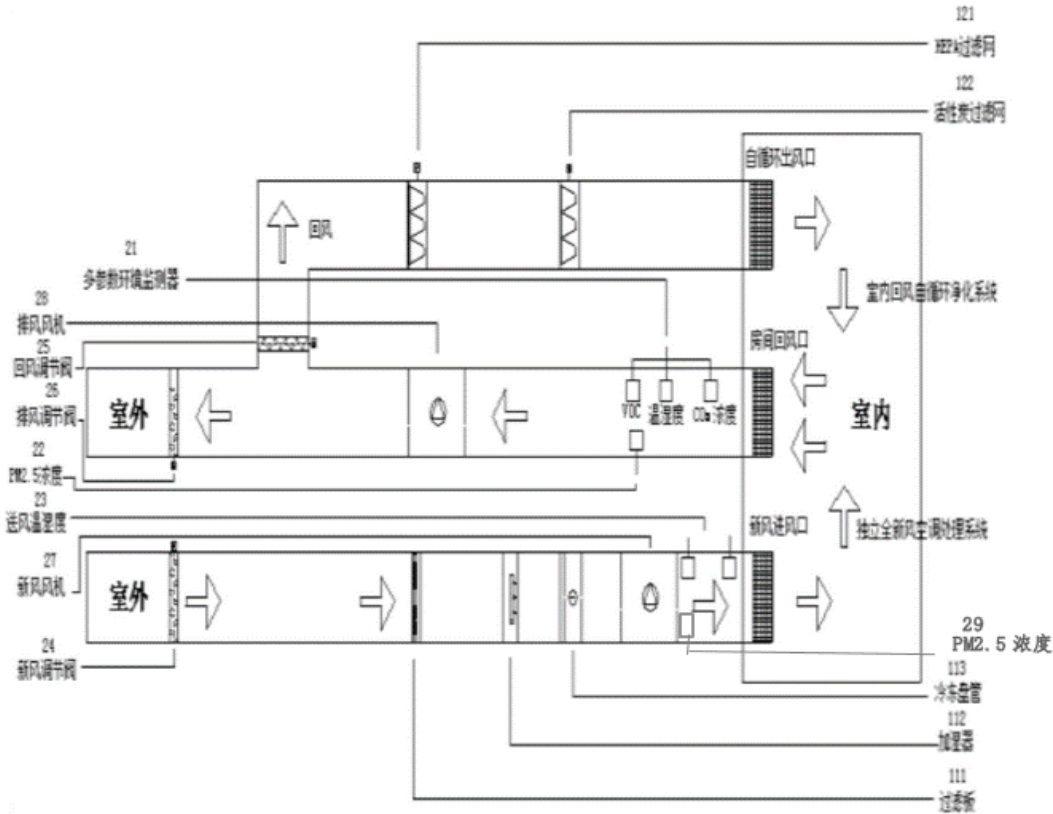

Figure 3. Implication of strategy

As shown in Figure 3, the location of indoor CO₂ sensor, PM sensor, VOC sensor and humidity sensor can be mounted in the return air duct, while the outdoor PM sensor and humidity sensor in the supply fresh air duct. To implement the strategy, a direct digital control (DDC) along with these sensors should be installed. The controller output is determined by comparing these measured concentration with corresponding set point.

The control flow chat is as shown in Figure 4. As we know, the humidity mainly to control the return water temperature as well as the air-conditioning's mainframe. **The humidity control is no longer illustrated on the flow chat, to highlight the DCV's requirement. The set point of CO₂ and VOC are consulted about the IAQ standard as mentioned above.** In this flowchart, PM_{in} is the indoor PM concentration, PM_{out} is the outdoor PM concentration. While PM is composed of different size particles, e.g. PM10 and PM2.5, PM10 is specified in the standard rather than PM2.5. In recent years, PM2.5 has been found that it is harmful for personal health. So set point of PM_{in} is subjected for further discussion and research.

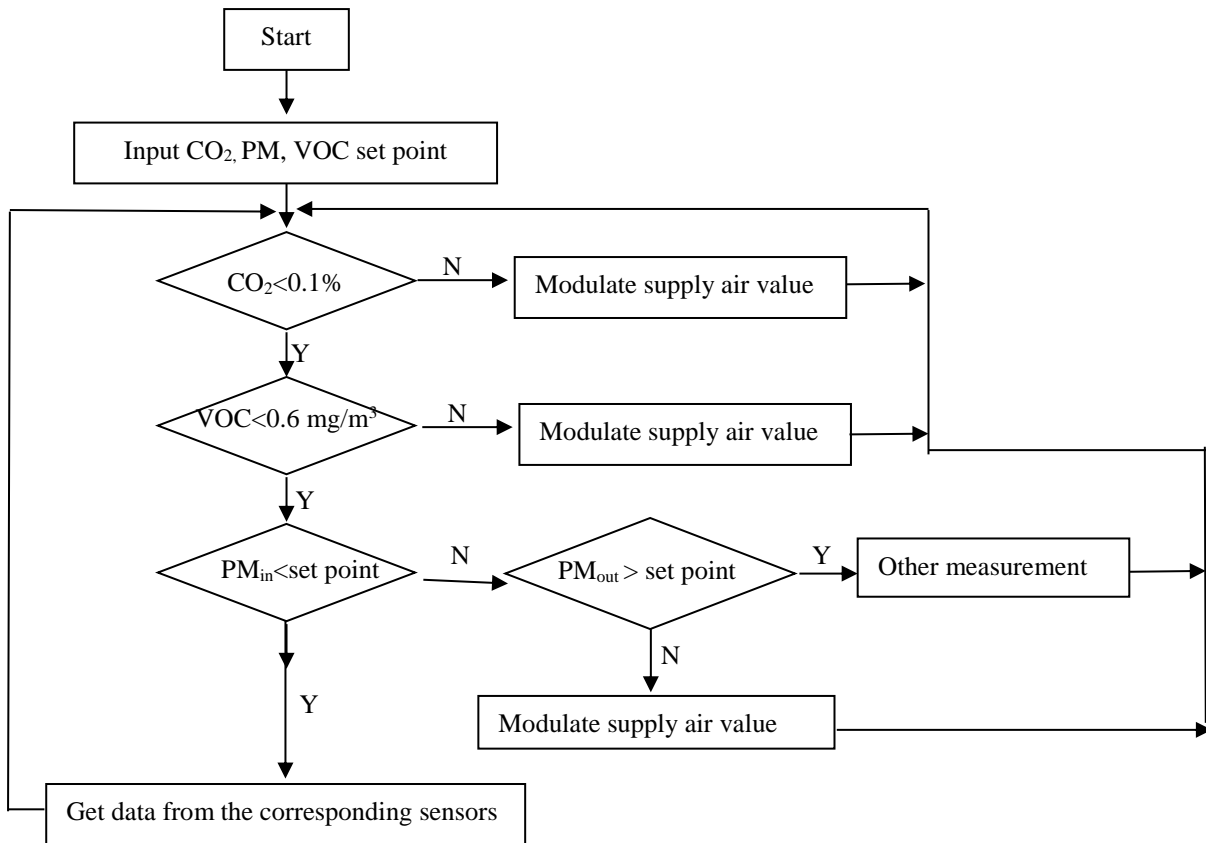

Figure 4. Control flow chart

It is easy to reason out that the relationship between PM_{out} , PM_{in} , PM_{set} has 6 situations: 1) $PM_{out} > PM_{in} > PM_{set}$, 2) $PM_{out} > PM_{set} > PM_{in}$, 3) $PM_{set} > PM_{out} > PM_{in}$, 4) $PM_{set} > PM_{in} > PM_{out}$, 5) $PM_{in} > PM_{set} > PM_{out}$, 6) $PM_{in} > PM_{out} > PM_{set}$. The 2) 3) 4) situations are the desired result after processing. The 1) 6) situations mean that the indoor and outdoor PM concentrations exceed the limit value, which is not conformity with the requirements. The outdoor air supply system may operate with the requirement of concentration of CO_2 , VOC below corresponding limit value, so the PM pollutant cannot be diluted because transports from atmosphere to buildings. Other measurement, e.g. purifier, must be operated to control the PM concentration under set point. The 5) situation means that the outdoor air supply system is required to decrease the concentration of PM.

3.3 Summary

The strategy presented above is based on the assumption that the data detected by sensor is accurate and **effective**. However, it's difficult to achieve higher precision with development of sensor technology at present. It is necessary to develop a new type of sensor for measuring the concentration of VOC, PM and other pollutants.

Single factor analysis is made for various pollutants with the consideration that they don't effect each other. However, the various pollutants are mutually influenced in fact, and the impact on the human has not been analyze completely. The comprehensive index of air pollution needs to be further studied.

The strategy are based on the requirement of IAQ rather than energy saving, so the set point of pollutants is need to be discussed.

REFERENCES

- [1] Esther Duflo, Michael Greenstone and Rema Hanna. Indoor air pollution, health and economic well-being. *Surveys and Perspectives Integrating Environment & Society*, 2008,1(1):61-71.
- [2] Majid Ezzati and Daniel M Kammen. The health impacts of exposure to indoor air pollution from solid fuels in developing countries: knowledge, gaps, and data needs. *Environmental Health Perspectives*, 2002, 110(11):1057-1068.
- [3] HE Da-si, TONG Shan-zhong, FAN Xiao-wei. Simulation of CO₂-based Outdoor Air Rates Control in a Council-chamber. *Building Energy&Environment*, 2009, 28(2):80-82.
- [4] ANSI/ASHRAE Standard 62-2001, Ventilation for Acceptable Indoor Air quality.
- [5] Roth Kurt W, Dieckmann John, Brodrick James. Demand control ventilation. *ASHRAE Journal*, 2003, 45(7):91-92.
- [6] Schell M, S.C. Turner, and R.O. Shim. Application of CO₂-based demand-controlled ventilation using ASHRAE Standard 62: optimizing energy use and ventilation. *ASHRAE Transactions*, 1998, 104(2):1213-1225.
- [7] DAI Zi-zhu. Air-conditioning of indoor air quality and ventilation. *Chinese Journal of Public Health Engineering*, 2002, 1(1):54-56.
- [8] GB/T 18883-2002, Indoor Air Quality STANDARD.
- [9] Persily AK. Evaluating building IAQ and ventilation with indoor Carbon Dioxide. *ASHRAE Trans* 1997, 103:193-204.
- [10] Nabil Nassif. A robust CO₂-based demand-controlled ventilation control strategy for multi-zone HVAC systems. *Energy and Buildings*, 2012, 45:72-81.
- [11] Tao Lu, Xiaoshu Lü, Martti Viljanen. A novel and dynamic demand-controlled ventilation strategy for CO₂ control and energy saving in buildings. *Energy and Buildings*, 2011, 43: 2499-2508.
- [12] Kui Shan, Yongjun Sun, Shengwei Wang, Chengchu Yan. Development and In-situ validation of a multi-zone demand-controlled ventilation strategy using a limited number of sensors. *Building and Environment*, 2012, 57:28-37.
- [13] V. Congradac, F. Kulic, HVAC system optimization with CO₂ concentration control using genetic algorithms, *Energy and Buildings* 2009, 41, 571–577.
- [14] CAI Kun. Review on the Demand Control Ventilation in Air Conditioning Systems. *Contamination Control & Air-Conditioning Technology*, 2013, 1: 19-21.
- [15] Steven J Emmerich, Andrew K Persily, State-of-the-Art Review of CO₂ Demand Controlled Ventilation Technology and Application. NISTIR 6729, 2001.
- [16] ASHARE. Technical guide for ground source heat pump engineering, 2001.
- [17] WEN Yuan-gao. Correlation between Outdoor and Indoor Air Pollutants. Shanghai Jiao Tong University, 2008.

Session 7.3: Smart Initiatives in SBE (3)

Using Advance Thermodynamics and Online Big Data Analytics to Maximize the Chiller Plant Performance

Rafael NAVARRO^a, Glen ANDERSON^b

^a ETC Group, Macau SAR, rafaelnavarrobarraza@gmail.com

^b ETC Group, Macau SAR, ganderson@etcgrp.com

ABSTRACT

It comes as no surprise; chillers are often the largest consumer of power in a building, accounting for 15-30% electric use. Just because a chiller is operating, does not mean it is efficient. Most chillers do not function efficiently resulting in higher energy costs and increased CO₂ emissions. Building owners looking for ways to better operate their facilities are paying more attention to their chillers.

This paper examines how advanced thermodynamic monitoring combined with big data analytics has advanced chiller plant performance in commercial buildings. This new Online Chiller Performance Evaluation technology (OCPE) supports high-performance buildings through accurate thermodynamic evaluation of chiller operation. This paper is based on real-world OCPE cases and will show:

- The typical % of savings achieved in chillers installed in commercial buildings such as clinics, hospitals and offices.
- The most common saving opportunities identified with the technology.
- The Return on Investment (ROI) of applying the OCPE technology.

This document also explains the importance of independent chiller performance monitoring, and defines the typical architecture (hardware, software and network) of an online OCPE system, its integration with an existing BMS, the involved cybersecurity concerns and how to overcome them. Finally, it explains the next steps of this technology towards Dynamic Chiller Performance Optimization: DChPO, that will lead to the next generation of high-performance Buildings.

Keywords: high-performance building, energy saving, smart building

1. INTRODUCTION

Air Conditioning (AC) systems are a central focus in the climate change challenge, as they play a double role in the problem. On one hand, AC systems have become a basic need, not only for developed countries, but also for the rest of world. To mitigating rising global temperatures, air conditioning systems have become necessary to keep adequate conditions for occupants of both residential and office environments.

On the other hand, AC systems are energy intensive, meaning they consume large amounts of energy over their lifetime, until the point that the acquisition cost is sometimes 5 to 20% of the net present value (NPV) of the energy consumption. It is important to note that AC systems are, by far in residential and commercial sectors, the highest energy consumer.

In much of the world, increase in energy demand occurs among the developing non-OECD (Organization for Economic Cooperation and Development) nations, where strong economic growth and expanding populations lead the increase in world energy use. Non-OECD demand for energy is expected to rise by 71% from 2012 to 2040. In contrast, more mature energy-consuming and slower growing OECD economies, total energy use is expected to rise by only 18% from 2012 to 2040 (U.S. EIA, 2016).

Multi-country studies of the effects of urbanization on energy use have shown two opposing effects: improvements in energy using equipment (e.g. air conditioning units) associated with an urban lifestyle increase efficiency, but higher numbers of households and increased penetration of air conditioning increase overall energy use (U.S. EIA, 2016).

It is evident that AC systems, specifically large units like those served by chiller plants, are suitable for optimization. The optimization process is not easy. This paper details a real-case of chiller plant optimization project, improving energy efficiency, by applying advanced thermodynamics and data analytics. This document also presents the identified improvements of the Online Chiller Performance Evaluation (OCPE), which is a commercially-available technology (but still unknown) and its next steps.

1.1 Barriers to chiller plant optimization

Chillers (unlike electric motors, engines, pumps, etc.) are susceptible to inefficiency since they are composed of many sub-components that transform energy from different sources (not only electricity) to several services (generally cooling and in some cases heating, when heat recovery processes are part of the equation). Chiller plants, comprised of at least one chiller, cooling tower (and/or heat exchanger) and pipelines, have even more complex sequences of operations than chillers alone and are more prone to inefficiency.

Chiller plant optimization requires understanding of electricity conversion, turbomachinery, refrigeration cycle, thermodynamics and advanced thermodynamics, and psychometrics. Knowledge of statistics is also required in order to convert large amounts of data into actionable information to support the decision-making process.

As can be expected, this intricacy leads to several challenges that need to be identified in order to undertake an optimization process on chiller plants. These barriers to Chiller Plant Optimization are:

- Lack of specialised professionals:

Given the technical background required to understand the chiller plants, its optimization process implies a specialized understanding of several diverse study fields, postgraduate studies and operational experience which are required before undertaking a chiller plant optimization project, or even a simple performance evaluation.

- A business model focused on reliability rather than efficiency:

Due to requirements for continuous operation, chiller manufacturers (and owners and facility managers) are more concerned with reliability and longevity rather than efficiency.

In addition, it is common to find that manufacturer staff (post-sales professionals) are more knowledgeable on **chiller's design specifications rather than with the complexities of chiller performance evaluation or optimization** process. In this regard, it is possible that the business model (manufacturer/owner) fosters a conflict of interest, as chiller optimization might show evidence of poor chiller performance and with current chiller capacity capable of future cooling demands thus negating new equipment purchase.

- Lack of a comprehensive method and tools:

As was presented above, chiller plant performance is complex and multivariable, depending on the following variables: outside air temperature (OAT), outside air relative humidity (OARH), condenser entering water temperature (CEWT), condenser entering water flow (CEWF), evaporator entering water temperature (EEWT), evaporator entering water flow (EEWF), refrigerant charge (RefCh), compressor isentropic efficiency (CompIE), Power Factor (PF), voltage (Volt), workload (WL), sequence of operation (SOO), chilled water set point (CWSP) and chilled water inertia.

As such, chiller plant optimization requires a well-structured method that takes into account all variables. Usually, chiller controller (control system) only considers half of these variables, those that are easy to measure and critical for chiller reliability.

1.2 Online chiller performance evaluation technology

To facilitate insight into chiller plant operation, an "Internal Method" was developed which offers a cost-effective way to determine overall performance with detailed component level information (Berglöf, 2013).

This Internal Method helps overcome barriers to Chiller Plant Optimization, as it incorporates several types of analysis to evaluate chiller performance. It is a huge advance providing for thorough performance evaluation.

The advantage with the Internal Method is that it is based on thermodynamic analysis of the refrigeration process. Additionally, it does not require any pre-installed sensors and can often be installed without stopping the compressors (brief interruption may be needed when opening the electrical housing to connect current clamps). Figure 1 shows sensor locations and how they are linked to the refrigeration cycle.

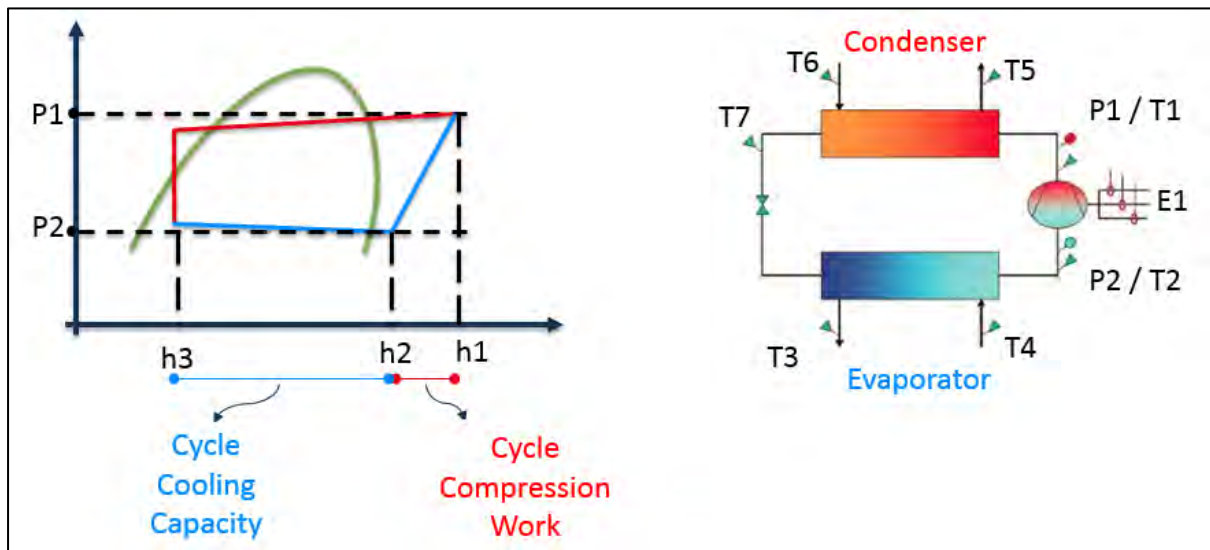

Figure 1: Location of "Internal Method" sensor and their equivalence on refrigeration cycle

The following are typical sensor locations: Pressure of Refrigerant in the Condenser (P1), Pressure of Refrigerant in Evaporator (P2), Temp. of Refrigerant at leaving compressor (T1), Temp. of Refrigerant at entering compressor (T2), Temp. of Chilled Water pipe at leaving the Evaporator (T3), Temp. of Chilled Water pipe at entering the Evaporator (T4), Temperature of Cooling Water at leaving the Condenser (T5), Temperature of Cooling Water at entering the Condenser (T6), Temperature of entering pipe to expansion valve (T7), and Power Demand of Chiller Compressor (E1).

This method is based on well-defined properties of the refrigeration cycle and reduces measuring errors while generating information about dynamic systems that cannot be achieved using other methods. It accurately **determines a working system's (Berglöf, 2013):**

- Coefficient of performance ($\pm 5\%$)
- Cooling and heating capacity ($\pm 7\%$)
- Power input ($\pm 2\%$)
- Compressor isentropic efficiency

As the method has been successful, specialised software and hardware has been developed to increase productivity and accuracy where a portable unit can be installed on almost any chiller and connected to the Internet for multiple purposes: big data analysis, monitoring and remote assistance. The method (patented in 1986 and commercialised since 1990) has a large database of chiller models and refrigeration cycles that support analysis and deliver insightful results.

These advances have led to Online Chiller Performance Evaluation technology (OCPE) which can be integrated with controls systems for chiller plant optimisation and consequently better building efficiency.

Since 2004, hardware and software were developed in a cost-efficient way to allow the method deployment and **commercialization to "early adopters" (via a few specialized consultants and technology providers), however the large majority of the market potential is far away of being reached.**

2. CASE DESCRIPTION

This paper is based on a real-world success case of a chiller plant evaluation developed in 2016. Findings are supported by 16 chiller plant evaluations and optimizations conducted on hospitals, medical centres, manufacturing plants, universities and supermarkets conducted in USA, China and South America.

The project-host company is located in Suzhou (China) while the energy consulting company (contractor) is located in Macau SAR, China with headquarters in UTAH, USA.

The project-host company plans to expand its operation which is composed by production buildings, administrative offices and other facilities where air conditioning is required.

The air conditioning system is composed of a central chiller plant (ChP) a chilled-water distribution system and 25 air handler units (AHUs).

Due to the host company's commitment to sustainability, the chiller plant optimization project was started. This paper uses this chiller plant optimization study to illustrate the OCPE technology.

2.1 Chiller plant description

The existing central chiller plant has two 500 ton Trane chillers. Figure 2 shows the ChP schematic.

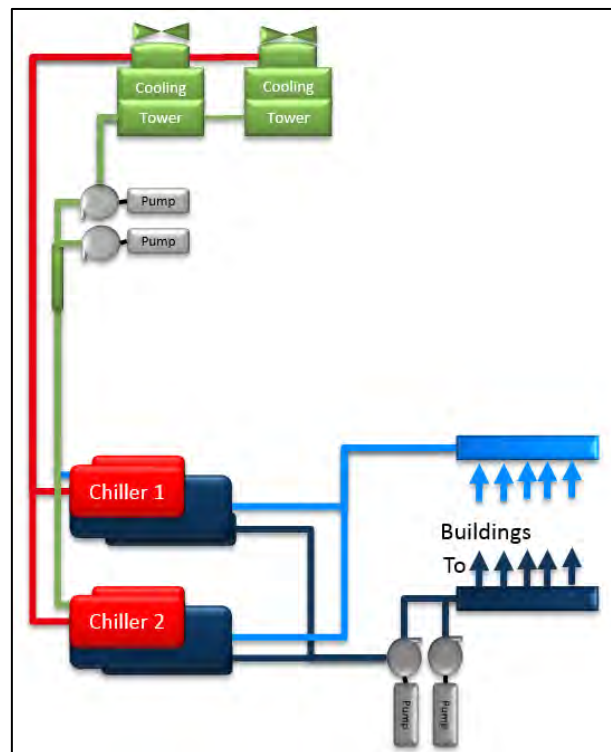

Figure 2: Chiller plant schematic

There is a plate and frame heat exchanger used for water side economization. The primary only chilled water plant has two chilled water pumps with Variable Speed Drive (VFD). The condensing water side of the plant has two condenser water pumps with VFDs and two counter flow cooling towers with VFDs fans.

As the production plant is being expanded to increase production a new 400-RT chiller was budgeted for 2017.

2.2 Installation of OCPE unit

The OCPE technology was developed in two formats: portable unit and permanent installation. In this case, a portable unit was installed due to budget limitations. Figure 3 depicts how the portable unit is connected to the chiller plant to gather the data for analysis. The Appendix A shows more detail about sensor placement.

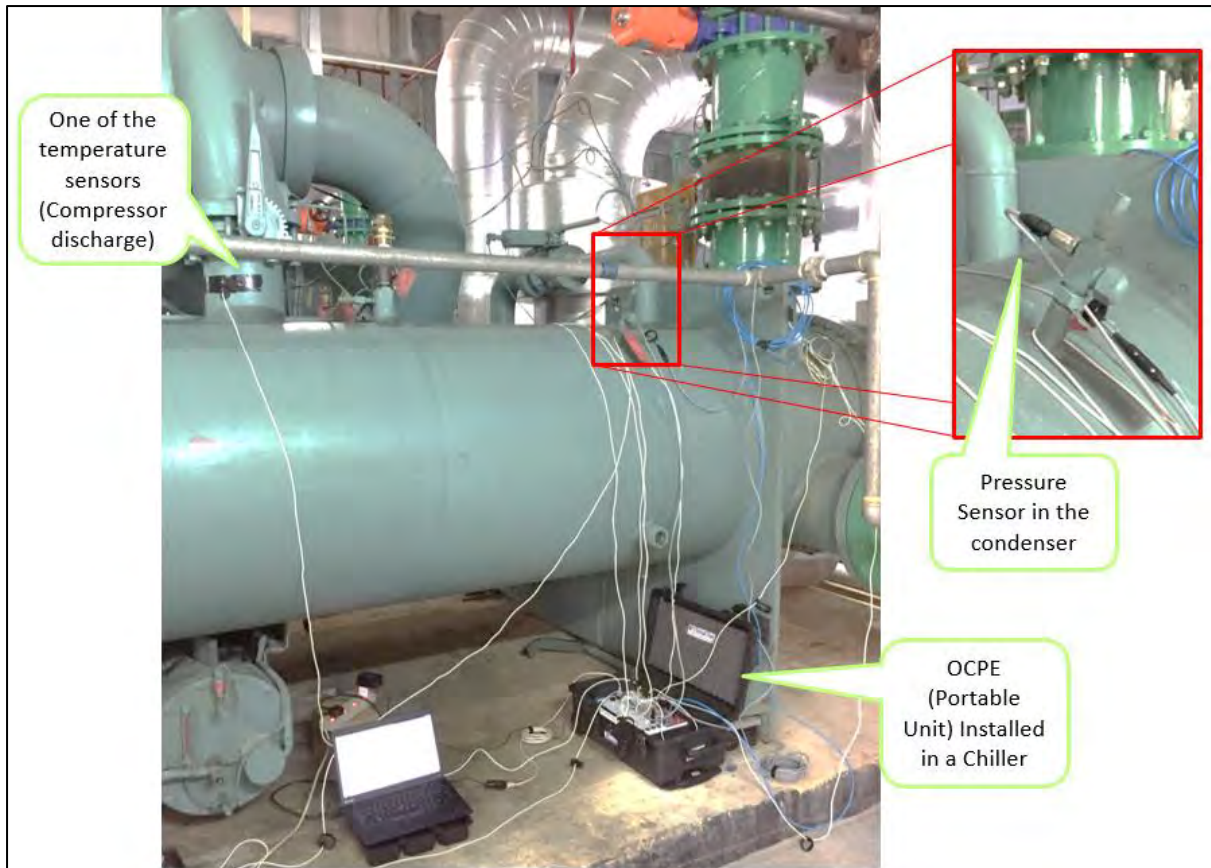

Figure 3: OCPE portable unit installation

2.3 How the chillers are operating

The sensors, data collection and calculations of the OCPE technology establish the chiller operating points. The Figure 4 depicts the operational conditions of both chillers.

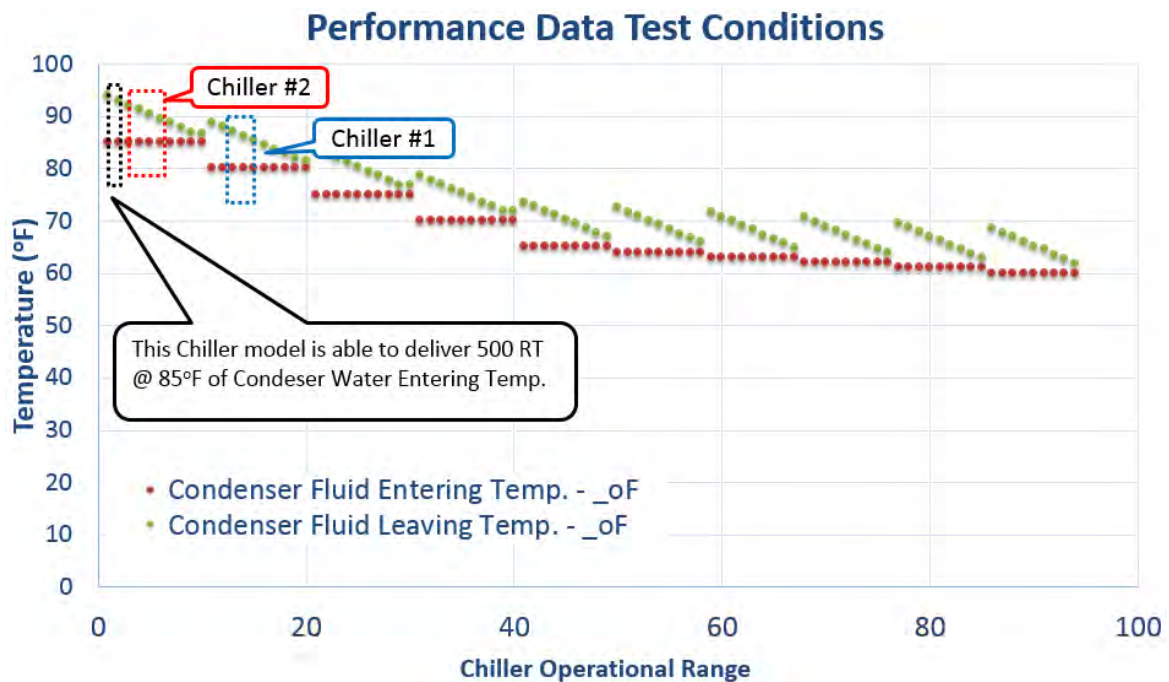

Figure 4: Chiller operational conditions

The OCOPE technology shows current operating conditions which are compared to design specifications to determine if the chiller is able to operate at full capacity. In this case, both chillers were working under less stringent conditions and were able to deliver design capacity and performance.

2.4 Chiller performance design vs. actual

The OCOPE technology calculates actual chiller performance based on the thermodynamic properties of the refrigerant and the refrigeration cycle, together with the measurement of power consumption. The Figure 5 shows that Chiller 1 and 2 have higher kw/ton than design data which is less efficient.

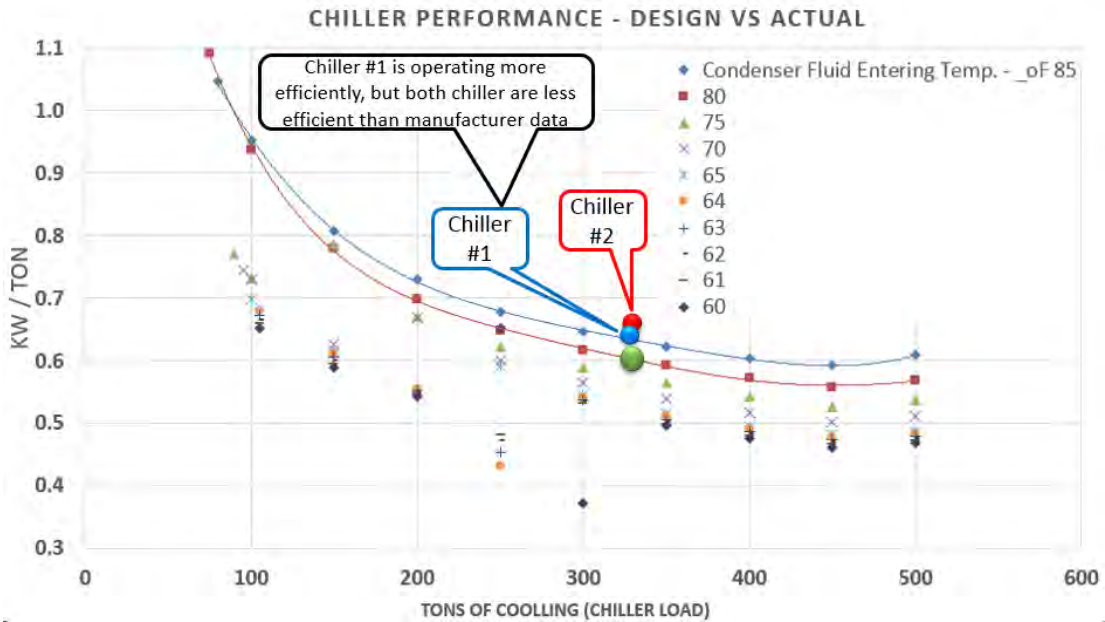

Figure 5: Chiller performance – design vs. actual

2.5 Cooling demand profile

Since OCOPE technology calculates the chiller load, it was also possible to determine the chiller plant cooling demand profile. The Figure 6 shows cooling demand together with other key variables.

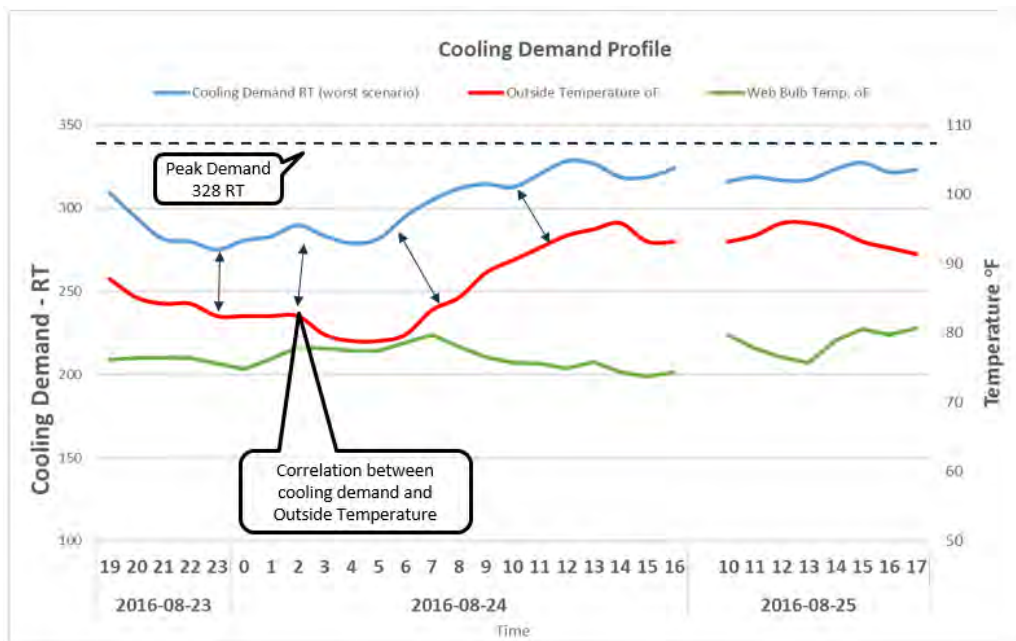

Figure 6: Cooling demand profile

A trend analysis of the cooling demand profile, showed a potential correlation between Outside Air Temperature (OAT) and cooling demand. This led to a regression analysis which is shown in Figure 7.

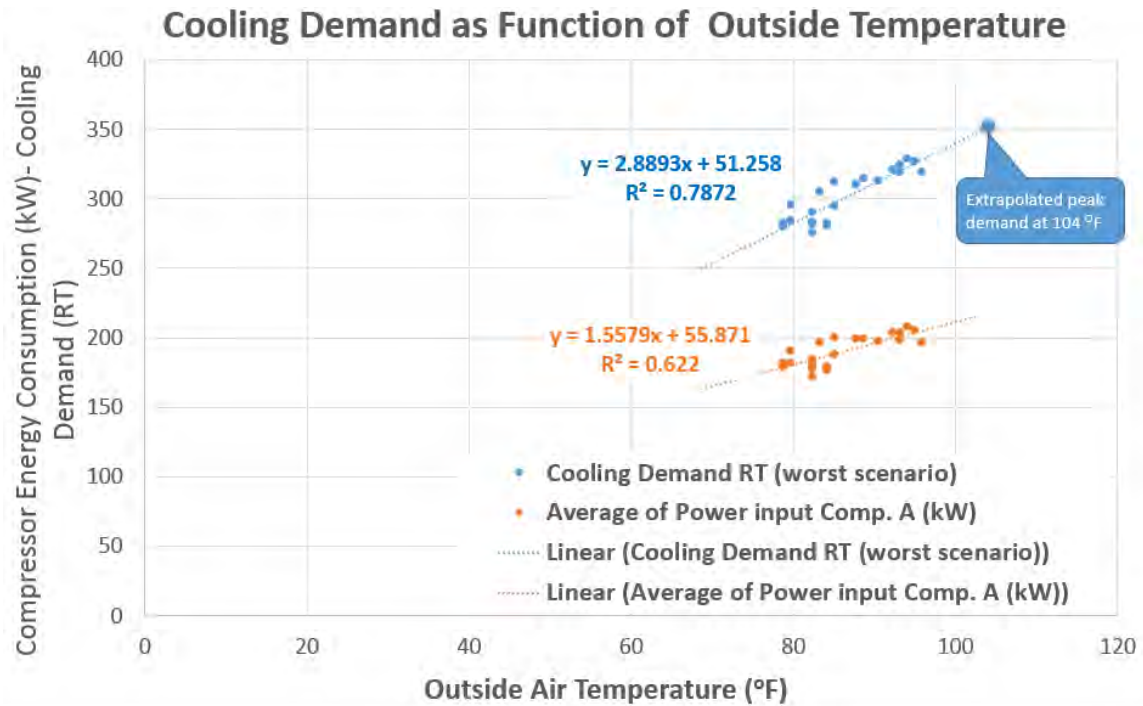

Figure 7: Cooling demand and chiller compressor consumption as function of OAT

2.6 Cooling demand forecast

The regression analysis allowed to develop a cooling demand forecast establishing the peak demand as a function of OAT and based on historical records of extreme weather conditions. The forecast provided insight into the current ChP workload and planning for optimization projects in two phases to keep the cooling demand under 500 TR, under one single chiller capacity, as it is shown in the Figure 8.

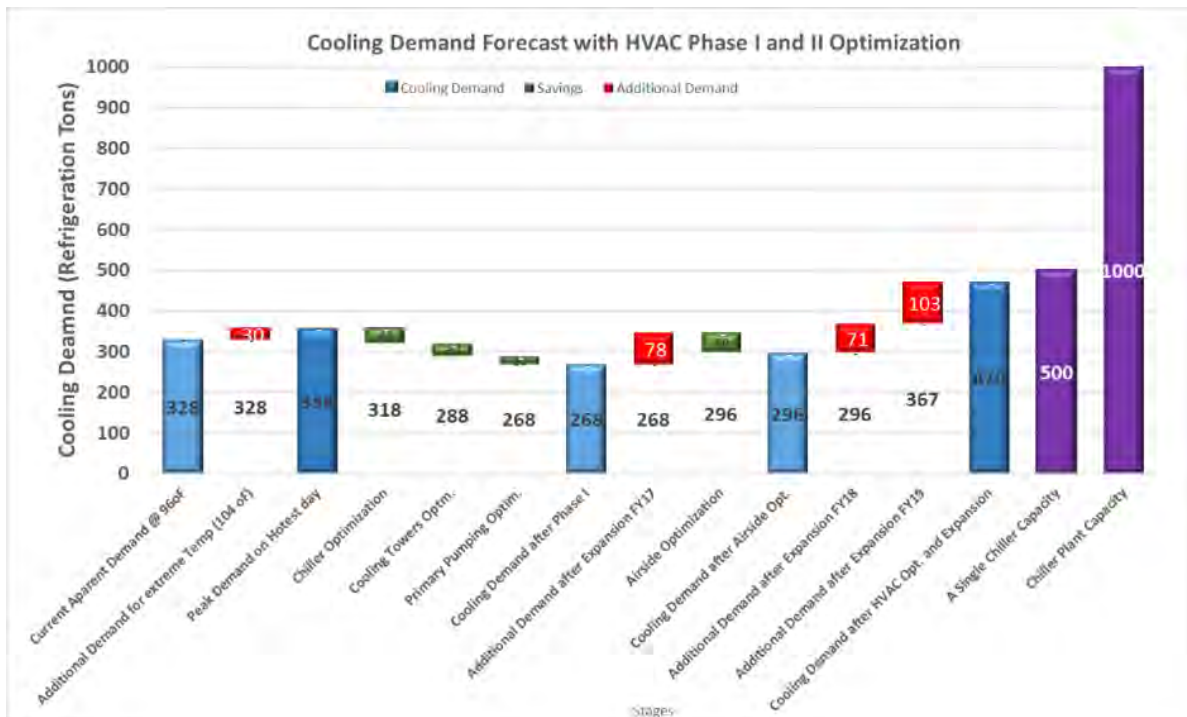

Figure 8: Waterfall chart of cooling demand forecast

3. IDENTIFIED IMPROVEMENTS

The following improvements were identified as a result of the OCPE:

Optimizing chillers and associated plant equipment will permit chillers to achieve their design capacity of more than 500 RT, each or 1000 RT together.

There is an opportunity to avoid a new chiller purchase if the recommended energy saving measures are implemented.

Current HVAC issues are not caused by lack of chiller capacity, but could be related to chilled water distribution issues.

Chiller Plant improvement will “free up” electrical infrastructure capacity. The electrical capacity to be released is from 40 to 80 kVA.

3.1 Return on investment

The main energy-saving opportunities identified are:

- Increase condenser water flow by 20% and modulate it as a function of the chiller workload and efficiency.
- Modulate cooling tower fans to reduce condenser water temperature as a function of chiller efficiency.
- Optimise Air Handler Units by installing VFDs to modulate air flow to rooms and reduce outside air infiltrations.
- Install capacitors to increase electric motors power factor.
- Reduce condenser water flow to chiller when they are not in operation.
- Clean condenser tubes.

The typical % of energy savings achieved by implementing the above measures is from 20 to 30%. The following Table show the financial analysis for the above improvements:

Improvement Area	Total Project Cost	Annual Energy Savings	Annual Energy Cost Savings	Chiller Capital Savings	Chiller Maint. Savings	Electrical Infrastructure savings	Total Savings first year	Net Annual Recurrent Savings	Simple Payback Period
	[USD]	kWh /year	[USD]/Year	[USD]	[USD]/year	[USD]	[USD]	USD /Year	Years
HVAC Waterside	\$ 141,715	287,000	\$ 34,440	\$ 160,000	\$ 13,000	\$ 75,000	\$ 282,440	\$ 47,440	0.50

Table 1: Financial analysis.

3.2 Common saving opportunities identified with the OCPE

OCPE technology has been applied in 16 chiller plants with the following common saving opportunities:

Inadequate refrigerant charge, low condenser water flow, Low chilled water flow, Faulty expansion valve and Inefficient cooling tower function.

3.3 Next steps for OCPE

OCPE technology has represented a huge advanced in chiller plant evaluation and optimization, however developments such as internet of thing and monitoring and analytics will assist towards Dynamic Chiller Performance Optimization: DChPO, which will lead to the next generation of high-performance Buildings. This new technology will incorporate elements such as:

- Predictive Maintenance
- Net present value optimization, including variables such as: maintenance cost, energy and water tariff, environmental taxes or incentives, etc.

The incorporation of these elements will allow an optimization at a higher level, towards to maximise building performance throughout its lifespan with more comprehensive information.

4. APPENDIX A: INSTALLATION OF OCPE SENSORS

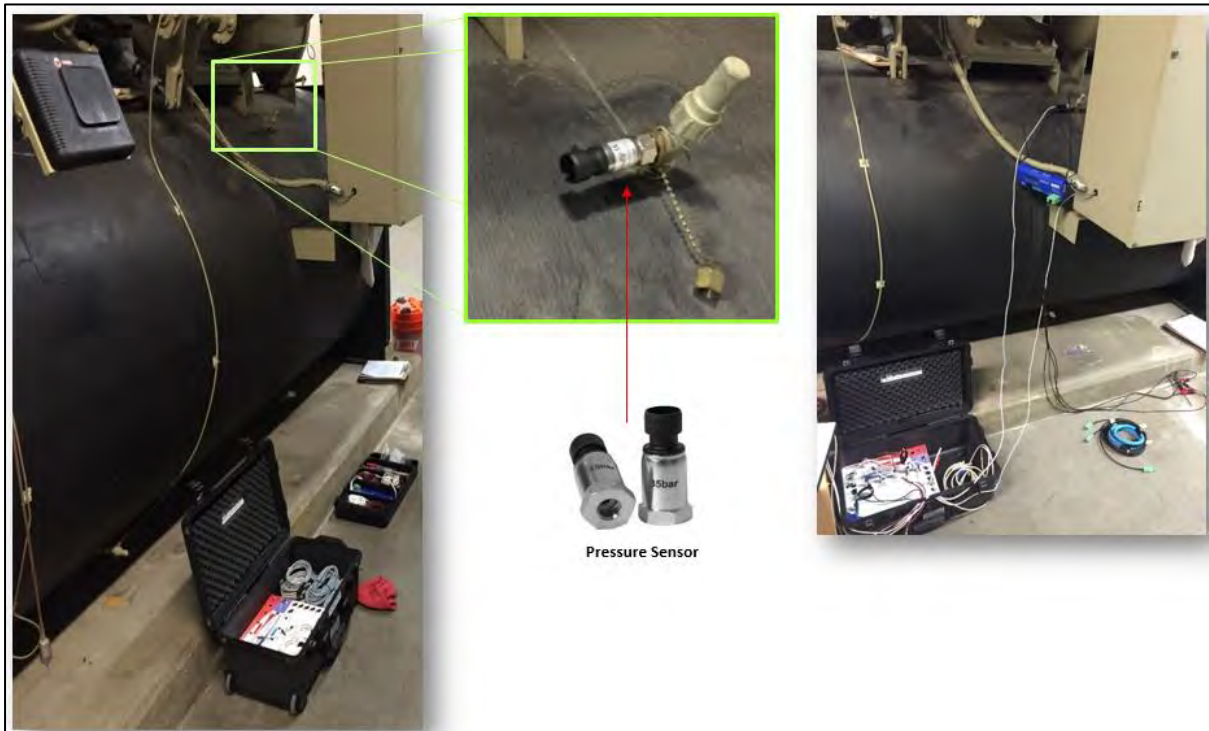

APPENDIX B: EFFECT OF LOW POWER FACTOR IN CHILLERS RLA

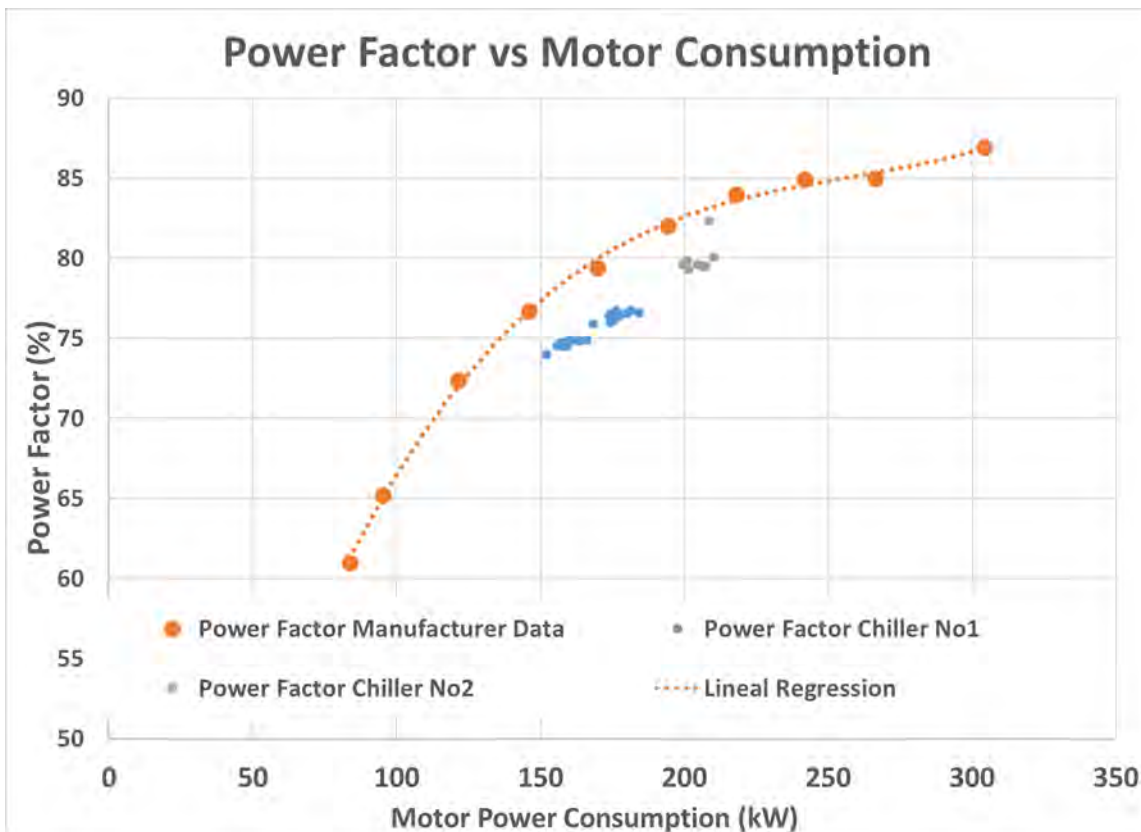

Project-host-company maintenance staff was confused by using Rated Load Amperage (RLA) in chiller 2 as an indicator of the chiller workload, this indicator had reached 80%, but the workload was not at 80% for the following reasons:

Chiller 2 is not operating in an optimum point.

Its Electric Motor is operating at a lower Power factor than the manufacturer performance conditions. This situation makes the motor consume more apparent current than it should be. In this case, when the chiller 2 reached 80% of the RLA at 79% of power factor only 62.3% is active Amperage against 65.6 % that it should be. This means the motor was loaded 3.7% less than it seems. Thus, the motor reached only 76.3% of its maximum load. As Chiller 2 is less efficient than Chiller 1 by 15%, the actual chiller load was not 80% but 71.3% when both effect are considered: Efficiency + power factor.

REFERENCES

- [1] U.S. Energy Information Administration (EIA). 2016. International Energy Outlook 2016. Chapter 1, pages: 8, 102, 103. Retrieved from: [www.eia.gov/forecasts/ieo/pdf/0484\(2016\).pdf](http://www.eia.gov/forecasts/ieo/pdf/0484(2016).pdf). [Retrieved on 30 September 2016]
- [2] Berglöf, K. 2013. Experience from Energy Optimisation in Refrigeration and Air-Conditioning Plants Through Field Measurements. paper presented at the 8th International Conference on Compressors and Coolants, Smolenice, Slovakia, 2-4 September 2013.

Transforming Data into Action – Building Energy Management System to Actualize a Sustainable Built Environment

Jovian CHEUNG Man-chit^a, CHAN Tze-chun^b, YIU Cheuk-man^c

^a Electrical & Mechanical Services Department, Government of the HKSAR, Hong Kong SAR, joviancheung@emsd.gov.hk

^b Electrical & Mechanical Services Department, Government of the HKSAR, Hong Kong SAR, chantzechun@emsd.gov.hk

^c Electrical & Mechanical Services Department, Government of the HKSAR, Hong Kong SAR, cmlyu@emsd.gov.hk

ABSTRACT

The Paris Agreement highlights the objective of holding the increase in the global average temperature to well below 2°C compared to pre-industrial levels, recognising that this would significantly reduce the risks and impacts of climate change. The building, which accounts for 40% of global energy consumption, represents a major opportunity to reduce greenhouse gas and combat climate change. By cohering smart technologies and energy-efficient initiatives into a building, people are enabled to raise building energy performance and enhance the sustainability of the built environment in their daily lives.

To motivate building management and users' participation in saving energy, Building Energy Management System (BEMS) can be built for turning data into actions. BEMS is formed by interfacing and integrating various control systems and legacy meters in the building and applying innovative data analytical techniques. It provides energy profile of a building which enables building management to achieve energy performance improvement through **raising building users' energy awareness, analysing the energy and system data for enhancing green operations** and benchmarking the energy usage for planning and prioritising energy management opportunities (EMO).

A BEMS comprises 4 core elements: (1) Energy Dashboard, for visualizing the building energy consumption and the contribution from renewable energy; (2) Energy Performance Analysis, for providing a comprehensive perspective on energy utilization and composition; (3) System Performance Analysis, for providing a holistic view on systems usage and efficiency; and (4) Benchmarking and Reporting, for measuring and verifying energy performance in accordance with ISO 50001 standards and energy audit requirements.

This Paper will illustrate how BEMS promotes green operations to actualize sustainable built environment and revitalises an existing building into a smart building. By transforming data into action, we perceive that the BEMS would contribute in developing Hong Kong into a sustainable smart city to be admired.

Keywords: energy use, energy measurement and verification, smart building

1. INSUFFICIENCY TOWARDS AN ENERGY-SAVING SOCIETY

About 90% of total electricity in Hong Kong is consumed by buildings. Through enhancement of building energy efficiency, a significant saving of electricity energy can be achieved and greenhouse gas emissions can be effectively reduced. The Buildings Energy Efficiency Ordinance (BEEO) in Hong Kong came in full operation in 2012. Different building stakeholders, including developers, building owners, occupiers, etc. should ensure key building services installations in new buildings fully comply with the energy efficiency standards of the Building Energy Code (BEC).

As at 2016, about 75% of Hong Kong's private commercial buildings have been operating for more than 15 years (Rating and Valuation Department, the Government of the Hong Kong Special Administrative Region, 2016). Therefore, initiatives in unleashing energy saving potentials of existing buildings are as important as designing a new building with energy efficient design. The revised BEEO requires the commercial buildings owners to carry out an energy audit on the key types of central building services installation every 10 years. (Electrical and Mechanical Services Department, The Government of the Hong Kong Special Administrative Region, 2012). The energy audit inevitably requires resources from building stakeholders in order to fulfil the legislative requirement, and the adoption of an effective BEMS can help them effectively carry out the energy audit and maximise the energy saving benefits.

1.1. Lack of plan-ahead features in legacy building control systems

Building Management System (BMS) has been deployed in commercial buildings for many years for purpose of centralised monitoring and scheduled control. Power Quality Management (PQM) System is also commonly used to check and manage the stability of the electrical power supply. However, these systems focus on how to achieve the optimum value by finding the best-fit parameters and loading profile to suit the best comfort and/or efficient operations. To achieve improvement for higher achievements, stakeholders should also continuously review and respond to what they have done, including extrinsic factors beyond the hardware limitation of building installations, so that they know what they can do next for greener operations under multiple perspectives. As existing buildings play a major role in electricity consumption as a whole, it is time to check what we can do better in a strategical way, achieve the most with least impact to existing operations.

1.2. Technical parameters are not transformable to business decisions

Metering facilities and mimic panels are not new technologies. But thanks to advanced metering facilities and **communication networks**, “**smart meters**” have been installed in more buildings in this decade, in which the interconnected sensor networks enable real-time central analysis and control for more efficient building operation and management. With sufficient operation data, building owners should be able to plan better than before (advancement in sensor and system level in Figure 1). However, as data representation in most BMS and PQM System are usually tailor made from a technical management perspective, that means there exists a gap between technical details and the layman understandable terms, unable to tell the subsequent steps to take. In order to mobilise stakeholders to take action, we should not underestimate the importance of common language and communication, and make use of BEMS to translate and propagate the key message to the key decision makers for establishing the directives, manage and hence push forward the green initiatives. (advancement in building level in Figure 1).

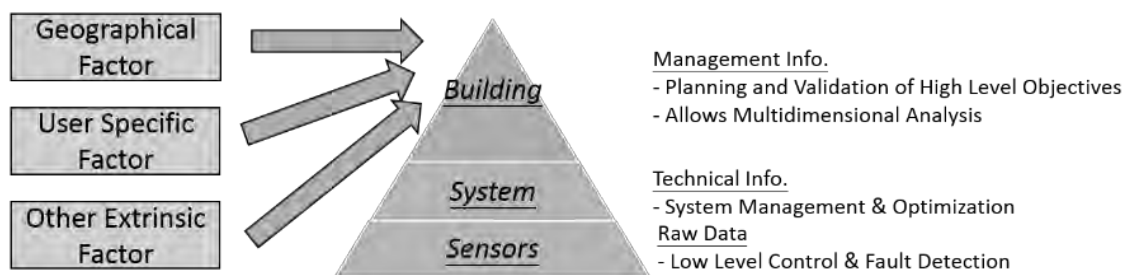

Figure 1: Hierarchy of building information collection and analysis

1.3. Hurdles to arouse and encourage public engagement

Some market barriers were identified in a previous study towards implementing energy efficient measures and some of them align with the situation in Hong Kong, including (1) misplaced incentives, (2) decision influenced by custom, (3) lack of information, etc. (Golove and Eto, 1996). For situations where residents are not billed for individual energy use, studies recommended to focus on continued awareness, education, and visualise incentives to achieving a long-term, sustainable effect, which is a matter of social-psychological domain rather than engineering discipline (McMakin, Malone, and Lundgren, 2002). In Hong Kong, the public is still focusing on the “**reliability**” level, and we have to move one step forward to “**efficiency**”. To encourage them to change, especially to visualise those indirect or intangible benefits, BEMS is helpful in providing accurate and up-to-date information, and facilitate in drafting plans and boosting incentives. Through regular review, proactively notified by energy alerts and passively by reading reports, BEMS is expected to help stakeholders to closely monitor building energy efficiency and address the barriers above.

2. ESSENTIAL FEATURES – HOW BEMS BOOST MOTIVATION

2.1 Less is more – Regrouping data to suit stakeholder capability

By adopting more smart meters in buildings, we are more accessible to the actual building performance. However, studies demonstrated that perceived information overload is associated with decreased performance. To balance **the reader's satisfaction and confidence** to make decisions, we need a careful dissemination of information even **within the organisation (O'Reilly, 1980)**. Also, **studies suggested that specific and challenging goals lead to higher performance than easy goals**, "do your best" goals or no goals. Goal setting is likely to improve task performance when the goals are specific and sufficiently challenging, and sufficient feedback is provided to show progress in relation to the goal, rewards, supportive management, etc. (Locke et al., 1981). The adoption of push notification is also expected to reduce information the overload (Edmunds and Morris, 2000), thus should also be considered. This suggests that BEMS should avoid information overload, select only the particular information and make target that actually matters to the particular reader groups nor beyond what they can perceive to encourage for action to save energy within their capacity.

Facility owner and management are usually responsible for analysing the building energy consumption. Central facilities like air-conditioning and pumping are maintained by facility management instead of individual tenants. In the case of system ageing and malfunctions, they should take lead in recommending a more energy efficient **machinery**. **From tenants' perspective**, the focus would be narrowed down for a comparison amongst themselves. For example, if Area A consumes more electricity per floor area than Area B, the usage pattern in Area A should be reviewed. As the usage patterns among similar tenants should be comparable, the review can help find out the **abnormalities and/or rooms for improvement**. **If geolocation factors are considered, the "aspect effect", e.g. west-facing vs. north-facing apartment**, can also be determined quantitatively.

2.2 Planning by setting target and verification by benchmark

Rewards can effectively encourage energy conservation, but with rather short-lived effects, yet frequently feedback has proven its merits in previous studies (Abrahamse et al., 2005). We have discussed the importance of setting challenging but achievable targets, and it is critical for management to set targets and endorse the representatives to take action. Setting a target will be the first step to do better, and then we could move forward and discuss how BEMS can assist in selecting the most efficient option and verifying the result

No two buildings can be completely identical, geographical locations and many other factors will affect the energy consumption and usage patterns. Therefore, the best yardstick to evaluate the changes would be the building itself, using the past performance data. To further analysis the performance, we can exclude those extrinsic factors like increase in outdoor temperature, and focus on intrinsic only.

For a qualitative comparison, green building project information is available online after green building certification like using the BEAM Plus assessment tool in Hong Kong. The public can understand more about the green features and the environmental performance of their buildings through the assessment for further advancement, and recognise the effort by the building owners. (The Hong Kong Green Building Council, 2016). For end-use energy data analysis, the Hong Kong Government has developed selected energy-consuming groups in various sectors in Hong Kong since 2001. The energy utilisation indices, benchmarks and benchmarking tools are available online for information and use by the public (Electrical and Mechanical Services Department, The Government of the Hong Kong Special Administrative Region, 2016).

No matters which grading and standards are taken for comparison, it is often good for builder users to share the fact for mutual learning. Although the standards and levels of detail could be different owe to different focus and various reasons, in the era of big data, we have to believe these scattered data could finally turn into useful advice, only when we have a sufficient information gathered for analysis.

2.3 All information at a glance – energy dashboard

An effective BEMS should provide different dashboard views which suit the needs of stakeholders. In the adoption in EMSD headquarters, there is three major view developed. For example, a view for public and general tenants may focus on the overview of green features; The breakdown view by system is for central management, while the

breakdown view by floor suits **the tenants' representatives**. The **system view and floor view** design another for decision makers and action takers can focus on benchmarking and trending analysis, to identify EMOs and setting targets to achieve. There will be two key ideas for the views: (1) keep it simple to understand, and (2) know the current performance against target.

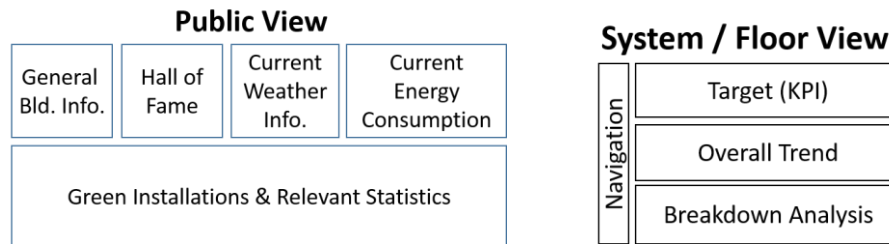

Figure 2: Different design of dashboard

To further arouse readers to get an idea how well they have done against the pre-defined target, the BEMS should provide a graphical interface with easily understandable charts to illustrate the intentions and achievements. For example, Key Performance Indicator (KPI) Gauge is introduced to visualise the target comparison rate by comparing the target and the up-to-date usage (Figure 3). **The baseline used is derived from last year's electricity usage with adjustment accordance to the saving target**, for example, 1% saving in the coming year, and the target is normalised in a shorter period in this implementation to further emphasise the possibility of meeting target while eliminating the fluctuation owe to daily patterns.

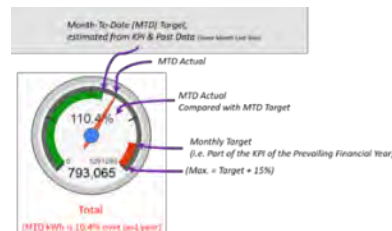

Figure 3: KPI gauge, show the target completion rate in a single chart

2.4 Take action proactively and passively – energy alerts and reports

If a system fault or abnormal energy pattern is found, a BEMS should be able to detect and provide energy alerts. The clues could be a combination of (1) Past Data (e.g. last day, last year same month, etc.) (2) Current Weather (e.g. against the pattern of same Cooling Degree Day loading) and (3) Usage patterns in different part of the building (e.g. against all west facing area of the building). The detection algorithm can be adaptive to the actual deployment, but instead of dashboard which focuses on providing a direction and overview, these alerts should be **presentable to the user in a mixed “push” (system notify the user actively, e.g. by sending notification via emails) and “pull” (system allows user to filter and analyse only on the data they are interested) approach, to suit the users’ dependency on BEMS.**

BEE0 requires an energy audit to be carried out for commercial buildings once in every 10 years, and other standards, e.g. ISO50001 can require a more frequent check. An efficient BEMS should feature an Energy Audit report functions which meet both the statutory law and ISO requirements, incorporate the general management methodology, e.g. KPI to help users easily understand the latest achievement.

Although these audits and checks are means to be conducted by registered professionals, it is still good for building management to establish the practice of internal audit as a quick check to know on the interim results towards the **set targets. With smart meters’ deployment and BEMS, report generation process could be fast and fully automatic.** The simplicity allows a more frequent check and review, which then raise the awareness in management levels with faster and effective response based on the feedback. The report should also show and compare the data against the past performance with detail breakdown so as to identify the possible EMOs. The EMOs can be **discussed in regular management review meeting, and members can define the next year’s plan in order to achieve** the targets, and channel the message to the frontline staff with motivation scheme for the frontline building users, so as to boost the atmosphere for executing energy saving initiatives.

3. IMPLICATION AND EFFECTIVENESS – HOW WE CAN BENEFIT

3.1 Systematic review of building performance

BEMS allows building owners and users to keep track the status of the building installation, and thus enables a systematic and quantitative review for detail analysis. With the data retrieved, we could better determine if a previously conducted campaign success or not, or in what ways we could replicate the success or learn from the failure. In addition, we can focus the activity on the potential improvement areas other than simply by the try-and-error approach.

3.2 Prioritisation of energy and system retrofit and the breakeven point

It is difficult and time-consuming to save energy by a try-and-error approach, especially from a financial perspective to building owners. However, as every electrical and mechanical installation system needs regular maintenance and replacement, BEMS can serve as a tool to find out the break-even point, in which the additional cost for a replacement to more energy efficient equipment might be payback through energy cost saved.

In 2016, an energy saving campaign had been carried out in EMSD Headquarters, in which non-essential lighting at particular areas were turned off during lunch time. Comparing the figures of 2015, the light-off campaign contributes 1% of saving solely, while the overall electricity consumption decreased for 3%, which means there are other factors also leads to energy saving. The result demonstrate energy measurement and breakdown is important to verify the effectiveness of an energy saving campaign, which will be useful in planning the next campaign, while further analysis can be applied to identify the cause of additional 2% saving by categorization the usage

3.3 Execute retro-commissioning for subsequent upgrades

Retro-commissioning of energy consuming building installations can restore them to the optimum operation level after years of usage. It shows how closely the building comes to operating as intended, helps to identify improper equipment performance, what equipment or systems need to be rectified or replaced, identifying EMOs and strategies for improving the performance of various building systems. As the actual usage pattern may have shifted in comparing with the original, execute retro-commissioning will be the best fit for existing buildings. As Hong Kong Government mentioned, some EMOs are simple housekeeping practices that require little additional cost, and they can and should be undertaken today (Electrical and Mechanical Services Department, The Government of the Hong Kong Special Administrative Region, 2015), the systematic analytics provided by BEMS makes it a cost-effective option to help building owners identify and justify the suitable measures for retro-commissioning.

4. DISCUSSION AND PROJECTIONS – WHAT WE CAN DO NEXT

As BEMS can quantitatively measure the consumption data, it gives rise to a new engagement model for owners to manage their buildings.

4.1. Energy performance contract

A typical building services maintenance contract includes materials cost and labour cost for repair of malfunctioning equipment. But when we come to maintenance or repair, ones may seldom measure if the energy usage is out of the expected range or not. If we take this into accounts, we will further correlate the equipment status with the long-term support pledge. Related energy saving and contract requirements have proved to show improved operational and plant efficiency gains in several studies (Davies and Chan, 2001). Instead of simply put the fault to maintenance body if the target cannot be met, an incentive can be established to encourage the maintenance body to upkeep the equipment in good and energy efficient condition. For example, a fixed amount of remuneration can be issued if the target is meet, similar to the practice of gratuity, with an additional bonus corresponds to the saved energy cost within the contract period; in return, the cost for overshoots can be shared by both building owners and the maintenance party, to raise the awareness and motivation on both side.

4.2. From scheduled maintenance to predictive maintenance

The deployment of massive sensor network keeps tracks of energy consumption, which also serves as means to measure **equipment's** healthiness. Abnormal energy consumption often correlates with faulty equipment or improper energy usage pattern, analysis of sensor data gives chances to derive a new maintenance model for **"predictive" maintenance. For example, the maintenance agent** may alter the preventive maintenance schedule for checking the high-risk equipment with an abnormal profile at a higher frequency and priority to better align the actual practical performance. The arrangement can be actualized by adding a fixed rate for onsite inspection service when setting the contract requirement, keeping the service in higher availability with minimum contract variations.

5. CONCLUSION

There are plenty of ways in saving unwanted energy consumption, but building management requires professional advice and tools to identify what they can do and how much they can do. It is crucial to effectively motivate and enable everyone to take action, which involves ideas beyond technical know-how. BEMS serves as a platform to let everyone do their part and take action together. Data analysis do matters, but how we take actions changes the environment, every little bit of efforts count.

REFERENCES

- [1] Abrahamse, W., Steg, L., Vlek, C. and Rothengatter, T. (2005) 'A review of intervention studies aimed at household energy conservation', *Journal of Environmental Psychology*, 25(3), pp. 273–291. doi: 10.1016/j.jenvp.2005.08.002.
- [2] Davies, H.A. and Chan, E.K.S. (2001) 'Experience of energy performance contracting in Hong Kong', *Facilities*, 19(7/8), pp. 261–268. doi: 10.1108/02632770110390694.
- [3] Edmunds, A. and Morris, A. (2000) 'The problem of information overload in business organisations: A review of the literature', *International Journal of Information Management*, 20(1), pp. 17–28. doi: 10.1016/s0268-4012(99)00051-1.
- [4] Electrical and Mechanical Services Department, The Government of the Hong Kong Special Administrative Region (2012) Buildings energy efficiency ordinance. Available at: <http://www.beeo.emsd.gov.hk/> (Accessed: 30 September 2016).
- [5] Electrical and Mechanical Services Department, The Government of the Hong Kong Special Administrative Region (2015) Energy Saving Tips - Introduction. Available at: <http://www.energyland.emsd.gov.hk/> (Accessed: 30 September 2016).
- [6] Electrical and Mechanical Services Department, The Government of the Hong Kong Special Administrative Region (2016) Energy consumption indicators and online Benchmarking tools. Available at: <http://ecib.emsd.gov.hk/> (Accessed: 30 September 2016).
- [7] Golove, W.H. and Eto, J.H. (1996) Market Barriers to Energy Efficiency: A Critical Reappraisal of the Rationale for Public Policies to Promote Energy Efficiency. Available at: <http://eande.lbl.gov/sites/all/files/lbnl-38059.pdf> (Accessed: 30 September 2016).
- [8] Locke, E.A., Shaw, K.N., Saari, L.M. and Latham, G.P. (1981) 'Goal setting and task performance: 1969-1980', *Psychological Bulletin*, 90(1), pp. 125–152. doi: 10.1037//0033-2909.90.1.125.l
- [9] Locke, E.A. and Latham, G.P. (2002) 'Building a practically useful theory of goal setting and task motivation: A 35-year odyssey', *American Psychologist*, 57(9), pp. 705–717. doi: 10.1037/0003-066x.57.9.705.
- [10] McMakin, A.H., Malone, E.L. and Lundgren, R.E. (2002) 'Motivating residents to conserve energy without financial incentives', *Environment and Behavior*, 34(6), pp. 848–863. doi: 10.1177/001391602237252.
- [11] O'Reilly, C.A. (1980) 'Individuals and information overload in organizations: Is more necessarily better?', *Academy of Management Journal*, 23(4), pp. 684–696. doi: 10.2307/255556.
- [12] Rating and Valuation Department, the Government of the Hong Kong Special Administrative Region (2016) Hong Kong Property Review 2016.
- [13] The Hong Kong Green Building Council (2016) BEAM Plus Online Exhibition. Available at: <http://greenbuilding.hkgbc.org.hk/projects> (Accessed: 30 September 2016).

Telecommunications Infrastructure for High Performance Buildings

Philip TAI^a

^a Swire Properties Ltd., Hong Kong SAR, philiptai@swireproperties.com

ABSTRACT

Easy access to full range of voice, ultra-high-speed broadband Internet and terrestrial & pay TV services, and full **spectrum of mobile coverage everywhere have become “must have” for high performance buildings.** Security and resilience are mandatory requirements from banking, finance and high-tech sectors who cannot afford any service unavailability. This paper addresses how these needs from Tenants and visitors can be catered given limited space.

We introduce a copper Cat 5-fiber hybrid blockwiring system, supplemented with a bi-directional coax SMATV system, for delivering full range of fixed network and TV services. Choice of services, security and resilience shall be taken into account. We also propose an indoor common antenna system which supports full spectrum of mobile services, and can be expanded to include Wi-Fi and walkie-talkie systems if needed. Space requirement can be optimized with common equipment rooms, and proper interconnection arrangement (on the shared use of blockwiring, SMATV and common antenna systems) with services providers.

The remaining of this paper is organized as follows. Section 1 **addresses Tenants’ needs for different kind of communications services.** Section 2 introduces a hybrid blockwiring and bi-directional coax backbone for wireline and TV services. Section 3 describes mobile common antenna system and Wi-Fi provision. Section 4 projects the future trends of communications services and how our proposed infrastructure can cater for future requirements. Section 5 provides a conclusion remark.

Keywords: high performance buildings, telecommunications, security and resilience

1. INTRODUCTION: TENANTS’ NEEDS & CONSIDERATIONS IN TELECOMMUNICATIONS SERVICES

Telecommunications services can be categorized into wireline and wireless services, both are critical to everyone including building managers, hotel operators, tenants, visitors, occupants, shoppers as well as hotel guests.

Office tenants expect easy access to full range of (both local and international) wireline services including voice grade, ultra-high-speed data and TV services. Free choices of service providers and hassle-free services provisioning are important. Security and network redundancy are mandatory requirements of banking, finance and high-tech sectors who cannot afford any service interruption. Nowadays, almost everyone carries smart phones. Mobile coverage everywhere has already become a necessity. In addition, courtesy Wi-Fi services in main lobby, cafes/food & beverage area provides convenience to office tenants and visitors who are tablet and notebook users, and helps to create cyber community sentiment. Tenants and visitors of shopping malls expect the same telecom services provision as office tenants except network redundancy may not be critical.

Broadband Internet, terrestrial & pay TV and telephone services are must-have in residential buildings. Occupants always expect reliable services, free choice of service providers as well as quick service provisioning time. Good mobile coverage within residential flats is desirable. Coverage inside lift cars is nice-to-have but not critical. In addition, **free Wi-Fi service is usually provided in residents’ club house.**

Telecom provision for hotels is another story. Hotel guests always expect a very user-friendly & easy-to-use telephone system with IDD services (reasonably priced), speedy broadband services (both wireline and wireless), plenty of popular satellite TV channels around the world, pay TV and video-on-demand services in their rooms. **All these services shall be managed by the hotel’s hospitality system for better guest experience, market analysis and billing purposes.** Furthermore, comprehensive mobile coverage of all domestic mobile operators (for roaming services to visitors) and free Wi-Fi everywhere in hotel are must.

2. WIRELINE INFRASTRUCTURE

Wireline infrastructure includes fixed network, TV services and some shared facilities facilitating tenants to operate their own private networks within the building or campus.

2.1. Fixed network Services Provision

Fixed network facilities consist of 3 components: lead-in cable, equipment room (i.e. TBE room in Hong Kong terminology) and blockwiring system. Building managers shall facilitate as many fixed network operators as possible to deliver their services in their buildings for the sake of choices of services. To achieve better space utilization, building managers shall mandate share use of lead-in cable ducts, TBE rooms and telecom risers among all services providers.

Fixed network operators connect a building (i.e. their customers within the building) to their networks via their own fiber cable contained in lead-in ducts. Two different lead-in routings connecting to the TBE rooms are strongly recommended for the sake of network security and availability.

TBE room accommodates the access equipment of fixed network operators who deliver their voice, data and multi-media services to tenants. Each building shall be provisioned with at least one TBE room, for the shared use among all fixed network operators. Dual TBE room is highly recommended for office towers whose tenants demand for secure and truly resilient fixed line services. The size of TBE room(s) usually relates to the total floor area of the building, and the OFCA guidance provides a good reference on this subject.

Blockwiring system (i.e. the “last mile”), including cat 5 copper and single mode fiber cable, is usually the hindrance for fair competitions among fixed network operators. To ensure free choices of services for occupants, building managers can build and lease out their own blockwiring to all services providers with a non-discriminatory terms. In addition, dual telecom riser, a standard provision in high-end office towers, is recommended for network **redundancy and resilience**. **Figure 1 illustrates that buildings can achieve “no single point of failure” in fixed network provision by deploying dual lead-in, dual TBE room and dual telecom riser.**

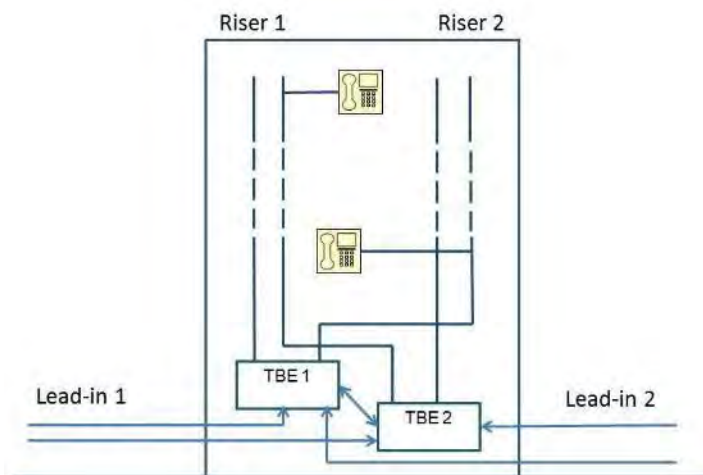

Figure 1: Fixed network provision with no single point of failure

2.2. Private connectivity solution for office tenants

Some office tenants may occupy two or more premises at different floors within a building or across buildings within a campus. They always need to build their own private network connecting up all their premises. Conventional fixed network service is an obvious solution but can be very costly. Private fiber is a cost-effective solution for these tenants who want to build their own very high speed private network connecting up two premises. Building managers can reserve a “Tenant’s Trunking” in telecom risers for the shared use of tenants who want to lay their own telecom cables across floors.

Alternatively, building managers can maintain their own fiber network within the building (and across buildings for a campus of buildings), and lease out dark fiber to tenants. This kind of private dark fiber network within a building

and a campus of buildings also offers other benefits including dedicated high speed access to common facilities **within the building or campus such as satellite farm (i.e. to support tenants' own satellite dishes), data centres etc.** Building managers can also utilize their own fiber network for better support of their own system such as surveillance CCTV, building management systems, energy management systems, walkie-talkie etc.

2.3. SMATV System

Coaxial cable based SMATV system is another basic infrastructure in every building. It consists of terrestrial TV antenna, satellite dishes, headend (i.e. receivers and combiner) and a tree-like coax distribution network. In Hong Kong, OFCA has specified a bi-directional coaxial cable based backbone system, which supports reception of various TV services such as terrestrial TV (including both analog and digital), satellite TV and cable TV (HFC based) services, and broadband Internet services (cable modem based).

For a campus of buildings, a single SMATV system with a centralized communal TV antenna and satellite reception dish, as shown in Figure 2, is desirable. Individual buildings are provisioned with a coaxial backbone, which connects to the headend via single mode fiber. Cable and pay TV operators can deliver their services to the whole campus by interconnecting to the headend. This communal system approach minimizes space requirement as only one set of headend in a single equipment room plus one set of satellite dishes is needed for serving the whole campus.

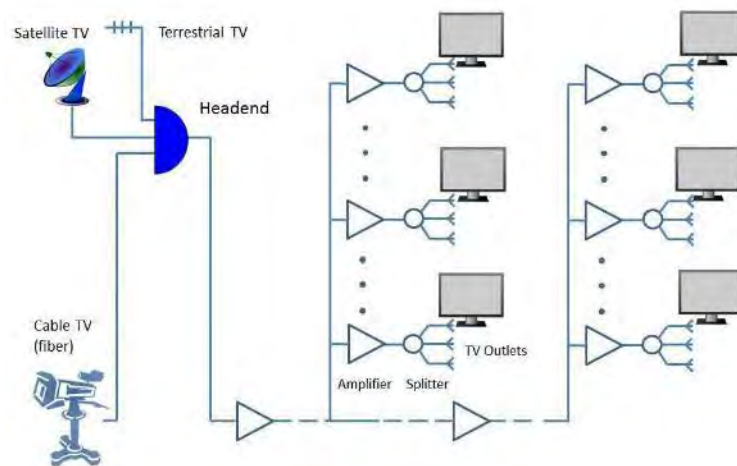

Figure 2: Communal SMATV system

3. WIRELESS INFRASTRUCTURE

Public mobile communications, including voice and data, has become a necessity for everyone nowadays. Wi-Fi services, which can be operated by either service providers or building managers, is considered as a supplementary wireless services to mobile services.

3.1. Mobile communications

One challenge for building owners is to facilitate tenants and visitors to enjoy full range of mobile services (i.e. 2G, 3G & 4G) and free choices of services from all mobile operators given limited space.

Common antenna system is the only solution for this challenge. A tree topology, as shown in Figure 3, consisting of a point-of-interconnect (i.e. combiner) and a mobile backbone with horizontal cables extending mobile coverage in each floor, is adopted. All the joining mobile operators shall install their own base station equipment inside the Common Mobile Equipment Room and connect to the common antenna system via the point-of-interconnect. Dual cable design is usually adopted for the sake of maximized system capacity i.e. the quantity of mobile networks to be connected to the common system.

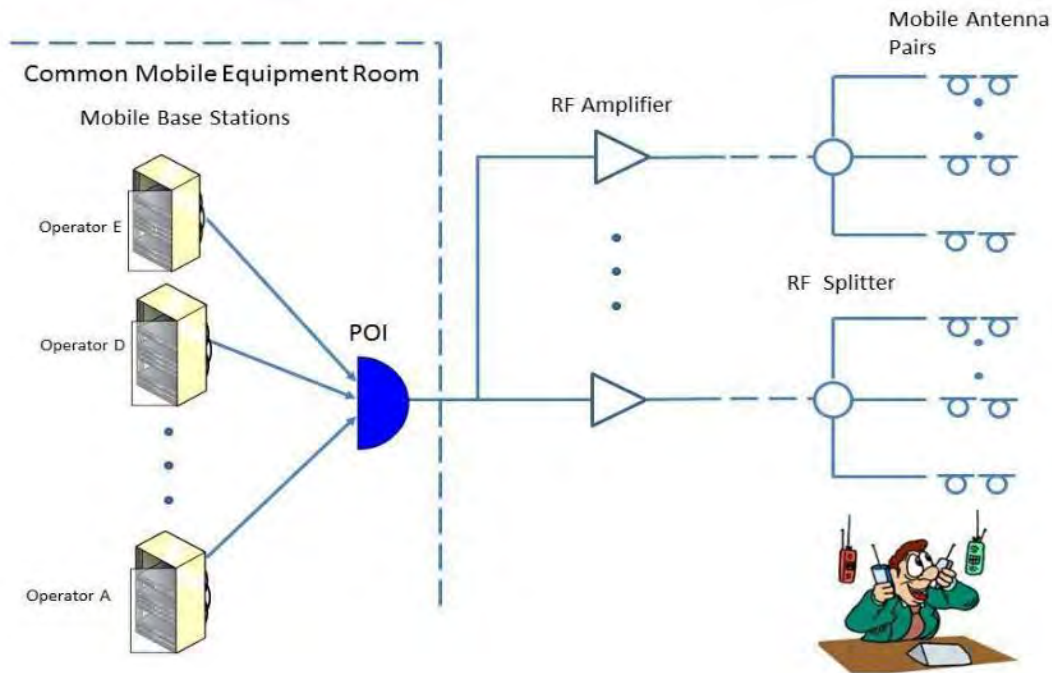

Figure 3: Mobile common antenna system

Indoor mobile antenna is the most common and cost-effective transmission element. Leaky coax is another option of providing mobile coverage particularly for indoor or confined area (e.g. tunnels) with very limited space but it is more costly. To provide mobile coverage inside lift cars, mobile antenna can be installed inside lift cars and connects to the mobile backbone with a travelling cable. Alternatively, mobile coverage inside lift cars can be achieved by installing small panel antennae along the lift shaft and a mobile repeater covering lift cars.

Wi-Fi signal can also be transmitted through mobile common antenna system. The biggest advantage of this approach is capital cost saving, and can be adopted in hotels and shopping malls where guests and shoppers expect comprehensive mobile and Wi-Fi coverage within the whole premise.

3.2. Wi-Fi

Wi-Fi services, being a “must have” facility in most buildings, allows handheld devices to connect to Internet and virtual private network (VPN) via a wireless local area network (LAN), mainly using the 2.4GHz and 5GHz radio bands. The current Wi-Fi, conforming to the IEEE802.11ac standard, can supports data speed up to 1,300 Mb/s. Wi-Fi services can be offered via hot spots within around 100m from wireless router(s) owned by the establishment. Hot spots are common in airports, libraries, coffee shops and beverage outlets. Another approach is comprehensive Wi-Fi coverage which is common in shopping malls and hotels who want to provide high quality services to their visitors and guests. Normally, users must connect manually to Wi-Fi services by checking the Wi-Fi connection option, selecting the correct network (i.e. the SSID), and entering authentication information, usually a simple password. Most shopping malls encourage visitors to register as a member of the shopping mall so that they can enjoy free Wi-Fi services in the mall.

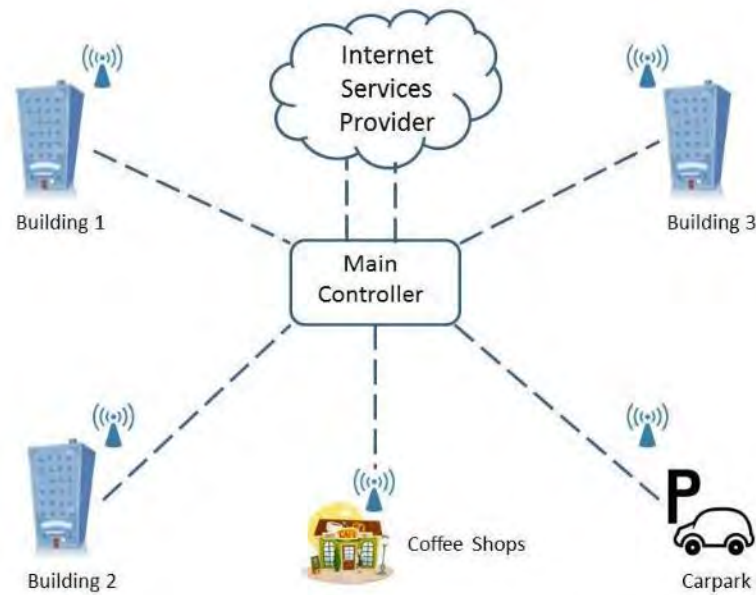

Figure 4: Campus-wide Wi-Fi system

Wi-Fi services can be offered by either telecom service providers or building managers. Operating a self-owned Wi-Fi system brings the following benefits to building managers.

- Courtesy Wi-Fi services which is a great convenience to visitors particularly tourists or foreign visitors
- Better understanding on visitors/guests behaviour in terms of usage pattern, footfall etc. (more precise marketing analysis is possible when combined with visitors and guests profile data)
- Wireless data connections for all activities in Atrium or public hall area
- Wireless data connections for building facilities or systems (which eliminates the needs of cable laying and related builder work and cable containment)

4. FUTURE OUTLOOK

The fifth generation (5G) mobile and Hotspot 2.0 are emerging new wireless technologies which aim to enhance user experience in terms of speed and connectivity.

4.1. 5G Mobile

5G mobile, operating in the 5GHz band, is the next generation mobile services which shall support higher data speeds (i.e. up to 1 Gb/s or 100 times of the current 4G mobile) and larger network capacity. The market expects the first 5G mobile services to be commercially available after 2020. We anticipate that tenants and visitors will expect indoor 5G mobile coverage when new 5G mobile handsets and devices come into market.

The dual-cable common antenna system as described in section 3.1 has already catered for future expansion for 5G mobile support without the needs for substantial cable alternation or installation work. The upgrade work shall include replacement of point-of-interconnect, antennae and RF components (such as fiber amplifiers, splitters, couplers etc.) by wideband ones supporting 900MHz to 5GHz. Additional antenna points and/or fiber amplifiers may be needed as 5G mobile signal propagates at shorter range than 4G/3G signals. We need to identify some equipment space in the common mobile equipment room for additional 5G base station equipment. Mobile equipment has reduced their physical size due to rapid advancement in semi-conductor technology, and thus extra space in common equipment room may not be critical. The biggest challenge of 5G upgrade is probably agreeing outage windows with tenants for the replacement of mobile antennae/splitters/couplers inside tenant premises. **Opening and re-instatement of tenants' false ceiling will be involved. The upgrade work can be delayed due to the difficulties in convincing tenants to allow for the replacement and associated false ceiling work.**

4.2. Hotspot 2.0 (IEEE802.11u)

Hotspot 2.0 (HS 2.0), also called Wi-Fi Certified Passpoint, is a new standard for public-access Wi-Fi that enables seamless roaming among Wi-Fi networks and between Wi-Fi and mobile networks. HS 2.0 was developed by the Wi-Fi Alliance and Wireless Broadband Association to enable seamless hand-off of traffic without requiring additional user logon and authentication.

The HS 2.0 specification, introduced in 2012, is based on a set of protocols called 802.11u, which facilitates cellular-like roaming, increased bandwidth, and service on demand for wireless-equipped devices in general. When a subscriber's 802.11u-capable device is in range of at least one Wi-Fi network, the device automatically selects a network and connects to it. Network discovery, registration, provisioning, and access processes are automated, so that the user does not have to go through them manually in order to connect and stay connected.

Major objective of HS 2.0 is to support automated roaming between HS 2.0 certified Wi-Fi networks so that users, once connected to a Wi-Fi network or even mobile network, can enjoy seamless connection to Internet when they travel from place to place. Traffic offload for mobile operators is possible with HS 2.0 and can become a potential revenue stream which is a partial subsidy for venue owners who operate their own Wi-Fi services.

5. CONCLUSION

We have introduced the fiber-cat 5 cable based fixed network infrastructure and mobile common antenna system/Wi-Fi system which can support full range of fixed network and wireless services nowadays as well as choices of services and network resiliency. In addition, our proposed dual-cable mobile common antenna system can be upgraded easily to support future 5G mobile without major rewiring work.

REFERENCES

- [1] Code of Practice for the Provision of Access Facilities in Buildings for the Supply of Telecommunications and Broadcasting Services, CoP-1/2012, Communications Authority, 1 Apr 2012 [online]. Retrieved from: <http://www.coms-auth.hk/filemanager/statement/en/upload/104/cop201201e.pdf>
- [2] Frequency Layout Plan of the In-building Coaxial Cable Distribution Systems, Statement of the Telecommunications Authority, ST-08/1999, 15 July 1999 [online]. Retrieved from: http://tel_archives.ofca.gov.hk/en/tas/others/ta990715.pdf

Using Big Data Analytics and Continuous Monitoring to Increase the Return on Investment (ROI) in Projects for Sustainable Building Performance

Rafael NAVARRO^a, Mark CASE^b, Jeffrey SIOW^c

^a ETC Group, Macau SAR, rafaelnavarrobarraza@gmail.com

^b ETC Group, Macau SAR, mcase@etcgrp.com

^c BD Medical, Singapore, jeffrey_siow@bd.com

ABSTRACT

During the 21st session of the Conference of the Parties (COP21) in Paris, 177 countries agreed on reducing their greenhouse gas emissions. The COP21 is just the start of a long path towards sustainable development. The next step is to identify and implement projects to efficiently increase energy performance in industrial, commercial and residential processes. This paper describes how big data analytics and continuous building monitoring are used to **reduce the capital cost and implementation time of energy projects, while increasing the ROI of facility's** sustainable performance: higher comfort at lower or lowest footprint.

This paper examines how the Energy Efficiency industry is changing and how these changes can help project formulation and make implementation easier and less risky for investors and decision makers. This paper will use a real-world success case of a Deep Building Renovation (technological upgrade in control and monitoring system) project to describe how data analytics led to a reduction in capital cost and implementation time while improving project return and overall success. It examines continuous monitoring enabled energy waste identification along with saving verification, and how these two technologies worked together to overcome typical sustainable project barriers.

The paper will explain:

- The key factors for success in Deep Building Renovation projects:
 - Change Management: Cultural change and training.
 - Quality of the Solution: The most efficient hardware / software architecture for both Cloud-base continuous monitoring systems and local-server oriented facilities
- The streamlined roadmap that guarantees the highest ROI.
- Operational tangible benefits:
 - Maintenance management
 - Energy efficiency
 - Compliance and verification

Keywords: high-performance building, smart building, deep building renovation

1. INTRODUCTION

While it is widely known that sustainable development is the only sound and viable pathway for humankind's future, its attainment remains elusive despite intensive efforts and some successes. The current industrial society approach, based on product and process innovation in a variety of fields, is not providing the expected results in addressing this important issue (Morioka, 2006). There have been various studies regarding improvement on the efficiency of several industrial, commercial and residential processes and technologies but a few in Energy-Efficiency industry itself.

The Energy Efficiency industry, as other industries, has been highly impacted by IT development, making industry processes cheaper and less time demanding. As a technological field highly dependent on exact science (such as Mathematics, Physics and Thermodynamics), the automation of its process it has been possible thanks to advances in data storage, telecommunications and computing. Behind are the days when it was necessary to manually collect large amounts of data, which might not make sense due to lack of synchronization, unstable processes or simply uncalibrated instruments, or could not be identified because data was insufficient for trend analysis or inadequate instruments to crosscheck the accuracy of the in-field readings.

Those early days were very hard for energy professionals who had to fight with several challenges: a new field of study, lack of literature, unreliable instruments, manual work for data gathering and computing, cost-efficient technology, etc.

Fortunately, those days are gone and technology has advanced, allowing a streamlined process for energy audit and project formulation. Energy efficiency is a proper study field and many universities around the world offer degrees for professional careers. Today data collection is very easy and the analysis is done instantaneously via servers connected to internet providing information that allows industrial, commercial and residential processes to be analysed by hour, minute, second, or even before problems occur.

This paper describes a real-world project that used big data analytics and continuous monitoring to identify, define and implement energy efficiency improvements in order to increase building performance and sustain this performance for the long run. These technologies also allowed a fast and reliable project formulation and made implementation more cost-efficient and less risky for investors and decision makers.

The main objective of this article is to describe the evolution of the energy efficiency industry pillars (tools, process and people) key factors for success in this Deep Building Renovation project, and the streamlined roadmap that guarantees the highest ROI.

The project was executed by an international energy efficiency services company with an Asia regional office in Macau and headquartered in Utah, USA. The project-host company is a healthcare products manufacturer located in Singapore. The main objective of the project was to increase building HVAC system efficiency, thus reducing environmental impacts and the operational cost. This project is also a real-world success case of a Deep Building Renovation (technological upgrade in control and monitoring system) that describes how data analytics led to a reduction in capital cost and implementation time with improved project return and overall success. It examines how continuous monitoring enabled energy waste identification along with saving verification, and how these two technologies worked together to overcome typical sustainable project barriers.

1.1 Evolution of energy-efficiency tools

Energy efficiency diagnostic tools have advanced significantly in past 50 years, passing from fully-manual to online-automatic based approach. This huge leap has brought cost and time reduction to energy efficiency process, especially savings identification, quantification and verification. And with this, the project capital cost has been reduced, as well as the associated risk.

The newest monitoring and analytics technology allows energy professionals to identify and evaluate energy efficiency opportunities in existing buildings by analyzing trends of different variables in systems such as: air conditioning, heating, ventilation, lighting, etc. This type of study can be executed on-site or remotely via an internet **connection. As a result, projects no longer require an energy professional's physical presence for data collection or monitoring.** This has brought two direct benefits: lower cost and implementation time.

The technology brought new challenges, as large amounts of data need to be processed, requiring more complex algorithms, software and data storage. Fortunately, the Internet offered a solution, cloud data storage and processing. This implies the following benefits:

- Lower capital investment: local server data storage is no longer required
- Lower operating cost: cloud services are significantly cheaper than in-situ data centres
- Higher flexibility: cloud data storage can be contracted monthly with long term contracts not required.
- Less administration: Software as a Service (SaaS) model can be deployed by specialized energy efficiency companies.

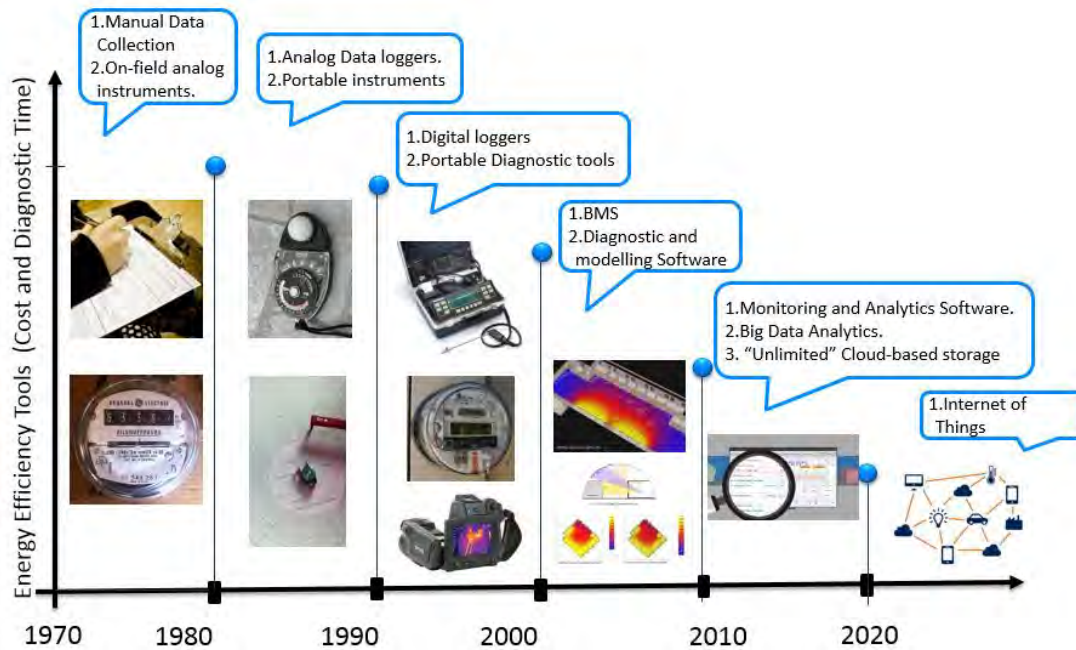

Figure 1: Evolution of energy-efficiency tools

1.2 Evolution of energy efficiency industry pillars

A project manager increases the probability of a project successfully meeting its business objectives by applying the most effective combination of people, process, and tools to solve the problem and providing the essential leadership to guide the project in the right direction for it to be successful, (Cobb 2016).

It is necessary to review the evolution of the other two pillars, as not all the advances have been developed on the tools side, there has also been progress in the energy efficiency study field (process pillar) itself. In this sense, a large and robust knowledge base has been developed with proven best practices in several energy systems. These best practices are not only improvements to energy systems, but also enhancement to the process of how energy savings calculations are made. This, of course, facilitates the work of the energy efficiency professionals and technicians.

Similar to process and tools, the third pillar (people) has become an important component of the energy efficiency industry. Energy managers are now a very common position in different industries such health care, commercial building, and large hotels, etc. From an academic point of view, it is now possible to find master and doctoral degrees in energy efficiency. The increase in the number of professional certifications offered has allowed for industry growth in commercial and public institutions around the world.

When these three pillars (people, process and tools) of the project development converge, the factors for a successful energy-efficiency project can be deployed, the key factors that were identified in this paper case study were: Change Management and Quality of the Solution.

2. PROJECT METHODOLOGY CHANGES

The advances in data monitoring and analysis have impacted the development of energy efficiency projects in a positive way. With the recent advances in energy efficiency tools, large amounts of data are processed and converted into valuable information which reduce uncertainties which affect project risk and cost. The result is a streamlined roadmap.

This is explained by to the following:

First, traditional project methodology is based on a manual data collection, a limited knowledge base and less specialized human resources. As a result, the learning curve to understand the system takes longer in comparison to the new approach. The streamlined roadmap is simplified version of the traditional one.

Second, traditional data collection with multivariable analysis was difficult to perform. With a streamlined road map, data collection is a continuous process, multiple variables are recorded at the same time, making it easy to find correlations, especially with help of computational tools.

Third, data collection records different conditions and scenarios of the process. The decision-making process is based on robust and diverse scenario analysis which reduce the risk of investing in an energy saving opportunity that is a result of a data-driven analysis rather than a pure deterministic study as the traditional approach was.

The Figure 2 shows how the project development path has been simplified.

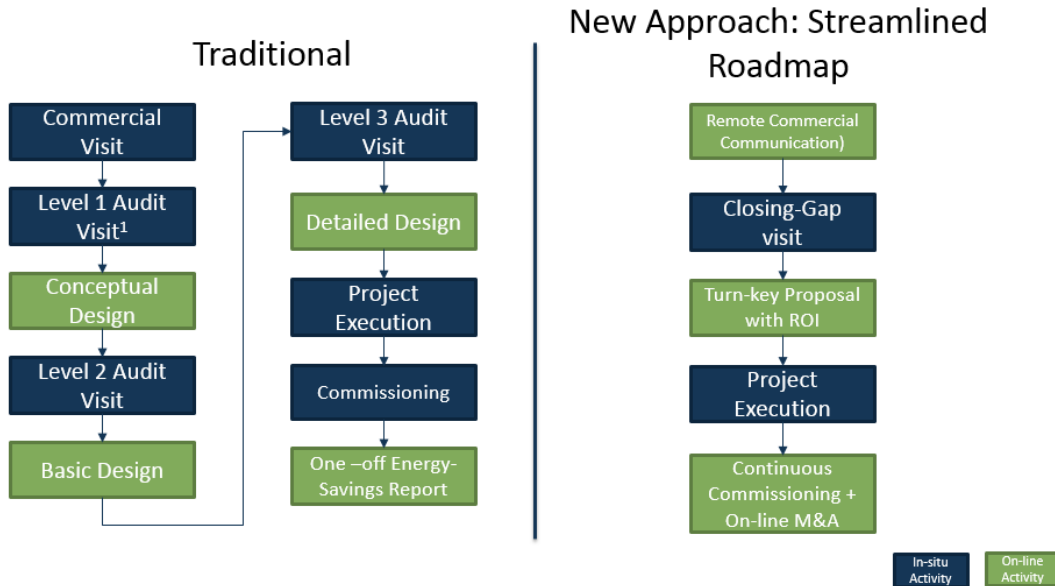

Figure 2: How traditional project methodology has changed

3. PROJECT DESCRIPTION

This paper uses a real-world success case of a Deep Building Renovation (technological upgrade in control and monitoring system) project which was developed from 2014 to 2016.

The project-host company is located in Singapore while the energy consulting company (contractor) is located in Macau SAR, China with headquarters in UTAH, US. Singapore-based contractors also participated in the project development.

The project-host company is dedicated to manufacture and commercialize health care products which production processes require controlled air conditions for temperature, humidity, pressure and cleanliness. Therefore, the HVAC system is a fundamental element in the building where production occurs. The scope of the project included production buildings, administrative offices and other facilities where air conditioning is required.

The air conditioning system is composed of a central chiller plant (ChP) a chilled-water distribution system and 70 air handler units (AHUs). The Table 1 shows the main characteristics of this system.

Chillers Power Peak Demand	Served Area	Peak Cooling Demand
Kilo Watts	Square Meters	Refrigeration Tons
1146	Production – 14,600	2,000
	Office – 5,900	
	20,500	

Table 1: Basic description of the HVAC system

3.1 Project Scope

The project scope was to identify, select, define and implement energy-saving improvements to the HVAC system by designing a monitoring and analytics platform that provided the right data to drive the system optimization. Project-tasks breakdown included the following:

- Monitoring hardware, installation and Integration
 - Furnishing and installation of electric sub-meters
 - Network hardware
 - Integration Hardware
 - Data Integration
- Analytics software programming and integration
 - Monitoring and Analytics (M&A) software license
 - Analytics software programming
 - System mapping, classification and investigation
 - Development and installation of customized analytics software
 - Findings summary
- Implementation of recommended measures
 - Control Logic changes
 - Hardware refurbishment were required
 - Measurement and Verification
- On-going M&A maintenance
 - Software updates
 - Configuration Management

3.2 Monitoring and analytics platform

The project deployed a M&A platform (platform is the combined infrastructure of hardware, software, telecommunication, internet, cloud service, and human support) which allowed identification and visualization of energy-efficiency opportunities via trend analysis and sequence of operation rules. When the M&A application **detects an energy efficiency opportunity, it creates a notification called a “Spark” and visualize the problem by send** an email or text message with the relevant information required to fix the problem in the HVAC system. Some examples of these rules as follows:

AHU - Supply Temperature Not Met: Identifies when supply air temperature consistently does not match the set point. This is an indication of energy waste due to either over heating or cooling, as well as lack of comfort.

Boiler & Chiller Cycling: Detects when the boiler or chiller status is cycling on and off, and determine equipment status by preferencing points.

AHU - Valve Leak: Measures entering and leaving temperature from each coil individually, taking advantage of any temp sensors available and accommodating for different AHU designs.

Flow Through Offline Equipment: Detects flow through offline equipment have been deployed. This is measured by the temperature drop through equipment that is off, with support for temperature preferencing. These have been deployed on chiller plant equipment.

The project deployed the following rules for AHUs and TUs:

AHU - 100 rules

Terminal Units – 40 rules

However, the M&A application has rules for the following systems as well:

Boilers – 30 rules

Chiller – 50 rules

Meters – 10 rules

Pumps – 5 rules

3.3 Project results in energy-efficiency

The project-host maintenance staff is using the Sparks to increase the efficiency of the HVAC. Figure 3 is an example of the Spark: “Supply AHU Temperature Not Met”.

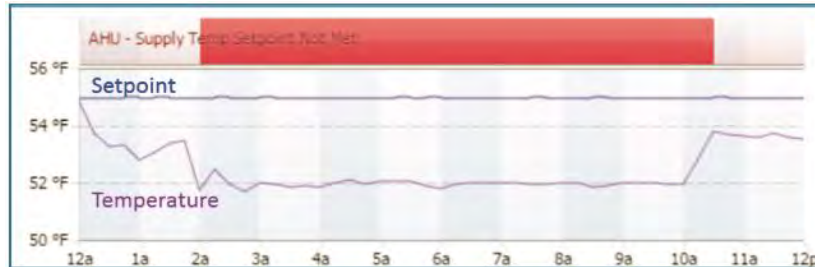

Figure 3: Issue detected by M&A application.

In this case, further investigation on the AHU identified a problem with the actuator that operates the chilled water valve. The valve was kept always open even though the controller commanded it to close. As expected, the fix of this issue led to save energy as chilled water started to be properly supplied.

This project successfully implemented changes in control and corrected equipment deficiencies that saved 152 kW power demand and 1,331,520 kWh/year of consumption, which represents \$170,340 (USD) per year in operating cost saving. The optimization of AHU workloads led to a reduction in chiller load by 10%.

With these actual benefits, the project pay-back period is 1.8 years, only considering tangible and measurable energy-saving benefits and based on an electricity tariff of 0.128 USD/kWh. If other maintenance and operational benefits are included (such as: releasing chiller capacity and electrical infrastructure), then the pay-pack period would be less than one year. In some companies, it is difficult to include in financial analysis of benefits that are not supported by a meter. The decision-making process is very critical for company success, thus a well-defined process, such as TCA, is recommended in order to include those benefits that are not easily measurable (Navarro, 2012).

Additionally, significant effort was made to document and clarify equipment inconsistencies and gain vision for future improvement.

3.4 Project results in maintenance management

Although most of the Spark algorithms are oriented to identify energy-efficiency opportunities or issues, they also identify equipment failures due to the close relationship between equipment performance and efficiency. For instance, the Spark for AHU - Valve Leak is intended to save energy (a leaking valve might allow cooling in a room that is not required, therefore wasting energy).

At the same time, the Spark also detects a maintenance issue since the leak may get worse. The AHU may become inoperable which is more expensive to repair. Even worse, the leakage may lead to a catastrophic damage if the AHU is part of a critical air conditioning system such as a gateway or data centre where moisture level has low tolerance.

The M&A application has led to significant benefits in maintenance management and equipment reliability. Using the M&A application, the maintenance staff is able to schedule work in advance in a way that has moved HVAC system maintenance from corrective to predictive as equipment failures can be identified in an early stage.

Furthermore, given the historical data storage, some maintenance teams have been able to conduct root cause analysis and highlight common issues in some types of equipment, such as valve models with design defects or those not appropriate for the application where installed.

3.5 Key factors for a successful energy-efficiency project

This paper case study identified the following key factors for a successful energy efficiency project:

Change Management

An energy-efficiency project is not only the deployment of a new technology; it is a profound change in the organization where the technology is being deployed. A well-managed project deploys a change management approach in order to facilitate the knowledge transfer.

From client company to contractor/ consultant, thus the contractor captures the right information at the right time, mainly during the steps of energy saving measure identification, business case development, design review, build and commissioning, amount others.

From the contractor/ consultant to client company, the technology is well-understood in a way that the users are able to:

- Utilize the technology to realize the benefits as per the business case
- See how these benefits impact both the client company goals and themselves

Quality of the Solution

As M&A infrastructure is integrated into the existing hardware and software, it is critical to define the minimum software and hardware requirements to guarantee a low-cost solution that will be able to paid via energy savings. At the same time, the solution must be high quality with flexibility (able to connect to different protocols) and scalability for future expansions. Appendix A shows the different options for data transfer to a M&A platform.

4. APPENDIX A: DATA TRANSFER OPTIONS FOR A M&A PLATFORM

There are different options to connect a M&A system, the following diagram shows four proven ways of doing it. The efficiency and suitability of each option depend on each case based on: IT landscape, cybersecurity policies, cost, among others.

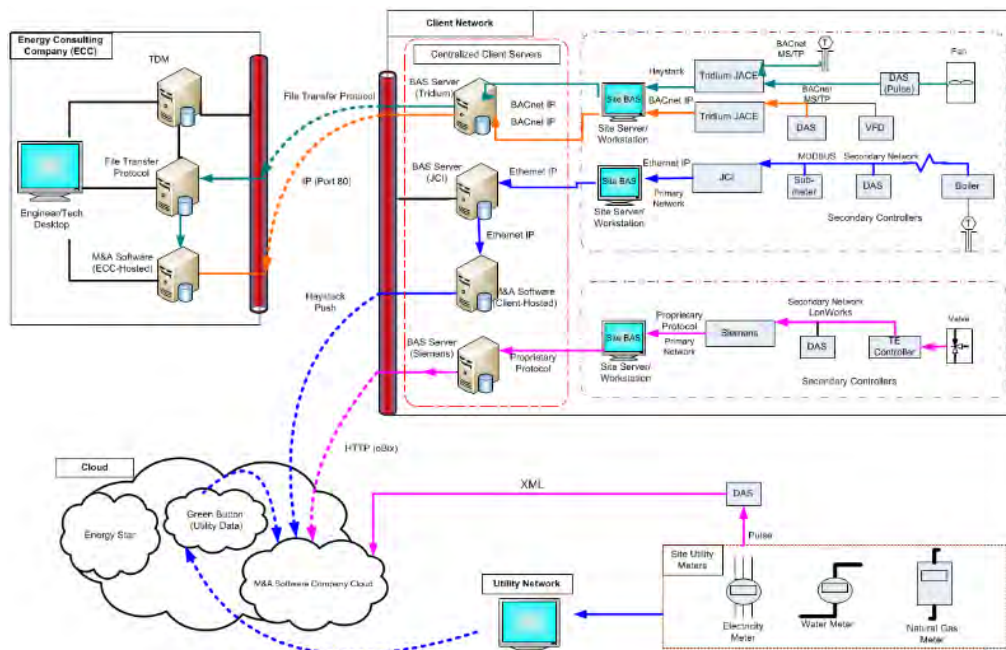

Option 1 (Teal ---):

- Meter pulse data acquisition device (DAS) to Site BAS.
- Primary Controllers transfer data to centralized BAS server

- Centralized BAS server transfers data by file transfer protocol (FTP) to M&A Software server (Energy Consultant-Hosted).

Option 2 (Orange ---):

- Meter secondary controllers and transfer data to primary controllers
- Primary Controllers transfer data to centralized BAS server
- Centralized BAS server transfers data to M&A Software (Cloud)

Option 3 (Pink ---):

- Pulse data acquisition from utility meter to M&A Software (Cloud)
- Primary Controllers transfer data to centralized BAS server
- Centralized BAS server transfers data to M&A Software (Cloud)

Option 4 (Blue ---):

- Meter secondary controllers and transfer data to primary controllers
- Primary Controllers transfer data to centralized BAS server
- Centralized BAS server transfers data to M&A Software (Cloud)
- Green Button transfers data to M&A Software (Cloud)

REFERENCES

- [1] Morioka, T; Saito, O and Yabar, H. 2006. The pathway to a sustainable industrial society. *Sustain. Sci.*, 1, 65-82
- [2] Cobb, C. "ARE THERE PROJECT MANAGERS IN AGILE?" Retrieved from: <http://managedagile.com/2016/06/20/need-project-managers> . [Retrieved on 24 September 2016]
- [3] Navarro, R. 2012. Desarrollo Sostenible: Caso De Producción Más Limpia En Sistema De Acondicionamiento De Aires De La Fundación Educativa En Montelibano, Córdoba. Externado University, Colombia.

Poster Session

Vertical Farm: Integrating Multifunctional Microalgae Cultivation into the Sustainable Built Environment

LEE Tzan-chain^a

^a Biodiversity Research Center, Academia Sinica, Taiwan, crane173@yahoo.com.tw

ABSTRACT

The world's first algae-powered has been built in Hamburg, Germany. In the building, microalgae are cultivated in **the glass elements that make up its "bio skin"**. Microalgae are sustainable energy source for biofuel production that can transfer solar energy to chemical energy by photosynthesis. Microalgae are known to exhibit 20-fold higher biomass production than agricultural crop plants. Microalgae can culture in glucose-contained culture medium in dark condition, it is similar fermentation culture and produce many commercial products, e.g. DHA, lutein, biodiesel and biomedical compound.

In this **article**, I would like to share an idea about "How to design a microalgae-powered sustainable building that can utilize microalgae more efficiency", including increase biomass of microalgae in light-culture condition, and produce commercial products in high cell-density culture in dark-culture condition. This idea might help microalgae sustainable building will be become a multifunctional building.

Keywords: microalgae, renewable energy, commercial products

1. INTRODUCTION

1.1 BIQ House--- The world's first algae-powered building

There are many sustainable building using biomaterials, e. g. plants and microalgae, to decorate or integrate into building structure. Microalgae cultivation is a photosynthetically driven system applied to architectural integration in last three years. BIQ house (building in Hamburg Germany; Image 1) project is completed in April 2013. In the **building, microalgae are cultivated in the glass elements that make up its "bio skin"**. These bioreactors are used to produce energy, can also control light and provide shade.



Figure 1: The BIQ is setting new standards as the first building in the world to have a bioreactor façade. Microalgae are cultivated in the glass elements that make up its "bio skin"

1.2 Utilization of algae

Microalgae and plants are renewable energy source which can transfer solar energy to chemical energy by photosynthesis. They can capture and consume CO₂ to produce many compounds, including oxygen, glucose, oil and other organic compounds in light culture condition. Algae have efficient conversion of solar energy to biomass and electricity (20-fold higher biomass production than agricultural crop plants). However, the cell densities can't higher than 66g L⁻¹ in light culture condition. On the other hand, fermentation culture can significantly increase the culture density of microalgae (>100g L⁻¹). Until now, there are some kinds of microalgae can use fermentation culture condition for a long time by supplied carbon source (e.g. glucose, acetic acid and glycerol), without light irradiation. In the culture condition, algae would be change their biochemical pathway, and can be use in waste water clearance, or produce high-value products: biodiesels, antioxidants, bioplastics, pigments, cosmetics compounds, etc. (Figure 2). Thus, it is important to increasing production efficiency of energy and foods.

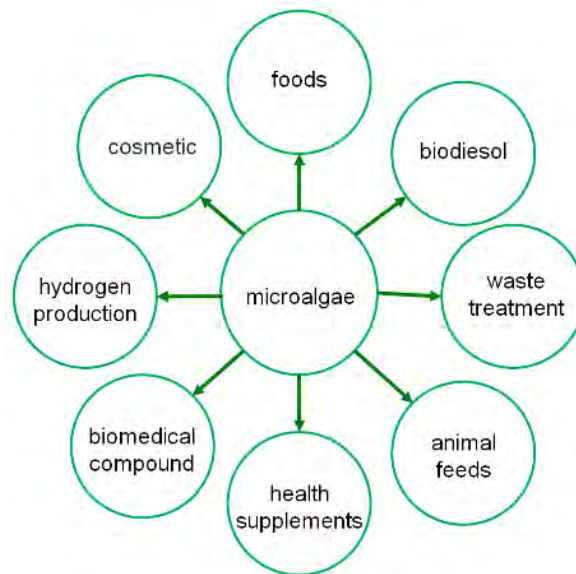

Figure 2: Microalgae are multifunctional organisms, as a powerful tool for the production of commercial biomolecules

1.3 Change culture conditions can modify physiological state and increase productive efficiency of the final products

Beside photosynthesis, algae can change their physiological characteristic with different culture conditions. For example, heat and light stress can increase antioxidants production. *Haematococcus pluvialis* can synthesis and accumulated astaxanthin when cells under conditions of cellular stress [4]. Many alga cells can synthesis GABA (γ -Aminobutyric acid), DHA and EPA in fermentation culture. In the article, I only share an opinion about how to use different culture conditions to increase the economic efficiency of microalgae to integrate into the sustainable built environment, but not showed experimental data.

Algae are photoautotrophic organisms that carry out photosynthesis for maintain their life. However, the production of high-value products from microalgae using fermentation culture in the dark (heterotrophic production) has very successful to date. The final products were very different in two culture conditions, and these two conditions can be continued to recalculate. The characteristic of this two culture conditions as shown in below.

	Light condition	Dark condition
Energy pathways	Autotrophic	Heterotrophic (fermentation)
Carbon source	CO ₂	Sugars (including glucose)
Growth rate	Fast	Slow
Cost	Low	High
Final products	O ₂ , H ₂ , glucose, and antioxydants.	CO ₂ , health supplements, biodiesel, biomedical compound.

Generally speaking, microalgae culture in light condition in glass elements. In the culture condition, algae can fix CO₂ and utilize inorganic nutrition media. It would be growth fast during log phase and slow down the rate until stationary phase. In my suggestion, during stationary phase, collect 90-95% volume of the algae suspension medium as fermentation materials. The fermentation materials can influx into inorganic nutrition media and add sugars as carbon source. It is very important that fermentation culture must keep the concentration of nutrition media (the same with light culture) and sugar (1.5~0.8% w/v). Fermentation culture without light irradiation, and can maintain high culture density of microalgae. On the other hand, microalgae cells would be recovered to the log phase after add new inorganic nutrition medium into the glass elements.

Microalgae can storage glucose as starch in light culture condition. In dark condition, microalgae can hydrolysis starch to glucose during fermentation process and the added sugars can be transfer to highly productive, in terms of biomedical compound, oil (e. g. EPA and DHA), and CO₂. Beside CO₂ can be reused in light culture, the economics are greatly improved when considering the high amount of product on a per liter basis (high titer). The production cycles, and the high productivities are not attainable with autotrophic algae (culture in light condition).

As shown in Figure 3, the light-dark recirculate culture can enhance the economic values of microalgae-powered building.



Figure 3: A model system for light-dark recirculate culture

REFERENCES

- [1] IBA Hamburg – BIO. <http://www.iba-hamburg.de/en/projects/the-building-exhibition-within-the-building-exhibition/smart-material-houses/big/projekt/big.html>
- [2] First algae powered building goes up in Hamburg. <http://phys.org/news/2013-04-algae-powered-hamburg.html>
- [3] Solovchenko A. E. (2015). Recent breakthroughs in the biology of astaxanthin accumulation by microalgal cell. *Photosynth. Res.* 125, 437–449.

Grid Connected Photovoltaic System Potentials and Performance in 4 University Campuses

Chanikarn YIMPRAYOON^a

^a Faculty of Architecture, Kasetsart University, Thailand, arccks@ku.ac.th

ABSTRACT

Photovoltaic (PV) system installation has grown exponentially in the last few years because of growing concerns about the environmental impacts from fossil fuel and nuclear energy. Solar energy is abundant, especially in locations near the Equator. Grid-connected PV system prices are also decreasing, so many projects found it was affordable. Using renewable energy is also a key a project can use to demonstrate commitment to sustainable development. A common problem in Thailand in promoting the use of grid-connected PV systems is the unpredictable incentive program from the government and the lack of confidence in the system with a few demonstration case studies. Universities as educational institutes could be pioneers in successful large installation demonstration projects.

Kasetsart University is the largest public university in Thailand with four teaching campuses across the country and several research stations, mostly in agricultural fields. This study aimed to evaluate the potential of each campus in accommodating rooftop PV. The results demonstrate the maximum PV installation potential of each campus, as well as the specific installation location for each building, the predicted annual electricity production, and the feasibility of the installation. However, more incentive programs or the integration of PV systems into building envelopes could make the investment return more favourable. The results could help other similar university campuses evaluate their potential, moving toward self-sustainable energy production as demonstration projects in the communities are successful, and encourage more PV installation in the country.

Keywords: grid-connected photovoltaic system, sustainable neighbourhood, green university

1. INTRODUCTION

Thailand imported more than 80% of its fuel from outside the country—mostly crude oil and natural gas—resulting in country energy insecurity. The country actually has a lot of sunlight due to its location at 14°N of the Equator. Despite the monsoon seasons and frequently overcast sky, the average solar energy received per day is approximately 5 kWh (Department of Energy Development and Efficiency and Department of Physics, 1999) which is high, compared with other leading countries in photovoltaic (PV) installation. PV systems have a very low environmental impact compared to other sources of energy for electricity production, especially fossil fuels. PV systems can be easily installed on building rooftops without the need for land. Its modulation characteristic makes the system size and shape flexible. Solar energy has the highest capacity compared to other energy sources: it is free, unlimited, and available everywhere. When the system is in operation, there is no noise, no pollution, and it requires very low maintenance.

Electricity peak demand in Thailand occurs during the day, especially in the afternoon in summer when the temperature is high from strong solar radiation resulting in heavy use of air conditioning systems. At the same time, solar energy is the primary source of PV electric generation. The amount of electricity generated from PV has a strong correlation to the electricity peak demand. PV has high potential to be used for peak load mitigation during heavy electricity demand periods. Many studies have demonstrated that PV systems could help reduce grid peak load stresses (Perez and Collins, 2004, Perez et al., 2004, Perez et al., 2009).

Institutional buildings such as those in university campuses or commercial building complexes have plenty of unused rooftop area free of shading. These available areas can be used for green roof, collecting rain water, or installing PV systems that can provide electricity both for the buildings and to help relieve grid stress due to peak demand (Yimprayoon and Navvab, 2011).

UI Green Metric, the green university ranking initiated by the Universitas Indonesia in 2010, assigned the highest score proportion to the energy category in all of the rating versions. The latest version, 2016, has increased the score related to renewable energy from 3/100 to 5/100 which emphasized the importance of renewable energy

awareness in this building type. Kasetsart University was ranked number one in Thailand for the UI Green Metric in 2011, the rating inception year. The university has continued to participate in the ranking process since then. However, renewable energy is not yet implemented much because of the lack of information and the lack of **confidence in such a technology**. This study demonstrates the potential of Kasetsart University's four campuses for implementing PV systems on their building rooftops in a tropical climate, thus increasing the university's UI Green Metric score and encouraging similar projects for more PV installation.

2. KASETSART UNIVERSITY

Originally an agricultural based educational institute, Kasetsart University (KU) owns many lands and is the biggest public university in Thailand, both in terms of area and enrolled student numbers. The university has seven campuses, four student training facilities and 16 research stations in various agriculture fields across the country. The four main campuses with study activities, Bangkhane, Si Racha, Kampangsan, and Sakon Nakhon locations are shown in Figure 1. There are currently more than 67,000 enrolled students. With its missions and context, the university has many advantages in promoting sustainability development.



Figure 21: Locations of four Kasetsart University campuses

2.1 Kasetsart University: Bangkhane campus

Bangkhane Campus is located in the northern part of Bangkok. It is the oldest KU campus established in 1887. The campus has more than 36,600 enrolled students and 1.41 km² land area and more than 250 buildings. There are 16 schools: Faculty of Agriculture, the Faculty of Agro-Industry, the Faculty of Architecture, the Faculty of Business Administration, the Faculty of Economics, the Faculty of Education, the Faculty of Engineering, the Faculty of Environment, the Faculty of Fisheries, the Faculty of Forestry, the Faculty of Humanities, the Faculty of Science, the Faculty of Social Sciences, the Faculty of Veterinary Medicine, the Faculty of Veterinary Technology, and the Graduate School.

2.2 Kasetsart University: Kampangsan campus

Kampangsan Campus is located in Nakorn Pathom Province, 90 kilometers east of the Bangkhane campus. The campus has more than 13,000 enrolled students and 12.72 km² land area—mostly agricultural lab areas—and more than 350 buildings. There are six schools: the Faculty of Agriculture, the Faculty of Engineering, the Faculty of Education and Development Sciences, the Faculty of Liberal Arts and Science, the Faculty of Sports Science, and the Faculty of Veterinary Medicine

2.3 Kasetsart University: Sakon Nakhon campus

Sakon Nakhon Campus is located in Sakon Nakhon province in the northeastern region in Thailand. The campus has more than 6,800 enrolled students and 7.52 km² land area with more than 35 buildings. There are four schools: the Faculty of Natural Resources and Agro-Industry, the Faculty of Science and Engineering, the Faculty of Liberal Arts and Management Sciences, and the Faculty of Public Health.

2.4 Kasetsart University: Si Racha campus

Si Racha Campus is located in Rayong Province in the eastern region of Thailand. The province is famous for Pattaya beach, and the industrial estate Maptaphut. Sitting on the hillside, the campus has more than 10,000 enrolled students and 0.32 km² land area with more than 40 buildings. There are five schools: the Faculty of Management Science, the Faculty of Engineering at Si Racha, the Faculty of Science at Si Racha, Faculty of Economics at Si Racha, and the International Maritime College.

3. METHODOLOGY

3.1 Roof potential survey

Basic data of building names, locations, sizes, and floor areas were obtained from the university facility offices at each campus. Field site surveys, together with satellite images obtained from Google Maps were used to update or correct the basic data. The potential of each building was determined by surrounding shades, structure conditions, working possibility, and obstructions on the roofs. Aerial maps using an Unman Aerial Vehicle (UAV) were produced for two campuses, Bangkhane and Si Racha.

3.2 PV systems

PV systems used in the calculation were 250 W crystalline silicon modules, size 2 m x 1 m. The modules would be mounted on the structure attached to the roof away from obstructions at the actual roof orientation and tilt angle. Space between PV arrays and roofs is no less than 0.10 m to allow proper ventilation to reduce heat accumulation.

Electricity produced from PV systems was estimated using PVwatts Calculator (<http://pvwatts.nrel.gov/>). The inputs were as follows:

- Weather data source: IWEC BANGKOK, THAILAND
- Latitude and longitude: 13.92° N 100.6° E
- Module type: Standard polycrystalline silicone
- Array type: Fixed (open rack)
- System losses: 14%
- Inverter efficiency: 96%
- DC to AC size ratio: 1.1
- Capacity factor: 15.4%

The highest PV potential was 1,351 kWh/year when the module was tilted 14 degrees from the ground and oriented toward the south. Other orientations and tilt angles potential proportional to the highest potential tilt angle and orientation are shown in Table 1. Electricity produced from PV systems was estimated using PVwatts Calculator (<http://pvwatts.nrel.gov/>). The inputs were as follows:

Tilt angle

Azimuth*	0°	15°	30°	45°	60°	75°	90°
345°	97	90	80	66	51	40	31
0°	97	90	79	65	50	39	30
15°	97	91	80	66	51	40	31
30°	97	91	81	68	54	43	34
45°	97	93	83	71	58	47	37
60°	97	94	85	74	62	51	41
75°	97	95	87	77	66	55	44
90°	97	97	90	80	70	58	47
105°	97	98	92	83	72	61	49
120°	97	99	94	86	75	62	50
135°	97	99	95	88	77	63	50
150°	97	100	97	89	78	64	49
165°	97	100	97	90	79	64	49
180°	97	100	98	90	79	64	49
195°	97	99	97	90	78	64	49
210°	97	98	96	89	77	64	49
225°	97	97	95	87	76	63	49
240°	97	96	93	85	74	62	49
255°	97	95	91	83	72	65	48
270°	97	94	89	80	69	57	46
285°	97	93	87	77	65	54	43
300°	97	92	84	73	61	50	40
315°	97	91	82	70	57	46	36
330°	97	91	81	68	54	42	33

* 0 = North, 90 = East, 180 = South, 270 = West

Table 1: PV output performance proportion of various tilt angles and orientation for Bangkok.

3.3 Investment cost

PV investment in Thailand is approximately 65 Baht/rated Watt installed. This price includes PV arrays, all electrical related materials, inverters, mounted structure, and installation.

4. RESULTS AND DISCUSSION

Roofs with PV installation potential on each campus are shown in Figure 2 - Figure 5.



Figure 2: KU Bangkhane campus PV roof top potential

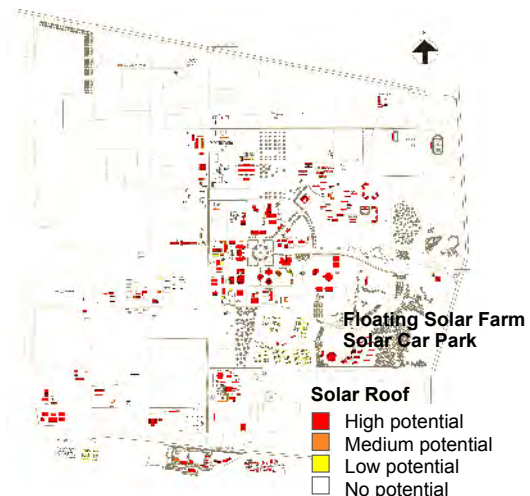

Figure 3: KU Kampangsan campus PV roof top potential

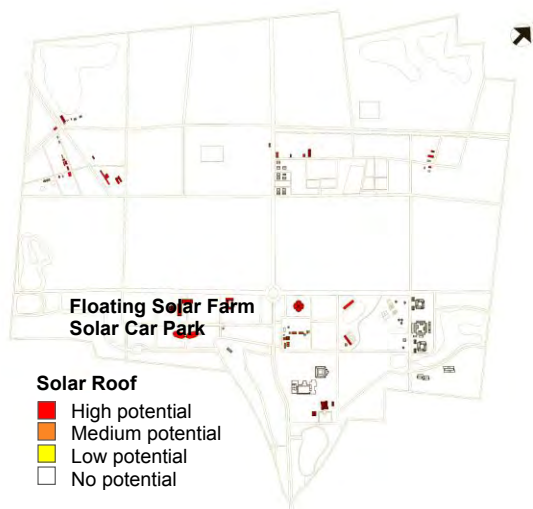

Figure 4: KU Sakon Nakhon campus PV roof top potential



Figure 5: KU Si Racha campus PV Roof top potential

The results of rooftop PV potential, investment and simple payback period are provided in Table 2.

	Bangkhane	Kampangsan	Sriracha	Sakon Nakhon
Land area (km ²)	1.41	12.72	0.32	7.52
No. of Building	254	358	44	38
Building area (m ²)	904,549.98	1,013,356.19	102,282.10	78,647.32
No. of Building with solar roof potential	177	191	25	19
Roof area suitable for PV system (m ²)	255,456.64	212,486.40	52,232.63	42,508.00
Rated power PV Potential (MW)	15.62	15.69	2.34	2.87
Electricity production (MWh/year)	19,962.46	19,440.87	2,742.76	3,677.83
Campus electricity consumption in fiscal year 2015 (MWh)	61,064.43	13,202.65	8,579.46	3,975.77
Energy Reduction	33%	147%	32%	93%
Peak reduction (MW)	10.94	10.98	1.64	2.01
Investment (Mbaht)	937.32	941.21	140.60	172.32
Payback period (Year)	10.43	10.76	11.39	10.41

Table 2: Rooftop PV potential, investment and rate of return for KU Four campuses.

Bangkhane and Si Racha campuses are located in urban areas. They have many large buildings, many big trees, and limited open spaces. Fifty-five to 70% of the buildings have PV rooftop potential; however, the electricity produced could account for only 32-33% of the campus' total electricity use. Energy saving measures are recommended to be implemented intensively to reduce energy use and increase percentages that renewable energy can account for.

Kampangsan and Sakon Nakhon campuses, on the other hand, have many open spaces mostly used for agricultural labs, livestock farms, and dry dipterocarp parks. The majority of buildings are small and use passive cooling or small air conditioning systems, resulting in much less electricity use intensity compared to the Bangkhane and Si Racha campuses. Kampangsan campus roofs have the potential to accommodate PV systems that can generate electricity more than the amount that the campus needs in one year, while the Sakon Nakhon campus can have PV systems produce electricity almost equal to the amount that the whole campus uses in one year. The two campuses could then be made net zero energy campuses.

The university can invest in PV systems one building at a time. The payback period is approximately 10 to 12 years without subsidy. There are two other possible investment options which are 1) Loan money from Kasetsart University Cooperatives Bank (KU Coop) with a very low interest rate, and 2) Sign solar power purchase agreements with a private company. Both options could result in large-scale solar rooftop investment which could reduce the investment cost by approximately 20%. The income each year would need to be shared, 66% with KU Coop for option 1 and 50% with the private company for option 2. The university could then possess the systems after the loan has been paid (25-30 years - option 1) or the contract has ended (21-25 years – option 2).

Installing PV systems on all roofs that have potential in PV system installation at four campuses could provide approximately 53% of the electricity demand. This will increase points for KU in UI green metric rating assessment as well; however, grid system improvement might be needed. The university would need to work closely with **Thailand's Metropolitan Electricity Authority and Thailand's Provincial Electricity Authority to make the project possible and successful.**

REFERENCES

- [1] Department of Energy Development and Efficiency, Ministry of Energy, Technology and Environment, & Department of Physics, Faculty of Science, Silpakorn University, 1999. Solar Radiation Map of Thailand.
- [2] Perez, R. & Collins, B. 2004. Solar Energy Security: Could Dispersed PV Generation Have Made a Difference in the Massive North American Blackout? *Refocus*, 5, 24-28.
- [3] Perez, R., Kmiecik, M., Hoff, T., Herig, C., Letendre, S., Williams, J. & Margolis, R. Availability of Dispersed Photovoltaic Resource During the August 14th 2003 Northeast Power Outage. OR ASES National Solar Conference 2004, 2004 Portland, Oregon.
- [4] Perez, R., Taylor, M., Hoff, T. & Ross, J. P. 2009. Redefining PV Capacity. *Public Utilities Fortnightly*.
- [5] Yimprayoon, C. & Navvab, M. Applications of Grid-Connected Photovoltaic System in Large Institutional Buildings. The SOLAR 2011 National Conference 2011 Raleigh, NC.xxx

Track 2: Practices & Policies for High-Performance Buildings

Session 1.4: Practices Review of High-Performance Green Buildings

When will Hong Kong build its first Passive House? : Concepts and Case Studies around Asia show great possibilities for Energy Savings

Anne JACOBS^a

^a BASF, Hong Kong SAR, anne.jacobs@partners.basf.com

ABSTRACT

The Paper explains the history and basic technical principles of the Passive House Concept in the context of the need for more energy efficient buildings. Several pilot projects around Asia are introduced. These projects show the wide adaptability of the concept, with examples of a single family home, an office, a hotel and a multi-family high-rise. As all projects are located in different climate zones, they also offer insights into adaptation to the climates.

The paper evaluates the possibility to use the Passive House Concept for Hong Kong. It explains why the concept could work very well for this city where energy consumption in buildings is one of the highest worldwide. In addition to significant energy savings, a Passive House also contributes to healthier indoor air quality due to its ventilation system with energy recovery.

Keywords: energy efficiency, indoor air quality, Hong Kong

1. BACKGROUND

It is well known that worldwide, buildings account for about 40% of global energy use and for about one third of energy-related GHG emissions. (UNEP, 2017).

In Hong Kong the figure is even more extreme: buildings consume an **incredible 90% of all the city's electricity and emit more than 60% of the city's GHG. (HKGBC, 2014).**

Much of the rise in energy use by buildings can be attributed to increased demand for cooling and heating. Whereas some time ago people were happily using open windows or fans to cool their apartments or work spaces in summer, now ever-growing numbers of people live in air-conditioned dwellings. Mobile heating units replace warm clothes in winter time, and dehumidifiers run around the clock in the humid season. More and more people strive for comfortable dwellings, which are no longer regarded as luxury. This is a worldwide trend: with advancing urbanization, comfort levels are rising, too.

Yet it is possible to provide the comfort people are longing for and at the same time reduce the energy consumption **of buildings to a more sustainable level. Widely used in Europe and America, a "Passive House" can provide exactly the comfort wished for - at a fraction of the current energy consumption of buildings**

2. SHORT HISTORY OF THE PASSIVE HOUSE CONCEPT

The first Passive House was constructed in Germany in 1991. This single family, row house proved the feasibility of an idea evaluated academically in previous years by Wolfgang Feist during his research in Sweden, together with his host Professor Bo Adamson. The two men followed up on the concept and Feist later founded the German Passive House Institute (PHI) to promote and facilitate the idea. In the early years, the Passive House concept attracted mainly visionaries, but it soon became more mainstream. With the increasing demand for technology suitable for this type of buildings, prices for improved building elements began to drop, and it became more and more affordable to construct this way. Reduced energy costs quickly offset higher investment at the construction phase.

The concept began to be applied to non-residential buildings like schools, offices, hotels and special use buildings; the projects also became bigger in size.

3. THE BASIC PRINCIPLES OF PASSIVE HOUSE

The Passive House is not a new concept, and the name is not protected by copyright. The concept is open to anybody who understands its principles. It is basically a comfort-improved, low-energy building brought to a new level. Its energy demand has been reduced so significantly that traditional heating or cooling systems are unnecessary. The official definition of a Passive House given by the German Passive House Institute reads as follows:

“A Passive House is a building, for which thermal comfort (ISO 7730) can be achieved solely by post-heating or post-cooling of the fresh air mass, which is required to achieve sufficient indoor air quality conditions – without the need for additional recirculation of air.” (Passipedia.org, 2017)

To achieve good thermal comfort without a standard heating or cooling unit, some principles need to be observed (see Figure 1 and Figure 2):

- The building needs to be insulated very well. This will help to keep the indoor comfort steady. Typical thickness of insulation would be between 4 and 30 cm – depending on material and climate.
- The building needs to be airtight, in order to hinder unwanted air exchange with outdoor air - if the outdoor air is too cold, too hot or too polluted.
- An external shading system needs to be installed to prevent the sun from heating up the building in summer time.
- Thermal bridging needs to be reduced. This also contributes to a high quality construction standard.

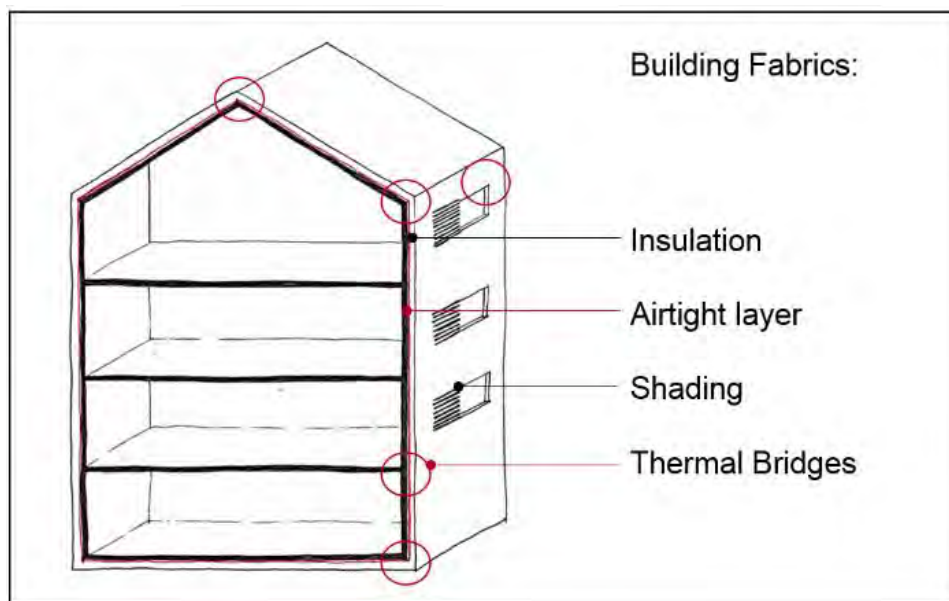

Figure 1: The passive house principles: improved building envelope (Source: BASF)

- The building services need to include a mechanical ventilation unit with energy recovery and filters for most climate zones. This is to ensure best indoor air quality at lowest energy consumption.

Innovative hot water production or further energy recovery solutions help to further improve the performance of the building.

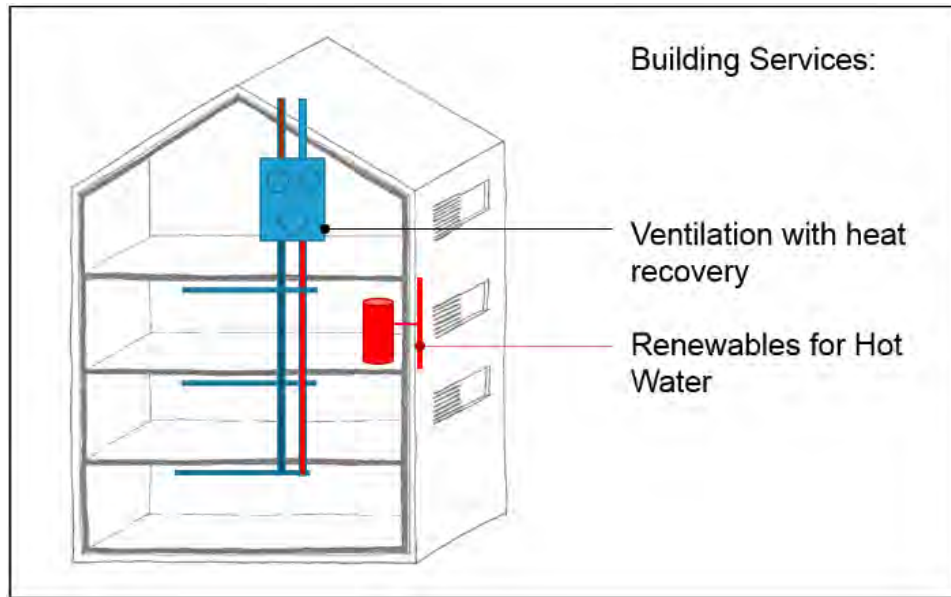

Figure 2: The passive house principles: ventilation with heat recovery (Source: BASF)

A Passive House can be certified by PHI or their certification partners worldwide to ensure the quality standards are met. For example, this certification helps to make sure that it reaches the required energy standard, and indirectly also provides assurance of the construction quality. Because reaching Passive House standards requires extreme dedication to every detail in construction, Passive House buildings achieve excellent construction quality standards, which often also result in reduced maintenance costs.

4. EXAMPLES IN ASIA

While the first examples of Passive Houses were all small buildings, constructed in northern European climate zones, the concept is now spreading all over the planet and is used for large-scale buildings, too. The PHI, among others, has conducted studies on adapting the concept to all climate zones, and several examples have already been constructed and are being monitored.

4.1 Korea and Japan

As most of the South Korean and Japanese climate zones are very well suited for this standard, the concept was quickly adopted there, and several Passive Houses have been registered with PHI. Passive Houses are viewed as highly desirable: One Japanese company for prefabricated houses recently extended their portfolio to include this building concept (see Figure 3).



Figure 3: Design for the new pre-fabricated passive house (Source: Hokushu)

To not lose any indoor area due to higher insulation standards, they are using one of the thinnest insulation materials available (see Figure 4).



Figure 4: Aerogel insulation for space saving (Source: BASF)

4.2 Chinese passive house projects

In China, the Passive House concept was explicitly recommended in the 13th Five Year Plan, leading to high interest in the topic and several pilot projects. The additional benefit of very good indoor air quality has also created interest in the Passive House construction method.

The first ever certified Passive House in China was the Hamburg House in Shanghai, which was constructed in 2010 as an office building (see Figure 5). This showcase building used innovative insulation materials, high performance windows, airtight layers and efficient building services, none of which were standard in the Chinese market. Therefore, the building also served as a learning project for all of the building experts involved.



Figure 5: The hamburg house: thin and efficient insulation for the external walls and healthy indoor air (Source: BASF)

The first certified Passive House for the hot summer and cold winter climate of the Yangtze River Delta region in China was a hotel (see Figure 6). In addition to being constructed according to the Passive House principles, the building was also certified according to three sustainability standards - China Three Stars Green Building Evaluation Standard, DGNB (German Sustainable Building Certificate) and LEED (Leadership in Energy and Environmental Design).



Figure 6: The passive house hotel, innovative neopor® insulation, efficient spray foam insulation for the roof (Source: BASF)

As there is a high demand for Passive House construction, due to energy efficiency targets as well as due to improved indoor air quality, there are currently many projects in the planning phase.

A very interesting example will be the first high-rise Passive House, currently under development in Tianjin (see Figure 7). This project recently received Pre-Certification by the PHI. This building will highlight the adaptability of the Passive House concept to standard building archetypes. It will most likely lead the way from showcase houses to standard construction on a larger scale.



Figure 7: Planning for the first certified Chinese high rise passive house (Source: BASF)

With the growing numbers of buildings constructed according to Passive House principles, the availability of innovative construction solutions is also increasing and the costs for these solutions are dropping.

5. WHEN WILL **HONG KONG, ASIA'S WORLD CITY, BUILD ITS FIRST PASSIVE HOUSE?**

Although Hong Kong is seen as a technology and innovation leader in many areas, the city has yet to construct its first Passive House. Even though there are sustainable buildings being constructed in Hong Kong, none meets the Passive House standard. Considering the extremely high electricity consumption of the building sector, the savings potential is compelling. Adding the advantage of good indoor air quality, it can only be a matter of time until the first Passive House will be constructed in Hong Kong – which will serve as a showcase for others to come.

The conditions are right: there is a high demand for comfortable, high-quality dwellings; rising awareness of sustainability is making people look for energy-efficient buildings; and the construction sector is technologically ready to take on the task.

Hong Kong's climate is suitable for constructing a Passive House. Even a typical Hong Kong high-rise building in a dense neighbourhood could implement the standard, as in contrast to other climates, the building would not require significant solar gains to heat it up in winter. The few cold days in winter could easily be covered in a well-insulated building by the heat recovering unit. In summer, shading in a densely-inhabited area could help the building keep cool, and in combination with good insulation and the energy exchange of the ventilation system, the air inside the dwellings would stay comfortably cool.

So why has this concept been so well received in mainland China, but not in Hong Kong? Do construction experts believe that insulation works only to keep out the cold? Many examples worldwide prove the opposite. If Hong Kong really wants to position itself as a leader in sustainable construction, it is time for Hong Kong to build its first Passive House.

REFERENCES

- [6] Unep.org [online]. Retrieved from: <http://www.unep.org/sbci/AboutSBICI/Background.asp> [Retrieved on 23 February 2017].
- [7] HKGBC, 2014. Hong Kong Report on the State of Sustainable Built Environment. Publication.
- [8] Passipedia.org [online]. Retrieved from: <https://passipedia.org> [Retrieved on 23 February 2017].
- [9] Passiv.de [online]. Retrieved from: <http://passiv.de/> [Retrieved on 23 February 2017].
- [10] HKGBC, 2014. Market Drivers for Transformation of Green Buildings in Hong Kong, A Roadmap to Deep Energy Reductions, Executive Summary. Publication.

Insights into Energy Efficiency of hotels Constructed as Green Buildings

Duygu ERTEN^a

^a TURKECO Consulting, Turkey, derten@turkeco.com

ABSTRACT

Global climate change has already had observable effects on the environment. Hotel industry has a role to play mitigating climate change by reducing carbon emissions. This article explores the energy saving potentials in hotels by simulating several currently available scenarios at different climates by using methodical and iterative processes to evaluate potential decisions and achieve long-term goals. The information provided in this research work is based on a review of relevant literature and the results of EQUEST simulations for 3 hotels certified with LEED V3 across Turkey. Three locations were selected to represent the three climate zones in Turkey. Green criterias are evaluated according to LEED V3 certification system. Based on the findings presented in this paper, it is suggested there exists significant **energy savings potential for the Turkey's hotel industry if hotels are designed and built with sustainability principles**. The main finding after comparing the three hotel designs is that it is technically feasible to increase energy efficiency more than 60% without compromising guest comfort by using green technologies. Because the number green design and construction of new constructed hotels is low, implementing a new green building code with strict energy requirements is recommended for those developers who do not want to certify their hotels.

Keywords: green hotels, energy simulation, CO₂ reduction, LEED, DGNB, sustainability

1. INTRODUCTION

Glaciers have shrunk, ice on rivers and lakes is breaking up earlier, plant and animal ranges have shifted and trees are flowering sooner. Taken as a whole, the range of published evidence indicates that the net damage costs of climate change are likely to be significant and to increase over time. The Second Assessment Report (SAR) of the Intergovernmental Panel on Climate Change (IPCC), published in 1996, is an assessment of the then available scientific and socio-economic information on climate change. Working Group I, dealing with the scientific aspects of climate, stated that carbon dioxide remains the most important contributor to anthropogenic forcing of climate change. According to US Green Building Council, with buildings accounting for up to 30 percent of global emissions, a commitment to the rapid transformation of the global built environment seems to be one solution that the entire world can get behind.

United Nations declared that, emissions generated directly from the tourism sector account today for 5 per cent of global CO₂ emissions but may be higher. Due to similar facts, energy consumption and conservation in hotels received growing attention globally in recent years. Hotel facilities rank among the top five in terms of energy consumption in the tertiary building sector (minor only to food services and sales, health care and certain types of offices). Among non-domestic buildings, hotels belong to one of the highest emitting sector. According to US EPA, for a study that was carried out in the United States for both hotels and motels on their practices and operating costs energy represented roughly six percent of all the operating costs. The CHOSE project estimated that European hotels – which are reported to provide nearly half of the world total hotel rooms – used a total of 39 TWh (terawatt hours) in 2000, half of which is in the form of electricity. Most of this energy is derived from fossil sources, **and the hotel sector's contribution to global warming and climate change, is estimated** to include annual releases between 160 and 200 kg of CO₂ per m² of room floor area, depending on the fuel mix used to provide energy. Global hotel-based CO₂ emissions were assumed to be at the level of 55.7 Mt in 2001, while the estimated annual energy consumption for European hotel of 39 TWh, would result in emissions of more than 10 Mt of CO₂ each year.

	COST OF ENERGY/COST OF TOTAL SECTOR		COST OF ENERGY/GROSS VALUE ADDED
Other services	18,96	Air Transportation	27,1
Other mining	12,40	Production of simple metal	26,4
Precious Metal Mining	9,80	Production of paper	13,9
Road Transport	9,20	Production of other minerals-non metallic	21,2
Distribution of Water	9,10	Precious Metal Mining	20,6
Production of other minerals-non metallic	8,90	Other service actions	19,2
Air Transportation	8,90	Other mining	16,4
Sale, maintenance and repair of vehicles	7,80	Wood production	14,9
Production of paper	7,00	Plastic and rubber production	14,9
Production of simple metal	6,80	Textiles production	12,8
Transportation of water	6,70	Road Transport	10,5
Hotels and restaurants	5,40	The sooting and sewing of leather	9,9
Rental of equipments without operators	5,30	Production of chemical products	9,3
Wholesale commerce	5,30	Hotels and restaurants	8,8
Real Estate Activities	4,70	Production of electrical equipments	8,8
Retail commerce	4,50	Production of metal products	8,3
Agriculture and Fishery	4,40	Sale, maintenance and repair of vehicles	8,1
Plastic and rubber production	4,40	Water transport	7,5
Wood production	4,20	Production of cars	7,1
Textiles production	3,70	Public Governance and defence, mandatory social security	6,1
Balance	2,40	Balance	3,4

Table1: The ratios of total gross value added (right) and cost of total sector (left) to the cost for total energy. Source: Calculations prepared by Deloitte based on EU Commission Tables on Turkey data

According to Turkey's National Energy Efficiency Plan, energy costs for hotels have a considerable portion among total industry costs. Looking from this framework, as seen from the Table 1 data, the increase of energy efficiency in hotels will not only drop the cost of energy, but will contribute lowering the energy density and increase the competitiveness. The hotels designed and built according to sustainability principles and certified with green building certification systems can contribute to this national goal.

According to USGBC rankings, Turkey has made the top 10 Countries for LEED certification list, and was able to make this year's list on the strength of the 258 percent increase in the amount of year over year. Maintaining this form of commitment to transforming Turkey's national built environment holds enormous potential for the country's long term economic and environmental future since 42 percent of Turkey's net electricity consumption comes from the country's building sector.

Rank	Nation	GSM of LEED certified space (million)	Total GSM of LEED-certified and registered space (millions)	Total number of LEED-certified and registered projects
1	Canada	26.63	63.31	4,814
2	China	21.97	118.34	2,022
3	India	13.24	73.51	1,883
4	Brazil	5.22	24.50	991
5	Republic of Korea	4.81	17.47	279
6	Germany	4.01	8.42	431
7	Taiwan	3.84	9.08	149
8	United Arab Emirates	3.13	53.44	910
9	Turkey	2.95	23.74	477
10	Sweden	2.54	4.20	197
	United States	276.90	727.34	53,908

Table 2: World rankings for LEED certified and registered projects

2. STATUS OF HOTELS WITH GREEN BUILDING CERTIFICATIONS

In US alone, hotels represent more than 5 billion square feet of space, nearly 5 million guest rooms and close to 4\$ billion in annual energy use. Hotels and hospitality venues have significant opportunity to reduce negative

environmental impacts associated with guest rooms, event space, an general facility use through measures such as energy and water efficiency, waste reduction and management, sustainable and local purchasing, and the use of alternative transport. Hotels can also contribute to human health by providing healthy, comfortable, and productive indoor environments with improved indoor air quality, access to daylight and views, and occupant control of the lighting and thermal environment]. Leadership in Energy and Environmental Design (LEED) is a set of rating systems for the design, construction, operation, and maintenance of green buildings. Developed by the U.S. Green Building Council (USGBC), LEED is intended to help building owners and operators be environmentally responsible and use resources efficiently. Since 1993, it has been a popular system all around the world. In LEED, credits are all organized under the following seven categories: location and transportation, sustainable sites, water efficiency, energy and atmosphere, material and resources, indoor environmental quality, and innovation. Len Foote Hike Inn in Dawsonville, Georgia became the first LEED certified hotel in the world. Since 2004, though practitioners and advocates have been promoting LEED certification, hospitality industry was shy about using LEED. One reason maybe was the LEED criterias were not initially directed specifically at hotels. Since 2004, hotels started seeking green building certification systems.

Available studies seem examine the benefits of LEED from a cost perspective, with a focus on whether certification will reduce energy costs or empirically examine the impact of LEED certification on revenue performance on a **substantial sample of hotels. The LEED certification system's new v4 has criterias specifically designed for the hospitality industry** and is intended to create incentives for new lodging construction that meets sustainability criteria.

A recent study of 93 LEED certified hotels found that the certified hotels displayed better financial performance than a larger sample of non-certified ones. These researchers analyzed the financial results of hotels that had received the Travelocity eco-friendly hotel designation, which is based on any of a dozen different certifications. **They found that the "green" hotels recorded higher resource efficiency for both hotel operations and customer activities**, as compared to those that had not earned the designation. Thus, it may be that regardless of the certification, hotels that are involved in sustainability activities are operated more efficiently than typical properties.

DGNB is relatively a new system by German Sustainable Building Council. The DGNB has developed the CORE 14 system for international use. It is based on international standards and requirements and can be adapted to local requirements in different countries. As of August 2015, there are 17 hotels in Germany certified with DGNB and an additional project certified by ÖGNI in Austria with the DGNB System other than the one pre-certified hotel project in Turkey.

2.1 Status of hotels with green building certifications

Turkey's energy demand is increasing so does the number of new hotels built. Out of 477 buildings in Table 2, only 36 of them are hotels registered to be certified at some level of LEED. The author used the three hotel projects in Turkey for this research, aiming to be certified with LEED.

The Fairmont Hotel in **Mecidiyeköy, İstanbul received a DGNB-Gold pre-certification** but the project has not been completed and received the final certification yet.

Even though BREEAM as well as LEED and DGNB is a widely used green building certification system in Turkey especially for retail projects; there are no BREEAM certified hotels in Turkey as of August 2015.

From 2007 to 2015, the number of hotels aiming to get certification in Turkish market give us an indication that hotel industry has started appreciating the benefits of certification. The hotels aiming for green building certification in Turkey are among top-tier foreign hospitality brands, offering environmentally friendly features and practices including solar panels, green roofs, electric vehicle charging stations, rainwater collecting systems and VIP parking for electric and hybrid vehicles. The hotel buildings themselves incorporate many sustainable design and construction features, while the hotel teams include sustainability professionals to oversee environmental practices throughout the buildings.

3. STATE OF ART

According to USGBC, energy efficiency is a key strategy for reducing building-related pollution and greenhouse gas emissions, which are possibly the most important negative environmental consequence of building operation. Production of electricity from fossil fuels is responsible for air pollution and water pollution. Building systems including electrical, lighting, HVAC, and others can be designed to significantly reduce energy consumption compared to conventional designs and practices. The real estate industry started using green building certification systems to demonstrate that their design and construction since early 1990s. Several Cornell Hospitality Reports have demonstrated the importance of green certification in gaining favorable guest notice, including ISO 14001 and LEED. A study of over 2,000 independent hotels in Spain by Segarra-Oña, Peiró-Signes, and Verma found that hotels that have implemented the ISO 14001 environmental standards displayed stronger sales and earnings before taxes and depreciation than those that were not certified.

Constructing hotels green is one of the great strategies to combat climate change for the hotel industry. Greening the hotels help building managers, investors, owners and occupiers reduce the running costs and improve the environmental performance once the hotels start operation. Independent certification process provides a clear and credible route map for sustainable design and construction. Green design and energy simulation results help to optimize the building envelope and mechanical and electrical systems as well as fulfilling the pre-requisite requirements of green building certification systems.

4. METHODOLOGY

This research is conducted on 3 hotel projects in Turkey. These hotels are: Rixos Bademlik Hotel in Eskişehir (certified with LEED-GOLD) and CARYA Hotel at Belek (certified with LEED-GOLD) and HILTON Güneşli in İstanbul (certified with LEED-GOLD). The author was the LEED Process Manager of the three projects and was involved from the design to end of construction of the every step of the integrated project management process including performing the energy simulations with a team of experts for each hotel. In LEED, energy performance is a key component of sustainable design. Accordingly, in both of these systems it is the energy consumption category EA is the the most influential in terms of its impact on the overall assessment score. The most influential sub-categories in LEED is: **EA Credit-1 Optimize Energy Performance (19 available credits).** 'EA Credit-1' sub-category grant credits for buildings that demonstrate a performance improvement over a specific target. For LEED **this target is associated with ASHRAE performance standards. To enable this, the performance of the 'Designed building' is compared to that of a generated 'Base case' building by using any of the approved simulation tools according to each standard. The 'Base case' building shares some characteristics with the 'Designed building' (shape, size, activities etc.), but includes adjusted specifications for building fabric and service systems. For LEED V3 standard: The 'Base case' building is known as the 'Baseline building' and is defined in accordance with the specifications outlined in ASHRAE 90.1-2007. The LEED 'performance improvement' is a cost savings calculation.**

For LEED EA Credit-1 calculations, USGBC approves the qualified simulation program must follow a list of **specification that includes requirements that the tool must be able to** • Calculate 8760 h of building operation to simulate annual energy use. • Model hourly variations in occupancy, lighting power, miscellaneous equipment power, thermostat set points, and HVAC system operation.

Energy modelling was performed for each hotel to predict the annual hotel energy usage and to investigate the energy savings. Performing energy simulation is a prerequisite in order to get most green building certifications but energy modeling predates certification systems like LEED, BREEAM and DGNB. Energy modelling proved to be a powerful tool in all projects since it was part of the integrated design process from the beginning. Energy efficiency measures in each projects are diverse and have different interactions with other components of the building and it was necessary to evaluate their effectiveness using some sort of modelling approach.

There are many energy modelling softwares available in the market. A fundamental issue that has been highlighted in various studies is the predictive variability found between energy simulation tools. For the design and selected HVAC equipment, the research team decided to select eQUEST. eQUEST, used for all 3 projects demonstrates the percentage improvement in the proposed building performance rating compared to the baseline building performance rating as per ASHRAE/IESNA Standard 90.1-2007 for a whole building project simulation using the Building Performance Rating Method in Appendix G of the standard. The proposed design model is based on the actual parameters and actual design considerations and architectural details.

During schematic design phase a simplified model of building is used to test site and basic design features. For the values not available at the pre-design stage, default values are utilized. After several runs, alternative scenarios are compared. During design development stage inputs like, building characteristics, occupant characteristics, system characteristics are used to model. The outputs show us what the monthly consumption by end use will be as well as equipment type. Once the design development is completed the exact location, size and material characteristics for the envelope, windows, doors, roof and foundation are plugged into the model. During the preparation of construction and bid documents the complete energy model outputs are used. Construction management team is asked to install the designed features. Modelling also helped us to examine the life cycle costs.

There are 35 possible points and 3 Prerequisite requirements for energy requirements in LEED V3. The prerequisites are: 1. Fundamental Commissioning of Building Energy Systems 2. Minimum Energy Performance 3. Fundamental Refrigerant Management. The document states that the minimum energy performance in Prerequisite 2 is 10% improvement in the proposed building performance rating for new buildings compared with the baseline building performance rating. Other credits are:

- Credit 1 Optimize Energy Performance 1-19
- Credit 2 On-site Renewable Energy 1-7
- Credit 3 Enhanced Commissioning 2
- Credit 4 Enhanced Refrigerant Management 2
- Credit 5 Measurement and Verification 3
- Credit 6 Green Power 2

New Buildings	Existing Building Renovations	Points (NC & Schools)	Points (CS)
12%	8%	1	3
14%	10%	2	4
16%	12%	3	5
18%	14%	4	6
20%	16%	5	7
22%	18%	6	8
24%	20%	7	9
26%	22%	8	10
28%	24%	9	11
30%	26%	10	12
32%	28%	11	13
34%	30%	12	14
36%	32%	13	15
38%	34%	14	16
40%	36%	15	17
42%	38%	16	18
44%	40%	17	19
46%	42%	18	20
48%	44%	19	21

Table 3: % improvement and corresponding LEED credits

4.1 Case studies

A total number of 36 major hotel developers in Turkey were contacted for the study. 35 of these hotels aimed to receive LEED certification at some level while 1 aimed to receive DGNB. All 3 cases under this study received LEED GOLD certifications.

4.2 Bademlik Rixos Hotel at Eskişehir, Turkey

The Hotel consists of 5 basements, ground floor and 3 Guest Room floors. Boilers are designed to meet the heating energy demand of the building. Principal heating source is natural gas. According to function of the zones different heating systems are used. 4-piped Fan Coil system is used ballroom, back stage retail areas, foyer. Water cooled VRF system is used in guest rooms; café, restaurant and gym are heated by PTACs. Water cooled chillers are installed for cooling; FCU indoor units are used to meet the cooling energy demand of the building. Geothermal water is used as domestic hot water and laundry process demand. In addition to heating and cooling systems;

provided fresh air rates are designed according to ASHRAE 62.1-2007. In order to predict and compare the energy performance of the project with respect to the LEED NC requirements, Energy Analysis is done using eQUEST. This program simulates the energy performance of a building using hourly time steps for all 8760 hours in a year and by using Meteonorm Hourly Interpolated Values for Eskisehir weather file. The analysis and modeling methodology is in line with the LEED requirements. The energy model results show that the actual design for the building performs 30 % better than ASHRAE 90.1-2007 requirements using the LEED performance rating method.

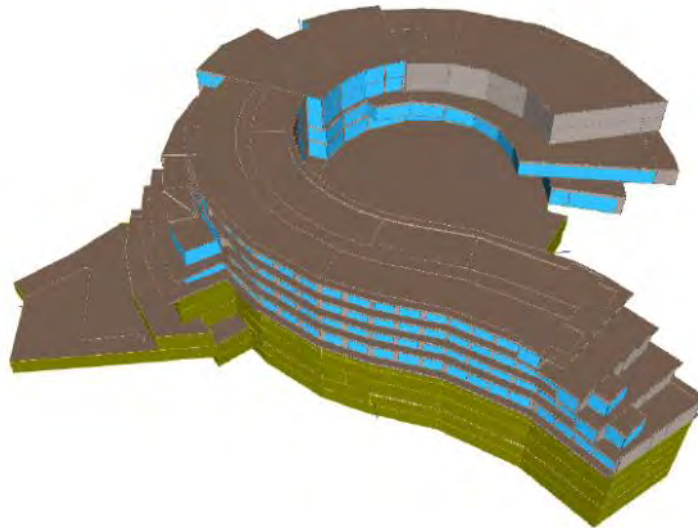

Figure 1: The 3D geometric model output of Bademlik Rixos Hotel for eQuest

4.3 Carya Hotel in Antalya, Turkey

Carya Hotel consists of one basement, Ground floor, one Mechanical Floor, and 4 Guest Room floors (including Attic Floor). Boilers are designed to meet the heating energy demand of the building. As a fuel type natural gas is used. According to function of the zones different heating systems are used. 4-piped Fan Coil system is used office, hotel rooms and circulations. Unitary Heaters are used in technical areas; café, restaurant and gym are heated by PTACs. Chillers are installed for cooling; FCU indoor units are used to meet the cooling energy demand of the building. Tri generation unit installation is the most important point for energy efficiency and improvement in the building. In addition to heating and cooling systems; provided fresh air rates are designed according to ASHRAE 62.1-2007.

eQUEST is used to simulate the energy performance of a building using hourly time steps for all 8760 hours in a year and by using TUR_Antalya_MN6.bin weather file. The analysis and modeling methodology is in line with the LEED requirements.

The proposed design model is based on the actual parameters and actual design considerations and architectural details. The key measures of an efficient design are: improving glazing, improving exterior wall Thermal Energy conductivity, using Heat Recovery Wheel; etc. The energy model results show that the actual design for the building performs 20 % better than ASHRAE 90.1-2007 requirements using the LEED performance rating method.

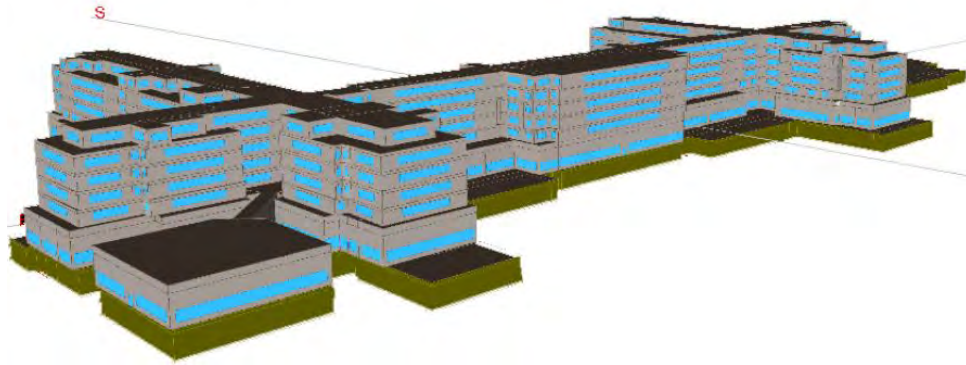

Figure 2: The 3D geometric model output of Carya Hotel for eQuest

4.4 GÜNEŞLİ HILTON, ISTANBUL, Turkey

Güneşli Hilton Hotel consists of 4 basements, ground floor and 22 Guest Room floors. Boilers are designed to meet the heating energy demand of the building. Principal heating source is planned to be natural gas. According to function of the zones different heating systems are used. 4-piped Fan Coil system is used in restrooms, changing rooms, ballroom, boardrooms, offices, fitness room, guest rooms and corridors. Variable air volume with under floor static heating is modelled for the pool area. Air cooled chillers are installed for cooling; FCU indoor units are used to meet the cooling energy demand of the building. In addition to heating and cooling systems; provided fresh air rates are designed according to ASHRAE 62.1-2007. In order to predict and compare the energy performance of the project with respect to the LEED NC requirements, an energy analysis is completed using eQUEST. The proposed design model is based on the actual parameters and actual design considerations and architectural details. The energy model results show that the actual design for the building performs 26,9 % better than ASHRAE 90.1-2007 requirements using the LEED performance rating method.

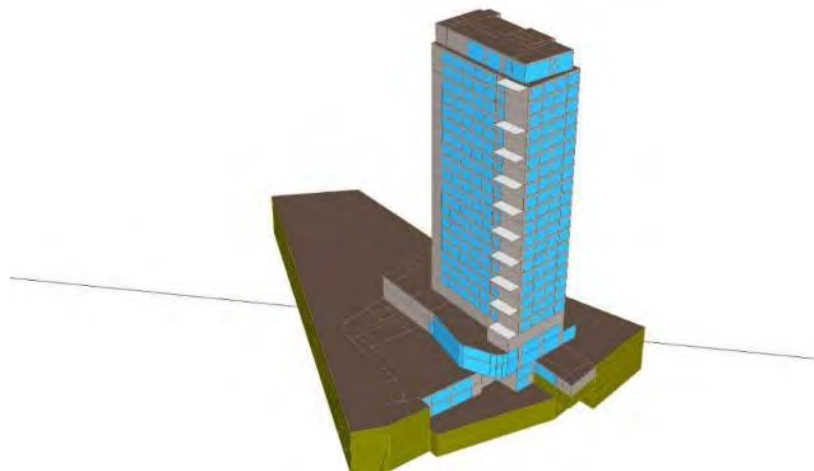

Figure 3: The 3D geometric model output of GÜNEŞLİ HILTON hotel for eQuest

5. RESULTS

Green building rating systems like LEED, aims to give benchmark and rank buildings within a specific frame. LEED considers a broad range of categories for reducing the environmental impact. The certification process requires a substantial modelling work. Building Energy Modelling helps determine the most cost effective solutions. Balancing the long-term payback of energy improvements, against critical capital costs, defines the building decisions. It is beneficial for hotel designers to utilize modelling as part of their design plan since modelling helps to optimize the building envelope and mechanical and electrical systems. Based on the findings presented in this paper, it is **suggested there exists significant energy savings potential for the Turkey's hotel industry as in the case for the 3 green hotel projects from three different climate zones in Turkey.** The main finding was that it is technically feasible to have 67 % energy cost improvement over baseline without compromising guest comfort by using green technologies used in Carya Hotel in Antalya.

Category	DATA	CARYA	BADEMLIK	HILTON
ENERGY	Standard of Simulation	ASHRAE 90.1-2007 App. G	ASHRAE 90.1-2007 App. G	ASHRAE 90.1-2007 App. G
	Actual Design (kWh/m ² /year)	166,37	221,56	155,49
	Baseline Design (kWh/m ² /year)	208,05	318,14	212,71
	% energy cost improvement over baseline	67	37,89	19,94
	Actual Design (KgCO ₂ /m ² /year)	90,1725	120,0855	84,2755
	Baseline Design (KgCO ₂ /m ² /year)	112,7631	172,4318	115,2888
	% improvement over baseline	20	30	26,9
	U values of exterior wall (W/m ² .K)	0,31	0,42	0,48
	U values of glazing+frame system (W/m ² .K)	4,49	2,27	4,31
	% of actual energy cost by renewable/trigen sources connected to the building	56	2	0
WATER	% Water consumption improvement over baseline	33	43	40
WASTE	Percentage (%) of waste diverted from landfill	89	87	88
AIR QUALITY	%30 Increased Ventilation according to ASHRAE 62.1-2007	YES	NO	YES

Table 4: Comparison of sustainability criterias

6. CONCLUSIONS AND RECOMMENDATIONS

Turkey has a favorable economic environment for foreign direct investment and construction market has a compound annual growth rate (CAGR) of 19%, while investment in the sector is increasing with a CAGR of 10%. Every year 100 thousand construction permits are granted for new buildings and 1,2% of these permits are for hotels. That corresponds to approximately 1200 hotel construction per year where only 3% of these hotels are aiming to receive green building certification systems. Based on the analysis of the three hotels which received LEED-GOLD certification, **there exists significant energy savings potential for the Turkey's hotel industry if hotels are designed and built with sustainability principles.** The main finding after comparing the three hotel designs is that it is technically feasible to increase energy efficiency over 60% without compromising guest comfort by using green technologies. From the LEED registered hotel list in Turkey, a high percentage of hotels receiving green building certifications are found to be foreign brands. Turkey, in order to develop its local hotel brands in a sustainable way, has to create a green code for the hotels. Turkish NGOs in the real estate sector are on the verge of creating a new national code for buildings. Since the ASHRAE 90.1 Energy Standard is being widely used by international green building certification systems, the new building code to be developed for Turkey can embed the requirements of ASHRAE 90.1 Energy Standart into the new code. Designers can use the building energy modelling to efficiently meet the new building code standard. This way, developers can evaluate energy saving potential of several possible solutions and pick the one suitable to meet the requirements of the code.

CONFLICTS OF INTEREST

The author declares no conflict of interest.

REFERENCES

- [11] IPCC 2007, Summary for Policymakers, in Climate Change 2007: Impacts, Adaptation and Vulnerability. Contribution of Working Group II to the Fourth Assessment Report of the Intergovernmental Panel on Climate Change, Cambridge University Press, Cambridge, UK, p. 17.
- [12] [IPCC SAR WG1](#) (1996), Houghton, J.T.; Meira Filho, L.G.; Callander, B.A.; Harris, N.; Kattenberg, A., and Maskell, K., ed., *Climate Change 1995: The Science of Climate Change*, Contribution of Working Group I to the Second Assessment Report of the Intergovernmental Panel on Climate Change, Cambridge University Press, [ISBN 0-521-56433-6](#) (pb: [0-521-56436-0](#))

- [13] BRE 2002. Carbon dioxide emissions from non-domestic buildings: 2000 and beyond. BR 442, Building Research Establishment 2002.
- [14] Hotel Energy Solutions (2011), Analysis on Energy Use by European Hotels: Online Survey and Desk Research, Hotel Energy Solutions project publications First edition: 2010 Revised version, July 2011
- [15] U.S Environmental protection Agency. (2007). Energy Star Building manual, facility type: hotels and motels.
- [16] SME hotels (EETI) Contract N°: IEE/07/468/S12.499390
- [17] **Turkey's National Energy Efficiency Action Plan (2015)**
- [18] Deloitte Calculations based on EU Commission Reports
- [19] <http://www.usgbc.org/articles/usgbc-announces-international-rankings-top-10-countries-leed-green-building>
- [20] USGBC Report on Practical Strategies in Green Building-Hotels-1996
- [21] The Impact of Hotel Certification on Hotel Performance, by Matthew C. Walsman, Rohit Verma, and Suresh Muthulingam, Cornell Hospitality Report, Vol. 14, No. 15, July 2014
- [22] M. Segarra-Oña, A. Peiró-Signes, and R. Verma, "Environmental Management Certification and Performance in the Hospitality Industry: A Comparative Analysis of ISO14001 Hotels in Spain," **Cornell Hospitality Report, Vol. 11, No. 22 (2011).** 17 M. Walsman, R. Verma, and S. Muthulingam, , "The Impact of LEED Certification on Hotel Performance," **Cornell Hospitality Report, Vol. 14, No. 15 (2014).**
- [23] M. Walsman, R. Verma, and S. Muthulingam, , "The Impact of LEED Certification on Hotel Performance," Cornell Hospitality Report, Vol. 14, No. 15 (2014).
- [24] <http://www.dgnb.de/en/>
- [25] ASHRAE Standard Energy Standard for Buildings Except Low-Rise Residential Buildings, ASHRAE, Atlanta, 2007. ISSN 1041-2336.
- [26] J. Neymark, R. Judkoff, Building Energy Simulation Test and Diagnostic Method for Heating, Ventilating, and Air-Conditioning Equipment Models (HVAC BESTEST), Volume 1: Cases E100–E200, International Energy Agency, 2002.
- [27] A. Brun, C. Spitz, E. Wurtz, L. Mora, Behavioural comparison of some predictive tools used in a low-energy building, in: **Proceedings of the Eleventh International IBPSA Conference (BS'09), International Building Performance Simulation Association, Glasgow, Scotland, 2009**, pp. 1185–1190.
- [28] <http://www.doe2.com/equest/>
- [29] Ministry of Science, Technology and Industry, 2014
- [30] TURKSTAT: www.turkstat.gov.tr

Building Energy Efficiency in Hong Kong: Case Study of a Commercial Building with BEAM Plus Provisional Platinum Rating (Existing Buildings)

POON Ka-man^a, CHAN Wai-yee^b, HUI Pui-shan^c

^a Business Environment Council Ltd., Hong Kong SAR, carmen@bec.org.hk

^b Business Environment Council Ltd., Hong Kong SAR, veronica@bec.org.hk

^c Business Environment Council Ltd., Hong Kong SAR, effie@bec.org.hk

ABSTRACT

Hong Kong currently has over 42,000 existing buildings that account for over 90% of the total electricity consumption in the territory. The Energy Saving Plan by the Hong Kong Government and the “HK3030” Campaign by the Hong Kong Green Building Council (“HKGBC”), both put forth an electricity consumption reduction target of buildings. Expediting green building adoption with better energy performance is identified critical to achieve the target. To advocate low carbon sustainable built environment, Business Environment Council (“BEC”) has undertaken a Transformation Project which aims to upgrade its Headquarters (with building age of around 20 years) to an energy wise green building with BEAM Plus Platinum rating. This paper presents the details and major findings of the project.

Since 2013, a number of energy-retrofit measures has been implemented, which including lighting system upgrade, installation of variable speed oil-free air cooled chiller, light and motion sensors, smart metering, and commissioning of building services equipment. These implementations aim to reduce electricity consumption of the building, future replacement, maintenance cost, and to enhance the energy efficiency of different building facilities. Meanwhile, driving behavioural changes of the occupants is also an important element for energy conservation. Stair-Days was one of the adopted measures which contributed to approximately 5% reduction in daily electricity consumption of lift. As an overall result, the electricity consumption of BEC Headquarters was reduced by 24% from 2013 to 2015. Together with other green features and environmentally friendly operational practices introduced, the BEC Headquarters has achieved the Platinum Rating of Provisional Assessment under the BEAM Plus Existing Buildings. It is the first commercial building in Hong Kong which has achieved the highest level of recognition under the BEAM Plus assessment for existing buildings. This project showcases how a 20-year-old building could contribute in energy saving and green building transformation in Hong Kong.

Keywords: existing buildings, BEAM Plus, energy consumption

5. INTRODUCTION

Hong Kong currently has over 42,000 existing buildings that account for over 90% of the total electricity consumption in the territory. To enhance the public awareness of energy saving, the “HK3030” Campaign was initiated by the Hong Kong Green Building Council (“HKGBC”). The objective was to reduce the electricity consumption of buildings in Hong Kong by 30% by 2030, compared to 2005 level. In 2015, the Energy Saving Plan by the Hong Kong Government also set a target to reduce energy intensity by 40% by 2025, compared to 2005 level. Expediting green building adoption with better energy performance is identified critical to achieve the target. To advocate low carbon sustainable built environment, Business Environment Council Limited (“BEC”) has undertaken a Transformation Project which aims to upgrade the BEC Headquarters (with building age of around 20 years) to an energy wise green building with BEAM Plus Platinum rating.

This paper presents the narrative of the Transformation Project and energy performance achieved to demonstrate that it is feasible for existing buildings to make themselves green and energy efficient.

1.1 BEC headquarters

BEC Headquarters (“BEC-HQs”) is situated at 77 Tat Chee Avenue, Kowloon since September 1996. It is a low rise commercial building. The building consists of 3 floors and a car park area on the lower ground floor, totalling an area of about 4,000 m². Apart from offices, auditorium and classrooms are also provided in the building. The building, when constructed in 1996, achieved “Very Good” rating under Hong Kong BEAM for New Office Designs Version 1/96.

1.2 Transformation project of BEC-HQs

Since BEC-HQs is almost 20 years old, the installed hardware became out-dated and inefficient in energy. Therefore, a Transformation Project was carried out and it commenced in 2013. The objectives of the Transformation Project were a) To provide optimum energy savings, better indoor environment quality, and more importantly greater connection to the community; and b) To provide environmental and green building related education and information to different community segments and create a large scale impact. A number of measures, relating to energy use, waste management, plumbing and drainage installation, have been implemented in order to improve building performance.

This paper focuses on the measures related to energy use. The measures are divided into two categories: a) Energy-retrofit and b) Driving behavioural change, and they are listed in the tables overleaf. The detail of these measures are discussed in the following sections.

Designation	Item
a)	Installation of variable speed oil-free air cooled chiller
b)	Upgrade of lighting system
c)	Installation of daylight and occupancy sensor
d)	Installation of power meters and energy meters
e)	Commissioning of building services installation

Table 1: Energy-retrofit measures in BEC-HQs

	Item
a)	“Stairs Days”
b)	Setup of Lighting zones
c)	Switching off lights during lunch hours
d)	Energy Saving Reminder

Table 2: Driving behavioural change measures in BEC-HQs

6. ENERGY-RETROFIT MEASURES

2.1 Installation of variable speed oil-free air-cooled chiller

The old air-cooled chiller was installed since the building completion. In other words, the operation time was almost 18 years in 2014. Its performance deteriorated from its original. To improve the energy efficiency of air conditioning, this chiller was replaced by an oil-free variable speed air-cooled chiller in July 2014. The new chiller consists of high energy efficiency compressors with magnetic bearings and variable speed permanent magnet motors. In addition, on the operation side, maintenance cost of the new chiller will be significantly reduced due to the maintenance free compressors.

The advantage of the oil-free chiller is its better COP and part load performance. Considering the thermal load of BEC-HQs is relatively low compared to a commercial building due to its scale, allowing part load operation of chiller could achieve energy conservation. According to the meter reading, the energy consumption of chilled water system (i.e. including chilled water pump) reduced by approximately 29.9%.

2.2 Upgrade of lighting system

Apart from the air-conditioning system, lighting system is also dominant in the building energy consumption, and hence, the lighting system was also upgraded since 2014. The lighting system originally adopted in BEC-HQs was mainly T8 fluorescent tubes. The system was firstly saved by de-lamping of the lighting panels by reducing the number of fluorescent tubes. In 2014, to further enhance the saving, LED panels were installed in the building. There were mainly three features to achieve energy conservation:

- The rated power of LED panel is much lower than T8 lighting panel (3 T8 fluorescent tubes in one panel), where approximately 40% of energy can be saved.
- Due to the luminance of LED panel is higher, the required amount of fittings is less than original plan. For instance, for the BEC office areas, totally 207 nos. of lighting fittings were originally installed, but it only requires 111 nos. of LED panels to provide satisfied working environment for staff members, which is in compliance with CIBSE.
- The heat generated from the LED panel is much lower than that of T8 fluorescent tubes. This can reduce the cooling load of the air-conditioning system.

By calculation, the replacement of lighting system contributed approximately 54.9% reduction in the consumption of lighting system.

It is targeted to install LED panels/ tubes for the whole lighting system in the building. At the current stage, office areas, common corridors, lift, back of house corridor, external staircases and floor lights, exit sign were all replaced.

2.3 Installation of daylight and occupancy sensor

To enhance energy saving, both daylight and occupancy sensors were provided for light fittings at common area (essential lighting is excluded). Inside the building, totally 5 daylight sensors were installed at perimeter zones at 1/F and 2/F, including corridor and offices. The light fittings at the controlled area were pre-set to provide at maximum 80% of lux level of the rated performance. The light fittings are dimmed when there is sufficient lighting level at the controlled area. There were totally 9 occupancy sensors installed at toilets and corridor at lower ground floor. The light fittings are switched on when there is occupant in the sensed area, and switched off if no occupant is detected within the certain time interval.

2.4 Installation of power meters and energy meters

In order to enable better monitoring and measuring the energy performance of the building engineering systems, 20 power meters and 12 energy meters were installed in 2014.

The installed power meters could separately monitor the power consumption of chillers, air handling units, lighting system, lift installation and small power. By checking metering record, the management office could take prompt and targeted actions to improve energy efficiency of specific facilities.

Energy meters were installed at the areas occupied by tenants in order to evaluate their respective amounts of energy consumption associated with air-conditioning. The data is targeted to be adopted as a factor to implement green lease in the future.

2.5 Commissioning of building services installation

Re-commissioning has been carried out since 2014, covering air conditioning system, water pumps and pressure vessels, and electricity system. The property manager has set up a schedule to maintain and inspect the systems regularly. Regular inspection and adjustment of building services installations optimise system performance throughout the lifetime of the equipment.

7. DRIVING BEHAVIOURAL CHANGES

Driving behavioural changes of the occupants is also an important element for energy conservation. As mentioned, several campaigns has been introduced and implemented since 2014. These campaigns were initiated by the Green Office Team of BEC. The team members meet regularly for discussing if any campaign can be held for engaging building occupants to live and work greener.

3.1 'Stairs Days'

'Stairs-Days' encourages building occupants to take the stairs instead of lift for the purpose of health and energy conservation. It commenced in March 2015 and was originally proposed for Friday only. With the support of the building occupants, the campaign was extended to Monday. With increased idling time of the lift, this campaign contributed to a 5% reduction in daily electricity consumption of lift.

3.2 Energy saving reminder

To promote energy saving and influence the building occupants to have better habit, the energy saving reminders were allocated around the office, near the switches of lighting system, computers, air-conditioning system. The users are always reminded to switch off the equipment or lights that are not in use, and to keep the air-conditioning set point at 25°C or above.

3.3 Energy saving measures of lighting

Considering it is a waste of energy when only a few staff member is working but with all lights are on in office, lighting zones were setup in BEC offices to allow individual control from BEC staff member. A lighting zones map **is posted to draw staff's attention**. BEC staff member who is the last one leaving the zone is responsible for turning off the light.

Apart from setup of lighting zones, lunch hour is also an opportunity to achieve energy saving. In BEC, staff members are recommended to switch off the lights during lunch hour. By estimation, if the lights are turned off 1 hour, approximately 2.2kWh could be saved daily, which may contribute to over 570kWh reduction in annual consumption.

Meanwhile, the measures not only benefit the reduction of lighting power consumption, but also indirectly help for reducing the thermal load, implying that less energy is required for air-conditioning system.

8. ENERGY PERFORMANCE OF IMPLEMENTED MEASURES

To study the effect on the energy performance of the adopted measures, the electricity consumption of the BEC-HQs from 2013 to 2015 is considered and presented in Figure 1. It is found that the consumption decreased year by year. As mentioned in Sections 2 and 3, most of the measures, especially the hardware upgrade, were implemented in 2014. Over 14% of electricity consumption was saved in this year; while the total electricity consumption of 2015 was further reduced by 10%, reaching 424,330kWh. In other words, approximately 24% of electricity consumption has been reduced since the commencement of transformation project (compared with 557,696kWh in total in 2013).

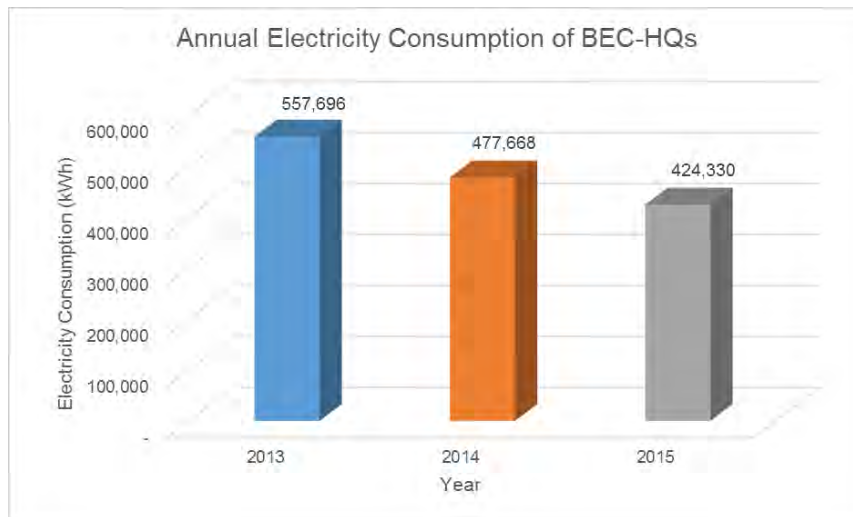

Figure 1: Annual electricity consumption of BEC-HQs

9. BEAM PLUS ACHIEVEMENT

BEC-HQs has achieved the Platinum Rating of Provisional Assessment under the BEAM Plus Existing Buildings (Version 1.2), as a result of the green features and campaigns adopted. Table 3 shows the credits achieved in different categories under BEAM Plus Provisional Assessment. The measures described in Sections 2 and 3 contribute to Energy Use category, which has the largest weighting among all categories in the assessment tool.

Category	Weighting (%)	Credits Achieved
Site Aspects	18	16
Materials Aspects	12	4.4
Energy Use	30	24.4
Water Use	15	10.7
Indoor Environmental Quality	25	19.2
Innovations and Additions	-	5
Total		79.7

Table 3: BEAM Plus credit achievement

10. CONCLUSION

A series of hardware upgrade and campaign have been implemented to improve the energy performance of BEC-HQs. In 2015, the overall energy consumption was approximately 24% lower compared with that of 2013. Both energy retrofit and driving behavioural change measures are essential to achieve this accountable energy saving performance.

BEC-HQs has achieved the Platinum Rating of Provisional Assessment under the BEAM Plus Existing Buildings. With the achievement of the first commercial building attaining the highest level of recognition under the BEAM Plus Provisional Assessment for Existing Buildings, BEC-HQs is a successful case for industry to learn from. This is not the end, continual improvement in energy performance is essential for existing buildings. It is believed that there would be more opportunities in the future for making existing building more green and energy efficient.

REFERENCES

- [1] Environment Bureau of HKSAR, 2015, Energy Saving Plan: For Hong Kong's Built Environment 2015~2025+. Hong Kong.
- [2] Hong Kong Green Building Council, 2013, HK3030: a vision for a low carbon sustainable built environment in Hong Kong by 2030. Hong Kong.
- [3] The Chartered Institution of Building Services Engineers, 1994, Code for Interior Lighting. London, UK.

An Elemental Approach for Predicting Embodied Carbon of Office Buildings

Michele VICTORIA^a, Srinath PERERA^b

^a Northumbria University, United Kingdom, michele.f.victoria@northumbria.ac.uk

^b Western Sydney University, Australia, srinath.perera@westernsydney.edu.au

ABSTRACT

Embodied Carbon (EC) in buildings is increasingly becoming an important factor in carbon management. There are numerous tools and methods to estimate EC right from the beginning of a construction project. However, each tool has its own pros and cons. One such approach is to estimate EC using Element Unit Rates (EC-EUR) and Element Unit Quantity (EUQ). This is made possible by identifying carbon hotspots in buildings in the first instance and developing EC-EURs for different specifications of the carbon hotspots. Development of elemental EC-EUR benchmarks and its application in the proposed elemental approach for predicting EC is presented in the paper. Carbon hotspots of office buildings were identified using a sample of 28 office buildings in the UK where Substructure, Frame, Upper Floors, External Walls and Services were identified as the carbon hotspots. EC-EUR benchmarks were developed for different specifications of the hotspots by statistically modelling the sample for Frame. However, EC-EURs of the rest of the hotspots were not developed due to lack of specification information. The key outcomes of the research include the carbon hotspots of office buildings leading to the development of an early design stage EC prediction model and the concept of developing EC-EUR benchmarks which are not established at the moment and hence, fill the knowledge gap in the literature.

Keywords: carbon hotspots, Embodied Carbon Element Unit Rate (EC-EUR), Element Unit Quantity (EUQ), office buildings

1. INTRODUCTION

A hotspot may mean different things to different people from different discipline. RICS (2014) defines '**carbon hotspot**' as the carbon significant aspect of a project which can be building elements or other aspects in supply chain. However, carbon hotspots in this research refers to the carbon critical or significant building elements. RICS (2014) further extends that carbon hotspots are not only carbon intensive but also easily measurable and carbon reduction is possible. Pareto Principle defines that 80% of the results (or consequences) are attributable to 20% of the causes which implies unequal relationship between the inputs and the outputs (Koch, 2011, Delers, 2015). According to 80:20 Pareto rule, it can be assumed that 80% of embodied emissions are caused by 20% of building elements (yet to be proved). These carbon hotspots may vary from one building to the other depending on the type or function of the building (Ashworth and Perera, 2015).

Monahan and Powell (2011) highlighted the importance of identifying hotspots in buildings by modelling a two storied residential building (in the UK) in three different scenarios – timber frame and larch cladding, timber frame and brick cladding, conventional masonry cavity wall. The substructure (including foundation and ground floor) accounted for 50% of embodied carbon in timber frame and larch cladding building and substructure, external walls and roof were identified as the carbon hotspots in the building (elements responsible for 81% of embodied carbon, however, not all the building elements were included in the accounting). Further, the same building (timber frame with larch cladding) substituted with timber frame and brick cladding and conventional masonry resulted in additional embodied carbon of 32% and 51% respectively. The majority of difference in embodied carbon was found to be attributed to the difference in foundations and external walls. The findings of the study (Monahan & Powell, 2011) reveal substructure and external walls as '**carbon hotspots**' in the particular residential building and highlight the potential for embodied carbon reduction.

Shafiq et al. (2015) studied a two storied office building in Malaysia by modelling six different scenarios for structural composition using Building Information Model (BIM). However, Shafiq et al. (2015) used UK databases to estimate embodied carbon due to lack of embodied carbon databases in Malaysia. Different grades or classes of concrete and steel were combined to generated different composition which resulted in different material quantities producing varying embodied carbon impacts. Only few elements were studied including foundation, beams, slabs, columns and staircases which can be related to substructure, frame, upper floors and stairs as per NRM element

classification. Shafiq et al. (2015) found that it was possible to reduce up to 31% of embodied carbon by designing these elements with different classes of concrete and steel to meet the given design criteria. However, it should be noted that only the elements that constitute concrete and steel are considered because concrete and steel are considered as the main structural building materials and emit high embodied carbon during production. Particularly, upper floors were identified as the key carbon hotspot followed by substructure, frame and stairs.

It is clear that embodied carbon studies in different types of buildings highlighted above (Monahan & Powell, 2011; Shafiq et al, 2015) has different focus and hence, limit the analysis to few elements. However, analysis of the whole building will provide a holistic picture of the embodied carbon contribution of each element and will highlight the potential areas for carbon reduction. Generally, floors (ground and upper floors), frame, external wall and roof are identified as carbon hotspots in building case studies (Clark, 2013, Davies et al., 2014, Halcrow Yolles, 2010). However, the knowledge of carbon hotspots is still obscure and there is a need for research in this area especially to facilitate early design stage EC estimating as proposed by Victoria et al. (2016).

2. THE METHOD

Historical data were obtained from a QS consultancy practice which include embodied carbon estimates of twenty-eight (28) office buildings prepared in an NRM compliant element standard. Carbon hotspots were analysed using the Pareto principle which suggest that 80% of the results (or consequences) are attributable to 20% of the causes which implies unequal relationship between the inputs and the outputs (Koch, 2011, Delers, 2015). The same 80:20 theory was used to identify the carbon hotspots in the buildings due to its popularity and applicability in especially, economics, business and management related areas. Consequently, it was deduced that **80% of the EC is coming from 20% of the building elements. These 20% of the building elements are named as the 'carbon hotspots' in the context of the research. Even though 80:20 is accepted as the universal ratio, Pareto Principle neither dictates that the 80:20 ratio is applied to all the situation nor should the two figures add up to 100 (say, it could be 90:10 or 80:30) (Business Balls, 2016).** Therefore, this ratio is also tested in the case of the relationship between embodied carbon (and cost) and building elements.

The elements contributing up to 80% of the EC were identified as shown in Error! Reference source not found.. Firstly, embodied carbon of individual elements was estimated and the percentage contribution was calculated. Then, the elements were arranged in descending order based on the EC intensity. Then, cumulative percentage was calculated to draw a cut-off point at 80% as shown in Error! Reference source not found..

Building Elements (NRM compliant)	Embodied Carbon % (in descending order)	Cumulative Embodied Carbon%
2A Frame	38.54	38.5
2E External walls	20.30	58.8
5 Services	13.82	72.7
1A Substructures	9.90	82.6
2B Upper floors	6.71	89.3
2C Roof	3.94	93.2
2D Stairs	2.44	95.7
2G Internal walls and partitions	1.66	97.3
3B Floor finishes	1.50	98.8
4A Fittings and furnishings	0.43	99.2
3A Wall finishes	0.34	99.6
2H Internal doors	0.32	99.9
3C Ceiling finishes	0.09	100.0
2F Windows and external doors	0.01	100.0

Table 1: Identifying carbon hotspots of a building – an example

According to the example presented in Error! Reference source not found., Frame, External Walls, Services and substructure are the identified as the carbon hotspots of the particular building and 28% of the building elements (4 of the 14 elements) are being responsible for the 80% of the embodied carbon emissions from the example building. The carbon hotspots of the sample (28 buildings) were calculated in this manner by using the average EC values

of the elements. In addition to that, descriptive statistics (mean, minimum, maximum and standard deviation) were also presented to convey the dispersion of the sample analysed.

The identification of the carbon hotspots lead to the development of the early design stage EC prediction model for office buildings based on the idea proposed by Victoria et al. (2016). The proposed concept of Victoria et al. (2016) suggest that the sum of the product of EUQ and EC-EURs of the carbon hotspots and the residuals will yield the EC of the building. Consequently, EUQs of the carbon hotspots were defined using BCIS and EC-EURs **were also calculated using 'mean' while minimum, maximum and standard deviation** were also presented to enable the readers to understand the data dispersion.

3. FINDINGS

3.1 Carbon hotspots

Carbon hotspots of the sample were analysed using 80:20 Pareto Rule as described in the method. Accordingly the carbon hotspots (building elements contributing up to 80% of the EC emissions in descending order) were identified and plotted in a table as shown in Error! Reference source not found.. Accordingly, each row represents a building and the elements that were identified as carbon hotspot in the respective building were marked **with a 'x'**. **Last row of the table presents the probability of each element being identified as a hotspot in the sample.** Accordingly, Frame found to be a hotspot in all the buildings; Substructure and Services found to be a hotspot in 90% of the buildings; and External Walls found to be a hotspot in 80% of the buildings in the sample. On the other hand, elements like Stairs, Internal Doors, Wall Finishes, Ceiling Finishes and Fittings and Furnishings were not found as hotspots in any of the buildings in the sample. Rest of the elements were found to be hotspots in some of the buildings.

Building ID	1A Substructures	2A Frame	2B Upper floors	2C Roof	2D Stairs	2E External walls	2F Windows and external doors	2G Internal walls and partitions	2H Internal doors	3A Wall finishes	3B Floor finishes	3C Ceiling finishes	4A Fittings and furnishings	5 Services
#D1001	x	x				x								x
#D1002	x	x				x								x
#D1003	x	x	x			x								
#D1004	x	x				x								x
#D1005	x	x				x								x
.														
.														
.														
#D1028	x	x	x			x								x
Probability of occurrence	0.9	1	0.6	0.1	0	0.8	0.11	0	0	0	0.2	0	0	0.9

Table 2: Example of identifying carbon hotspots of the sample buildings

Descriptive statistics of EC per GIFA of the sample for each element are presented in Error! Reference source not found.. Elements are presented in a descending order according to their EC intensities. Further, cumulative EC percentage was also calculated to identify the elements responsible for 80% of the EC emissions. Frame, Substructure, External Walls, Services and Upper Floors (highlighted in greyscale) were identified as carbon hotspots in the sample. Findings suggest that 36% of the elements are responsible for 80% of the EC emissions. Also, it can be noticed that the standard deviation is comparatively high for the hotspots which implies EC-EUR range is wide for these elements.

Element	Average EC per GIFA (kgCO ₂ per m ²)	Minimum	Maximum	Standard Deviation	Cumulative EC %
2A Frame	236.72	98.00	486.41	101.13	30.1
1A Substructures	137.20	33.21	320.72	65.31	47.5
2E External Walls	111.24	8.37	265.80	63.35	61.6
5 Services	106.81	6.63	192.88	50.16	75.2
2B Upper Floors	75.99	1.72	191.08	38.68	84.8
3B Floor Finishes	37.69	0.39	97.77	28.82	89.6
2C Roof	25.05	2.88	103.25	19.69	92.8
2G Internal Walls and Partitions	20.14	1.19	64.37	15.97	95.3
2F Windows and External Doors	15.20	0.02	157.64	35.20	97.3
3C Ceiling Finishes	8.55	0.65	24.62	6.05	98.3
2D Stairs	7.00	2.47	21.46	5.01	99.2
3A Wall Finishes	3.65	0.22	18.47	4.23	99.7
2H Internal Doors	1.50	0.12	7.32	1.79	99.9
4A Fittings and Furnishings	0.86	0.02	3.39	1.15	100.0
EC of the building	785.31	431.61	1,368.17	215.92	

Table 3: Descriptive statistics of the sample

3.2 The proposed EC model

Based on the carbon hotspot analysis of the sample, the proposed idea by Victoria et al. (2016) for an early stage EC model can be presented as follows for office buildings:

$$EC = EUQ_{Fr} \cdot EUR_{Fr} + EUQ_{Sub} \cdot EUR_{Sub} + EUQ_{EW} \cdot EUR_{EW} + EUQ_{Ser} \cdot EUR_{Ser} + EUQ_{UF} \cdot EUR_{UF} + k$$

EC - EC of the Building

EUQ_F - Element Unit Quantity of Frame

EUR_F - Element Unit Rate of Frame

EUQ_{Sub} - Element Unit Quantity of Substructure

EUR_{Sub} - Element Unit Rate of Substructure

EUQ_{EW} - Element Unit Quantity of External Walls

EUR_{EW} - Element Unit Rate of External Walls

EUQ_{Ser} - Element Unit Quantity of Services

EUR_{Ser} - Element Unit Rate of Services

EUQ_{UF} - Element Unit Quantity of Upper Floor

EUR_{UF} - Element Unit Rate of Upper Floor

k - Minor EC components of the rest of the elements (20% of EC emissions)

Equation 1

According to the proposed EC model for office buildings, EUOs have to be defined in a standard way and EC-EURs need to be developed for the identified elements in the model. NRM compliant Building Cost Information Services (BCIS) defines the measurement rules for EUOs of the elements which is adopted as the standard definition of the EUOs of the identified hotspots. However, in the case of Services, each type of service is measured in different unit of measurements. For instance, Sanitary Installations are measured in Nr while Water Installations are measured as floor area serviced by water installations (m²). However, details such as number of appliances and service equipment are less likely available during early design stage. Hence, GIFA was selected as the appropriate EUO for Services. Error! Reference source not found. presents the definitions adopted for EUOs of he selected carbon hotspots.

Elements	EUO
Frame	GIFA - area of a building measured to the internal face of the perimeter walls at each floor level (m ²).
Substructure	Area of lowest floor measured to the internal face of the external wall (as for GIFA) (m ²).
External Walls	Area of external walls measured on the inner face (excluding openings) (m ²).
Services	GIFA – same as for Frame (m ²).
Upper Floors	Area of upper floor measured to the internal face of the external wall (as for GIFA) (m ²).

Table 4: Definitions of EUOs for the identified carbon hotspots from NRM compliant BCIS

3.3 Developing EC-EURs

The next step in using the model is to develop EC-EURs for possible alternative design options of the identified carbon hotspots. Based on a survey of 41 buildings from BCIS online database, the design options which were found to be predominant in the office buildings are presented in Error! Reference source not found..

Elements	Design options
Frame	Concrete, steel and hybrid
Substructure	Pile, raft, pad and strip
External Walls	Cavity and curtain walls
Services	Non-air-conditioned, air-conditioned – with and without BMS or lift installations
Upper Floors	In-situ concrete floors, pre-cast concrete floors, metal decking and timber floors

Table 5: Typical design options for the identified carbon hotspots

Consequently, EC-EURs were developed for the identified design options using the available EC data. Frame EC-EURs of the sample (28 buildings) are presented in Error! Reference source not found. where the sample size of each design option is indicated in parentheses. It can be noted that the EC-EUR of the concrete frame is derived from one (1) building which cannot be considered as a representative of the population. Similarly, hybrid frame EC-EUR is also calculated from three (3) buildings which is also unsatisfactory. In comparison to concrete and hybrid frames, steel frame EC-EUR has been derived from a larger sample with fourteen (14) buildings though the sample size is not statistically significant. Hence, a larger sample is required to benchmark EC-EURs.

Frame	Average EC per GIFA	Minimum EC per GIFA	Maximum EC per GIFA	Standard Deviation
	kgCO ₂ / m ²			
Concrete (1)	108.51	-	-	-
Steel (14)	242.86	98.00	486.41	104.87
Hybrid (3)	230.36	191.49	291.38	53.50

Table 6: EC-EURs for the possible design options of frame

Further, EC-EURs of the other elements could not be developed due to the unavailability of specification information of the rest of the elements of the sample buildings.

4. CONCLUSIONS

Application of a proposed EC estimating method is presented in this paper using the concept of carbon hotspots. Carbon hotspots in this research context is defined as the carbon critical building elements. Frame, Substructure, External Walls, Services and Upper Floors were identified as the carbon hotspots of the selected sample whose EC-EUR range is wider than the other elements. Also, 80:20 Pareto Rule was not supported in the research context instead the findings propose an 80:36 ratio for EC of office buildings which implies that the 80% of EC emissions in office buildings are attributable to 36% of the building elements. However, the findings are based on a sample of 28 buildings and hence, are not generalised which is a limitation of the study. However, the study can be repeated with a larger sample to attain statistically significant results. Further, there is also a need for a larger sample to benchmark EC-EURs for alternative design options of the identified carbon hotspots. Developing such EC-EURs will facilitate EC estimating during early stages of design which has the potential for huge emission reductions.

REFERENCES

- [1] Ashworth, A. & Perera, S. 2015. Cost studies of buildings, Oxon: Routledge.
- [2] Business Balls. 2016. Pareto's principle [Online]. Businessballs. Available: <http://www.businessballs.com/pareto-principle-80-20-rule.htm> [Accessed 04 August 2016].
- [3] Clark, D. H. 2013. What Colour is your Building? Measuring and reducing the energy and carbon footprint of buildings, UK: RIBA Enterprises Limited.
- [4] Davies, P. J., Emmitt, S. & Firth, S. K. 2014. Challenges for capturing and assessing initial embodied energy: a contractor's perspective. **Construction Management and Economics**, **32**, 290-308.
- [5] Delers, A. 2015. Pareto's Principle: Expand your business!, 50Minutes.com.
- [6] HALCrow YoLLES 2010. Sustainable offices – embodied carbon. South West Regional Development Agency.
- [7] Koch, R. 2011. The 80/20 Principle, Nicholas Brealey Publishing.
- [8] Monahan, J. & Powell, J. C. 2011. An embodied carbon and energy analysis of modern methods of construction in housing: A case study using a lifecycle assessment framework. *Energy and Buildings*, 43, 179-188.
- [9] RICS 2014. Methodology to calculate embodied carbon. 1 ed. UK: RICS.
- [10] Shafiq, N., Nurrudin, M. F., Gardezi, S. S. S. & Kamaruzzaman, A. B. 2015. Carbon footprint assessment of a typical low rise office building in Malaysia using building information modelling (BIM). *International Journal of Sustainable Building Technology and Urban Development*, 1-16.
- [11] Victoria, M., Perera, S. & Davies, A. 2016. A pragmatic approach for embodied carbon estimating in buildings. SBE16 Torino, Italy.

Exploring Risks and Rewards Associated with High Performance Manufactured Buildings

Karlson Charles HARGROVES^a, Lios HEBERT^b, Peter NEWMAN^c, Jemma GREEN^d, Daniel CONLEY^e

^a Curtin University, Australia, charlie.hargroves@curtin.edu.au

^b Curtin University, Australia

^c Curtin University, Australia

^d Curtin University, Australia

^e Curtin University, Australia

ABSTRACT

The transition to the offsite construction and manufacture of buildings stands to create a lucrative opportunity for the global building sector. The shift to the manufacture of buildings stands to generate numerous benefits including economic benefits (such as construction times for major commercial construction projects substantially), social benefits (significantly improving workplace occupational health and safety by bringing the majority of building construction indoors), and environmental benefits (through reduced materials wastage, reduced materials transportation, greater inclusion of energy and water efficient elements, and the potential for greater use of recycled materials). This paper explores a range of factors that affect the attractiveness of such benefits along with the perception of the associated risks related to the fact that for instance in order to provide the access to capital needed to significantly upscale building manufacture long standing financing structures need to be redesigned in the building sector related to providing progress payments and dealing with completion risk.

The paper is informed by an industry workshop held by Sustainable Built Environment National Research Centre (SBEnc) in Australia, in collaboration with the EU Centre for Global Affairs at the University of Adelaide and **prefabAUS**, on the topic of “Capturing Opportunities from Financing Offset Building Manufacture”. The workshop was held as an official partner event as part of the European Union’s Green Week 2016. The workshop was well attended with 25 representatives from banks, builders, government agencies and researchers. In-line with the Green Week theme of “Investing in the Future” the workshop focused on how the banking community perceived risks and rewards from investing in the manufacture of buildings in Australia.

Keywords: building manufacture, construction risk, innovation

1. INTRODUCTION

The transition to the offsite construction and manufacture of buildings stands to create a lucrative opportunity for the global building sector. The shift to the manufacture of buildings stands to reduce a number of impacts including economic (reducing the time homebuyers rent while their home is constructed), social (significantly improving workplace occupational health and safety by bringing the majority of building construction indoors), and environmentally (through reduced materials wastage, reduced materials transportation, greater inclusion of energy and water efficient elements, and the potential for greater use of recycled materials).

In 2012 the economic output from the manufacture of buildings globally was estimated at just over US\$90 billion, up from \$60 billion in 2011. Asia-Pacific was the largest regional market in 2012, worth just under \$60 billion, outperforming all other regional markets, and set to rise to some \$100 billion by 2020. In 2014 the largest regional market was Asia-Pacific valued at US\$44.4 billion, followed by Europe at US\$31.5 billion, and North America at US\$10.2 billion. China constituted the largest share of the Asia-Pacific market with just over 60% in 2012, followed by Japan at 22%, Australia at 7%, and Indonesia at 5%. The growing number of case studies and examples of manufacturing buildings provides quantifiable data that can inform efforts to capture the opportunities by providing strong evidence to developers, investors, and homebuyers.

There is great potential for the manufacture of buildings to be harnessed to significantly strengthen both the building and manufacturing sectors. Domestic building industries around the world will face strong international competition in the near future, especially as the quality of imported prefabricated and manufactured building offerings is increasing and the price is decreasing. If not considered as part of a strategic transition such competition can have significant impacts on domestic construction industries with an Australian study suggesting that Australian imports

of buildings are anticipated to reach a value of \$30 billion by 2025, which could displace as many as 75,000 jobs nationally. Hence the transition to manufactured buildings needs be undertaken in such a way as to harness a nations existing pool of skills and trades so as to allow workforce transitioning in a manner that strengthens industry.

A leading example is the 'Little Hero Apartments in Melbourne Australia that demonstrated the savings possible, from time to safety improvements. Built by Hickory for Delphine Holdings, Little Hero Apartments is an eight storey building, comprised of 75 prefabricated modules which were able to be assembled on site in just 10 days – significantly reducing the interruption to traffic in the CBD of Melbourne associated with onsite construction methods. The total project time was 9 months, which reduced the construction time by at least 6 months when compared to an onsite build, fast tracking the return on investment.

2. BENEFITS OF OFFSITE CONSTRUCTION

Research by the Australian Sustainable Built Environment National Research Centre has shown that building manufacture allows for cost savings, faster delivery times, and the reduction of a number of impacts associated with on-site building construction methods, such as:

- Cost savings

The shift to prefabrication of buildings stands to deliver a range of cost savings to developers, builders, and owners. The greatest cost benefits are achievable in projects where replicable structures are used, such as apartments, housing developments, hotels, student accommodation, classrooms, prisons, and mining accommodations. Direct costs savings are achieved from the faster delivery of buildings using prefabrication methods, along with reductions in construction waste both from design and higher reuse of materials, weather damage of materials, damage caused from onsite handling in often restricted sites with multiple trades, and the elimination of vandalism and site theft during construction. The potential for such savings opens up the opportunity for the greater provision of affordable and social housing along with the provision of a higher level of quality and non-standard inclusions in **residential and commercial buildings. In particular it would make 'sustainability' related inclusions that can deliver** lower operating costs to occupants and owners more economically feasible at the construction stage (especially energy related inclusions).

- Faster delivery

The shift to the manufacture of buildings stands to significantly reduce construction times, along with reducing onsite delays often caused by waiting for materials delivery, coordinating service providers and subcontractors, and from inclement weather. Reducing construction times can lead to a range of benefits such as reducing the cost of fees on land taxes, equipment hire, fuel bills, and staff on-costs. The shift will also allow a greater volume of buildings to be delivered as not only is the construction time shorter it can be carried out at the same time as site preparation (i.e. footings, retaining walls, and landscaping). This is important as the shift is likely to reduce the labour requirement of individual buildings so it will be important to compensate with a growth in building output.

- Improved work place conditions

The shift to the manufacture of buildings in dedicated facilities will provide a number of improvements to workplace conditions, including:

- Protection from weather and other hazards for both workers and materials, along with the provision of appropriate lighting levels 24 hours a day,
- Provision for use of central power tool facilities rather than the reliance on hand tools or portable power tools onsite, and
- Greater ability to provide elevated platforms, mini cranes, roped harnesses, and other safety equipment due to construction undertaken in a fixed facility with flat floors and overhead beams.

Furthermore, the shift to a centralised facility leads to a number of benefits such as greater flexibility in supplier choice as materials can be stockpiled rather than being needed on demand at multiple sites across a city or region,

a regular delivery location with dedicated loading bay facilities reducing transportation costs of supplies, and the assurance that there will be someone to sign for materials at the facility.

On the 24th of July the Sustainable Built Environment National Research Centre (SBEnc), in collaboration with the EU Centre for Global Affairs at the University of Adelaide and prefabAUS, held an Industry Stakeholder workshop in Perth, WA, at the WA Club on the topic of “Capturing Opportunities from Financing Offset Building Manufacture”. The workshop was held as an official partner event as part of the European Union’s Green Week 2016. The workshop was well attended with 25 representatives from banks, builders, government agencies and researchers. In-line with the Green Week theme of “Investing in the Future” the workshop focused on how the banking community perceived risks and rewards from investing in the manufacture of buildings in Australia.

- Reduced risk of delays

Faster construction times and a focus on greater quality construction will reduce the risk that the project will be delayed, especially from supply issues or weather related delays. This reduces a number of risks, such as delayed mortgage payments, delayed rental payments, and delayed occupancy dates for hotels.

- When asked how valuable the reduced risk of delays was to lenders and investors just over 35% responded ‘Very High’ with a further 35% responding ‘High’ and 25% responding ‘Moderate’, suggesting that this provided tangible value.

- Reduced risk of variations

A manufacturing approach shifts focus from assuming that variations can be undertaken onsite, to getting it right the first time. This is achieved by eliminating defects and ensuring consistent quality in design, workmanship, and materials, hence avoiding costly variations.

- When asked how valuable the reduced risk of variations was to lenders and investors some 28% responded ‘Very High’ with a further 34% responding ‘High’ and 24% responding ‘Moderate’.

- Increased construction safety

A factory environment for building construction allows improved workplace occupational health and safety that will reduce the number of work place accidents and injuries and the associated impacts.

- When asked how valuable the reduced risk of variations was to lenders and investors just under 32% responded ‘Very High’ with a further 25% responding ‘High’ and 44% responding ‘Moderate’ (with no respondents indicating ‘Low’ or ‘Very Low’).

- Greater return on equity

The faster construction times mean that return on equity can be increased by completing a project sooner and re-investing the capital in subsequent projects, especially on commercial projects. Given the faster construction time the initial capital could be invested into multiple subsequent projects in the same time that it would take to deliver an onsite construction project.

- When asked how valuable the greater return on equity was to lenders and investors some 20% responded ‘Very High’ with a further 60% responding ‘High’ and 20% responding ‘Moderate’ (with no respondents indicating ‘Low’ or ‘Very Low’).

- More attractive to home buyers

Given faster construction times, homebuyers are likely to be interested in reducing the time they wait for their home to be built, which not only reduces the amount paid in rent or alternate accommodation but also sees them occupying the property sooner and hence paying the mortgage.

- When asked how valuable the potential for greater appeal to homebuyers was to lenders and investors just over 22% responded 'Very High' with a further 56% responding 'High' and 17% responding 'Moderate'.
- Less theft, vandalism or damage of materials

Given the construction is undertaken in a factory environment materials and tools can be better protected from weather conditions and from theft. Such costs can increase the construction cost and cause delays.

- When asked how valuable the potential for less theft, vandalism or damage of materials was to investors/financiers just under 18% responded 'Very High' with a further 30% responding 'High' and 42% responding 'Moderate'.
- Reduced materials costs

A central facility allows for 24 hour receipt of bulk orders with secure storage which will reduce costs and delays. Further materials can easily be reused which can reduce waste by 30-40%, reducing wasted materials and dumping costs.

- When asked how valuable the potential for reduced materials costs was to lenders and investors just under 12% responded 'Very High' with a further 53% responding 'High' and 35% responding 'Moderate' (with no respondents indicating 'Low' or 'Very Low').
- Land value unaffected until completion

As construction is offsite the land value of the intended site is not affected should the construction be interrupted, postponed, or abandoned. Rather the near complete building is delivered to site, maximising the lands utility and worth throughout the construction phase.

- When asked how valuable it would be to lenders and investors that the land value was unaffected until close to completion just over 6% responded 'Very High' with a further 38% responding 'High' and 44% responding 'Moderate'.
- Greater security on completion risk

Given the construction is undertaken in a centralised facility the majority of the tools and equipment are owned by the manufacturer and can be used as security for loans, rather than these assets being owned by independent trade contractors.

- When asked how valuable it would be to lenders and investors to have greater securing on completion risks no respondents indicated its importance was 'Very High', 23% responded that it would be 'High' and 46% responding 'Moderate'.

3. WHAT IS HOLDING UP PROGRESS?

The workshop explored the premise that in order to increase the market penetration of offsite construction and building manufacture a number of key challenges need to be addressed related to finance, insurance, and warranty structures with the following findings:

- Negative perceptions

There is a need to shift perceptions of the industry and consumers around manufactured buildings being simply temporary reloadable structures to recognising them as high quality precision built buildings; this may be through independent quality verification, demonstration buildings, community education programs, and qualifying the specific benefits to consumers.

- When asked how much of a risk the issue around negative perceptions was to lenders and investors nearly 40% responded 'Very High' and a further 40% responded 'High'.

- Quality and lifespan

There is a need for a clear and accountable process for the rectification of defects, especially when sourcing building modules from overseas, along with insurance and warranty structures that support offsite construction and onsite erection. The allocation of responsibility for defects is complicated by the nature of the offsite delivery model in that it can require multiple contractors to undertake offsite construction, module transportation, and onsite preparation and assembly, with each stage able to identify defects and warranty issues.

- When asked how much of a risk the issue around quality and lifespan was to lenders and investors **nearly 30% responded 'Low' and just under 45% responded 'Moderate'**.

A key element in ensuring the quality of buildings constructed offsite using prefabrication and/or manufacturing based processes is the provision of associated design codes and standards that can be assessed for compliance. In the USA, the U.S. Department of Housing and Urban Development can created a construction and safety **standard for offsite construction and building manufacture, the 'Manufactured Home Construction and Safety Standards'**. This standard classifies a manufacture home as one that is **'constructed on a permanent chassis'** and provides standards for design, construction, and installation of manufactured homes to assure the quality, durability, safety, and affordability. The standards include a dispute resolution component along with the provision for inspections and record keeping.

A second key way to provide assurance of quality is through the provision of a warranty or assurance scheme. For example in Japan building owners are provided with a standard 20 year warranty which entails strong after sales service. In the UK efforts to increase the viability of securing construction financing have focused on providing independent certification of the processes used in offsite construction and building manufacture in collaboration with the Council of Mortgage Lenders. The **'Build Offsite Property Assurance Scheme' (BOPAS)** seeks to provide assurance to lending institutions that buildings constructed offsite are sufficiently energy efficient and durable and will be readably saleable for a minimum of 60 years.

- Completion risk

There is also uncertainty around managing completion risk, such that the building is in the possession of the manufacturer up until delivery and may not be able to be easily completed should the manufacture halt operations (this may be affected by issues related to intellectual property of manufacturing methods hindering a shift in manufacturer if required). This also presents a risk to the builder or manufacturer as clients may not provide purchase confirmation until the building is delivered and able to be used for collateral for loans, leaving open the potential to withdraw part-way through the offsite construction or not being able to secure a loan at time of delivery.

- When asked how much of a risk the issue around completion risk was to lenders and investors **nearly 65% responded 'High' and just under 12% responded 'Low' or 'Very Low'**.

- Progress payments

In order to provide the access to capital needed to significantly upscale building manufacture, and capture the associated benefits, long standing financing structures need to be redesigned in the building sector that are on progress payments at different stages of onsite construction rather than being able to support factory style construction prior to transportation to site of completed product for erection. Issues related to the lack of a standardised quality assessment process for offsite construction along with gaps in current building standards and codes complicate matters.

- When asked how much of a risk the issue around progress payments was to lenders and investors **nearly 70% responded 'High' (25%) or 'Very High' (44%) and no respondents indicated the risk was low.**

Considering the progress payments related risk, lending institutions are however accustomed to releasing funds for buildings constructed offsite after the building has been placed on site. The stage at which funds are released varies between lenders from when the building is installed on approved footings to when a certificate of occupancy has been issued. Hence the issue of progress payments is currently being overcome by developers, or even the

building manufacturers, providing the funding required for the construction phase to then allow customers to seek purchasing finance based on the completed building. Although this model allows for the client or owner to secure traditional loan products based on a completed building there are two draw backs that are hindering the growth of the industry. Firstly it lends itself to large companies who can afford to provide construction phase financing, with smaller operators having to mortgage their own assets (or requiring customers that have appropriate assets to leverage), and secondly it means that the risk is carried by the builder or manufacturer until payment is made. Since the purchase finance cannot be secured prior to the construction stage this leaves the builder open to risks like the customer not being able to secure funding after the building is complete, or having the client change their mind before the building is completed.

4. CONCLUSION

At a project level there are numerous economic, social, and environmental benefits associated with building manufacture or offsite construction. According to research by the Australian Sustainable Built Environment National Research Centre (SBEnc, 2014), new approaches to design, materials, and expanding the use of modular techniques can take advantage of faster fabrication times, lower costs, less waste, high quality standards, and shorter onsite construction periods. These enhanced outcomes provide benefits to both the builders and the financiers.

In order to capture the potential of building manufacture the building sector needs to quickly develop the infrastructure for the construction of buildings in centralised facilities and their transport and erection on site. This may involve a transition strategy that includes an initial push for the use of panelised onsite construction to build momentum in the manufacture and erection of prefabricated components and modules. It is particularly important to develop the sector in a manner that takes advantage of the cost effectiveness of sourcing building modules offshore, otherwise such offerings may compete with domestic construction. Hence, if countries slow to invest in this new sector do not seize the opportunity, offshore interests will certainly continue to bring them to market, which if not harnessed as part of the sectors overall development could lead to job losses across the building sector and its supply chain.

REFERENCES

- [1] Business Wire – A Berkshire Hathaway Company, ‘Research and Markets: The Global Prefabricated Buildings Market - Key Trends and Opportunities to 2017’.
- [2] SBEnc (2014) “Investigating the Mainstreaming of Building Manufacture in Australia”, Industry Report to the Sustainable Built Environment National Research Centre (SBEnc), Curtin University Sustainability Policy Institute, Curtin University, Perth.

Session 2.4: Policies for High-Performance Green Buildings (1)

Demystifying and Democratizing the Energy Use Conversation to Support the Net-Zero Challenge

Birgit SIBER^a, Mike WILLIAMS^b

^a *Diamond Schmitt Architects, Canada, bsiber@dsai.ca*

^b *Rowan Williams Davies & Irwin Inc., mike.williams@rwdi.com*

ABSTRACT

Ambitious climate change targets are transforming how new and renovated buildings are designed and constructed. As the industry seeks to significantly reduce built form energy use, carbon emissions and, ultimately, strive for net-zero - or better yet, net-positive - the professionals engaged in meeting these challenges must grasp a new way of thinking about energy use and design. ecoMetrics was developed to reveal the energy modelling data for a portfolio of projects and thereby inform decision making. It also seeks to expose the key integrated passive and active systems that drive energy use down. The goal is to present data gleaned from energy modelling results that can be understood by non-energy experts in graphic, accessible terms.

The architects and engineers who developed ecoMetrics believe improving energy literacy and transparency is a necessary and fundamental step in advancing the outcome of the challenges we all face to realize the urgency of significant energy use and carbon emission reduction in building design.

Keywords: architecture 2030, big data, energy metrics

1. ENERGY LITERACY

The sharing of information is a key tenet of the integrated design process (IDP) that drives most of today's energy-efficient building projects. Energy metrics are complex, difficult to understand and opaque for most non-engineers, which limits the conversation and exploration of deeper energy reductions. There is a vast array of energy reduction programs and benchmarks - Building Codes based on ASHRAE and MNECB, LEED and the 2030 Challenge all have different energy use approaches and metrics.

During the design phases of a project, energy simulation modelling informs decision-making. Energy simulation models are typically developed and submitted for review for LEED projects and more recently for building permits. Quick access to energy use in our portfolio of buildings has been elusive until we created an internal data bank. We strove to frame modeled data in a way that is meaningful to the architectural profession. Simply, we unpack the energy simulation models for our projects and reveal the data in accessible graphic terms. If we can understand it, we can explain it. Similarly, if we can understand it, we can manage it. To this end, we created a series of custom templates or lenses through which to view the enormous amount of data contained in energy models; data that we typically never see. The result is ecoMetrics an in-house tool that democratizes the energy-use conversation and decision-making.

ecoMetrics is a live, interactive database that currently showcases building energy simulation model results for **over 50 completed Diamond Schmitt Architects' projects.** It contains templates for various purposes: energy literacy, benchmarking, design and data management.

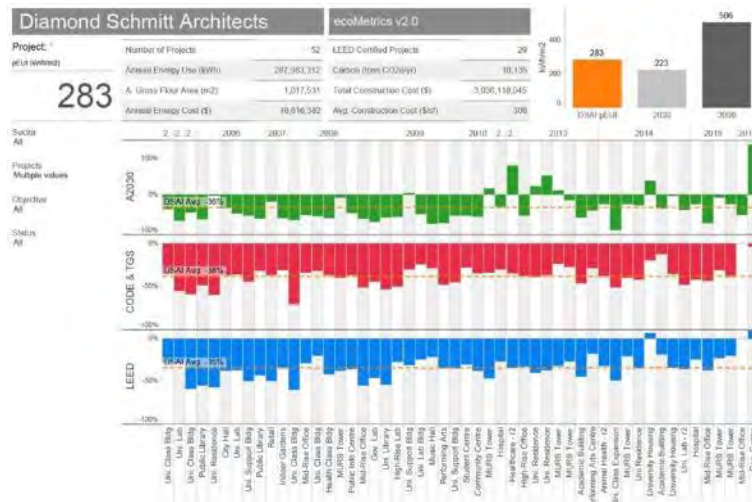

Table 1: The Benchmark Comparison template highlights differences between prevailing energy metric systems. The 2030 Challenge is based on kWh/m²/year as compared to a building of its type in its region. Canadian codes and LEED are compared to a reference building of identical configuration as the design building. Codes assess energy while LEED assesses cost of energy. The comparison template shows greatest divergence between the 2030 challenge and the code / LEED methods.

The following Tables 2, 3 and 4 highlight several of the databanks key templates:

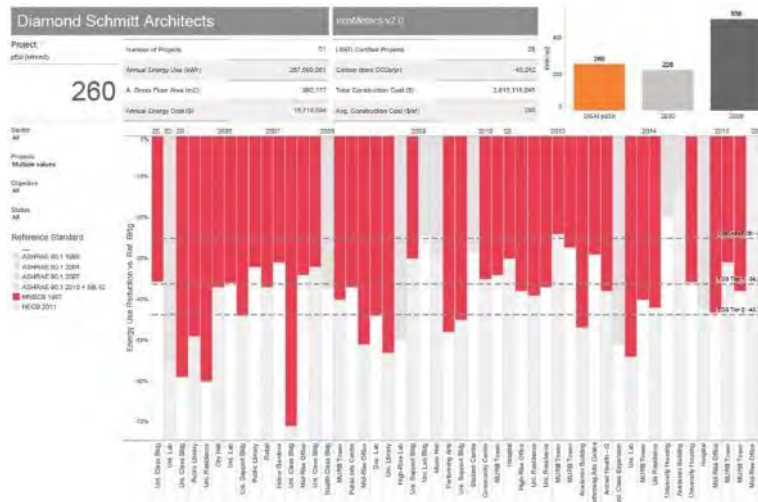

Table 2: The Building Code Template shows 51 uploaded projects. Red bars represent those projects modelled as compared with the MNECB (Model National Energy Code for Buildings). Grey bars represent projects modelled as compared to ASHRAE; these are carried on a separate template. The longer the red bar the greater the energy reduction of the building. The upper dashed horizontal line indicates the OBC-SB-10 25% energy reduction, which is a mandatory reduction required to obtain a building permit in Ontario. The middle dashed line represents Toronto Green Standards (TGS) Tier 1, which has a 36.25% energy reduction requirement for building permit in Toronto. The lowest dashed line represents TGS Tier 2, which is a voluntary, and incentivised 43.75% energy reduction target. This template instantly allows us to see how our building portfolio performs relative to these code requirements and to each other.

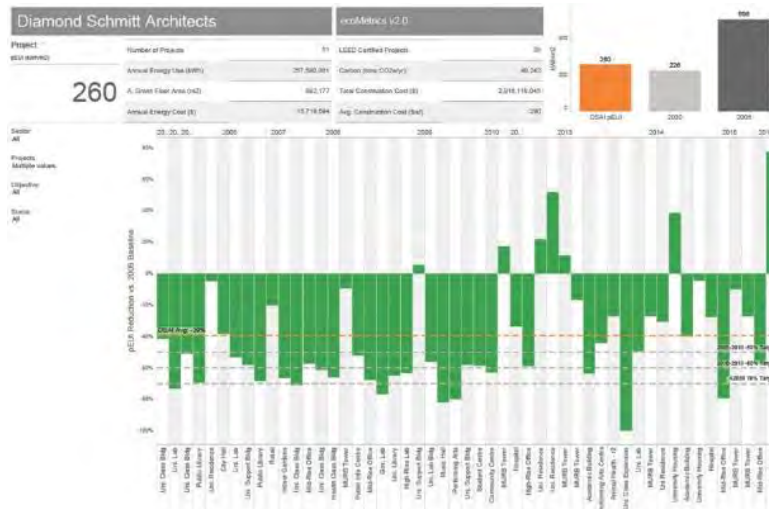

Table 3: 2030 Challenge Template shows 51 uploaded projects. Green bars represent modelled energy reductions relative building type as set out by NRCAN. The longer the green bar below 0% line, the greater the energy reduction. The orange dashed line is the portfolio average. The top grey dashed line indicates a 50% reduction, the target for projects tendered before 2010. The middle dashed grey line indicates a 60% reduction, the target between 2010 and 2015. The lowest dashed grey line indicates a 70% reduction, the target for projects tendered between 2015 and 2020. Those projects with green bars above the line are predominantly MURB (Mixed Use Residential) Towers and Student Residence towers. These projects all meet code but not the baseline carried by 2030 Challenge.

The energy metric approach set out in the 2030 Challenge led us to explore the comparison of energy uses as chronicled in the following template which focuses on Energy Use Intensity (EUI).

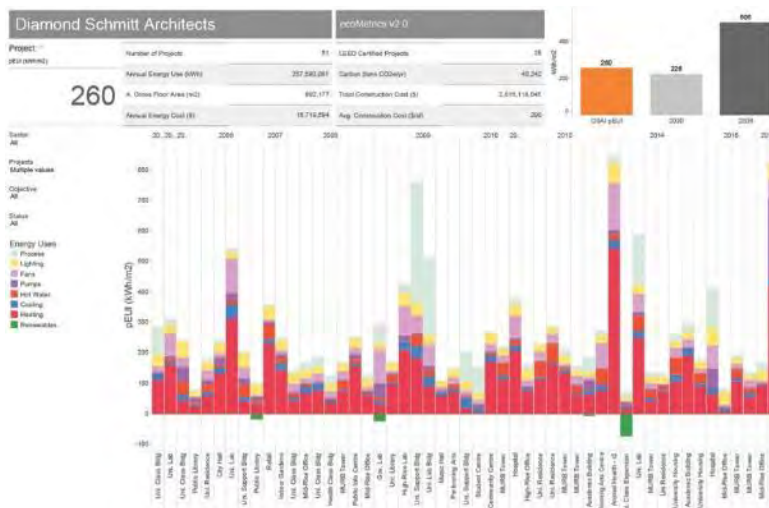

Table 4: The Energy Use template reveals modeled kWh/m²/yr statistics for the main categories of end energy uses (heating, cooling, pumps, domestic HW, fans, lighting, process loads) and exposes energy use as an apples to apples comparison between projects. Colours represent major energy uses above the 0 line and renewable energy in green below. The light blue tone at the top of each column represents the process (or plug) loads. These process loads are influenced by building function and client expectations. On a few projects, the process loads are equal to the building operation loads, highlighting the importance of client participation when striving towards zero energy. The Uni. Class Expansion project (13th column from the right) is a net-zero energy and carbon project: renewable energy matches energy use.

The data contained in these templates increases our understanding of the prevailing energy use methods and how our projects perform within each framework.

Energy literacy and access to key data from the portfolio can form a foundation for new design projects. Fully integrated design, where architecture and engineered systems are designed in lockstep for optimal energy performance, is essential for high performance and net-zero buildings. Gaining insight into the architectural (passive) parameters is a useful starting point for early design modeling.



Table 5: The Architectural template has been developed to capture passive (non-system) model inputs such as building envelope thermal performances, window-to-wall ratios, floor-area-to-perimeter ratios, which provide valuable insight into correlations between building EUI (Energy Use Intensity) and strategies to reduce energy use through built form and design. The template below shows Educational Building Types sorted with most efficient EUI to the left. This provides a data set to inform the design of new projects and guide early stage shoebox massing model comparisons.

Curiosity to explore the integration of passive and active systems has led to the vital signs template that is described further in section 6 below.

The ecoMetrics databank is visually accessible and interactive; this data empowers us, our design teams and clients with a foundation for decision-making during design; it raises our collective understanding of energy targets and provides access to the methods used for deep energy reductions using our portfolio of projects as reference.

2. BENCHMARKING AND SETTING TARGETS

As we strive towards designing net-zero and net-positive or regenerative buildings, we incrementally work towards increasingly high performance buildings. We have recognized that setting an energy reduction target is a powerful driver for the team that focuses effort and improves results.

Evolving code requirements are also a potent driver for change as building permit issuance is subject to design compliance. OBC-SB10 increased energy performance requirements for the province of Ontario. Toronto Green Standards Tier 1 further increased the requirement for metropolitan Toronto. In both cases obtaining a building permit is contingent on following a prescriptive path or demonstrating compliance through an energy simulation model submission.

Energy reduction incentives provided in programs such as the Toronto Green Standards Tier 2 encourage clients to aim for greater reductions. The modelled performance of past projects is a valuable resource for both client and the design team to make decisions about the appropriate energy reduction target. Precedent high performance projects engender confidence for clients to aim as high or higher.

Case study: When Version 2 of the Toronto Green Standard (TGS) was launched ecoMetrics provided Diamond Schmitt Architects the ability to reassure their clients that the enhanced performance targets that TGS v2 presented were an achievable step forward, not an insurmountable leap. With the development of TGS v3 is in the works we anticipate ecoMetrics being similarly useful when it is released.



Table 6: Code Template selection set to educational and lab buildings. A search selecting academic buildings allows us to instantly see that 100% meet OBC SB-10, 77% meet TGS Tier 1 and 61% meeting TGS Tier 2. Note that Animal Health meets TGS Tier 1.

The 2030 Challenge views energy reduction through another lens based on kWh/m²/year. This energy reduction program has been adopted by the AIA, RAIC and the OAA and its strength is that it focuses on energy and incrementally increases the energy use reduction by 10% every 5 years to 100% by 2030, with an allowable 20% contributed by renewables. Building performance is adjusted to a baseline for building type and region. We have discovered that projects that do well based on code targets may perform poorly relative to the 2030 challenge. Viewing projects through both lenses helps flag issues and identify opportunities to improve energy performance.

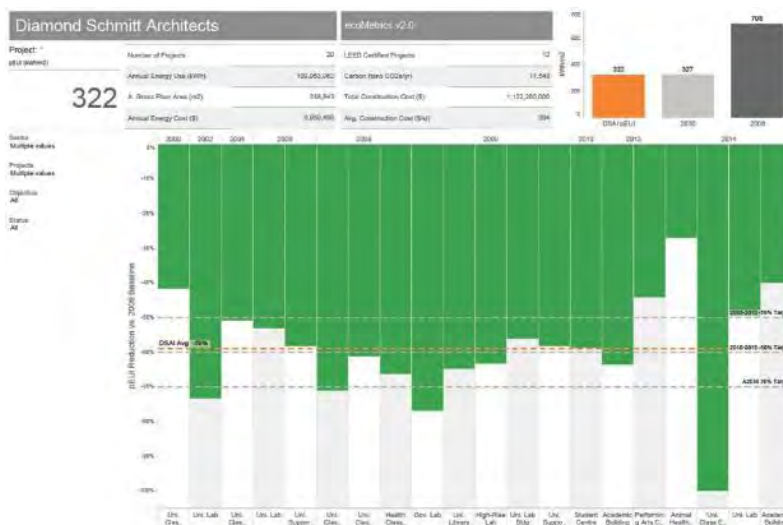

Table 7: 2030 Challenge Template selection set to educational and lab buildings. Note that Animal Health does not perform well relative to 2030 Challenge. The most recent projects to the right show data for several non-LEED projects.

Code officials are taking note; increasingly we are seeing an array of metrics being established to meet minimum program requirements. In Ontario for example, peak electricity demand (kW), carbon intensity (eCO₂/m²) and energy use reduction vs. a reference building are all required to be reported and meet minimum performance benchmarks. We anticipate this trend to continue as programs that are seen to be on the leading edge, such as Passive House, introduce new metrics such as Thermal Energy Demand Intensity, and infiltration limits. Interpreting and contextualizing metrics will be a critical skill for future building design and we believe tools such as ecoMetrics have great potential in this regard.

The 2015 Paris Climate Change Summit focused on GHG emission reduction. Canada, Ontario and Toronto now have carbon reduction targets, although not identical, they are all ambitious. Across the country there are various approaches being developed that will drive market change, finance significant incentives and penalize large carbon emitters. Carbon is an important new metric and has been included in the ecoMetrics databanks.

Net-zero, net-zero ready and net-positive buildings are emerging within our portfolio, demonstrating that a no carbon future is possible. However, like our LEED Platinum projects, these projects rely on fully integrated passive design and systems design to drive energy use down.

3. LEVERAGING DATA

Many predict that data will be leveraged to provide much needed direction as the green building movement **continues to advance**. **ecoMetrics presents Diamond Schmitt Architects' effort to utilize data from completed projects to advance the work produced by our studio.**

In his recent book, *The Industries of the Future*, Alec Ross, an Innovation Advisor to Hillary Clinton, outlines the **current and future technological trends that will be drivers of disruptive change**. **Mr. Ross identifies 'Big Data' as one of six technologies that will have a broad reaching impact on many, if not most, industries in a similar fashion to the impact of the Internet in the late 1990s.** How is the building design, construction and operations industry readying itself to leverage big data?

To date, existing operational buildings are leading the way in the development of large data banks of building energy performance information. For example, since 2011 the Green Energy Act **has required all of Ontario's Broader Public Sector (BPS) buildings to report their annual energy use and Greenhouse Gas emissions.** Other examples include Local Law 84 in New York City that requires all public and private buildings greater than 50,000 sq. ft. to disclose their energy use and the City of Philadelphia, whose mandatory energy-reporting program has been in place since 2012.

The data banks being developed in Ontario, New York, Philadelphia and by other municipalities around the world are based **on data reported from operational 'existing buildings'**. **The collection of existing building energy performance data is tremendously important and will undoubtedly begin to inform buildings codes, incentive programs, green building standards and carbon reduction strategies.** However, the wealth of information available **in 'new construction' building design documents presents a large, rich and underleveraged opportunity.**

Data such as predicted levels of energy performance, building geometric characteristics, mechanical systems performance, amongst many other metrics, are data points that can be harvested from design information available **from new construction projects in a relatively easy fashion.** **Diamond Schmitt Architects' ecoMetrics provides an example of the data that can be harvested from new construction projects and how graphic representations can be developed to gain insights into the data set.**

4. CHECKS AND BALANCES

The role of the architect as the prime consultant often requires taking an oversight role of specialty consultants who are responsible for the completion of studies such as energy models. **ecoMetrics provides Diamond Schmitt Architects with a powerful tool to vet energy models prepared by sub-consultants through a quick comparison to other completed projects in the Diamond Schmitt portfolio.**

Through growing adoption and rollout of voluntary programs such as LEED, energy codes and regulations and incentive programs, the use of energy modelling to inform design decision-making has become commonplace. As a result, energy modelling and consulting as a discipline has moved from being a niche service performed by specialists to an exercise that is now being completed by designers without the years of experience necessary to interpret the validity of results produced by energy performance software. Programs such as LEED require a third party review of energy models to be completed by experienced experts prior to granting approval. However, such review processes are not typically in place when energy models are being submitted for regulatory purposes such as code compliance. The result is energy models that are of questionable quality and a growing divide between predicted and measured energy performance as a result. **ecoMetrics allows for quick, inexpensive screening level reviews of energy models to be completed through a comparison to similar completed projects.** If municipalities were to create accessible data banks of submitted energy models, a similar approach could be taken, with the potential to significantly raise the quality and accuracy of energy models.

There is a trend towards completing an early energy model at the concept stage of design to support preliminary decision-making. However, preliminary models are typically based on broad assumptions that can produce

misleading results if not checked by an experienced professional. The availability of a data bank of previously completed energy models has the potential to aid in solving this challenge by allowing design teams to compare their results to aggregated results from like projects. Designers at Diamond Schmitt are using ecoMetrics in this fashion to inform Sefaira energy simulations that are being completed at the concept or schematic stages of design.

Case Study: On a recent project, the project's design progress energy model was uploaded to ecoMetrics to find that the proposed energy use intensity far exceeded that of any other project in the tool. Upon further investigation it was noted that the "Vital Sign" (see Section 6) for outdoor air was one of the highest in the portfolio. Identifying this outlier triggered a conversation with the mechanical engineer about the project's approach to ventilation. Through a rezoning exercise and the addition of demand control ventilation in critical spaces the design team was able to reduce the projects total predicted energy use intensity by over 25%.

5. VITAL SIGNS

ecoMetrics has raised the understanding of performance benchmarks such as Energy Use Intensity (EUI) and reduction targets vs. energy codes within the Diamond Schmitt studio. This collective understanding brought forth the next logical question – what do we do about it? Inspired by this question and a paper by Dr. Ted Kesik, Diamond Schmitt Architects and RWDI set out to develop a set of next level indicators that are intent on identifying the architectural and engineering systems that are driving the performance of a given project.

In a 2015 paper, 'Vital Signs: Towards Meaningful Building Performance Indicators' University of Toronto professor Dr. Ted Kesik suggests that the root of the emerging problem with energy simulations is 'a failure to correlate measureable and/or observable physical attributes with key indicators that concisely reveal the critical performance characteristics of buildings'. Dr. Kesik further suggests that there should be a set of building performance indicators, which designers could use to diagnose building performance issues in a similar fashion to how physicians use indicators such as a patient's heart rate and blood pressure to diagnose human health concerns.

Building upon this concept, RWDI and Diamond Schmitt worked to analyse the data set resulting from the ecoMetrics tool to identify and propose a set of 'vital signs'. In this context, vital signs are a set of performance indicators that are intent on identifying the architectural and engineering systems that are driving the performance objectives of a given project. The ecoMetrics "Vital Signs" template is presentation below as Table 8.

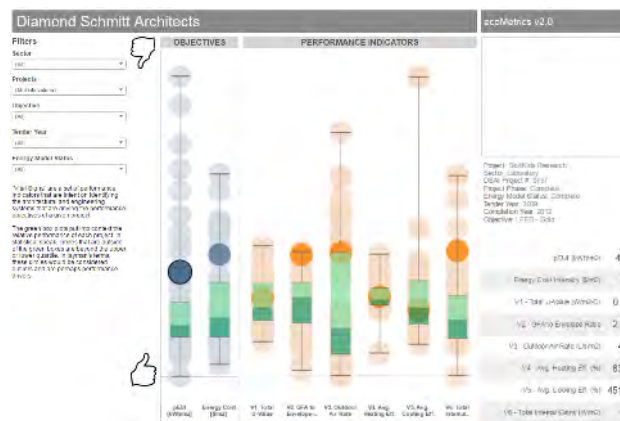

Table 8

The objectives or performance indicators for each project are displayed along a spectrum as blue or orange circles, respectively. The green box plots put into context the relative performance of each project. In statistical speak, circles that are outside of the green boxes are beyond the upper or lower quartile. In layman's terms, the circles outside the typical range for each vital sign would be considered outliers and warrant further exploration.

The hypothesis is that successful management of these six key metrics throughout the design process should result in improved energy use and energy cost performance. The following performance indicators are the "vital signs" that we have proposed:

- Total Envelope U-Value: the weighted average thermal resistance of all above grade envelope components
- GFA-to-Envelope Ratio: an indicator of the architectural efficiency of the built form

- Outdoor Air Rate: the average rate at which outdoor air is being introduced into the building
- Heating Efficiency: the weighted average of heating equipment efficiencies
- Cooling Efficiency: the weighted average of cooling equipment efficiencies
- Internal Gains: the sum of major sources of internal heat gain including: lighting, people and process equipment normalized by the building gross floor area

These individual vital signs do not necessarily provide much insight to designers without a background in building energy performance consulting. However, when compared to a set of like buildings from a data bank of completed projects, the vital signs become compelling design tools that reveal performance indicators that are often buried in the appendices of energy reports or never extracted from digital simulation files.

The efforts to date by RWDI and Diamond Schmitt Architects present a starting point. Further work is required to increase the size of the data set, which will allow for regression analyses to be conducted to statistically test the strength of the correlation between the vital signs and the desired outcome.

REFERENCES

- [1] Architecture News 2016, **10 Green Building Megatrends from the 'Godfather of Green'** [online]. Retrieved from: <https://sourceable.net/10-green-building-megatrends-godfather-green/#> [Retrieved on April 11, 2016]
- [2] Ross, A., 2016. The Industries of the Future.
- [3] The Province of Ontario 2011, O. Reg. 397/11: Conservation and Demand Management Plans [online]. Retrieved from: <https://www.ontario.ca/laws/regulation/r11397> [Retrieved March 28, 2016]
- [4] The City of New York 2009, Local Laws for the City of New York No. 84 [online]. Retrieved from: http://www.nyc.gov/html/planyc2030/downloads/pdf/1184of2009_benchmarking.pdf [Retrieved on March 28, 2016]
- [5] The City of Philadelphia, 2014, City of Philadelphia Energy Benchmarking Report 2014 [online]. Retrieved from: http://www.phillybuildingbenchmarking.com/wpcontent/uploads/2015/09/MOS_BnchMrkRprt_R5fin_FINAL.pdf [Retrieved March 28, 2016]
- [6] Kesik, T., 2015. Vital Signs: Towards Meaningful Building Performance Indicators. Pg. 1

Building Energy Saving Strategy in Hong Kong — “Built-in” + “Plug in”

CHAN Pak-cheung^a, CHIU Chun-ting^b, KONG Ka-wah^c, SHUM Chung-yee^d

^a Electrical and Mechanical Services Department, Government of the HKSAR, Hong Kong SAR, pcchan@emsd.gov.hk

^b Electrical and Mechanical Services Department, Government of the HKSAR, Hong Kong SAR, ctchiu@emsd.gov.hk

^c Electrical and Mechanical Services Department, Government of the HKSAR, Hong Kong SAR, kwkong@emsd.gov.hk

^d Electrical and Mechanical Services Department, Government of the HKSAR, Hong Kong SAR, cyshum@emsd.gov.hk

ABSTRACT

Hong Kong is a densely populated metropolitan city crowded with more than 7 million people. The erection of high-rise buildings is thus essential for accommodating the residents of this small stretch of land. These buildings and the activities therein are the energy terminators which consume about 90% of the city's total electricity use. Of the 50,000 buildings and facilities in Hong Kong, commercial sector and residential sector account for around 66% and 26% respectively of the electricity share. Thus, energy saving in commercial and residential buildings is a key factor in addressing climate change and associated environmental issues of Hong Kong.

HKSAR Government has been pursuing various energy efficiency policies and initiatives to reduce energy use in buildings. In 2012, the Buildings Energy Efficiency Ordinance, Cap 610 (BEEO) came into full operation. It requires new buildings as well as existing buildings undergoing major retrofitting to comply with the energy efficiency standards and requirements specified in the Building Energy Code (BEC). Such “built-in” approach is able to regulate nearly 80% of electricity consumption in commercial buildings. Meanwhile, by specifying the energy performance of 5 types of “plug-in” domestic electrical appliances under the Energy Efficiency (Labelling of Products) Ordinance, Cap 598 (EE(LP)O) since its full implementation in 2009, about 60% of electricity consumption in residential sector can be regulated. These two pieces of legislation govern the “built-in” system and “plug-in” appliances in buildings, which together constitute over 70% of electricity consumption in Hong Kong.

An overview of the BEEO and the EE(LP)O will be given in this paper. The latest update since their full implementation, including progress of enforcement, tightening of energy efficiency standards and issuance of new Codes, will be highlighted. Besides, the way forward in enhancing energy efficiency of existing buildings through operational optimization and retro-commissioning will be addressed.

Keywords: building energy code, Buildings Energy Efficiency Ordinance, Energy Efficiency (Labelling of Products) Ordinance, energy saving

1. INTRODUCTION

Hong Kong consumed 289,160 TJ (about 80,000 million kWh) of energy in 2014, in which around 55% energy end-use is in form of electricity consumption. With more than 7 million people squeezed within small stretch of 1,100 km land, the fulfilment of living needs and city operation has indeed resulted in making Hong Kong the most vertical city in the world. It is thus not surprising that buildings take up about 90% of our total electricity consumption, and is roughly 50% of total energy end-use. When comparing to the global energy use in buildings of 40% of the total energy consumption, the energy footprint for buildings in Hong Kong is affirmatively on the high side. It is imperative to reduce the use of electricity in buildings to help mitigate climate change. Commercial buildings and residential buildings are the major sectors which share 66% and 26% of electricity use respectively.

To this end, the Electrical and Mechanical Services Department (EMSD), HKSAR enacted two Ordinances respectively to govern those “plug-in” electrical appliances in residential buildings and “built-in” major building services installations in commercial buildings.



Figure 1: BEEO and Energy Label under MEELS

2. THE BUILDINGS ENERGY EFFICIENCY ORDINANCE

The BEEO gives a legislative foundation to continuously save energy use in both new and existing buildings through the mandatory compliance of its BEC and Energy Audit Code (EAC). For building design, the BEC governs **the minimum energy efficiency standards for “built-in”** central building services installations, including air-conditioning, lighting, electrical as well as lift and escalator systems, which are about 80% of electricity consumption in buildings. Meanwhile, EAC sets out the technical guidance and details in conducting energy audit for commercial buildings.

2.1 Certificate of compliance registration

The BEEO requires the developers of newly constructed prescribed buildings to engage Registered Energy Assessors (REA) to certify and submit “stage one declaration” at design stage to declare all the major building services installations (BSI) in buildings have been designed and will be completed according to the specified standards and requirements under BEC. Subsequently at occupation approval stage, the developers are further required to submit “stage two declaration” certified by REA to declare those BSI have been installed and completed in accordance with the BEC requirements, and apply for Certificate of Compliance Registration (COCR) which will be valid for 10 years.

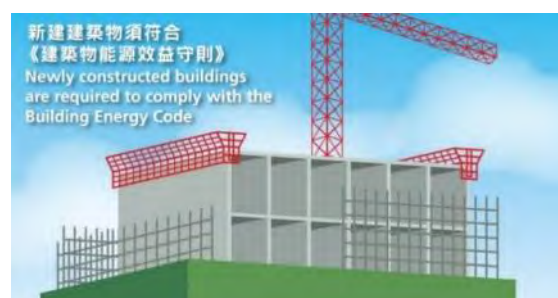

Figure 2: BEEO applicable to newly constructed buildings

2.2 Major retrofitting works

When Major Retrofitting Works (MRW) are involved, irrespective of newly constructed buildings or existing buildings, the owners or responsible persons are required to obtain a Form of Compliance (FOC) from REA **certifying the MRW's compliance with the BEC**. MRW refers to the addition or replacement of BSI covering a works floor area aggregated to 500m² or above, or the addition or replacement of a CBSI component, including an electrical circuit at rating 400A or above, a chiller/ air-conditioner at 350 kW cool/ heat capacity or above, or a motor drive plus mechanical drive of a lift or escalator.



Figure 3: BEEO applicable to major retrofitting works in existing buildings

2.3 Energy audit

Owners of commercial buildings are required to engage REAs to conduct energy audits for the CBSI of their buildings once every 10 years. The energy audits should be carried out in accordance with the requirement of EAC. After the audits, energy audit forms which contain the energy utilization index (EUI) of buildings must be exhibited in conspicuous positions at the main entrance of the buildings. Energy Management Opportunities (EMO) should be included in the energy audit report for building owners to realize the possible savings of the building and to consider further the implementation plan in the future.



Figure 4: BEEO requires commercial buildings to carry out energy audit

2.4 Implementation of the Building Energy Efficiency Ordinance

Upon **full implementation of the BEEO in Sep 2012, around 1,200 “stage one declaration” have been received and over 220 COCR have been issued.** As for major retrofitting works, about 5,200 FOC have been recorded for completion of work in prescribed buildings. It is also expected that about 4,000 commercial buildings are required to comply with the energy audit requirements. In respect of enforcement actions against any non-compliance with BEEO, prosecution action will be instigated if relevant parties fail to comply with the statutory requirements. On the other hand, briefings and presentations have continuously been conducted for all stakeholders including developers, building owners and tenants etc. to promote the statutory requirements of BEEO.

2.5 Continuous review of the codes

The BEC and EAC will be reviewed at a 3-year interval since the initial edition was issued in 2012 so as to further tighten the energy efficiency standards. In each review, reference will be made to the latest worldwide technological development as well as the updated international standards and public aspirations. The review was conducted by a Technical Taskforce with members drawn from the relevant professional institutions (including green groups), trade associations, consultant or contractor associations, university academia, and government departments. Six Working Groups were formed under the Technical Taskforce to help provide expert advice on the possible improvements to the energy efficiency standards and requirements under BEC and EAC.

The first comprehensive review was conducted in Sep 2014 and completed in mid-2015. The updated version of the BEC and EAC (i.e. BEC 2015 and EAC 2015) were gazetted with a press release in Dec 2015. Having taken into account the past practice and the operational need of relevant trades, grace periods of six-month and nine-month respectively have been provided for COCR and FOC submission respectively. The revised energy efficiency standards are expected to bring around 10% energy saving in buildings as compared to those under BEC 2012.

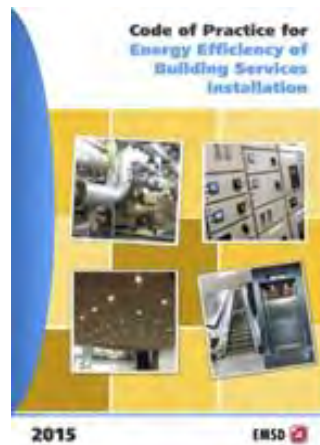

Figure 5: BEC 2015 Edition

3. ENERGY EFFICIENCY (LABELLING OF PRODUCTS) ORDINANCE

3.1 The Ordinance

The Mandatory Energy Efficiency Labelling Scheme (MEELS) was introduced through the Energy Efficiency (Labelling of Products) Ordinance (Cap. 598) [EE(LP)O] which was enacted in May 2008. The MEELS was implemented in phases. The initial and second phases were fully implemented on 9 November 2009 and 19 September 2011 respectively. Currently, five types of prescribed products, namely room air conditioners, refrigerating appliances, compact fluorescent lamps, washing machines and dehumidifiers are covered that altogether account for about 60% of the annual electricity consumption in the residential sector.



Figure 6: Five types of prescribed products regulated under MEELS

Under the EE(LP)O, the manufacturers or importers are required to submit relevant forms, test reports and associated product information to EMSD for assignment of reference number for the product models and attach energy labels in the prescribed formats as specified in the EE(LP)O before supplying these products in Hong Kong. All local suppliers (including wholesalers and retailers) cannot supply the specified products without any energy labels.

As at the end of August 2016, over 7,800 product models have been listed under the MEELS. Consumers can check the information of these product models in the thematic website namely Energy Label Net.

Since the enactment of the EE(LP)O, the MEELS has been effective in –

- Promoting energy saving by informing potential customers of the energy performance level of the products and facilitating customers in choosing the more energy-efficient models;
- Encouraging product suppliers to make available more energy-efficient products to meet **customers'** demand; and
- Increasing the penetration rate of energy labels through the introduction of legislation to mandate the display of energy labels.

3.2 Review of MEELS

Any regulatory system has to move with times. The scope and grading standards of MEELS are kept under regular reviews to ensure that the grading standards will not lag behind technological advancement. The scope of MEELS is also regularly reviewed to cover more products and hence increase the penetration rate of products bearing energy labels.

3.2.1 Review of grading standards

A review of the grading standards of room air conditioners, refrigerating appliances and washing machines was completed in late 2014. In reviewing the grading standards of these products, due consideration has been given to the distribution of the appliances among various existing grades; grading systems adopted overseas; development of testing standards; technological development and potential energy savings arising from further tightening of the grading standards, etc.

The energy efficiency grading standards of these 3 products have been tightened and promulgated through issuance of a revised Code of Practice on Energy Labelling of Products (CoP). The revised CoP stipulating the new grading standards was published by gazette in October 2014. Full implementation took place on 25 November 2015, after which the three products to be supplied into the market must bear energy labels under the new energy efficiency grading standards.

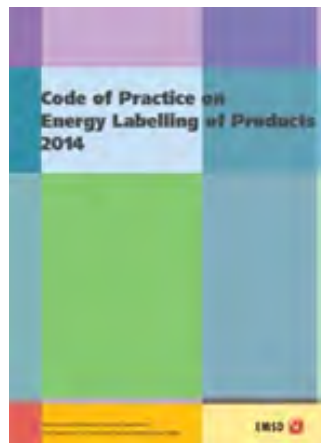

Figure 7: CoP on Energy Labelling of Products 2014 Edition

3.2.2 Proposed third phase of MEELS

In order to capture further energy saving potential, a review of the scope of the MEELS has been conducted with a view to expanding the coverage of the scheme. Having considered the comments received during a 3-month consultation conducted in the second quarter of 2015 and other factors such as overseas practices, availability of test standards and testing laboratories, as well as energy consumption and energy saving potential of the products, it was proposed to include more products such as televisions, storage type electric water heaters and induction cookers in the MEELS. In addition, the existing coverage of room air conditioners and washing machines will also be extended. The Legislative Council Panel on Environmental Affairs was consulted in January 2016, and was supportive of the proposal. The preparation of legislative amendment of the EE(LP)O is underway.

4. PROMOTION OF ENERGY SAVING IN BUILDING – GOING FORWARD

With the full implementation of BEEO and EE(LP)O, 80% of electricity consumption of "built-in" central building services installation in commercial buildings as well as 60% of electricity consumption of "plug-in" domestic electrical appliances can be effectively regulated. By combining the effect of these Ordinances, over 70% of electricity consumption in Hong Kong can be governed.

While the energy intensity and carbon intensity of Hong Kong has been the lowest among the APEC economies, we should continuously strive for further improvement towards energy efficiency to help mitigate climate change. To this end, a first-ever **"Energy Saving Plan for Hong Kong's Built Environment 2015 ~ 2025+"** was launched in May 2015 by HKSAR to address the necessity on reducing energy consumption in Hong Kong and a new target

of reducing Hong Kong's energy intensity by 40% by 2025 has been set. With this ambitious vision, the whole community has to endeavour further effort to achieve energy conservation with concrete supporting measures.

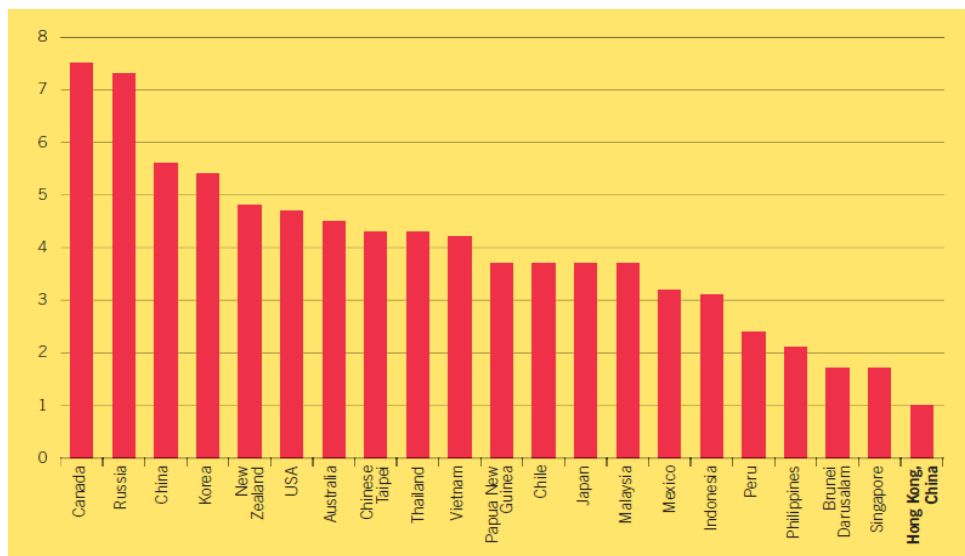

Figure 8: APEC energy intensity ranking, 2012

The Government is leading by example. In particular, we have set a new target of 5% saving in the electricity consumption of government buildings in the next five years from 2015/ 16 to 2019/ 20. With other green building initiatives being rolled out in full steam and relevant energy efficiency regulations being continuously enforced with further tightened requirements, various energy saving initiatives have been readily in place. However, there will still be a gap to achieve the energy saving target. It is therefore important to trigger contribution from private sector towards the energy saving target. A dialogue platform has been established to forge closer partnership with key stakeholders to foster energy efficiency in the community, especially for the private buildings, as foreshadowed in the Energy Saving Plan. Other initiatives including Retro-commissioning (RCx) will be promulgated by developing a Technical Guidelines for RCx and taking the lead to conduct pilot RCx projects in government and private buildings.

5. CONCLUSION

HKSAR has made a very deliberate move to regulate the energy performance of buildings and electrical appliances. **Through the implementation of BEEO and EE (LP)O on “built-in” central building services installations in commercial buildings and “plug-in” domestic appliances in residential buildings, over 70% of electricity consumption in buildings can be regulated.** Since the implementation of the EE(LP)O and BEEO, which serve as the key drivers of product and building energy efficiency, Hong Kong has taken the very major step forward in addressing to the impacts of climate change by the reduction of energy consumption of electrical products and buildings. This mandatory approach reinforces the roothold of the energy efficiency of electrical appliances in MEELS as well as minimum energy efficiency standards in the BEC, and paves the way for further enhancement in energy efficiency and relevant energy efficiency standards by means of periodic review.

While the Government has put lots of effort by tightening the regulations, enhancing the codes and reducing government energy consumption, the gap to achieve the energy saving target would require the collaboration with the private sector and the community. Therefore, to mobilise stakeholders and the entire community to understand energy efficiency issues better and thus contribute in energy saving is of paramount important. Through the implementation of RCx to trigger private stakeholders to gauge the energy saving potential in existing buildings, we are on the right track to reduce the total electricity consumption in buildings and hence to meet the target of 40% energy intensity reduction by 2025.

6. ACKNOWLEDGEMENTS

Sincere thanks are extended to members (including representatives from ASHRAE, CIBSE, HKIE & PolyU) of the Technical Taskforce on Mandatory Implementation of the BEC and its working groups in offering their expertise advice and support in the development of the BEC and EAC, as well as the members of the Taskforce on the MEELS in offering their advices and support in the development of the new grading standards as well as proposed new product types.

REFERENCES

- [1] HKSAR Government, 2010. Buildings Energy Efficiency Ordinance (Cap. 610).
- [2] HKSAR Government, 2008. Energy Efficiency (Labelling of Products) Ordinance (Cap. 598).
- [3] The Electrical and Mechanical Services Department, 2015. Code of Practice for Building Energy Audit 2015.
- [4] The Electrical and Mechanical Services Department, 2015. Code of Practice for Energy Efficiency of Building Services Installation 2015.
- [5] The Electrical and Mechanical Services Department, 2014. Code of Practice on Energy Labelling of Products.
- [6] The Electrical and Mechanical Services Department, 2010. Code of Practice on Energy Labelling of Products.
- [7] The Electrical and Mechanical Services Department, 2016. Technical Guidelines on Code of Practice for Building Energy Audit 2015.
- [8] The Electrical and Mechanical Services Department, 2016. Technical Guidelines on Code of Practice for Energy Efficiency of Building Services Installation 2015.

How Sustainable Are the Quality Control Procedures for Constructions in Europe?

Frits MEIJER^a

^a TU Delft / Faculty of Architecture and the Built Environment, The Netherlands, f.m.meijer@tudelft.nl

ABSTRACT

Requirements on the sustainable quality (e.g. energy performance) of new and existing buildings are one of the pillars building regulatory systems of European countries are founded on. The influence of EU policy goals and contents of EU Directives in the energy regulations of the Member States is clearly noticeable. The European Union has set the ambitious goal that all newly built constructions must have a zero energy level by 2020. The total building stock must furthermore be energy neutral by 2050. The Energy Performance of Buildings Directive and the Energy Efficiency Directive have given Member States the tools and direction to develop and strengthen their regulations. There are doubts if the current requirements are sufficient to realise these goals. There is common agreement that the goals only can be reached by more strict and supportive policy instruments. This does not necessarily mean that the technical requirements must be formulated in more severe terms. Probably the big-gest challenges could be found in the way the construction process is organized, the regulations are enforced and way the roles and responsibilities of constructors (builders and installers) are defined. On the basis of a comparative research project in seven European countries, this paper analyses to what extent the current frameworks for the quality control of constructions are adequately organised to meet the current and future sustainable demands.

Keywords: policy and regulation, quality control, energy saving

1. INTRODUCTION

From way back quality control of construction work in Europe has been a governmental responsibility. In most European countries local authorities have been responsible for plan approval, site-inspections and checks on completion of constructions. During the last decades however these building control tasks have been outsourced more and more to private parties. The main driving force behind this development has been the wish of governments to deregulate. The shift of responsibilities to private parties should not only improve the quality of construction works but it could also streamline administrative procedures and processes. The idea is that less regulation leads to a qualitative better building stock through cheaper and faster quality control procedures. It is because of these reasons that the Dutch government is on the brink of changing its quality control system of constructions towards a more private model (MBZK, 2015).

Simultaneously with the strong wish to deregulate new quality goals have emerged that require regulatory governmental intervention. The reduction of energy use and environmental impact of construction have been the most important new policy goals the last decades. The European Union and its Member States have implemented regulations that should ensure very energy efficient new buildings and have introduced instruments to improve the energy performance of the existing building stock. The Energy Performance of Buildings Directive and the Energy Efficiency Directive have been the dominant frameworks for the Member States to fit in their national regulations. This growth of energy performance requirements seems to be at odds with the deregulation trend. Furthermore recent studies show that the (energy) regulations are probably inadequate to realize the ambitious energy saving goals (summarized in Visscher et al, 2016). To reach the goals more strict and supportive governmental regulations are needed. That does not only mean formulating more stern demands. It also poses new challenges to the way the quality control process of constructions is organized and the regulations are enforced. The roles and responsibilities of (private) quality controllers and builders are an essential part of this. This paper explores if the regulations and the quality control processes in the 'average' European building regulatory system are fit for the task that lies ahead. Section 2 characterises the essentials of the systems in seven European countries. In the closing sections 3 and 4 the results are discussed and the main conclusions are drawn.

2. OUTLINES OF THE CONTROL SYSTEMS

For many years we have been involved in studying alternative visions on building regulatory systems in international comparative projects. Recently we have been involved in studies for the DG Internal Market (Ecorys and Delft University of Technology, 2015) and for the Dutch government (Meijer et al, 2016). For the latter we compared the quality control system for constructions in the Netherlands, England and Wales, France, Germany, Ireland, Norway and Sweden. In these countries the tasks and responsibilities of public and private building controllers were analysed. The study was based on our existing dataset on building regulatory systems. Additional and updated information was inventoried via desktop research. Relevant regulatory documents and other sources were analysed. Within the framework of this paper only the essentials of the systems can be touched upon.

2.1 England & Wales

For the technical quality control of constructions requiring approval, applicants can choose between local authority building control or a private Approved Inspector. Approved Inspectors have to be certified and must be registered. No legal demands are made about the way in which quality control should take place. Nonetheless both public, as well as private controllers, have voluntarily committed themselves to the Building Control Performance Standards. These standards give guidelines how qualitative good building control should be performed (DCLG, website). Builders have to comply with the general rules concerning materials and workmanship. There are no general recognition or certification schemes for contractors or builders. However specialist installers can join a Competent Person Scheme. These installers can self-certify certain types of building work (e.g. glazing, heating systems), It is assumed that the work meets the requirements. In practice many installations are being placed by these competent persons. Although there is no certainty that all these competent persons deliver adequate work, the certification frameworks in which they have to operate give certain basic assurances about their workmanship, capabilities and experiences. Obligatory demands on indemnity and warranty insurance schemes are in place to protect the building owner. There are no regulations that apply to a post occupancy testing of for instance if the regulations are being met.

2.2 France

For technical control a public-private construction supervision system has been in operation in France for almost forty years (Meijer et al, 2016). The complexity of the construction defines the quality control procedure. For relative uncomplicated works (e.g. dwelling) a registered architect must declare that the plan meets the demands. In practice these works are hardly being controlled during construction (De-man, 2013). For complex construction works with a higher risk quality control by private control organisations is obligatory. Control starts in the phase of plan approval and continues until completion. After plan approval the control organisation has to deliver an initial technical report and an inspection plan. Private controllers are obliged to control the structural and personal safety. Site inspections are held at random. After completion the private controller must deliver an end report. Public and high-rise buildings must have a user permit before they can be used (MLHD, website). Private controllers have to be certified and accredited and must be independent of the applicant/building owner. Organisations can be certified for various control scopes. A decisive factor behind this system is the French insurance and guarantee system for building works (Meijer et al, 2016). The relevant law dictates that every building professional involved with a construction project must have appropriate guarantee insurances. Builders and contractors have to be registered otherwise there is no certainty that they can meet the guarantee provisions.

2.3 Germany

The German model is a mix between public and private quality control. Municipalities are responsible for issuing the (building and completion) permits. Recognised or registered building professionals however play an important role in the system. Certified and registered architect and/or structural engineer must submit the permit application and usually take care of plan approval. In addition — depending of the construction type and control scope — state recognised experts must be involved in the quality control process. These experts have to be independent and comply with strict demands on education and practical experience (Building Code of NRW, 2015). The building application for constructions that are eligible for a regular building permit procedure must be signed by a qualified architect or engineer. Normally state recognised experts verify compliance with demands on structural stability and fire safety). For the construction phase a contractor and a – independent- site manager has to be appointed. Both the builders as the other building professionals have to meet statutory insurance requirements regarding liability.

During construction, building control is exercised by local authority building control and the site manager. After the construction is finished and local authority building control is satisfied the requirements have been met a completion certificate is issued (Meijer et al, 2016).

2.4 Ireland

Ireland has recently (2014) changed its system to an almost entirely private quality control system, in which competent private building professionals are responsible for the quality control of construction works. Applicants for works that need building approval must submit a Commencement Notice that needs the inclusion of a certificate of design compliance and proof that an Assigned Certifier is going to inspect and certify the works and a builder has been hired to carry out the works. The Notice must also be accompanied by an inspection notification framework and an inspection plan. After completion of the project, both the certifier as the builder must certify that the completed construction complies with the demands of the Building Regulations (DECLG, 2014). Shortly after the introduction of the new regulations it became clear that for the construction of one-off dwellings and extensions on existing houses, the control costs were highly disproportionate. This has led to an amendment to the system. Owners and self-builders got the choice to opt-out of the statutory certification and are allowed to demonstrate compliance with the demands by other means. At the same time the government announced the development of a new local authority quality control process for single dwellings and residential and commercial buildings (Meijer et al, 2016). For building professionals inclusion on statutory registers is the primary means of establishing competency. For architects and engineers these registers already are in operation. The register for builders should be in place shortly. Furthermore building professionals must ensure that they are adequately covered for liabilities (DECGL, website).

2.5 Netherlands

In April 2016 the new law on Quality Assurance of buildings has been sent to the Dutch Parliament (MBZK, 2015). The law is going to be discussed in Parliament this autumn. If the bill will be adopted, it will change the quality control system fundamentally. All control activities on compliance with the technical building regulations will be transferred from public authorities to private parties. Construction works eligible for the quality control procedure will be classified in three groups according to their complexity and possible consequences in case of failure. Class 1 contains for instance one family housing. Hospitals and high rise buildings are assigned to class 3. The technical quality control of these construction works will be carried out by private parties. An independent Admission Organisation is going to assess and recognise these private quality controllers and their quality control instruments. In the intended new system an applicant must notify the municipality about his plans and the way quality control is going to be arranged. The appointed private controller carries out plan approval and makes an inspection plan and takes care of the control during the construction phase. At the end of the process the quality controller declares **that the building meets the technical demands (IBK, 2014). To strengthen the position of the 'building consumers'** the liability of builders (e.g. for hidden faults) will be sharpened in the Civil Code.

2.6 Norway

In the 1990's **Norway changed its public quality control system drastically. The new system was largely based on self-certification by approved building professionals.** These enterprises could self-certify their own construction works and that of others. In practice it quickly appeared that this new model proved to be highly ineffective. Self-certification proved to be inadequate and local authorities failed to supervise the private parties (World Bank Group, 2013). From 2012 on a new regulatory framework has come into force. The checks and balances to assure the quality of the quality control process have been sharpened considerably. The demands and supervision on both quality as independence of control have become stricter. Building professionals have to meet demands on education and practical experience. For construction works that are eligible for quality control all parties involved have to be approved by the central government as (KoRD, 2015). All roles have to be filed in properly before the authority issues a building permission (DiBK, website). The process starts with an obligatory consultation meeting where an inspection plan must be established. This plan is used during the construction and completion phase. For critical building elements (e.g. structural components, fire safety, energy efficiency and the building envelope) in complex constructions independent private control is obligatory (Meijer et al, 2016). At the end of the construction process the controller/applicant has to make a completion report. At completion the applicant and builder has to supply the user or occupant of the building with an user and maintenance manual of the building.

2.7 Sweden

For works needing building approval in Sweden at least one private person/party must be involved that controls the quality during construction. Quality controllers must be certified before they can operate in practice (Boverket, website). When private quality control is necessary it is obligatory to make an inspection plan and to organise a technical meeting (Deman, 2013). If the municipal building committee agrees with the inspection plan the building permit is issued. The municipality controls the essential elements (structural and fire safety, sustainability, insulation and health issues) of the intended construction plan during plan approval. During construction a certified independent quality controller takes care of the inspections. No specific demands are made on the builder with respect to registration or practical experience. The building regulations expect that a builder complies with the regulations. Liability-issues of building professionals are usually arranged in standard contracts. After completion an end meeting is held that establishes if all the agreements and commitments have been met that were stipulated in the approved inspection plan. If the municipal building committee is satisfied a written notice is issued to the applicant/owner.

3. DISCUSSION

The main goal of a quality control system is to assure that buildings – after they have been constructed - meet the regulatory quality demands. Traditionally the countries studied, focussed their attention on the beginning of the process. In the meantime they all have developed systems where the checks and balances have been more evenly distributed throughout the building process. During the process qualified architects and engineers (e.g. Germany and France), qualified builders (e.g. Norway, France, Ireland) and qualified controllers (all countries) have to make sure that constructions meet the demands. After completion controllers, and some-times builders too, have to report their experiences and the results of the inspections before local authority building control issues a completion certificate. With these kind of procedures in place the chances are fair that buildings meet the intended minimum quality.

At the same time all countries have been trying (and still are trying) to streamline and simplify their quality control procedures for construction works. Without exception the countries thought that deregulation and privatisation was the way forward. This has led to a greater emphasis on the responsibility of building owners and the transfer of actual quality control from municipalities to private parties. As we have sketched above the emphasis of quality control has moved from the design phase to the as built situation. Strict regulatory demands are made on the requirements that should be tested and sometimes the way it should be controlled. These demands always focus on the control and inspection of the structural and fire safety requirements. What is more, these statutory demands on control and inspection always apply to complex constructions. In most countries dwellings are outside the centre of the quality control attention. An example of this is France, where due to the insurance and guarantee system, the structural and fire safety of complex constructions is inspected thoroughly and adequately. Dwellings are hardly controlled by professionals, because the insurance risks are lower. In a more broader sense one can argue if a regulatory system that is heavily funded on insurance regulations is helpful in the face of climate change. The height of the energy use and the sustainable quality of construction probably hardly affect insurance heights and is no driving force to realise a better environmental quality.

The high potential and expected energy savings in buildings increases the need for accurate quality control. This theme still does not get the attention it deserves in the control systems. However the regulatory infrastructure is already available and more attention for energy and sustainable requirements can be easily incorporated in the current framework. The first step would be to give energy requirements the same status as currently is being done with structural or fire safety requirements. Private quality controllers should be made explicitly responsible to check these requirements.

Other interesting developments are the growing demands on the quality and workmanship of builders and installers. All countries have incorporated various forms of guarantees in their systems to make sure that builders and contractors deliver what they are supposed to do. In England individual installers can certify their work when they are certified as competent persons. In France builders have to be registered before they can be qualified for insurance and can operate in practice. Ireland is working on a voluntary register of builders. In Norway persons and parties who want to perform construction work and building control tasks can be approved and in all cases have to declare that they are fit for the task. In Sweden the builder must appoint a certified site manager who is responsible for the quality control. On top of this, all countries have strict rules for building defects insurances. With

these developments a step can be made to a further professionalisation of builders. However for a successful transition to energy neutral constructions more stern demands must be set on the knowledge and skills of the building professionals. They will have to use new techniques and improve the quality and accuracy of the work. The Competent Person Scheme in England could be an example how to deal with the growing need for accurate quality control. This scheme specifically focuses on construction elements that matter regarding the energy performance of buildings (e.g. windows, glazing and installations). Further study will be needed to determine the accuracy and effectiveness of the scheme.

Regulatory attention for post occupancy monitoring is completely absent in the countries studied. Some countries have had in the recent past some regulations and guidelines relating to the user phase of constructions. Currently only Norway makes regulatory demands with respect to a user and maintenance manual. Besides that building owners all over Europe have to provide an Energy Performance Certificate because of European regulations. It is not foreseeable in the near future that post occupancy monitoring will be incorporated in the building regulatory system of any European country. In view of the growing big datasets with the actual energy use in buildings, one can question if the lack of regulatory post occupancy monitoring matters much. The datasets provide, although indirectly, a wealth of information about the effects of the energy regulations on the actual use of occupants.

4. CONCLUSIONS

This paper pictures the state of the art of quality control systems for constructions in seven European countries. What can be noticed in the countries is that the balance slowly shifts from public control and enforcement towards a more dominant role of private parties and building professionals. This development goes hand in hand with the materialisation of more robust and reliable certification and accreditation schemes to guarantee the quality and qualifications of building professionals. With respect to the scope of quality control we see a strong focus on control of the design to monitoring of the building process and testing of the quality of the final building. Post occupancy monitoring is nowhere an established part of the building regulatory system. With respect to the contents it can be noticed that statutory demands on control (when present) usually are focussed on structural and fire safety issues. The priority to check the energy performance requirements in general does not seem to be high. All along the line more simple constructions (e.g. dwellings) are controlled to a far lesser extent. The leading question in this paper was if current quality control frameworks are adequately organized in the light of the regulatory needs related with the expected climate change. In organizational terms the framework looks adequate enough to make the regulations more climate proof. What is needed is the political will and determination to give the energy and sustainable requirements the same status as for instance the demands on structural or fire safety. The last decades the themes energy saving and climate change have been dominating the political agenda. It seems merely a question of time before the desired changes in the regulatory framework will be implemented. In the end however it is also about the question how the systems function in practice. In our future research we intend to lay emphasis on these practical experiences. Only then a more definite and more balanced judgement can be made about the “**sustainability**” of quality control systems for constructions.

REFERENCES

- [1] Boverket, website of the National Board, for Housing, Building, and Planning. Available at: www.boverket.se. (Retrieved on 16 May 2016).
- [2] Building Code of NRW Bauordnung für das Land Nordrhein-Westfalen, 2015, Available at: <http://www.bauordnungen.de/html/nrw.html>. (Retrieved on 9 May 2016).
- [3] DCLG Department for Communities and Local Government, website provides relevant regulations, guidelines, reports, etc. Available at: www.gov.uk/government/organisations/department-for-communities-and-local-government (Retrieved on 18 March 2016).
- [4] DECLG Department of the Environment, Community and Local Government, 2014, Code of Practice for Inspecting and Certifying Building and Works, February.
- [5] DECLG Department of the Environment, Community and Local Government website contains all relevant codes and regulations; Available at: www.environ.ie/en/DevelopmentHousing/BuildingStandards/ (Retrieved on 11 March 2016).
- [6] Deman, Jonas, 2013, Building control systems and technical control activities in Belgium, the Netherlands, Sweden and France (dissertation for Master Science degree civil engineering) Técnico Lisboa.

- [7] DiBK Direktoratet for byggkvalitet; website of the Norwegian Authority for Building Quality. Available at: <http://www.dibk.no/> (Retrieved on 13 April 2016).
- [8] Ecorys & Delft University of Technology, 2016, Simplification and mutual recognition in the construction sector under the Services Directive (Markt/2014/087/E) Final report, (ISBN: 978-92-79-51535-4).
- [9] IBK Instituut voor Bouwkwaliteit, 2014, Rapportage Verkenningfase; op weg naar een toelatingsorganisatie, The Hague.
- [10] KoRD Kommunal og Regionaldepartemente/Ministry of Local Government and Regional Development, Housing and building department. 2010. Regulations relating to building applications, Oslo, 26th of March.
- [11] MBZK Ministerie van Binnenlandse Zaken en Koninkrijksrelaties,.2015. On-twerp wetsvoorstel kwaliteitsborging voor het bouwen, The Hague.
- [12] Meijer, F. and H.Visscher, 2016, QuickScan van buitenlandse stelsels van kwaliteitsborging in Engeland, Ierland, Duitsland, Frankrijk, Noorwegen, Zweden en Australië, Delft: Technische Universiteit Delft, Faculteit Bouwkunde, OTB.
- [13] **MLHD Ministère du Logement et de l'Habitat Durable; website provides current laws and other legislation.** Available at: <http://www.territoires.gouv.fr/ministere> (Retrieved on 24 February 2016).
- [14] Visscher, H. and F. Meijer, 2016, Energy regulations for houses in the Netherlands: theory and practice, (paper for COBRA 2016), Delft University of Technology, The Netherlands.
- [15] World Bank Group, 2013, Investment Climate; good practices for construction regulation and enforcement reform (guidelines for reformers), January, Washington.

Policy Scenarios of Zero Carbon Building for Hong Kong: To Survive or To Lead?

PAN Wei^a, PAN Mi^b

^a The University of Hong Kong, Hong Kong SAR, wpan@hku.hk

^b The University of Hong Kong, Hong Kong SAR, panmi@connect.hku.hk

ABSTRACT

During the past decade 'zero carbon' building policies have been formulated in a number of countries. In Hong Kong, despite the over 20 years of evolution of building energy codes, there is still no policy agenda of achieving possible zero carbon for buildings. General perception exists on the infeasibility of high-rise buildings particularly in the subtropical climate such as Hong Kong. This paper aims to develop policy scenarios of zero carbon building (ZCB) for the high-rise context of Hong Kong. The research was conducted through the integration of a questionnaire survey, follow-up interviews, series of focus group meetings, and a policy forum, which together engaged over 600 professionals and stakeholders in Hong Kong over a 15-month period. A definition of ZCB for Hong Kong is developed and so is a socio-technical systems ZCB policy framework, elaborating four technical components, i.e. definition and scope, measure and indicator, target and timeline, and renewable energy, within their social, regulatory and geographical contexts. Policy scenarios are developed for different building types and sectors from the status quo towards the UN's 2050 carbon neutrality target. Important opportunities are identified for addressing climate change as well as re-shaping energy and infrastructure planning in Hong Kong, whilst significant risks are also discovered with technological constraints and reluctant behavioural changes. The opportunities are found to outperform the risks. To realise the policy scenarios requires the adoption of the recommended strategies, aiming a leading model rather than survival. Key to that is to strengthen the partnership between government, industry, universities and communities. To survive or to lead for Hong Kong in the strategic future of high-rise ZCB is not a policy decision per se, but a socio-technical debate provoking an institutional paradigm shift.

Keywords: zero carbon building, energy policy, carbon emission, carbon policy

1. INTRODUCTION

During the past decade 'zero carbon' or 'zero energy' building policies have been formulated in a number of countries. In Hong Kong, despite the over 20 years of evolution of building energy codes, there is still no policy agenda of achieving possible zero carbon for buildings. In addition, research on ZCB policy and its associated opportunities and risks in Hong Kong has been limited. In 2011 the Council for Sustainable Development in Hong Kong launched a public engagement process on energy saving and carbon emission reduction in buildings, and provided recommendations of 'systemic enhancement' and 'facilitation of behaviour change' to help engage the community, but did not explore the opportunities and risks of possible strategic movement towards zero carbon. As observed by Crawley et al., a common language in defining and measuring ZCBs is lacking, which contributes to significant ambiguity when setting targets and procedures to achieve carbon reduction.

This paper aims to develop policy scenarios of zero carbon building (ZCB) for the high-rise context of Hong Kong. A definition of ZCB for Hong Kong is developed and so is a socio-technical systems ZCB policy framework. **Policy scenarios are developed for different building types and sectors from the status quo towards the UN's 2050 carbon neutrality target.** The opportunities and risks associated with the formulation and implementation of this ZCB policy are identified, including their relevant technical, regulatory, social and geographical aspects. These provide evidence of the potential benefits **of this policy to inform the HKSAR Government's policy decisions.** Recommendations are developed to realise the opportunities and mitigate the risks identified.

2. RESEARCH METHODOLOGY

The research was conducted through the integration of a questionnaire survey, follow-up interviews, series of focus group meetings, and a policy forum, engaging professionals and stakeholders in Hong Kong over a 15-month period.

The questionnaire survey approached over 1000 informed professionals and stakeholders in Hong Kong industry and society. In total 260 questionnaires were returned, of which 235 were properly completed, thus yielding an overall response rate of 235 for analysis. Followed by the questionnaire results, semi-structured interviews, four focus group meetings and one discussion forum were conducted to further explore and verify the results. Table 1 illustrates the number of participants involved in each research activities. The participants cover all eight stakeholder groups including developers, clients and investors, estate and facilities managers, contractors, professional advisors, manufacturers and suppliers, government and its departments and agencies, financiers, bankers and mortgage lenders, and universities and professional bodies.

Items	Questionnaire survey	Follow-up Interviews	Four Focus group meeting	Discussion forum
Number of participants	235	30	105	248

Table 1: Study components and number of participants

3. RESULTS AND ANALYSIS

The proposed ZCB policy for Hong Kong has drawn on the socio-technical systems policy framework of our previous research, which highlights a ZCB policy as a complex socio-technical system. The technical system of a ZCB policy consists of four components: definition and scope, targets and timelines, measures and indicators, reliance on renewable energy. This technical system should be embedded into the regulatory, social and geographical contexts. Stakeholder engagement is an important mechanism for formulating and implementing the policy. The four components of the technical system of the ZCB policy, in addition to the regulatory, social and geographical contexts and the mechanism of stakeholder engagement, form the core of the proposed ZCB policy for Hong Kong.

3.1 Policy scenarios of Zero Carbon Building for Hong Kong

3.1.1 ZCB definition and scope

The ZCB definition developed for Hong Kong regards ZCBs as complex socio-technical systems, and recognises the multidimensional boundaries of the ZCB systems and the wide-ranging stakeholder group engagement. The generic definition of a ZCB (or a LCB) is a building within its defined systems boundaries with net-zero (or very low) carbon emissions on an annual basis during the operational stage of the building. The systems boundaries should be defined in terms of the technical components of the definition within the relevant regulatory, geographical and social contexts (for a detailed explanation see [5]).

3.1.2 ZCB policy target and timeline

Different ZCB policy targets and timelines were proposed for different building types and sectors in Hong Kong, using the policy targets and priorities adopted in the UK as a point of reference. Considering three variables, namely, building type, sector and status, eight combinations of policy targets were considered in eight typologies, and preliminary timelines for these targets were also proposed (Figure 1). Their feasibility was examined through the stakeholder questionnaire survey and interviews.

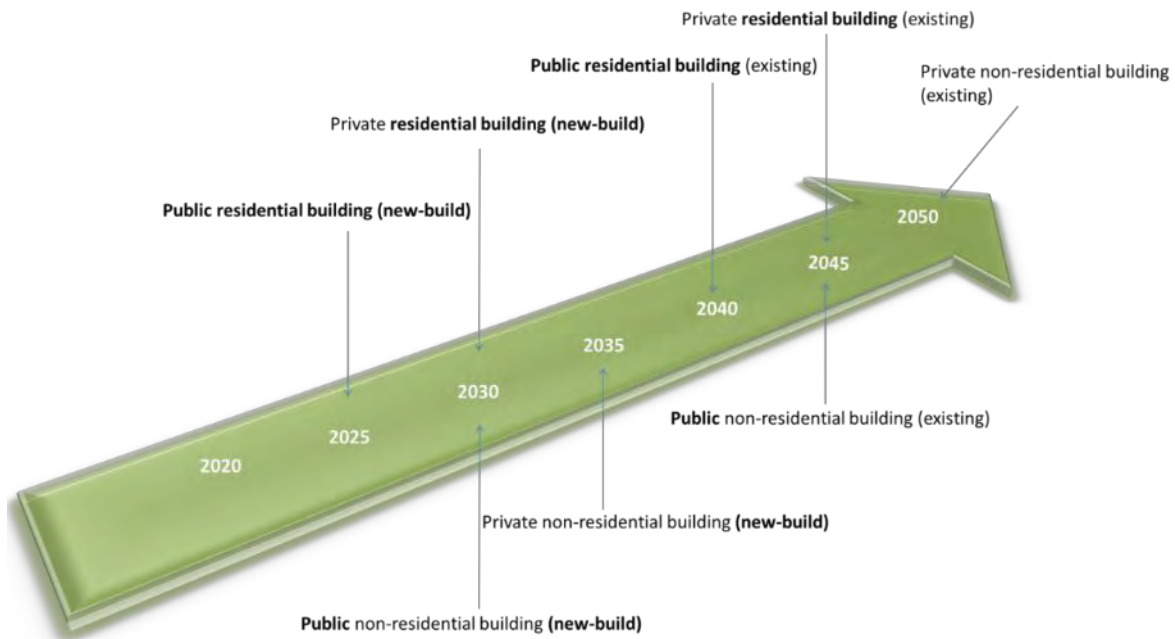

Figure 1: Possible ZCB policy targets and timelines for study

All buildings in Hong Kong were proposed to achieve net zero carbon as defined above by 2050. To enable a progressive approach, all newly built public residential buildings were prioritised to achieve net zero carbon from 2025. The other policy targets were proposed to follow up, with a five-year period of catching up, and with existing private non-residential buildings as the last target by 2050.

3.1.3 Measures and indicators

Performance measurement is important to ensure the effective implementation of the proposed policy. Use of kgCO₂e/m²/year was suggested as a measure of carbon emission intensity (CEI) and kWh/m²/year to measure energy use intensity (EUI), as these are common measures both worldwide and in Hong Kong. For consistency, the gross floor area (GFA) of a building was proposed for calculating the EUI and CEI, denoting the area contained within the outer surface of the external walls and measured at each floor level, with any portion of this area not floored over also included. Both regulated and unregulated operation energy should be counted.

3.1.4 Use of renewable energy

The energy supply is a major contributor to carbon emissions in Hong Kong, with 53% of the fuel mix from coal, 23% from nuclear energy, 22% from natural gas and remaining 2% from others. The increased adoption of renewable energy is crucial to reduce reliance on fossil fuels and reduce carbon emissions. Hong Kong has abundant sunshine, and solar energy has the greatest potential for use, such as solar thermal systems for water heating or refrigeration and PV systems for electricity generation. Wind power has been proposed as an alternative, but its low efficiency and effect on the natural environment have generated substantial debate about its applicability in Hong Kong. Energy from municipal solid wastes (MSW), particularly the organic fraction, has also been emphasised as a valuable source of electricity. The HKSAR Government has proposed targets to reduce carbon intensity by 50–60% of the 2005 level by 2020, and to utilise renewable energy at about 3–4% of the fuel mix in ways of two wind farms and integrated water management facility.

Given the limited use of renewable energy in Hong Kong, it was proposed that the required renewable energy for a ZCB may be generated on- or off-site and directly connected with the building and/or off-site and indirectly connected with the building.

3.2 Perceptions of the ZCB definition and policy scenarios

Overall, most participants recognised that Hong Kong should initiate a ZCB policy, or at least set relevant energy-reduction targets to facilitate the sustainable development of the city. The majority of questionnaire respondents agreed or strongly agreed that Hong Kong lacks a strategic policy leading to zero carbon emissions, that Hong

Kong needs to develop such a policy and that this is a global trend (71%); and that a ZCB policy is important for Hong Kong (80%). However, opposed views still exist. These attitudes were explained through the follow-up interviews and focus group meetings by a perception that the existing building energy policies and ordinances were capable of reducing building energy use and carbon emissions; and a perception that achieving zero carbon in Hong Kong lacked feasibility due to the high-rise, high-density nature of its buildings. Some also argued that many steps are required before achieving zero carbon emissions and thus a low-carbon or low-energy building policy may be more practicable.

During the survey, focus group meeting and discussion forum, there was a consensus on the proposed measures and indicators, but much division and discussion of other parts of the technical system of the policy, including definition and scope, timelines and targets, and renewable energy.

Over two thirds (67%) of the questionnaire respondents agreed or strongly agreed with the proposed definition, while others held a neutral or disagree attitude. Possible reasons were identified through the follow-up interviews and focus group meetings as uncertainty about a true definition; lack of clarity about the definition of system boundaries in the definition; whether embodied energy should be considered; and different ZCB considerations for different types of building.

There was a division of views on the timeline and target, most respondents (61%) agreed that public buildings should be prioritised over private ones, but more than half (52%) disagreed with prioritising residential over non-residential buildings. Interviewees and focus group participants explained that although many other countries or cities prioritises residential buildings over non-residential, this may be unsuitable for Hong Kong due to the high-rise, high-density characteristics of residential buildings. In addition, the user behaviour factor of residential occupants (generally perceived as reluctant to change) may make it more difficult to achieve zero carbon in residential buildings in Hong Kong. In the follow-up interviews, most agreed that policy targets and timelines should set the same pace as the international approach, but that it was unlikely the target would be achieved by the proposed time. This perceived low possibility of the target fulfilment was attributed mainly to the high-rise, high-density building, difficulties with renewable energy, political uncertainty, and lack of industry and public willingness for zero carbon in Hong Kong.

While renewable energy is one of the most important strategies for achieving ZCB, the feasibility of applying many technologies in Hong Kong has long been doubted. The achievability of renewable energy like solar energy, combined cooling, heat and power (CCHP) plant was considered high from the questionnaire survey, but doubted during follow-up interviews and focus group meeting. One participant suggested that the results of questionnaire survey may not be useful as the general public lack technological knowledge, and it would reflect their misunderstanding of the use of some forms of renewable energy, the associated power generation and the potential benefits and risks.

Not surprisingly, most questionnaire respondents (65%) agreed that implementing the possible ZCB policy in Hong Kong would be difficult. Through follow-up interviews and focus groups, possible reasons that emerged were that the difficulty lies in industry not trying because the policy is not compulsory. The questionnaire survey results also demonstrate the view that the willingness of both industry and the public to support the ZCB policy is neutral or even weak, and that to gain such support the government should take the lead with more incentives.

3.3 Opportunities, risks and recommendations

The importance of possible opportunities to formulate and implement the proposed ZCB policy, as well as the potential risks, was examined in the technical, regulatory, social and geographical aspects. Raising public awareness of sustainable living was considered the most important opportunity, followed by promoting strategic urban planning for long-term city development, and cutting building energy consumption. The major hurdles were identified in the geographic and technical aspects, particularly the geographical difficulties for domestic renewable energy generation, heavy reliance on fossil fuels, and resistance of practitioners to support the policy due to uncertain benefits. To realise the opportunities and mitigate the risks, the important recommendations were recognized as the encouragement of energy and carbon reduction through urban planning, the demonstration of life cycle economies and cost benefits of ZCB, and including zero carbon/energy targets in public project procurement.

4. DISCUSSION

Drawing on a critical literature review and desk study of ZCB policies, initiatives, demonstrations and the like worldwide and the evolution of policies on building energy and carbon emissions in Hong Kong, a potential ZCB policy for Hong Kong was proposed. This proposed policy adopts the socio-technical systems framework which regards ZCB policies as complex socio-technical systems as presented by Pan and Ning [4]. The technical system of the proposed ZCB policy consists of four components and embedded in the relevant regulatory, social and geographical context of Hong Kong. Critical to the context is the high-rise, high-density, hot-and-humid urban environment of Hong Kong. Policy scenarios are developed for different building types and sectors, supported by a technology roadmap in a progressive manner towards net zero carbon. Stakeholder engagement is an effective mechanism for the formulation and implementation of a ZCB policy.

However, despite recognising the importance of such a ZCB policy for Hong Kong, the majority of the participants perceived limitations to the proposed policy centred on whether the policy targets can be achieved in the proposed timeline, whether zero carbon can ever be achieved for high-rise buildings in Hong Kong, and whether substantial renewable energy can be developed. Debates within the policy scenarios are illustrated in Figure 2, and the future direction could be manifold.

Although a ZCB definition for Hong Kong was proposed, concerns were raised over specific details and the applicability of this definition to different contexts. Taking energy scope as an example, some participants believed **embodied energy should be included for 'true' ZCB, others disagreed over whether the energy scope should follow the EMSD scope or include others.** These findings echo the differing definitions of ZCB and the like in other countries and regions. For practicality, the proposed definition should have explicit boundaries, particularly in **relation to Hong Kong's context, building types and user behaviour.**

Regarding the proposed policy targets and timelines, the participants appeared pessimistic and suggesting the timeline was too aggressive. In addition, the lack of a detailed blueprint contributes to policy and business uncertainty. Most participants believed that non-residential buildings could achieve net zero carbon more easily than residential buildings. This finding is in disagreement with the policy priorities for residential buildings in the UK, US, and EU. However, residential buildings in those countries tend to be low-rise and easy to measure, and energy consumption in residential buildings depends on user behaviour while for commercial buildings it is more dependent on energy systems.

Focus group meetings raised a wide range of recommendations regarding renewable energy. Some suggested solar power should be the main focus and it is the most developed energy technology, while others argued that critical learning is needed and that heavy reliance on solar power may not be appropriate for **Hong Kong's high density** with tens of thousands of high-rise buildings. Some suggested the use of power generation from waste, but shared uncertainties due to the current underdeveloped technologies and client preferences.

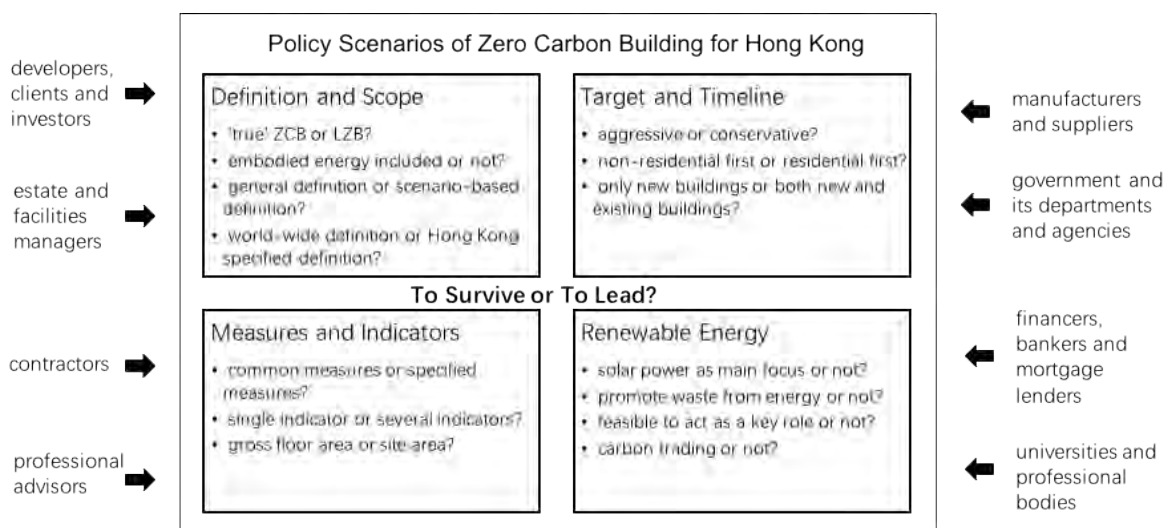

Figure 2: Debate on details of policy scenarios of ZCB for Hong Kong

5. CONCLUSIONS

This paper develops policy scenarios of ZCB for the high-rise context of Hong Kong. A definition of ZCB for Hong Kong is developed and so is a socio-technical systems ZCB policy framework, elaborating four technical components, i.e. definition and scope, measure and indicator, target and timeline, and renewable energy, within their social, regulatory and geographical contexts. Policy scenarios are developed for different building types and sectors from the **status quo towards the UN's 2050 carbon neutrality target. Important opportunities are identified** for addressing climate change as well as re-shaping energy and infrastructure planning in Hong Kong, whilst significant risks are also discovered with technological constraints and reluctant behavioural changes. The opportunities are found to outperform the risks. To realise the policy scenarios requires the adoption of recommended strategies, aiming a leading model rather than survival. Key to that is to strengthen the partnership between government, industry, universities and communities. To survive or to lead for Hong Kong in the strategic future of high-rise ZCB is not a policy decision per se, but a socio-technical debate provoking an institutional paradigm shift.

ACKNOWLEDGEMENTS

This research project (Project Number: 2014.A8.020.14E) is funded by the Public Policy Research Funding Scheme from the Central Policy Unit of the Hong Kong Special Administrative Region Government.

REFERENCES

- [1] Report on the public engagement process on “Combating climate change: energy saving and carbon emission reduction in buildings” , Hong Kong:Council for Sustainable Development (SDC) [online], Retrieved from: <http://www.enb.gov.hk/en/susdev/council/> [Retrieved on 5 May 2016]
- [2] Law W.W.Y., Chow W.C., Leung T.H.D., Yiu S.I.S., Yan W.L., Lo Y.H. and Yeung H.Y.D. 2012. “Final Report: Combating Climate Change: Energy Saving and Carbon Emission Reduction in Buildings,” Consultancy Report commissioned by Environment Bureau, HKSAR Gov.
- [3] Crawley, D., Pless, S. and Torcellini, P., 2009. Getting to Net Zero. ASHRAE Journal.
- [4] Pan, W. and Ning, Y., 2015. The dialectics of sustainable building. Habitat International, 48, 55-64.
- [5] Pan, W. ,2014. System boundaries of zero carbon building. Renewable and Sustainable Energy Reviews,37,424-434.
- [6] Walker R.M. and Hills P., 2012. Partnership Characteristics, Network Behavior, and Publicness: Evidence on the Performance of Sustainable Development Projects. International Public Management Journal, 15(4),479-499.
- [7] Hong Kong Energy End-user Data 2015, Hong Kong: Electrical and Mechanical Services Department [online], Retrieved from: http://www.emsd.gov.hk/filemanager/en/content_762/HKEEUD2015.pdf [Retrieved on 8 January 2016]
- [8] Energy Saving Plan for Hong Kong's Built Environment 2015~2025+, Hong Kong: Environment Bureau [online], Retrieved from: <http://www.enb.gov.hk/sites/default/files/pdf/EnergySavingPlanEn.pdf> [Retrieved on 5 May 2016]
- [9] Marszal, A. J., Heiselberg, P., Bourrelle, J. S., Musall, E., Voss, K., Sartori, I., & Napolitano, A., 2011. Zero-energy building – A review of definitions and calculation methodologies. Energy and Buildings, 43(4), 971–979.
- [10] Sartori, I., Napolitano, A., & Voss, K., 2012. Net zero-energy buildings: A consistent definition framework. Energy and Buildings, 48, 220–232.
- [11] Zhao, X., Pan, W. and Lu, W. ,2016. Business model innovation for delivering zero carbon buildings. Sustainable Cities and Society.
- [12] Code for sustainable homes: A step-change in sustainable homebuilding practice, London, UK: Department for Communities and Local Government [online], Retrieved from: <http://webarchive.nationalarchives.gov.uk/20120919132719/www.communities.gov.uk/documents/planningandbuilding/pdf/codesustainhomesstandard.pdf> [Retrieved on 15 September 2015]
- [13] 2011 integrated energy policy report, California Energy Commission [online], Retrieved from: http://www.energy.ca.gov/2011_energy/policy/. [Retrieved on 8 January 2016]
- [14] EISA.2007. Energy Independence and Security Act.

- [15] European Commission., 2010. Directive 2010/31/EU of the European parliament and of the council of 19 May 2010. Official Journal of the European Union, 53, 13–34.

A Discussion on the Benefits of Environment Performance of the Promotion of Kaohsiung Green Building Specialties Policy

CHAO Chien-chiao^a, CHOU Po-cheng^b, SU Chih-hsun^c, HUANG Chih-ming^d, TSENG Pin-chieh^e, KUO Yi-chun^f

^a Maintenance Office of Public Works Bureau, Kaohsiung City Government, Taiwan, kuo597@gmail.com

^b Shu Te University, Taiwan, paul@stu.edu.tw

^c Maintenance Office of Public Works Bureau, Kaohsiung City Government, Taiwan, s610@ms3.hinet.net

^d Maintenance Office of Public Works Bureau, Kaohsiung City Government, Taiwan, Kuo597@gmail.com

^e Kaohsiung City Government, Taiwan, Kuo597@gmail.com

^f Shu Te University, Taiwan, Kuo597@gmail.com

ABSTRACT

"Urban Heat Island" effect leads to high temperature in the urban climate, increased rainfall, reduced wind speed and air pollution as well as other effects. According to "International Association for the Evaluation of Educational Achievement," average carbon dioxide emission in Taiwan is 11.26 tons in 2008, while the building structures are the third source of carbon dioxide emissions. Taiwan is ranked to have the 18th highest carbon dioxide emissions in the world. In view of this, for the new buildings, the Kaohsiung City Government actively promotes the **transformation plan for "Green Building • Sustainable Environment"**, presenting the local culture, green architecture and the concept of public participation, and promotes Taiwan's first "green building autonomous regulations in Kaohsiung", "the policy for design and encouragement reward for Kaohsiung building" and other innovative design policies. **Kaohsiung implements existing buildings through "Improvement on Kaohsiung Buildings" action**, prioritizing public buildings that are frequented by the people of Kaohsiung. Buildings will be elevated with the suitable solution based on integrated physical environment quality testing and data analysis (including sound, light, warmth, air).

Therefore, this study used the analysis of relevant policies of Kaohsiung city prompted by innovative green building. With the "Building (New) Sustainable Environment" of Kaohsiung City Government, **practical benefits and the target completion of the policies will be discussed**. From the point of view of environmental health diagnostic, existing buildings are examined for their achievement in actual practice. The aim of this study is to provide hope to enhance the quality of life in Kaohsiung, and to add to Taiwan's research reference.

Keywords: Kaohsiung buildings, green buildings, innovative design policy

1. INTRODUCTION

In 2015, Paris Climate Conference (COP21) performed protocols regarding the topic of restraining the global warming, which was aimed at reducing the emission of greenhouse gases and controlling the global temperature would not increase more two centigrade degree in 2100 with the global warming speed. The conference also advocated the concepts of think locally, act globally. To respond the changes of global climate and the trend of international energy conservation and carbon reduction, the central government promotes the policies of "Sponge City" and "Million Solar Roofs". **Faced at the problems of high carbon emission, alternations of floods and droughts**, the air pollution of PM 2.5 caused by urban island effect and difficult to diffuse, more than 120,000.00 unauthorized buildings and Aging Population with too Few Children and other problems, Kaohsiung City is in need of thinking about how to transform into the healthy and sustainable Southern Taiwan metropolitan district from the image of industrial city to develop the local architectural features and living cultures of Kaohsiung region.

2. TO PROMOTE STRATEGIES AND CREATIVE ACHIEVEMENTS

In order to solve the environmental studies of Kaohsiung and effectively plan and make reformation on sustainable construction environment of Kaohsiung, the countermeasures, **"Kaohsiung House Plan" is created**. To more properly adapt to the sustainable construction movement, the three cores of the plan are consist of global Environmental Sustainability, the Identity of Reflecting the Local in line with the local conditions of Kaohsiung, and **Healthy Residence closed to the populaces' life, which conclude the following creative achievements:**

2.3 Twelve creative policy tools

Kaohsiung House Plan has constantly made twelve policy tools initiatively nationwide, and conducts the reformations on sustainable construction environment by away with a higher standard.

2.4 Vertical forests: roof greening and landscape balcony

The landscape balcony with the depth of three meter is initially built in line with the local conditions to create green landscape in metropolis, which seems as a 3-D vertical forest park, creating the unique architectural features and brand, and promoting the construction to the international construction with high quality.

2.5 The universalization of design space

The elderly population in Taiwan will reach to more than 20% in 2025. In response to the upcoming super-aged society, the universal design is further introduced by the laws so that the children, the elderly and disabled person, etc., can conveniently use all sorts of building environments.

2.6 The solar photovoltaic facilities set on buildings

By making full use of Kaohsiung's abundant sunshine to facilitate the renewable energy of solar photovoltaic to develop local characteristics, and to standardize the setting of the solar photovoltaic facilities in the roofs of buildings, the regulations of central government's laws and decrees are broken, and the restrictions on the height of the solar photovoltaic on the roofs are broaden so that those with the height fewer than 4.4 meters are excluded from the volume and height of the building.

2.7 The self-creation of financial resources-the sustainable operating fund of green buildings

The financial resource is self-created by handing in the giving back money of Kaohsiung adjacent. Apart from **giving back to sustainable environmental construction, the operation of the innovation policy's mechanism can also** be constantly rolled. The operating fund of sustainable green construction of this city is co-managed by experts of industry, government and science.

3. RELEVANT OUTCOMES

3.1 Motivate cities to study from typical example

"Kaohsiung house plan" has motivated more than 10 other cities in Taiwan to learn all sorts of innovation policies of Kaohsiung City, which has become the typical example of green and sustainable city and become the dialogue basis for diplomacies between international cities.



Figure 1: Vertical forests –landscape balcony and transformation of unauthorized buildings - green energy facilities

3.2 Rainwater storage facilities

The disaster prevention of small flood detention: when the rainwater storage amount has reached to 223,920 cubic meters, equivalent to capacity of 119 swimming pools with international standard, then the delay time of the flood **peak's arriving is set at about 30 minutes to reduce the disaster of heavy rain's impact.**

The rainwater tank: the processed amount of recycled rainwater has reached to 2,761,365.24 liters/ day, which means 1,007,898 tons of water is saved per year, and 156,224 kg of carbon is reduced per year.

3.3 The set amount of solar photovoltaic

The set amount of solar photovoltaic in newly-built construction has reached to 54,446 KWP, equivalent to the amount the set amount of solar photovoltaic of 53 Kaohsiung World Games Main Stadium. It can create 700 million degrees of electricity consumption in one year, and the carbon reduction can reach to 430 million kg/ year.

3.4 The of lighting and energy saving

To standardize 97% of existing buildings in the city, the high-energy lamps and interior decorations shall not be used when applying for interior decoration for the buildings and changing the use of buildings. So far the energy-saving lamps applied in the case have reached to 2,861,768 watts, which can reduce the electricity consumption of 2,862/ hour. Calculated by using 16 hours one day, then, the reduced electricity consumption is 16,714,080 kWh/ year, and the reduced carbon amount is 10,228,188 kg / year.

3.5 The creation of universal space suit for All-Age

The universal design of the bathroom: the moving lines of the passageways are smooth and the net width of the door should reach 80 cm so that wheelchair users can be in and out smoothly and steadily, and the area has reached 12,406 square meters.

The universal design of social hall: Extending the traditional construct concept of "courtyard" space to create spaces of social hall for all-ages in the community, of which the area has reached 1,369 square meters.

3.6 To create the business opportunity for green building industry

By supporting green energy industry, increasing more than 2,500 job opportunities per year and newly- increasing 500 high-standard green buildings in four years to motivate the green business opportunity with about more than 700 billion of total industries, and to improve the job opportunity and wishes of returning the hometown to provide services for the people of Kaohsiung.

3.7 Verticals forest

The green area on the roof is 160,921 square meters.

The area of landscape balcony is 70,360 square meters, of which Green area 23,453 square meters. The balcony landscape with the depth of 3 meters, breaking the laws and decrees, is combined with more than 1/3 shrubs and arbors to afforest. By adjusting the micro environment, and creating a healthy rest space to promote the plane surface greening to become the vertical forest. By replacing the former frozen cement and iron sheet to transform the image of industrial city into Kaohsiung garden city.

The total green area has reached 184,374 square meters, equivalent to the areas of about 28 football fields, and the reduced carbon is 3,687,480 kg.



Figure 2: The landscape balcony that can be used for sun shading and rest

3.8 The total amount of reduced carbon

The execution of the "Kaohsiung house plan," can reduced the annual carbon amount of 13,500 tons, equivalent to the carbon amount stored by 13.5 ten thousand arbours. So far the total reduced carbon amount has reached to 47,250 tons, equivalent to carbon amount stored by 4,725 ten thousand arbours.

3.9 Cross-border action and social participation

"Kaohsiung house plan" is a cross-domain construction action studied and participated by citizens and experts from industry, government and science. Now 100 green building awarding brands of Kaohsiung houses has been awarded certificates, 100 outstanding creative design works of Kaohsiung houses has been selected, 45 ACCD of Kaohsiung house has been cultivated, and more than 12,000 people have participated in the relevant activities. The plan emphasizes the public participation and empowerment of community, and is driven by the units of metropolis, economy, education, agriculture and marine division dividedly. Having launched the responses of 348 schools, and 95 agricultural and fishery facilities, the plan has got 144 buildings of construction license of Kaohsiung house, a total of 11,950 households.

4. THE FUTURE KAOHSIUNG GREEN BUILDING 3.0 VERSION DEVELOPMENT ASPECT

4.1 Orange construction planning

The most important element of orange technology is H2O, which stands for health, happiness and offering. Its correlative calculation is orange computing models are health model, happiness model and offering model. The details are as follow:

- Health Technology: senior medical care and old timers living technology are becoming increasingly important. Medical prevention of illness has become a crucial issue. To advance and develop senior living quality and green-orange health care is the challenging issue.
- Happiness Technology: in order to promote happiness indicator, engineering technology and social science and humanity can be used to advance public safety, anti-stress, pleasure, social relationship, education, energy, financial wellbeing.
- Offering Technology: other than establishing personal health and happiness, orange technology also promotes happiness in others. Offering technology uses technological innovation to better interpersonal relationship.

4.2 Intelligence: disaster prevention

Cloud technology can provide designers to directly on Web-GIS cloud system to design site development, install and control various water tanks in order to set and measure the precipitation.

4.3 Life box

Newly built residential households have to install a family emergency shelter. It is about 1.6~3.4 m² (determined by the surface area of the house). The door is made of steel board, and the four walls, ceiling and floor are made

of concrete with steel foundation that are thickened to 200-300mm (determined by the height of the house). The inside has one or two vents and has electricity, internet and radio.

5. SUSTAINABLE DEVELOPMENT AND CONCLUSION

The city plan shown by Kaohsiung sustainable construction on its local culture, sustainable nature and friendly environment is: under the pluralistic development of the overall Kaohsiung city, not forgetting the traditional geographic landscape, architectural features and ethnic culture to show respects to different ethnics, cultures and regional characteristics by Kaohsiung house plan.



Figure 3: The field surveys on Kaohsiung house

Kaohsiung house case is integrated by project management, from which benefits of Kaohsiung house is studied and analysed. Inviting and getting the scholars and experts from industry and government to jointly study, analyse and discuss the case to formulate the basic standard of **the sophisticated direction for Kaohsiung house plan's policy tools. Establishing the database of Kaohsiung house's newly-built cases** to track application case progress of Kaohsiung houses which have got the licenses for the construction, and to build the databases of photos, decrees, construction methods, cost analysis on the basis of the weekly field surveys. Meanwhile the wind environment, ambient heat, light environment or user satisfaction will be studied and analysed by simulation software and questionnaires, and the benefits of industry, the economy and reduced carbon will be quantified.

To promote the sustainable environmental feedback mechanism, the financial resource should be self-created by paying agent money, fees for regulations and giving back money, besides which shall be executed by the **management mechanism of sustainable green construction's operating funds. Apart from the direct giving back to sustainable environmental construction, the operation of the innovation policies' mechanism** should be constantly scrolled.

ACKNOWLEDGMENTS

Full gratitude paid toward Public Works Bureau of Kaohsiung City Government for its support in this research.

REFERENCES

- [1] Chiang, C.M.; Kuo, Y.C.; Chou, P.C., 2011, A Study on Response to Global Climate Change the Community Environment of Taiwan in the Construction of Evaluation System, *Journal of Applied Mechanics and Material*, EI, Vols. 71-78, Pages 3237-3241.
- [2] David Walker, Nathan Forsythe, Geoff Parkin, John Gowing, 2016, Filling the observational void: Scientific value and quantitative validation of hydro meteorological data from a community-based monitoring, *Journal of Hydrology*, EI, Volume 538, Pages 667-676.
- [3] Chou, P.C.*; Lee, C.Y.; Chang, K.F and Chiang, C.M., 2008, An Evaluation Index for Assessing the Indoor Environment of Sustainable Buildings in Taiwan, *Indoor and Built Environment*.
- [4] Chang, K.F. & Chou, P.C.*, 2010, Measuring the Influence of the Greening Design of the Building Environment on the Urban Real Estate Market in Taiwan, *"Building and Environment"* , EI, 45(10): 2057-2067.

Session 3.4: Policies for High-Performance Green Buildings (2)

Baseline and Water Efficiency for Green Building in Taiwan

CHENG Cheng-li^a, HO Ming-chin^b, LIAO Wan-ju^c, CHERN Szu-jen^d

^a National Taiwan University of Science and Technology, Taiwan, ccl@mail.ntust.edu.tw

^b Department of Architecture, China University of Technology, Taiwan, 2010hmc@gmail.com

^c Department of Interior Design, China University of Technology, Taiwan, annie5064@gmail.com

^d National Taiwan University of Science and Technology, Taiwan, jenny0250@hotmail.com

ABSTRACT

More than a thousand buildings have been certified as green buildings using this evaluation system since 1999 when the green building evaluation system of Taiwan was first applied. It provides policy makers as a form of positive feedback from the quantitative effects of water conservation efforts. The present study offers a calculation process for estimating the quantitative volume of water saved by practical green buildings. The baseline water usage for all kinds of buildings was determined to serve as the criterion for determining the water saving efficiency of individual buildings. An investigation of the average water saving rate from 2000-2013 for 1,320 buildings certified as green buildings was conducted to validate the estimation results. This research used 568 cases of green buildings which involved the rainwater harvesting system design and operation to be the validation as well. The evaluation result shows average 48% water saving rate in these cases involved rainwater harvesting system. Water savings will inevitably follow from the use of water-saving appliances or water-saving designs for buildings. The investigation on the difference between the actual water consumption of the building awarded with green building certification and the general building had been verified. Through the field survey, the water efficiency from rain water harvesting operation was evaluated and confirmed. It is proved the significant contribution to water efficiency from adoption of saving water design and rainwater reuse system in green buildings.

Keywords: design process, green rating tool, high-performance building

1. INTRODUCTION

The green building evaluation system used in Taiwan was first applied in 1999 and initially utilized a building's water efficiency as the threshold index for determining the building's environmental impact. More than a thousand buildings have been certified as green buildings using this evaluation system since then. It provides policy makers as a form of positive feedback from the quantitative effects of water conservation efforts. Theoretically, water-saving designs and the adoption of water-saving facilities should benefit buildings in terms of their water usage efficiency. However, actual real-world water usage is complex, being affected by a wide range of human behaviors and other factors. Regarding the issue of the effective use of water resources, the actual water consumption of a building with a green building certification should be different from those of buildings without water-saving designs. Relatedly, the question of whether substantial water-saving effects are achieved by such designs, as well as questions regarding their energy-saving and carbon-reduction benefits, are widely discussed. Therefore, it is requested with various investigations had to be undertaken to answer them.

To date, however, there are still no solid means of verifying or providing clear evidence to determine the quantitative effects of various water conservation strategies. A model for estimating water-saving benefits in order to clarify the effective use of water resources was established in previous research. To that end, an empirical investigation of buildings with green building certification was conducted to verify the values estimated by the model after statistical analysis. More specifically, quantified values of reasonable water-saving benefits for Taiwan for every year were derived to examine the effects of water conservation and to validate the proposed model. In this study the actual cases awarded by green building certification since 2000 to 2013 are taken as the research subjects [9]. This study would focus on the water conservation measures for green buildings in Taiwan with the aim of providing a quantitative procedure for proving water-saving efficiency.

2. WATER INDEXES AND EVALUATION

The water conservation index is a ranking system for the adoption of water-conserving items, including water closets, urinals, faucets and baths, and for the reuse of rainwater and grey water. As a practical process of the **assessment of the water index of a green building's water resource indicator system WI value, the applied building** should submit the proof documents about the saving water design items; then, the referee committee would confirm and determine the final rating value of the WI index. This rating system focuses on the saving water design and the adoption of water efficiency facilities for green buildings. The evaluation consideration engages the design and facility, not including usage patterns or behavior styles. Therefore, the rating value of saving water is a conceptual assessment for the water efficiency parameter without real water saving volume.

To more precisely estimate the quantity of water actually consumed by a given green building, the factor of operating time was added to the building categories when estimating the baseline for the quantity of water consumed. After the water consumption per unit of the floor area of a building with green building certification was acquired, this study used statistical quantitative methods and an empirical investigation for comparison and analysis, determining the **actual gross water consumption as a basis for estimating the quantity of a building's** annual water conservation. Accordingly, the baseline for annual water consumption for each category of building W_{ty} ($m^3/year$) was established, and the formula for the estimated quantity of annual water conservation W_{st} ($m^3/year$) is provided as Equations 1–4.

$$W_{ty} = A_f \times WUI$$

Equation 1

$$W_{st} = W_{ty} \times (WI \div 9)$$

Equation 2

$$R_{sw} = W_{st} \div W_{ty} \times 100\%$$

Equation 3

$$R_{rs} = W_{rs} \div W_{ty} \times 100\%$$

Equation 4

W_{ty} : Annual water consumption for each category of building ($m^3/year$).

A_f : The floor area of a building (m^2).

WUI : Water consumption density per unit area of a building ($m^3/m^2 \cdot year$).

WI : **Water index of a green building's water resource indicator system** ($0.0 \leq WI \leq 9.0$).

W_{st} : Annual water saving of building ($m^3/year$).

W_{ty} : Annual water consumption of each category of building ($m^3/year$).

R_{sw} : Annual water saving rate of building (%).

R_{rs} : Annual rainwater substitution rate of building (%).

The score for the water resource indicator system for a green **building's rating assessment system, WI, is the key** parameter for estimation. This study used the real cases with green building certification, and each case has a certified rating value of the WI index. The average values of the water resource indicator rating scores for 2007–2013 (WI) were, for the most part, normally distributed between 3.0 and 5.0. According to the survey green building certificated cases, the annual water saving rate R_{sw} and rainwater substitution rate R_{rs} would be estimated.

3. BUILDING CATEGORY AND WATER USAGE BASELINE

The water demand and the actual water consumption of buildings are actually quite complex, not only because of the difference in building types, but also because even among buildings of the same type, individual buildings may **differ substantially due to factors, such as building age, occupancy, density, etc.** Moreover, a building's usage and demand patterns will change after the actual construction is completed. All of these factors cause considerable difficulty in accurately estimating water consumption. Therefore, in order to more accurately estimate the actual consumption of green buildings to serve as the basis for assessing water-saving efficiency, the operating time factor was added to the factor of building types as one of the water consumption estimation criteria [10]. Herein, the water unit intensity (WUI) formula is defined by the parameters of occupancy density, yearly water usage and occupancy rate, shown as Equations (5)–(8).

$$WUI = P_{di} \times Q_{wi} \times F_{ri}$$

Equation 5

$$P_{di} = \prod_{i=1}^{12} P_{di} ; 0.03 \leq P_{di} \leq 1.2$$

Equation 6

$$Q_{wi} = \prod_{i=1}^8 Q_{wi} ; 1 \leq Q_{wi} \leq 130$$

Equation 7

$$F_{ri} = \prod_{i=1}^5 F_{ri} ; 0.4 \leq F_{ri} \leq 0.8$$

Equation 8

WUI: Water consumption density per unit area of the building (m³/m²·year).

P_{di}: Person density (person/m²).

Q_{wi}: Yearly water usage (m³/person/year).

F_{ri}: Occupancy rate (%).

This study proposes WUI as the definition of building water usage density and to serve as the baseline of building water usage to evaluate the water efficiency of building water consumption. Due to the various categories of buildings, this study, in accordance with existing literature and relevant research and investigations, divided the **buildings according to 52 different types of water utilization based on the building's utilization time characteristics** in order to estimate the baseline for water consumption more precisely. After estimating the parameter levels for the standardized building water consumption and water consumption parameters, the baseline for each type of water consumption was estimated.

Overall, other than accommodation or medical buildings, which involve everyday-life water demands, the per-capita water demand per unit of buildings in general is mainly determined by the use of toilets and for cleaning activities. The water demands of accommodation buildings, on the other hand, include the water needed for cleaning and bathing, toilet flushing, cooking and other purposes. Based on the unity and efficiency principle of the estimation formula and for the sake of consistency in our assessments, water consumption was translated into average per-capita water consumption per unit for all building types. **A building's total water consumption is mainly influenced** by the two factors of per-capita consumption per unit and user density, and basically, these two factors are independent variables. With regard to the building category, spatial contrasts were computed by referring to 52 types of space according to building categories A–I under the building code of Taiwan.

4. INVESTIGATION AND VALIDATION

In this study the actual cases awarded by green building certification since 2000 to 2013 are taken as the research subjects with totally 1224 cases, the rainwater harvesting system is the focus of this research. Through the field survey, the water efficiency from rain water harvesting operation of 568 cases was evaluated and confirmed which involved the rainwater harvesting system design and operation to be the validation. The adoption rate of rainwater harvesting system design and operation in green building certificated cases is around 50% in general since 2000 to 2013, as shown in Figure 1.

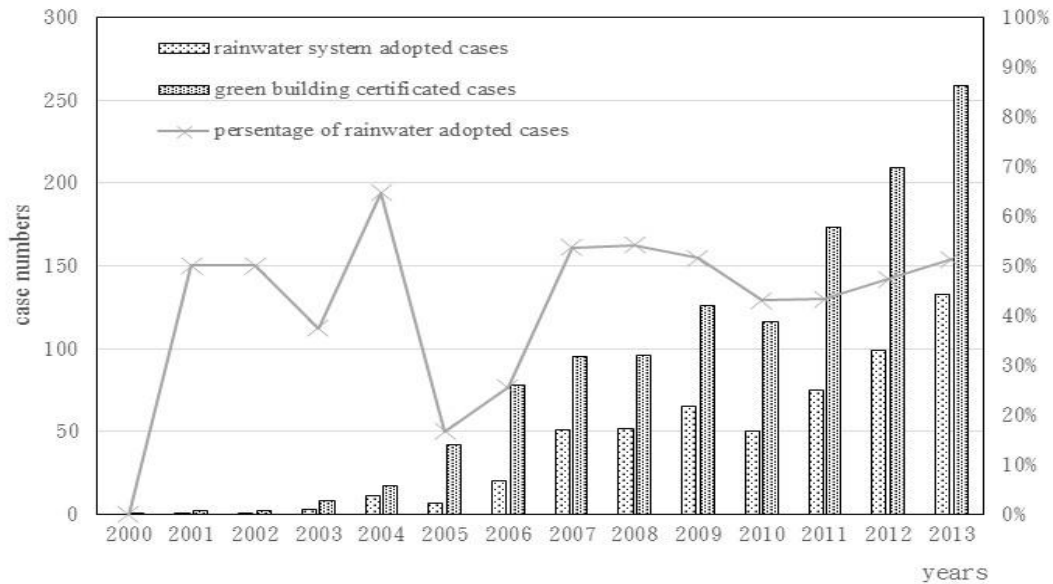

Figure 1: Green building certificated cases with rainwater system design

It is not possible to survey all green building certified cases with water consumption data. Thus, limited real cases of green building certification with confirmed data were selected to validate the efficiency of rainwater system. Due to the water quality standard and utility needs, the water saving rate was limited under 60% in evaluation system. Meanwhile, the rainwater substitution rate has maxima for different building type and utility needs. Herein, three groups of building types were defined from the 52 categories as residential, commercial and productive usage.

The residential use is daily usage for life including drinking, bathing, washing and etc.. The commercial use is daily usage for working area mostly is for toilet, washing, cleaning and etc.. The productive use is the usage for production area and the utility is vary and comprehensive including factory, restaurant, sport center, hospital and etc.. The usage includes producing process, toilet, washing, cleaning and etc.. Therefore, each category has maxima rainwater substitution rate for calculation from 20% to 55%. According to the reasonable limitation of maxima substitution rate, the green building certificated cases could be evaluated from water saving rate to rainwater substitution rate which the contribution framework of rainwater system adoption could be identified and recognized.

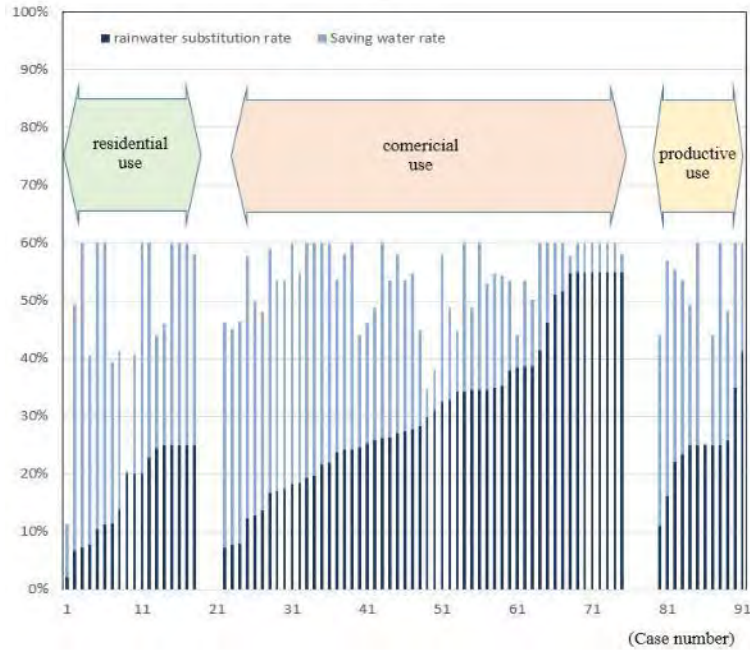

Figure 2: Distribution of rainwater substitution rate and water saving rate

This study used 91 cases of green buildings which involved the rainwater harvesting system design and operation to be the validation. Figure 2 shows the distribution of rainwater substitution rate and water saving rate of three group's buildings. It reveals that the rainwater substitution rate of residential use has lower rate of average 17%. As a result, the evaluation result shows average 54% water saving rate in these cases involved rainwater harvesting system. Initially, the average rainwater substitution rate is 28% as shown as Figure 3.

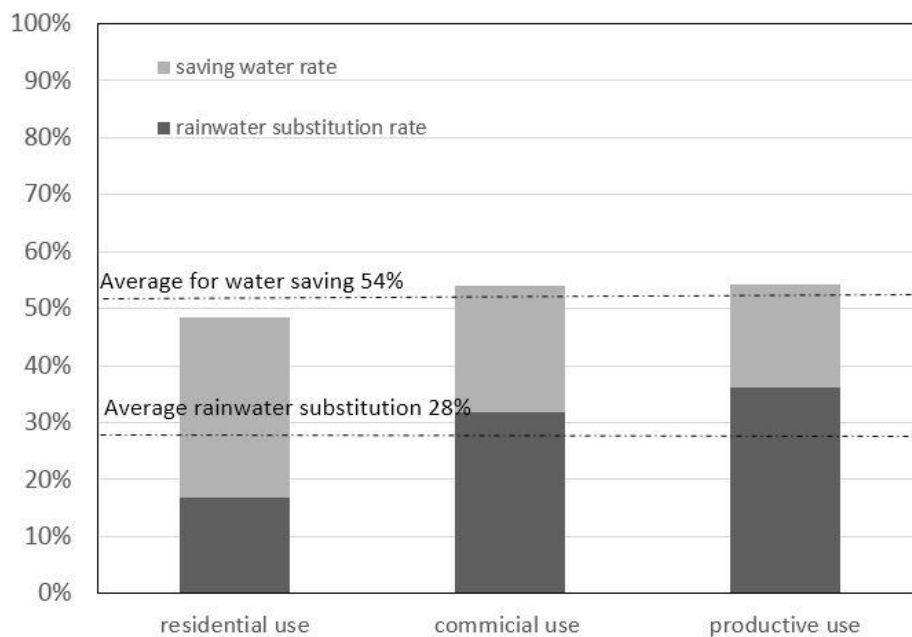

Figure 3: Comparison of rainwater substitution rate of three group's buildings

5. CONCLUSION

In this study the real cases awarded by green building certification since 2000 to 2013 are taken as the research subjects. WUI is proposed as the definition of building water usage density and to serve as the baseline of building water usage to evaluate the water efficiency of building water consumption. This conception is used to evaluate the water conservation in green building as the index to improve the water efficiency. The results are adopted by carbon footprint calculation model and link to low carbon evaluation system in Taiwan. Through the field survey, the water efficiency was evaluated and confirmed. This research used 91 cases of green buildings which involved the rainwater harvesting system design and operation to be the validation. The evaluation result shows average

54% water saving rate in these cases involved rainwater harvesting system. Initially, the average rainwater substitution rate is 28%. It is proved the significant contribution to water efficiency from adoption of water saving design and rainwater reuse system in green buildings.

REFERENCES

- [1] Kanako T.; Takayuki O.; Yasutoshi S. Water Use Patterns in Vietnamese Hotels: Modelling Toilet and Shower Usage. *Water* 2016, 8, 85.
- [2] Toyosada, K.; Shimizu, Y.; Dejima, S.; Yoshitaka, M.; Sakaue, K. Evaluation of the potential of CO2 emission reduction achieved by using water-efficient housing equipment in Dalian, China. In Proceedings of the 38th International Symposium of CIB W062 on Water Supply and Drainage for Buildings, Edinburgh, UK, 28 August 2012; pp. 27–30.
- [3] Minami, O.; Ryohei Y.; Minoru, S.; Masayoshi, K.; Kanako, T.; Yasutoshi, S.; Kyosuke, S.; Liao, W.J.; Lee, M.C.; Cheng, C.L. Comparison of the Physical Properties of Showers that the Satisfaction of Shower Feeling among Users in Three Asian Countries. *Water* 2015, 7, 4161–4174.
- [4] Mangsham, L.; Berrin, T. Life cycle based analysis of demands and emissions for residential water-using appliances. *J. Environ. Manag.* 2012, 101, 75–81.
- [5] Okamoto, M.; Sato, M.; Shodai, Y.; Kamijo, M. Identifying the physical properties of showers that influence the satisfaction of shower feeling for the purpose of developing water-saving showers. *Water* 2015, 7, 4054–4062.
- [6] Okamoto, M.; Sato, M.; Shodai, Y. Analysis of factors affecting showering comfort—Comparison between Japan and Taiwan. *J. Affect. Eng.* 2015, 14, 173–180.
- [7] Wong, L.T.; Cheung, C.T.; Mui, K.W. Energy efficiency benchmarks of example roof-tank water supply system for high-rise low-cost housings in Hong Kong. In Proceedings of the 39th International Symposium CIB W062 on Water Supply and Drainage for Buildings, Nagano, Japan, 17–19 September 2013; pp. 349–359.
- [8] Matos, C.; Briga-Sá, A.; Pereira, S.; Silva-Afonso, A. Water and energy consumption in urban and rural households. In Proceedings of the 39th International Symposium CIB W062 on Water Supply and Drainage for Buildings, Nagano, Japan, 17–19 September 2013; pp. 209–221.
- [9] C.L. Cheng, M.C. Ho, W.J. Liao, S.G. Chang, Y.S. Jing, Evaluation of water efficiency from adoption of rainwater reuse system in green buildings, In Proceedings of the 42th International Symposium CIB W062 on Water Supply and Drainage for Buildings, Kosice, Slovakia, Aug29–Sep01 2016; pp. 103–113.
- [10] Cheng-Li Cheng, Jr-Jie Peng, Ming-Chin Ho, Wan-Ju Liao, Szu-Jen Chern, Evaluation of Water Efficiency in Green Building in Taiwan, *Water* 2016, 8(6), 236.

A Comparative Study on Economic Policies for Construction and Demolition Waste Minimisation

Jongsung WON^a, Jack CP CHENG^b, Irene MC LO^c

^a Korea National University of Transportation, South Korea, jwon@ut.ac.kr

^b The Hong Kong University of Science and Technology, Hong Kong SAR, cejcheng@ust.hk

^c The Hong Kong University of Science and Technology, Hong Kong SAR, cemclo@ust.hk

ABSTRACT

The amount of solid waste generated in construction and demolition (C&D) processes is massive. Therefore, many countries and cities have established various economic policies to reduce C&D waste, which include waste disposal charge, deposit-refund scheme, tax on materials, and fine scheme. Appropriate economic policies can motivate the construction industry to minimise C&D waste. There are differences in economic policies adopted by various countries and cities. However, studies that compare the economic policies for C&D waste minimisation in various countries and cities are currently lacking. Therefore, this paper aims to quantitatively and qualitatively compare the economic policies implemented for C&D waste minimisation in Hong Kong, South Korea, the US, the UK, Ireland, the Netherlands. To understand the impacts of the economic policies on C&D waste minimisation, C&D statistical data are also analysed. Based on the comparative study, this paper will discuss the relationships between the economic policies and C&D waste. Recommendations on economic policies for C&D waste minimisation will also be provided.

Keywords: construction and demolition (C&D) waste, economic policy, waste management

1. INTRODUCTION

The amount of solid waste generated in construction and demolition (C&D) processes is massive. For example, C&D waste contributes 25% of solid waste disposed of at landfills in Hong Kong (HKEPD, 2015), 26% in the US (USEPD, 2009), and 47% in South Korea (ME and KECO, 2014). Therefore, many regions such as Hong Kong (HKEPD, 2015) and the US (ESD, 2012) have established various economic policies to reduce C&D waste. Appropriate economic policies can motivate the construction industry to minimise C&D waste (Li, 2013). Economic policies include waste disposal charge, deposit-refund scheme, tax on materials, and fine scheme (Li, 2013). There are differences in economic policies adopted by various countries and cities. For example, a high landfill tax is charged at USD 176 per tonne in Germany, which is 11 times as expensive as the construction waste disposal charge in Hong Kong. However, studies that compare the economic policies for C&D waste minimisation in various regions are currently lacking. Therefore, this paper aims to quantitatively and qualitatively compare the economic policies implemented for C&D waste minimisation in the Asia Pacific, North American, and European regions because they are the largest construction markets (IHS, 2013). Specifically, Hong Kong, South Korea, the US, the UK, Ireland, and the Netherlands were studied in this paper. The details of economic policies to be investigated include establishment and modification years of economic policies, waste disposal facilities, classification of waste types, and charges for each waste type. To understand the impacts of the economic policies on C&D waste minimisation, solid waste and C&D waste generated per capita and C&D waste generation rates are analysed as well.

The next section introduces the economic policies for C&D waste minimisation in the six regions, and investigates and compares them quantitatively and qualitatively. Section 3 compares previous and current C&D waste statistical data of each region. Section 4 discusses the findings, followed by conclusion in Section 5.

2. ECONOMIC POLICIES FOR C&D WASTE MINIMISATION

This section introduced and compared the economic policies for C&D waste minimisation in Hong Kong, South Korea, the US, the UK, Ireland, and the Netherlands.

2.1 Economic policies for C&D waste minimisation

The economic policies cover deposit-refunded scheme, fines scheme, charging scheme (or landfill levy), and tax on raw materials (Li, 2013). Deposit-refunded scheme means that the deposit is refunded when the specific requirements are fulfilled. The scheme reduces the incentive to illegal dumping and stimulates reuse and recycling of waste streams. In construction and demolition diversion deposit (CDDD) in the US, the deposit is based on construction type, project size, and project value. Fines are charged for non-compliance such as illegal dumping and low recycling rates. The charging scheme charges construction waste generation in order to reduce the amount of C&D waste disposed of at landfills. Many countries and regions have adopted this scheme. Tax on raw materials is a financial measure by shifting the price differential against raw materials and in favour of secondary materials, in order to reduce resource extraction, to increase recycling rates, and to make full use of secondary materials.

2.2 Comparison of economic policies

Establishment and modification years of the four types of the economic policies were investigated and compared in this study. Data on the economic policies for C&D waste minimisation in the six regions were collected from previous studies (Oosterhuis et al., 2009, EIONET, 2009, HKEPD, 2012, ESD, 2012), as shown in Table 1. Although there are no economic policies for C&D waste management and minimisation in South Korea, the waste management law introduced for solid waste in South Korea in 1986 was used for C&D waste as well (KECO, 2016).

A deposit-refunded scheme (in 2001) and fines scheme (in 2006) were established in the US. In terms of the deposit-refunded scheme, CDDD of the County of San Diego (ESD, 2012) was effective in 2007 with the requirement of 90% of inert waste and 70% of other waste diverted from landfill. Four regions such as Hong Kong, the US, the UK, and the Netherlands established tax on raw materials. Moreover, tax on raw materials is also adopted by most of European countries such as Denmark, Sweden, Belgium, and Italy (Eunomia et al., 2009).

Region (reference)	Economic policies (year)			
	Charging scheme	Deposit-refunded scheme	Tax on raw materials	Fines scheme
Hong Kong (HKEPD, 2012)	2006	-	2001	-
South Korea (KECO, 2016)	1993 ^{a)} (2008 ^{a)b)}	-	-	-
US (ESD, 2012)	1989	2001 2007 (San Diego)	1998	2006
UK (EIONET, 2009)	1996	-	2002	-
Ireland (EIONET, 2009)	2002 (2008 ^{b)})	-	-	-
Netherlands (Oosterhuis et al., 2009, EIONET, 2009)	1996	-	1997	-

a) Denotes the establishment or modification year for solid waste

b) Denotes the modification year

Table 1: Comparison of economic policies for C&D waste minimisation in six regions

Interestingly, the UK has a progressive landfill tax, which means the tax rate rises each year, to enhance the awareness of waste reduction and divert waste from landfill (Tojo et al., 2006). Since there are big differences in the charging schemes adopted by various countries and cities, C&D waste charging schemes in the six regions are quantitatively compared in the next sub-section.

2.3 Comparison of C&D waste charging schemes

C&D waste charging can be categorized by waste type and waste treatment facility type according to charging schemes, as shown in Table 2. For example, in Hong Kong, C&D waste is classified into inert waste and non-inert waste by waste material. Inert construction waste contains rock, rubble, boulder, earth, soil, sand, concrete, asphalt, brick, tile, masonry, and used bentonite (HKEPD, 2013). In other regions such as South Korea and the Netherlands, C&D waste is categorized into combustible and non-combustible waste (Gritten, 2007). In the Netherlands,

combustible waste that can be recovered is prohibited to dispose of in landfills. Depending on the C&D waste types, C&D waste is disposed of in other types of facilities, including landfills, public fills, sorting facilities, and incineration facilities. Table 2 shows the comparison results of charging schemes in the six regions, including C&D waste types, facility types, charging fee, and ratios of charging fee.

C&D waste disposal cost at landfills in the UK (USD 107.7) is the most expensive, followed by the US (USD 74.0), the Netherlands (USD 70.8), South Korea (USD 46.1), and Ireland (USD 26.0). The C&D waste disposal cost at landfills in Hong Kong (USD 16.4) is the cheapest among the six regions, which is 15.2% of that in the UK. On the other hand, the disposal cost at public fills in the UK and Hong Kong are cheap. The incineration of construction waste in South Korea is the most expensive method.

Country (Reference)	C&D waste type	Facility type	Charing fee (USD/tonne)	Ratio (%)
Hong Kong (HKEPD, 2012)	Less than 50% inert waste	Landfill	16.4	15.2
	Inert waste	Public fill	3.5	3.2
	More than 50% inert waste	Sorting facilities	12.9	12.0
South Korea (Lee and Dong, 2016)	Mixed waste	Landfill	46.1	42.8
	Recyclable waste	Sorting facilities	67.3*	62.4
	Combustible	Incineration	134.5*	124.9
US (ESD, 2012)	Mixed waste	Landfill	74.0	68.7
	Recyclable concrete	-	10.0	9.3
UK (UKGov, 2006)	Mixed waste	Landfill	107.7	100.0
	Sorted waste (rock or soil)	Public fill	3.2	3.0
Ireland (Li, 2013)	-	Landfill	26.0	24.1
Netherlands (Van Dijk et al., 2001)	Non-combustible	-	13.9	12.9
	Combustible	-	70.8	65.7

* Is the average value of charging fee

Table 2: Comparison of charging schemes in the six regions

3. ANALYSIS OF C&D WASTE STATISTICS

In order to understand the current status of C&D waste generation and the impacts of the economic policies on waste minimisation in the six regions, their C&D waste statistical data were collected, analysed, and compared. This paper analysed data on (1) the amount of generated solid waste per capita, (2) the amount of generated C&D waste per capita, and (3) C&D waste generation rates.

In order to analyse the amount of generated solid waste and C&D waste per capita in each region, data on the amount of generated solid waste and C&D waste and population in each region should be collected. In this paper, data on the amount of solid waste and C&D waste were obtained from database of HKEPD (2015), ME and KECO (2014), and Eurostat (2016) for Hong Kong, South Korea, and the UK, Ireland, and the Netherlands, respectively. However, since Eurostat has provided waste information during the period from 2004 to 2012, this paper analysed trends of generated C&D waste per capita for 12 years. Population data in South Korea, the UK, Ireland, and the Netherlands were collected from the Organization for Economic Co-operation and Development (OECD) Structural Analysis (STAN) database (OECD, 2016). Population data in Hong Kong were collected from the database of the Census and Statistics Department of Hong Kong (HKCSD, 2016).

Figure 1 shows the trends of (a) Generated solid waste per capita, (b) Generated C&D waste per capita, and (c) C&D waste generation rates in the six regions during the period from 2004 to 2012. However, since data on the amounts of solid waste and C&D waste in the US were not officially provided, the results of the US could not be investigated and compared. As a result, the amount of generated C&D waste per capita in the Netherlands (average: 3,930kg) was generally larger than those in Ireland (2,033kg), Hong Kong (2,011kg), the UK (1,674kg), and South Korea (1,279kg), in spite of high recycling rates of C&D waste (around 99% in the Netherlands (Gritten, 2007)). The amount of generated C&D waste per capita increased in the Netherlands (159%), Hong Kong (203%), and South Korea (121%) during the periods from 2004 to 2012, while those in the UK (95%) and Ireland (3%) decreased during the period. Interestingly, generated C&D waste per capita in Hong Kong has rapidly increased since 2008, while that in Ireland has rapidly decreased since 2006 although generated C&D waste per capita in Ireland in 2006 was the highest among the six regions. The C&D waste charging schemes in Hong Kong and

Ireland were released or modified in 2006 and in 2008, respectively, and they had positive impacts on C&D waste reduction at the time the schemes were released or modified in each region. Especially, generated C&D waste per capita in Ireland in 2012 was around 2 % of that in 2006. On the other hand, although generated C&D waste per capita in Hong Kong in 2008 was 77% of that in 2004, that in 2012 increased by 2.6 times as compared with that in 2008. According to previous studies (Lu, 2013, Lu and Tam, 2013, Yu et al., 2013, Hao et al., 2008), the C&D waste charging scheme in Hong Kong helped to reduce the amount of C&D waste generated for the first three years (2006 to 2008); however, the impacts of the charging scheme was low since 2008 because of low C&D waste disposal cost. The most expensive cost for disposal of C&D waste in the UK can be a reason of the slight decrease in the amount of C&D waste generation in the UK. Another reason is the annual increase of C&D waste disposal cost in the UK year by year.

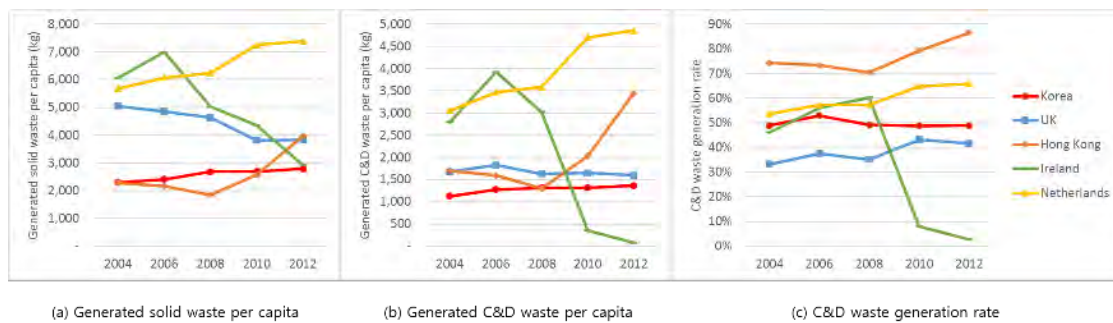

Figure 1: Trends of solid waste and C&D waste generation per capita in the six regions (2004, 2006, 2008, 2010, and 2012)

Although time-based trends of the amount of generated C&D waste per capita in the six regions were similar to those of generated solid waste per capita and of C&D waste generation rates, the orders of C&D waste generation rates in the six regions were slightly different from that of generated C&D waste per capita. In terms of C&D waste generation rates, Hong Kong (average: 77%) was the highest, followed by the Netherlands (60%), South Korea (48%), the UK (38%), and Ireland (35%). The C&D waste generation rates in the UK (125%), the Netherlands (123%), and Hong Kong (127%) increased unlike those in South Korea (100%) and Ireland (6%).

4. DISCUSSION

According to the results of this study and previous studies (Li, 2013), disposal cost of C&D waste had positive impacts on C&D waste reduction. Therefore, appropriate adjustment of disposal cost of C&D waste can motivate practitioners to efficiently minimise and manage C&D waste on site. Referring to the policy in the UK, an annual increase of the disposal fee year by year helps to decrease the amount of C&D waste generation. In Hong Kong, the charges for C&D waste disposal will be increased with effect from April 2017 to reduce the amount of generated and disposed C&D waste. Public fill charge, sorting charge, and landfill charge in Hong Kong are proposed to be increased to USD 9.2, 22.6, and 25.8 (263%, 175%, and 160% of charges of the current C&D waste disposal charging scheme in Hong Kong), respectively (HKEPD, 2016)

In order to efficiently minimise C&D waste, quantified goals, such as setting limits on the amount of total C&D waste being sent to landfills, setting recycling rates for C&D waste, etc., are required. The Department for Environment, Food, and Rural Affairs (DEFRA) in the UK has attempted to achieve zero construction waste to be disposed of at landfills by 2020 (Ismam and Ismail, 2014). The UK already exceeded the 2020 reduction target of recovering at least 70% by weight of inert C&D waste (DEFRA, 2013). Additionally, the impacts of economic policies on C&D waste reduction should be continuously monitored by investigating time-trends of C&D waste generation and disposal.

A comprehensive C&D waste composition study should be conducted so as to be aware of the current quantities of each C&D waste material type. Not only sorting inert and non-inert materials or combustible and non-combustible materials, a more detailed breakdown is necessary to identify which material type is in majority and which type should be mainly managed. The study should be carried out periodically in order to keep the data most up to date so that it can reflect recycling performance of different C&D waste materials as well as changes of disposal patterns because of established and modified economic policies for C&D waste minimisation. The collected data could also help the government to propose possible future scenarios and required capacities.

5. CONCLUSIONS

This paper quantitatively and qualitatively investigated and compared the economic policies for C&D waste minimisation in Hong Kong, South Korea, the US, the UK, Ireland, and the Netherlands. Four types of economic policies, namely deposit-refunded scheme, fines scheme, charging scheme (or landfill levy), and tax on raw materials, were compared. In terms of charging schemes, there are big differences among the six regions. Tax on raw materials and charging schemes are used as economic policies for C&D waste minimisation in the investigated regions. The disposal cost at landfills in Hong Kong is around 15% of that in the UK. Comparing results of C&D waste statistics in Hong Kong, the UK, and Ireland, this study finds that high disposal cost, annual increase of disposal cost, and establishment or modification of C&D waste charging schemes have positive impacts on C&D waste minimisation. However, impacts of low disposal cost for C&D waste in Hong Kong on C&D waste reduction did not last for a long period, but in Ireland, generated C&D waste per capita in 2012 decreased by 2% of that in 2006.

However, due to the limitations of data collection in this study, relationships between the economic policies and the amount of C&D waste were not analysed quantitatively and other factors can affect the C&D waste statistics as well. Therefore, in the future, the relationships will be analysed using statistical methods.

ACKNOWLEDGMENT

This research was supported by Basic Science Research Program through the National Research Foundation of Korea (NRF) funded by the Ministry of Education (2015R1A6A3A03018687).

REFERENCES

- [11] Session 7.5: SBE Assessments – Practice Review DEFRA. 2013. Waste Management Plan for England [Online]. London, UK: Department for Environment, Food and Rural Affairs. Retrived from: https://www.gov.uk/government/uploads/system/uploads/attachment_data/file/265810/pb14100-waste-management-plan-20131213.pdf, [Retrieved on].
- [12] EIONET. 2009. Country Fact Sheets on Waste Policies - 2006 edition [Online]. European Topic Centre on Sustainable Consumption and Production. Retrived from: http://scp.eionet.europa.eu/facts/factsheets_waste/2006_edition, [Retrieved on Sep. 2016].
- [13] ESD. 2012. Benefits of Construction and Demolition Recycling. Environmental Services Department, City of San Diego. California, United States
- [14] Eunomia, Tobin Consulting Engineers, Arcadis, Monza, S. A. d. P. d., Engineering, T. and Zealand, E. N. 2009. International Review of Waste Management Policy: Annexes to Main Report. Oko-Institute.
- [15] Eurostat. 2016. Generation of waste [Online]. Eurostat. Retrived from: <http://appsso.eurostat.ec.europa.eu/nui/submitViewTableAction.do>, [Retrieved on Sep., 2016].
- [16] Gritten, T. 2007. A review of international approaches to waste prevention and minimization. AEA Energy and Environment, UK
- [17] Hao, J. L., Hills, M. J. and Tam, V. W. Y., 2008. The effectiveness of Hong Kong's construction waste disposal charging scheme. Waste Management and Research, 26, 553-558.
- [18] HKCSD. 2016. Population Estimates [Online]. Hong Kong, China: Census and Statistics Department, Hong Kong. Retrived, [Retrieved on Sep., 2016].
- [19] HKEPD. 2012. Recovery and Recycling of Municipal Solid Waste in Hong Kong. Hong Kong EPD. Hong Kong, China
- [20] HKEPD. 2013. Introduction to Construction Waste [Online]. Hong Kong: HKEPD. Retrived from: <http://www.epd.gov.hk/epd/misc/cdm/introduction.htm>, [Retrieved on July, 2015].
- [21] HKEPD. 2015. Monitoring of Solid Waste in Hong Kong - Waste Statistics for 2013. HKEPD. Hong Kong
- [22] HKEPD. 2016. Construction Waste Disposal Charging Scheme [Online]. Hong Kong, China: Hong Kong Environmental Protection Department. Retrived, [Retrieved on Sep. 2016].
- [23] IHS. 2013. Global Construction Outlook. IHS Economics. CO, USA
- [24] Ismam, J. N. and Ismail, Z., 2014. Sustainable construction waste management strategic implementation model. Wseas Transactions on Environment and Development, 10, 48-59.

- [25] KECO. 2016. Waste Disposal Scheme [Online]. Seoul, South Korea: Korean Environment Corporation. Retrived from: <http://www.budamgum.or.kr/user/system/intro.wcs?uppMenuId=2&menuId=11>, [Retrieved on Sep., 2016].
- [26] Lee, J. and Dong, G. 2016. Issues of landfill in Seoul. Gyeonggi Research Insitute. South Korea
- [27] Li, Y. 2013. Developing a Sustainable Construction Waste Estimation and Management System. Ph.D., The Hong Kong University of Science and Technology, Hong Kong, China.
- [28] Lu, W. 2013. Construction waste management in Hong Kong: 10 years, no change? Building Journal. China Trend Building Press Ltd. Hong Kong, China
- [29] Lu, W. S. and Tam, V. W. Y., 2013. Construction waste management policies and their effectiveness in Hong Kong: A longitudinal review. Renewable & Sustainable Energy Reviews, 23, 214-223.
- [30] ME and KECO. 2014. 2013 Generation and Disposal of Waste in South Korea. Ministry of Environment and Korea Environment Corporation. Sejong, South Korea
- [31] OECD. 2016. OECE.Stat [Online]. Organization for Economic Co-operation and Development (OECD). Retrived from: <https://stats.oecd.org/#>, [Retrieved on Feb., 2016].
- [32] Oosterhuis, F. H., Bartelings, H., Linderhof, V. G. M. and van Beukering, P. J. H. 2009. Economic instruments and waste policies in the Netherlands. Institute for Environmental Studies, Vrije Universiteit. Amsterdam, Netherlands
- [33] Tojo, N., Neubauer, A. and Bräuer, I. 2006. Waste Management Policies and Policy Instruments in Europe: An Overview. The International Institute of Industrial Environmental Economics. Lund University, Sweden
- [34] UKGov. 2006. Environmental taxes, reliefs and schemes for businesses - Landfill Tax [Online]. UK: UKGov. Retrived from: <https://www.gov.uk/green-taxes-and-reliefs/landfill-tax>, [Retrieved on Sep., 2016].
- [35] USEPD. 2009. Buildings ad their impact on the environment: a statistical summary. US EPA Archive Document. U.S. Environmental Protection Agency (USEPD). U.S.
- [36] Van Dijk, K., Boedianto, P., Te Dorsthorst, B. J. H. and Kowalczyk, T., 2001. Strategy for reuse of construction and demolition waste role of authorities. Heron, 46, 89-94.
- [37] Yu, A. T. W., Poon, C. S., Wong, A., Yip, R. and Jaillon, L., 2013. Impact of construction waste disposal charging scheme on work practices at construction sites in Hong Kong. Waste Management, 33, 138-146.

Using Supply Chain Management for Sustainable Public Procurement

Johannes WALL^a, Jörg KOPPELHUBER^b, Christian HOFSTADLER^c

^a Graz University of Technology, Austria, johannes.wall@tugraz.at

^b Graz University of Technology, Austria, joerg.koppelhuber@tugraz.at

^c Graz University of Technology, Austria, johannes.wall@tugraz.at

ABSTRACT

In recent years, interest in the cross-disciplinary area of sustainable procurement has increased in both academia and research. A main driver of this development is the rising number of policies and regulations dealing with these issues of procurement (e.g. COM (2008) 400; Directive 2014/24/EU). There are various strategies available for including sustainability aspects in the procurement of construction works.

However, the consideration of sustainability aspects in the tendering and awarding stage has only been implemented to a limited extent (insufficient criteria and weighting). In addition, a holistic approach is still missing.

This contribution presents a review of existing evaluation approaches in public tendering and awarding of construction works. This helps to provide evidence of connections between sustainability policy goals included in public procurement tenders and how public contracts are awarded (especially in Central Europe).

Furthermore, the paper focuses on supply chain management and how these processes of criteria setting, especially from the private (automotive) sector, can be considered and transferred to public procurement procedures. Therefore, not only product related aspects are examined, but also process related issues, e.g. information exchange and workflow management.

The goal is to identify and evaluate useful supply chain management criteria development methods, which could be adapted for construction and building projects in order to focus on a more holistic consideration of sustainability aspects.

Finally, a more performance-orientated approach is intended, with the aim of working towards a more cooperative procurement. Joint specification, selected tendering, performance-based bid evaluations and collaborative tools particularly influence the success of a construction project during its life cycle.

Keywords: green procurement, design process, green economics

1. INTRODUCTION

Based on the latest climate initiatives, there is increasing awareness of the construction industry and their contribution to fighting climate change. In addition to the COP 21 taking place in Paris in 2015, a global alliance for building and construction has been launched to emphasize the implementation of ambitious actions towards the below 2°C pathway in the building and construction sector (cf. UN, 2015). The sector offers crucial potential for resource and energy efficiency; 30% of global CO₂ emissions are related to construction activities. Current developments such as rapid urbanisation, in particular in emerging economies, highlight the need to use the procurement of goods and services in the building sector to consider these sustainable development issues. This contribution targets the use of supply chain management to enable and promote sustainable public procurement.

2. METHODOLOGY

In order to assess the state of the art in sustainable public procurement, an extensive literature review (Wall and Hofstadler, 2016a) has been performed. In a second step, the ongoing situation has been investigated using an expert questionnaire with the aim of investigating current implementation of sustainable construction (Scherz, 2016). The questionnaire explored the perception of different parties and stakeholders involved in sustainable construction from an AEC point of view. The experts were chosen based on their experience in this field. These are people with a certain specific knowledge and expertise in a field (based on reference projects). Experts (in general) are responsible for the design and implementation as well as for checking/monitoring a certain solution and have privileged access to certain information such as decision-making processes (cf. Bogner et al., 2009).

This contribution shows the important role of supply chain management in achieving sustainable procurement. The findings stated in the following sections provide an overview focussing on the building sector. But most of these issues are relevant to the whole construction industry. There are several patterns, especially in procurement, that target the use of supply chain management.

3. SUSTAINABLE PUBLIC PROCUREMENT

The procurement process sets up legal boundaries, based on the conditions within which a project is developed. Several European and national initiatives proposed policies for considering additional aspects during the tendering procedure. These started with the white paper on public procurement in the EU and COM 96 (583) final as well as **COM 98 (143) final, which concluded with COM (2001) 274 focusing on “Commission interpretative communication on the Community law applicable to public procurement and the possibilities for integrating environmental considerations into public procurement”. They resulted in the directive 2004/18/EC, which supports the awarding of contracts based on the most economically advantageous tender and enables a more life cycle orientated perspective in tendering with the European directive 2014/24/EU.**

3.3 Current implementation of sustainability issues

The current procurement process within harsh and competitive markets in the construction industry is characterized by a strong focus on financial issues. The building sector has a fluctuating demand cycle, uncertain production conditions and segmented production processes with competitive relationships among the involved stakeholders. In order to focus more on life cycle oriented sustainable development, it is important to take into account a holistic approach, therefore the most economically advantageous tender could be suited best.

In the current implementation of sustainability aspects in the design and procurement of buildings, there is a strong focus on individual aspects, especially environmental issues. They may also be linked to certain energy-related performances of buildings, and building certification schemes are used to communicate these ambitions in practice. Therefore, data is required to transport this information and communicate certain aspects during the planning and construction stages of a project. For instance, in terms of environmental qualities, there are two different approaches available. One is on using normative issues, such as indications of toxic components and harmful influences, as limitation criteria in the procurement process. This information is gathered in online databases such as WECOBIS (German platform on ecological building products) and baubook (containing similar ecological information and offering services for implementing text blocks into calls for tenders).

Otherwise, a material selection process based on life cycle assessment according to EN ISO 14040 for determining the ecological performance of certain products and building components can help certain design targets to be reached. Relevant information can be communicated using environmental product declarations (EPDs) throughout the supply chain as an information tool for business-to-business clients/customers. Due to their standardized information, EPDs can be used in the procurement process to indicate the consideration of sustainability aspects and as an appropriate tool for documentation and quality management during the planning and construction stages (cf. Passer et al., 2015).

In an empirical study (cf. Scherz, 2016), different expert views from AEC industry have been assessed, not only taking into account the current implementation of sustainable construction but also future potential and action needed. The experts agreed that extensive demand planning is indispensable for the definition of specific stakeholder aims, especially for the consideration of sustainability aspects.

However, when the current situation is considered, the barriers result from reduced and limited financial and organisational capabilities of the clients. This is often combined with an insufficient understanding of integrated project deliveries and information workflows across the stakeholders. In addition to financial issues (price), current selection criteria take into account evidence of environmental policy, the supply chain network of subcontractors as well as the health and safety performance of main contractors. Furthermore, limited environmental information on products leads to look-alike criteria, which aim to consider life cycle orientated issues, but, due to their reduced weighting in the awarding procedure, are not relevant or do not contribute to a life cycle optimization.

Following the idea of holistic optimisation, it is important to target not only single normative aspects, but also an integrated project delivery.

When these findings are viewed in the context of the fragmented relationships between clients, contractors, subcontractors, and the building products and components manufacturing industry, the topic of supply chain management becomes of clear relevance.

4. SUPPLY CHAIN MANAGEMENT

Supply chain management (SCM) is a concept that flourished in manufacturing. It originated from Just-In-Time (JIT) production and logistics, taking into account the interdependency of supply chains (cf. Vrijhoef and Koskela, 1999). Recent developments in the field of SCM include the expansion of traditional performance measures (time, cost, and quality) including environmental and social aspects. In the automotive industry, factors affecting suppliers are identified as cost, technical capability, quality assessment, organisational profile, service levels, supplier profile **as well as risk factors. Furthermore, suppliers' sustainability performance is becoming** increasingly important as a key issue of tender selection criteria. Sustainable supply chain management (SSCM) has become a major issue in many industries, with the construction sector lagging behind (cf. Adetunji et al., 2008).

Green and sustainable supplier selection adds to the complexity of the decision and modeling process. The criteria are less specific and sometimes not easy to measure as they include aspects such as collaboration and project culture. Therefore, the operationalization of these criteria into meaningful and practical measurable variables presents a challenge to both suppliers and purchasers (cf. Igarashi et al 2013)

The following Figure 1 illustrates a general overview of a supply chain, with its dependencies in building construction (according to Vrijhoef and Koskela, 1999).

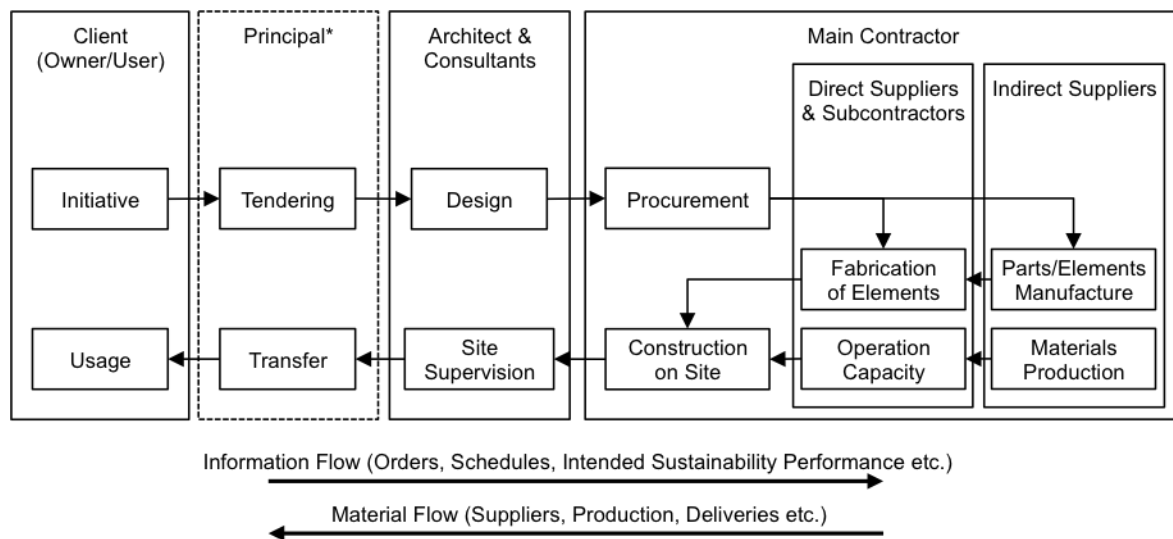

* Relationship depending on the contractual framework.

Figure 22: Generic overview of a building supply chain

A major challenge is to communicate information targeting sustainable performance, not only of certain products and materials, but also of overall achievement. Problems occur due to information asymmetries and losses through the supply process, affecting the interdependencies. This causes delays in earlier stages, resulting from myopic understanding and control of single processes missing out the impact on other related processes. In many cases, the actors are not willing/prompted to consider the effects of their activities.

4.1 Supplier selection methods

When procuring complex services and products, there is a need to evaluate and select qualified suppliers. The supplier selection process is often reduced to purchasing risks and maximizing the overall value of the purchase. The methodology evolved from the manufacturing industry, where selecting the right suppliers is crucial for business and represents a major opportunity for companies to reduce costs across its entire supply chain. However, emphasis changed from selection just based on price and has turned into a multi-criteria approach, with various qualitative and quantitative evaluation criteria.

There are plenty of sources introducing different approaches based on a categorical method, data envelopment and cluster analysis, such as case-based rating system decision modes for supplier selection. They follow a multi-criteria approach divided into multi-criteria decision-making tools, focusing on evaluation criteria, and sensitivity analysis (cf. Pal et al. 2013).

In this context, it is important to point out that the weighting aspect of additional criteria in supplier selection can vary depending on the specific project conditions.

4.2 Classification of project parameters

An increasing awareness of environmental issues due to clients' green procurement policies has led to a focus on a more comprehensive implementation of sustainability aspects, which depends on the type of building and its usage e.g. housing, office and public service buildings (hospitals, schools). Following this diversification, there are different key issues that occur in the context of a specific project and are necessary for providing a certain type of usage. Such parameters can be divided into: project goals, resources of the client, specific importance of the project, project duration, costs and number of involved experts and professionals from different disciplines managing the planning and construction tasks. Such issues are important in the selection of a supplier in terms of adapting requirements in specific project classes.

4.3 Supplier selection criteria

Despite the importance of sustainable supply chain management, there are several gaps in the research on how to implement sustainable issues into the procurement process within the frameworks of several policies (e.g. COM(2008)400) and directives (e.g. Directive 2014/24/EU). Literature reveals various criteria for supplier selection, such as cost, delivery quality, warranties, client policies and especially environmental product properties (cf. Pal et al., 2013).

The focus is often purely on product issues and material properties. Setting up selection criteria, it has to be considered that building products and the overall performance of the building are strongly influenced by the planning and building processes.

A life cycle optimized building can only be achieved using an integrated approach. This includes the consideration of issues related to process qualities, in terms of identifying criteria defining how specific works are carried out and performed, focusing on information flows and the design of reference processes to support the holistic optimization of a construction project.

4.4 Performance-based supplier selection criteria

Focusing on the different stakeholders and their contribution to a successful project, their technical (problem-solving) capability is crucial for providing high quality delivery. Requirements of a more performance-orientated supplier selection target the workforce skills, organisational structures, information flows and exchange within the project team. Factors include employment relationship, staffing schedule, and a proactive and solution-orientated working approach (cf. Wall and Hofstadler, 2016b).

Therefore, environmental management systems (EMS), certifications to ISO 14001 or special in-house policies and guidelines as well as qualification of key project managers can contribute towards a more performance-orientated supplier selection. Considering the composition of teams, the European Court of Justice confirmed in Case C-601/13 Ambisig 03/26/2015 that the academic and professional background of employees and their

experience enables an evaluation of teams, especially for the performance of the contract. Hence, previous performance can help to clarify credibility and references projects, in terms of reliability.

Another crucial aspect seems to be the corporate philosophy of a project team, related to the organizational issues of the contractor in terms of their company culture and how projects are handled. This is also linked to performance and interaction with the previous client, considering how they managed to support the project workflow, keeping to the schedule and contributing towards the common project aim. When measuring such issues, the number of submitted claims could be an issue, as well as the involvement of the cooperation and project development. Performance-based tendering decisions could be conducted using expert interviews with key employees to assess their problem solving capacities as well as their qualification and applicability for project specific requirements. Furthermore, such prequalification information can be obtained from electronic platforms such as ANKO or PQ-VOB.

Focusing on the supplier selection process, a committee (experts from different backgrounds, technical as well as representing user and operating perspectives) could provide support from early project stages onwards, defining awarding criteria and providing consistent consideration of these issues and their weighting factors through tendering and awarding stages.

The problem of the supply selection is also based on the fact that not all decisions can be made with measurable parameters that can be indisputably economically justified. This indicates a shift from cooperative to collaborative supplier performance.

A major weakness of SCM is the difficulty of creating a shared and common strategy and vision, achieving and maintaining significant behavioural change among involved stakeholders of the AEC, which in turn leads to a common understanding of project culture. The traditional reliance on price as a major indicator of success as well as fragmented delivery structures and competitive relationships, with the knowledge of the interchangeability of involved suppliers reveals the need for further investigation and research into these relationships and how to implement a continuous information flow towards a collaborative project culture.

Cooperative relationships recognize the potential for both organisations to achieve their aims and maintain a long-term relationship. But they lack the teamwork that is needed between the buying and supplying stakeholders. In collaborative relationships, a holistic view has to be applied for the two organisations to truly realize the benefits of working together to optimize the outcomes for both organizations in terms of developing a high-quality product or service on time and under budget.

5. CONCLUSION AND OUTLOOK

This paper emphasized the importance of sustainable public procurement and its contribution to putting the buildings and construction sector on a below 2°C path in the fight against climate change. There are several policies available, but practical implementation seems to lag behind. It is proposed that supply chain management should be used to deal with the complex situation of supplying and purchasing in the building and construction industry, due to the various suppliers and trades involved.

The aim is to use supply chain management to enable more sustainable decision making in tendering and awarding construction works in order to consider additional criteria rather than simply focussing on the cheapest offer when making the awarding decision. Therefore, the focus is not only on the product related aspects of construction works, but also on process-orientated aspects, thus supporting a more performance-based selection of contractors.

In terms of SCM or SSCM, the existing concepts can be defined as tools for identifying problematic economic, social and environmental issues throughout the supply chain and assessing their potential impact and risks and how to handle their occurrence. Therefore, a spectrum of advanced and innovative SSCM tools and methods are suggested, such as strategic alliancing, pre-qualification assessment and third parties certification of sustainable (environmental) product properties, validation of improvements, etc., in order to target an integrated project delivery.

The implementation of sustainability into the SCM is still limited to the willingness and capability of the client to decide to implement such a process. Thus, the responsibility of involved stakeholders and, subsequently, the practical implementation of sustainable aspects should be increased.

REFERENCES

- [1] Adetunji, I. et al., 2008. *Achieving sustainability in the construction supply chain*. Proceedings of the ICE – Engineering Sustainability, 161 (3), 161-172.
- [2] Bogner, A., 2009. *Introduction: Expert Interviews – An introduction to a New Methodological Debate*. In A. Bogner, B. Li g & W. Menz (Eds.), *Interviewing Experts* 1–13. London: Palgrave.
- [3] Igarashi, M. et al., 2013. What is required for greener supplier selection? A literature review and conceptual model development. *Journal of Purchasing and Supply Management* 19 (4), 247-263.
- [4] Pal, O., et al., 2013. *Supplier Selection Criteria and Methods in Supply Chains: A Review*. *International Journal of Social, Behavioral, Educational, Economic, Business and Industrial Engineering* 7 (10), 2667-2673
- [5] Passer, A., et al., 2015. Environmental Product Declarations entering the building sector - critical reflections based on 5 years experience in different European countries. *International Journal of Life Cycle Assessment* 20 (9), 1199-1212.
- [6] Scherz M., 2016. *Implementing Sustainable Construction - An Empirical Case Study*. Thesis (Master). Graz University of Technology
- [7] United Nations, 2015. *Global Alliance for Buildings and Construction*. Framework convention on climate change.
- [8] Vrijhoef, R. and Koskela, L., 1999. *Roles of supply chain management in construction*. In Proceedings IGLC-7 Berkeley, CA, USA. 133-146.
- [9] Wall, J. and Hofstadler, C., 2016a. *Sustainable Public Procurement of construction works – a literature review and future requirements*. In Sustainable Built Environment Conference 2016 in Hamburg. 1174-1183.
- [10] Wall, J. and Hofstadler, C., 2016b. *How can sustainability issues be considered in the public procurement process?* In S. Nenonen, J-M. Junnonen (Eds.) Proceedings of the CIB World Building Congress 2016. 94-105.

Innovative Measures to Protect Residential Developments from Traffic Noise - Hong Kong Experience

LAU Kwok-keung^a, LEE Chee-kwan^b, Maurice YEUNG^c

^a Environmental Protection Department, Government of the HKSAR, Hong Kong SAR, npg_kkl@epd.gov.hk

^b Environmental Protection Department, Government of the HKSAR, Hong Kong SAR, cklee@epd.gov.hk

^c Environmental Protection Department, Government of the HKSAR, Hong Kong SAR, mklyeung@epd.gov.hk

ABSTRACT

Hong Kong is a hyper-dense city with over 7.3 million people living in 1,100 sq. km in which 85% of land is hilly area. Due to the need to build residential developments to accommodate the ever growing population and at the same time, the need to have very concentrated road network systems to support economic growth, residential buildings are unavoidably built next to roads. As a result, traffic noise is undoubtedly the major environmental noise problem affecting residents in Hong Kong. The Government of Hong Kong Special Administrative Region (the Government) is committed to tackle road traffic noise problem through careful planning of new residential developments and also applying latest advancement of road surfacing to reduce noise at source. Alleviating traffic noise impact on new buildings sitting next to busy highways is never an easy task, nevertheless, the Government is forward looking and has been proactively collaborating with research institutes to develop innovative noise mitigation designs such as acoustic windows and acoustic balconies. Both are capable to reduce noise substantially while allowing natural ventilation for residents. On reducing noise at source, low noise road surfacing is a standard road surfacing material for expressway. New forms of road surfacing like polymer modified stone mastic asphalt with different aggregate size and crumb rubber stone mastic asphalt are being explored and put into trial widely on local roads. This paper summarizes the efforts in addressing traffic noise problems affecting residential developments through applying innovative acoustic windows and acoustic balconies; and overlaying low noise road surfacing on local low speed roads. Both means are novel ways that can be applied under suitable situations to achieve a quieter environment for residents in Hong Kong.

Keywords: traffic noise, noise mitigation measures and low noise road surface

1. INTRODUCTION

Hong Kong is one of the most densely populated metropolitan cities and is facing severe and pervasive road traffic noise problems. Due to a host of factors like limited habitable land, the need to provide accommodation for large population and concentrated transport networks to support economic growth, many residential developments are unavoidably built in close proximity to heavily trafficked expressways and roads, e.g. see Figure 1, and as a result, about 960,000 people are exposed to road traffic noise at levels higher than 70 dB(A)L10(1 hour).

There are mounting public concern about the noise environment and its impact on the residents' quality of life. Legislative Council members called for case conferences to look into the situation and pressed for solutions to reverse the situation. In response, the Administration is committed and action plans are in place to minimize the noise exposure. For instance, proactive preventive works are being done in planning of new roads and new residential developments so that future residents would not be affected by excessive road traffic noise. The Government are implementing measures such as retrofitting noise barriers on suitable sections of existing roads to address the existing problems.

For the preventing planning of new residential developments, conventional noise mitigating designs or measures like maximizing the setback from the road; orientating the building block to minimize view angle on the road; single aspect building design with only non-noise sensitive uses facing the road and using noise tolerant building, structure, architectural fin or purposely built barrier to screen off the road are considered for incorporation in the design of development against road traffic noise. However, these conventional noise measures may not be applicable in each and every case due to specific site constraints. Furthermore, these measures can hardly offer adequate noise reduction in the case which noise exceedances are large, say, when the housing block is extremely close to highly trafficked road. Therefore, innovative noise mitigation measures are needed in order to keep the traffic noise at bay. In this respect, the Government has been proactively collaborating with research institutes to

develop such mitigation measures in the form of specially designed windows and balconies (acoustic windows and acoustic balconies).

On the other hand, low noise road surfacing (LNRS) delivers promising performance even though noise reduction effect is not large as compared with that from barriers but all residents in the vicinity would be benefitted. As a matter of fact, LNRS has already been adopted for our new high speed (70km/hr or above) roads. The Administration takes further steps to test and to try out different forms of LNRS on local low speed roads.



Figure 1: Trunk roads built right next to residential blocks in the 1980s

2. INNOVATIVE NOISE MITIGATION DESIGNS

Closing of window with suitable pane for better acoustic insulation is a practicable noise mitigation measure in some western countries but not in Hong Kong because of its warm and humid climate, in particular, in summer. It **will not only practically deprive the residents of an “open-window” life style but also increase the energy consumption by air-conditioning which is needed for a “closed-window” environment in Hong Kong.** Therefore, **acoustic insulation is only provided as the “last-resort” for residents to choose closing the window for abatement of traffic noise disturbance.**

Therefore, in the context of Hong Kong, it is considered worthwhile to explore innovative designs at façade which can reduce noise transmitted into the housing units while allowing sufficient natural ventilation complying with the relevant statutory requirements. Having conducted studies and mock-up tests, the following special designs of windows or balconies are identified capable of offering sufficient ventilation and very effective in reducing road traffic noise transmitted into housing units.

2.1 Acoustic windows

There are different forms of acoustic windows. One of them is known as acoustic window (baffle type), which basically comprises 2 layers of openable windows separated by an air gap. The opened parts can be staggered on two sides with a vertical gap as shown in Figure 2 or on upper and lower portions with a horizontal gap as shown in Figure 3. For the former, the windows at the outer layer are normally side-hung windows which can be opened by pushing outwards while the window at the inner layer is sliding window. For effective noise reduction, the pane of the sliding window would be slid to the side behind the opened side-hung windows and the side-hung windows on the other side need to be kept close. Under such setting, only small portion of the noise reaching the opened side-hung windows can enter into the housing unit through the gap in-between the overlapping panes at both layers and then the opened part of the sliding window. At the same time, air flow can be maintained through the opened side-hung window, the gap and the opened part of the sliding window as well. The noise reduction mechanism for acoustic window with horizontal gap is basically the same as that for acoustic window with vertical gap.

After carrying out preliminary laboratory tests to demonstrate the noise reduction effectiveness of the acoustic windows with vertical gap, mock up units have been set up at a site to be developed for public housing to evaluate noise reduction and air ventilation performances. The mock up tests also aimed at evaluation of other issues like window cleansing, clothes hanging and maintenance etc with a view to facilitating the detailed design. The results of noise measurement at the mock up units facing the concerned highly trafficked road indicated that the achievable

noise reductions could be up to 8 dB(A) and the ventilation performance was also found to be satisfactory. The results of other studies indicate that the noise reduction effectiveness depends on a number of factors such as the gap width, the overlapping length and the sizes of the outer and inner openings etc.

For acoustic window with horizontal gap, the outer layer may simply be an opening on the upper part and the pane of the inner sliding window can be slid up and down. As the screen at lower position at the outer layer is very effective in shielding the traffic noise from street level, comparable noise reduction can be achieved even with a much wider gap between the inner and outer layer, which would probably allow for more ventilation.



Figure 2: Schematic diagram showing the working mechanism of acoustic window (baffle type)

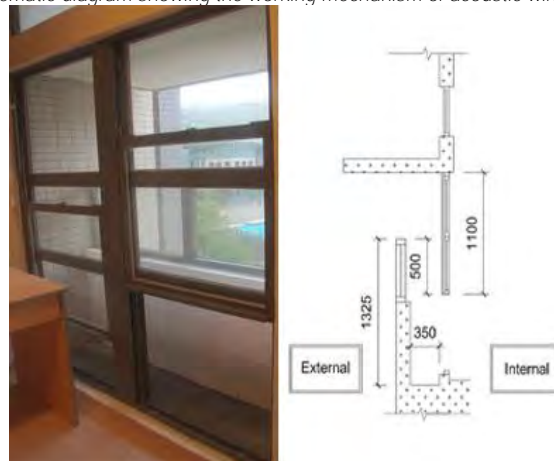

Figure 3: Acoustic window (baffle type) with horizontal gap

Another form of acoustic windows is known as acoustic window (top-hung type), which comprises top-hung windows as upper part close to ceiling and a horizontal panel projecting out from the frame and at the bottom of the windows as shown in Figure 4. The horizontal panel can act as an effective noise screen to reduce traffic noise propagating directly to the opening of the opened top-hung window and, hence, can greatly reduce the noise transmitting into the housing unit. As part of the noise is transmitted into the unit through single or multiple reflections by the pane and the horizontal panel, absorbent may be applied on the side of the pane facing inner and the upward side of the panel to enhance its noise reduction effectiveness. The noise reduction also depends on the height of the window and the extent of the horizontal panel. It is anticipated, with proper design, acoustic window (top-hung type) can achieve a noise reduction of 4-5 dB(A) or even more.

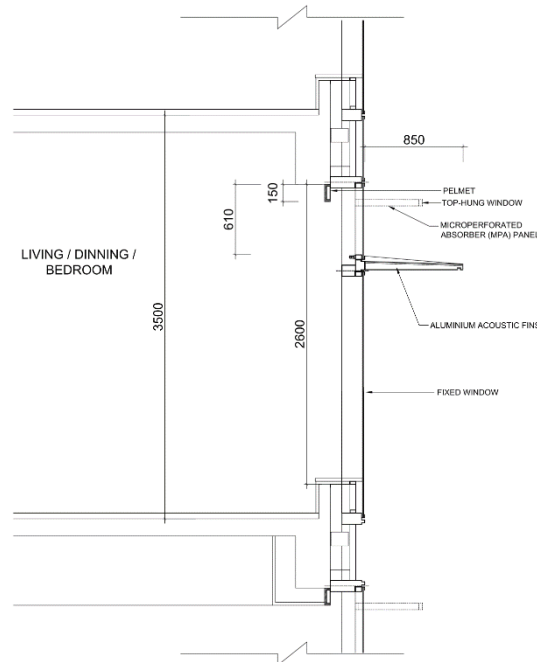

Figure 4: Schematic diagram of acoustic window (top-hung type)

2.2 Acoustic balconies

Balconies have been used in Hong Kong for long time. Features were added enabling noise reduction and hence could be adopted as a measure for mitigating traffic noise impact. The original design of acoustic balcony is just with solid parapets to screen off the noise from entering into the unit through the balcony door and with absorbents applied on the ceiling of the balcony to reduce the noise reflected by the ceiling to the balcony door. It is expected that such acoustic balcony can offer 2-3 dB(A) noise reduction. To enhance the noise reduction effectiveness, further additional features including extending the side parapets to full height side walls, providing a laminated glass panel projecting out from the top of the front parapet and adding sound absorption panels on side walls have been explored into the balcony design. Based on the results of noise measurements at mock up units, these additional features were found capable of offering significant extra noise reduction. Hence, the enhanced acoustic balcony were adopted and implemented in a public housing development in Sham Shui Po, Hong Kong as shown in Figure 5. The noise measurements at some completed housing units on different floors reveal that the noise reduction can be up to 5.5 dB(A).

However, for some extreme difficult cases with large noise exceedance, the above enhanced acoustic balcony is still not able to offer adequate noise reduction. Hence, efforts have been spent to study including other features to enhance the noise reduction further. It was found that, by putting a vertical panel above the front parapet and in front of the balcony door, the noise reduction can be increased significantly and may be above 10 dB(A) on higher floors.



Figure 5: Acoustic balcony in the public housing development in Sham Shui Po

3. LOW NOISE ROAD SURFACE

3.1 Low noise road surface on high speed road

The first trial of polymer modified friction course (PMFC) on a section of expressway was conducted in 1987 in Hong Kong to improve driving safety conditions under heavy raining situation, see Figure 6. Because of porous nature, PMFC brought along noise reduction which was mainly road tyre interaction noise. Measurements were conducted to study its traffic noise reduction performance. It was found that there would be around 5 dB(A) noise reduction in comparing the newly laid PMFC with the neighbouring brushed concrete surface. The maintenance records also indicated that the service life of PMFC on high speed roads was around 5 years .



Figure 6: First PMFC trial on high speed road in Hong Kong

As a result, noise abatement programme was embarked so that 11 kilometres of high speed roads were subsequently resurfaced with PMFC and was completed in 1999, bringing relief to about 16,000 dwellings. PMFC is now standard materials for high speed roads in Hong Kong for the dual effect of noise reduction and reduction of the potential for vehicles to aquaplane .

3.2 PMFC on local low speed roads

To investigate the applicability of PMFC on local low speed roads, some 60 existing road sections with different traffic conditions and road geometries were resurfaced with PMFC. Both noise reduction performance and durability performance were monitored for 5 years. The results showed that just after resurfacing, an average noise reduction was about 2.7 dB(A). From the monitoring data, it is considered that free flow traffic is almost a pre-requisition for PMFC to perform well in durability on local low speed road condition.

3.3 PMSMA6 on local low speed roads

Since not all local low speed roads are suitable for resurfacing with PMFC as locations with frequent stop-and-go etc. will induce repetitive shear forces on the PMFC surface causing development of defects and damage on the porous non-structural PMFC surfaces, following the recommendations of “**Review and evaluation of the low-noise road surface programme for low speed-roads in Hong Kong**”, thin layer asphalt in the form of polymer modified stone mastic asphalt of 6mm nominal maximum aggregate size (PMSMA6) was trial in different local low speed roads. It is noted that smaller aggregate size could generally achieve better noise reduction ability, stone mastic asphalt of 6mm nominal maximum aggregate size is selected as the base mix. Both noise reduction performance and durability performance are monitored.

3.4 CRSMA6 on local low speed roads

In parallel to trial of PMSMA6 on Hong Kong's local low speed road condition, feasibility of rubberized asphalt on local low speed roads is also reviewed and explored. Modification based on PMSMA6, rubberized asphalt in the

form of crumb rubber modified stone mastic asphalt of 6mm nominal maximum aggregate size (CRSMA6) will be explored in Hong Kong to investigate its field performance under local low speed road conditions.

This idea stemmed from reuse of waste rubber tyre in which on one hand looking for appropriate LNRS for noise reduction and on the other hand providing way out for waste rubber tyres saving space of our very precious and limited landfill areas.

4. CONCLUDING REMARKS

The Administration is committed to keep traffic noise at bay. The innovative noise mitigation designs such as acoustic windows and acoustic balconies are relatively new approaches for reducing traffic noise problems in Hong Kong. Adoption of these designs could offer noise attenuation effect while allowing natural ventilation. Apart from adopting proactive planning approach and also use of noise barriers, the Administration takes big steps forward in exploring use of LNRS particularly on local low speed roads. Different forms of LNRS have been tried and tested out with promising noise reduction results. With the provision of innovative noise mitigation building designs and LNRS, it is optimistic that an acceptable acoustical environment for residents in Hong Kong would no longer be out of reach.

REFERENCES

- [1] Environmental Protection Department, Hong Kong SAR: Spatial Distribution of Traffic Noise Problem in Hong Kong [online]. Retrieved from: <http://www.epd.gov.hk> [Retrieved on 13 September 2016].
- [2] Environmental Protection Department, Hong Kong SAR [online], Retrieved from: http://www.epd.gov.hk/epd/misc/ehk13/en/noise_spotlight.html [Retrieved on 26 September 2016]
- [3] Environmental Protection Department, Hong Kong SAR [online], Retrieved from: http://www.epd.gov.hk/epd/Innovative/greeny/eng/acoustic_window.html [Retrieved on 26 September 2016]
- [4] Environmental Protection Department, Hong Kong SAR [online], Retrieved from: http://www.epd.gov.hk/epd/Innovative/greeny/eng/recessed_window.html [Retrieved on 26 September 2016]
- [5] Yeung, M., Ng, I., Lam, J., Tang, S.K., Lo, D., Yeung, D., 2014. Tackling Traffic Noise Through Plenum Windows – An Application in Hong Kong, Internoise 2014, Melbourne Australia, 16-19 November.
- [6] Kwan, J.C.F., 1987. The Effect of Trial Overlay in Reducing Road Traffic Noise from the Island Eastern Corridor, Environmental Protection Department, Hong Kong SAR.
- [7] Kwan, R., 1993. Aging Effect of Open Textured Road Surface Material, Environmental Protection Department, Hong Kong SAR.
- [8] Trial Study on the Use of Friction Course as a Noise Mitigation Measure on Low Speed Roads, Report No. RD/TR/022, 1998. Highways Department, Hong Kong SAR
- [9] Lee, C.K., Leung, J., Ng, I., Yeung, M., 2013. Application on low noise road surface material to reduce road traffic noise of local roads in Hong Kong, Internoise 2013, Innsbruck, 15-18 September.
- [10] Guidance Notes on Noise Reducing Road Surfacing, Ref. RD/GN/011B, 2001. Highways Department, Hong Kong SAR
- [11] Ulf Sandberg, Review and Evaluation of the Low-noise Road Surface Programme for Low-speed Roads in Hong Kong, 2008. Environmental Protection Department, Hong Kong SAR.

Energy Efficiency for a Sustainable Built Environment in Nigeria

Susanne GEISSLER^a, Ene MACHARM^b

^a SERA energy & resources, Austria, susanne.geissler@sustain.at

^b German International Cooperation (GIZ), Germany, ene.macharm@giz.de

ABSTRACT

Nigeria is a fast growing economy but suffers from serious setbacks due to lack of power supply and the widespread use of ecologically and economically questionable private diesel and petrol generators accounting for over 50% of the active generation capacity. In 2013, the Nigerian Energy Support Programme (NESP) was set up to address and improve this situation. The Programme is implemented by the Deutsche Gesellschaft für Internationale Zusammenarbeit (GIZ) in cooperation with Nigerian partner institutions, and funded by the European Union and the German Government. It aims at improving the conditions for the application of and investments in **renewable energy and energy efficiency as well as the promotion of rural electrification**. Part of the Programme's activities is on energy efficiency in buildings, to ensure that electricity is saved through concrete measures like contributions to shaping the framework conditions and the implementation of pilot projects as a promotion and awareness creation mechanism.

This conference contribution reports on the approach and on the achievements accomplished so far in the building area. Key to success in developing framework conditions and related procedures is a participatory approach to ensure acceptance and feasibility, the focus on achieving actual energy savings, and the creation of an enabling environment for implementation and roll-out.

Keywords: affordable housing, energy saving, building code

1. INTRODUCTION

1.1 Content of this contribution

This contribution presents the Nigerian Energy Efficiency Support Programme (NESP), and specifically the activities and results achieved so far in the building area. It presents the general objectives of NESP, and continues with the activities in the building sector. Chapter 2 starts with describing the status on the ground, to better understand the setup of the programme presented in chapter 3.

Chapter 4 shows a key result, namely the Nigerian Building Energy Efficiency Guideline (BEEG), and chapter 5 continues with the Nigerian Building Energy Efficiency Code currently under development. The contribution concludes with a short outlook.

1.2 Objectives of the Nigerian Energy Support Programme

The overall objective of the Nigerian Energy Support Programme (NESP) is to improve the framework conditions for the application and investment in renewable energy, energy efficiency, and rural electrification. Specifically, it is the objective to ensure that concrete energy efficiency measures generate energy savings and contribute to reducing the load on the electricity grid. In Nigeria, the residential sector accounts for about 78% of the final energy consumption and consumes around 58% of the total electricity consumption. This situation compounded with the over 17 million units housing deficit in Nigeria certainly explains the urgent need for interventions to improve the conditions in the following areas (GIZ NESP, 2015 and GIZ NESP, 2014):

Policy: As the policy framework was not existing, NESP supported in developing an energy efficiency policy with an energy efficiency action plan as the implementation mechanism. The policy outlines target activities such as developing building energy codes and guidelines.

Standards: Standards on energy efficiency in buildings do not yet exist as the building code in Nigeria only **addresses structural strength and fire safety**. It is the intention of Nigeria's Government to integrate energy efficiency standards into the already existing building code in order to reduce building energy consumption.

Awareness Creation: Awareness creation could lead to more interest on energy efficiency issues, hence NESP focuses on implementing pilot projects on energy efficiency measures that demonstrate the technical and economic feasibility of energy efficiency, while also implementing public campaigns targeting specific stakeholders to increase knowledge on the benefits of energy efficiency.

Training: Knowledge on energy efficiency in buildings is lacking as many experts are not qualified in the area of energy efficiency concepts and technologies. NESP has developed curricula and handbooks on energy efficiency in building design, energy audit, and energy management. NESP is supporting training institutions with these curricula and handbooks and would train them as trainers in the sector.

2. STATUS ON THE GROUND: OVERVIEW OF THE NIGERIAN BUILDING SECTOR

2.1 Building legislation

The current building code dates from 2006 and does not address energy efficiency and renewable energy use. It is a set of rules to be implemented and enforced by regional governments, currently mainly referring to the structural system, general safety, and fire safety.

While in rural areas legislation is practically non-existent, in urban areas, the building codes and building permit procedures are relevant, except small buildings defined by building area or by building volume. However, building laws are not sufficiently respected, and there is lack of enforcement. People have disregarded the existing code, and often the control that should come from the responsible ministries is very ineffective because of corruption.

The causes of non-compliance with the legal framework are essentially related to:

- The lack of staff for the monitoring of construction sites;
- The lack of sanctions in proven cases of violation of the regulations constituting bad examples which impact on the decision for new constructions;
- The lack of information and communication on the one hand, the lack of good practices in terms of housing on the other hand, also regarding the laws regulating the materials and methods of construction in the built environment;
- The poverty of households;
- The corrupt practices.

The advert effect has been frequent collapse of buildings, water leakages, and abuse of set-back lines. However, there is awareness of this problem, and awareness of the need for improvement regarding compliance and control, and enforcement.

2.2 Energy utilisation in Nigeria's building sector

Availability of data for policy making is a prerequisite, and efforts for data gathering must follow a coordinated approach, meaning that data gathering must be institutionalised in responsible agencies. The National Bureau of Statistics mission is to generate, on a continuous and sustainable basis, socio-economic statistics on all facets of development in Nigeria. However, data on building energy consumption is not yet readily available (National Bureau of Statistics, n.d.).

With a population of over 170 million, Nigeria is the most populous country in Africa and the eighth most populous country in the world. According to the United Nations, one in six Africans is Nigerian. The population growth rate is projected to be between 2.5 and 2.7% per annum in the next 20 years. The population of Nigeria is therefore forecast to potentially grow to 310 million by 2035 (GIZ NESP, 2015). The present Government has committed to construct 17,760 houses annually as a short term plan to meet the over 17 million units housing deficit. With the population growth and the increased access to technology it is expected that building energy consumption will continue to increase. This stresses the importance of implementing energy efficiency measures in the building sector and particularly in the residential sector. In the residential sector, tenement, compound, bungalows, and block of flat housing types are the dominant housing options available to households in Nigeria. Also, the majority of rental and ownership households are concentrated in buildings considered old fashioned, while only a small

number of ownership households occupy block of flat buildings accompanied with modern facilities and services commonly found in high-income neighbourhoods of Lagos, Abuja, and Port Harcourt.

Most buildings occupied by the higher proportion of households in Nigeria are considered to be over aged and some are in need of renovation and timely maintenance. Governments have low impact on housing provision in Nigeria as the majority of buildings are owned by individuals, family, cooperative groups and societies, as well as multinational real estate companies.

Regarding electricity supply, Nigeria depends on thermal and hydro power plants for its energy production. According to Nigeria Electricity Regulatory Commission (NERC) statistics, 80% of actual generation capacity in 2015 comes from gas based power plants, while the remaining electricity comes from hydro power plants (GIZ NESP, 2015). **However, Nigeria's peak energy generation amounts only to a maximum of about 5,000MW with a peak demand forecast of almost 13,000MW and 10,000MW off peak, meaning that the electricity supply of about 60 million Nigerian relies on private diesel and petrol generators (Federal Ministry of Power, n.d. and GIZ NESP, 2014).**

Regarding energy consumption, around 85% of Nigeria's consumed energy comes from biofuels and waste. Almost 90% of that energy is consumed for residential usage. Similarly, based on data from the International Energy Agency, residential usage accounts for about 58% of the final electricity consumption in Nigeria. Likewise, it is the residential sector (households) where the increase over the ten-year period is evident (GIZ NESP, 2015).

3. SETTING UP THE ENERGY EFFICIENCY IN BUILDINGS COMPONENT OF NESP

3.1 Basic requirements

Wide application of energy efficiency requires a policy framework and legislation imposing energy efficiency minimum requirements. However, requirements will only be respected when controlled and enforced, and efforts for control and enforcement will be only feasible if there is societal support for the legal obligation. Societal support will emerge from understanding the challenges in the electricity sector and energy efficiency legislation as a means of problem solving. Thus, case studies are important to demonstrate technical and economic feasibility, and trainings are essential to further qualify those active in the construction and real estate business as well as civil servants concerned with checking, control and enforcement. Energy efficiency for a sustainable built environment in Nigeria is achievable by engaging the right stakeholders in all activities to ensure buy-in of energy efficiency concepts.

3.2 Modules of the energy efficiency in buildings component of NESP

The energy efficiency in buildings component in NESP is based on three pillars:

- Stakeholder involvement and awareness creation to generate societal support for the new framework conditions and legal requirements to come.
- The development of standards such as an energy building code regulating energy efficiency in the building sector.
- Implementation of pilot projects to demonstrate feasibility of complying with the new requirements.

An essential element of the first pillar is the Building Energy Efficiency Guideline (BEEG). It provides useful information to professionals in the building sector on key factors to consider when implementing energy efficiency measures in Nigerian buildings. BEEG was launched in June 2016 by the Federal Ministry of Power, Works and Housing with the support of NESP and the EU. More information is provided in chapter 4.

The Building Energy Efficiency Code (BEEC) mentioned above is an essential element of the second pillar and is currently under development. It is developed in cooperation with the Federal Ministry of Power, Works and Housing and Department of Development Control (AMMC) Federal Capital Territory Administration Abuja, as the Federal Code is adopted and implemented on states level. Implementation in Department of Development Control (AMMC) Federal Capital Territory Administration Abuja will be voluntary at first, in order to gain experience and improve procedures prior to imposing legal obligations. More information is provided in chapter 5.

Pilot projects demonstrate feasibility of complying with the new requirements and create material for dissemination to various stakeholder groups. Currently, the following pilot projects are being carried out:

- A Solar Water Heater (SWH) pilot project is being implemented with the aim of demonstrating the technical and economic feasibility of solar water heating technologies. By end of 2016, the SWH systems (68 units and 212 m² module area) of thermosiphon flat plate collectors will be installed at a boarding secondary school in Jos (Plateau State) to cater for the bathing needs of 1,000 students. The objective of the pilot project is to increase the use of solar water heaters in boarding schools in Nigeria, and to educate students on solar energy utilisation.
- In 2016, an Energy Audit of the Federal Ministry of Power, Works and Housing building was conducted. Based on the building energy use analysis and the audit results, it was observed that there is much room for improving energy efficiency. Recommendations for energy management in the building include low cost, medium cost and high cost energy efficiency measures. The objective of the pilot project is to increase awareness on energy management and the related benefits in public buildings and to provide a template for carrying out similar energy audits in other public buildings.

4. BEEG: BUILDING ENERGY EFFICIENCY GUIDELINE

The first Nigerian Building Energy Efficiency Guideline (FMPWH-NESP, 2016) includes a general introduction of energy efficiency in buildings at the beginning. Then it divides technically into two parts, namely active and passive elements of energy efficient building, and presents a design guideline how to proceed in building design to achieve an energy efficient building in Nigeria.

The Guideline also includes a description and assessment of building energy simulation and calculation tools as well as whole building design tools and sustainability certification models used globally. The regulatory framework necessary for the implementation of building energy efficiency in Nigeria is presented, and regional hazard to consider when designing buildings in Nigeria is discussed.

The Guideline concluded most importantly with case studies on building typologies, in order to assess and quantify the status quo of calculated energy demand and the impact of specific energy efficiency measures, showing how to improve on future building energy efficiency standards. The building typologies and climate conditions analysed in the case studies have been defined together with Nigerian architects and builders. Because of the lack of data it was not possible to follow a bottom-up approach but it was necessary to apply a model approach based on **experts' knowledge. The following building types were analysed: residential buildings (bungalow and apartment)** and office buildings (small and large). Two climatic zones have been tested for the building typologies, namely hot and humid climate and hot and dry climate. Although Nigeria has 6 geopolitical zones and 4 climate zones according to Köppen climate classification, the Guideline distinguishes only roughly between the two climates mentioned above. Simplifications were also necessary due to budgetary reasons. In order to define the impact of energy efficiency measures on each building type, a Building As Usual (BAU) scenario was defined for each typology. The BAU represents the usual construction practice in Nigeria and was derived mainly from responses to questionnaires circulated to construction professionals in Nigeria including local knowledge. Three variants on the BAU were modelled with incremental energy efficiency improvements following the concept of energy efficiency hierarchy: to reduce energy demand by passive measures, and to supply remaining energy demand by energy efficient active technologies.

The defined variants for the guideline are:

- Variant 1: Reducing energy demand by simple implementable measures, e.g. improving orientation, optimising window sizes.
- Variant 2: Variant 1 with additional measures, e.g. insulated walls, double glazing.
- Variant 3: Variant 1 and 2 with additional measures such as PV installation to generate electricity.

The simulation tool used for the analysis was DesignBuilder version 3, a whole building dynamic energy simulation tool using the software energy plus for calculating annual energy consumption of building designs. It also has the capacity of analysing both passive and active energy efficiency measures. The main outputs presented in the Guideline are annual energy consumption, annual energy cost, CO₂ emissions reduction, and hours of thermal comfort.

The Guideline promotes the objective of bioclimatic design strategies for Nigeria, in order to minimise heat gains and to promote heat loss by means of building orientation facing mainly north and south with overhangs or external shading. These are the most cost effective measures as they require no or low additional investment cost which is of paramount importance for societal support and wide spread application of energy efficiency in building.

5. BEEC - BUILDING ENERGY EFFICIENCY CODE

The starting point for developing the Nigerian Energy Efficiency Building Code (BEEC) was the analysis of existing energy efficiency building codes implemented in countries on all continents and evaluation studies if available.

Among others, the European Concerted Action on the Energy Performance of Buildings Directive (EPBD) and the EU-funded QUALICHeCK project provided important insight and ideas for discussing the specification for the development of the BEEC with Nigerian Stakeholders (EPBD-CA, 2016 and QUALICHeCK, 2016).

Usually, building energy codes consist of the following elements:

- Scope of the energy building code
- Definition of cost optimum energy performance minimum requirements and calculation methods how to determine them
- Publication of the assessment result (e.g. Building Energy Declaration: DEC, Energy Performance Certificate: EPC, Building Energy Rating: BER)
- Qualification requirements for experts issuing EPCs, BERs or DEC
- Control system, penalties and enforcement

In Nigeria, the challenges for developing a building energy code are manifold:

- There is a lack of knowledge how to plan and construct energy efficient buildings.
- There is a lack of standardised and quality assured materials and products needed for energy efficient buildings.
- The energy building code should avoid increasing investment cost for mass housing, at least in the beginning (urgent need for affordable housing).
- There is a lack of data to determine the status quo of energy efficiency and thus difficulties in determining energy performance minimum requirements.
- Cost optimum levels are nearly impossible to define because of lack of transparency and problems with corruption.
- Input data for energy performance calculations are hardly available or difficult to access.
- Qualification of experts entitled to issue energy performance certificates is an enormous challenge.
- Another huge challenge is the qualification of civil servants entitled with checking whether the building design and the completed building complies with the energy regulation.
- The difficult economic situation of the country is another problematic aspect.

The high importance of affordable housing puts simple but effective no-cost measures to the fore, such as correct building orientation to avoid solar gains and facilitate heat losses, and choosing the correct arrangement of windows (bioclimatic building design), in order to reduce cooling demand.

This creates additional challenges, namely the need to coordinate the approach with urban planning procedures, and the need to agree on the use of calculation tools suitable for taking into account sun exposure of facades depending on orientation and other site-specific features such as natural shadowing.

All these difficulties explain why the code will be voluntary at first, and compliance with the code will be rewarded with incentives. Nevertheless, the code should be developed as a fully functional framework to be implemented on the level of pilot cases, in order to gain experience and create awareness on new necessary building requirements and how to achieve them. Voluntary systems precede mandatory systems to give stakeholders the chance to learn and adapt.

Because of the expected fast increasing electricity consumption and the limited generation capacity lagging far behind demand, energy efficiency requirements clearly refer to the completed building and not only to the building

design. It is of paramount importance to increase energy efficiency in reality. It is also evident that the code will only be effective if regularly controlled. In this regard it is planned to entitle civil servants involved in checking building documents and completed buildings and issuing building permits and permits of use to also check whether energy efficiency minimum requirements are met. In Nigeria, the responsible public authority is called Development Control. Collaboration with the Department of Development Control (AMMC) Federal Capital Territory Administration Abuja will be crucial for developing a solution effective in the Nigerian environment. Integrating energy efficiency compliance checks in the daily routine of Development Control will require a substantial training effort.

6. CONCLUSION AND OUTLOOK

Implementation of building energy efficiency codes is essential for improving energy efficiency in the building sector. In 2013, interviews were carried out during the SEEA-WA project in most ECOWAS countries to investigate the status quo regarding energy efficiency building codes and to collect information about the most important barriers for developing and implementing such codes. The results showed that the major problem is not only the lack of legislation but the fact that laws are transferred from abroad, usually from Europe or from America, and are not sufficiently adapted to the needs of the respective country (ECREEE, n.d.).

Thus, BEEC development builds upon the prevailing conditions, and strongly considers local resources and skills available in Nigeria. Energy efficiency for a sustainable built environment is achievable by engaging the right stakeholders to ensure buy-in of energy efficiency concepts. In addition to building related requirements and frameworks conditions to encourage the uptake of energy efficiency measures, monitoring and enforcement procedures must be put in place.

It is important to plan monitoring and control procedures right from the beginning, in order to ensure that verification procedures proving that energy minimum requirements are met can be carried out with justifiable effort. These procedures serve to ensure quality, and if necessary to enforce compliance, in order to create an impact and actually increase energy efficiency.

Because of the enormous housing demand, financing options and the implication of the energy efficiency code to be developed have to be borne in mind. On the one hand, affordable housing for the middle-income class is a key issue for achieving development goals, and specification of minimum energy efficiency requirements has to respect this prerequisite. It must be considered that the projected time horizon for payback from energy efficiency measures is short, due to the rather insecure political environment. On the other hand, energy efficiency minimum requirements must be sufficiently ambitious to qualify buildings compliant with the code for financing with new financing instruments such as climate bonds (Climate Bonds Initiative, n.d.).

REFERENCES

- [1] Climate Bonds Initiative, n.d.. Residential Property Climate Bonds Certification methodology. Retrieved from: <http://www.climatebonds.net/low-carbon-buildings-criteria> [Retrieved on 29 September 2016].
- [2] ECREEE, n.d.. Supporting Energy Efficiency Access in West Africa (SEEA-WA) Project [online]. Retrieved from: <http://www.ecreee.org/page/supporting-energy-efficiency-access-west-africa-seea-wa-project-funded-european-union> [Retrieved on 29 September 2016].
- [3] EPBD-CA, 2016. Outcomes 2011-2015 [online]. Retrieved from: <http://www.epbd-ca.eu/ca-outcomes/2011-2015> [Retrieved on 29 September 2016].
- [4] Federal Ministry of Power, n.d.. [online]. Retrieved from: <http://www.power.gov.ng> [Retrieved on 29 September 2016].
- [5] FMPWH-NESP, 2016. (2016). Building Energy Efficiency Guideline for Nigeria (BEEG), released by the Federal Ministry of Power, Works and Housing, Abuja. Retrieved from: <http://www.energyplatformnigeria.com/index.php/library/energy-efficiency> [Retrieved on 29 September 2016].
- [6] GIZ NESP, 2014. Energy Efficiency in Buildings (EEB) in Selected Sub-Sectors of the Nigerian Building Sector: Development of recommendations for interventions to promote energy efficiency in buildings, May 2014. Retrieved from: <http://www.energyplatformnigeria.com/index.php/library/energy-efficiency> [Retrieved on 29 September 2016].

- [7] GIZ NESP, 2015. The Nigerian Energy Sector. 2nd Edition, June 2015. Retrieved from: <http://www.energyplatformnigeria.com/index.php/overarching> [Retrieved on 29 September 2016].
- [8] National Bureau of Statistics, n.d.. [online]. Retrieved from: www.nigerianstat.gov.ng [Retrieved on 29 September 2016].
- [9] QUALICHeCK, 2016. Project Results [online]. Retrieved from: <http://qualicheck-platform.eu/results/reports/> [Retrieved on 29 September 2016].

Session 4.4: Processes of High-Performance Green Buildings

What Are The Most Effective Drivers of Sustainable Development in The Decision Making Process

Hanne Tine Ring HANSEN^a, Mary-ann KNUDSTRUP^b

^a Søren Jensen, Denmark, hrh@sj.dk

^b Aalborg University, Denmark, mak@create.aau.dk

ABSTRACT

The identification of the most effective drivers of sustainable development is a focal point for most – if not all – policymakers and companies interested in sustainable development. Whilst the answer to this is of course very **contextual this paper presents a practitioner's review of the political and voluntary drivers for sustainable building** in Denmark.

The paper identifies the most influential drivers for sustainable development in the Danish Building industry by combining a review of the regulatory political drivers in Denmark with two market surveys for construction clients from 2015 and 2016. The result of these surveys is compared to professional experiences from a number of sustainable Danish building projects completed or initiated in between 2008 and 2016.

It is the conclusion of this paper that whilst the regulatory drivers for energy and health are important when it comes to initiating and sustaining the market demand for sustainable buildings it is actually the economic and social drivers for sustainable building, such as life cycle costs, futureproofing of investments, better quality and Corporate Social Responsibility (CSR), **that have the greatest impact on construction clients' decision-making processes.** The paper **furthermore reflects on how drivers for sustainable development vary depending on the construction client's** planning perspective and how the contractor is engaged in the project.

Keywords: policy and regulation, drivers for sustainable development, strategy development

1. INTRODUCTION

Political and voluntary drivers of sustainable development are essential to whether humankind succeeds in its endeavour to create a more sustainable future in which future generations will not have to pay for the previous and **current generations' over-consumerism** and environmental negligence. If these drivers are too ambitious, people give up on delivering the goals set by the policymakers and if the drivers are too conservative the drivers become obsolete or victim of ridicule. By identifying the most effective drivers of sustainable development the chance of finding the right balance between political and voluntary drivers increases.

The following pages will provide readers with an insight into how regulatory and voluntary drivers are perceived by a Danish professional practitioner from the building industry who draws on experiences from more than forty different decision making processes relating to sustainable building design.

2. POLITICAL DRIVERS FOR SUSTAINABLE BUILDING DESIGN

When it comes to political drivers for sustainable development the UN and the EU have a history of providing effective political drivers for sustainable development. The UN has had a great impact on sustainable development through publications like the Brundtland Report and the fourth assessment report from the IPCC panel whilst the **EU has made a significant impact on its member states' energy-efficiency** and CO₂ reductions in the Building Sector.

From a Danish building practitioner's point of view, the following EU policies have had the largest impact on sustainable development in the Danish building sector until 2016; the 2010 Energy Performance of Buildings Directive and the 2012 Energy Efficiency Directive. The past two years have also demonstrated how the voluntary UN Global Compact and EU directive on Non-Financial Reporting have established an increased awareness about social, as well as, economic and environmental sustainability with construction clients and tenants. This has

increased the market demand for sustainable buildings and changed the scope of sustainable building design from energy-efficiency towards a recognition of more holistic sustainable solutions. Last but not least the EU's focus on circular economy, the 7th Framework Programme and the Integrated Product Policy have 1) Provided building designers with incentives to design buildings for low-impact and for disassembly and reuse, 2) Caused the Danish government to change its policies on waste management in general and on construction projects and 3) Provided building product manufacturers with incentives to ensure recycling of resources and the use of renewable energy in their manufacturing processes.

3. VOLUNTARY DRIVERS

Since the mid-1980s when the concept of a 'low-energy building' was introduced in the Danish Building Regulations Danish building designers and construction clients have had voluntary schemes that have ensured improved the energy-efficiency of the Danish building sector. The scope for sustainability was broadened in 2006 when the Nordic Ecolabel (also known as the Swan Label) was introduced for single family homes in a Danish project titled 'Future Single-family Homes'. During the period leading up to the release of the Danish version of the DGNB system in 2012 Denmark saw the first BREEAM International and LEED registered projects and the transformation from low-energy towards a more holistic approach to sustainable building design was complete.

Despite having a nationalised adaptation of the DGNB system available and despite the fact that the LEED system is not the most ambitious certification system in a Danish context some companies still choose to adhere to the LEED system when it comes to sustainable building certification or company policies on sustainable building concepts. Based on experiences with companies like these it is this author's experience that the reasoning behind this choice is strategic and market driven rather than ignorance.

In 2015, the Danish Association of Construction Clients (DACC) conducted a market analysis of how 1) Construction clients, 2) Consultants, 3) Contractors and building product manufacturers perceived sustainability. The survey results are available at DACC's webpage and the results of the survey show that:

- 65% of construction clients regard the term sustainability as a relevant issue in their project organisations
- 62% of the construction clients define their approach to sustainability as a holistic and integrated approach to sustainability and that 53% of the construction clients define their approach to sustainability to include energy-efficiency
- The construction clients identify life cycle costs (LCC) (61%), total value (51%), branding (54%) and future regulatory requirements (32%) as drivers for sustainable development.

In 2016, the Danish Green Building Council followed up with a market analysis in which:

- 75% percent of the construction clients revealed that they expect the demand for sustainable buildings to increase and 25% expect the demand to remain at its current level.
- The construction clients with experiences with sustainable construction were asked to identify which of the following drivers that motivated them to choose sustainable building certification: environmental considerations (65%) lifecycle costs (48%), CSR (44%), Innovation (41%) Future regulations (37%), Fewer construction and design mistakes and a leaner process (27%), Increased sale and leasing opportunity (24%), increased market value (20%), increased demand for sustainable buildings (20%), 3rd party verification (17%).

The answers to these surveys demonstrate that whilst environmental benefits, as well as, current and future **regulatory and voluntary drivers are considered important by construction clients' they also place great emphasis** on economic drivers as well as tenant requirements which typically focus on social- and economic considerations such as operation costs, indoor climate and health. It is also worth noticing that the market analysis from 2015 did not focus on identifying the drivers of sustainable development but rather the main motivation and that the answers were slightly limited by the pre-defined answers in the survey.

4. THE IMPORTANCE OF MARKET, CULTURE AND ORGANISATION

4.1 The importance of market scope

The market scope of the construction client or tenant is essential when it comes to sustainable development where multinational co-operations or multi-nationally funded or insured co-operations in Denmark tend to choose the American LEED system whilst the nationally focused co-operations and organisations adhere to the Danish version of the DGNB system. The general impression of the development in Denmark is that LEED and DGNB are the main players in the market and other systems like the Swan Label, the Passive House and Active House concepts also appeal to some construction clients. This was confirmed in the DACC market analysis from 2015 where the construction clients have answered that 0% favour BREEAM, 14% favour LEED, 71% favour DGNB and 29% favour another system.

Sustainability consultants thus experience different market-driven approaches to voluntary certification schemes: 1) Nationally focused clients that choose to comply with the Danish version of the DGNB system, 2) Multi-national co-operations that choose to adhere to the LEED system because that simplifies their decision making process and thus their building design paradigm 3) Multi-national co-operations that choose to adhere to the scheme that is the preferred, and often most ambitious scheme, in the country where they planning a new project and 4) Multi-national co-operations or national co-operations that wish to comply with more than one scheme e.g. both the Danish DGNB scheme and the American LEED scheme.

Market scope and uniformity are thus important motivators when it comes to voluntary schemes that promote drivers of sustainable development. This also means that the voluntary drivers of sustainability vary a lot from project to project.

4.2 The importance of culture

When looking at the number of buildings in Denmark that have either undergone certification or that are registered for certification there is an increase in the number of tenders and projects that request sustainable building certification. However, if one only regarded the number of projects registered for certification one might think that neither DGNB nor BREEAM or LEED is very popular in Denmark when in fact most construction clients or tenants request sustainability these days. The difference between the Danish market and international markets with a large percentage of certified buildings can be ascribed to the fact that Danes are still a very trusting people. Because of that they regard certification as a stamp of approval of something that they expect their consultants and contractors to comply with regardless of whether or not they request building certification.

This means that voluntary building certification becomes a motivational driver when the construction client or tenant either 1) Wishes to brand his/her property via third party certification or 2) Wishes to change business as usual and challenge his/her organisation, consultants and contractors to improve their performance towards a more sustainable development. The latter is especially true for clients that take CSR reporting seriously and thus have a need to monitor and report progress. It is also interesting that, after having worked for the same companies more than once and having seen multiple tender material from the same clients, a lot of developers and municipal construction clients start out with the first type of motivation and end up with the latter. This is a testament to the fact that once they gain a better understanding of their approach to sustainability they start to use it as a developmental driver.

4.3 The importance of project organisation

Sustainable development is closely related to change management in the sense that sustainable development is about challenging the status quo and ensuring a change towards a more sustainable development. This means that ownership and communication are essential success parameters that one needs to consider when designing a project organisation for sustainable building project. Experiences with both successful and non-successful processes for decision making on sustainable building projects have verified that this is definitely the case when it comes to sustainable development in the building sector.

If the project organisation does not support a shared ownership or the person responsible for realising the sustainability strategy are placed inappropriately in the project organisation the drivers for sustainable development

change during the process at the risk of compromising the original intent behind the selected drivers. This means that the project organisation greatly influences the relevance and appropriateness of the drivers of sustainable development and whether the sustainability strategy for a given project is realised.

When deciding on a project organisation and a type of tender (i.e. turn-key vs. main-contractor vs. multiple individual contractors) one must therefore consider what motivates the different stakeholders at their given role in the project. Sustainable development is possible no matter the selected type of tender but it is important to be aware of motivational factors and how to ensure ownership with all stakeholders and actors involved in the process when designing the tender material.

Table 1 provides an overview of the experienced drivers for construction clients and an overview of the experienced drivers for contractors depending on the type of tender. The tables are based on experiences with more than forty cases of which at least twenty have either undergone BREEAM, LEED or DGNB certification or used the systems as a strategic tool whilst other projects have included a bespoke evaluation system that builds on one or more of these schemes. The table content for each type of project organisation has been generalised which means that the majority of the evaluated projects correspond with the experiences.

Generally, there are two types of construction clients; 1) Short-term perspective clients and 2) Long-term perspective clients. Short-term perspective construction clients are clients that build with the intent to sell (e.g. developers) whilst long-term perspective clients are clients that build and operate their own buildings (e.g. municipal, regional and social housing organisations).

Contractors are engaged in many different ways and at both early and late stages of the planning process. Generally, the earlier the contractor engagement the better the chance of realising holistic sustainability strategies. Four different types of contractor engagement are used in Denmark; 1) Turn-key contraction, 2) Main contraction, 3) Individual contraction and 4) Public and Private Partnership contraction. Of these four the Public and Private Partnership is the only type of contractor engagement that ensures a strong engagement in drivers for sustainable development in a long-term perspective because the contractor takes on the role of the building owner where he needs to ensure the building operation in a long-term perspective.



Table 1: The experienced correlation between planning perspective and motivational drivers for sustainability and the experienced correlation between type of tender and contractor's motivational drivers.

5. REFLECTION

This paper compares the practical experiences of a practitioner specialised in sustainable building design with political and voluntary drivers in the Danish building sector.

When creating strategies for sustainable building projects Construction clients and client consultants need to be very careful when designing their project organisation and tender material. Drivers for sustainable development must be identified and prioritised in the initial ideation stage of all projects and an implementation strategy must be developed for the selected project organisation and the type of tender. Contractor motivation must be considered **in this process to ensure that the Construction Client's drivers for sustainability also motivates the contractor** (e.g. by early engagement of the contractor or financial incentives to perform better).

When it comes to the political drivers for sustainable development a lot of clients are not conscious of EU or UN enforced drivers. They do however still have an impact **on the construction client's decision making because they** are influential of the Danish building regulations which the market analyses from 2015 and 2016 have verified that construction clients are very much aware of.

When reflecting on which drivers are the effective it is positive to see that the political drivers and the voluntary drivers together ensure a market demand that in turn engage construction clients and tenants to implement voluntary schemes in their projects. In the past decade, the market reached a tipping point where voluntary economic and social drivers of sustainable development became strong and well-known drivers for sustainable building. Energy efficiency of buildings is still a strong driver but that has more or less become a standard requirement in all building projects which motivates construction clients to differentiate themselves more on the social and economic drivers.

Education of construction clients is also relevant due to the importance of early identification and implementation planning of motivational drivers. Today the client consultant, the architect or engineer takes on the role of educator **which means that the construction client's knowledge is limited to the expertise of the consultants engaged on the project.**

REFERENCES

- [1] Active House, Active House [Online] Retrieved from: <http://www.activehouse.info/> [Retrieved on September 30, 2016]
- [2] BRE, BREEAM [Online] Retrieved from <http://www.breeam.com/> [Retrieved on September 28, 2016]
- [3] Bygningsreglementet.dk, Bygningsreglementet 1985 [online] Retrieved from http://w21.dk/file/502104/br_femogfirs.pdf [Retrieved on September 28, 2016]
- [4] Danish Association for Construction Clients, Hvidbog [Online] Retrieved from <http://www.bygherreforeningen.dk/projekter/baeredygtighed-i-byggeriet> [Retrieved on September 28, 2016]
- [5] Danish Green Building Council, an introduction to DGNB [Online] Retrieved from: <http://dk-gbc.dk/publikationer/an-introduction-to-dgnb/> [Retrieved on September 27, 2016]
- [6] Danish Green Building Council, Markedsundersøgelse 2016 [Online] Retrieved from http://www.dk-gbc.dk/media/2100/markedsundersogelse_web.pdf [Retrieved on September 28, 2016]
- [7] Ecolabel.dk, Bygninger [online] Retrieved from <http://www.ecolabel.dk/da/produkter/byg-og-bolig/bygninger> [Retrieved on September 28, 2016]
- [8] European Commission, 7th Framework Programme [Online] Retrieved from https://ec.europa.eu/research/fp7/index_en.cfm [Retrieved on September 28, 2016]
- [9] European Commission, Energy Efficiency Directive [Online] Retrieved from: <http://eur-lex.europa.eu/legal-content/EN/TXT/?qid=1399375464230&uri=CELEX:32012L0027> [Retrieved on September 28, 2016]
- [10] European Commission, Energy Efficient, Buildings [Online] Retrieved from: <https://ec.europa.eu/energy/en/topics/energy-efficiency/buildings> [Retrieved on September 28, 2016]
- [11] European Commission, Energy Performance of Buildings Directive [Online] Retrieved from: <http://eur-lex.europa.eu/eli/dir/2010/31/oj> [Retrieved on September 28, 2016]
- [12] European Commission, Environment [Online] Retrieved from: http://ec.europa.eu/environment/index_en.htm [Retrieved on September 28, 2016]
- [13] European Commission, Integrated Product Policy [Online] Retrieved from <http://ec.europa.eu/environment/ipp/epds.htm> [Retrieved on September 28, 2016]

- [14] European Commission, Non-financial Reporting [online] Retrieved from: http://ec.europa.eu/finance/company-reporting/non-financial-reporting/index_en.htm [Retrieved on September 28, 2016]
- [15] European Commission, Towards Circular Economy [online] Retrieved from: https://ec.europa.eu/priorities/jobs-growth-and-investment/towards-circular-economy_en [Retrieved on September 28, 2016]
- [16] Intergovernmental Panel on Climate Change, Fourth Assessment Report [Online] Retrieved from <http://www.ipcc.ch/report/ar4/> [Retrieved on September 28, 2016]
- [17] Kotter, J. P 2012, Leading Change, USA.
- [18] Passiv Haus Institute, Home [Online], Retrieved from: <http://www.passiv.de/> [Retrieved on September 30, 2016]
- [19] United Nations, Our Common Future [Online] Retrieved from: <http://www.un-documents.net/our-common-future.pdf> [Retrieved on September 28, 2016]
- [20] United Nations, UN Global Compact [Online] Retrieved from: <https://www.unglobalcompact.org/> [Retrieved on September 28, 2016]
- [21] US Green Building Council, LEED [Online] Retrieved from <http://www.usgbc.org/leed> [Retrieved on September 28, 2016]
- [22] US Green Building Council, LEED project directive [online] Retrieved from <http://www.usgbc.org/projects> [Retrieved on September 28, 2016]

German ÖKOBAUDAT Goes International: An Online Infrastructure for LCA as a Basis for International Structure

Tanja BROCKMANN^a

^a BBSR Federal Inst. for Research on Building, Urban Affairs and Spatial Development, Germany, tanja.brockmann@bbr.bund.de

ABSTRACT

LCA at building level is a central instrument for the evaluation of the ecological quality of the building (e.g. global warming potential). In Germany, the federal government provides the online database ÖKOBAUDAT (open source) which supplies the required building materials datasets (Generic data, EPD data) and the calculation tool eLCA for LCA at building level.

ÖKOBAUDAT meets the demands of EN 15804, but also follows an extended ILCD format. As an internet aware data format, it has been designed to explicitly allow publishing and linking of data as resources via the internet. The advantage is that existing software tools with built-in support for the ILCD-format can be easily enabled to support the new EPD datasets. Internationally more and more EPD are produced (According to EN 15804). The possibility to directly online import data with a given harmonized data format which follows ILCD and EN 15804 is a great chance also for international use. Hence, ÖKOBAUDAT and its infrastructure are a good starting point for the establishment of an open international LCA database network. In this paper the quality standards of ÖKOBAUDAT and its infrastructure are described, while the concepts and requirements for realization in an international context will be presented in the paper “International LCA data network – demonstration project for an open international online database structure”, (Paper ID 2336).

Keywords: life cycle assessment, database network, sustainable building

1. INTRODUCTION

Sustainability Considerations in the construction sector are nowadays established in an International level, and often, certification schemes are used to evaluate sustainability at building level. Within these, the life cycle assessment (LCA) is a central instrument for the evaluation of the ecological quality of the building: e.g. global warming, ozone depletion, photochemical ozone creation, acidification and eutrophication potential.

In Germany, as part of the Assessment System for Sustainable Building (BNB), the Federal Ministry for the Environment, Nature Conservation, Building and Nuclear Safety (BMUB), provides important infrastructure for choosing suitable building products. **There is offered a complete “tool chain”.** It starts with the basic material data from environmental product declarations (EPD), which are imported in the online database ÖKOBAUDAT, exported from there to the calculation tool “eLCA”, and finally are used for the final evaluation of a sustainable building resulting in a bronze, silver, or gold certificate (Figure 1). All provided tools are web-based, cost-free and publicly available; for all of them an English version or other information is given. These tools are administered by the German Federal Institute for Research on Building, Urban Affairs, and Spatial Development (BBSR).

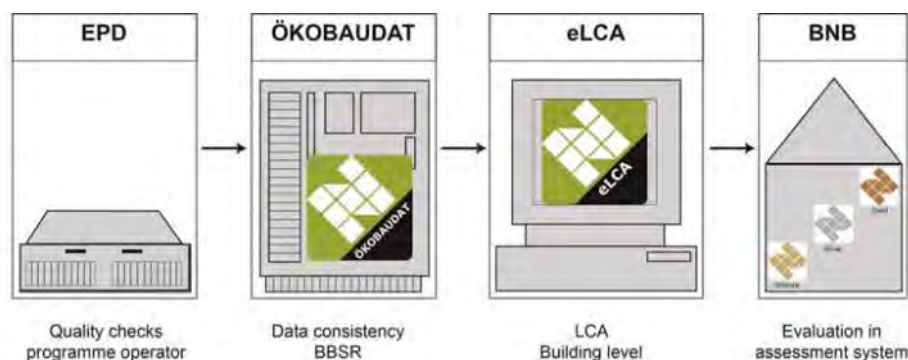

Figure 23: LCA infrastructure within German BNB

2. ÖKOBAUDAT

The German online database ÖKOBAUDAT is provided by BMUB already since 2009, and it is available for everybody interested in an ecological evaluation of buildings with a consistent database. Main users are planners and architects, who analyze the environmental indicators of the products, services, and processes, as integrated in the database.

The webpage (www.oekobaudat.de) offers a user friendly direct access to the database. Also, basis information, as well as interesting links, is given. Different versions of the ÖKOBAUDAT are archived. This can be relevant for ongoing projects as well as for reproducing former LCA results. Search- and filter- functionalities allow finding relevant datasheets for chosen materials or products directly in the online database. A comprehensive English version of the ÖKOBAUDAT webpage is provided since June 2015.

ÖKOBAUDAT contains generic basic datasets that provide suitable values of the environmental indicators for the building materials, as well as product related datasets that are determined mainly within EPD. Using the generic datasets allows sustainability studies of buildings already in early planning stages when architects or planners do not yet work with product specific but with generic building product information. In a later stage, the generic data in the model is then substituted by specific data representing actual construction products.

ÖKOBAUDAT offers over 1.000 datasets, half of them are generic data. Since 2013, ÖKOBAUDAT comprehensively meets the demands of European Standard EN 15804. The German Institute for Construction and Environment e.V. (IBU), which significantly contributes EPD datasets for the ÖKOBAUDAT, was the first to introduce EN 15804 in its EPD program rules. Other EPD programs followed.

At the moment ÖKOBAUDAT means the online database ÖKOBAUDAT with highly consistent and harmonised data, which can be transferred **as a whole “package” to affiliated tools. Via interfaces, direct online transfer, or Excel-sheet** ÖKOBAUDAT data are used nationally and internationally by other LCA tools, BIM applications or other. All ÖKOBAUDAT data are quality checked and data suppliers have to confirm, respectively proof conformity with the relevant standards and requirements.

2.1 ÖKOBAUDAT requirements

BBSR has developed “Principles for the acceptance of LCA data in the online database ÖKOBAUDAT” (Published at www.oekobaudat.de in German and English language). Accordingly, the data supplier has to apply for data transfer into ÖKOBAUDAT, where it differentiates between the following data categories:

- Category A: Independently externally verified EPD according to EN 15804 within EPD program according to ISO 14025
- Category B: Independently externally verified EPD or LCA data with independent external critical review, which comply with EN 15804, but have not been produced within an EPD program according to EN ISO 14025
- Category C: LCA data according to EN 15804 without independent external verification or critical review (Generic datasets).

The category types are important for the required quality procedures, as verification, critical review or audit.

Generic data are surrogate data used if no system specific data are available. The data can either be generated based on data from the industry (but usually not declared as such) or on data from other sources (Literature, expert knowledge etc.). Generic data are usually not developed within an EPD programme. In order to be used in LCA calculations these data follow the same data format, but external verification as for data category A and B is not required. Still, quality assurance for the generic data used for ÖKOBAUDAT, which are based on Gabi database, is given by an audit according to especially developed critical review criteria, e.g. complete and accurate meta-info; use of independent, relevant and qualified references; application of a consistent methodology and modelling principles.

Any other LCA data are currently not accepted for integration in the online database ÖKOBAUDAT.

As already mentioned, ÖKOBAUDAT is usually addressed as a complete “data package”. Being an important international data provider ÖKOBAUDAT decided to offer additional data, besides to the core ÖKOBAUDAT “data package”. These will be offered in October 2016. Apart from the following, these data offer ÖKOBAUDAT data quality and completely fulfil the “ÖKOBAUDAT-Principles”:

- EPD data in English language

The German Government, in general, requires German language for any public information. For this reason, ÖKOBAUDAT data are offered in German language and EPD data which are offered in English language only, are not integrated in the core ÖKOBAUDAT and will be offered as “additional data” in the first step. Full integration of English EPD datasets is discussed already.

Anyhow, all generic data produced on behalf of BMUB will be provided bi-lingual in German and English language from 2017 on. Also, it is the aim to motivate bi-lingual LCA from German data supplier, as English language is a common agreement for international data network structures.

- EPD data derived with eco-invent as background database

For the calculation of EPD data, generally, different background databases are used. As these may lead to significantly differing results for the considered environmental indicators, usually one background database is prescribed. Within BNB this is the background database Gabi; exceptions are allowed, but equality has to be shown. Also, all benchmarks of BNB refer to Gabi.

BNB decided to use its infrastructure and offer ÖKOBAUDAT as platform for those other data as well, starting with data referring to eco-invent. These data will not be integrated in the core ÖKOBAUDAT.

As a consequence, there will be a core ÖKOBAUDAT, which will be directly used for LCA calculations in eLCA (or other tools), while users will have to decide about the use of the “additional data” in their own responsibility. For eLCA, options for integration of selected “additional data” will be developed.

After application, BBSR (or agent on behalf of BBSR) checks up on the data supplier for fulfilment of requirements, i.e. conformity of program rules, PCR, verification rules with relevant standards. A report will be produced, and sometimes remediation is required. All data transfer procedures are administrated by BMUB/BBSR. Only after approval of a data supplier as such, in a second step, data are transferred ÖKOBAUDAT. All data have to be delivered in the so-called EPD data format (ILCD compatible). At first, data are transferred to an ÖKOBAUDAT-Inbox, where they are quality checked for plausibility and completeness, before finally being released in the actual version of online database ÖKOBAUDAT.

2.2 Technical data transfer

Since ÖKOBAUDAT is presented as online database, the provision of interfaces (API interface) which allow direct online import of LCA data to the database ÖKOBAUDAT is decisive. There are two possible ways:

- Direct EPD data import via interface
- **Data transfer via “openLCA”. The openLCA software tool is used to create and export EPD datasets in the EPD data format.**

All technical requirements for data transfer and relevant information on interfaces, open source tools and other sources are to be found on the web-page, or ÖKOBAUDAT-Handbook, which supports the user with practical information, or is to be found on the web-page.

The required EPD data format meets EN 15804 but also follows the already established extended International Reference Life Cycle Data System (ILCD) format. Within the EPD format some additional information is given, e.g. administrative information, validity of dataset, safety factors used for generic data. Also, regarding representativeness the dataset sub-type has to be declared, i.e. specific, average, representative, template, or generic dataset. As an internet-aware data format, it has been designed to explicitly allow publishing and linking of data as resources via the Internet. The advantage of this new approach is that existing software tools with built-in support for the ILCD-format can be easily enabled to support the new EPD datasets as well, with only minor

changes to their internal information structures. It is to emphasize that ÖKOBAUDAT is running on an open source program software platform (soda4LCA), which allows the development of further modules which use or may add new features to the procedures. Anyhow, with EPD data format data can be exchanged online and transferred to any LCA or other calculation tools, as long as suitable interfaces are provided.

When supplying EPD datasets it is also essential to classify the dataset within the already existing product category structure of ÖKOBAUDAT. File names are always provided by the data supplier. Responsibility on the data file remains with the data supplier at all times. Hence, corrections or required modifications are always carried out by him, and not by BMUB/BBSR.

2.3 Current situation

In Germany, IBU as an important EPD program operator has equipped its own database application with facilities to directly import its data online into ÖKOBAUDAT. As not all relevant institutions are in the position to provide such online databases, the widely-adopted open source LCA modelling tool “openLCA” is offered as part of the LCA infrastructure within BNB. OpenLCA is currently used for data transfer by German EPD program operator ift Rosenheim, and Austrian EPD program operator Bau-EPD, as well as by German Thünen Institute for its averaged LCA data derived from industrial background data for wooden materials (Figure 2).

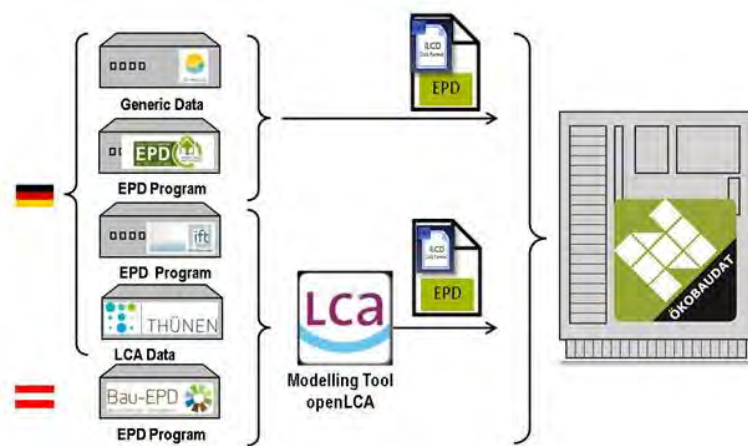

Figure 2: Current situation of data transfer to German ÖKOBAUDAT

ÖKOBAUDAT is an internationally well-accepted database. It is used as such for LCA calculations at building level within different certification schemes, BIM applications. Obviously, with over 1.000 quality checked datasets it is one of the most comprehensive databases with consistent and comparable data, which easily can be transferred to affiliated applications. A wider use of data will be supported in future by providing bi-lingual generic data. Also, the provision of additional data, even if not directly addressed within the BNB tool eLCA for already explained reasons, will be of high importance for many users.

The high data quality of ÖKOBAUDAT is assured by application procedures of data supplier, which comprise a reviewing of conformity of their program rules, PCR documents and verification rules with standards and requirements, as well as by sampling of the finally supplied data. A high consistency and comparability of data is given for several reasons: e.g. application procedures with clear requirements, setting standard for EPD data format, referencing one background database, generic data from one data provider. Also, the co-operation with **Germany's most important EPD program operator IBU, who has established important rules and procedures within its program, supports the data quality of ÖKOBAUDAT.**

Another important instrument is the “Anwenderkreis ÖKOBAUDAT”. In this board BMUB/BBSR, all ÖKOBAUDAT data supplier and other LCA experts develop common agreement on interpretation of EN 15804, data transfer procedures etc. This group significantly supports the data quality of ÖKOBAUDAT by improving harmonization, consistency, and comparability of data, information and processes.

3. GERMAN LCA INFRASTRUCTURE AS A STARTING POINT FOR INTERNATIONAL DATA NETWORK

The current situation is that more and more EPD are produced worldwide following harmonized standards, but no structured data transfer is foreseen. As explained, the possibility to directly transfer data between databases, furthermore export those to LCA tools, with a given harmonised data format which follows the generally accepted European or international standards, is a great chance for the idea of a consistent and harmonised way of using material and product relevant LCA data, or EPD data respectively, for LCA at building level internationally. It is the vision of an open international data network. The main idea is that there exist independent (national) databases which are linked to each other, and due to a common standard allow open search and use of data. Anyhow, each state will have the opportunity to set up own national rules for the use of data in subsequently used LCA tools, or other applications.

BBSR initiated the WG “International open data network for sustainable building” (InData) where stakeholders from 8 European nations started to develop a common understanding for this idea.

The infrastructure and all technical background as described in the article shows that the technical possibilities are already there. Data transfer as practiced for the ÖKOBAUDAT, either directly or indirectly via openLCA could be realized by every interested stakeholder. Furthermore, all tools and programs are open source, which allows for the development of modifications or additional features being open for everybody.

A research project funded by BMUB will set up a show-case for an international system of data transfer (See “International LCA data network – demonstration project for an open international online database structure” paper 2336). As a result, the conceptual framework and the technical applications shall be analyzed, and to some extent realized for demonstration. Apart from the technical possibilities, the definition of common rules and common core information, data quality levels etc. will be crucial, as described in more detail in (Paper 2336).

ÖKOBAUDAT with its acceptance and proofing procedures has set a Standard. Also, in future it will be a “label” for high quality and consistency of LCA data and will only accept data that follow the principles for LCA calculations within BNB. By offering all tools and information as well as datasets themselves in English language ÖKOBAUDAT contributes to a tremendous extent to the open network structure.

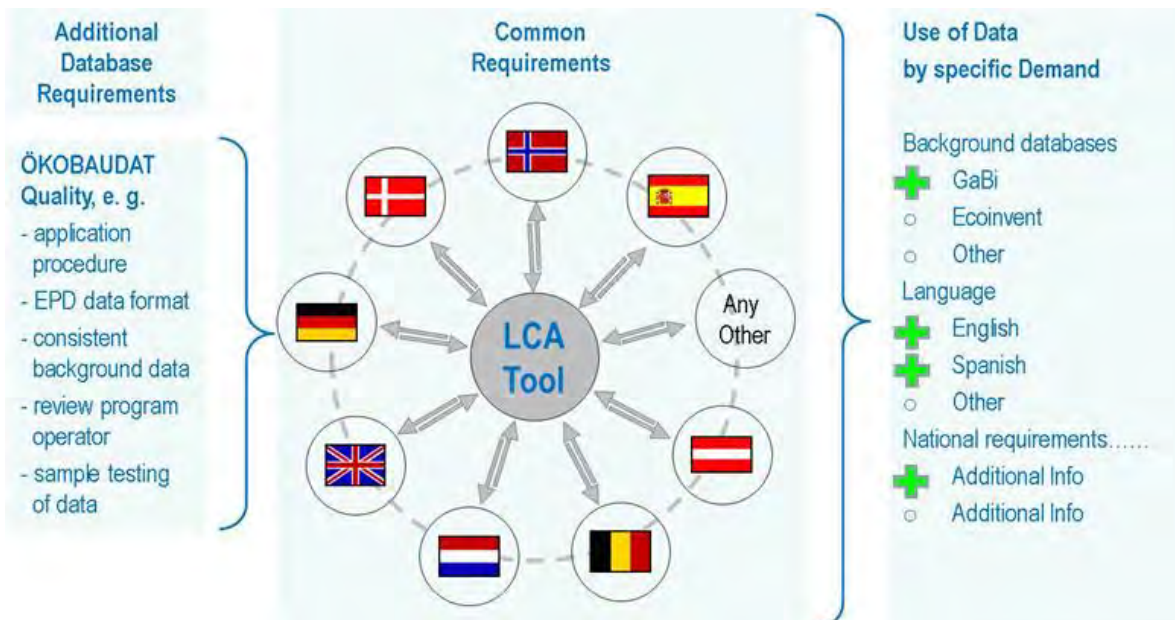

Figure 3: Example for individual use of data within open international data network structure

4. CONCLUSIONS

In Germany, for the use within BNB a complete LCA online infrastructure was developed. EPD data are transferred to the online database ÖKOBAUDAT and exported to eLCA for LCA tools at building level, which leads to final results and certification labels. All information and tools are cost free, publicly available, and open source based. With this, a starting point and the technical basis for the development of an open international data network are given. WG InData and research, as well as bi-lateral cooperation support further developments. Furthermore, it is shown for ÖKOBAUDAT that application procedures, review of program operators, sampling testing, the development of a data format, and also harmonization between national program operators are crucial for a database with high quality level, which offers consistent and comparable data for LCA at building level.

In Germany, the government decided to take the responsibility and bring forward sustainability for federal buildings by establishing the certification scheme BNB. It always was the aim to offer all information and tools with a high transparency with the aim to support the idea of sustainable building in general and to diminish barriers in using it. With establishing the LCA online infrastructure for BNB which may be offer the basis for an open data network, the German government supports European ideas of sustainability. Political programmes and support is very helpful, also for the definition of responsibilities. It is very helpful to run one central national database for EPD data rather than having different databases by several programme operators. Experience in Germany has shown that the centrally bundled provision of data and tools by the government is a highly supportive instrument for a wide application of LCA at building level and the realisation of sustainable buildings.

REFERENCES

- [1] Brockmann, T., Haas, S., Kerz, N.: Sustainability and Building Materials within BNB – Evaluation, Tools, and Database; World Sustainability Conference WSB 14, Barcelona, Spain, 28.-30. October 2014
- [2] Brockmann, T., Kusche, O., Rössig, S.: Life Cycle Assessment within BNB – Online-Tool eLCA and materials database ÖKOBAU.DAT, World Sustainability Conference WSB 14, Barcelona, Spain, 28.-30. October 2014
- [3] Brockmann, T.: European LCA data network – open public online database and data format of ÖKOBAUDAT as a starting point? In: Sustainable Built Environment Conference 2016 in Hamburg; Strategies, Stakeholders, Success factors, 7th - 11th March 2016; Conference Proceedings, pages 526-535.
- [4] Brockmann, T.: LCA within BNB (German Assessment System sustainable building for federal buildings – German Online database ÖKOBAUDAT as a starting point for open LCA data network. In: Sustainable Steel Buildings: A Practical Guide for Structures and Envelopes, October 2016, page 66-72
- [5] Brockmann, T.: ÖKOBAUDAT internationally. In: BBSR Research News., Nr. 3/2016 (Mai), page 6
- [6] Döpmeier, C., Kusche, O., Brockmann, T., Rössig, S., Ciroth, A., & Lode, T., „Towards a complete tool chain for eco-balancing governmental buildings.” **Proceedings of the 28th EnviroInfo 2014 International Conference on Informatics for Environmental Protection: ICT for Energy Efficiency**, September 10-12, 2014, Oldenburg, Germany, pages 173-180.
- [7] EN 15804 European Standard EN 15804 – Sustainability of construction works – Environmental product declaration – core rules for the product category of construction products.
- [8] EN ISO 14025 – Environmental labels and declarations – Type III environmental declarations, principles and procedures (ISO 214025)

How Actors Can Implement in Practice the General Principles of Sustainability in Their Buildings and Civil Engineering Projects

Sylviane NIBEL^a, Thomas LÜTZKENDORF^b, Guido HOFF^c, Gérard SENIOR^d, Jabeen QUADIR^e

^a Centre Scientifique et Technique du Bâtiment, France, sylviane.nibel@cstb.fr

^b Karlsruher Institut für Technologie, Germany, thomas.luetzkendorf@kit.edu

^c Deutsches Institut für Normung - Consumer Council, Germany, guido.hoff@din.de

^d GermanyArchitecte, A.E.T.I.C., France, aetic.senior@orange.fr

^e Sustainability Edge Solutions, Canada, jquadir@sustainabilityedge.com

ABSTRACT

In order to implement sustainability thinking in the construction sector, actors need to have in mind the general principles of sustainability and to rely on guidance for practical implementation. The complexity and multi-dimensional character of sustainability leads to the necessity of a well-structured tool able to accompany the actors in their construction projects, and to recommend relevant questions, actions and decisions at each phase. In 2014 the technical specification ISO/TS 12720 **“Sustainability in buildings and civil engineering works - Guidelines for the application of the general principles”** was released, based on nine general principles, described in ISO 15392:2008. These principles are: continual improvement, equity, global thinking and local action, holistic approach, involvement of interested parties, long-term consideration, precaution and risk management, responsibility, and transparency. The ISO 15392 standard is very general and difficult to implement in real projects without application guidance. ISO/TS 12720 is able to provide this guidance to actors during the different phases of a construction project, combining different sustainability issues and detailing practical recommendations. Starting from a “vision” of what a sustainable building should be, inspired from a European R&D project, the technical specification (TS) describes a multi-dimensional framework with different view angles. This TS is a powerful tool to facilitate integration and concrete implementation of the sustainability general principles. This paper presents the contents of this TS and its application as a guideline in the elaboration of an ISO standard on visual environment developed by ISO TC 205. The ISO 15392 standard is currently under revision, which presents an opportunity to analyse if new practices like BIM, integrated design, smart-cities, circular economy and resilience, may generate new general principles or bring a new light on existing ones.

Keywords: sustainability principles, ISO standard, design process

1. INTRODUCTION

ISO 15392:2008 is part of a suite of international standards developed by the Technical Committee ISO/TC 59, Buildings and civil engineering works, Subcommittee SC 17 Sustainability in buildings and civil engineering works. In this paper, the background, basics and application of the standard are clarified and possibilities for its further development and refinement are discussed.

1.1 Background

There are currently various developments and trends in relation to sustainable development-oriented design, construction and operation of buildings. This involves approaches that focus on environmental (design for environment, design for deconstruction), economic (design to cost, design to life cycle cost) or social/functional issues (healthy buildings, performance based buildings). However, what has long been lacking is a basis for combining these aspects into an overall concept. At the same time, there is a growing desire among many companies in the construction and real estate sector to contribute to sustainable development. The principles and rules to ensure sustainable development must always, however, be integrated into the responsibilities and duties of the actors involved (here the construction and real estate sector) and adapted to the respective object of assessment (here construction works). To overcome the uncertainty found in the sector regarding the use and **interpretation of terms such as “sustainable building”, and in particular to distinguish it from the term “green building”**, a need for clear terminology, principles and concepts arises to support sustainable development in the construction sector.

1.2 Scope and purpose

From the beginning, the aim of ISO 15392 has been to contribute to the creation of a common understanding of sustainability in the construction and real estate sector and to provide a generally recognized basis for this purpose. This basis covers both requirements for sustainability assessment of construction works and principles that should be considered when integrating sustainability aspects into the design and decision-making processes. At the same time, ISO 15392 provides the basis for other standards, including ISO 21929-1, which establishes a core list of sustainability indicators for buildings. The ultimate goal is to ensure the transferability and applicability of the objectives and principles of sustainable development to the construction sector. In future, ISO 15392 needs to be and will be even more oriented to the Brundtland definition of sustainability in order to avoid misunderstandings.

1.3 Linkages between dimensions of sustainability

The description and assessment of the sustainability of products and processes traditionally considers the environmental, social and economic dimensions. This also applies to the assessment of buildings and other construction works. The way the three dimensions relate to each other has long been discussed. ISO 15392 specifies that all three dimensions of sustainability must be considered in a sustainability assessment – simultaneously and in an equal manner. This results in various consequences, even in terms of the establishment of weighting factors in sustainability assessment systems. In the meantime, the subdivision between dimensions **or “pillars” causes several problems.** Assessment criteria and indicators cannot always be clearly assigned neatly to one of the three dimensions. For any effect taking place in one dimension, side effects and consequences may arise in the other two dimensions. For example, indoor air quality (IAQ) can be considered both an environmental and a social aspect. This topic has been discussed in ISO 21929-1 and is planned to be addressed in the revision of ISO 15392 that is currently underway.

1.4 Areas of concern

ISO 15392 identifies areas of concern and protection goals that are suitable for the development of an understanding of sustainability and identification of criteria. These are shown in Table 1.

Dimension	Areas of concern
Economic dimension	Economic resources Asset value (property value)
Environmental dimension	Environment (Natural) Resources
Social dimension	Social infrastructure Cultural heritage Human health and comfort

Table 1: Dimensions of sustainability and related areas of concern

It is planned to refine the concept and terms of the areas of concern and harmonise them within the ISO TC 59/SC 17 suite of standards. Nevertheless, it is worth pointing out that the derivation of assessment criteria and indicators from protected goods and protection goals has proven to be effective.

2. GENERAL PRINCIPLES

ISO 15932 was created as an overarching, generally applicable document addressing sustainable development in the building and civil engineering sector. Specific issues are tackled in various standards elaborated within ISO TC 59/SC 17, all based on the current nine principles listed in 2.1 below.

Public authorities are one of the drivers in promoting the idea of sustainability, especially in the building sector. They act as a role model for private consumers and property investors, creating a demand for relevant, credible, reliable and unambiguous information. It is expected that assessment and certification of the contribution of products, buildings, civil engineering works and related services to sustainable development will be more visible to all actors and will play an even more important role in decision-making in the near future, for example, in public procurement. The standard establishes a common basis for information which the demand side (e.g. public authorities, owners, architects) asks for and enables the supply side (e.g. product manufacturers) to provide it in the right format.

2.1 Current nine general principles

a) Continual improvement

Sustainability is not a value in itself nor can it be seen as an end state that is achieved once the project is completed. Therefore, the concept of sustainability described in the standard measures the contribution of a building or civil engineering works to sustainable development while fulfilling the required functional and technical performance over time. This contribution may vary depending on the construction type or technique used and ideally will be reconsidered during the design process to ensure the performance of the building over time. Continual improvement moreover addresses the scientific basis for assessment, the calculation rules and communication of results as well as monitoring during the use stage by constantly analyzing problems that occurred in the past, deducing measures and metrics as the basis for improvement.

b) Equity

The building and civil engineering sector is one of the most important economic sectors throughout the world, generating tremendous related social impacts (notwithstanding the ecological impacts) and is therefore predestinated to help overcome existing inequalities related to social status, gender, abilities and age. Next to the aspects of creation of jobs, income and reduction of poverty, this principle addresses the satisfaction of basic needs such as affordable housing, healthy shelter and social services provided by the built environment. The diverging interests existing in society need to be considered impartially and in a balanced way, taking into account regional specifics.

c) Global thinking and local action

Sustainable development is a global challenge predominantly pursued by regional or local strategies, which may differ in content depending on the respective context. It is essential that these local strategies contribute to the global aims and that their consequences are considered on a broader scale. Likewise, when strategies are established on a global scale, it is important to consider the impacts and implications on the regional and local level and to take into account the context, such as traditions, needs, capacities and restrictions present at these levels.

d) Holistic approach

The concept of sustainability implies the equal consideration of all three pillars of sustainability (see also 1.3). This is vital to reflect the entire impacts of building and construction works rather than focusing on single criterion based claims, for example, with respect to global warming potential (GWP) or claims that narrow the view to environmental aspects only, such as product environmental footprint (PEF). Moreover, global aims and concerns with respect to sustainable development need to be aligned with needs, requirements and constraints with respect to functionality and efficiency.

e) Involvement of interested parties

Sustainable development generally requires an interested society with responsibly acting individuals. In the construction sector, existing national regulations may require participation of the general public (e.g. in land development plans) or of individuals (e.g. direct neighbours), when planning a building on a specific site. This principle however, seeks to stipulate the direct involvement of all interested parties in all relevant processes. This is applicable to the different interested parties, including manufacturers, designers, construction companies, owners and users all acknowledging their different views, personal concerns, interests and understanding. Direct participation also adds to transparency, when decisions and their justification are discussed in an open manner, easing their acceptance, especially for large-scale projects.

f) Long-term consideration

To benefit from sustainable development concepts, long-term considerations are an important factor during inception and design of a project. It is evident that every decision making process will also take short- and medium-term effects into account. However, the major concern is to maintain the required function of the building or civil engineering works over the predicted service life. The use stage is of paramount importance, although all life cycle

stages have to be taken into account to assess the implications of a decision taken on other life cycle stages. The building or civil engineering project becomes part of the built environment, providing the physical and functional environment of a society, forming a cultural identity. The implications reach far beyond the project boundaries. Next to the physical presence of the building or civil engineering work the project effects the environment, the economy and society by forming part of the cultural heritage.

g) Precaution and risk management

Risks may not be prevented but may be avoided by using methods, techniques and products that are proven to be safe and healthy (precautionary principle) rather than adopting them without any risk analysis. However, this principle should not inhibit innovation. Management strategies need to be set up and communicated to identify, analyze and control any potential risk.

h) Responsibility

Decisions or actions taken by individuals or companies during the project will have (next to environmental consequences) legal or financial implications. The legal responsibility and liability is subject to national laws. This principle addresses the moral responsibility for these decisions and actions and implies the facilitation of skills and competencies, both on an individual and the collective level (i.e. companies, authorities, societies).

i) Transparency

This principle comprises two aspects: the transparency related to decision-making processes that may require personal involvement of interested parties and an accessible documentation (system). The second aspect relates to the presentation of information on the contribution of products or building construction works to sustainable development. Basic concerns are credibility, completeness, relevance and an assessment that is easy to understand. Therefore the underlying data need to be traceable and need to be reviewed and verified for certain purposes.

2.2 Revisions under consideration

It is worth noting that the ISO 15392 standard is currently undergoing revision by the working group experts of ISO TC 59/SC 17. Some areas identified for update include more complete terminology that is appropriately aligned to the many

international and national standards that impact or are impacted by this standard and the UN Sustainable Development Goals. As discussed in section 1.4, the Areas of Concern, objectives and the different perspectives of the life cycle will be more definitively related to each of the three pillars of sustainability to promote a common understanding within the building and civil engineering sector. The handling of multiple impacts within multiple impact chains will be elaborated on. The text on the Precautionary Principle will be further expanded to address prevention and avoidance of hazards, risks and waste. The concept of resilience will be elaborated on as an objective of some of the general principles, such as long-term consideration. Contemporary tools and methodologies such as integrated design, smart buildings and infrastructure and building information modelling (BIM) will be identified for achieving one or more of the general principles. Discussions are ongoing to determine if there are any new general principles that should be added. One such concept under consideration is regenerative sustainability, which aims to broaden the scope beyond reducing adverse impacts to actually generating benefits for society and the environment, with a particular focus on the human design element. A primary overall objective of the revisions for the next edition of the ISO 15392 standard is to more clearly demonstrate its value and relevance to the construction sector and the marketplace. It is anticipated that the ISO/TS 12720 application guidance for the general principles will be updated accordingly.

3. GUIDANCE FOR APPLICATION

Two ways to implement the nine general principles described in ISO 15392 are summarized here: the wrong and the best, or the formal way and the real application.

An example of a formal way is to implement the general approach and terms as defined in the ISO 16813 Building environment design — Indoor environment — General principles, developed under ISO TC 205. These general principles for the design of the building indoor environment enable the main participants in the design process to ensure an indoor environment of the quality required for users. They enable the clients and designers to provide the desired quality of indoor environment in a sustainable building according to the fundamentals of the design process with energy conservation and the whole life cycle in mind. The design process aims to ensure that the building design provides the specified quality and performance level of safety, health, comfort, and energy use as well as the sustainability philosophy, ethics, and assumptions taken by the people concerned. Building designers are to define the goals based on the requirements, constraints, and actual conditions to be achieved, integrating the owning and operating costs during the design stage.

A better way, as a realistic tool for designers, is outlined in ISO DIS 16817 Building environment design — Indoor environment — Design process for visual environment with the help of ISO/TS 12720. The purpose of this International Standard is to provide design team members with a design process for the indoor visual environment to achieve required visual comfort, physiological effects of light and energy performance of buildings. The objective of this standard is to provide the design team at each phase of the design process with a way to implement the nine general principles of sustainability in buildings, as described in ISO 15392 and how to integrate these principles in their decision-making processes, as part of a sustainable approach. The scope of this International Standard provides an integrated design process for high-quality indoor visual environment including architectural and engineering aspects of daylighting and artificial lighting for user satisfaction, health, well-being and productivity as well as the energy performance and sustainability of buildings.

The design process is divided into 9 phases: (1) Stage I — Formulation of project definition; (2) Stage II — Schematic design; (3) Stage III — Detail design; (4) Stage IV — Final design; (5) End of design; (6) Development of design criteria; (7) Development of design aids; (8) Cost evaluation; (9) Estimation of primary costs. In each phase we determined which principle could be introduced and which information and concept could be applied, in project information, area of the visual environment design project, detail design and so on. That work was continued by applying ISO/NP 19454 Building environment design — Indoor environment — Daylight opening design process in order to ensure sustainability principles in the visual environment.

All of the sustainability objectives and related issues of concern presented in Table 3 of ISO/TS 12720 were considered and the relevant items related to visual environment were selected, keeping the same structure as the flow chart in ISO16813. The table shows the relationship between design permutations related to daylighting opening design and the optimization of sustainability objectives. The relevance between opening design elements **and sustainability objectives and related issues of concern are noted with a “yes”**. So a question must be expressed and an appropriate response given.

4. CONCLUSIONS AND OUTLOOK

A uniform understanding of the transfer of sustainable development goals and concepts to the different objects of assessment and practical procedures in the construction and real estate industry is a precondition for taking on the responsibility towards the environment and society. It is necessary to consider the various sustainability aspects in the construction sector not in an isolated way, but rather in an integrated way. Using the described principles, sustainability aspects can be considered in the design and decision-making processes.

It is necessary and useful to exchange experiences, more than ever, on how sustainability aspects are considered in a building's design, construction and operation. Sharing of global experience in the application of these principles in practice will, in turn, increase the relevance and value of the application guidance for the general principles provided in ISO/TS 12720.

REFERENCES

- [1] ISO/TS 12720 Sustainability in buildings and civil engineering works -- Guidelines on the application of the general principles in ISO 15392
- [2] ISO 15392:2008 Sustainability in building construction -- General principles
- [3] ISO 21929-1:2011 Sustainability in building construction -- Sustainability indicators -- Part 1: Framework for the development of indicators and a core set of indicators for buildings
- [4] ISO 16813:2006 Building environment design -- Indoor environment -- General principles
- [5] ISO DIS 16817 Building environment design — Indoor environment — Design process for visual environment
- [6] ISO/NP 19454 Building Environment Design -- Indoor environment -- Daylight opening design process in order to ensure sustainability principles in visual environment

Driver and Challenges Facing Leadership in Adopting Sustainability in the Built Environment: A Developer's Perspective

ZHANG Xiaoling^a

^a Department of Public Policy, City University of Hong Kong, Hong Kong SAR, xiaoling.zhang@cityu.edu.hk

ABSTRACT

Sustainable development drives the sustainable built environmental campaign on the global stage, which will continue to be an increasing challenge over the next decades particularly to most developing countries. In order to meet the challenges involved, several major China property developers have initiated a “green building development” campaign. They have established a post of “Director of Sustainability” responsible for overseeing the overall development and implementation of green technologies in their projects. Decisions concerning sustainable building development are often embedded in the typical logic of a property developer's strategy, e.g. from vision, mission and strategy to final objectives. This paper identifies and explores the drivers and challenges confronted by the leadership of real estate enterprises in adopting sustainability, and their strategies and approaches taken to reinforce sustainability in the built environment. By doing so, this highlights the great diversity of drivers and challenges facing entrepreneurs in adopting sustainability and which extends well into the built environment.

Keywords: leadership, sustainable built environment, drivers and challenges

1. INTRODUCTION

For several decades, nations, cities and stakeholders worldwide have begun to promote the construction of “green buildings”. Due to different national realities, different countries have different approaches to developing green building. In referring to the environmental performance assessment systems of developed countries, a special organization is usually established by either government or industry associations (Non-government Organizations, or NGOs) by way of the third technical certification to conduct green building reviews and evaluation. For example, the United Kingdom's Building Research Establishment's Environmental Assessment Method (BREEAM) (Larsson, 1998), United States' Leadership in Energy and Environmental Design (LEED) (Crawley and Aho, 1999), Australia's Green Star (Seo et al., 2006), the Japanese Comprehensive Assessment Scheme for Building Environmental Efficiency (CASBEE) (Japan Sustainable Building Consortium, 2006), the GBTool designed by Canada and applied internationally by over 20 countries (Cole, 1998) and the Hong Kong Building Environmental Assessment Method (HKBEAM) (Davies, 2001). In the USA, green buildings are promoted by NGOs, which aim to use market forces for their development. The U.S. Green Building Council for example, an NGO, established the LEED system, which is designed for market-oriented operation. Before market forces start to play their role in driving green construction projects, however, government intervention is the primary force to encourage building green. In the USA, the federal and state governments have passed legislation concerning the energy consumption of products, mandatory minimum energy standards of equipment, and use government investment projects to demonstrate and encourage state-of-the-art building energy-saving technologies based on building energy efficiency standards. Building environmental rating systems, therefore, provide a way of showing building owners the extent to which a building has been successful in meeting the expected level of performance in terms of the various criteria involved (Buys and Hurbissoon, 2011).

It is necessary to encourage more stakeholders to be involved in initiating green buildings. Real estate developers are considered to be one of the most proactive stakeholders. With the increasing rise in environmental awareness, some pioneers in the real estate industry have gradually entered the realm of eco-friendly design and building practices in building management and taken other green initiatives (Torre, 2013). In China, green buildings are becoming increasingly demanded due to rapid urbanization pressures, low carbon city developments and public, **social and private stakeholders' willingness to pay for sustainability**. Although the central government in China is committed to delivering sustainable developments, it rarely is delivered in practice once the policy is handed down to a local level. Quite why this situation exists is unknown. Of course, it is possible that it is attributable to the well-known challenges involved in green projects, such as higher initial cost.

In this context, green buildings need committed, forward-thinking leadership to drive through change. Ignoring green building issues is no longer a safe business model, as the current market demands developers to be more innovative than ever before, and it is therefore critical for real estate developers to adjust their core business model to the environmental driven market environment (Torre, 2013).

2. DEFINITION OF GREEN BUILDING DEVELOPMENT AND ROLES OF “DIRECTOR OF SUSTAINABILITY

Green building, also known as ‘green construction’ or ‘sustainable building’, is a term defined by the Office of the Federal Environmental Executive. This agency defines this term as:

“the practice of (1) increasing the efficiency with which buildings and their sites use energy, water, and materials, and (2) reducing building impacts on human health and the environment, through better siting, design, construction, operation, maintenance, and removal-**the complete building life cycle” (Howe, 2010).**

It can be traced to many origins over recent decades, being initially called “Arology” in 1960s by Paolo Soleri, an architect combining ecology and architecture (Soleri, 1969). The arrival of the oil crisis in the 1970s, in which the price of oil quadrupled virtually overnight, alerted building providers and operators to the need for greater energy saving and that high energy consumption was unsustainable for development in general. In the 1980s, the excessive focus on energy saving resulted in severe detrimental effects on users’ physical and mental health, prompting calls for more attention to be paid to “healthy” buildings. By 1987, the United Nations’ World Commission on Environment and Development first defined sustainability as the ability of the present generation of people to meet their needs without compromising the ability of future generations to meet theirs (Yudelson, 2007). This idea was extensively promoted and applied to architecture in the form of “sustainable building”.

Since 2000, global warming has increasingly attracted the attention of the international community. The Intergovernmental Panel on Climate Change (IPCC) predicted that greenhouse gas emissions will grow by 25%-90% from 2000 to 2030 (IPCC, 2007), which will have an immeasurable influence on our living environment. Significantly, as is well-known, building construction is one of the major sources of greenhouse gas emissions, with an estimated 36% of greenhouse gases being emitted by building construction related activities (IPCC, 2001; Metz, 2001).

Today, “green building” is based on the theory of sustainability and is part of the concept of promoting sustainability (Chan et al, 2009). It has become a flagship for sustainable development in this century, with a responsibility for balancing long-term economic, environmental and social health. (Ali and Al Nsairat, 2009). According to the USGBC (1998), green buildings incorporate design and construction practices that significantly reduce or eliminate the negative impact of buildings on the environment and occupants in five broad areas of: (1) sustainable site planning; (2) safeguarding water and water efficiency; (3) energy efficiency and renewable energy; (4) conservation of materials and resources; and (5) indoor environmental quality (Council UGB, 1998). Mahsa et al (2011) define a green building as “a structure that is designed, built, renovated, operated, or reused in an ecological and resource-efficient manner”. The Building Services Research and Information Association (BSRIA) point out that a green building is conducive to people’s health, and its construction and management should be based on the principle of efficient resource utilization and ecological benefits. Generally, green buildings are energy efficient, water conserving, durable and non-toxic, with high-quality spaces and materials with a highly-recycled content (Yunna and Ruhang, 2013). They have both private utility and public utility. Private utility refers to safety, comfort and health as, according to the World Health Organization (WHO), green buildings can provide healthy, comfortable and safe spaces for people’s living, working and other activities. In contrast, public utility is recognized as environmental protection through saving energy and water and reducing carbon emissions, which presents a solution to resource and environmental problems.

For the purpose of reducing carbon emissions and alleviating the greenhouse effect, more and more research concerning green building is focused on “low carbon” buildings. As a result, together with energy rating systems such as LEED and Green Star now operating in several countries, green building is gradually being put into practice. China, as a large industrial country and one of the largest energy consumers and carbon emitters in the world, where especially residential buildings are in great demand, has a responsibility to urgently help lead the way (Yunna and Ruhang, 2013).

2.1 The role of the “Director of Sustainability”

The Director of Sustainability is a position that is responsible for achieving one of the corporate goals, e.g., to sustain social responsibility. In general, corporate social responsibility means the organizational consideration of multiple stakeholders and global impact, beyond simply focusing on maximizing the shareholders' wealth (Pienaar, 2010). Many companies associate the expenses involved in social responsibility and green design effort to be in accordance with the idea of integrating economic, environmental and social criteria into strategy and management to create long-term value for shareholders (Smith, 2007). These widespread CSR efforts are driven not only by ideological thinking that firms can be positive forces for social change, but also by the business returns that firms potentially reap from CSR engagement (Du, 2013). Consequentially, corporations now pay more attention to the internal status of “green building”. Hence, sustainability is becoming a vital consideration in leadership decision making, and may even lead to the birth of a new “green” position.

As it is important to engage with different stakeholders in developing green buildings, I conducted several interviews with business leaders to elicit their opinions concerning their attitudes to social responsibility or, in other words, the sustainability development views of managers.

According to CEO of Gammon Construction, Ho Corporate Social Responsibility is defined as action to promote and protect the environmental, social and economic interests of future generations, adding that, as part of the commitment to create real value in a changing world, they are determined to hold themselves accountable for the social, environmental and economic impacts of their operations and are committed to developing appropriate policies, business practices and services (Jones Lang LaSalle and LaSalle Investment Management, 2010). Mr Mao Daqing, the CEO of Vanke, one of China's largest developers, believes that corporations will not stay in existence unless they conform to being “green”. This is echoed with China Merchants Property Deputy GM, Mr Hu Jianxin's comment that “Real estate is in a process of green innovation that will gradually spread to all levels of the real estate industry chain. Hence, it is becoming a common mission and vision for most Chinese developers to depart from the traditional real estate development approach in favour of developing green buildings (Zhang et al., 2011) Although it is not necessary for a business corporation to found its own energy saving company, it must have a management team to implement requirements from top-down (Jiao, 2012).

In China, some leading real estate developer pioneers, such as China Merchant Properties, Vanke, Modern Land and Landsea real estate, have integrated their own characteristics with a burgeoning green mission since 1999. For example, China Merchants Property (CMP) proposed a “green real estate” concept directly with a guidebook published in 2004 named “The Road towards Green Real Estate”. During early 2010, a new mature green operation system first appeared within the CMP management system. Within this system, the CMP headquarters established a Planning Commission Committee and Green Real Estate Research Centre to maintain their green property operation as well as promote new housing products. In each of their local branches, CMP nominates its technology director as a green commissioner to take responsibility for green development. CMP has also established a new position of “Green Technology Director.” As the main principal for corporate social responsibility and green real-estate development, the Green Technology Director is responsible for green strategy formulation, implementation, low-carbon green product standardization, technology development (RandD), corporation strategic platform construction and green financial expansion (Zhong, 2011). The directors of sustainability in other real estate enterprises have similar responsibilities. For example, Modern Land has established a chief energy efficiency executive officer to take care of green building and produce a complementary building energy management system that integrates a number of advanced green technologies. Landsea has also instituted a senior technology management position named “Green Chief Architect” who is responsible for reviewing all of development projects in terms of sustainability criteria (see Table 1).

Corporation	Position	Director responsibilities
China Merchants Property	Green Technology Director	(1) Develop, implement and promote corporate green strategies. (2) Standardise product, research and develop specific technologies. (3) Review regional green building projects. (4) Coordinate the relationship between government and corporation financed green subsidies.
Modern Land	Chief Energy Efficiency Executive Officer	(1) Complete the energy saving technology system (2) Provide a comfortable and energy-efficient residential product.
Landsea	Green Chief Architect	(1) Responsible for green building technology counselling (2) Review all green building projects. (3) Continue designing environmental friendly residences.

Table 1: Director of sustainability in three real estate enterprises

3. LEADERSHIP IN PROMOTING GREEN BUILDING DEVELOPMENT: THE STATUS-QUO

3.1 Performance in engaging with green building

Leadership is the capacity for leaders to be engaged with their subordinates and relevant stakeholders, including the interactions among them (Zhang, 2007). The influence of leadership is significant throughout the process of green estate development, particularly the leaders' perceptions of green buildings, green marketing, and green management. Nevertheless, developers perceive the development of green buildings in different ways, which has a direct impact on their marketing strategy, e.g., to prioritise green projects as core products. In a market survey conducted by the China Real Estate in 2011, 36% of the property developers agreed that the green building industry in China is in a 'germination' (initial) or transition stage (from of 'demonstration to rapid development'), while 22% thought it had already passed into the 'demonstration stage.' Distinctive cognition differences have led to particular preferences in green buildings. Proactive business leaders tend to take the initiative in developing green buildings and promoting real estate projects that comply with green guidelines. In this way, entrepreneurial behaviour driven by green leadership can change a property developers' core strategy, technology system, supporting mechanism and development goal to one that is devoted to green real estate.

Furthermore, the leader's perception of the green building development can also influence the formulation and transformation of consumer perception in 'going green' through real estate products and marketing campaigns. Therefore, when developers promote their products in the market, they are also contributing to publicising and popularizing green building development. In fact, there are insufficient intellectual resources available for green building in China. In this context, a proactive leadership of the sustainability mission and vision not only has a significant impact on recruiting the intellectual resources needed for green building, but also in personnel training and establishing a green strategic map, which would eventually lead to a greater core competence to compete in the real estate market. Recently, several real estate enterprises have successfully transformed themselves from the traditional approach to green building development and established their own green real estate research teams. For example, the China Merchants Property Development Company has started a "Green, R and D and Application Centre" with the purpose for achieving the goal of "building green homes and promoting social progress." Landsea has also recruited more than 200 domestic and foreign senior researchers committed to the development of green building technologies.

3.2 Leadership styles for green building

Entrepreneurial leadership can be classified into two types – transformational leadership and transactional leadership - which perform differently in promoting green building development. Specifically, transformational leadership plays a more positive role in delivering green buildings due to consideration of social responsibilities and the interests of secondary stakeholders (Du et al.2013), entrepreneurial spirit. The acceptance of social

responsibility is one of the initial moves of housing developers in delivering green real estate. Environmental protection and energy saving are important aspect of company social liability. As a leading property developer, one of the primary goals of the Vanke Group has always been to undertake social responsibilities. Since 2008, the Vanke Group has added “becoming an outstanding green enterprise” to its developing vision. In 2013, its total Green Building Certification Area reached 596.4 million square metres, while the area with “Green 3-stars” reached 172.7 million square metres (Vanke CSR Report, 2013). China Merchants Property Development Co, a developer ranked second only to Vanke, defines its core values as “Humanism, Responsibility, Outstanding and Co-prosperity”. Its leaders believe the company can only create more social values by bonding together social responsibility and their own competitive advantage. In order to listen to the voices of all stakeholders, a complete CSR system has been established that provides a stage for the stakeholders to express their opinions concerning green building development.

Another impetus from transformational leadership in green building development is generated by entrepreneurship - the spirit to grab opportunities, confront challenges and take risks even in an uncertain environment. Entrepreneurship also inspires creative and innovative approaches. Corporate innovation is revealed in a spirit of **adventure through ‘first-mover strategies’ (Das et al.1998)**. As a new venture, green building faces higher costs, more technical difficulty, greater market risk and other developmental problems compared with traditional building. For this reason, many companies tend to stay with traditional building. But entrepreneurial companies choose to seize the opportunity and encourage staff to develop green building in creative ways. In fact, companies that have **made a successful green transformation always focus on innovation**. For example, ‘green gold’ is a new concept indicating the high rewards that can be obtained from investing in green building technology, and has already been adopted by major real estate companies such as Vanke, Landsea, and Vantone.

Compared with transformational leadership, transactional leaders are inclined to focus on the pursuit of self-interest rather than the interests of secondary stakeholders (Das et al., 1998). They usually lack a spirit of adventure and innovation. Therefore, transactional leaders are not willing to invest in the green real estate market because of the high risk and high-cost. In China, small and medium-sized real estate enterprises pay less attention to green buildings than to the traditional market, which leads them to behave as transactional leaders. Henda Property Enterprises is a representative case of the transactional style of leadership. As the second largest real estate enterprise in China, the Hengda Real Estate Group has invested less in green building over the years. Its business leaders have placed their emphasis on hard-work and a fighting spirit instead of the change and innovation needed in ‘going green’.

At present, there are a total of 112 mature and professional real estate enterprises in China, 27 of which are in a process of green transformation. These enterprises regard green real estate as a corporate strategy. Of the top 10 green real estate enterprises, 6 have written social responsibility and a spirit of innovation into their enterprise vision and business goals. The leadership of these enterprises not only bring their own approach to better development in the green real estate market, but also promote customer awareness and acceptance of green building. In addition, the leadership promotes the development of green building technology and improvement in **laws and regulations**. For example, the green image imposed on the public promotes the developer’s brand and reputation, which can enhance **the developer’s intangible value and improve overall competitiveness accordingly**. In this aspect, the China Merchant Property (CMP) enterprise and one of the top ten developers in the Chinese real estate development industry, provides a good example. According to an interview with one manager in CMP

“A leader does not only lead in performance and capability, but also accepts greater social responsibilities and has a mission to lead the industry to a healthier development .CMP is always committed to external environmental protection so as to secure the long-term value among shareholders and stakeholders. In this way, CMP is on the **way towards making a green and social responsible difference of our own future .”**

Consistent with its mission, China Merchant Property has been promoting the responsibilities of corporate citizenship and green property brand within the Chinese real estate industry, and has gained the trust and respect of society, which in turn has provided the firm with greater opportunities for further development.

4. DRIVERS OF CHANGE

As the “green building” movement gains momentum, many business leaders of key stakeholders, such as developers, governors, and designers, are anxious to understand the use of green building metrics to make the case for a sustainable future. Through a comprehensive literature review, a list of 16 incentive factors has been compiled as optional factors driving the implementation of green buildings. These factors can be classified into three groups in accordance with the guidelines in the extant literature.

4.1 Financial incentives

Many previous studies agree that financial incentives provide both efficient and effective tools for improving the building energy consumption and environmental protection situation (Jaffe et al., 2002; Dennis, 2006; Qian and Chan, 2007b, 2008b). As green projects can offer reduced operating costs while providing an improved working or living environment such as by natural daylight and better indoor air quality, it is therefore considered by many business sectors that the value of buildings designed by sustainable principles is more than that of conventional buildings – the reduced operating costs being a welcome bonus. In this way, the market demand for green buildings could be met (Baldwin et al, 1998; Clark, 2003). The investment needed during the construction period to develop green buildings is 1%-4% more than that of conventional buildings - substantially lower than is commonly perceived (Kats et al., 2008; Zhang et al., 2011). However, the economic returns due to increased property rents, the energy and water savings, reduced waste and lower operation and maintenance costs during the sales and post-sales period are much higher than the increased construction costs (Kats, 2003; Bradshaw et al., 2005; Johnson, 2005; Braham, 2006; Qiu, 2010). Taylor (2009) and Baek (2008) also include incentive money from utility energy efficiency programs, in terms of structural, mechanical, appliances, lighting, and alternative/renewable energy. In order to acquire the expected financial benefit, it is necessary for owners to understand which incentive programs are available to them, the specific details of each program and the products involved. Income tax credit is another important financial incentive (MTETM, 2007; Hawken et al., 1999). For example, a landfill tax was introduced in 1996 at a cost of £7 per tonne of active waste and £2 per tonne of inactive waste (The Sustainability Construction Task Group, 2002). For the installation of new renewable energy equipment, the tax credit has been increased from 15% to 40% of the expenses; and for high-efficiency insulators, a tax credit of 25% of the investment cost (MTETM, 2007). Green building tax credit is also available to corporate and residential taxpayers who construct a new green building or undertake the green rehabilitation of an existing building (USGBC, 2011). In the case of New York, for example, six different tax credit projects are available, which comprise the whole building credit, base building credit, tenant space credit, fuel cell credit, photovoltaic module credit and green refrigerant credit. In addition, many USA municipalities have already offered tax credits and abatements as a means of advancing specific policy agendas to improve green building development.

4.2 Policy incentives of government-related bodies

Recently, government regulations and incentives have led many construction projects to pursue sustainable outcomes (Rahman and Sadehpour, 2010). For example, the EU Energy Performance of Building Directive requires energy performance certificates for all property bought, sold or rented in the commercial and residential sectors (Strong, 2005). In 2002, Germany passed additional energy saving regulations known as EnEV) which set new minimum and mandatory standards for all new residential and almost all new non-residential buildings (Power and Zulauf, 2011). In France, a subsidy of not more than 20% of the construction costs is granted for the general renovation of private dwellings, and grants as well as subsidies are given for renovations to improve energy performance (Baek, 2008). Many studies have explored the best way for the government to motivate the increased development of green buildings (Varone and Aebischer, 2001; Atsusaka and LeVan, 2003; Qian and Chan, 2007). The Density Bonuses Policy offered by the U.S. government could provide an opportunity for municipalities to tie incentives to specific local public policy priorities. For example a higher percentage increase in Floor Area Ratio (FAR) can be offered to clients after green building certification (Hawkins & Wang, 2013).

The access to relevant policies and preferential loans/loan funds is considered as another effective policy incentive (Power and Zulauf, 2011). It is considered favourable for the public sector to offer low interest loans from a large fund to those seeking to build or renovate to verifiable green building standards. In this way, the concerns over the initial costs of a green building retrofit could be eased to a certain extent. Other forms of government policy incentives exist, such as partially or fully refunded development fees (Circo, 2009). As Nolan (2008) reports, for example, because few municipalities and land use agencies in the USA can afford to relinquish revenues, reduced

fees and rebates can only provide meaningful savings to developers if some alternative source replaces the lost revenue involved. **One alternative solution, named a “cost-shifting strategy”, aims to increase the fees paid by traditional projects by an amount sufficient to offset the costs of the green building program.** However, this cost-shifting strategy depends on local circumstances, as expedited review and development bonuses have relatively high value to developers.

“Priority permit processing/reduce the difficulty of the project approval” is another policy incentive (Prum, 2009; Deng, 2012). For example, for developers who adopt specified green building standards several government programs, some aspects of the development permit application are processed more quickly than those submitted by traditional developers (Circo, 2009).

4.3 Corporate-based incentives

Many previous studies agree that corporate-based incentives are both efficient and effective tools to improve the development of green buildings (McMurdy, 1991; Gallarotti, 1996; Warren, 2010). As one of the stakeholders in **sustainable development, real estate developers’ incentives include: positive benefits for corporate business performance (McMurdy, 1991; Castleman, 1987); strengthening of corporate environmental performance (Carroll et al., 1990); establishment of ‘green brands’ in the industry (Gallarotti, 1996); green project awards (Tinker and Burt, 2004; AIA, 2006); meeting various shareholder requirement and benefits (Smart, 1992; Ken and Ratnayaka, 1992); philosophy to build green (internally) (Gallarotti, 1996); added value to the property (Warren, 2010); and Marketing/Good Publicity/Awards (Clark, 2003).** In many cases, the mere presence of green buildings provides much publicity, which can make it easier for developers to attract new tenants or purchasers – especially where energy savings are involved. In this case, the value of faster sales and higher occupancy rates can substantially improve short run business performance (Clark, 2003).

5. CONCEPTUAL CHALLENGES IN ‘GOING GREEN’

Green building development still faces challenges in market penetration (Chan et al, 2009). Business leaders are **also faced with challenges and risks before they make the ‘go green’ decision** - failing to meet the required level of certification for example. This risk may be significant where a large number of projects need to meet sustainability standards (Hancock, 2010).

Developers are one of the key participants in green building. From the developer’s perspective, there are both ideological and operational challenges to be addressed during the decision-making and delivery processes involved. Ideological challenges include a cognitive bias towards green building development from inside and outside the organization. Internal misunderstanding occurs mainly from the leadership and the corporate culture. As discussed in the previous section, transformational leadership is more willing to adopt green building development than transactional leadership as the former has more sense of social responsibility and is more proactive in embracing challenges and taking risks. Moreover, the attitude of the leadership towards green building **development has a profound influence on the choice of development approach for integrating the ‘green’ concept into the enterprise’s personnel management and cultural development. Taking Vanke and Landsea as examples.** Landsea values green building development more than Vanke, due to its cultural characteristics since its establishment. **Due to its investment in ‘green’ technology, Landsea has been engaged in a variety of green projects since the early stage of its formation.** It provides comfortable, energy-efficient, environmentally friendly residential products with highly cost-effective products in the housing market and it continues to expand its growth in green technology. On the other hand, unlike Landsea, Vanke places less emphasis on green building, giving **priority instead to its traditional value of ‘high speed of capital recycling’ and adherence to the Wal-Mart model of development, which features the production of standardized residential developments around the city outskirts to specifically targeted groups of consumers (Guang, 2009).** This external cognitive bias is associated with the public awareness and acceptance of green buildings. Even though the concept of green building has been widely accepted, progress in its adoption is very slow. Newly constructed green buildings are always located in suburbs, such as in a high-tech development zone, which is distant from well-developed public services facilities, such as renowned hospitals and schools. Green buildings are also more expensive in the research and development stages. Consumers may be fond of the advantages of the green building but might not be ready to pay the costs involved.

From the developers’ viewpoint, a major issue also concerns the perceived costs involved. From an operational perspective, the challenges confronted by developers include the cost throughout the building life-cycle. The cost

of building includes construction costs and operating costs, which specifically refers to the research and development expenses (R&D) incurred with green techniques, manufacturing installation costs, and operating and maintenance costs. R&D for green techniques can lead to a significant cost difference between traditional building and green building (Jerry, 2007, and many others), leading to the general perception that green buildings are too **expensive and not worth the extra cost (Kats, 2003). Indeed, Bartlett and Howard's (2000) research indicates that UK quantity surveyors believe that energy efficient and environmentally friendly buildings cost between 5% and 15% more to build from the outset (Bartlett and Howard 2000).**

A particular issue concerns the difficulties involved in estimating costs over the lengthy building life-cycle, with uncertainty surrounding future developments and absence of reliable information and associated risks being a major problem (Cole and Sterner, 2000). On one hand, the RandD costs for green technology increase the initial cost of green building. On the other hand, uncertainty of the application of green techniques increases the risks. For example, green building in China must be tested and may fail in the evaluation, which means that if the building does not reach the Evaluation Standard for Green Building (GB/T 50378-2006), then it cannot be classified as a **“green building”, so that all the effort in the use of green techniques is wasted. The risks can also be defined as opportunity costs. Hence, RandD expenses and opportunity costs both increase the cost of green buildings, and therefore present great challenges for their large-scale adoption. This is reflected in an interview with a developer CEO in talking about the barriers to going green: “ It made sense to me to go green. However, there is still a lack of cost analysis and measurement tools in going green due to the initial development stage. For most of the cases, I need to equip myself and the managerial team with ‘green’ and ‘social responsibility ’ roles, however, when we get down to the cost analysis and measurement tools, we got stuck there. ”**

Other perceived challenges to limit the development of green buildings , as shown below (Larsson, 2009):

- lack of simple funding mechanisms to pay for incremental performance;
- difficulty in measuring environmental performance in an objective and reliable way;
- increasing requirements for specialized skills and knowledge in the design and construction process;
- skill deficits in small design firms and contractors;
- lack of suppliers to provide green construction materials and equipment

There are great challenges, therefore, in converting green building intentions into reality. Ultimately, though, it is our responsibility to adhere to sustainable development and it is imperative that green building is implemented, and developing a mechanism for bringing this about is an important mission.

ACKNOWLEDGMENTS

This research is supported by the Early Career Scheme of Hong Kong Research grant council (Project No: 9048039) · the General Research Funding of Hong Kong Research grant council (Project No: 9042363).

REFERENCES

- [1] Ali, H. H., and Al Nsairat, S. F. (2009). Developing a green building assessment tool for developing countries: Case of Jordan. *Building and Environment*, 44(5), 1053-1064.
- [2] Kats, G., James, M., Apfelbaum, S., Darden, T., Farr, D. and Fox, R. et al. (2008), *Greening Buildings and Communities: Costs and Benefits*, Good Energies, New York, NY.
- [3] Kats, G. (2003). *Green building costs and financial benefits* (p. 1). Boston, MA: Massachusetts Technology Collaborative.
- [4] Kouzes, J. M., and Posner, B. Z. (2012). *The leadership challenge: how to make things happen in organizations*. Jossey-Bass.
- [5] **Larsson, N., 1998. Green Building challenge '98: international strategic considerations. *Building Research and Information*, 26 (2), 118-121.** Larsson, N. (2009). SB state of the art. The International Initiative for a Sustainable Built Environment http://www.byggalliansen.no/dokumenter/september_09/intend/Sustainable_building_state_of_art.pdf
- [6] Lee, S., Lee, B., Kim, J., & Kim, J. (2013). A Financing Model to Solve Financial Barriers for Implementing **Green Building Projects. *The Scientific World Journal*, 2013.** Lin M. (2012). **Analysis on stakeholders' behavior during green building development. *Construction Economics*, 12, pp. 63-66 [in Chinese]**

- [7] Lin, H., Zeng S.X., Ma H.Y., Qi G.Y., and Tam V.W.Y.. "Can political capital drive corporate green innovation: Lessons from China", *Journal of Cleaner Production*, 2013.
- [8] Roodgar M., Mahmoudi, M., Ebrahimi, P., Molaei, D. (2011). Sustainability architectural topology and green building evaluations of Kashan-Iran as a hot-arid region, *International conference on green buildings and sustainable cities. Procedia Engineering*, 21:811.
- [9] McMurdy D. (1991). Green is the **Color of Money**. *Maandan's* 104, 49-50.
- [10] Metz, B. (Ed.). (2001). *Climate change 2001: mitigation: contribution of Working Group III to the third assessment report of the Intergovernmental Panel on Climate Change (Vol. 3)*. Cambridge University Press.
- [11] MTETM (Ministère des Transports de l'Équipement du Tourisme et de la Mer) (2007). **Acquisition-amélioration et amélioration des logements locatifs**. Ministère des Transports de l'Équipement du Tourisme et de la Mer. [in French].
- [12] Nolan 2008)
- [13] Qiu, B.X. (2010), Speech on the 6th Green Building Conference, Ministry of Housing and Urban-Rural Development (MOC), Beijing.
- [14] **Qu, M., Pelkonen, P., Tahvanainen, L., Arevalo, J., and Gritten, D. (2012). Experts' assessment of the development of wood framed houses in China. *Journal of Cleaner Production*, 31, 100-105.**
- [15] Rahman, F., & Sadeghpour, F. (2010). Canadian industry practitioners' perception on LEED credits. In *Construction Research Congress* (pp. 1547-56). University of Alberta and the Construction Institute of the American Society of Civil Engineers..
- [16] Sayce, S., Ellison, L., & Smith, J. (2004). Incorporating sustainability in commercial property appraisal: evidence from the UK. *Australian Property Journal*, 38(3), 226. Seo, S., Tucker, S., Ambrose, M., Mitchell, P., Wang, C.H. (2006). Technical evaluation of environmental assessment rating tools, Research and Development Corporation, Project No. PN05.1019.
- [17] Carroll, A. B., & Shabana, K. M. (2010). The business case for corporate social responsibility: a review of concepts, research and practice. *International Journal of Management Reviews*, 12(1), 85-105. Du, S., Swaen, V., Lindgreen, A., & Sen, S. (2013). The roles of leadership styles in corporate social responsibility. *Journal of business ethics*, 114(1), 155-169. Smart, B. (Ed.) (1992). *Beyond Compliance: a New Industry View of the Environment*, World Resources Institute, Washington. Smith, Alan D. 2007. Making the case for the competitive advantage of corporate social responsibility. *Business Strategy Series* 8.3, pp.186-195.
- [18] Soleri P. (1969) *Arcology: The city in the image of man* [M]. Cambridge, MA, USA: MIT press.
- [19] Strong, D. (2005), *Toughen up on Energy*, Energy & Geoscience Institute, Salt Lake City, UT, available at: www.egi.co.uk/egarchive_detail.asp?arch_id=205154 (accessed 13 December 2005).
- [20] Taylor R.P. (2009). Achieving sustainability in world bank energy efficiency projects: lessons learned developing ESCOs in China *Strategic planning for energy and the environment*, 29 (1), pp. 32-41
- [21] Herbst, T. H., & Conradie, P. D. (2011). Leadership effectiveness in Higher Education: Managerial self-perceptions versus perceptions of others. *SA Journal of Industrial Psychology*, 37(1), 01-14.
- [22] (The) Sustainability Construction Task Group (2002), *Reputation, Risk and Reward: The Business Case for Sustainability in the UK Property Markets*, available at: <http://www.dti.gov.uk/construction/sustain/rrnr.pdf> (accessed 22 March 2006).
- [23] The Commission for Environmental Cooperatio. (2008). *Green building in North America*, available at website: <http://www3.cec.org/islandora/en/item/2335-green-building-in-north-america-opportunities-and-challenges-en.pdf>
- [24] **Tinker, A., & Burt, R. (2004). Greening" the construction curriculum. *International Journal of Construction Education and Research*, 9(2), 26-33.**
- [25] Torre, J. (2013) *Affordable Housing 2013: Tax and regulatory reform in a changing economy*. http://www.reznickgroup.com/sites/reznickgroup.com/files/papers/rg1032_wp_developers_going_green.pdf
- [26] Vanke CSR Report, 2013. Available at website: <http://www.vanke.com/en/newstext.aspx?id=1770&u=CitizenshipNav>
- [27] Varone, F., & Aebischer, B. (2001). Energy efficiency: the challenges of policy design. *Energy Policy*, 29(8), 615-629.
- [28] Warren, P. (2010). *Uptake of micro-generation among small organisations in the Camden climate change alliance* (Doctoral dissertation, Durham University). Yudelson J. (2007) *The green building revolution* [M]. Island Press.
- [29] Yunna, W., and Ruhang, X. (2013). Green building development in China-based on heat pump demonstration projects. *Renewable Energy*, 53, 211-219.

- [30] **Zhang, X., Wu, Z., Feng, Y., & Xu, P. (2014). "Turning green into gold": a framework for energy performance contracting (EPC) in China's real estate industry.** *Journal of Cleaner Production.* Zhang S. (2007). Principal leads the strength: background, connotation and practice. *Journal of the Chinese Society of Education*, 9, pp: 42-47
- [31] Zhang X., Plattern A., and Shen L.Y. (2011). Green property development practice in China: Costs and barriers, *Building and Environment*, 46 (11), 2153-2160
- [32] Zhang X., Shen L., and Wu Y. (2011). Green strategy for gaining competitive advantage in housing development: a China study. *Journal of Cleaner Production*, 19, pp: 157-167
- [33] **Zhong L., (2011). China Merchant Property: 'green system' will improve corporation's competitiveness. 21st Century Economic Report.** < <http://www.21cbh.com/HTML/2011-11-25/zMMDcyXzM4MzEzMQ.html> > (Accessed on 25 September 2011) [in Chinese]

Analyzing the Reference Flows for Energy Efficient Retrofit of Typical Residential Building in Tianjin, China

LIU Lu^a, YANG Wei^b, MA Lingbo^c, YU Hanze^d

^a School of Architecture, Tianjin University, Mainland China, lucia_liu@tju.edu.cn

^b School of Architecture, Tianjin University, Mainland China, walker_yang@tju.edu.cn

^c School of Architecture, Tianjin University, Mainland China, 732875444@qq.com

^d School of Architecture, Tianjin University, Mainland China, hanzeyu@usc.edu

ABSTRACT

Previous studies related to energy efficient retrofit of the existing building stock mostly focused on operational energy reduction either on individual building or on the national and urban level. The evolution of the urban building stock in a resource conservation perspective needs to be further studied. The material and monetary investment and the embodied energy and carbon of building refurbishment need to be examined. However, the life cycle inventory data for reference buildings need to be refined based on thorough case studies. The objective of this study is to obtain the reference flow in the energy efficient retrofit processes of typical residential building, in order to provide accurate data basis for the simulation of the evolution of the residential building stock in a certain urban area. This contribution selects a fragment in the city of Tianjin for a case study. Through field investigation and data collection, we establish the information database for one typical apartment building, which is described in detail with BIM. The LCA results of different retrofit scenarios are analyzed with a BIM-based LCA tool, Tally. The costs are calculated with the quantity data derived from BIM and the prices for Chinese building material and energy. The results will provide reference data for urban fragment simulation in Tianjin and in similar cities in northeast China.

Keywords: residential building, energy efficient retrofit, life-cycle assessment

1. INTRODUCTION

After decades of high-speed development, China's urban construction is getting slow. The planning of the renewal about the building environment has become a major concern in this country's urban development. For many existing buildings, the high energy consumption along with their short life cycles, poor thermal comfortable conditions, and other issues have made their energy efficient retrofit a critical work under the background of urban renewal. In this paper, the Hongshunli community at Hebei district in Tianjin, China is picked as the study case. There are a large number of residential buildings built around the 1980s to 1990s, among which most of them need to be repaired, renewed or demolished as time goes by. In this study, one typical residential building built in the 1980s is selected. The goal is to achieve 65%

and 75% energy saving by proposing an energy efficient retrofit strategy according to the energy conservation design standard of Tianjin. On the basis of this, a complete Revit model of the building is built to conduct the life cycle assessment with Tally, and add-in for Revit. The result contains the material consumption, ecology and costs indexes of the typical building during the life cycle stages of energy saving renovation, operation, and demolition, providing accurate and complete background data for the existing tool named FRASIM established by our group.

2. DEFINITION OF TYPICAL RESIDENTIAL BUILDINGS

2.1 Goal of energy efficient retrofit in Tianjin

There is no energy saving design standard for residential buildings in Tianjin before 1991, only a so-called test data of 1980-1981 Residential general design heating energy consumption level. In order to implement building energy efficiency, Tianjin proposed the four-step energy efficiency standards on the new residential buildings. At present, the goal of energy efficient retrofit of existing residential buildings in Tianjin is to achieve the third step energy-saving (65%), so the study is based on the standard to achieve 65% and 75% energy saving. Table 1 shows the standards for heating energy consumption in Tianjin.

Steps of Energy Saving	1980-1981	the First Step Energy-saving (30%)	the Second Step Energy-saving (50%)	the Third Step Energy-saving (65%)	the Fourth Step Energy-saving (75%)
Heating Energy Consumption (KWh/ m ² a)	147.34	116.76	69.50	55.6	37.04

Table 1: Standards for heating energy consumption in Tianjin

2.2 Basic information about typical residential building

Reference buildings are chosen for the case study urban fragment in Tianjin according to the main features including their year of construction, number of floors, energy saving standards and their structure and material. (Table 2) Five residential buildings in the case study fragment were chosen as representatives of the majority of the housing stock in certain periods. Due to the length limit, this article focuses on one typical building named Sanjieli No.4, which is a 3-story building of brick-concrete structure built in 1980.

Time Period		1976-1991	1992-1999	2000-2004
Main Building Structure		Brick-Concrete	Brick-Concrete	Reinforced Concrete
		Prefabricated Concrete Panel	Prefabricated Concrete Panel	
Number of Stories	Low-rise (1 - 3)	●	/	/
	Mid-rise (4 - 6)	●	●	●
	High-rise (> = 7)	○	●	●
Energy Saving Standard		No	First Step (30%)	Second Step (50%)

Note: ● ————> ○
Majority —————> Few
(Black rectangles are defined as features of typical buildings)

Table 2: Definition of typical residential buildings in the city of Tianjin

Sanjieli No.4 belongs to the reconstruction project of Hongshunli-Huangwei Rd area after the earthquake in 1976. It is designed with no energy saving strategy. The construction time and structural system of Sanjieli represent the general characteristics of residential buildings in Tianjin in the 1980s which are suitable for research as a typical building. Table 3 shows its basic information.



Built Age	Building Structure	Storey Number	Building Area	BIM Model	Building Image
1980	Brick-Concrete	3	1603.5 m ²		

Table 3: Basic information of Sanjieli No.4 building

3. RETROFIT STRATEGY OF TYPICAL RESIDENTIAL BUILDING

According to the **related energy efficient retrofit files and cases in Tianjin, the strategy of Tianjin's residential buildings** mainly focus on the building envelope, heating, and air conditioning, ventilation system, solar energy system and some other aspects, in which the building envelope and heating system take a large part of it. In this way, this article will mainly focus on the retrofit of these two aspects.

3.1 Building envelope

3.1.1 External wall insulation

A layer of 50mm expanded polystyrene insulation board will be used for the 65% energy saving goal and the 80mm one will be used for the 75% goal.

3.1.2 Roof insulation

The XPS Extruded polystyrene insulation board is used while aiming at 65% energy saving and the thickness is 70mm. Rigid polyurethane board is used at the 75% goal and the thickness is 100mm.

3.1.3 Energy saving of external window

65% energy saving

There are two conditions with the external window retrofit:

- If the windows are already replaced with single-glazed window with aluminum or PVC-steel frame by the residents, an additional layer of single-glazed window with PVC-steel frame will be added to the outside of the existing ones.
- If the windows have not been replaced, the single-glazed window with old steel frame will be replaced with double-glazed windows with the PVC-steel frame.

75% energy saving

If the goal is set to 75% energy saving, all the original windows need to be replaced with triple-glazed window with aluminum frame.

3.2 Heating system

In practice, the retrofit of heating system should be carried out from the indoor system, outdoor pipe network, and heat station. As the research scope of this article focuses on the building itself, only the indoor system is discussed.

The original indoor heating systems of the two typical buildings are separated sub-ring system which has been used for more than 25 years. All the equipment (pipes, radiators, valves, etc.) of the system have reached the usage limit and need to be replaced. The heating system after the retrofit will use a vertical dual-tube system and has an individual metering function.

4. LCA AND LCC ANALYSIS OF TYPICAL BUILDING ENERGY EFFICIENT RETROFIT

For each typical building, the following three possible scenarios are listed:

Scenario 1: Present → 65% energy saving → Demolition

Scenario 2: Present → 75% energy saving → Demolition

Scenario 3: Present → 65% energy saving → 75% energy saving → Demolition

Scenario 1 is to retrofit the typical building to 65% energy saving at one step and keep operating under this condition till its demolition. Scenario 2 is to retrofit the typical building to 75% energy saving at one step and keep operating under this condition till its demolition. Scenario 3 is to retrofit the typical building to 65% energy saving

at the first step then another retrofitting may happen later if the structure is still in good form to improve the condition to 75% energy saving and keep operating under the new condition till its demolition.

4.1 Sanjieli No.4

4.1.1 Energy efficient retrofit of Sanjieli

65% energy saving

The U-value of each envelope after 65% energy saving are: External wall U-value=0.442 W/(m²•K), Roof U-value=0.3261 W/(m²•K), External window U-value = 2.4 W/(m²•K). The heating demand after the simulation in IES(VE) software is 54 KWh/m². Table 4 shows the amount and cost of the materials used during 65% energy saving efficient retrofit of Sanjieli.

Amount	Project	the Weight per Square Meter (kg/m ²)
	Demolished Material	39.84
	Added Material	83.08
Cost	Project	the Cost per Square Meter (yuan/ m ²)
	Recycling Price	10.39
	Input Price	318.41
	Gross (Input- Recycling)	308.02

Table 4: Amount and cost of the materials used of scenario 1 (Present → 65% energy saving)

Table 5 shows the amount of the greenhouse gas emission and the primary energy consumption of the materials used during 65% energy saving efficient retrofit.

	Global Warming Potential Total (kgCO ₂ eq/ m ²)	Non-renewable Energy Demand (MJ/ m ²)
Demolished Material for recycling	-4.72	-38.32
Added Material	62.02	642.46
Total	57.31	604.14

Table 5: Amount of the greenhouse gas emission and the primary energy consumption of the materials used during scenario 1 (Present → 65% energy saving)

75% energy saving

The U-value of each envelope after 75% energy saving are: External wall U-value = 0.3205 W/(m²•K), Roof U-value = 0.1968 W/(m²•K), External window U-value = 1.47 W/(m²•K). The heating demand is 36 KWh/ m². There are two different scenarios under the 75% energy saving situation:

Scenario 2: Present → 75% energy saving

Amount	Project	the Weight per Square Meter (kg/m ²)
	Demolished Material	39.84
	Added Material	84.07
Cost	Project	The Cost per Square Meter (yuan/ m ²)
	Recycling Price	10.39
	Input Price	394.31
	Gross (Input- Recycling)	383.92

Table 6: Amount and cost of the materials used of scenario 2 (Present → 75% energy saving)

	Global Warming Potential Total (kgCO ₂ eq/ m ²)	Non-renewable Energy Demand (MJ/ m ²)
Demolished Material for Recycling	-4.72	-58.99

Added Material	79.70	738.03
Total	74.98	679.04

Table 7: Amount of the greenhouse gas emission and the primary energy consumption of the materials used during scenario 2 (Present → 75% energy saving)

Scenario 3: 65% → 75% energy saving

Amount	Project	the Weight per Square Meter (kg/m ²)
	Demolished Material	83.08
	Added Material	84.07
Cost	Project	the cost per Square Meter (yuan/ m ²)
	Recycling Price	9.80
	Input Price	394.31
	Gross (Input- Recycling)	384.51

Table 8: Amount and cost of the materials used in scenario 3 (65% → 75% energy saving)

	Global Warming Potential Total (kgCO _{2eq} / m ²)	Non-renewable Energy Demand (MJ/ m ²)
Demolished Material	95.56	-1142.98
Added Material	79.70	738.04
Total	175.25	-404.94

Table 9: Amount of the greenhouse gas emission and the primary energy consumption of the materials used during scenario 3 (65% → 75% energy saving)

4.1.2 General maintenance and retrofit of Sanjieli (Except energy efficient retrofit)

In addition to the initial investment in energy saving retrofit, the repair and replacement of other building components and materials are also happening during the life cycle of the building. Table 10 shows the environmental impacts and amount of the other building components during their repair and replacement.

Building Component	Macro-component	Life	Amount	Global Warming Potential	Non-renewable Energy Demand	Renewable Energy Demand
		year	kg/m ²	kg/m ²	MJ/m ²	MJ/m ²
Interior Door & Window	Holistic	40	3.39	5.48	54.38	32.31
Exterior Wall	Interior Mortar	50	33.60	19.84	113.82	2.77
	Interior Painting	10	0.13	0.33	7.36	3.35
	Exterior Mortar	30	33.60	19.84	113.82	2.77
	Exterior Painting	15	0.13	0.33	7.36	3.35
Interior Wall	Interior Mortar	50	99.94	59.28	339.97	3.74
	Interior Painting	10	0.39	0.99	21.98	3.74
Floor	Mortar	50	75.35	44.71	256.43	104.26
	Painting	10	0.29	0.75	16.58	104.47
Ceiling	Mortar	50	30.99	18.41	105.58	125.68
	Painting	10	0.12	0.31	6.83	124.31
Stair	Mortar	50	5.71	3.39	19.42	123.91
	Painting	10	0.02	0.06	1.26	128.19
Total		/	283.66	173.72	1064.79	762.85

Table 10: Environmental impacts and amount of the other building components

For other equipment systems, due to a wide range of materials and difficult to estimate, this article courts their default values by referring to other retrofit cases, shown in Table 11.

Equipment System	Material	Life	Amount	Global Warming Potential	Non-renewable Energy Demand	Renewable Energy Demand
		year	kg/m ²	kg/m ²	MJ/m ²	MJ/m ²
Ventilation	Steel Zinked	30	0.77	1.84	22.05	1.07
	Mineral Wool	30	0.13	9.12	106.57	9.48
Water Distribution and Sanitary	Steel	30	0.72	0.59	7.99	0.88
	PIR, PVC	30	0.20	1.01	12.56	1.04
Electricity	Steel Zinked	30	0.19	0.45	5.43	0.26
	Copper Cable	20	0.96	1.63	16.83	1.92
	PVC, PUR	20	0.29	1.47	18.21	1.51
Total		/	3.26	16.11	189.64	16.16

Table 11: Environmental impacts and amount of the other equipment system

4.1.3 The Demolishment phase of Sanjieli

According to the previous analysis, the typical building may be demolished after 65% or 75% energy saving retrofits. Table 12 lists the statistics of the demolition after different energy saving stages.

Energy Saving Goal	Amount of demolished material	Global Warming Potential	Non-renewable Energy Demand	Renewable Energy Demand	Cost
	kg/m ²	kgCO _{2eq} / m ²	MJ/ m ²	MJ/ m ²	yuan/ m ²
65%	2701.58	69.76	1086.40	41.90	-84.50
75%	2699.99	64.53	1036.24	17.58	-83.81

Table 12: Statistics of the demolition after different energy saving stages

5. DISCUSSION

It can be resulted from the compare of the buildings before and after the retrofit that the heating energy consumption is reduced, following with the deduction of gas consumption which used as the resource of heating. Table 13 shows the comparison of the heating energy consumption, heating price and ecological index before and after the retrofit.

Index	Stage	Sanjieli No.4
Terminal Heating Energy Consumption (KWh/ m ² .a)	Present Situation	125.3
	65% Energy Saving	54.3
	75% Energy Saving	36.1
Heating Prices (yuan/ m ²)	Present Situation	23.8
	65% Energy Saving	14.6
	75% Energy Saving	12.2
Global Warming Potential Total (kgCO _{2eq} / m ²)	Present Situation	38.1
	65% Energy Saving	16.5
	75% Energy Saving	11.0
Primary Energy Demand Total (MJ/m ²)	Present Situation	634.2
	65% Energy Saving	274.9
	75% Energy Saving	182.7

Table 13: Comparison of the heating energy consumption, heating price, and ecological index

In the previous calculation, the external walls and roofs also contain the general maintenance items. The original residential heating system has been used for more than 30 years which has reached the service life, so the replacement of the indoor heating system is also a maintenance that should not be included in the cost of energy

efficient retrofit. The real investments, annual net cash flow and a static payback period of energy efficient retrofit with the consideration of the general maintenance items should be like Table 14.

Sanjieli No.4	Investments (yuan/m ²)	Annual Net Cash Flow (yuan/m ²)	Static Payback Period (year)
Scenario 1 (Present→65%)	205.0	16.7	12.3
Scenario 2 (Present→75%)	283.9	19.1	14.9
Scenario 3 (65%→75%)	282.9	2.4	117.9

Note: Calculation method of static payback period: $n=I/A$

n - static payback period (year)

I - energy saving investments (yuan/ m²), calculated by the cost of energy efficient retrofit

A - annual net cash flow (yuan/ m²), calculated by the heat metering price

Table 14

Sanjieli No.4	Primary Energy Consumption of Retrofit	Primary Energy of Heat Saving	Payback Period of Energy Consumption
	(MJ/m ²)	(MJ/m ²)	year
65% (Present→65%)	600.6	359.3	1.7
75% (Present→75%)	679.0	451.4	1.5
75% (65%→75%)	225.9	92.2	2.5

Table 15: The payback period of primary energy consumption

It can be seen from the table 15 that scenario 1 and scenario 2 are basically able to recover their investment over a period of 10 years. At the same time, the payback periods of primary energy consumption of all the scenarios are relatively short and the investment payback periods of scenario 1 and scenario 2 are reasonable. However, the investment payback period of scenario 3 is too long to meet the economic efficiency. Consequently, it is feasible to adopt the energy efficient retrofit in scenario 1 and scenario 2 for the typical buildings in this article. It should be pointed out that the payback period is calculated in the ideal condition. If taking the rebound effect into account, the period should be longer.

For cities in the cold climate zone of China, heating accounts for the major part of the total energy consumption. Therefore, the energy-saving standards mainly set benchmarks for heating energy consumption. The consumption from hot water or other household appliances is not directly relevant to the energy efficient retrofit due to the **uncertainties of residents' behaviours**. Therefore, this paper focuses on the variations related to the space heating. Hot water and other energy demands are set as default values in energy simulation software (IESVE).

It's important to note that the retrofit strategies will have an unintended effect of making the building hotter in summer. It is partly proved by the results of cooling energy consumption in the rough energy simulation (Table 16). But the increase in cooling energy consumption is negligible in comparison to the decrease of heating energy consumption. To get more accurate results for the change of cooling energy consumption under different retrofit scenarios, further study on the indoor temperatures of different rooms according to their exposures need to be conducted.

Scenarios	Cooling Energy Consumption (KWh/ m ² .a)
Current Situation	5.9
65% energy saving retrofit	6.1
75% energy saving retrofit	6.3

Table 16: Simulation results of cooling energy consumption

6. CONCLUSION

The energy efficient retrofit of the typical residential building reduces its heating energy consumption and improves the living comfort of tenants. In the meantime, the repair and replacement of old components extend the lifespan of the building. The retrofit strategies to reach different levels energy saving standards and the resulting reference flows (primary energy, GWP, costs, etc.) in different life cycle stages (retrofit, repair, replacement, demolition and recycling) are analysed in this study, which could provide reference values for the energy efficient retrofit of existing buildings in cold climate zone of north China. With the analytical results of more typical buildings, the environmental and economic cost benefit of the strategies for urban housing stock update can be estimated.

ACKNOWLEDGEMENT

This contribution is supported by Project 51478294, 51628803 funded by NSFC, the Program of Introducing Talents of Discipline to Universities (B13011), and by the International S&T Cooperation Project 2014DFE70210 funded by the MOST. Prof. Niklaus Kohler had contributed to the scientific thoughts of the study. The authors sincerely thank the reviewers for giving valuable advices and comments.

REFERENCES

- [1] Existing Residential Building Energy Conservation Transformation Started to Promote Large-scale Green Building [on line]. Retrieved from: <http://news.enorth.com.cn/system/2015/03/11/030075257.shtml> [Retrieved on 11 March 2015].
- [2] Heating Prices [online]. Retrieved from: http://www.tjdpc.gov.cn/qzcx/syjqcx/gr/201307/t20130705_30045.shtml [Retrieved on 20 May 2016].
- [3] Tangshan Building Energy Conservation Office, Physics Study Branch of China Academy of Building Research, 2007. Basic Situation Investigation of Hebei No.1 Community in Tangshan. The Construction of Science and Technology, Tangshan.
- [4] Tangshan Construction Bureau, 2008. Project Summary of Hebei No.1 Community in Tangshan. The Construction of Science and Technology, Tangshagn.
- [5] **Tianjin Urban and Rural Construction Management Committee, 1999. 50 years' Construction in Tianjin.** Zhuhai Publishing House, Zhuhai.
- [6] Xia, J.J. and Jiang, Yi., 2015. The Determination Method for Heating Index Values of Civil Building Energy Consumption Standard. Construction Science and Technology, 14,51-55.
- [7] Yang, Y. and Lu, Y., 2011. Energy-saving Rate and Energy Saving Strategy Analysis of Tianjin residential buildings. Gas & Heat, 31(6), 19-21.
- [8] Yu, L.F., 2014. Research on Energy Saving Retrofit of Existing Residential Buildings. MD. Tianjin University.
- [9] Zhang, L.F. and LI, Z.G., 2005. Development of Building Energy Saving. Building Technology, 10:4-6.

Session 5.4: Deep Renovations – Policies & Standards

Small, Beautiful, Yet Difficult: Energy Plus Renovation in Small Social Housing Companies

Christian KOCH^a, Anders LUTTEMAN^b

^a Chalmers University of Technology, Sweden, kochch@chalmers.se

^b Chalmers University of Technology, Sweden, anders.lutterman@chalmers.se

ABSTRACT

Social housing represents a particular challenge of creating sustainable buildings. Large portfolios of post second world war concrete blocks type of building is the epitome of this issue. They are in serious need of renovation to meet future demands of energy consumption and sustainability. This even involves the important aspect of social sustainability. At a time new energy producing renewable technologies represent important contributions to the mitigation of these challenges. This is also the case in Sweden. However, here, beneath the dominant agenda of suburbs to large cities, a series of small social housing company actually operate which have similar issues, yet receive far less attention. The aim of this contribution is to discuss challenges of carrying out energy plus renovation of small social housing companies in Sweden and to present a possible roadmap for meeting the challenges. The theoretical framework draw on conceptualisations of small organisations characteristics, building research on small clients and political science approaches to the role of regulation. The empirical material has been gathered through collaboration with one company and its network among other small housing companies in its area. Research collaboration extends over a year of study. The results show that the limited resources of small social housing companies has to be mitigated through developing a new financial model enabling the rent to stay stable, providing extra manpower in the purchasing process and a network for identifying energy producing and less consuming technologies for the renovation. A roadmap for carrying out renovation is suggested involving all phases of purchasing and operating renovated building blocks. The roadmap suggest moreover systematic involvement of tenants in the process.

Keywords: Social housing, energy renovation, roadmap

1. INTRODUCTION

The Swedish Post War suburban housing construction projects constitute of nearly 1000000 apartments, hence the name “**The million program**”. **All of which came in to place between the years 1965-1974** as a response to the huge demand of housings from a growing population and urbanization. 600 000 apartments of the Million program is in need of renovation and there is a big challenge in both making them energy efficient and to keep the overall cost as low as possible (Lindén, 2015). In the larger cities of Sweden many of these renovations has lead up to an un-proportional rise in rental levels. These higher rents in turn generate gentrification and social exclusion in some areas. The renovation processes in it self is a complex task that requires special knowledge and practical **experience from both developers and hired contractors. Houses of “The million program”**, and especially the ones in the rural regions of Sweden pose a huge challenge for both owners and tenants. If politicians and owners are to be successful in their aim to renovate all dwellings a new and dramatically different approach needs to be put in place. One of many obstacles that social housing companies have to handle is the tension between different paragraphs in a new legislation from 2011, governing social housing companies. The new law stipulates that a social housing company needs to act as independent subsidiary with standardized market commercial demands on profit and turnover. (Blomé, 2012). Finally and the particular focus of this paper is the many small municipalities and their social housing companies, which is working from a rather different financial and managerial condition compared to the bigger sisters and brothers in the Big City regions of Sweden. This gives raise to this paper main questions:

- What obstacles are commonly addressed by the smaller social housing companies whilst executing a renovation program?
- What kind of actions and steps is feasible to pursue in the renovation process?

And as sub questions to the second main question:

- How to manage, create and distribute knowledge in order to enhance the owners/clients role through out the renovation process and the procurement process?
- What kind of strategy can be considered by a small housing company when handling owners demand, legal and bureaucratic processes in order to create a driving force and willingness for collaboration between all stakeholders?

The paper is structured in the following manner. It commences with providing information on the methodological set up. Then the framework of understanding is given. Then two major section answers to the main questions of the paper. The second section provides a brief presentation of the roadmap suggested to guide small social housing companies in energy plus renovation the paper ends with a conclusion.

2. METHOD

The paper has exploratory character and draws on organisation and management as well as energy renovation literature. Several consecutive literature searches has been made to better underpin and understanding and conceptualisation of the concepts of the clients, energy plus renovation, energy renovation building processes, procurement in building etc. The empirical part has been developed through conversations and observations, in partnership with one small social housing company starting autumn 2015 and during 2016 within the frame of a economic project support from the Swedish Energy Agency. We conducted nine interviews with people who have extensive experience in municipal companies implementing energy renovations or installation of energy producing technologies. Also the researchers have attending meetings between a group of social housing companies that are close to each other geographically and in size. The companies share the same features of being small in size and owned by municipalities in the countryside regions of Västra Götaland. Gathering together this material made it possible for us to condense a few central challenges and suggest a strategy in the shape of a roadmap. It is a limitation that our research has been attached to one social housing company mainly. However at a time that also provided us with valuable knowledge of the challenges of small social housing companies.

3. FRAMEWORK OF UNDERSTANDING

Below are gathered the theoretical elements to respond to the aims of the paper. This includes the understanding of small building clients, facing energy renovation and other challenges and the conceptualisation of the needed building processes. The literature is sparse on small and medium sized building clients, and even more so on small social housing companies. We contend that small building clients in many ways can be compared to other SMEs, also building SME meaning they lack internal resources, they have an informal internal organisation (Hardie 2010, Lu et al 2008, author reference) and energy renovation is not an area were these organisations have extensive competences (Alhourani and Saxena 2009, Granderson et al 2016, Schleich and Gruber 2008). They therefore need to rely on external networking and contracting of competences such as client counsellors. The process of **renovation is therefore very much an issue of learning, but also on making choices i.e. it's a political process** (author reference). This stand in contrast to many conceptualisation of Building processes, where rational phase model dominate (an example is Sutt 2011). These dominant models also usually assume that the client have endless resources an underestimate the importance of emergent learning and political processes. One central early choice is the procurement form. Normally clients opt for either a design bid build, design build or partnering contracts (Bresnen 2007). Design bid build can be understood as an instrument for handling risk as it provide the client with a clear milestone in the process separating design and production, this mean negotiating time and resources in two steps. On the other hand design build and partnering contract make it possible to utilize the contractors competence early in the design phase, and at a time involves negotiating the building sum early (Sporrong and Kadefors 2014). Our framework for the energy plus renovation thus takes into concern that the client is small. Moreover it is indeed constructed as a phase model, because this provides an attractive order of the argument, yet also knowingly that the actual process will not follow a neat scheme.

4. ADDRESSING THE CHALLENGES

Below we address three challenges: the dialogue with tenants, collaboration with partners and legal issues related to energy use.

4.1 The dialog with tenants

A recurring theme during a renovation of social housing is the importance of maintaining a good and healthy relationship with tenants. Historically there are examples of when the The Swedish Tenants Association along with tenants have caused delays and altered the renovation project. This underline why many housing companies have invested considerable resources to engage the tenants and to give them a strong influence on the renovation process. There are examples of renovations where the interaction has become so fruitful that tenants themselves became the main driving force. Giving tenants the opportunity to choose the level of renovation standard is a mean to make the tenants be a part of the renovation process. Some argue that this kind of engagement from the developers is only there as a facade in order to get a smooth and efficient renovation process. Others believe that a strong commitment from tenants themselves improves and streamlines the process and that the dialogue is the alpha and omega of a successful renovation. Regardless, this means that in any case a lot of work when you involve the tenants (Author reference). There are tenant dialogues that have proved to work. On those occasions it has for example been a key person who have had special knowledge and skills to manage the tenant dialogue. If the company does not have such a resource available, a tenant dialogue run the risk of being counter-productive instead. Through a fruitful tenant dialogue it is possible to reach a sort of binding agreement in which both the developer-landlord and the procured contractors together with the tenants' association and tenant agree on the future with regard to costs, quality and choosing materials and renovation standards.

4.2 Collaboration and working together as partners

The choice of procurement process is a challenge. Coordination and collaboration in renovation often proved to be complex. Partnering is one method developed for interaction which tries to streamline the construction and renovation process (Bresnen 2007). The partnering concept is based on the developer and the contractor agree to work together for a common goal and where the risks and benefits are shared equally. Moreover, it is about establishing practices that create and maintain personal relationships in the renovation process. It is also about creating procedures for what to do when a conflict arises or how to measure and control how well the various objectives have been achieved. It may involve two different types of targets. First measurable goals related to the project's impact on the economy, energy efficiency or social betterment of society. Second to set goals about how the stakeholders internally act and behave against each other. This can include goals for responsibility, how much information one should share with each other or targets on how to improve cooperation. Partnering cooperation objectives and procedures relates to all persons who have an active and central role in the planning, design, construction and maintenance. This includes project managers, craftsmen, the developer and the owners and management and other consultants (Kadefors, 2002). The concept of open books provide insight for each participant in the partnership, and improves both trust and frank dialogue. The way to work should be through a current account with the so-called incentives consisting of financial targets attracting contractors and consultants to work more efficiently and more rational in order to be able to receive bonuses or share of profits.

4.3 Legal and financial issues may reduce energy saving

The questions about law versus finances are multiple and complex. At a first glance it could come across like a simple technical vs. mathematical problem. Instead law and subsequent beurocracy is complex and involve many different levels. For example; The construction legislation in Sweden exhibit trade-offs between the requirements on emergency exits, ventilation requirements or any other compelling solutions which in some cases stands in the way of the most energy efficient solution. In such situations it is important to understand and collaborate between administrators and stakeholders within the municipality so that the right technology is selected with respect to legal aspects. It becomes important to understand how the flow of information ought to function between relevant officials and consultants all the way through the blue collars and their practical knowledge. (Author reference 2015). To achieve set goals within a renovation the developer will be faced with various choices and trade offs. It is the final goal and mission set by the developers along with the choosen time horizon that governs the size and type of the investment trade-offs. The following factors should be taken into account:

- Social responsibility of the municipality and the property's tenants (by extension the whole municipality's population) (Lind et al. 2014)
- Laws, regulations and directives that govern the expected standard on the company's properties
- Environmental responsibility (regulated by the owners and the state)
- The discount rate that is controlled by the internal and external market factors

- Depreciation requirements controlled by the timing aspect of choosing the investment horizon (Byman and Jernelius, 2012)
- How to evaluate in monetary terms the improvements coming from investing in soft social values and also how to put this monetary figure into the investment calculations evaluating future profit and success (Johansson, 2012, Lind, 2014)

5. HOW TO HANDLE CHALLENGES – ELEMENTS OF A STRATEGY

5.1 Knowledge in organization to strengthen the role in the procurement and as a developer

Knowledge management in an organization is about how to choose to organize, evaluate and use knowledge in an organization. By pursuing cooperation between the different stakeholders that goes vertically and horizontally throughout the renovation process there will be positive effect on efficiency. The construction process should be organized in such a way that an on-going communication about issues regarding construction, energy, and finance is always present. The creation of knowledge and subsequent solutions must come directly from practice and solved jointly at an early stage in the renovation process (Author reference). In order to reduce costs and increase the efficiency of a project, a client must be able to evaluate quotes which promote various techniques and put them up against each other and simultaneously assess the contractor and the designers' skills to perform the work. The procurer who acquires the ability to combine their own skills of assessing technical aspects in combination with **contractor's ability and at the same time is able to deepen and enhance cooperation through out a renovation** process will reinforce the developer's role as a strong and robust procurer. Because of the complexity in a larger renovation process a certain amount of strategic thinking is needed (Author reference). It is important as a procurer and developer to define energy demands that are reasonable. There must be specified margins of energy so that entrepreneurs actually will be able to meet the requirements. If the client does not set reasonable standards it could mean that important tender fail to be submitted, or that it provides room for future conflicts that results in higher costs. Clients must understand the principle of give and take to reach their goals. It is also important to create specifications which clearly defines the requirements that must be measured after the renovation is completed. The skills of contractors should be examined. This is done either by triangulation and hearsay. An excessive focus on the lowest price in the tender evaluation is contraproductive towards incentives for cooperation and business opportunities (Bresnen 2007, Kadefors 2002). By understanding and knowing the Public Procurement Act, a developer can in gain advantage (Sporrong and Kadefors, 2014). Ability to cooperate, teamwork, and a good track record are all factors that will beat a lower price. These factors could easily be checked **by using the contractors' track-record** demonstrating good and successful collaborations. The developer or purchaser must be up to date on the industry's energy requirements and allow to invest in internal and external training. It is only when there is sufficient knowledge that makes it possible to think in new and different ways. Co finance and recruit clients with a long track record of working with these issues within other municipalities. Create contracts that either share risks but also opportunities. It may be better with positive signals about future profit motivation than to threaten with punishment and sanctions. Add incentives of increased profits through further agreements if, and only if, certain requirements are met. Through triangulation ensure such high requirements that contractors who do not measure at an early stage are being disqualified. It is important that this exclusion is done in the right way according to the Public Procurement Act. Some important parameters that are measurable in such exclusion criteria might be: Historical data, the number of complaints that remain after the final inspection, time for completion of reference projects, delivery of projects on time and number of penalties for delays.

5.2 **Handling owner's politics**, legal and bureaucratic processes to create a driving force and enhance collaboration

One of the key factors to a successful renovation project is the driving force that gets the project to move forward. Since many different players are normally involved in a renovation project, it is important that no delays or misunderstandings occurs. The following six areas has been identified as key factors (a-f): (a) Ask for political decisions from owners that are simple and that gives clear information about the size of the renovation budget for energy savings and size of resource allocations. (b) A completed climate plan for the property portfolio at a general level has been shown to increase the likelihood of implementation of energy-saving measures when carrying out renovations. (c) Make sure the issue and topic of energy renovation has been well established among officials and politicians in other parts of the municipality departments. This is particularly important when testing for various permits, building permits, and other resources needed by the officials (Paradis, 2015). (d) There must be clarity in

the internal project team about what to do, what the conditions are and that everyone is clear on this. To achieve this, the group should have conducted a feasibility study of the renovation project to conditions, limitations and resources are well known. All employees in the project should have the same basic philosophy and thought. (e) Strategic thinking by project managers and officials who are set to implement parts of the renovation project by identifying and consciously using the established rules and objectives within the municipality and housing company. Such a strategy implies that one should take advantage of the environmental plans, rules and policies that exist to achieve their own projects or team goals (Paradis, 2015). (f) Add resources and time to find / define the persons who are knowledgeable in many different areas needed and who possess the ability to absorb new information. The personell should also have the ability to create alliances and networks and thus have a large contact area within adjacent municipalities. Four important points are (1) Determine together the values that will be the basis for communication within the group in the event of a conflict. (2) Establish procedures within the project that will connect to the projectleader in the event of deficiencies or breach of goals or soft values. (3) Create routines for how to register and manage defects without pointing out or blaming particular persons or contractors. It is important to clarify the difference between practical / physical errors and other values-related issues (4) Create a shared detailed document, describing how the parties should manage, solve and act given objectives, targets, and potential conflicts. Make these routines reciprocal amongst stakeholders in a follow-up communication. Formulate a partnering declaration that express the agreed vision which all participants sign, creating a moral obligation to work towards the common objectives and to do this by some predetermined norms (Nyström, 2007, Kadefors, 2002).

5.3 The road map development

Below follows a short description of the Road Map Development. The road map is suggested as a tool for the social housing developer. Phase 1 encompasses ideas, survey and development of projects. This phase involves working to produce data needed to make a renovation plan. In this phase it is important to find out what purposees the renovation will have. It also include to point out what financial and practical resources exists and in what physical condition the property is in. Phase 2, the planning and tendering phase is about evaluating techniques and requirements in detail. Project together with architects and engineers go through different specifications, requirements and design proposals. The evaluations will be the basis for system documents containing details of design, materials, systems for air and heat, and possibly other energy systems. Phase 3 is the construction and implementation phase. It covers renovation and implementation of energy-producing technologies. The work is driven through the renovation fase based on a detailed planning and control plan. Various energy-producing technologies are being installed. Throughout the practical renovation a variety of checks on contractors, planners and subcontractors are being carried out. Phase 4 is operation and maintenance. This consists of a variety of systems and controls. The work begins with trying to optimize the property and all newley installed energy producing systems. It is through inspections of the property's systems several years after an energy renovation that faults and errors has been found and the goal is to make the running time as long as possible. In addition, this is a delicate phase in which there is a risk that the skills, knowledge and other important staff can be lost in the transition from the completion of the operational phase (Author reference)

6. CONCLUSION

This paper set out to answer two main questions related to small social housing companies doing energy renovation. First what obstacles would the companies meet whilst executing a renovation program? Second what kind of actions and steps is feasible to pursue in the renovation process, when looking at how to manage, create and distribute knowledge in order to enhance the owners/clients role through out the renovation process and the procurement process? And what kind of strategy can be adopted considering owners demand, legal and bureaucratic processes and collaboration between all stakeholders? The challenges we identify answering the first question is the dialogue with tenants, collaboration with partners and legal issues related to energy use. As solutions to these challenges and answering the two questions we suggest to systematically organise knowledge to strengthen the clients and to form a strategy here presented as a roadmap in four steps. We argue the collaboration with the tenants should be a constructive fruitful process. In cases where the tenants association is strong collaboration can be underpinned for example by agreeing with the tenants' association along with a mediation party that no rent increase may be implemented that can be traced to the renovation. As a response to such an agreement, the tenants association agrees on not put hinders towards the renovation process. We emphasize the need to enhance skills of the clients in relation to negotiations with contractors and consultants.

Energy renovation of the existing building stock is of paramount importance for societies to tackle the climate challenge. Much effort focus on large players, yet most of the building stock is owned by smaller clients that even collaborate with smaller suppliers. We hope with this paper to have contributed to a further focus of small players contribution.

REFERENCES

- [1] Alhourani, F., & Saxena, U. 2009. Factors affecting the implementation rates of energy and productivity recommendations in small and medium sized companies. *J.of Manufacturing Systems*, 28(1), 41–45.
- [2] Blomé, G. 2012. Försäljning av allmännyttan och inträde av privata ägarintressen-Effects of privatization of public housing in Sweden.in Formas publication. Formas, Stockholm.
- [3] Bresnen, M. 2007. Deconstructing partnering in project-based organisation: seven pillars, seven paradoxes and seven deadly sins. *International Journal of Project Management*. 2007;25(4):365-374
- [4] Byman, K. & Jernelius, S. 2012. Ekonomi vid ombyggnader med energisatsningar. Energicentrum vid Miljöförvaltningen Stockholm Stad, Stockholm
- [5] Granderson, J., Hult, E., Fernandes, S., Mathew, P., and Mitchell, R. 2016. Unlocking Energy Efficiency in Small Commercial Buildings through Mechanical Contractors. *Journal of Architectural Engineering*.
- [6] Johansson, B. 2012. Miljonprogrammet-utveckla eller avveckla?, Forskningsrådet Formas.
- [7] Hardie M, (2010) Influences on innovation in small Australian construction businesses, *Journal of Small Business and Enterprise Development*, 17(3), 387 - 402.
- [8] Kadefors, A. 2002. Förtroende och samverkan i byggprocessen: förutsättningar och erfarenheter, Chalmers tekniska högskola, Göteborg.
- [9] Lind, H. 2014. Ekonomiska aspekter på renoveringar av bostäder: en översikt.
- [10] Lind, H., Annadotter, K. & Björk, F. 2015. Socialt hållbar renovering—ett exempel. Social hållbarhet med fokus på bostadsrenovering—en antologi. Own publisher. Borås.
- [11] Lu. S.L., M. Sexton & C. Abbott (2008) Key characteristics of small construction firms. In Carter et al: Transformation Through construction. Proceedings from CIB WO65 symposium. Dubai.
- [12] Nyström, J. 2007. Partnering: definition, theory and evaluation. Royal Institute of Technology.
- [13] Lindén, S. V. L., Lennander S., Thornberg E. 2015. Förslag till utvecklad nationell strategi för energieffektiviserande renovering. In: Energimyndigheten (ed.). Boverket, Karlskrona.
- [14] Sporrang, J. & Kadefors, A. 2014. Municipal consultancy procurement: new roles and practices. *Building Research & Information*, 42, 616-628.
- [15] Schleich, J., and Gruber, E. 2008. Beyond case studies: Barriers to energy efficiency in commerce and the services sector. *Energy Economics*, 30(2), 449–464
- [16] Sutt, J. 2011, *Manual of construction project management for owners and clients*, Wiley-Blackwell, Ames.

Deep Renovation: Key Action for Active Protection of Modern Heritage. The Case of Architecture for the Service Sector

Claudia CALICE^a, Carola CLEMENTE^b

^a University of Rome, Italy, claudiacalice@gmail.com

^b University of Rome, Italy, carola.clemente@uniroma1.it

ABSTRACT

This paper is the synthesis of multi-year research activities carried out with the support of Sapienza University in collaboration with some local authorities and private entities on integrated refurbishment planning of tertiary buildings. Despite European Commissions requests (Energy Performance of Buildings Directive and Energy Efficiency Directive) about renovation in the service sector, there are not yet national or european databases and studies, but only some preliminary hypothesis potentials of energy efficiency of the interventions. The very incomplete knowledge of the heritage and its energy consumptions leads to develop only partial studies, without an integrated and multidisciplinary approach. Therefore, there is a lack of retrofit integrated guidelines, especially for the heritage with architectural value but non still included like a consolidated category of historical monuments.

This is the case of directional buildings, in which were involved the best architects and designers in Europe during the post-war reconstruction of the productive and administrative features of European countries. The renovation of a substantial part of this architectural heritage is aimed at protection and promotion, through actions both **respectful and effective, in order to answer to even more complex and variable user's needs but the know how is** to build yet. This absolutely open and still very unclear question often shows how entities and authorities are underprepared on the best practices to implement in order to protect and enhance architectural heritage.

Keywords: energy saving, heritage, deep building renovation.

1. INTRODUCTION

The integrated refurbishment, and the deep, functional and energy renovation of architecture for the tertiary sector from the last century, is a major commitment for public administrations and private entities that own and manage heritage of importance in terms of size and architectural quality – heritage that in many cases characterizes the diffuse quality of the consolidated city. The organization of tertiary sector building heritage in Italy reflects the **country's productive structure, and the dynamics** of urban and demographic development in the leading metropolitan areas have evolved. With few differences, this timeline is the same throughout all the building stocks in the traditional and advanced tertiary sector; these buildings are marked by a generally swift functional and technological obsolescence, closely connected to the cycles of operative renewal involving the activities they house. Falling into these categories are various types of buildings that may be catalogued by different levels of complexity in terms of technology and plant, in which energy consumption – generally found to be in decline in residential construction – continues to hold firm, or is seeing a slow and steady rise.

Looking at the buildings of greater architectural importance, the issue of deep renovation brings to bear a number of different competences belonging to various disciplines in technology and plant, as well as those in history and restoration, especially when working in an established historic setting or in a modern setting with strong architectural content. This is the case of the management architecture built during the last century, where the need **to reconstruct the productive and administration infrastructure engaged the period's finest designers throughout** Europe. The conversion of a considerable portion of architectural heritage to be protected and capitalized on with solutions that both respect pre-existing buildings and are effective in their response to increasingly complex requirement frameworks is an open and still under-examined question; often, even the entities in charge of managing the protection of architectural heritage find themselves unprepared.

2. MATERIALS AND METHODS

2.1 Deep renovation approach in modern non-residential heritage

For decades, the question of intervening in the modern utilitarian heritage has been a characteristic theme of technical design culture almost exclusively of national interest. In the international sphere, the management or transformation of these buildings has often found a quick response in their demolition or reconstruction. This cultural distance – which emerged in the second postwar period from the extremely different situation of architectural heritage for public services among the various European countries more or less stricken by the devastations of war – **narrowed, especially by virtue of the modern and reconstruction movement's critical re-evaluation of utilitarian architecture.** Although these architectures, to a great degree, have yet to come under categories of monumental landmarking, the recognition of their intrinsic value, or of the value of the urban context they are rooted in, has brought about a new sensitivity in their management. In many cases, no critical design ability for this category of buildings has yet been established, particularly for the reconstruction architectures built between 1945 and the early 1960s. These buildings, when they manage to conserve their morphological integrity, are often highly modified in their interior spaces, in their finishings, and in their decorative apparatus – elements in some cases integral to the design and its architectural quality. These buildings were, with very few exceptions, long considered mere containers of utility, and were experienced, managed, and often mistreated as such.

Part of the responsibility for this *modus operandi* may be laid upon the lack of a culture of “of the ‘design for the existing building. The historization of these buildings, conceived as a manifesto of modernization of a country and of its service structures, has made it possible to open up a new line of intervention that, although more aware, has yet to fully mature. Although this kind of highly conservative attitude ends up demeaning the original spirit of the design, on the other hand, in certain contexts, it was deemed indispensable for preserving the architectural image strongly characterized by the technologies originally used.

There are more and more design opportunities appropriately reconciling preservation of the historic urban image, operative refurbishment, and deep renovation; these require a design investment in which functional and technological innovation uphold the architectural image. This is the case with the successful example of refurbishment underway of the Jussieu Campus in Paris, a project that has involved various design groups and the commissioning parties in a complex operation of environmental restoration, recladding, and functional **reorganization of the city's main urban campus. These interventions, of importance for the size and quality of the operators involved, present opportunities for experimentation on an issue still far from being systematized.** Knowledge of this heritage, organized by building type, intended use, and construction technologies employed, is still very much in flux, and lacks sound, aggregated data.

2.2 The energy efficiency in the modern tertiary sector

The fragmentary nature of the state of the art is due in part to the extreme compartmentalization of the types of ownership, and of the enormous difference of management models between the public tertiary sector and the private one which – in addition to being broken down by the function housed there – is often marked by a clear **separation between the building's ownership, management, and end user. The characterization of the heritage is among the reasons why, in spite of strong EU urging, systematized data on the refurbishment of tertiary architecture are still lacking on both the national and European levels, except for forecast estimates of impact on the potential of the sector's energy efficiency efforts in the medium term; at the moment, this appears to be the only potential lever for promoting a systematization of studies on the issue.**

The open debate on energy efficiency in the traditional tertiary and high-tech sector has developed since the 1990s, but without conducting an effective strategy for intervention and for the technological and energy conversion of heritage. The difficulty of classifying the common traits of the building stock to be analyzed translates into a low capacity for action, due also to the dearth of effective guidelines in support of design for existing architecture.

The tertiarization of the productive system, and the consequent building transformations inattentive to the rational use of the building resource that have occurred in recent decades, has impoverished the quality of the state of the heritage, and has resulted in steadily growing consumption, from 1990 to the present time, in the tertiary sector – the only sector that, from 1990 to 2012, saw a +105% increase. This is a discouraging rise when compared to the national objective for 2020, which, with the final energy savings achieved in 2011-2013, was only 5.6%

accomplished, against 35.2% in the residential sector and 26.6% for industry. Taken together, these factors have brought about the depreciation of certain segments of the existing assets, a factor apparently believed connected **with the current economic situation, but actually closely linked to the buildings' state of technological inefficiency**. In this heritage of 0.7 million buildings, equal to 3.4 million real estate units for an area covering 0.85 billion square metres, that is being converted at excessively slow and poorly structured rates, the only consumption-reducing dynamics came with the diminished production owing to the continuing economic stagnation in recent years. Since 2013, consumption trends have actually seen a slight reversal in the tertiary sector as well, due in part to the **sector's lower productivity**, and in part to the effects of the first refurbishments that have been completed, especially on education buildings.

In particular, the national heritage for management facilities, equal to approximately 88.09 million square metres, has an estimated specific consumption of 114 kWh/m² - an excessively high figure in line with or outstripping the consumption levels of other sectors of the heritage on which more structured and incisive action has been taken, as in the case of residential and school heritage.

Supported by European funds and by Por-Fesr 2014-2020 operative programmes, incentivize instruments for energy management and renovation have multiplied. These include Legislative Decree n°.102/2014, implementing Directive 2012/27/EU which introduces a programme **to improve the energy performance of public bodies' buildings** and the obligation for large enterprises to adopt energy diagnosis, in accordance with criteria of quality and reliability, and energy flow monitoring systems. The adoption of monitoring systems makes it possible to establish a highly realistic and precise baseline and breakdown of business energy, with the aim of maximizing the effectiveness of refurbishments. However, these instruments cannot depend on a widespread know-how of comfort to the end users, who still perceive the interventions to be implemented as too complex and ineffective in terms of return on investment.

Regulatory constraint is essential in a technical and decision-making setting that has yet to be sufficiently informed and attentive, both for the public sector tasked with the role of being a model and promoter of best practises in managing its heritage, and for the private sector that labours to find attractiveness in investments outside its own core business – even when these investments bring considerable profits derived from savings on energy bills and from the higher quality of the workplaces.

Beyond the instruments of regulatory guidance on the tertiary sector, the adoption of certain virtuous behaviours like ECMs (Energy Conservation Measures), which spread in the United States starting in the early 2000s, helps raise awareness, among technicians, operators and end users, of the need to govern technological transformations, technical devices, and use behaviours.

Adopting ECMs in the tertiary sector requires guidance strategies based on the creation of extended and diversified databases – currently not available – containing the data needed to characterize buildings and their auditing, and **to define “falling rule lists”**; these are guidelines, with decreasing likelihood of the investment being effective, that make it possible – also with expeditious auditing activities – to define cost-benefit analyses and unquantifiable impacts, such as the transformation of buildings in an established or modern but highly characterized historical environment. To form this database, it is essential to identify some highly significant pilot cases; studying these buildings is indispensable for the integrated investigation of this portion of heritage.

The management facility type discussed here is specific to Italy: a building block, of medium or high density, often included in the fabric of post-Unification nineteenth-century expansion, almost fully occupying the perimeter of the city block in the fabric it stands on, and in some cases also replicating the proportions of the buildings it has replaced. The fabric of the established historic periphery has grown denser; this periphery is now absorbed by the modern, expanding city where low-density settlement, characterized by the stately villa or the small collective home, is transformed into management, administrative, or commercial architecture, generally occupied by a single activity. This type, highly widespread throughout Italy, is unpopular elsewhere in Europe where, especially in the metropolitan areas, tall buildings prevail, with greater construction densities and greater concentrations of activities different from one another; here, the owner and the end user of the spaces do not coincide, except in the case of public or institutional management architecture.

3. CASE STUDIES IN ROME'S SAPIENZA UNIVERSITY CAMPUS

3.1 The significance of Sapienza University as case study

The research that has been carried out, a portion of whose results are reported, aim precisely at modelling the pilot cases of use for the parametrization of the analyses and of the expected results, and regarded the initial **examination of the building heritage of Rome's Sapienza University, from its monumental historic nucleus** (1932-35) to the most recent buildings. Aimed at establishing the modes of intervention on prized tertiary heritage designed for education and research, the study made it possible to codify an investigation methodology, integrated from the standpoint of technology, structure, and plant, that might be replicable on other building stocks.

Sapienza University's heritage proved to be a rich sample, given its complexity and technical/constructive quality, with outstanding potential for renovated function and performance (especially in its historic part, where the **envelope's construction technologies have been shown to possess relatively good physical/technical and durability performance**), and with excellent possibilities for performance implementation by means of minimally invasive interventions. The results on the buildings constructed starting in the 1960s are of a wholly different kind. In these buildings, the performance response, especially of the envelope components and the plant systems, proved to be no longer in line with the use requirements of the housed functions – all the less given the offered performance specifications, which are quite distant from current performance standards in terms of acoustic and visual-attentional comfort, and energy requirements.

3.2 Simulation of deep renovation in two campus buildings

The case of the pharmaceutical chemistry building built from 1962 to 1966 is representative in terms of technology and performance, and was able, through dynamic energy modelling, to identify margins for improvement. The design simulation of synergic interventions on the envelope/plant system (performance improvement of the envelope, a complete reconceiving of the solar shading system, installation of systems to control environmental parameters, multisplit climatization system and the introduction of renewables) brought about a 78% reduction in the energy performance index in terms of kWh/m³ year (from 68 kWh/m³ year to 10.5 kWh/m³ year), and a 40% decline in climate-changing emissions.

Another case study was analyzed within the same university district, with the aim of studying the consumption profile and to identify priorities for action for a building made with bearing walls and restricted by much more stringent requirements for the protection and preservation. The pilot-building is the Mathematics building, one of the most representative for his architectural features, designed by architect Gio Ponti in 1935. The building was altered by the redistribution of classroom, changing his original distribution and character. This pilot project, therefore, has, more than others, complex possibility of renovation, where the technology and energy retrofit must be integrated with conscientious actions, ensuring the functionality and the historical memory of the building.

The envelope is made of bearing walls with no insulation and the windows, in most cases, is the original ones of 1939. The blueprint is design around a big court has the advantage of more natural lighting and good ventilation in the rooms, but also a greater dispersion surface. Bearing walls allow the minimization of thermal bridges, focusing dispersions in the large windows. The average U-value (thermal transmission value) of the external vertical walls was calculated to be about 1.5 W / m²K. The particularity of the building and the potential of the renovation have led to a dual simulation in two different calculating methods: steady state mode and dynamic mode. The first one brings as a result the overall energy requirement of 653 MWh, a carbon footprint of 189 tCO₂/year and an energy performance index of about 50 kWh/m³year. The winter performance, despite the contained presence of thermal bridges, is therefore absolutely insufficient. Using dynamic simulation, however, the research reveals a best summer performance, due to the high thermal inertia of the walls and the floor plan configuration. A smart retrofit strategies for plant system maybe to include this building with all near buildings in an energy district, replacing the generator with radically different technologies, such as cogeneration, which, however, requires an high investment, even for maintenance and management. This action can bring an environmental benefit of 23%.

The high quality design criteria adopted and the high cost of actions on envelope (internal cladding, replacement of windows) lead to have an high payback time (27 years) for an integrated renovation of building-plant system, but still low compared to the reference range of envelope retrofit (about 40 years). This is a consequence of large

transparent surfaces, which means an excessive loss in winter and an overheating in summer. Therefore, despite to the high replacing cost, improve window efficiency results in significant savings on heating and air conditioning.

The studies that were done have made it possible to codify an intervention procedure, later tested on groups of buildings deemed exemplary by type, size, and period of construction, with analyses concentrating on post-1945 buildings. The analyses and simulations led to determining the need to perform a deep renovation of the envelope components and of the interior comfort management system, not so much because of the non-optimal conditions of building maintenance, but because of the current requirement **frameworks' incompatibility with the design frameworks**.

It was found that even when the envelope components still had fair residual performance, the conditions of use of **the spaces, and of managing the work for the users' safety, were no longer compatible with the building's original performance**. These buildings – originally places of technological, typological, and construction experimentation efforts that were ahead of their time – have not withstood the test of time and of a use that was often ill-advised. The poor use of the envelope components or of some environmental control devices, like mobile shading, differentiated window systems, or natural ventilation devices, has impaired the geometric stability and the seal of the envelope components, negatively impacting the efficiency of the building/plant system. Maintenance interventions implemented without monitoring or technical oversight have further aggravated the general picture of **obsolescence of the building's performance system, and has even deprived it** of its overall morphological quality.

4. CONCLUSIONS

In the city of Rome, the buildings selected by type, placement, era of construction, and current use, that had characteristics akin to the model described earlier, were analyzed from the historical standpoint, in order to identify the salient traits of architecture and construction to be restored or redeemed; for these buildings, the current use model was reconstructed, along with the events connected with the evolution of the activity contained within them. **All the verifications of consistency of the building's active and passive requirements in terms of safety, structural performance, and environmental comfort were made, and its consumption and energy loads were modelled**. From this perspective, **the building's energy and functional renovation was considered the main driver to trigger an integrated refurbishment of the building, using the parameter of the building/plant system's efficiency as the potential activator of an architectural renovation that would otherwise not be economically affordable**.

The results of the research proposed in this paper aim to lead to the construction of a replicable methodology for the preliminary analysis and evaluations useful for deep renovation of tertiary building heritage. During the various steps of the study, numerous selected pilot cases throughout the country were selected, addressed in part to validate theoretical assumptions of research, and in part to check actual strategies of integrated refurbishment, in progress or already concluded, of buildings mainly used for directional, educational and research activities. **The modelling work of the "pilot buildings" is still in progress, in order to consolidate the soundness of the sample and validate the results from the first cycle of obtained financing**.

REFERENCES

- [1] Carbonara, G., 2015, Energy efficiency as a protection tool, *Energy and Buildings*, Vol. 95, pp. 9-12
- [2] **D'Ambrosio Alfano, F.R., Mazzarella, L., Romagnoni, P., 2015, Designing the Retrofit, Energy and Buildings, Vol. 95**
- [3] **de Santoli, L., 2015, Reprint of "Guidelines on energy efficiency of cultural heritage, Energy and Buildings, Vol. 95, pp. 2-8 ENEA, 2015. RAEE - Rapporto Annuale Efficienza Energetica 2015, Roma**
- [4] CRESME, 2014. Rapporto RIUSO03. Ristrutturazione edilizia, riqualificazione energetica e rigenerazione urbana, Roma
- [5] Legislative Decree no. 102 of 04 July 2014, Implementation of Directive 2012/27/EU on energy efficiency, amending Directives 2009/125/EC and 2010/30/EU and repealing Directives 2004/8/EC and 2006/32/EC.
- [6] ASHRAE (2002), Guideline 14 -2002, Measurement of Energy and Demand Savings
- [7] Ferreira, M. and Almeida, M., 2015, Benefits from Energy Related Building Renovation Beyond Costs, *Energy and Emissions, Energy Procedia*, Volume 78, 2015, Pages 2397-2402.
- [8] **Clemente, C., 2014, Riqualificazione integrata e valorizzazione dell'edilizia universitaria. L'esperienza delle ricerche operative in corso sul patrimonio edilizio della Sapienza, TECHNE n.8, p. 278-291**

- [9] Sesana, M.M., Grecchi, M., Salvalai, G., Rasica C.,2016. Methodology of energy efficient building refurbishment: Application on two university campus-building case studies in Italy with engineering students, *Journal of Building Engineering*, 6 (2016),54–64.
- [10] **Clemente C., Calice, C.; Marandola, M. (2016)**, “Deep renovation as tool for development and active protection of the consolidated city heritage. Riqualificazione tecnologica integrata come strumento di valorizzazione e di tutela attiva del patrimonio città consolidata.” in *TECHNE*, n 12; pp.104-112

Future Challenges for Renovation as Experienced by Swedish Housing Companies

Liane THUVANDER^a, Paula FEMENÍAS^b, Birgit BRUNKLAUS^c

^a Chalmers University of Technology, Sweden, liane.thuvander@chalmers.se

^b Chalmers University of Technology, Sweden, paula.femenias@chalmers.se

^c SP Technical Research Institute of Sweden, Sweden, birgit.Brunklous@sp.se

ABSTRACT

There is an extensive need for renovation in the existing housing stock and an increased rate of renovation activities is necessary not only to meet international climate and energy targets, but also in order to ensure buildings functions, technical qualities and to provide a good living environment. Thus, the challenges for the housing companies is to meet and balance all the different needs. Research focus on the development of decision support tools and expansion of the renovation discussion from not only a technical issue but also to include a social perspective. But how do housing companies manage renovation activities in a broader perspective and what are the related future challenges in renovation and transformation of building stocks? The aim of this study to investigate how larger housing companies act in renovation projects and to identify perceived challenges in relation to renovation. A questionnaire survey directed to the Swedish housing sector has been carried out including all housing companies with more than 20 employees. Out of 198 companies, 76 companies responded, which corresponds to a response rate of 38 percent. Results show that even if companies have environmental and energy goals or policies, only minor energy efficiency measurements are carried out in renovation projects. Social aspects are increasingly addressed both in policy and renovation. The largest challenges are economy and a limitation of the rent increases in order to ensure that the residents can remain in the apartment or in the housing area after renovation, i.e. to find appropriate rent levels. With a starting point in Swedish conditions, the results are of interest for the transformation process of the European housing stock.

Keywords: housing companies, renovation, questionnaire survey

1. INTRODUCTION

There is an extensive need for renovation in the existing housing stock and an increased rate of renovation activities is encouraged to meet international climate and energy targets (e.g. EU, 2010, EC, 2002), but is also a necessity in order to ensure buildings functions, technical qualities and to provide a good living environment. The challenges for the housing companies is to meet and balance all the different needs. Research focus on development of decision support tools, study of renovation strategies and expansion of the renovation discussion from not only a technical issue but also, for example, a social perspective often applied in specific cases (e.g. Lind et al., 2016, Taillandier et al., 2016, Malmgren and Mjörnell, 2015, Thuvander et al. 2012). But how do housing companies manage renovation activities in a broader perspective and what are the related future challenges in renovation and transformation of building stocks? What are the challenges in relation to different aspects such as technical, environmental, economic, social, and heritage/ architectural values? Most of the empirical research on renovation is based on case studies or interviews which gives in depth-knowledge. Less is known about the general renovation activities in the housing sector. The aim of this paper to investigate how larger housing companies act in renovation projects and to identify perceived challenges in relation to renovation.

2. THE RENOVATION BAROMETER

A questionnaire survey directed to the Swedish housing sector has been carried out in 2015. The survey, called Renovation barometer, covers renovation actions as experienced year 2014 but takes into account a time span ten years back in time.

2.1 Data collection and preparation of questionnaires

The survey includes all housing companies with more than 20 employees owning and managing rental apartments. The questionnaire comprised in total 32 questions (q) within eight sections with addressing the following topics: general information about the companies' portfolio (5q), the companies' renovation activities in general (5q),

investigations carried out before a renovation (1q), renovation measures (7q), policy and strategies (5q), follow-up of renovations (1q), need for knowledge and development (5q), and company facts (4q). When relevant, the questions take up technical, environmental, economic, social, heritage/ architectural aspects of renovation. The questions measured the opinion of the respondents by using a Likert scale with a three- to five-point range, a binary scale only allowing yes/ no answers, and questions concerning more general and descriptive information. The questionnaire was pretested on three researches and two housing companies.

Initially, a web-based questionnaire was sent out to the CEO or property development manager of the company. Because of a very low response rate and difficulties to reach the adequate respondent, also a paper version of the questionnaire was sent out by mail followed up by one reminder. In order to increase the response rate, researchers contacted some of the companies personally. The reasons why some respondents failed to respond were also investigated.

2.2 Data analysis

Data were compiled and stored in a database using the online software SurveyMonkey. The respondents answering the digital version entered data directly into the database. The data from the paper version were entered manually. From there, the data were exported and analysed by using the statistical data program Statistical Package for the Social Sciences (SPSS).

In a survey that aims to assess peoples' attitudes and values there is always a risk that the respondent gives answers that reflect how it ought to be rather than how it is in order to appear good. Possible bias from this should therefore be considered when interpreting the results.

2.3 Responses and respondents

Out of 198 companies, 76 companies responded, which corresponds to a response rate of 38%. Most of the respondents manage municipally owned rental apartments (80%), only a minor share of the respondents manage privately owned rental apartments (13%) or other types of rental tenure (7%).

3. RESULTS

3.1 Upcoming renovation needs and investments

During the last 5 - 10 years, a majority of the housing managers focused on renovation of the stock constructed during the period 1941 to 1960. Not surprisingly, the coming 5 - 10 years the focus will be on the stock constructed **1961 to 1980. The amount of money the companies spent on maintenance and/or renovation was about 19 €/sqm (183 kr/m²) per year (for 2013, before a national change of accounting system was introduced).**

3.2 Technical renovation measures

The most frequent renovation measures the companies usually carry out ('always' or 'often') are adjustments of the heating system (85%) and ventilation system (82%) followed by exchange of pipes and lightings. Measures taken with impact on the climate shell of the building are foremost exchange of the roof covering (59%), exchange of windows (56%), and additional insulation of the attic (53%). Additional insulation of facades is one of the least frequent measures carried out. **Only 11 percent of the respondents state that this measure is carried out 'always' or 'often'. Among the measures performed 'seldom' or 'never', we find attic extensions, redistribution of apartments sizes, installation of elevator, and adding of balconies or entrances.** Figure 1 shows all renovation measures related to the climate shell, common spaces (laundries, staircases), appliances and installations but also measures that have impact on the distribution of areas such as installation of elevator or addition of attic. Interventions in the apartments are not included.

Factors that usually are prioritized in connection with a renovation are costs in the first place (more than 95 % prioritize **'always' or 'often'**) followed tightly by **energy efficiency measures in the second place (more than 90 %)**. Less than 50 percent prioritize larger interventions and least prioritized is attractive architecture.

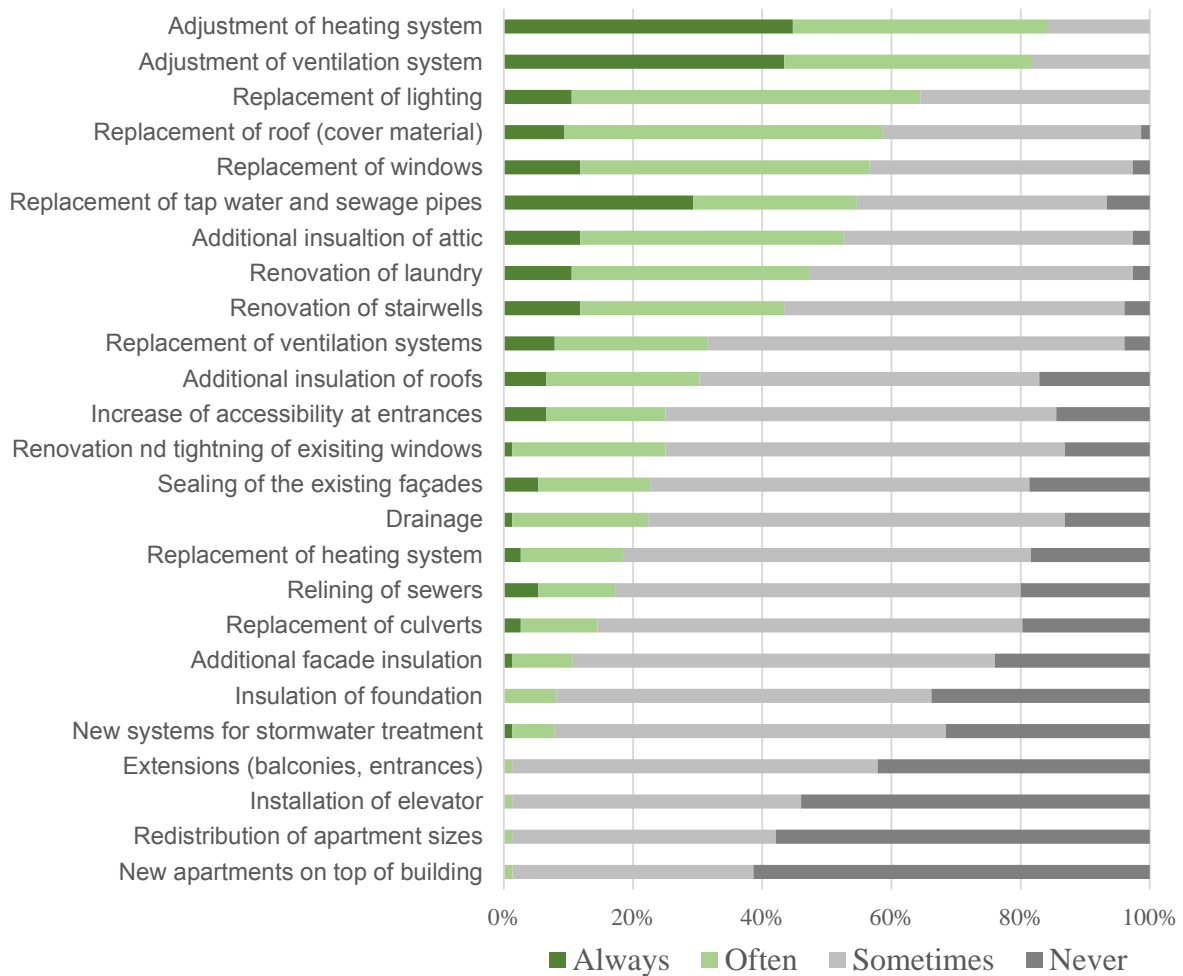

Figure 1: Technical measures that companies usually carry out in renovation. Interventions in the apartments are not included

3.3 Renovation policies and goals

The companies have a broad repertoire regarding different types of policy or goal for renovations (Figure 2). More than 70 percent of the companies have policies or goals for economic aspects, the procurement process, energy use, residents' influence, and choice of materials. Only a small share of the companies, slightly more than 30 percent, have a policy considering heritage values.

When having a look at the difficulties to achieve the goals, economic aspects can be found on the top (Figure 3). More than 60 % of the respondents consider that goals regarding reasonable rent increase and costs in general are difficult to achieve to a 'very high degree' or 'high degree'. Also, to fulfil accessibility goals is a large challenge. Up to 23 % of the companies perceive difficulties to meet the target settings for energy use. Less than 10 % perceive that the selection of materials is a larger problem in terms of meeting targets.

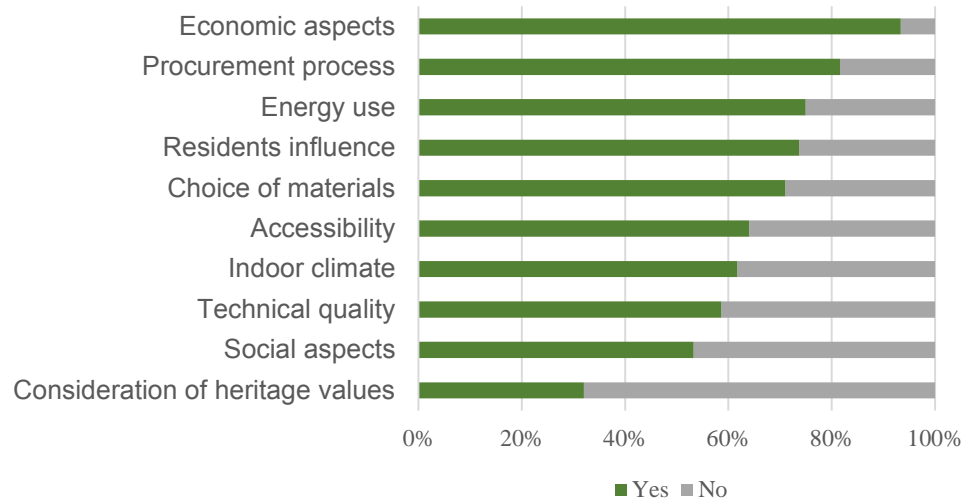

Figure 2: Companies' specific policy or goals for renovation

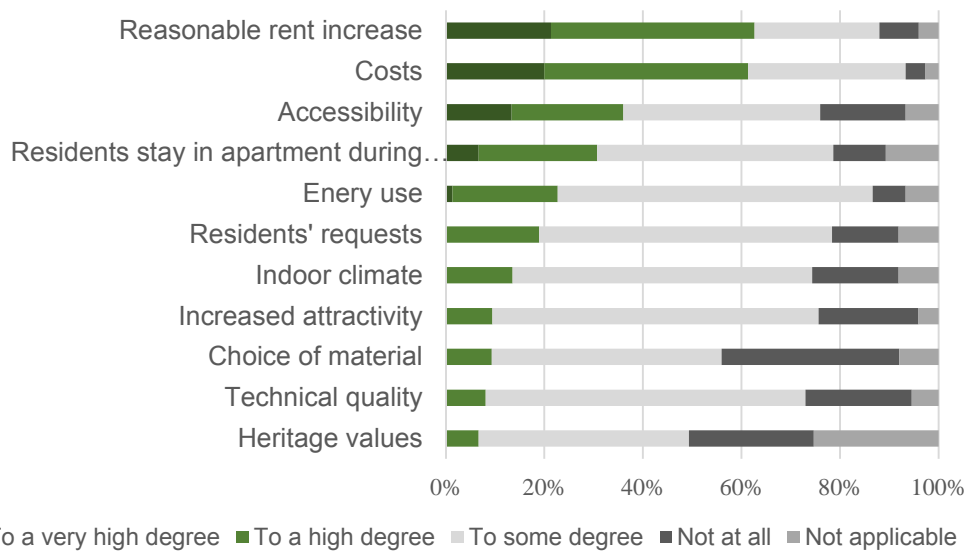

Figure 3: Difficulties to achieve different kind of goals as perceived by the companies

3.4 Need for technical development, knowledge and support

When asking for technical development in the building sector, the respondents state that there is a need for development of renewable energy systems (50%), passive house technology for renovation projects as well as ventilation- and installations systems (both 44%). About one third of the companies see a need for development of measurement and feedback systems to the operation staff, systems that support accessibility and integration of elevators in existing buildings, façade systems, and measurement systems with feedback to the residents. There seem to be good technical solutions for windows, balconies, and roof systems. About 40% of the companies agree on that there is a knowledge need on incentives for behavioral changes and the operation and maintenance of energy efficient buildings. Only 8% see a need for knowledge on heritage aspects and about 23% state that no knowledge is needed on that topic. Regarding different actors need for knowledge or education, the respondents **consider the companies' board members having the** greatest needs. When it comes to other types of supporting structures such as subsidies, models, contract forms, or decision support tools, almost 37% of the companies agree on a need for subsidies. At the same time, 26% of the companies states that there is no need for subsidies. Subsidies have a top position, both the companies that ask for subsidies and those who do not see a need for subsidies.

3.5 Challenges as perceived by the companies

When the companies were asked to state the three biggest challenges that they face, it was economics, rents, the ability for residents to be able to remain in the apartment after renovation, and profitability over time that was mentioned most (Figure 4a). The statements of the second biggest perceived challenges resulted in a more scattered picture (Figure 4b). Energy, social aspects such as dialogue with the residents, and yet again economy and rents are seen as the main challenges, followed by accessibility issues as well as technical quality.

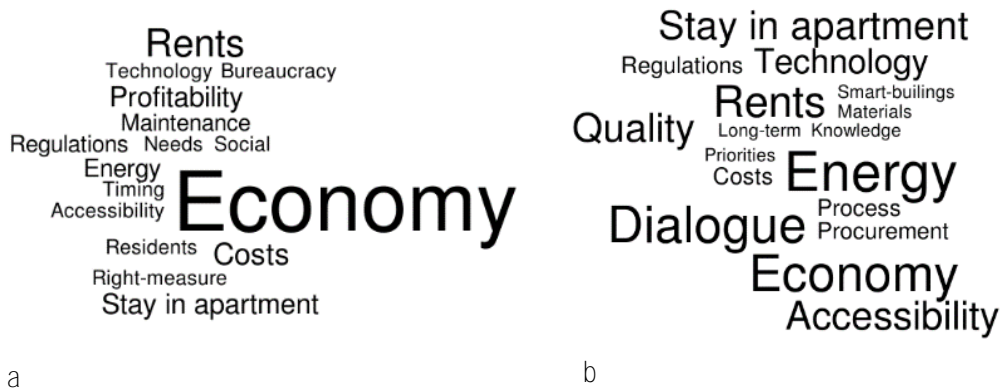

Figure 4: The biggest challenges as perceived by the companies, a) Biggest challenges and b) Second biggest challenge. Illustrations produced with the online tool WordItOut.

4. FUTURE CHALLENGES FOR RENOVATION

In the coming years, renovation activities will take place in the housing stock from the 1960 - 80s but also continue in the slightly older stock, constructed after the WWII.

4.1 Economy: The predominant challenge in renovations

Economy was found to be the most important factor, but also the most challenging part. Costs have the highest priority in a renovation process as well as the possibility for the residents to stay in the apartment during a **renovation, something which is advantageous not only from the residents' perspective but also from an economic perspective**. Only less than half of the companies prioritize larger interventions, i.e. packages of renovation measures, which is interesting as companies in other contexts often highlight the importance to co-ordinate different measures to larger packages in order to avoid to disturb the residents too often. When it comes to goal fulfilment, economic aspects are also seen as the most difficult ones, including both reasonable rent increase and renovation costs. Support: subsidies both need for (37%) and no need for (26%). The companies see economy by far as the most dominating future challenges in the renovation debate.

4.2 Energy: One of the largest challenges

Energy use and energy efficiency measures are important questions. Energy efficiency measures have the second highest priority (after costs) in renovations, and more than 70 % of the companies have an energy policy or energy targets. The majority do not perceive difficulties to achieve energy-related goals and almost all companies monitor the energy use after renovation. Regarding energy related measures usually carried out in renovations, mainly minor improvements can be found among the most frequent measures: adjustment of different systems, exchange of lighting, insulation of attic or exchange of windows. These measures are relatively simple to implement. More cost-intensive, non-standard increasing measure, or challenging energy efficiency measures from a technical and/or architectural point of view such as additional insulation of facades is only carried out to a lesser extent despite that there might be large energy saving potentials. The companies also see a need for development around energy issues and would like to see, among others, technical development of renewable energy systems and passive house technology, as well as operation and maintenance of energy efficient buildings. In summary, the companies have good control on energy issues but the energy saving potential is not fully utilized in renovation projects. The companies are aware of that which is expressed in the statement where energy issues are pointed out as one of the biggest challenges.

4.3 Architectural and heritage aspects: Left out in renovations

Little attention is paid to architectural and heritage aspects and they are not perceived as a challenge by the responding companies. They are either not prioritized or only considered to a little extent. Architectural and **heritage aspects are difficult to define and therefore easy to “forget” in the complexity of a renovation process.** At the same time, the existing architecture, foremost the facades, has impact on renovation solutions and identity creating effects for the residents and the housing area. Awareness and a more active stance to architecture and heritage values could contribute to better balance of attractive housing and lead to demand and development of well-adapted energy efficient façade solutions. This could be a self-interest of the housing owner. Should it be a challenge? Maybe a challenge also to be addressed more clearly on a national perspective?

5. CONCLUSION

This paper has investigated how larger housing companies in Sweden act in renovation projects and identified challenges. Results show that even if companies have environmental and energy goals or policies, only minor energy efficiency measures are carried out in renovation projects. Social aspects are increasingly addressed both in policy and renovation. The largest challenges are economy and a limitation of the rent increases in order to ensure that the residents can remain in the apartment or housing area after renovation, i.e. to find appropriate rent levels. Economy and costs are dominant challenges in all phases of renovation. The discussion on how to finance renovation projects in order to keep a good technical standard of the buildings, a good indoor climate and housing environment, and at the same time to improve the energy performance of buildings still remains. The fragmented picture whether there is a need for subsidies or not is just one more illustrative example. Architectural and heritage values are not considered as a challenge by the housing managers despite that they have impact on technical solutions, indoor environment and social aspects. The results of the study represent challenges of Swedish housing companies, however, as there are similarities in the composition of the housing stock in other European countries and common goals to fight climate change, deeper knowledge of the Swedish challenges in renovation might contribute to a better understanding of the potentials and barriers for a successful transformation of the European housing stock.

ACKNOWLEDGEMENTS

The research has been financed by the within the framework of the strong research environment SIRen and the Formas-BIC project 244-2010-252.

REFERENCES

- [1] EC (2002). Directive 2002/91/EC of the European parliament and of the council on the energy performance of buildings. Official Journal of the European Communities.
- [2] EU (2010). Directive 2010/31/EU of the European parliament and of the council on the energy performance of buildings (recast). Official Journal of the European Union.
- [3] Lind, H., Annadotter, K., Björk, F., Högberg, L., & af Klintberg, T. (2016). Sustainable renovation strategy in the Swedish million homes programme: A case study. *Sustainability*, 8(4), 388; doi: 10.3390/su8040388.
- [4] Malmgren, L & Mjörnell, K. (2015). Application of a Decision Support Tool in Three Renovation Projects. *Sustainability*, 7(9), 12521-12538; doi: 10.3390/su70912521.
- [5] Taillandier, F., Mora, L., & Breyse, D. (2016). Decision support to choose renovation actions in order to reduce house energy consumption – An applied approach. *Building and Environment*, Vol 109, pp 121-134.
- [6] Thuvander, L., Femenías, P., Mjörnell, K. & Meiling, P. (2012). Unveiling the Process of Sustainable Renovation. *Sustainability*, 4(6), 1188-1213; doi: 10.3390/su4061188.

Integration of Sustainability Analyses into Business Models for Energy Renovation of Buildings: A Case Study in Norway

Roberta MOSCHETTI^a, Helge BRATTEBØ^b, Kristian S SKEIE^c, Anne G LIEN^d

^a Norwegian University of Science and Technology (NTNU), Norway, roberta.moschetti@ntnu.no

^b Norwegian University of Science and Technology (NTNU), Norway, helge.brattebo@ntnu.no

^c SINTEF Building and Infrastructure, Norway, kristian.skeie@sintef.no

^d SINTEF Building and Infrastructure, Norway, anne.g.lien@sintef.no

ABSTRACT

The building sector represents nowadays a key field to achieve the sustainable development goals. In particular, the implementation of energy efficiency measures (EEMs) in existing buildings has been recently acknowledged **as very significant to improve their energy performance, as well as to preserve the environment and reduce resource depletion.** Building energy renovation projects can also constitute a new source of business for the actors **involved in the whole process, including service providers, building owners, and financing companies.** Therefore, the adoption of both EEMs and innovative business models (BMs) can foster the achievement of sustainability within the building field. Nonetheless, there is still limited research on how to integrate sustainability analyses into BMs of energy renovation projects for achieving meaningful sustainable BMs (SBMs).

This paper first illustrates state-of-the-art and research gaps in the field of BMs for the energy renovation of existing buildings. Then, it presents the application of an analytic approach aiming to integrate quantitative sustainability analyses into BMs for such projects. The case study examined is a deep energy renovation project of a single-family house, which is part of a Norwegian research project. Some specific performance indicators, such as climate change, energy use, and global cost, are computed for the case study. The findings of this paper can represent the first steps towards a possible operationalization of sustainable business in energy renovation projects, as a blueprint for delivering sustainability.

Keywords: sustainability, building sector, energy renovation, business models

1. INTRODUCTION

Nowadays, buildings are responsible for about 40% of the total energy demand in Europe (Buildings Performance Institute Europe, 2011). Accordingly, the implementation of energy efficiency measures (EEMs) in existing buildings can play a fundamental role in decreasing the environmental impacts of the construction sector. Such measures can also lead to economic and social benefits, e.g., lower energy and maintenance costs, new job opportunities, and higher indoor wellbeing (Xu, et al., 2011; Li, et al., 2013). Moreover, energy renovation projects might represent an important source of business, by involving different actors in addition to building owners, such as service suppliers and financing providers.

In recent years, several academics and practitioners have focused on the definition of business model (BM), but there is still disagreement on what a BM is.

In (Osterwalder, et al., 2005), BM is conceptualized by nine main blocks: 1) Value proposition, 2) Target customer, 3) Distribution channels, 4) Relationship, 5) Value configuration, 6) Core competency, 7) Partner network, 8) Cost structure, 9) Revenue models. In (Richardson, 2008), the BM concept is organized around the value notion, i.e., the value proposition, the value creation, and the value capture.

Bearing in mind such common definitions of BM (Osterwalder, et al., 2005; Richardson, 2008), it can be stated that the main value proposition in building energy renovation projects is the provision of renovation works, along with a possible reduction of future energy/operating costs.

In this research work, the level of analysis focuses on BMs of energy renovation projects, meaning how such projects propose, create, and capture value, in a triple bottom line perspective and for the whole network of stakeholders.

Presently, the state-of-the-art of business models (BMs) in building projects is still limited (Abuzeinab & Arif, 2014; Pan & Goodier, 2012). An examination of possible BMs for projects of deep energy renovation is shown in (Moschetti & Brattebø, 2016). Here, such BMs are described and categorized with reference to the way of implementing renovation actions and to the drivers for the adoption of these measures.

Although current research focuses on BM changes to matching the shift towards sustainable buildings, further studies are needed. In fact, the innovation of BMs can represent a meaningful approach to boosting the adoption of EEMs in the built environment (de T'Serclaes & Devernois, 2008). In particular, among the research gaps characterizing BMs for building energy renovation, there is a lack of integration of sustainability analyses into the decision and business context. Hence, the issue of defining the best way to make use of quantitative information, deriving from sustainability analytic tools, within qualitative investigations, which are common in BMs (Bocken, et al., 2013). Furthermore, overall analyses on sustainability for energy renovation projects are meaningful for shifting current BMs to sustainable BMs (SBMs). To this aim, environmental, economic, and social criteria should be included in sustainability evaluation, with reference to the triple bottom line approach. Nonetheless, sustainability analyses fragmented and focused on specific sustainability-related aspects represent the current practice (Passer, et al., 2016; Cetiner & Edis, 2014).

This paper aims at contributing to the innovation of the BM concept towards a green shift within the energy renovation context, by means of sustainability performance analyses. To this scope, a case study is analyzed in detail, by quantifying specific sustainability criteria. Moreover, recommendations are provided for a future further development and employment of the proposed approach.

In section 2, the methodological approach followed in this article is presented and the case study is described, together with the analyses performed. In section 3, the obtained results are shown and discussed. In section 4, conclusions are drawn up, with suggestions on possible future research outlook.

2. METHODOLOGY

The research questions addressed in this article are the following:

How can the sustainability level of an energy renovation project be defined? How can quantitative sustainability results be integrated into BMs for such projects?

The analytic approach followed in this paper was already presented, in its embryonic form, in a previous article (Moschetti & Brattebø, 2016). Moreover, such approach was fully developed within another article submitted to a special issue of *Journal of Cleaner Production* (Dentchev, Nikolay et al., 2016).

Essential stages of the adopted approach include the detailed examination of a case study, the identification of EEM scenarios, and the involvement of the stakeholders in the choice of meaningful sustainability criteria to be assessed in these scenarios. The main aim is to provide a possible way to make use of quantitative sustainability analyses for sustainable business modeling in building energy renovation projects, as a blueprint to delivering future sustainability.

2.1 Case study

The case study analyzed in this paper is a deep energy renovation project of a single-family house, which is part of a Norwegian research project, SEOPP (Systematisk EnergiOPPgradering av småhus fra 1960, 2013-2016). This project was developed between 2013 and 2016, with the objective of defining methods and solutions for the systematic energy renovation of houses built in the period 1960-1990. SEOPP included two demonstration houses, located in Oslo and Bergen. In this research work, the house in Oslo (Figure 1) was chosen for the implementation of part of the proposed analytic approach.

The analyzed house is a three-floor house, including a basement, with a gross internal floor area of 176.7 m². The house has a timber frame structure and an average envelope thermal transmittance of 0.24 W/(m²K), after the implemented EEMs.

The house renovation included: a new internal layout; the addition of further insulation in walls, roof, and basement floor; new triple pane windows; new efficient external doors; the addition of a mechanical ventilation system with heat recovery; and a new wood stove.



Figure 1: A rendering of the single-family house analyzed, as planned after the renovation works

2.2 Business context analysis

The value proposed by the BM of the analyzed case study regarded the deep energy renovation of the house, together with a likely future reduction of energy/operating costs and a general enhancement of the house functionality.

Furthermore, the case study provided the implementation of different measures through several service providers and economic incentives from a governmental enterprise.

The actors involved in this project were several, including a research institute, SINTEF Building and Infrastructure, the Norwegian housing bank, a Norwegian government enterprise, the Norwegian Water Resources and Energy Directorate, an energy consulting company, an architecture firm, and numerous material suppliers.

The network of actors was asked to fill out a questionnaire, inclusive of different questions regarding, e.g., their role in the project, their knowledge about sustainability tools and business models, and their preference about remarkable criteria to evaluate the overall sustainability level of the project.

Based on the highest rated sustainability criteria, the performance indicators computed are: climate change (CC), non-renewable primary energy (NRPE), and global cost.

2.3 Performed sustainability analyses

Adequate analyses were performed to compute the above mentioned performance indicators for the case study.

CC and NRPE were assessed through the life cycle assessment (LCA) methodology, as defined in ISO 14040 (International Organization for Standardization, 2006). Specifically, material impacts were assessed by combining data from Environmental Product Declarations (EPDs) and Ecoinvent 3.0.1 database (Ecoinvent Centre, 2013). The latter was also used for modeling energy carriers and processes and was run in SimaPro 8.1.1 software (Pre Sustainability, 2016). Two impact methods were used to compute the chosen indicators: the cumulative energy demand (CED) method for NRPE and the Recipe method for CC.

The following life cycle phases were considered: **pre-use phase, including the materials' production and transport** to the construction site; use phase, including electricity and wood for heating, domestic hot water (DHW), lighting,

and electric appliances, together with the maintenance activities; end-of-life phase, referring to the waste final handling. The building life span after the renovation works was assumed to be of 50 years.

With respect to the pre-use phase, the total amounts of materials constituting the building envelope and technical building systems, together with main distances from the production places to the construction site, were collected based on the project documentation.

Regarding the use phase, the annual energy demand for heating was estimated by means of a dynamic energy simulation tool, IDA-ICE (EQUA Simulation AB, 2016). Moreover, data on the energy use for indoor lighting, electric appliances, and DHW were derived from the Norwegian standard NS 3031:2014. This standard was also used for the definition of various parameters needed for the energy simulation, such as air leakage, internal gains, and building occupation time. The International Weather for Energy Calculation 2.0 (IWEC2) database by ASHRAE was used as the source for hourly weather data of Oslo. Electric heaters located in all the rooms and an air-to-air heat pump placed in the living room represented the main heating systems. Furthermore, a wood stove was assumed to provide 20% of the energy demand for heating purposes.

The annual values of delivered energy were adapted to the building life span (50 years) and associated to eco-profiles available in Ecoinvent database. Furthermore, some maintenance actions were hypothesized, such as repainting external walls every 8 years; repainting internal walls and ceilings every 15 years, substituting windows and external doors after 30 years; replacing of roof covering every 30 years; replacing electric heaters after 20 years; and substituting **heating floor and ventilation system after 25 years.**

Regarding the end-of-life phase, information was already available for materials with EPDs, while for the other **materials some assumptions were made. Specifically, materials like steel, aluminum, iron, and polyethylene** were assumed to be recycled for the 80% of their amounts, while the remainder was assumed to be disposed in a **municipal landfill. Wood was assumed to be treated in an incineration plant, while other materials, such as concrete, glass, ceramic, and copper, were supposed to be entirely landfilled.**

The global cost was assessed according to EN 15459:2007 (European Committee for Standardization, 2007), through a life cycle costing (LCC) analysis. Specifically, the global cost was evaluated by summing up the investment and annual costs (including running costs and periodic replacement costs) and subtracting the final value of the building components. Both the annual costs and final values were actualized to the calculation year, by means of a real interest rate of 4%.

The investment costs, including the expenses for building materials, plants, and renovation works, were assessed through the available project documents, together with the Norwegian Price Book for the lacking data. The replacement costs were evaluated according to the substitution rate of building components, over the whole life cycle. Instead, the maintenance costs for technical building systems were calculated as a percentage of their initial cost, as in EN 15459:2007. The costs of electricity (0.91 NOK/kWh) and wood (0.65 NOK/kWh) were estimated by means of available statistical prices.

All the costs were considered with the value-added tax (VAT) included.

3. RESULTS AND DISCUSSION

The results for NRPE and CC are shown Table 1, normalized by the gross internal floor area. The use phase for both indicators is dominant among all life stages. This follows the trend in building energy renovation projects, where heating-related impacts lead the whole life cycle. Specifically, the annual delivered energy was 99.7 kWh/m², split in: 31.2 kWh/m² for heating, 8.2 kWh/m² for HVAC auxiliaries, 31.4 kWh/m² for DHW, 11.4 kWh/m² for lighting, and 17.5 kWh/m² for electric appliances.

For the NRPE results, the contribution of the pre-use, use, and end of life phases is within the following ranges: 6%, 94%, and -0.5%.

For the CC results, the pre-use, use, and end of life phases contribute within the following ranges: 10%, 84%, and 6%.

Note that the maintenance actions, inclusive of material production, transport, and cutting waste, are considered within the use phase, where they contribute with 10% for CC and 5% for NRPE.

	Pre-use phase	Use phase	End-of-life phase	Total
Climate change (kg CO ₂ eq./m ²)	104.8	894.6	64.3	1063.8
Non-renewable primary energy (MJ/m ²)	1583.7	24010.7	-123.2	25473.7

Table 1: Climate change (kg CO₂ eq./m²) and non-renewable primary energy (MJ/m²) in all the building life phases

The results for the global cost are shown in Table 2, where they are normalized by the gross internal floor area. As shown, the investment costs provide the highest contribution to the global cost, around 78%, while replacement, maintenance, and energy costs contribute with 9%, 3%, and 10%, respectively.

It should be mentioned that the investment costs were reduced by the economic support from Enova, a Norwegian energy enterprise, which consisted of around 5% of the expenses for envelope upgrading and balanced ventilation system installation.

Investment costs (NOK/m ²)	Replacement costs (NOK/m ²)	Maintenance costs (NOK/m ²)	Energy costs (NOK/m ²)	Global Cost (NOK/m ²)
14977.0	1798.9	588.5	1892.9	19257.3

Table 2: Main cost categories over the building life phases, actualized to the calculation year

The results of the computed indicators were grouped together and shown in a radar chart, as in Figure 2. A normalized scale factor was defined for each indicator so that they can all be displayed on the same scale, where 0 is the best level and 8 is the worst one.

The objective is to build such graphs for other possible EEM scenarios for the project and to compare them with respect to their overall sustainability level. Indeed, the radar charts should be interpreted considering that the smaller the area of the geometric shape in the chart, the better the sustainability performance of the scenario.

Other EEM scenarios for the analyzed project could include, for instance, renewable energy technologies, such as photovoltaic and solar thermal systems, or business as usual measures.

The analysis of further performance indicators, including social ones, would allow to have a more complete picture of the overall sustainability level of the project.

The radar charts might be used during the design phase to assess the performance of possible EEM scenarios from different sustainability-related points of view. Furthermore, such examinations could be meaningful in the BM perspective to link the value proposition, creation, and capture of the project not only to the economic domain but also to the environmental and social dimensions.

An effective implementation of the proposed analytic approach towards SBMs would involve the formulation of specific constrains, such as: a minimum number of EEM scenarios to evaluate, a minimum number of sustainability criteria and performance indicators to assess, a weight for criteria/indicators, and a minimum overall sustainability level to reach. Therefore, the proposed approach should be included in a more standardized and formal framework, to be actually supportive of sustainable business modelling for energy renovation projects.

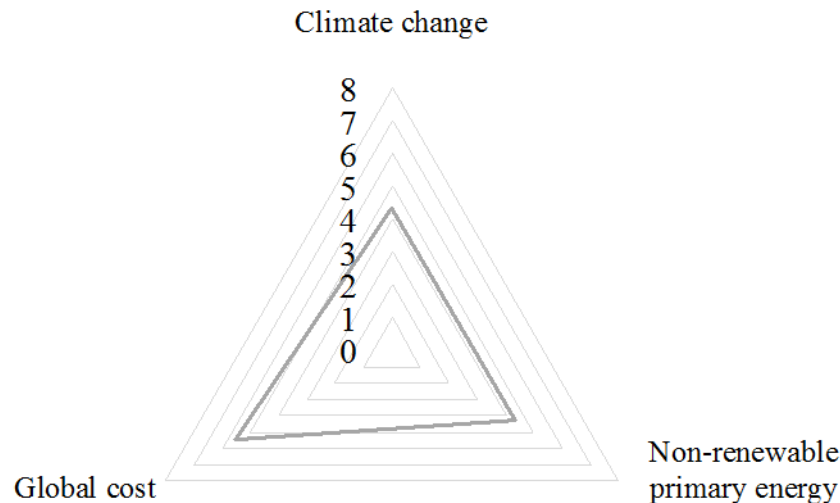

Figure 2: Radar chart including the results of different performance indicators for the case study analyzed

4. CONCLUSION

This research work addresses the lack of innovative approaches for sustainable business modeling in energy efficiency projects within the building field.

In particular, the article presents the early results from the implementation of an analytic approach in a deep energy renovation project, in order to foster BM innovation through quantitative sustainability analyses.

The proposed approach might promote discussion and awareness, among the stakeholder, on how the project could propose, create, and capture value, in a triple bottom line perspective and based on quantitative results. Moreover, such approach might serve for a wider use, e.g., incorporation into building codes for energy renovations or in government incentive programs.

The examination of a case study is meant as a valuable example for other similar projects, with the objective of a systematic integration of sustainability analyses into BMs.

Future research work might be focused on the implementation of the proposed approach in other similar projects, to develop benchmark values for the performance indicators to compute in such projects.

Furthermore, future examinations could cover also other energy efficiency projects in the building field, such as the construction of nearly zero-energy buildings (nZEB).

REFERENCES

- [1] [Accessed on 1 July 2016].
- [2] [Accessed on 1 July 2016].
- [3] **Abuzeinab, A. & Arif, M., 2014. 'Emergence of the Business Models in the Building and construction literature', paper presented at the International Conference on Construction in a Changing World, Kandalana, Sri Lanka, 4-7 May.**
- [4] Bocken, N., Short, S., Rana, P. & Evans, S., 2013. A value mapping tool for sustainable business modelling. *Corporate Governance: The international journal of business in society*, 13(5), 482-497.
- [5] Buildings Performance Institute Europe (BPIE), 2011. Europe's buildings under the microscope. A country-by-country review of the energy performance of buildings. Brussels: Buildings Performance Institute Europe (BPIE).
- [6] Cetiner, I. & Edis, E., 2014. An environmental and economic sustainability assessment method for the retrofitting of residential buildings. *Energy and Buildings*, 74, 132-140.
- [7] de T'Serclaes, P. & Devernois, N., 2008. Promoting energy efficiency investments: case studies in the residential sector. Paris: OECD/IEA and AFD.

- [8] Dentchev, Nikolay et al., 2016. Call for papers: Embracing the variety of sustainable business models: Social Entrepreneurship, Corporate Intrapreneurship, Creativity, Innovation, and other approaches to sustainability challenges. *Journal of Cleaner Production*, 113, 1-4.
- [9] Ecoinvent Centre, 2013. Ecoinvent database 3.0. [Online]. Available at: <http://www.ecoinvent.org> [Accessed on 1 July 2016].
- [10] EQUA Simulation AB, 2016. IDA Indoor Climate and Energy (IDA ICE), Version 4.7. [Online]. Available at: <http://www.equa.se/en/ida-ice> [Accessed on 1 July 2016].
- [11] European Committee for Standardization, 2007. EN 15459:2007, Energy Performance Buildings — Economic evaluation procedures for energy systems in buildings, Brussels: CEN.
- [12] International Organization for Standardization, 2006. ISO 14040:2006, Environmental management – Life cycle assessment – Principles and framework, Geneva: International Organization for Standardization.
- [13] Li, D. H., Yang, L. & Lam, J. C., 2013. Zero energy buildings and sustainable development implications – A review. *Energy*, 54, 1-10.
- [14] Moschetti, R. & Brattebø, H., 2016. Sustainable business models for deep energy retrofitting of buildings: state-of-the-art and methodological approach. *Energy Procedia*, 96, 435-445.
- [15] Osterwalder, A., Pigneur, Y. & Tucci, C. L., 2005. Clarifying Business Models: Origins, Present, and Future of the Concept. *Communications of the association for information systems*, 16, 1-25.
- [16] Pan, W. & Goodier, C., 2012. House-Building Business Models and Off-Site Construction Take-Up. *Journal of Architectural Engineering*, 18(2), 84-93.
- [17] Passer, A., Oullet-Plamond, C., Kenneally, V. & Habert, G., 2016. The impact of future scenarios on building refurbishment strategies towards plus energy buildings. *Energy and Buildings*, 124, 153-163.
- [18] Pre Sustainability, 2016. SimaPro, Version 8.1.1. [Online]. Available at: <https://www.pre-sustainability.com>
- [19] Richardson, J., 2008. The business model: an integrative framework for strategy execution. *Strategic Change*, 17(5-6), pp. 133-144.
- [20] Systematisk EnergiOPPgradering av småhus fra 1960, 2013-2016. [Online]. Available at: <http://seopp.net>
- [21] Xu, P., Chan, E. H.-W. & Qian, Q. K., 2011. Success factors of energy performance contracting (EPC) for sustainable building energy efficiency retrofit (BEER) of hotel buildings in China. *Energy Policy*, 39(11), 7389-7398.

The Development of Existing Buildings Green Retrofitting in China

WANG Qingqin^a, WANG Junliang^b, FAN Dongye^c

^a China Academy of Building Research, Mainland China, wangqq@cabr.com.cn

^b Chongqing University, Mainland China, wjjjh06313@163.com

^c Chongqing University, Mainland China, fandongye@126.com

ABSTRACT

There were 3979 projects, totally 460 million square meters of buildings certificated green building labels by Dec 31 2015, in which only 61 projects and 3.07 million square meters were retrofitted buildings. In China, there are more than 58 billion square meters existing buildings, and the green retrofitting of existing buildings will play a more important role in reducing energy consumption and global greenhouse gas emissions. In this paper, the **development of green retrofitting of existing building was summarized. The national standard “assessment standard for green retrofitting of existing building GB/T GB/T51141-2015” was issued on Dec 3 2015, the assessment method and main contents of the standard was introduced.**

Keywords: green retrofit, development status, technology application

1. INTRODUCTION

The construction and operation of buildings contributed to a large proportion of total energy end-use worldwide. After the reform and opening-up, urban and rural building industry developed rapidly, there have been more than 54 billion square meters existing buildings in China. And most existing buildings built before 1980s had such problems as weak disaster resistance capacity, high energy consumption, and unsatisfactory application function, due to the economic conditions of the time, design standard was relatively low. After 1980s energy saving standard be carried out, the existing buildings energy consumption had improved, but still in high carbon emission or poor environmental performance. It is unreasonable and imposable demolition and rebuild the buildings, retrofitting of existing buildings offers significant opportunities for reducing global energy consumption and greenhouse gas emissions (Zhenjun Ma et al., 2012).

Significant effort towards energy efficiency improvement or sustainable retrofitting in existing buildings had been taken by governments and international organisations at home and abroad. In 2009, US government announced a new \$450 million program designed to catalyze a nationwide energy upgrade that experts estimate could save \$100 million annually in utility bills for households and businesses(DOE, Buildings Energy Data Book,2010). In 2010, the UK government aimed at reducing carbon emissions by 29% by upgrading the energy efficiency of 7.0 million British homes by 2020 (Department of Energy &Climate Chang, 2010),and the International Energy Agency (IEA) launched a set of Annex projects to promote energy efficiency of existing buildings, such as: Annex 46 – Holistic assessment toolkit on energy efficient retrofit measures for government buildings; Annex 50 – Prefabricated systems for low energy renovation of residential buildings; Annex 55 – Reliability of energy efficient building retrofitting; and Annex 56–Energy and greenhouse gas optimised building renovation(IEA).

How to approach and tackle the existing buildings has great significance on the implementation of such strategies as energy saving, environment protection, establishment of a resource-efficient society and sustainable development, and therefore technical requirements for retrofitting existing buildings are need to be researched. Key phases in a sustainable building retrofit programme, key elements affecting building retrofits and main retrofit technologies were summarized shown as Figure 1.

Most retrofitted technology strategies were related to energy efficiency, Life cycle cost and payback analysis, occupied assessment (Fusion, 2010).

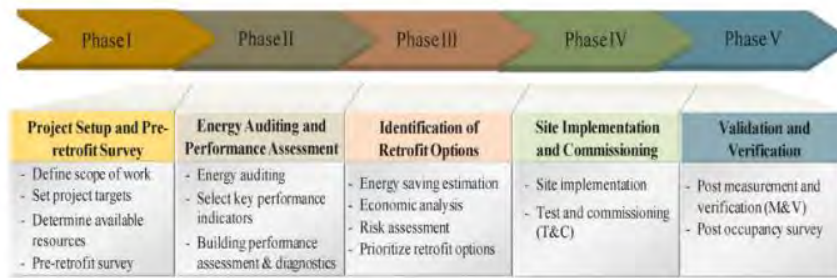

Figure 1: Key phases in a sustainable building retrofit programme (Zhenjun Ma et al., 2012)

In order to push forward scientific research of the project, the Ministry of Science and Technology and Ministry of House and Urban-Rural Development (MOHURD) approved the significant project" research and Demonstration of Key Technology of existing buildings retrofitting, to promote the retrofitting technology develop.

Compared to new buildings construction, there are more limitations for existing buildings in green retrofitting processes. The green retrofit technical application, for instance, must under corresponding evaluation. The investment, technical difficulties, environmental and social benefits factors also must be considered carefully to **meet the customer and the stakeholder's demands**. Du investigated people's response on building repair and retrofit, and identified the impediments of limited response in a case historical village Shangli located in disaster-prone mountainous area. The result showed that most of the local people were unsatisfied with the limited disaster resistance of their buildings. But their repair and retrofit activities were limited, 3 damaged buildings were not repaired or just partly repaired (Fei Du et al., 2016). The retrofitted work was mainly in Building Energy Efficiency Retrofit (BEER) to improve the buildings energy consumption, little work in green retrofitted buildings, because it need more efforts to reduce the resource consumption, to have a better performance and lower carbon emissions.

Li made a green retrofit survey and analysis of public institution building in Cold Region. Taking Shenyang as the main object of study, surveyed five typical public sector buildings green retrofit situation. Through the survey data analysis, it found that combined with the evaluation index system of green building, the suitable technical measures was the problem of public institutions existing in the retrofit process (Li et al., 2015). So in this paper, the development history was reviewed, and the technology researcher contents and technical measures were **summarized**. The first national standard "assessment standard for green retrofitting of existing building green retrofitting GB/T GB/T51141-2015" had been was laughed issued on Dec 3 2015, the assessment method and main contents of the standard were introduced. The aim of work is to provide a better understanding of existing building green retrofitting development and practice in China.

2. HISTORY AND POLICY MECHANISM

2.1 Development history

Compared to developed countries, the development process of China existing building green retrofitting had been relatively delayed. And it had experienced four different periods so far, which were the functional and reinforcement reconstruction period, the energy-saving reconstruction period, the comprehensive performance improvement period, and the green retrofitting period. In chronological order, the process was illustrated as below.

Mid of 80s, the 20th century

In this period, with the rapid development of industrialization and urbanization, big industrial enterprise had to move out of city center, many industrial buildings therefore faced function transformation and performance improvement problem. Most buildings needed to be upgraded, repaired, reconstructed or expanded (Bai, 1991). The key research issues were focused in industrial buildings' retrofitted characteristics, technology and policies, cultural and economic benefits. The typical cases during this period included Beijing FANGZHI Textile Building, SHUANG AN Shopping Mall, CHONGWENMEN Hotel, these buildings are still in good condition in the city (Du, et al., 1993, Deng, et al., 1996, Chen. 1995, Shen 1995).

In 1996, the Ministry of Construction (MOC) of the People's Republic of China (PRC) promulgated the "Ministry of construction Building Energy-saving the 9th Five Year Plan and 20-Years Plan ". The 9th Five Year Plan was aimed to improve the urban and rural buildings' thermal environment, people's living environment and to promote

energy efficiency. Energy-saving retrofit technologies and at the same time the route map were made up clearly in north of China. Building envelope and heating system retrofit design, construction and economic problems were also discussed during this period (Zhao, et al., 1998, Fang et al., 1998). The discussion and implementation of this issue started from cold north China and gradually expanded to the south regions (Li 1997).

The 10th five year plan (2001~2005)

Individual energy-saving retrofit technology was researched for different type buildings in different climate zones during the 10th Five Years Plan period. In the same period, some key technologies, plans, and standard system research work were carried out step by step. Policy and market mechanism were also established gradually, which promoted many new industries, such as insulation materials product industry, energy-saving equipment and production industry, and new construction materials industry (Tang et al., 2001, Qiu, 2003, Wang, 2004, Yu et al., 2004, Guo et al., 2004, Wang, 2002). A case in Nanjing was studied based on DeST dynamic simulation and energy efficiency retrofit analysis of commercial buildings in the hot summer/ cold winter zone of China (Changhai Peng et al., 2014).

The 11th five year plan (2006~2010)

At the end of 10th Five Year Plan, energy-saving retrofit theory and technology were becoming mature. Several integrated technologies were developed, energy-saving retrofit policies, new energy saving technology and materials standards were also implied and promoted (Li, 2009, Yu, 2007, Jiang, et al., 2008, Zhou, 2006, Chen, 2006). **“The comprehensive retrofit technology research and demonstration of existing buildings”** was regarded as one of key projects of the 11th Five Year Plan research projects (Yin, 2008).

During the research process of existing **buildings’ comprehensive retrofitting**, some scholars started to pay **attention to environmental burden**. Existing building and representative residential building’s status and residential building ecological retrofitting were analyzed and researched in Northeast China old industry areas (Jin et al., 2005). **The concept of existing building green retrofit was introduced on ‘The Key Technology Research and Demonstration of Comprehensive Retrofit Project of Existing Buildings Conference’ in Beijing 2009 (Wang, 2012)**. At present, green retrofit key technology research and demonstration project had been set up as the research theme supported by the National Science and Technology Support 12th Five Year Plan.

The main targets of the project are to study and develop key technologies of structure reinforcement, improvement of soil and foundation, special retrofitting machinery and materials and fire retrofitting machinery and materials and fire safety retrofitting for existing building and to apply for relevant patterns; to develop and revise standards, codes and polices including Technical Code and Improvement of soil and Foundation of existing buildings, Technical specification for repairing water leakage of house, Technical code for maintenance and strengthening of ancient timber buildings. Specification for repairing construction of civil buildings, technical specification for seismic strengthening of steel structures, technical code for indoor environmental improving.

2.2 Policy mechanism

In the perspective of existing buildings green retrofitting development process, its policy mechanism is in **correspondence with policy content for different periods**. In general, the **“Building Energy-saving 9th Five Year Plan and 2010 Plan”** established, the overall task, work goals and development strategy of nation’s building energy-saving work. And some implemented policies such as **“The Energy Conservation Law of the People’s Republic of China”**, **“The Law of the People’s Republic of China on Earthquake in Conformity”**, **“Civil Building Energy Efficiency Regulations”** have provided supervisions in the policy making process of existing building retrofit. Relevant government departments have also published a series of incentives to promote its development, such as **“Government Office Building and Large Public Building Energy Efficiency Special Funds Interim Management Measures”**, **“Heat Metering and Energy-saving Reward Fund Interim Management Measures for Existing Residential Buildings in North District”**, **“The Instructions on Promoting the Existing Residential Buildings Heat Metering and Energy-saving Work in North District”**.

About how to enhance existing buildings energy efficiency retrofit work, Zhang Li and Wang Yonghui had carried out some economic incentives research. Through the study of relevant incentive policies and measures, Wu Yong and Liang Yang suggested to provide subsidizing loan, tax incentives, governmental subsidies and special funds

to promote the development of retrofitted buildings. And if the advanced technologies and products were tested in actual project, those manufacturers and enterprises should enjoy tax relief or subsidiary as an encouragement for continuing technical innovation in future (Zhang, et al., 2008, Wu, 2010, Yang, 2010).

In 2012, some important policy were released. 'The Comprehensive Work Plan on Energy Conservation and Emissions Reduction in the 12th Five-Year Plan Period (2011-2015)', 'The Green Building Act Plan', and 'Green Building and Green Ecological District Development Plan in the 12th Five-Year Plan Period (2011-2015)' have partially specified the green building policies and regulations, and specified objective for existing building retrofit as well. It is planned to complete more than 400 million square meters heat metering and energy saving building retrofit in the northern heating area, to complete energy-saving retrofit residential building 50 million square meters in hot summer and cold winter area, and to reconstruct rural dangerous house demonstration projects 400,000 sets. By the end of 2020, it is planned to complete energy-saving retrofit work for most residential building in the northern heating areas.

3. TECHNOLOGY RESEARCH

In 2008, existing building green retrofiting started to grow. In 2011, it substantially stepped into a fast development stage. It was found that different research themes in different period show specific characteristics. Existing buildings function transformation and seismic reinforcement research were the main research themes during the 9th Five-Year Plan Period (1996~2000), during this period researchers paid more attention on the buildings function improvement, to made the old building or dangerous buildings more safe for users and avoided to be destroyed by the hazard.

And the ECR (Energy Conservation Retrofit) and BCPR (Building Comprehensive Performance Retrofit) themes in the 10th Five-Year Plan Period (2001~2005) and the 11th (2006~2010) Five-Year Plan Period respectively were focused on buildings energy efficiency and environmental improving. The GR (Green Retrofit) research was the theme of the 12th Five-Year Plan Period (2011~2015) which was a deep development of BCPR, now it had a system assessment index to the buildings retrofiting process as introduced in the following.

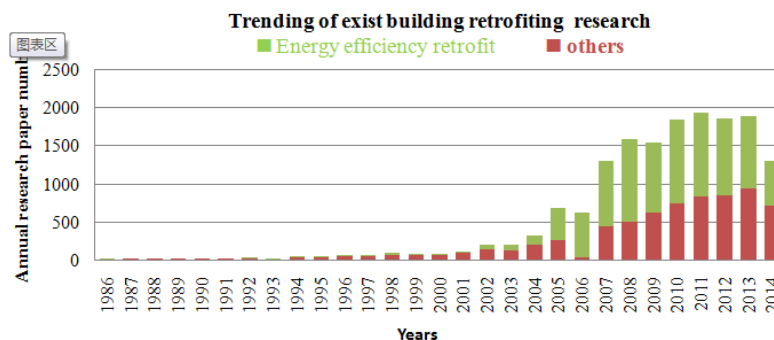

Figure 2: Existing buildings retrofitting research trend

From the Figure 3 we can see that four different themes were put up at the beginning of the Five Years Plan period. Though the research themes were different, the respective research content including the policy mechanism, technology development, standard system construction, project demonstration and application collectively keep a good cohesion relation. BCPR and GR research work and achievement will be introduced in the following article.



Figure 3: The research themes in deferent periods

3.1. BCPR (Building comprehensive performance retrofit)

Through the energy- saving retrofit technology research, it is discovered that there were more comprehensive contents required in existing buildings retrofitting evaluation, besides its safety, applicability, durability and **environmental factors**. **The existing buildings' economic efficiency, technical feasibility and social effect are also** need to be weighted. Therefore the comprehensive environment retrofit research, comprises the acoustic environment, light environment, thermal and humidity environment, indoor air quality and other healthy factors were all considered. For example, technical code for sound insulation improvement construction of existing buildings, foundation improvement construction of buildings, strengthening construction of concrete structures, and so on, all of those were needed to be assessed before retrofitting work.

There were ten topics in the 11th Five-Year Plan **'The Comprehensive Retrofit Technology Research and Demonstration of Existing Buildings' research project, which includes standard specification, testing evaluation, reconstruction safety, energy conservation, material and equipment, renewal, demonstration projects, etc.**

Integrated retrofitting for existing buildings involves diversified subjects and technologies such as structure design, function upgrading, building materials, renewable energy, history and culture, land resource, natural environment and cultural environment and so on. But all the researched technologies can be classified into 3 types: testing and evaluation technology, the comprehensive performance evaluation and comprehensive retrofitted technology. These research contents had considered every step of the retrofitting demand. For example, the retrofitting need of existing buildings should be tested and evaluated firstly, so the testing and evaluation Technology was studied. Then it was divided into several parts according to the building construction, including the envelope, the equipment and the power system upgrading, the water system, electronic system, and security system fixing, and so on. The retrofitted objects were consisted by residential buildings, office buildings and some public buildings. These buildings were mostly important buildings needed to make the more sustainable, including sustainable utilization of historic buildings and most of them were funded by the government.

Testing and evaluation technology

The testing and evaluation technology is the precondition of existing building retrofitting. Its contents include the safety and durability, disaster resistance and fire prevention diagnostic testing of the façade, foundation and structure of existing buildings. It also established evaluation index of retrofit technology applicability (Wang, et al., 2014).

Comprehensive performance evaluation technology

It is a multi-optimization problem to evaluate the comprehensive performance of existing buildings retrofit. The **building's environment performance, functional, healthy, comfort, technical** and economic rationality and other factors are all needed to be considered. Such technology considers the architectural space layout, the natural lighting, natural ventilation based on existing building surrounding environment. The fuzzy performance comprehensive evaluation method was then established based on fuzzy and extension theory (Chen long, 2004, Liu et al., 2007, Zhou et al., 2008, Dong et al., 2009, Fei et al., 2012).

Comprehensive retrofit technology

Comprehensive performance improvement technologies include the culture and function promotion, old building reuse, environmental performance retrofit, energy efficiency performance, etc. The energy efficiency factors during retrofit construction, operation and maintenance should all be considered, which constitute an energy efficiency system. Among all the retrofit process, building envelope retrofit is the one of the most important section, which is able to substantially improve the indoor comfort. The specific technologies researched include, thermal energy storage wall, energy efficient balcony structure, ventilation equipment embedded envelope, and so on. Other building equipment retrofit for, like energy station, water pump, ventilator, transmission and distribution system, AC terminal, etc. are also studied as key technologies.

Existing building comprehensive retrofit technology research laid a very solid foundation for existing building green retrofit research.

3.2. GR (Green retrofit) technology research

In order to promote the green technology application for existing building green retrofit, the government initiated '**Existing Buildings Green Retrofit Key Technology Research and Demonstration Program**' program, supported by the 12th NSTSP. Research contents covered residential buildings, urban communities, large commercial buildings, industrial buildings, office buildings and hospital buildings in different climate zones of China.

The research has already got some achievements, which have been introduced by Wang Jun etc. They also gave a conclusion of the research programme of China's existing building green retrofit and related standards research. Zhou Jianmin reviewed the green retrofit characteristics, indoor environment performance evaluation and test technology. In addition, Meng Chong summarized the existing building retrofit certificated projects(Wang 2014, 2012,Zhou 2013, Meng 2014).

China Academy of Building Research and other institutes were authorized to draft 'National Standard for Green Retrofit of Existing Building Assessment' sponsored by the Ministry of Housing and Urban-Rural Development People Republic of China. The standard consists of 11 chapters: a general provision in the former three chapters, 7 main categories of green assessment index of exist building retrofitting were included in fields of planning and construction, structure and materials, HVAC, water supply and drainage, electrical and lighting, construction and operation management respectively from chapter 4 to 10, and an innovation and improving measures also considered in chapter 11. Now the standard had finished and released by government on December 18, 2015.

7 main categories of green assessment index of exist building retrofitting were paid 100 points (Q1 ~ Q7), and one innovation categories no more than 10 points. they had different weight in design and operation period. And it can be calculated by Equation 1. It was divided into 3 certificated levels, ≥ 50 , one star level, ≥ 60 , two stars level and ≥ 80 , three stars level.

$$\Sigma Q = w_1Q_1 + w_2Q_2 + w_3Q_3 + w_4Q_4 + w_5Q_5 + w_6Q_6 + w_7Q_7 + Q_8$$

Equation 1

		Planning and Architecture w_1	Structure and Material w_2	Heating Ventilation and Air Conditioning w_3	Water Supply and Drainage w_4	Electricity w_5	Construction Management w_6	Operation Management w_7
Design	Residential buildings	0.25	0.20	0.22	0.15	0.18	—	—
	Public buildings	0.21	0.19	0.27	0.13	0.20	—	—
Operation	Residential buildings	0.20	0.17	0.18	0.12	0.14	0.09	0.11
	Public buildings	0.17	0.15	0.22	0.10	0.16	0.08	0.12

Table 2: GB/T51141-2015 assessment weights

4. CONCLUSION

The systematic research of energy-saving retrofit work and green retrofit projects has provided good condition and foundation for existing building green retrofit.

The green retrofit of existing buildings produces remarkable economic, social and environmental benefits, and the certified demonstration projects have a good guidance and play an exemplary role in promoting sustainable buildings development. Due to the complex process of green retrofit work, it needs more public attention besides of government promotion. More measures to drive the existing building retrofit market to transform to a more green way should be work out.

With the green buildings development, green retrofit will be play a more important role in sustainable buildings development, and it will be a key research of China's 13th NSTSP. The Standard for Green Retrofit of Existing Building Assessment GB/T51141-2015 would give a support in future, and in the 2030, 3% of existing buildings would be retrofitted.

REFERENCES

- [1] Bai Shaofeng. 1991. Industrial Construction Discuss about the transformation of BaoTou Steel Metallurgy industrial buildings [J]. Science & Technology of Baotou Steel (Group) Corporation, 119-124.
- [2] Changhai Peng, Ling Wang, Xiaosong Zhang, DeST-based dynamic simulation and energy efficiency retrofit analysis of commercial buildings in the hot summer/cold winter zone of China: A case in Nanjing, Energy and Buildings, Volume 78, August 2014, 123-131.
- [3] Chen Chang-Sheng. 1995. The old building have a bright future - Beijing ChongWenMen hotel renovation [J]. Architectural Journal, (Sep 1995), 49-52.
- [4] Chen Fujiang. 2006. Technology optimization and evaluation methods research of existing buildings energy conservation [D]. HUST (Hua Zhong University of Science and Technology)
- [5] DECC, Warmer homes, greener homes: a strategy for household energy management, UK Department of Energy and Climate Change. <http://www.decc.gov.uk/> (accessed on 10.01.12).
- [6] Deng Xuexian. 1996. Old buildings upgrade and renovation - new subject in the construction of the Beijing city [J]. Architectural Journal, 03-20
- [7] Dong Hairong, Qi Shaoming, Sun Xiaolu, Wu Xin. 2009. Study on technology of energy saving reconstruction on existing residential building in cold district [J]. Industrial Construction, (July 2009), 4-6.
- [8] Du Xiansheng, Feng Zhongping, de-xiang li, etc. 1993. Symposium, reinforcing and rebuilding engineering design of a textile building [J]. Architectural Journal, (Sep 1993),8-20.
- [9] F. Ardenete, M. Beccali, M. Cellura, M. Mistretta, 2011. Energy and environmental benefits in public buildings as a result of retrofit actions, Renewable and Sustainable Energy Reviews 460–470.
- [10] Fang Xiu-mu, Meng Fanbing. 1998. Existing building heating system condition analysis after the construction energy conservation transformation [J]. Wall Materials Innovation & Energy Saving in Buildings, (June 1998), 28-29.
- [11] Fei Bi-gang LIU Jing-bo, LIU Heng. Comprehensive performance assessment method for office buildings and its application [J]. Journal of Beijing University of Technology, 2012,04: 518-523.
- [12] Fei Du, Kenji Okazaki, Chiho Ochiai, Hirohide Kobayashi, Post-disaster building repair and retrofit in a disaster-prone historical village in China: A case study in Shangli, Sichuan, International Journal of Disaster Risk Reduction, Volume 16, June 2016, 142-157c
- [13] Fusion, 2010. A Review of Retrofit Technologies, Salford Centre for Research & Innovation in the Built & Human Environment, University of Salford, UK
- [14] Gan Yuelang, Peng Bo, Yuan Li, et.al. 2013. Passive design strategies of green retrofitting extensive investigate - taking Wuhan comprehensive retrofitted project as an example [C]. The 9th International conference on green building and building energy conservation Essays,1-9.
- [15] Guo Yong-hui, Ma Aihua, Karen wang. 2004. Energy-saving renovation of existing buildings heating system [J]. Refrigeration & Air Conditioning, (Mar 2004),57-59.
- [16] Huixing Li, Xiaoxu Cai, Guohui Feng, Shui Yu, Yibo Zhao, Yanhe Wang, Green Retrofit Survey and Analysis of Public Institution Building in Cold Region, Procedia Engineering, Volume 121, 2015, 1510-1514
- [17] Jiang Feng, Gao Min, Chen Zhijian. 2008. Chongqing area residential building energy conservation technology research and discussion [J]. Building Energy Efficiency, (July 2008),61-64.
- [18] Jin Hong, Song Fei, chun-hui Chen, etc. 2005. Old industrial worker housing ecological retrofit strategy in Dongbei [J]. Journal of Architecture Civil Engineering, (Vol 22(2)),72-74.
- [19] Lang Siwei. 2002. Current Situation and Progress of Energy Efficiency Design Standards in Buildings in China [J]. REFRIGERATION AIR CONDITIONING & ELECTRIC POWER MACHINERY, (Mar 2002), 1-6.
- [20] Li Baiyi. 2009. Building envelope insulation energy saving technology research [D]. Xi'an University of Technology
- [21] Li Qun. 2013. Establishing Environment by Nature, Creating Green by Space Green Remodeling for the Existing Building of Shanghai Shendu Mansion [J]. Architectural Journal, (July 2013),70-77
- [22] Li.Yong-Shou 1997. (MOC)Ministry of Construction will retrofit old buildings to improve energy efficiency [J]. Building Materials Industry Information,(Sep 1997),6
- [23] Liu Chunpu, Chen Wanjun. 1983. The characteristics of the reconstruction project and technology policy issues of industrial Construction [J]. Industrial Construction, 10-28,
- [24] LIU Ming, LI Li, etc. 2007. Application of extenics theory in evaluation of synthetic performance of residence building [J]. JOURNAL OF LIAONING TECHNICAL UNIVERSITY, (Jan 2007), 65-67.
- [25] Long Chen. 2004. Residential construction comprehensive performance of the fuzzy evaluation method [J]. Journal of Chongqing Polytechnic College, (Mar 2004), 6-8.

- [26] Meng Chong. 2014. Green retrofitted building certificated project status and analysis [J]. Construction Science and Technology,(2014,07),18-20.
- [27] O. Mejri, E.P.D. Barrio, N. Ghrab-Morcos, 2011. Energy performance assessment of occupied buildings using model identification techniques, Energy and Buildings.285–299.
- [28] Qiu Xiang. 2003].energy efficiency retrofit in hot summer and cold winter zone[J]. Wall Materials Innovation & Energy Saving in Buildings, (Nov 2003), Ren Jun, Wang Zhong, etc. 2013. Existing Building Green Remodeling Experiment for Super Low Energy Consumption Tenio Green Design Center [J]. Architectural Journal, (July 2013), 86-93
- [29] Shen Fuxu. 1995.Social and cultural factors and renovation of old residential building design evaluation [J]. South Architecture, (Feb 1995), 21-25.
- [30] T.M.I. Mahlia, H.A. Razak, M.A. Nursahida, 2011.Life cycle cost analysis and payback period of lighting retrofit at the University of Malaya, Renewable and Sustainable Energy Reviews. 1125–1132.
- [31] Tang Ming, Chen Hui. 2001. Building envelop energy-saving renovation and materials [J]. Building Energy Efficiency, (January 2001), 5-7.
- [32] Tong Quan. 2006. During the 11th five-year plan our country existing buildings energy saving reconstruction of 560 million square meters [J]. Solar energy, (Feb 2006), 47.
- [33] Wang jun, qing-qin wang, Ye Ling Chen Leduan. 2012 . **“The National Science & Technology Pillar Program during the 12th Five-year Plan Period”**— green retrofit key technology research and demonstration of existing buildings [J]. Construction Science and Technology, (Nov 2012), 38-39.
- [34] Wang jun, Qingqin Wang, Ye Ling Chen Leduan. 2012. Green retrofitting technology research and demonstration of existing buildings [J]. Housing Industry,(July 2012), 57-58.
- [35] Wang Jun, Yun-gui Li, et al., 2014. Existing buildings integrated transformation key technology research and demonstration [J]. Construction Science and Technology, (2014, Z1), 33-35.
- [36] Wang jun. 2002.Urban transformation problem research [D].Dongbei University of Finical and Economics
- [37] Wang Jun. 2014. Scientific Research › Standards and Case Studies of Green R etrofiting of Existing Buildings [J]. Construction Technology, (Nov 2014), 4-9.
- [38] Wang Shi. 2004. Research on residential building rebuilt and expansion [D]. Tian Jin University
- [39] Wu Yong, 2010. Incentive Polices and measures for existing building energy saving [J]. CHINA PROPERTY MANAGEMENT, (Oct 2010), 18-19.
- [40] Yang Liang, Bi Jihua. 2010. Promoting existing building policy research in China [J]. Construction Science and Technology, (Oct 2010), 78-80.
- [41] Yin Bo qing-qin wang. 2008. Architectural comprehensive renovation research direction and development trend -**“The 11th Five-Year National Science and Technology Support Plan series subject of major projects”**[J]. **Construction Science and Technology, (June 2008), 83-88.**
- [42] Yin Bo, Qingqin Wang. 2008. Architectural comprehensive renovation research direction and development trend -**“The 11th Five-Year National Science and Technology Support Plan series subject of major projects”**[J]. **Construction Science and Technology, (June 2008), 83-88.**
- [43] Yu Jinghua. 2007. Hot summer and cold winter area residential building energy saving technology research [D].Hu Nan University
- [44] Yu Wengong, Yang Zhao. 2004. Benefits analysis of residential heating buildings energy conservation reconstruction [J]. Energy Conservation, (Dec 2004), 21-23+2.
- [45] Zhang li, Wang yonghui. Economic Incentive Polices for building energy efficiency construction [J]. CONSTRUCTION ECONOMY, 2008, 06:94-96.
- [46] Zhao Li-hua, Guo Jun, Xiu-mu Fang. 1998. Energy saving reconstruction research of existing buildings in Harbin [A]. HVAC professional committee of architectural society of china, Chinese Association of Refrigeration 5th professional committee. HVAC& Refrigeration of 1998 academic collection [C]. HVAC professional committee of architectural society of china, Chinese Association of Refrigeration 5th professional committee, 4
- [47] Zhenjun Ma, Paul Cooper, Daniel Daly, Laia Ledo, 2012, Existing building retrofits: Methodology and state-of-the-art, Energy and Buildings, 889-902, ISSN 0378-7788.
- [48] Zhou Hong-bo,YAO Hao. 2008. Fuzzy comprehensive evaluation on the sustainable retrofit of existing industrial buildings [J]. CONSTRUCTION MANAGEMENT MODERNIZATION, (June 2008), 28-32.
- [49] Zhou Jianmin, Yu Hongbo,etc. 2013. Characteristics of green retrofitting method and examples[J]. Construction Science and Technology, (July 2013), 34-37.

- [50] Zhou Xiaoli. 2006. Existing heating residential building energy conservation reconstruction research and software development [D]. Hebei University of Technology

Session 6.4: Deep Renovations – Practices & Performance Review

The Verification and Implementation of Practical Renovation for net-ZEB Office

Hiroaki TAKAI^a, Takeshi ISHIGURO^b, Hiroshi ABE^c, Kouji TANAKA^d, Katsuhiko HIRANO^e, Kazuki WADA^f, Hiroki KAWAKAMI^g

^a Takenaka Corporation, Japan, takai.hiroaki@takenaka.co.jp

^b Takenaka Corporation, Japan, ishiguro.takeshi@takenaka.co.jp

^c Takenaka Corporation, Japan, abe.hiroshib@takenaka.co.jp

^d Takenaka Corporation, Japan, tanaka.kouji@takenaka.co.jp

^e Takenaka Corporation, Japan, hirano.katsuhiko@takenaka.co.jp

^f Takenaka Corporation, Japan, wada.kazuki@takenaka.co.jp

^g Takenaka Corporation, Japan, kawakami.hiroki@takenaka.co.jp

ABSTRACT

In Japan, energy-saving renovation of existing buildings has become an urgent issue. In the Japanese stock office buildings, the offices that less than 10,000m² accounts for 98%.

On March, 2016 Authors designed and completed the renovation for net-ZEB office in the local city Chiba near Tokyo. We introduced various technologies and reduced the energy consumption by approximately 70%. And we created renewable energy to exceed the remaining energy consumption, and it is expected to achieve a plus energy building.

The concept of this renovation project are (1) variety of comfort, (2) super energy saving, (3) work smart, (4) disaster resistance. Without the use of fossil fuels as much as possible, we adopted radiation air conditioning and desiccant air conditioning using geothermal heat and solar heat. And it is characterized by the combination of maximum daylighting and natural ventilation. We were carried out wellness air conditioning control based on the metabolic rate and comfort declaration of workers. We report the effect of the energy reduction by re-design to change work-mode and use of various spaces, and the effect of the energy reduction by façade renovation. This office has achieved a plus energy up to now, and we report the verification result of one year. At last, we consider about the essence of the ZEB renovation from LCC's point of view.

Keywords: net-zero energy building, renovation, wellness control

1. OUTLINE OF THIS RENOVATION OFFICE

In Japan, energy-saving renovation of existing buildings has become an urgent issue. In the Japanese stock office buildings, the offices that less than 10,000m² accounts for 98%.

This branch office, completed in 2003, has two stories and floor area of 1,318m². It is located near Chiba City, Chiba Prefecture. Approximately 60 workers are using this office. This office has the plan form of 38.6m × 17m. Existing exterior skins were single skins with vertical fins. The renovation of this actually using office was carried **out in half a year from October 2015 while the workers staying in this office. And it's the office aiming net-ZEB.** The generation of solar panel has started from May 2016.

After the renovation, the office layout of the second floor was greatly changed. Previous plan was the layout for few groups that have each desks, meeting tables, filings, and copying machines. After the renovation, the office was divided into Workplace, Communication area, and Filing area. And by renovating the exterior skin to the double skin, the perimeter heat load was greatly reduced.



Figure 1: Exterior of the building after renovation

2. CONCEPTS OF THIS OFFICE ZEB RENOVATION

We have considered the following four concepts in this renovation planning. **The first is “Variety of Comfort”, the second is “Super Energy Saving”, the third is “Work Smart”, and the fourth is “Disaster Resistance”.**



Is your office really comfortable?
Is it really environmentally efficient?

Concept #1 **Variety of Comfort**

We need to change the way we think about comfort. That is the only way to reduce the environmental load of a building. For example, controlling indoor temperature and humidity alone is



To really save energy, a building needs integrated control, maximum use of natural energy and advanced technologies.

Concept #2 **Super Energy Saving**



It's not smart to run computers when they are not being used or to leave air-conditioning on in large empty rooms or the lights on when nobody is there. We need to be smarter.

Concept #3 **Work Smart**



If buildings need less energy, they can manage better even when lifelines are damaged during a disaster.

Concept #4 **Disaster Resistance**

3. THE CONTENTS OF PLANNING AND TECHNOLOGIES

3.1 Variety of comfort

The first concept “**Variety of comfort**” consists of items such as:

Instead of keeping the room at constant temperature and humidity, we actively introduce the outside air when good climate and workers feel the natural change. Lowering the ceiling surface temperature slightly improves the comfort by removing heat from person. Also we improve the comfort by lowering humidity. In this way, our proposal is “to achieve variety of comfort, reduce heat load, and reduce energy consumption”.

With regard to daylighting, there is only 8.5m distance from window to the centre of the office, and both sides daylighting, and also the office has the top lights on both sides. On the outside of the windows, outside blinds are installed, and automatically adjust the slat angle in accordance with the amount of solar radiation and sun position. Air diffuser is installed on the ceiling for each worker, and workers can adjust the air volume by their smart phone or personal computers. Desiccant outside conditioner supplies the outside air of low humidity to the room. This conditioner is very compact and concealed in the ceiling, and has cooling coil, re-heat coil, and total heat exchanger.

3.2 Super energy saving

The second is “Super energy saving”. In this concept, advanced thermal performance renovation of the exteriors is the first point. We added 100mm heat insulation at roof, also 50mm insulation at exterior wall, and changed “single glass” to “gas-filled Low-E glass”. In addition we made outer glass on the outside, and made double skin. In this double skin outside blind automatically moves to cut the solar radiation. The perimeter heat load is reduced

to one third, and cooling peak load including the heat of lighting, human and OA machines is reduced 60% from existing office.

Lighting is the LED task and ambient system, and was developed as a product that face is divided into nine parts. Ambient illumination setting is 300Lx at the time of sitting, and 100Lx in the absence, automatically dimming by the thermal human sensors. Task lighting can also adjust the amount of volume and colour individually.

We planned the ceiling radiation system as the air conditioning system. We think important that the ceiling radiation system can use direct geothermal heat. By controlling ceiling surface a little cool temperature, this system removes radiation heat from the person, and gives comfortable feeling to the worker rather than the convection system. We installed the piles to take the heat from the ground on site, and used this direct geothermal heat to the cooling coil of ceiling radiation and desiccant air conditioning. Direct use is carried out all day hours in intermediate season and morning hours in summer etc. When the cooling water temperature rises in summer, the system switches from direct geothermal to cooling heat source. And we also installed the solar heat collection panel on the roof, accumulated hot water to the tank, and used the desiccant re-heat and radiation heating in winter.



Figure 2: Integrating most advanced technologies for ZEB

3.3 Work smart

The third concept “Work Smart” takes the idea to change the environment set point depending on area. At the workplace area, lighting, air conditioning, diffuser etc. are finely adjusted for each worker. At the communications area, workers can select a location, and this area is like an ambient area, and daylighting and natural ventilation are often used. At the filing area, lighting and air-conditioning are operated only when worker enters to see the document for reducing energy consumption. On the other hand, we drastically reduced the number of the printers and copy machines and installed at only one corner in the communications area to minimize the outlet consumption.

Also a trial of wellness air conditioning control system has started. This system combines with the personal health information, such as the metabolic rate and heart rate from the smart watches and smart phones of individual, personal comfort declaration data, position information of the individual, and temperature and humidity data of each zone. It makes the comfortable air-conditioning control such as diffusers air volume or ceiling temperature according to the worker.

3.4 Disaster resistance

The fourth “Disaster Resistance” is achieved by performing the three concepts mentioned before. Because of energy consumption minimization, fans, pumps, lighting fixtures, or OA machines can run for a long time. Solar power can be used when there is sunlight. Geothermal heat, solar heat can be used when pumps can move. Natural ventilation can be also used in case of emergency.

Photovoltaics panel is installed on the roof, and also solar heat collection pane is installed on the roof. Further this office has the re-use lithium-ion battery. If infrastructures are breakdown, this office can run about 6 days in summer, about 3 days in winter, about 7 days in intermediate season.

3.5 Integrated system control

We integrated the above devices, adding indoor and outdoor sensors data, and the control is performed to achieve minimization of energy consumption while keeping the comfort indoor environment. This system is operated by cloud CPU. Operation such as setting point change, real-time monitoring is possible by the parties from outside.

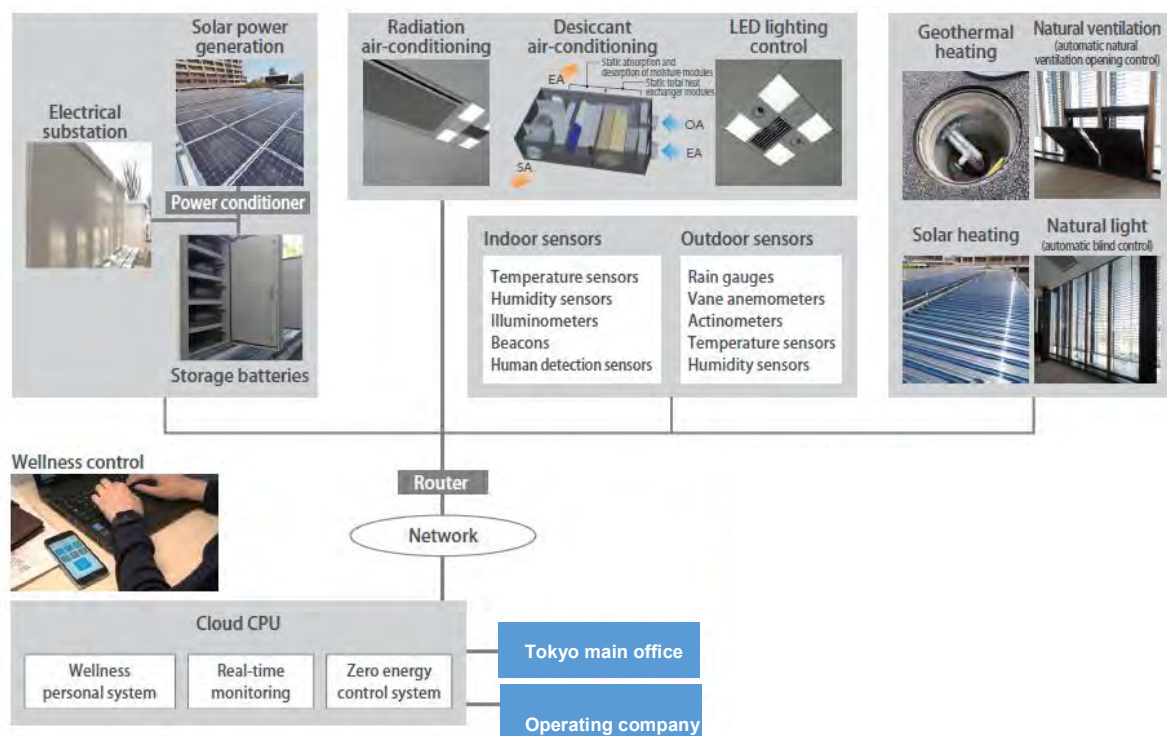

Figure 3: Integrated control system

4. PREDICTION OF ENERGY AND STUDY OF LIFE CYCLE COST

The prediction of energy consumption and energy generation is shown in the Fig-4. We set the reference amount of consumption to the actual consumption of existing office. And we predict that the energy consumption of this renovation office is reduced about 70% by the practice of mentioned four concepts. Further, we predict the remaining 30% is reduced to plus energy by solar power (photovoltaics panel). We note that this energy consumption includes the outlet consumption.

Next, we note the study result of life cycle cost of this building model. In the case of reducing 50% consumption in the renovation, number of years of pay back due to energy cost savings for the investment cost was approximately 15 years. At 100% reduction of the case, it was approximately 20 years.

In the case of reducing 50% consumption in the new construction, number of years of pay back due to energy cost savings for the investment cost was approximately 7 years. At 100% reduction of the case, it was approximately 14 years.

If life cycle of the building is nearly 100 years or there is a risk of energy costs rising, number of years of pay back will be improved. If working hours are reduced by productivity improvement, there is an effect that labour costs will be reduced. And also there is an effect that BCP is improved. In this way, Zero Energy Building can increase the benefits from LCC's point of view.

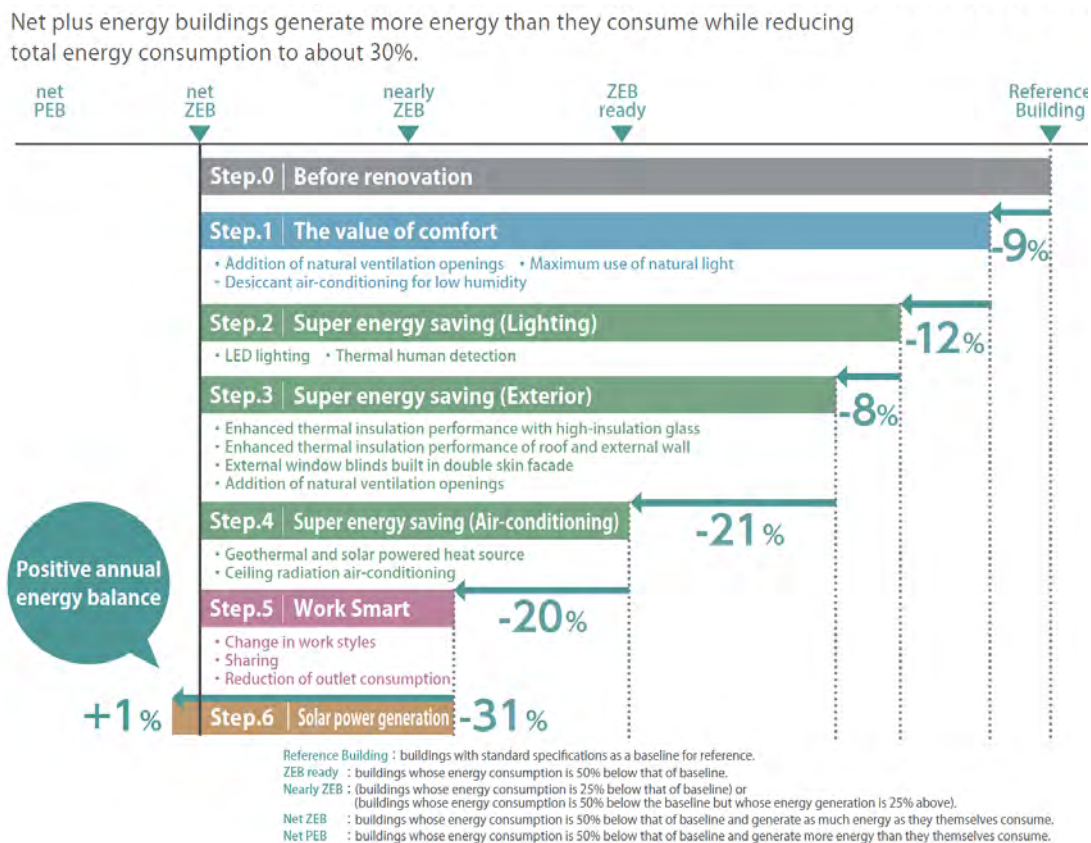

Figure 4: The prediction of energy consumption and energy generation

5. VERIFICATION AND IMPLEMENTATION OF ACTUAL DATA

This building was passed eight months from running. Energy generation has become the result of greater than energy consumption. We will continue the verification and implementation (commissioning) of one year, and report at this WSBE Conference 2017.

6. FUTURE TASKS

We think there are several future tasks in this building. They are as follows. And we will continue to verify, together with the improvement of how to use.

The operation of direct use of geothermal heat, the operation of direct use of solar heat, setting the indoor temperature, humidity and ceiling surface temperature, commissioning of wellness air conditioning control, matching between wellness control and adaptive model, the expansion of wellness control to the light environment and so on.

Humid Wall: Review on Causes and Solutions

Mohamad KHARSEH^a, York OSTERMEYER^b, Claudio NÄGELI^c, Izabela KURKOWSKA^d, Holger WALLBAUM^e

^a Chalmers University of Technology, Sweden, mohamad.kharseh@chalmers.se

^b Chalmers University of Technology, Sweden, york.ostermeyer@chalmers.se

^c Chalmers University of Technology, Sweden, claudio.naegell@chalmers.se

^d Chalmers University of Technology, Sweden, izabela.kurkowska@chalmers.se

^e Chalmers University of Technology, Sweden, holger.wallbaum@chalmers.se

ABSTRACT

Due to having airtight buildings, humid or wet walls have become a common problem in the last decades. Some common consequences of having humid walls is the growth of mold, which has a bad impact on the health and the comfort level of the internal environment. There is evidence that the effect of humidity on health is strong. Furthermore, the moisture content of the wall has a direct impact on its thermal resistance. This is due to the increase of thermal conductivity value of the wall. Briefly, the humid wall problem has a direct consequence on both energy consumption of the heating system and the health of the occupants. Hence, preventing and fixing humid wall problem is a challenge that is worth a closer investigation.

Humid walls can be a result of an external reason; namely external moisture enters the building through the envelope of the building. Alternatively, the moisture that comes from cooking, bathing, washing, and people can constitute an internal cause of humid walls in buildings with poor ventilation system and low insulation level. The current paper studies the causes of humid walls and the possible solutions. Comparisons between different solutions are made.

Keywords: humid wall, drying process, wall treatment, thermal resistance

1. INTRODUCTION

Sustainable design of building concentrate mainly on three area including (Karagiozis, Salonvaara, 2001): 1) **energy performance**, 2) **environmental impact**, and 3) **inhabitants' safety and health**. **Exclusively dealing with these critical areas might lead to make the interior environment more isolated from the exterior environment.** This results in increasing the indoor relative humidity and, consequently, more ventilation rates are needed. In many cold humid climates, due to having airtight buildings, humid or wet wall became a common and serious problem in the last years (Hens et al., 2007, Vos, Tammes, 1978, Newman et al., 1982b, Newman et al., 1982a). In 1970s, for instance, buildings were constructed and retrofitted to reduce energy consumption. Definitely, these measures made the building more energy efficiency of the buildings improved. However, this approach created problems in respect to stability of the building envelope as moisture accumulation in the building structure (Tariku et al., 2010). In addition, **moisture problems are the cause of significant economic costs from both repairs and health of the occupants' perspective** (Burke, 2009).

Building envelope, both above and below the grade, plays a role in determining the amount of moisture gain or loss that the building and its mechanical system has to deal with. Moisture can enter the wall through capillary and small cracks in the concrete rendering and becomes trapped in the construction (Van Belleghem et al., 2015, Barrett, 1998). Buildings in most cases are very tight. This means that in a house with a poor ventilation system, the moisture that is released into the indoor air from cooking, bathing, washing, and people has no other way to escape the house, which might cause condensation on the cooler surfaces. In addition, the moisture can enter the buildings through capillary action. The latter occurs where the water travels through the walls through small pore spaces or small cracks in the concrete and becomes trapped. Some common consequences of having humid wall is mold growing, which has a bad impact on the health and the comfortable level of the internal environment. There is evidence that the relationship between the humid and health is strong since the humid in buildings appears to increase the risk of cough, respiratory illness, wheeze, and asthma (Bornehag et al., 2004).

On the other side, the moisture content of the wall has a direct impact on the thermal resistance of the walls (Tinker et al., 1992). This is due to the increase of thermal conductivity value of the wall. In order to demonstrate the impact of the moisture on the thermal resistance of the wall, many materials have been tested in laboratory with different moisture content. As shown in Figure 1 (Veas, 2006), the moisture content affects the thermal conductivity of the

materials and, consequently, the wall thermal resistance. It is worth mentioning that at the design stage the moisture content of wall is usually assumed to be 3% at the inner side of a wall and 5% at the external side (Tinker et al., 1992). Hence, moisture content of building envelope has a significant effect on the heating load of the building. For example, assumed wall thickness is 20 cm of:

- Brick wall: Increasing the moisture content of the walls from 5% to 13% leads to reduce the thermal resistance by 25%
- Concrete wall: Increasing the moisture content of the walls from 3% to 5% leads to reduce the thermal resistance by 20%.

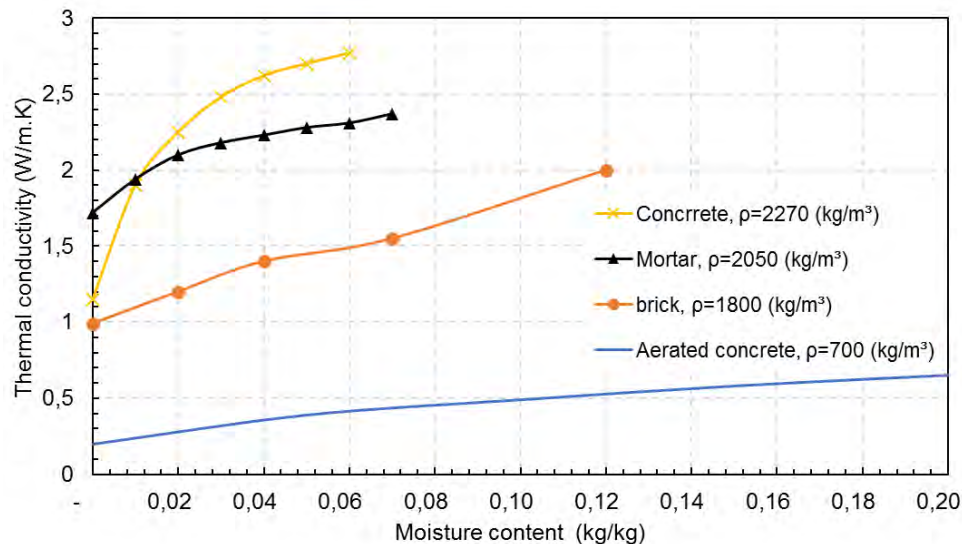

Figure 1: Relation between moisture content and thermal conductivity at temperature equals 20°C

In addition, currently there is general engorgement to refurbish a lot of buildings to match with current thermal performance standards. Yet, humid walls are a barrier to refurbishment as they increase cost of refurbishment. Accordingly, understanding **humid walls problem and solutions seem to be of significant benefits for tenants'** comfort, building stability, energy performance of the building, and refurbishment of such buildings. Current work, therefore, discusses the sources and the solutions of increasing wall moisture content.

2. SOURCES OF INCREASING WALL MOISTURE CONTENT

To have permeant solution of wet wall, it is very important to know where the moisture comes from. In cold climate, the common cause of humid walls is having the surface temperature lower than the dew point. The latter depends on the dry bulb temperature and the relative humidity. Hence, the internal relative humidity must be kept at a certain level that guarantees the dew point to be kept lower than the surface temperature. This can be achieved either by using dehumidifier and/ or use sufficient amount of ventilation air. In addition, installing insulation on the wall that is exposed to the external cold air can reduce the risk of having wall surface temperature lower than the dew point.

Conversely, in some cases humid wall can be a result of external reason. In such case the external moisture enters the building through the envelope of the buildings.

As depicted in Figure 2, the main moisture sources can be classified into two main categories include (Van Belleghem et al., 2015):

- External source includes precipitation, surface water/ runoff, and groundwater
- Internal source, namely high relative humidity of internal environment.

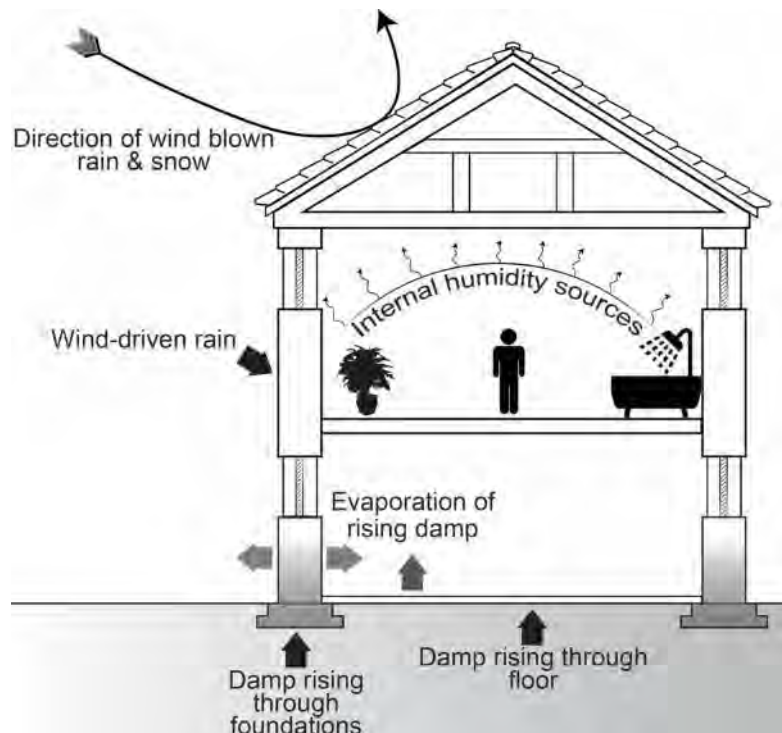

Figure 2: Sources of humid wall problem in the buildings

2.1 Internal source, i.e. the indoor humidity

Moisture released from cooking, bathing, washing, people has no way to escape the house. In the cases where the buildings have poor thermal performance, accumulation of the internal humidity causes condensation on the cooler surfaces. This is a common problem in cold climate buildings where the condensation on the warm side of exterior wall during the wintertime has a high probability for condensation. The temperature of the walls can reach the dew point due to poor insulation or higher thermal bridges (Calbureanu et al., 2010). The relation between the dew point temperatures, dry bulb temperature, and humidity of the air is illustrated in Figure 3. For instance, if the indoor temperature is 20 and the relative humidity is 70%, the condensation will occur on the walls if the temperature of the inner side become lower than 15°C.

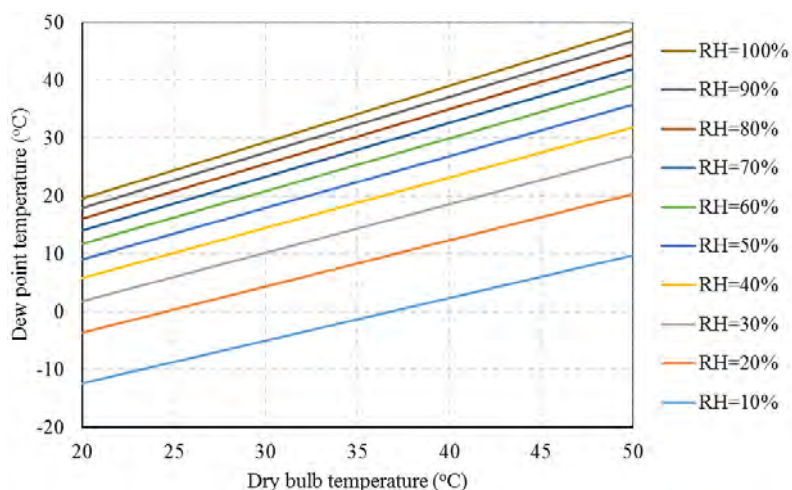

Figure 3: The dew point temperature as a function of relative humidity and dry bulb temperature

2.2 External source, e.g. rainwater

Rainwater, melting snow, or groundwater can saturate the soil around the foundation of the buildings and, consequently, leak in. As well as, the wind driven rain can penetrate the external walls due to the porosity or the cracks that exist in the wall (Van Bellegem et al., 2015, Hens et al., 2007).

2.3 Damp rising

In this case, the moisture is leaking vertically into the building. If the surrounding ground has a high level of the moisture, water will rise by capillary action through the pores and evaporate internally. Consequently, salts crystal is formed on the internal surface of the walls. Hence, even if a solution that prevents ground water to enter the building was applied, the salts on the wall will continue to absorb moisture from the surrounding indoor environment and, consequently, the wall remains wet (Damp proofing, 2016).

3. DIAGNOSE

It is often difficult to detect the cause of wet walls problems in buildings. However, the easiest way to find out the source of the problem is using a large sheet of aluminum foil to be taped to the considered wall and inspect it few days later. Moisture behind the foil indicates moisture is leaking from outside through the walls. While, moisture on the outside surface of the foil means high indoor humidity.

Alternatively, using moisture meter and moisture content of the wall at different depth in the wall. Two cases can be distinguished:

- The moisture content increase with the depth (from inside toward outside): this indicates that the source of humidity is external.
- The moisture content decreases with the depth (from inside toward outside): this indicates that the source of humidity is internal.

4. WALL DRYING OUT METHODS

The speed of drying is largely dependent on (Kidd et al., 2010): 1) drying method, and 2) wall materials. Three methods are commonly used to dry out the wall:

- Heat-based methods: Using heat and ventilation,
- Dehumidifier: Using heat pump to absorb the humidity from the indoor space,
- Chemical-based method: Using chemical agent, such as Sodium hydroxide, to absorb the humidity from the indoor space.

4.1 Heat-based method

In the heat-based method, a lot of heating and air moving system is needed. Hot and drying air with temperature above 40°C must be supplied to the treated space for 2-3 days. By using such method, there is still some doubt as to the possibility of damage to building contents. Therefore, it is important not to over-dry; this wastes energy and time and increases the risk of damage to building components. Therefore, monitoring the drying process is necessary for two main reasons: enables better control of the environment and allows the perfect drying chamber to be maintained more easily. Monitoring is also used to signal the end of the drying process and consequently, save energy and time and saving building components.

Heat-based method can be applied in two different forms:

- Conventional heating method, by supply the hot and dry air to the whole indoor space. The main advantage of this method is that it is easy to install. However, in such method lot of energy and takes longer time when compared to the modified heating method.
- Modified heating method. By installing a plastic sheet close to the treated wall and then supply the drying air (or sucking the air) directly to (from) the space between the wet wall and the plastic sheet, see Figure 4. This method is fast and less energy consumed.

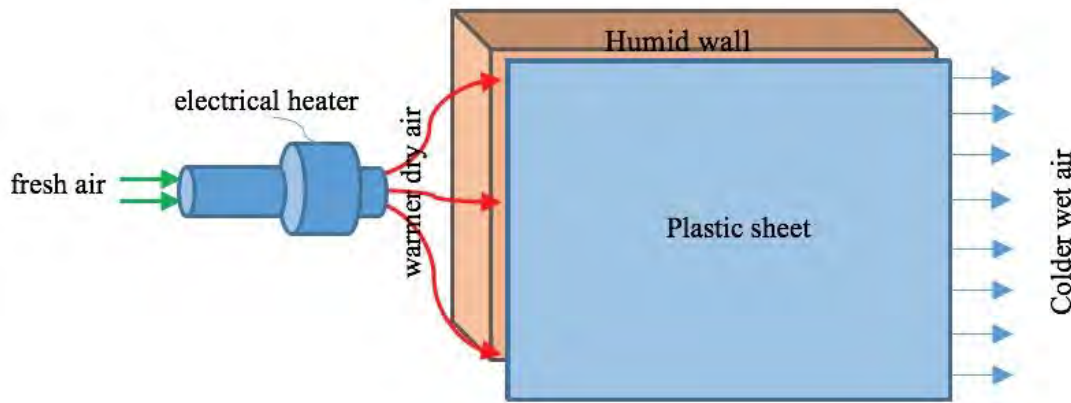

Figure 4: Modified heating method. The drying air pumped in the space between the wall and the plastic sheet

In the case where there is insulation into the wall, tiny holes can be drilled into the wall to be used to inject hot and dry air, see Figure 5



Figure 5: Drying wet wall with presence of insulation

4.2 Dehumidifier

Dehumidifier can be a useful machine to dry out the wall in a closed environment as they rely on creating an unnaturally low vapor pressure condition on the inside of the building than those on the outside so the moisture on the outside of the structure can move into the building. In another word, without a proper building envelope structure, using dehumidifier to dry out the walls engorges moisture moves through the envelope much faster.

The speed of drying is largely dependent on the capacity of the equipment relative to the space to be dried.

- Longer time is need when compared to heat-based method
- Dehumidifier should only be used, if the envelope structure is good. Otherwise, moisture might move through the envelope much faster.

4.3 Chemical base method

In chemical base method, a hygroscopic substance is needed as a drying agent to attract and hold water molecules from the surrounding indoor environment. For this purpose, various draying agents can be used include:

- Sodium hydroxide
- Silica gel
- Calcium chloride.

The drying agent can be placed in the treated space for some days. The drying agent will absorb the humidity from the space and, consequently, the moisture from the wall will be released into the space. Alternatively, the drying agent can be applied directly to the wet wall by means of installing assistant plastic or wooden plate that is few centimeters far from the treated wall. Then, the drying agent is used to fill the space between the wet wall and the assistant wall. Compared to other methods, chemical-based method does not require energy and drying time is much longer.

5. PREVENT HUMID WALLS PROBLEM OVER AGAIN

In order to prevent the mustier wall problem occurs again, there are some procedures must be taken. The nature of the procedures depends on the source of the humid as flowing:

5.3 Externally source of the humidity

In the case where the humidity source is externally, the wall needs to be treated carefully as follow. Plug holes and cracks in the foundation. Although, holes and cracks in the external envelope let moisture and water leak into the building, patching them perhaps not solve leakage problem. However, plugging the cracks can help to minimize the problem size. Since hydraulic cement can be used under water and swells, such cement works perfectly to seal the hole and lock the plug. It should be noticed that **the hole or crack must be enlarge into an inverted "V" with the narrow part of the "V" on the surface of the wall this trick assures that the cement will not be pushed out due to its expansion.**

In addition, use waterproofing paint which fills the pores in the concrete or masonry walls seems to be a good method to prevent water from leaking in. to make this method is more effective, the coatings need be applied to bare walls and adding a second coat after the first dries. This guarantees to fill every pinhole and create a continuous waterproofing membrane.

5.4 Internally source of the humidity

If the source of the humid is internally, the wall needs to be insulated carefully. This way will prevent the temperature of the walls to be as low as condensation temperature of the humidity, or what so-called dew point. As mentioned above, dew point depends on the relative humidity and the dry bulb temperature of the air, as shown in Figure 3. The higher relative humidity, the higher dew point will be and, consequently, the possibility of condensing the humidity on the walls will increase. Therefore, ventilation control becomes even more important to removing excess moisture in the air, moisture that is attributed to building materials, people sweating, showering, cooking foods, etc.

It is worth mentioning that the moisture is moving through the envelope structure into the building in summer, while leaving the buildings in the winter. Accordingly, using vapor barriers is a critical issue because it might really create quite significant and problematic conditions depending on where the vapor barrier is placed. In cold climate, where moisture condenses on the inside cold wall during winter months, the vapor barrier must be located on the interior (the warm side of the wall).

6. CONCLUSIONS

Increasing the moisture content of the buildings envelope has significant impact of the energy performance of the building, the on the health and the comfort level of the occupants, and the stability of the building envelope. Current work discusses the sources and the solutions of increasing wall moisture content. In order to get rid of increasing wall moisture content permanently, it is highly recommended to detect the source of the problem. It was shown that there are three main reason to increase moisture content of the buildings envelope:

- Internal reason due to increasing the indoor humidity,
- External reason due to exterior walls exposure to harsh-climate conditions.

A comparison between three drying methods (including heat-based, dehumidifier and chemical-based) was presented. As listed in Table 1, if speed of drying is the overriding consideration then the heat-based with powerful seems to be the proper method. However, there is still some doubt as to the possibility of damage to building contents. On the other side, chemical-based method seems to be the cheapest option, but it requires a long time.

Method	Drying time	Energy requirements
Modified heat-based	short	Low
Conventional heat-based	Relatively short	Relatively low
Dehumidifier	Relatively long	High
Chemical-based	long	No energy

Table 1: Comparison between drying methods

After solving the problem, namely dry out the wall, there are several steps can be taken to prevent humid wall problem such as using thermal insulation on the external wall of low thermal resistance or patching cracks and holes in the walls. The selection of the steps depends on the source of the problem.

Future work will concentrate on a practical case and the implications of different drying methods.

REFERENCES

- [1] Barrett, D. , 1998. The renewal of trust in residential construction.
- [2] Bornehag, C., Sundell, J., Bonini, S., Custovic, A., Malmberg, P., Skerfving, S., Sigsgaard, T. & Verhoeff, A., 2004. Dampness in buildings as a risk factor for health effects, EUROEXPO: a multidisciplinary review of the literature (1998–2000) on dampness and mite exposure in buildings and health effects. *Indoor Air*, 14(4), 243-257.
- [3] Burke, S. , 2009. Building Physics Tools: Needs, Use and the Lack of Use in the Building Process. Modelling Non-Isothermal Moisture Flow and Frost Penetration.
- [4] Calbureanu, M.X., Albota, E., Tutunea, D., Dumitru, S., Malciu, R. & Alexandru, D., 2010. Contributions above the dew-point problem in civil building EPS insulated walls modeling with finite element the convective heat transfer. *Int.J.Mech.*, 4(3), 53-62.
- [5] Damp proofing, waterproofing and timber treatments for restoration and renovation, [online]. Retrieved from <http://www.restorationuk.com> [Retrieved on 28 April 2016].
- [6] Hens, H., Janssens, A., Depraetere, W., Carmeliet, J. & Lecompte, J., 2007. Brick cavity walls: A performance analysis based on measurements and simulations. *J.Build.Phys.*, 31(2), 95-124.
- [7] Karagiozis, A. & Salonvaara, M., 2001. Hygrothermal system-performance of a whole building. *Build. Environ.*, 36(6), 779-787.
- [8] Kidd, B., Tagg, A., Escarameia, M., von Christerson, B., Lamond, J. & Proverbs, D. , 2010. Guidance and standards for drying flood damaged buildings, UK, London.
- [9] Newman, A.J., Whiteside, D. & Kloss, P.B., 1982a. Full-scale water penetration tests on twelve cavity fills- Part II. Three built-in fills. *Build. Environ.*, 17(3), 193-207.
- [10] Newman, A.J., Whiteside, D., Kloss, P.B. & Willis, W., 1982b. Full-scale water penetration tests on twelve cavity fills-Part I. Nine retrofit fills. *Build. Environ.*, 17(3), 175-191.
- [11] Tariku, F., Kumaran, K. & Fazio, P., 2010. Integrated analysis of whole building heat, air and moisture transfer. *Int.J.Heat Mass Transfer*, 53(15–16), 3111-3120.
- [12] Tinker, J.A., Cabrera, J.G. & Ganjian, E., 1992. Thermal conductivity of concrete: Effect of moisture. *Build.Serv.Eng.Res.Technol.*, 13(1), 31-36.
- [13] Van Belleghem, M., Steeman, M., Janssens, A. & De Paepe, M., 2015. Heat, air and moisture transport modelling in ventilated cavity walls. *J.Build.Phys.*, 38(4), 317-349.
- [14] Veas, L. , 2006. Development and application of a methodological model that allows evaluate and compare the behaviour of external walls exposed to moisture phenomenons. Thesis (PhD). Université catholique de Louvain.
- [15] Vos, B.H. & Tammes, E., 1978. 'Rain penetration through the outer walls on cavity-structures', paper presented at Helsinki, Finland, 28 August-2 September.

Improving the Market Up-take of Energy Producing Solar Shading: Experiences from Three Cases of Retrofit

Paula FEMENIAS^a, Liane THUVANDER^b, Peter KOVÁCS^c

^a Chalmers University of Technology, Sweden, femenias@chalmers.se

^b Chalmers University of Technology, Sweden, liane.thuvander@chalmers.se

^c Research Institutes of Sweden, Sweden, peter.kovacs@rise.se

ABSTRACT

The paper presents the test of a multi-value framework for the evaluation of energy producing solar shading on three cases of Swedish retrofitting projects. The evaluation framework was developed in collaboration between academics and industry partners in a transdisciplinary research project and considers: energy production, indoor environment and comfort, visibility and communication, aesthetics, design and process, and maintenance and repair. Results show that the model even though having few criteria gives a general and comprehensive feed-back about the outcomes, challenges and success of the projects. None of the projects scores high in all aspects, instead they exemplify different approaches to energy producing solar shading. All three have shading and low maintenance as important criteria for design. Furthermore, the availability of subsidies to add solar energy production to the shading has been decisive for choosing that solution. Case 1 has had energy production as an important driver and no architect was involved while in Case 3, being a listed building, aesthetics has been crucial. Case 2 shows a way forward with a good collaboration between the actors and a compromise between shading, energy production and aesthetics which respect the original design.

Keywords: building integrated solar energy, shading, retrofit

1. INTRODUCTION

With respect to global warming (Frank, 2005) and heat-islands in larger and denser cities (Santamouris et al., 2001), cooling is set to be a crucial element in building design in order to reach comfort levels. Modern architectural ideals with glass facades have also been identified as the origin of over-heating in buildings (Nässén & Holmberg, 2005). Solving the problem with energy consuming cooling systems goes against goals for increased energy efficiency and the growing importance of sustainability certifications. Solar shading proposes a solution for over-heating while a trade-off between reduced energy demand for cooling and increased need for artificial light has to be dealt with (Nielsen, Svendsen, & Jensen, 2011).

Energy producing solar shading proposes an attractive combined solution offering solar shading at the same time as renewable energy is locally produced. Although costs for solar cells has decreased such solutions are still uncommon sights. Challenges for the multi-functional system include a balance between energy reduction and indoor comfort regarding daylight and glare along with practical issues of maintenance, repair and wind-loads (Roberts & Guariento, 2009), especially for dynamic systems which are the most efficient in terms of balance between shading and daylight (Nielsen et al., 2011). Another crucial barrier for the wider implementation is traced back to the influence of architects and the possibility for a successful aesthetic architectural integration of solar energy in the overall building design (Munari Probst et al., 2013).

This paper presents on-going research on energy producing solar shading in Sweden. The ELSA (Elgenererande solavskärmning) project is carried out in a transdisciplinary setting involving three academic institutions representing architecture, daylight studies and technical expertise in collaborating with the industry representing architect firms, solar energy suppliers, solar shading suppliers, building contractors and lobby organisations for solar energy and shading. A process of gathering feed-back from ten cases of new building and retrofit applying energy producing solar shading was initiated in 2016. This paper focuses on three cases of retrofit which represent an important part of the building stock. The aim for the paper is twofold: 1) To test an analytic multi-value framework developed to evaluate the installation of energy producing solar shading from different value and stakeholder perspectives, and 2) To discuss general experiences from these case studies.

1.1 Method and material

The chosen cases of retrofit represent different types of solutions with respect to shading system and architectural integration. All cases are Swedish non-domestic buildings. In each case a number of key actors are interviewed: construction clients, architects, technical consultants, contractors, installers, operation managers, and end-users. Furthermore, representatives from the local public are interviewed as stakeholders to the visual effects of the systems on the urban environment.

The feed-back study gathers process information from the early design phase to the building in use. Technical information, energy performance and experiences from the system in operation and use are also collected. Opinions on the architectural integration of the system has been identified as one main question to be addressed as well as the visibility and marketing values. Data collection, still ongoing, is based on structured interviews carried out face-to-face or by telephone. Table 1 shows the actors that has been interviewed so far. Results are to be used as basis for discussing different aspects of energy producing solar shading within the trans-disciplinary research arena.

Case		Actors that has been interviewed
City	Type of building	
1. Alvesta	Town Hall	Client (the energy manager); the solar system supplier; 3 users
2. Sollefteå	Hospital	Client (the energy manager); architect; solar system supplier
3. Stockholm	University, entrance hall	Client; architect; maintenance & operation; users/public

Table 1: Interview respondents and type of interview in the three case studies.

2. EVALUATION FRAMEWORK

An evaluation framework was designed based on workshops and discussions in the transdisciplinary research team. The aim is to reflect a manageable number of influential factors that an energy producing solar shading should be evaluated upon and still get a comprehensive idea of its function and value (Table 2). Economy and costs are considered but not explicitly included in the framework instead implicitly evaluated in terms of energy production, user satisfaction, and in branding and marketing. The framework was used to analyse data from the case studied. Three researchers were involved in the analysis and adjustments were made to align different perspectives.

	Grade 0	Grade 1	Grade 2	Grade 3
Energy production	Insignificant production of energy	Covers only a limited part of the building energy needs	Produces energy according to expectations but does not cover building needs	Produces energy according to expectations and covers building needs
Indoor environment	No improvement; significant heat over load and glare problems	Small improvements of over-heating and glare	Improved conditions for over-heating and glare	Large improvements, no over-heating or glare problems
Visibility & communication	No feed-back to users; no communication for the public	Information panel indicating the energy production inside or outside building	Visible information panel and regular feed-back and info online or in newsletter	Visible information panel, web information etc. and knowledge diffusion through partnerships
Aesthetics	Not appreciated among any respondent	A majority (>50%) does not find the plant attractive	A majority (>50%) find the plant attractive	All respondents find the plant to be attractive
Design & process	All parties found project difficult or almost impossible to carry out.	At least 50% found the project more problematic and costly than expected.	At least 50% found the project smooth and efficient.	All parties found the process smooth and efficient.
Maintenance & repair	In need of recurrent maintenance and repair.	Seldom in need of maintenance or repair.	No need for maintenance and only occasional repair.	No need of either maintenance or repair.

Table 2: Evaluation framework.

3. CASE STUDIES

3.1 Case 1: Alvesta Town Hall

An office building from the 1960s had previously been renovated and fitted with a cooling system, but problems with over-heating persisted. **In 2015, highly efficient solar cells mounted as on a ‘baseball cap’ shading were fitted** on the eastern and southern facades to limit over-heating and energy use (Figure 1). The municipal agency who owns and manages the building had no previous experience of solar cells. Their energy manager was the initiator and promoter for the system. No architect was involved. National subsidies covering 35% of the total costs of **170.000 € was decisive for choosing solar cells. The system produces 65 MWh/year which covers** the electricity need for the building on sunny days and delivers a surplus (~6MWh/year) especially in the week-ends which is sold **making savings of 25.000 € per year. Although the building now has higher tax rate for being an energy producer** the total economic gain is positive.

The client wanted a system free from maintenance. The ‘baseball caps’ are 2 meters wide and the installation was difficult to attach to the façade. Today the system supplier only does ‘caps’ that are 1 meter wide. The client thanks the experienced entrepreneur for the success of the installation.

The system has received a lot of attention locally and the solar cells on the roof can be accessed for study visits. The client says that politicians and public servants are happy with the indoor climate and the aesthetics. The solar system supplier is also happy with the results but says that his architect friends do not like the looks. Both the client and the supplier agree that the system is best seen from a distance and that the shading defines the building as a landmark on an urban scale.

Three interviewed users all have different views on the comfort and aesthetics. The system seems to be less efficient on the top floors. Furthermore, the users seem little informed about the function and the value of the system. None of the users are in favour of the aesthetics and details are found clumsy. However, they think that **the building wasn't that attractive before as it had undergone several renovations. As one user states: “The building is now more blackish and the façade disappears. The building possesses no higher architectural value but it is still the Town Hall and a large visible building.”** A summary of the evaluation is found in Table 3.



Figure 1: Alvesta Town Hall before and after addition of solar shading.

Value area	Grade	Comment
Energy production	3	Produces energy according to expectations. Surplus energy is sold.
Indoor environment	2	Three users give varying testimony from good to bad.
Visibility & Communication	3	Information panel in the entrance hall. The building receives study visits. The owners engage in knowledge transfer to other municipalities.
Aesthetics	2	3 out of 5 respondents do not find the system attractive or does not have any opinion about the aesthetics.
Design & Process	1	The design process was costly due to extensive calculations for the façade attachments.
Maintenance & repair	3	No need for maintenance or repair so far.

Table 3: Evaluation of case 1, Alvesta Town Hall

3.2 Case 2: Sollefteå Hospital

This hospital building from the 1960s had problems with over-heating and was retrofitted with energy producing solar shading in 2010. The decision to add energy production to the shading was supported by an enthusiastic client and guided by local policy to invest in renewables. The possibilities to get national subsidies was highly supportive for the investment in solar energy.

The architect was satisfied with the collaboration regarding the architectural integration although the other parties were not that interested in the aesthetics. The architect is satisfied with the results which he thinks is not that **dominant on the façade. However, he claims that the system “does not add any aesthetic values to the building.”** A ‘cap’ like shading as in Case 1 was discussed and dismissed due to aesthetics. The client and the solar supplier are also satisfied with the aesthetics.

Important criteria for the design were shading, cost efficiency and low maintenance. With respect to his experience, the architect calls for more standardised products. In this project the shading lamellas had to be adapted to fit the size of the solar cells (12 cm). The client finds it remarkable that solar cells are not found in the dimensions of the shading as this kind of shading is very common. Due to the different dimension, the assemblage had to be done in two steps first the shading was fitted to the façade then the solar cells. This increased the costs and complication of the project. A summary of the evaluation is found in Table 4.



Figure 2: Sollefteå hospital with the energy producing solar shading.

Value area	Grade	Comment
Energy production	2	Production according to plans but does not cover more than a small part of the building's energy need.
Indoor environment	3	The shading give an improved indoor environment.
Visibility & Communication	3	Information panel at entrance. Information about collaboration on sustainability with the region. Seminars were given at the inauguration. A web-portal provides further information.
Aesthetics	3	All respondents are very satisfied with the aesthetics and the building integration.
Design & Process	2	The solar energy supplier is unhappy about the costly and time consuming installation.
Maintenance & repair	2	No maintenance but some smaller repair. Difficult to find replacement parts as these were specially produced.

Table 4: Evaluation of case 2, Sollefteå sjukhus

3.3 Case 3: Passage at the Royal Institute of Technology

The object is a passage between two building blocks originally built in 1948 and reconstructed as an entrance hall to a lecture hall in 2006 (Figure 3). The passage is designed by Swedish architect Nils Ahrbom and listed. During the reconstruction, the passage which only had high sitting windows were opened up with bay windows and an entrance. The client understood that over-heating would be a problem and searched for a solution. The university and the building manager did not want any exterior shading due to maintenance and risk for fall injuries would somebody climb the system. Instead, a system with glass integrated solar cells were installed in the upper part of the bay windows. The plant was financed to 70% with national subsidies which was crucial for the decision to use this solution. The situation of the passage which is lower than the surrounding buildings limits the insolation of the system and the payback time is consequently very long.

The passage is still over-heated but this is not a problem as it is only a passage. The client considers the installation more of an aesthetic solution for shading than energy producing. All involved actors as well as users and by-passers appreciate the aesthetics. Some users never thought about it as a solar system but when informed they think it goes well together with the profile of the technical University. The system provides shadow on the inside and a pleasant light pattern. The architect had close contact with the City Museum and the son of the late architect during the whole design. A summary of the evaluation is found in Table 5.



Figure 3: Royal Institute of Technology, entrance to lecture halls from inside and outside.

Value area	Grade	Comment
Energy production	1	The plant produces very little energy. There were no high expectations for energy production when installed.
Indoor environment	2	The installation provides some shading and does protect against glare. The passage is warm on sunny days but as it is only a hall way there are no complaints.
Visibility & Communication	1	An information panel besides the entrance door indicate the production of electricity but without reference to the relevance of the production with respect to energy use.
Aesthetics	3	All respondents and the public found the installation very attractive and well integrated in the building.
Design & Process	3	The process worked very well according to all parties.
Maintenance & repair	3	There has been no use for maintenance or repair so far.

Table 5: Evaluation of the Royal Institute of Technology case

4. DISCUSSION

The multi-value framework shows a means to quickly get a comprehensive vision of experiences with energy producing solar shading. Only a few interviews have been made, still and overall picture of the project is achieved. The limited number of evaluation criteria in our model makes it easy to apply and visualise (Figure 4). Return of experience through case studies will always be a trade-off between depths of the study and the number of cases that are possible to include in the study. The weaknesses in our evaluation are the few interviews with end-users and possibly also with representatives from the local public. A full survey among all end-users would need much more resources and the active participation of the project owners. Regarding technical information and experience among professional actors, no more interviews would be needed, and the information should be correct.

On a general discussion on experiences from energy producing solar shading a few statements can be made. Reduction of over-heating has been the main driver for installing the systems. Low maintenance and repair has been important criteria for finding a solution. Only Case 1 put energy production as a top goal. The possibility to receive financial support for solar cells has been crucial in all cases. Aesthetics have to a varying degree been of importance even though discussed in each project.

None of the projects scores high on all aspects of the evaluation framework (Figure 4). Case 1 has been successful for energy production but scores badly in aesthetics. No architect was involved and the energy production has been achieved on behalf on both respect for the building, the urban landscape. The user respondents do not give a unified view of the indoor environment. This could reflect the common view but more interviews could be carried out to get a better picture.

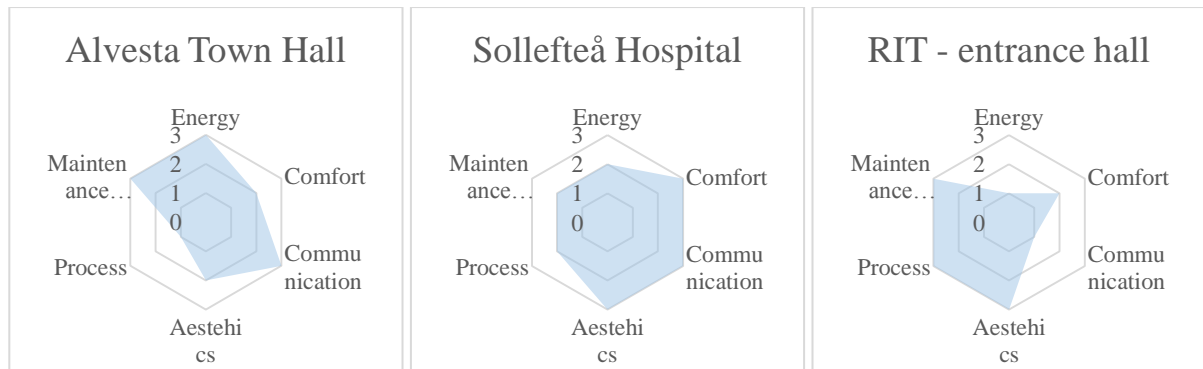

Figure 4: Visualisation of the evaluation of the three cases of retrofit.

Case 3, being a listed object the case has had aesthetics as a primary goal, the client even refers to the system as an “artistic installation”. The image value could be discussed in this case as the low efficiency could give a negative impression of this kind of solar systems. Case 2 gives the most balanced outcome. Comfort is reported good and the system works in terms of architectural integration with the existing building. Compared to Case 1, in Case 2 there was an architect involved which has improved the aesthetics while still scoring high on energy production and comfort. With reference to earlier work that point out the architect as an important actor for a market-up take of building integrated solar systems (Kanters, 2011), Case 2, where there was a good collaboration between architect, solar supplier and client, shows a way forward. In Case 1, no architect was part of the project group, but in many projects this would not be permitted. The solar system is definitely a very dominating part of the building and its aesthetics can be discussed. In Case 3, the system is very well integrated and an appreciated part of the building. The energy production is limited but this could be due to the local situation.

None of the cases have had need for maintenance and only Case 2 has been in need of repair. However, especially Case 1 is newly installed and time will show how successful it will be regarding maintenance. Time will also show which of these solutions that will have follow-ups. Case 2 shows the importance of standardisation in order for solar systems to be successfully integrated with other building elements.

5. CONCLUSION

The paper shows that it is a challenge to find a balance between the different criteria which are of importance for achieving an energy producing solar shading system that is efficient in terms of shading and comfort; easy to apply to an existing building and operate and maintain; that produces enough energy to make the investment justifiable; and which can be integrated without compromising the original architecture. None of the studied system would have been installed had in not been for subsidies.

The many and varying aspects for energy producing solar shading calls for an interdisciplinary collaboration, where all aspects need to be discussed and considered. The tested multi-value framework is a means to quickly get a comprehensive vision of experiences which can be a basis for discussions in an inter- and trans-disciplinary team. The value of the results from the return of experience study will be subject for up-coming studies.

ACKNOWLEDGEMENT

We wish to thank all respondents for sharing their experiences and project assistant Frida Bard for help with data collection. The ELSA project is co-financed through the Swedish Energy Agency and the IQ Build Environment joint programme E2B2 with support from the projects’ industry partners.

REFERENCES

- [1] Frank, T. (2005). Climate change impacts on building heating and cooling energy demand in Switzerland. *Energy and Buildings*, 37(11), 1175-1185.
- [2] Kanters, J. (2011). Adequacy of current design tools and methods for solar architecture—results of IEA-SHC **Task 41's international survey**. Paper presented at the Proceedings of PLEA.
- [3] Munari Probst, M. C., Roecker, C., Frontini, F., Scognamiglio, A., Farkas, K., Maturi, L., & Zanetti, I. (2013). Solar Energy Systems in Architecture-integration criteria and guidelines. Retrieved from
- [4] Nässén, J., & Holmberg, J. (2005). Energy efficiency—a forgotten goal in the Swedish building sector? *Energy Policy*, 33(8), 1037-1051. doi: <http://dx.doi.org/10.1016/j.enpol.2003.11.004>
- [5] Nielsen, M. V., Svendsen, S., & Jensen, L. B. (2011). Quantifying the potential of automated dynamic solar shading in office buildings through integrated simulations of energy and daylight. *Solar Energy*, 85(5), 757-768. doi: <http://dx.doi.org/10.1016/j.solener.2011.01.010>
- [6] Roberts, S., & Guariento, N. (2009). *Building integrated photovoltaics: a handbook*. Basel:Boston: Birkhäuser.
- [7] Santamouris, M., Papanikolaou, N., Livada, I., Koronakis, I., Georgakis, C., Argiriou, A., & Assimakopoulos, D. (2001). On the impact of urban climate on the energy consumption of buildings. *Solar Energy*, 70(3), 201-216.

Towards a Holistic Approach to Retrofitting: A Critical Review of State-of-the-art Evaluation Methodologies for Architectural Transformation

Stina Rask JENSEN^a, Aliakbar KAMARI^b, Anders STRANGE^c, Poul Henning KIRKEGAARD^d

^aAarhus University, Denmark, srj@eng.au.dk

^bAarhus University, Denmark; University of Palermo, Italy, ak@eng.au.dk

^cAART Architects, Denmark, ast@aart.dk

^dAarhus University, Denmark, phk@eng.au.dk

ABSTRACT

The building sector is well known to be responsible for a considerable part of the total European energy consumption. In the endeavor to implement radical reductions, there is an identified potential in addressing the existing building stock through deep renovations. These renovations make up complex, highly interdisciplinary systems. They involve stakeholders across a broad spectrum of disciplines and potentially affect the lives of a large number of occupants. The involved people bring different understandings of value in sustainability into a project and judge the outcome according to this understanding.

As a response to this, a number of sustainable assessment methodologies for the building industry, and specifically for that of retrofitting, have been developed to assist in the decision-making processes and ensure targeted results. However, these methodologies themselves represent a stance on sustainability as they assign weight to different sustainability indicators. As such, the same design may be assessed differently according to the chosen tool. As part of the research project RE-VALUE, this paper presents an evaluation of current practices in a Danish context through a systematic literature review of existing assessment tools. The paper presents the results of a meta-synthesis, which highlights the focus areas of the individual tool as well as patterns and relationships between the tools. **Based on the review we discuss a noticeable focus on quantitative, technical values in today's 'assessment practice' and put forward the hypothesis that there is a need to rank qualitative, 'non-technical' values alongside quantitative values in order to deliver significantly improved building performance, which benefits the people who inhabit the built environment.** This hypothesis is substantiated through an additional literature review, from which we propose a need to develop a holistic methodology for assessing architectural transformations in deep renovations.

Keywords: sustainable retrofitting, deep building renovation, architectural transformation

1. INTRODUCTION

The building sector is responsible for 40% of the total European energy consumption. In the endeavor to reduce this number, deep renovation of existing buildings has been identified as an important focus area (European Commission, 2014). Such renovation processes make up complex, highly interdisciplinary systems, which involve stakeholders across a broad spectrum of disciplines and potentially affect the everyday lives of a large number of people (Beim & Madsen, 2015). Subsequently, a deep renovation is not **'merely' about optimizing the technical performance of a building**, but prescribes a holistic approach, in which measures are considered for their interdependence rather than as separate elements in a traditional reductionist line of thought. A number of sustainable assessment methodologies have been developed to assist the decision-making processes and ensure targeted results. Many of these claim to have a holistic approach. However, it is the hypothesis of this paper that the models themselves represent **a stance on sustainability as they assign weight to different 'sustainability indicators'**. As such, the same design may be assessed differently according to the chosen tool (Tagliabue, 2016). The research project RE-VALUE has been initiated to shed light on available methodologies and the potential to further develop them into a model targeted retrofitting initiatives in Denmark (Kamari et al., 2016). As part of the research project, this paper presents the results of a literature review of existing assessment methodologies. The aim is to compare which sustainability indicators each methodology attach importance to, and to provide a synthesis of the findings, which can improve our understanding of the positioning of each methodology relative to each other.

The transformation towards a more energy-efficient building mass often involves radical changes to the built environment. Depending on the extent of the initiatives, these changes may affect the wellbeing of the people who inhabit the spaces (Acre & Wyckmans, 2015, Beim & Madsen, 2015, Hvejsel et al., 2015). As part of the literature

review, the paper examines to what extent each of the included methodologies address the implications of technical interventions on the perceived spatial quality.

The following section provides an overview of the methodological outset for the study. Section 3 includes a mapping of existing assessment methodologies, which forms the basis for a synthesis and discussion in section 4.

2. METHODOLOGY

The evaluation of existing sustainability assessment methodologies is performed as a systematic literature review of 7 selected methodologies. The overall aim of the review in section 3 is to identify to which sustainability indicators each methodology assigns weight. The methodologies have been included in this paper for their relevance to retrofitting in a Danish context. They do not necessarily target retrofitting initiatives, but encompass such projects **as part of their scheme. In order to provide a set of 'lenses' through which to map** the sustainability indicators in a similar way, the paper leans on the three pillars of sustainability, emanating from the 1987 Brundtland Report: social, environmental and financial sustainability (World Commission on Environment and Development, 1987), adding a fourth parameter addressing process-oriented indicators. The findings of the mapping are communicated **through diagrams, which depict the indicators relative to these 'lenses' and a timeline which indicates where in the renovation project the given methodology can be applied. Parallel to this study, the paper 'zooms in' on the social pillar and examines to what extent each methodology addresses the implications of technical interventions on socio-cultural aspects, focusing in particular on the perceived spatial quality. The concept of 'spatial quality' is highly complex in character and has been addressed by several scholars and practitioners through the years. In this paper we focus on the spatial quality in the understanding that architecture is a phenomenon which influences our sense of wellbeing and behavioral patterns (Bek & Oxvig, 1997). It lies beyond the scope of this relatively short paper to unfold the concept of spatial quality. Rather, it is the aim to identify if the included methodologies consider spatial quality indicators. Section 4 presents a meta-synthesis of the individual findings, with the objective to position the assessment methodologies relative to each other and identify potential knowledge gaps, with special attention to spatial quality.**

3. MAPPING OF EXISTING ASSESMENT TOOLS

3.1 DGNB-DK

The DGNB-DK tool is a Danish version of the DGNB tool, developed by Green Building Council Denmark in 2012. The purpose is to secure quantifiable standards, which makes it possible to certify buildings **based on a "scoring system". The methodology is not targeted renovations, but has been applied to such projects (DK-GBC, 2016).** The model has a relatively even distribution of social, economic, environmental and process-related sustainability indicators. **It addresses the concept of spatial quality in the subsection devoted to "social quality", e.g. attention to daylight factor, plan layout and to 'aesthetics' through evaluation of whether the project has been put out to tender in an architectural competition and through attention to building integrated art (Beim & Madsen, 2015) (Figure 1).**



Figure 24: Top: indicators relative to process and social, environmental and economic sustainability. bottom: timeline.

3.2 AktivHus (Active house)

AktivHus is a national initiative from 2015, based on the international ActiveHouse principles (AktivhusDanmark, 2015). The methodology is intended as a design strategy and certification tool. The methodology targets new buildings as well as retrofitting projects (ibid, 2016). There is a visible focus on environmental indicators. Social aspects of sustainability are here reduced to attention to indoor climate. The methodology does not consider economic aspects. Beim et al. points out that the methodology does not consider cultural aspects - in this paper addressed under social sustainability - or more process-related aspects of a retrofitting initiative (Beim & Madsen, 2015) (Figure 2).

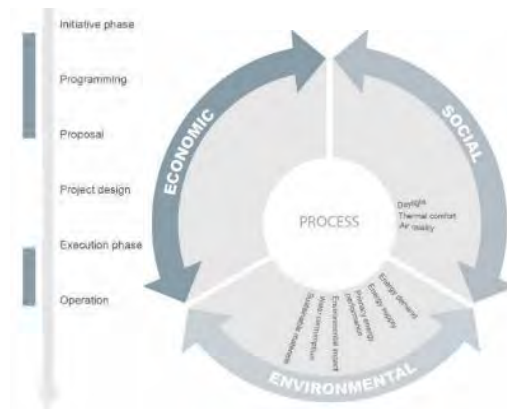

Figure 25: Top: indicators relative to process and social, environmental and economic sustainability. bottom: timeline.

If evaluating the methodology in terms of attention to spatial quality, this is 'only' addressed as a matter of quantifiable indicators related to indoor climate.

3.3 SAVE

SAVE was developed in Denmark in the late 1980's and is now administered by Kulturstyrelsen (The Danish Agency for Culture) (Beim & Madsen, 2015) (Kulturarvsstyrelsen, 2011). From 1992-2007 it served as the basis for development of 90 "Municipality-atlasses" in Denmark. The purpose of the methodology is to assess the level of preservation value in buildings or urban environments. (Kulturarvsstyrelsen, 2011). The methodology has a clear focus on culture-historical aspects. It includes weighting of economic aspects, but only a limited focus on the environmental value (Beim & Madsen, 2015) (Kulturarvsstyrelsen, 2011). The evaluation only focuses on the existing building, and is not considering potential renovation initiatives, including the potential implications on the perceived spatial quality (Figure 3).



Figure 26: Top: indicators relative to process and social, environmental and economic sustainability. bottom: timeline.

3.4 Evaluering af kvalitet i boligbyggerier (evaluation of quality in housing)

The methodology was developed by the Danish Building Research Institute (SBI) in 2000 for the Ministry of Housing and Urban Affairs. The methodology focuses on residential buildings and aims to provide a holistic tool for evaluating the condition and quality of the building across disciplines, focusing on both qualitative and quantitative indicators (SBI, 2000) and (Beim & Madsen, 2015). Each of the 6 themes are evaluated in relation to

4 different scales in the building and by means of different methodologies, which are described as part of the concept. The methodology has a relatively even distribution of indicators across the three pillars. There is well-articulated attention to the more qualitative aspects related to 'spatial quality', however, focuses on the existing building rather than new initiatives (SBI, 2000) (Figure 4).

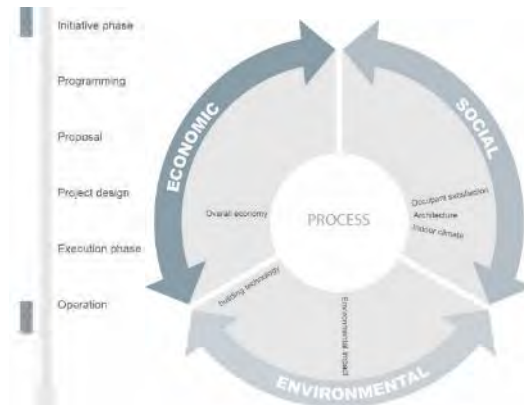

Figure 27: Top: indicators relative to process and social, environmental and economic sustainability. bottom: timeline.

3.5 Totalværdi-modellen (total value model)

The model was developed in 2012 by a partnership of local authorities and consultancy companies (Plan C). The model focuses on process management in the initial stage of an interdisciplinary renovation project, rather than the comparison of specific design solutions. As such, the model does not contain an absolute weighting system. Rather, it provides a digital framework with templates. In the model there is a relatively even focus on each of the **three sustainability “pillars”, which potentially helps to point out and articulate indicators as a sort of “check list”** including both quantitative and qualitative considerations. However, it is up to the stakeholders to set up objectives **for assessment of design solutions in later phases. The term “architectural quality” is introduced, but not further elaborated** (Schunck et al., 2011). Beim and Madsen point out that the model has a limited focus on cultural aspects, such as building culture and aesthetic qualities (Beim & Madsen, 2015) (Figure 5).



Figure 28: Top: indicators relative to process and social, environmental and economic sustainability. bottom: timeline.

3.6 RENO-EVALUE

RENO-EVALUE is developed by Centre for facility management (CMF) (Jensen & Maslesa, 2015). It provides a tool for clarifying sustainability objectives in a renovation process, comparing alternative project proposals and for evaluating the level of sustainability after completion (Jensen & Maslesa, 2015). The main purpose is to provide **a process tool, which can identify each stakeholder's priorities and help establish common criteria for success** in the early phases of large-scale renovation projects (Jensen & Maslesa, 2013). The weighting is based on the **stakeholders' subjective evaluation. As with the Total Value Model, the model focuses on process-related issues** in an interdisciplinary project. The implications on the perceived spatial quality is assessed under the subsection **“product” through attention to e.g. indoor climate and comfort. However, the qualitative aspects of “Architecture and aesthetics” are not further elaborated.** (Figure 6).



Figure 29: Top: indicators relative to process and social, environmental and economic sustainability. bottom: timeline.

3.7 Arkitektur, energi, renovering (architecture, energy, renovation)

The concept was developed in 2013 by SBI in collaboration with Henning Larsen Architects. The aim was to create a design guide for architects and engineers, for the early design phase. The guide is based on the understanding that a holistic approach to renovation in terms of energy, daylight and indoor climate should also provide added functional, architectural and/or financial value. The guide is divided into three typologies: single-family houses, multi-storey dwellings and offices, and provides simple tools, suggestions for strategies and cases, which exemplify added value (Marsh et al, 2013). In general, there is an even distribution of indicators. When zooming in on the **architectural indicator, the recommendations appear to be less explicit, e.g. the strategy “improved spatiality”** (Marsh et al., 2013) and (Hvejsel et al., 2015). (Figure 7).

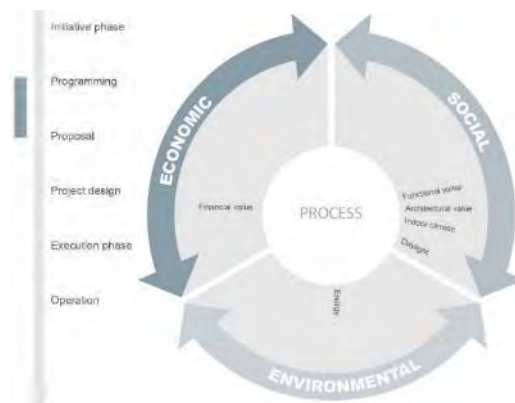

Figure 30: Top: indicators relative to process and social, environmental and economic sustainability. bottom: timeline.

4. FINDINGS AND DISCUSSION

In section 3, we have presented a review of 7 assessment methodologies. This section presents a synthesis and discussion of the findings in the review. The circle diagrams in each subsection of section 3 have served to illustrate that the methodologies address different sustainability indicators. For instance, AktivHus puts emphasis on environmental indicators and indoor climate, whereas the SAVE-methodology emphasizes culture-historical indicators. The RENO-EVALUATE methodology has a strong weighting of building process indicators, just to mention **a few differences. As such, the diagrams serve to indicate that ‘holism’ is a relative term. Despite the fact that many** of the methodologies are characterised as holistic by the developers (e.g. AktivHusDanmark, 2015 and Schunck et al., 2011), not all methodologies address *social*, *economic* and *environmental* sustainability as well as process-related aspects equally. This supports the initial hypothesis that the models themselves represent a stance on sustainability, which may affect the decision-making process and ultimately the outcome of the renovation project.

In Figure 8 the methodologies are positioned relative to each other. Along the “y-axis” we introduce a scale spanning from discipline specific tools with a delimited focus, e.g. preservation value or energy reduction, to holistic tools in the understanding that they consider *social*, *economic* and *environmental* and process-related aspects evenly. Along the “x-axis” we introduce a scale spanning from “design guide/process oriented” to “certification

system”, which serves to illustrate that the methodologies are targeted different stages of a renovation process. E.g., the TotalValueModel has a strong focus on project management in the initial phases of a renovation process, whereas DGNB serves as an elaborate certification tool, which can be viewed as less operable on the initial phases of a project.

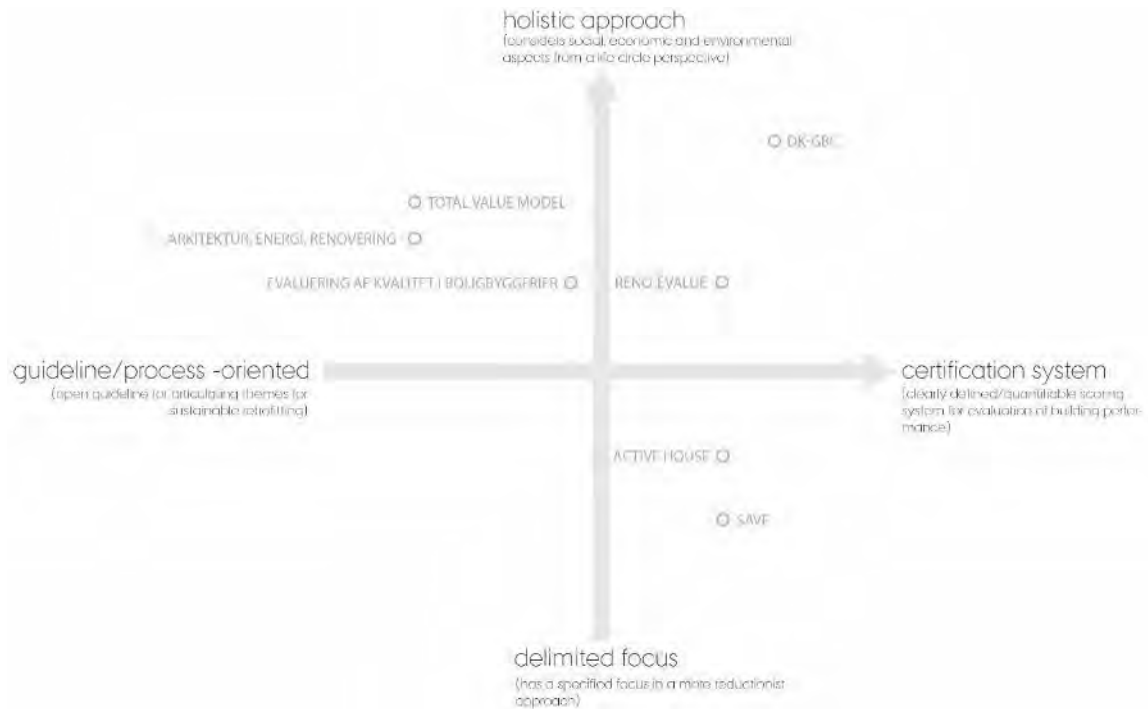

Figure 31: Graphical positioning of the studied methodologies for sustainable retrofitting.

If we ‘zoom in’ and address the methodologies with specific attention to the socio-cultural sustainability indicators, we see a general challenge in the methodologies when it comes to addressing the spatial consequences of technical initiatives in the early phases of a renovation process. It is well recognized that transformation towards a more energy-efficient building mass involves radical changes to the existing built environment, and thus potentially affects the perceived spatial quality amongst occupants (Acre & Wyckmans, 2015) (Beim & Madsen, 2015) (Hvejsel et al., 2015). A simplified example could be how an added mechanical ventilation system affects the height of a space, thus potentially affecting the perceived spatiality and access of daylight. Or how an added layer of exterior insulation may negatively affect the experienced coherence of a building to its neighbors from a culture-historical point of view. The other way around renovation processes may represent an opportunity to introduce new spatial qualities, e.g. improved access to private outdoor areas, which can help improve the receptiveness towards renovation amongst the residents of a building block. However, the ‘soft’ character of spatial quality is difficult to quantify, and, it seems, therefore more difficult to ‘operationalize’ as a part of the assessment methodologies on equal terms with e.g. indoor climate indicators. The methodology ‘Evaluation of quality in housing’ has a developed system for addressing spatial quality. However, the methodology has not gained currency – perhaps due to the complexity in use (Beim & Madsen, 2015). The methodology “Architecture, Energy, Renovation” on the other hand, is more readily accessible in the early stages of a project, but could be developed further to include more explicit strategies for addressing aspects related to spatial quality.

As such, the findings of this paper indicate a gap in the existing assessment practice. This indication is in line with the main findings of the report “*Værdiskabelse i bygningsrenovering*” (value creation in building renovation) by Centre for Industrialized Architecture in Copenhagen. In the report, Beim and Madsen stress the necessity of qualifying and describing the qualitative values about aesthetic, cultural and social values, in order for them to be addressed on equal terms with quantitative data (Beim & Madsen, 2015). This forms the outset for further studies in the RE-VALUE project, in which the theme will be explored through concrete case studies; firstly in a school renovation project in Copenhagen and secondly in a residential renovation project in Aarhus. The results of these case studies will provide insights into how to address qualitative, spatial aspects of energy renovations as part of a holistic approach to architectural transformation.

REFERENCES

- [1] Acre, F. and Wyckmans, A., 2015. Dwelling renovation and spatial quality: The impact of the dwelling renovation on spatial quality determinant. *International Journal of Sustainable Built Environment*, 4, pages 12-41
- [2] AktivHusDanmark, 2015. AktivHus Danmark – En bæredygtig designstrategi. Retrieved from: <http://aktivhusdanmark.dk/media/8437/aktivhus-folder-net.pdf> [Retrieved on 11 august 2016].
- [3] Bek, L., Oxvig, H. (1997): Rumanalyser, Fonden til udgivelse af arkitekturtidskrift B, Aarhus
- [4] Beim, A. and Madsen, U. S., 2015. Værdiskabelse i bygningsrenovering, CINARK, Copenhagen
- [5] Danish Building Research Institute (SBI), 2000. Evaluering af kvalitet i boligbebyggelser, 1st edition, By- og Boligministeriet, Copenhagen
- [6] DK-GBC (2015): Mini-guide til DGNB. Published by DK-GBC, Copenhagen
- [7] European Commission, 2014. Technical Guidance – Financing the Energy renovation of Buildings with Cohesion Policy funding. Retrieved from: http://ec.europa.eu/energy/sites/ener/files/documents/2014_guidance_energy_renovation_buildings.pdf [Retrieved on 20 September 2016].
- [8] Hvejsel, M. F., Kirkegaard, P. H. and Mortensen, S. B., 2015. Towards a tectonic approach – energy renovation in a Danish context. *Nordisk Arkitekturforskning*, 27, pages 35-60
- [9] Jensen, P. A. and Maslesa, E., 2013. RENO-EVALUE Et værdibaseret værktøj til målformulering og evaluering af bygningsrenovering, Technical University of Denmark, Management Engineering, Copenhagen
- [10] Jensen, P. A., Maslesa, E., 2015. Value based building renovation – A tool for decision-making and evaluation. *Building and Environment*, 92, pages 1-9.
- [11] Kamari, A., Kirkegaard, P.H., Jensen, Corrao, R., S.R., 2016. Towards a holistic methodology in sustainable retrofitting: Theory, Implementation and Application. In *Transforming Our Built Environment through Innovation and Integration: Putting Ideas into Action* proceedings of the SBE 2017, Hong Kong, China.
- [12] Kulturarvsstyrelsen, 2011. SAVE - Kortlægning og registrering af bymiljøers og bygningers bevaringsværdi. Retrieved from: http://slks.dk/fileadmin/user_upload/kulturarv/fysisk_planlaegning/dokumenter/SAVE_vejledning.pdf [Retrieved on 20 September 2016].
- [13] Marsh, R., Faurebjerg, L. M., Kongebro, S., 2013. Arkitektur, Energi, Renovering: designguide for energy-, dagslys-, og indeklima-renovering, The Danish Building Research Institute and Henning Larsen Architects, Copenhagen
- [14] Schunck, Charlotte, Plan C, 2011: Totalværdimodellen – Energirenovering med merværdi. Retrieved from: http://www.plan-c.dk/files/Dokumenter/rapport/totalvrdimodellen_14juni2011.pdf [Retrieved on 20 September 2016].
- [15] Tagliabue, L.C and Manfren, M., 2016. Sustainability Indicator for Buildings: Evolution and Interrelation Analysis by Advanced Visualization Techniques, abstract presented at the Sustainable Built Environment Conference, Zürich 13-17 June.
- [16] World Commission on Environment and Development, 1987. Our Common Future. Retrieved from: <http://www.un-documents.net/our-common-future.pdf> [Retrieved on 20 September 2016].

Renovation Needs and Potential for Improved Energy Performance Depending on Ownership – A Location Based Study of Multi-Family Building Stocks in an Urban Context

Magnus ÖSTERBRING^a, Liane THUVANDER^b, Érika MATA^c, Holger WALLBAUM^d

^a Chalmers University of Technology, Sweden, magost@chalmers.se

^b Chalmers University of Technology, Sweden, liane.thuvander@chalmers.se

^c Swedish Environmental Research Institute, Sweden, erika.mata@ivl.se

^d Chalmers University of Technology, Sweden, holger.wallbaum@chalmers.se

ABSTRACT

The transformation of urban building-stocks is fundamental to achieve climate change mitigation targets. As the rate of renewal of the building-stock is low, energy efficiency measures need to be applied when renovation is being done. To evaluate the renovation potential of the existing building stock on an urban level, a local approach is needed to understand challenges and possibilities associated with its transformation. The aim of this study is to investigate the renovation needs and potentials for implementation of energy efficiency measures in relation to owner and type of ownership for the buildings. For this purpose, available databases containing building-specific information have been gathered and processed for the multi-family building stock of the city of Gothenburg, Sweden. These data sources are used to describe the energy performance of the stock and future renovation needs based on type of property ownership while considering the location and context of the buildings using geographic information systems. Building attributes such as year of construction, value year, property owner, geometric data and energy performance certificates are spatially linked and visualized to describe the energy performance of buildings and its relation to renovation need, providing detailed and valuable information to property owners. Buildings from the period 1960 - 1975 are of particular importance as they constitute 42% of the multi-family building stock, have the highest average energy use (146 kWh/m²/year) and have to a large extent not been **renovated. The municipality's housing company own 36 % of the total stock and even more so considering buildings** from this period. While there will be a significant challenge in renovating their stock, this also presents an opportunity for large reductions in energy use. By incorporating building-specific information and considering the building in its local setting, a more holistic and realistic view on energy saving potentials can be achieved. The results aim to support owners of larger property portfolios in prioritizing buildings suitable for renovation.

Keywords: multi-building perspective, refurbishment, energy efficiency, GIS

1. INTRODUCTION

Buildings account for about 40 % of the final energy use and 36 % of CO₂-emissions in Europe (BPIE, 2011). At the same time, they provide a possibility for cost-efficient energy efficiency measures (EEM) (IPCC, 2014). The European Energy Performance of Buildings Directive defines efficiency standards for both new and existing buildings targeting these efficiency opportunities (EU, 2010, EC, 2002). The Swedish government has similarly set policy which strives for substantial reductions in energy use by 2020 and 2050 (SOU 2005, Swedish Government, 2009). In order to encourage energy efficiency in buildings, energy performance certificates (EPC) were introduced in Sweden in 2006 as a result of the EU energy efficiency directive (EC, 2002). On a municipality and city level, more ambitious targets on energy savings have voluntarily been adopted. The city of Gothenburg has implemented such targets and aims to reduce energy consumption in residential buildings by 30 % by 2020 compared to 1995 levels (City of Gothenburg, 2009). For developed countries, it is estimated that most of the buildings that will be in use in 2050 have already been built (U.N.E.P sbci, 2009) and the renewal rate of the Swedish residential stock is only 0.6% (Boverket, 2014), which implies a need for EEM in the existing stock if the above-mentioned targets are to be met.

In order to evaluate the renovation potential of the existing building stock on an urban level, a space and context specific approach is needed to understand challenges and possibilities associated with its transformation. By using building-specific information and considering the building in its setting, a better overview can be achieved (Thuvander et al., 2015). In Sweden, there are several data sources available with attribute data on buildings such as EPC, the building and property register as well as cadastral maps. It is important to note that Swedish EPC

contain information on measured energy performance and not calculated energy performance. As these datasets contain information on spatial location, it is possible to combine the different data sources for individual buildings using geographic information systems (GIS). Since the property register also contains information about ownership, it is possible to not only aggregate building information to spatial units such as districts or neighbourhoods but also for individual property owners. Furthermore, information regarding the economic extent of past refurbishment activities is known which better enables the analysis of future renovation needs.

The purpose of this paper is to describe the renovation need and related potential for energy savings for the urban housing stock of the city of Gothenburg.

2. MATERIALS AND METHODS

The renovation need is identified for the MFB stock in the city of Gothenburg considering previous renovation activities, energy performance of buildings and ownership. Available databases for the building-stock of the city of Gothenburg are gathered and spatially linked using GIS software ArcGIS (Table 1). The extent of the renovation need until 2025 considering a service-life of 50 years is evaluated both spatially and graphically for different housing owners, managers and types of ownership. A service-life of 50 years is commonly used in renovation studies for Sweden (Mangold et al., 2016).

Data were retrieved from the Swedish Mapping, Cadastral and Land Registration Authority (Lantmäteriet), the National Board of Housing, Building and Planning (Boverket) and the City planning office of Gothenburg. Table 1 shows the building specific databases available for the city of Gothenburg, level of aggregation, the most relevant information they contain, and the identifier for the spatial linkage.

Database/ Data owner	Aggregation level	N	Relevant information	Identifier
The building register	Building	153 000	Building type, construction year, value year and renovation year	Building ID, Property ID, mid-point coordinates
The property register	Property	114 000	Property owner, % owned	Property ID
National EPC database	Building	6 320	Energy use, HVAC systems, energy performance, heated floor area, number of stories, number of apartments	Building ID
Cadastral maps/ City planning office	Building	178 000	2D, 3D (roofs)	Coordinates

Table 1: Building specific databases available for the city of Gothenburg, level of aggregation, and number of posts (N) for the city of Gothenburg, the most relevant information contained, and the identifier for the spatial linkage.

The Swedish Mapping, Cadastral and Land Registration Authority supplied parts of the property register, specifically the provided the building register (50A) and the register of property owners (42P). The building register contains information on building type, year of construction, year of renovation and value year. The value year is calculated based on the year of construction and year of renovation and weighted depending on the economic extent of previous renovation measures. As such it can be used to assess the remaining life-time of a building and to assess the cost of previous renovation activities (Mangold et al., 2016). Table 2 and Equation 1 describes how the Swedish Tax Office requires a renovation to be registered as a change in value year (Swedish Tax Office, 2012).

Renovation cost	Calculation of value year
Less than 20 % of new building cost	No change in value year
20-70 % of new building cost	The value year is set based on Equation 1
More than 70 % of new building cost	The value year is set to the year of renovation

Table 2: Swedish Tax Office's requirements for registration of a renovation as a change in value year (Swedish Tax Office, 2012).

$$\frac{(\text{Value year} - \text{Construction year})}{\text{Renovation year} - \text{construction year}} = \frac{\text{Renovation cost}}{\text{New construction cost}}$$

Equation 1

The National Board of Housing, Building and Planning supplied all EPC for the city of Gothenburg. The Swedish EPC are unique in that they not only contain valuable information on characteristics of the buildings such as heating, ventilation and cooling system but also measured energy use for space heating (SH), domestic hot-water (DHW), and non-domestic electricity use. However, the Swedish EPC also suffers from some drawbacks. While the energy performance is given separately for SH, DHW and non-domestic electricity use, it is rarely measured separately but rather subdivided by the energy expert issuing the certificate. Similarly, the heated floor area (HFA) is rarely measured but rather derived based on the living area. More information on the Swedish EPC and suggestions on how to overcome issues of deriving the HFA on a stock level have been done by Mangold et al., (2015).

From the City planning office, GIS shape files in 2D were provided for the footprints of the buildings as well as outlines of two different levels of statistical/ administrative areas, base areas and primary areas. The datasets are combined based on the identifiers as follows. The EPC are connected to the property register using the building ID and the register of property owners is connected to the building register using the property ID. Coordinates are used to connect these datasets to each individual footprint in the 2D-map of Gothenburg. As not all EPC contain the correct identifier, 5 901 of the 6 320 EPC are spatially linked to footprints. The HFA from the full set of EPC decreases from 17 500 000 m² to 15 900 000 m² for the information that can be spatially linked to individual buildings.

3. RESULTS

Figure 1 shows the measured energy use (in total for SH, DHW and non-domestic electricity use) for the MFB stock in Gothenburg. It is divided into age-groups, i.e. year of construction, with their associated share of the total HFA. As can be seen, the energy performance is quite even for the stock up until 1980. The sharp decline in energy use in the building-stock occurring during the 1980s can be explained by more stringent demands on U-values being introduced in 1975. Figure 2 shows the distribution of HFA in the MFB stock divided by property owner, property manager or owner type. The municipal housing company (Framtiden AB) owns about a third (36%) of the stock with another third (33%) being private housing cooperatives. The two largest private housing cooperative managers, HSB and Riksbyggen, are presented separately. The last third of the stock is owned by private owners, individuals, foundations and others where the last category includes estates and non-profit organisations.

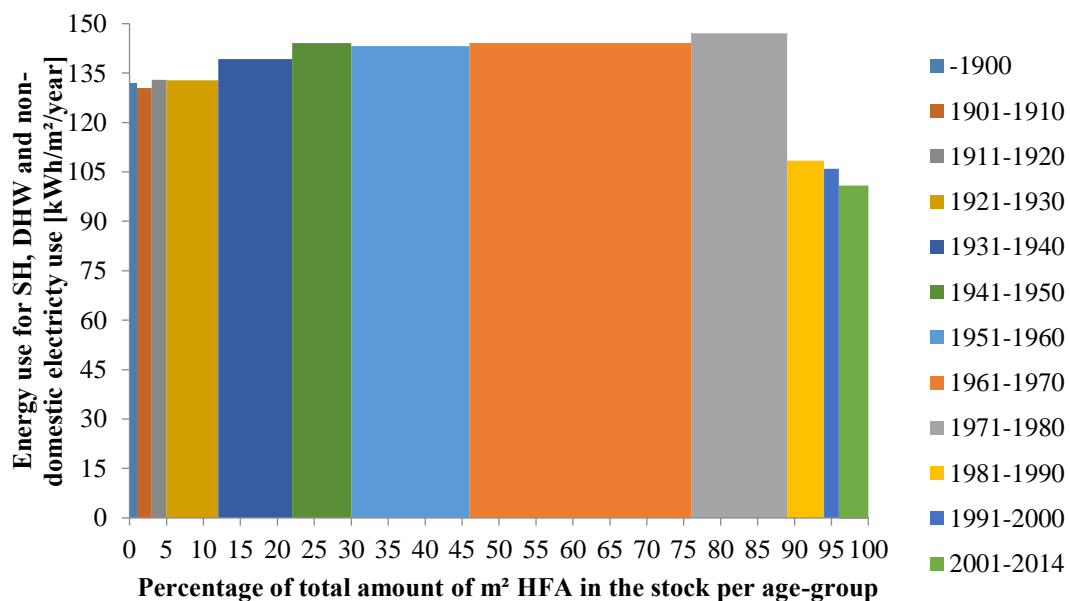

Figure 1: Measured energy use for the MFB stock in Gothenburg by age-groups. HFA, heated floor area.

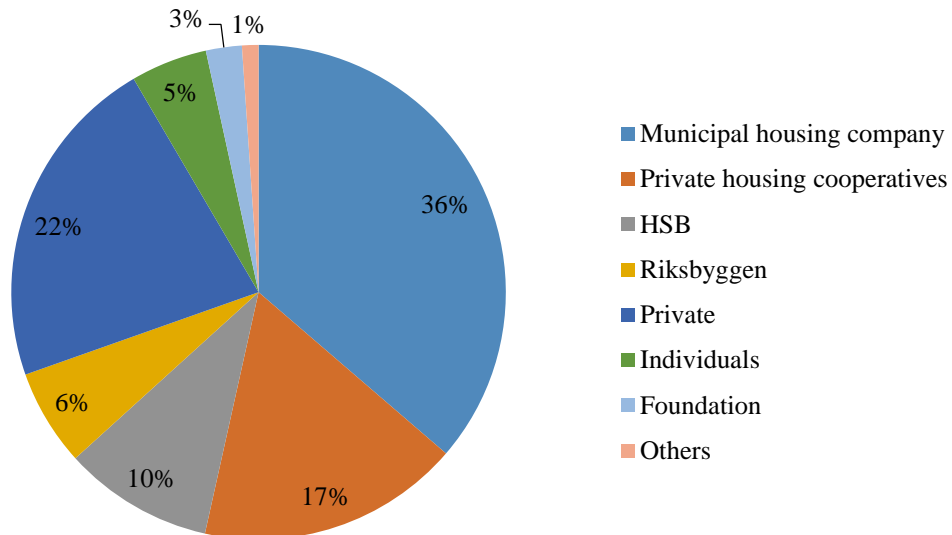

Figure 2: Shows the distribution of HFA in the MFB stock divided by property owner, property manager or owner type.

Figure 3 shows the spatial distribution for primary areas of the sum of m² HFA in need of renovation. On the left, all buildings in the MFB stock are included and on the right, buildings from the period (1960 - 1975), are highlighted. These buildings are of particular importance as they constitute the largest part of the stock (42% of all HFA) and have the highest average energy use (146 kWh/m²/year). Unlike buildings from earlier time-periods, these buildings have to a large extent never gone through a major renovation. The buildings from this period are nearing the end of their service-life and require renovation in the coming decade.

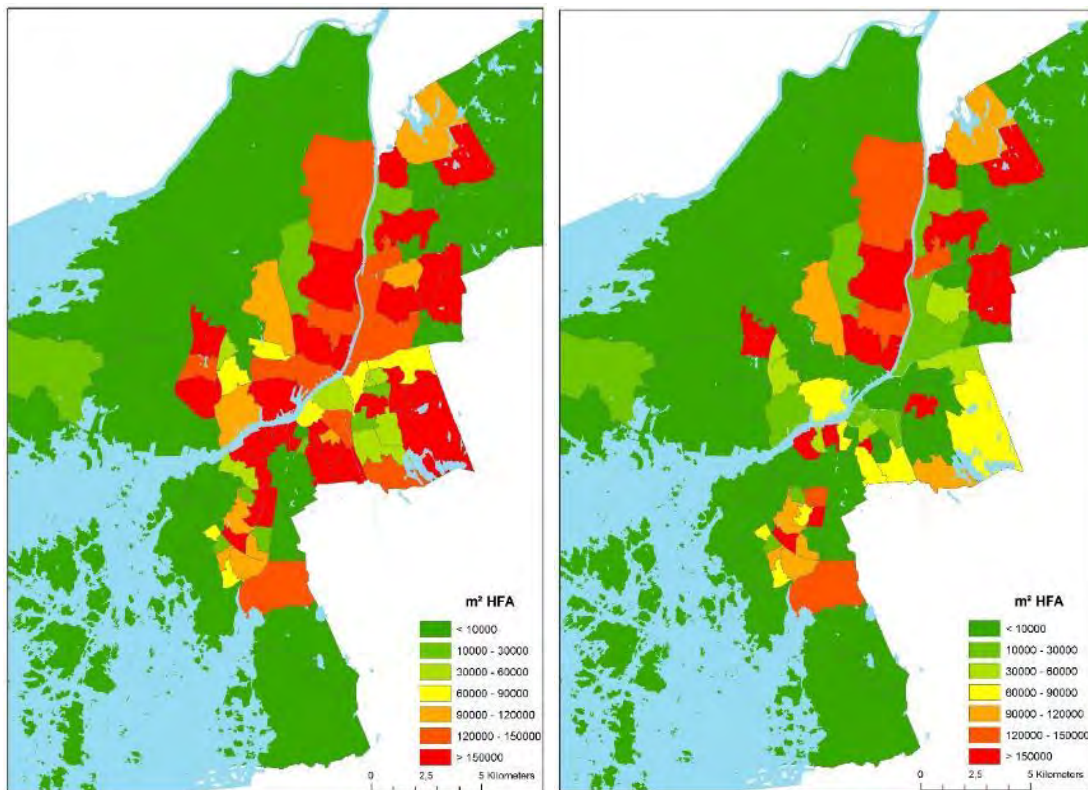

Figure 3: Shows the spatial distribution for primary areas of the sum of m² HFA in need of renovation. On the left, all buildings in the MFB stock are included and on the right, buildings from the period (1960-1975), are highlighted.

Figure 4 shows the share of the stock of the different property owners, managers and owner types that will reach a service-life of 50 years until 2025. It is clear that the renovation need will be substantial as most building owners will need to renovate more than 50 % of their total stock. In total, almost 10 000 000 m² of HFA requires renovation using the assumption of a service-life of 50 years. While a service-life of 50 years may be representative for certain building components, it is likely that other components will have a longer life-span. This is also likely to be impacted by the maintenance of the buildings which may vary significantly between different building owners and managers. The highest renovation need can be found in the group of individuals who owns MFB. The municipal housing company, Framtiden AB, have a slightly lower renovation need than private owners on average. The private housing cooperatives managed by HSB and Riksbyggen have a substantially larger renovation need than the average housing cooperative. It should be noted that while the value year changes if the cost of renovation is more than 20 % of the cost of new construction, smaller renovations and regular maintenance which may prolong the service-life of a building significantly is not taken into account.

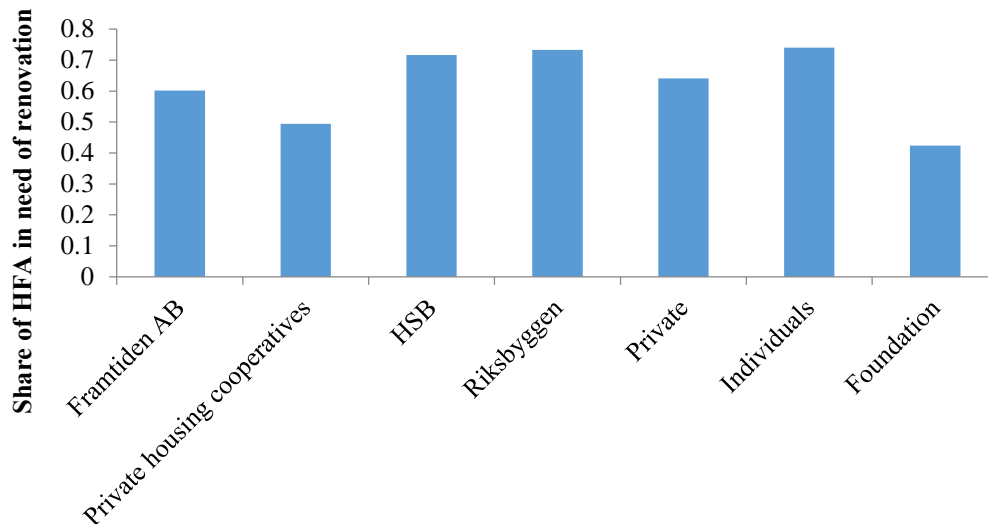

Figure 4: Share of the stock in need of renovation (normalized for total m² in stock) of the different property owners, managers and owner types that will reach a service-life of 50 years until 2025.

4. CONCLUSION

This paper has shown that available data sources can be used to describe the characteristics of the stock on a building level while considering the location and context. Building attributes such as year of construction, value year and owner from the Swedish Property register, spatial data provided by the City planning office of Gothenburg as well as EPC from the National Board of Housing, Building and Planning can provide detailed and valuable information to policy makers, urban planners and property owners. In this paper, the extent of refurbishment needs of the MFB stock of the city of Gothenburg has been assessed by ownership type as well as spatially. The extensive need for renovation need during the next ten years also provides an opportunity for achieving considerable reductions in energy demand. This work gives an overview of the existing renovation needs of the MFB in Gothenburg and is a starting point for the development of renovation strategies. Future work on renovation needs should expand the parameters used to describe the composition and state of the stock.

REFERENCES

- [1] Boverket (2014). Flyttmönster till följd av omfattande renoveringar. Rapport 2014:34, Regeringsuppdrag, Boverket, Karlskrona. Available on: <http://www.boverket.se/sv/om-boverket/publicerat-av-boverket/publikationer/2014/flyttmonster-till-foljd-av-omfattande-renoveringar/>.
- [2] BPIE, Europe's Buildings under the Microscope. A country-by-country review of the energy performance of buildings. 2011, Building Performance Institute.
- [3] City of Gothenburg, Strategic climate programme for Gothenburg. 2014.
- [4] EC, Directive 2002/91/EC of the European parliament and of the council on the energy performance of buildings. 2002: Official Journal of the European Communities.

- [5] EU, Directive 2010/31/EU of the European parliament and of the council on the energy performance of buildings (recast). 2010: Official Journal of the European Union.
- [6] IPCC, 2014: Climate Change 2014: Mitigation of Climate Change. Contribution of Working Group III to the Fifth Assessment Report of the Intergovernmental Panel on Climate Change [Edenhofer, O., R. Pichs-Madruga, Y. Sokona, E. Farahani, S. Kadner, K. Seyboth, A. Adler, I. Baum, S. Brunner, P. Eickemeier, B. Kriemann, J. Savolainen, S. Schlömer, C. von Stechow, T. Zwickel and J.C. Minx (eds.)]. Cambridge University Press, Cambridge, United Kingdom and New York, NY, USA
- [7] Mangold, M., Österbring, M., & Wallbaum, H. (2015). Handling data uncertainties when using Swedish energy performance certificate data to describe energy usage in the building stock. *Energy and Buildings*, 102, 328-336.
- [8] Mangold, M., Österbring, M., Wallbaum, H., Thuvander, L., & Femenias, P. (2016) Socio-economic impact of renovation and energy retrofitting of the Gothenburg building stock. *Energy and Buildings*, 123, 41-49.
- [9] Österbring, M., Mata, É., Thuvander, L., Mangold, M., Johnsson, F., & Wallbaum, H. (2016). A differentiated description of building-stocks for a georeferenced urban bottom-up building-stock model. *Energy and Buildings*, 120, 78-84.
- [10] Sbc, U. N. E. P. (2009). Buildings and climate change: a summary for decision-makers. United Nations Environmental Programme, Sustainable Buildings and Climate Initiative, Paris, 1-62.
- [11] SOU, Nationellt program för energieffektivisering och energismart byggande [National Programme for Energy Efficiency and Energy-Smart Construction]. 2005, Government Official Reports Vol. 2005/06:145.
- [12] Swedish Government Bill 2008/09:163, A cohesive energy and climate policy: Energy. 2009.
- [13] Swedish Tax Office, The tax office general advice (Skatteverkets allmänna råd), 2012.
- [14] Thuvander, L., Österbring, M., Mangold, M., Mata, É., Wallbaum, H., & Johnsson, F. (2015). Spatial exploration of the refurbishment dynamics of urban housing stocks. In *Computers in Urban Planning and Urban Management CUPUM Cambridge*.

Session 7.4: Deep Renovations – Processes & Methodologies

Towards a Holistic Methodology in Sustainable Retrofitting: Theory, Implementation and Application

Aliakbar KAMARI^a, Stina Rask JENSEN^b, Rossella CORRAO^c, Poul Henning KIRKEGAARD^d

^aDepartment of Engineering, Aarhus University, Denmark; Department of Architecture, University of Palermo, Italy, ak@eng.au.dk

^bDepartment of Engineering, Aarhus University, Denmark, srj@eng.au.dk

^cDepartment of Architecture, University of Palermo, Italy, rossella.corrao@unipa.it

^dDepartment of Engineering, Aarhus University, Denmark, phk@eng.au.dk

ABSTRACT

Sustainability paradigm foresees a balance of energy production and consumption with no, or minimal, negative impact on environment (within the environmental tolerance limits). It gives an opportunity to a country to employ its potentiality of the social and economic activities. An overview of recent researches about building renovation context demonstrates the lack of an appropriate methodology and decision support framework -by compounding the typical challenges of sustainable retrofitting from theory to implement stages- that takes into account the retrofitting projects throughout more comprehensive insights and perspectives. It calls, therefore, for a deep building renovation approach. The major difference between a deep building renovation project and an ordinary one is commitment to a holistic approach. From one side, it initially should be able to deal with the society including various stakeholders with different priorities and barriers -on the top of the list is behavioral barriers about energy consumption- in order to improve their learning; to the other side, it has to perform multiple optimization through sustainability development perspective in its full sense. The intent is to identify, manage, and evaluate the renovation objectives through different available retrofitting alternatives during the early design stages. In this framework, the paper considers building renovation as a complex messy/wicked problem and later it gives details on how combinations of methods that are parts of SSM (Soft Systems Methodologies) and MCDM (Multi Criteria Decision Making) may support multiple perspectives of such a problem. The aim is to promote a methodology which is initially able to deal with complexity of the detected problem and subsequently to address building renovation process in order to involve the various stakeholders in the design process [and keep them involved in all design stages]. Doing so leads to more effective and sustainable retrofitting actions within different criteria including functionality, feasibility, and accountability.

Keywords: sustainable retrofitting, deep building renovation, holistic methodology

1. INTRODUCTION

Enhancing energy efficiency is not the only goal for renovation of the existing buildings. The main objective has to be creating a high-performance building via application of the holistic and integrated design process, to the project during design stages which makes sure all design goals are met. In modern age and so rising complexity, the extent of this potential can be described and made up in several ways and this can happen with focus on climatic interests, security of supplies, environmental impacts, life-cycle cost, indoor climate, building functionality, spatial quality issues and other relevant arguments (Kamari et al., 2016). To achieve overall sustainability in this regard, **these factors must be taken into consideration all together in order to gain “sustained prosperity”**. But a logical question arises: how can the design team address this complexity among different objectives (?) which itself is methodological issue where the present study as part of a bigger project called RE-VALUE makes effort to deal with. The attempts here is on the development of a holistic methodology to address retrofitting context in order to keep the different stakeholders involved in the process and carrying out a real sustainable retrofitting based on multiple criteria in its totality. Doing so means it deals with the overall objective of the RE-VALUE project (within its macro scale) which is to develop and demonstrate the validity of a generic renovation assessment method within an integrated design schema. For this reason, the present paper primarily (see section 2.1) provides information about the general barriers and challenges in retrofitting context towards formulation of the research problem in section 2.2 that states the main objective of this research project. Later in section 3, it identifies the reasons for the suitability of SSM and MCDM in order to promote a holistic multi-methodology (Mingers et al., 1997) through mixing

certain SSM and MCDM that practically able to implement a sustainable retrofitting and overcome existing barriers in actual situation.

2. THE NATURE OF THE PROBLEMS IN SUSTAINABLE RETROFITTING CONTEXT

2.1 Barriers and challenges in retrofitting process

Experience over several decades has demonstrated numerous barriers that hinder the uptake of renovation measures. Having overall view over the sustainable retrofitting context reveals the existence of various barriers based on buildings functions and usage, features, environment and society in the bigger scale (BPIE, 2011). Booth *et al.* (2013) argue the barriers into the most usual ones as “Pre-bound effect” - which is the divergence between modelled and actual energy consumption for the pre-retrofit -, and “Rebound effect” in which the post-retrofit energy consumption is higher than predicted, due to changes in occupant behaviour following the installation of a measure. For the space reason it seems essential to summarize following discussion; therefore, within a more sustainable and holistic vision, the barriers in this context have been examined and classified in a more precise way by BPIE (2011) throughout “Financial”, “Institutional and Administrative”, “Awareness, advice and skills” and “Separation of expenditure and benefit”. In this regard, the challenges were identified as the main risks which need to be addressed for market uptake within Supply chain, Quality of workmanship, Technical failure, and Disturbance.

2.2 Problem statement and research objective

This section tries to zoom out and seeks for common patterns in order to formulate and simplify above issues into a few main trends so as to deal with the existing complexity through some of their principles and components. In retrofitting context from one side a common reason for many of existing barriers is the necessity of involvement or dealing with its humane society and so lack of learning. In other side there are different criteria or objective which derives into project based on sustainable perspective [as source of Holism] which need to be optimized within a multiple optimization process. Hence it is looked not just as a technical problem but as a socio-technical problem; in this regard we refer word ‘society’ to the community of different stakeholders who are involved in retrofitting process (see Figure 1), and also word ‘technical’ for sustainable aspects of the retrofitting and its various alternatives (see Figure 2). It also has to be noted that the technical part in this model itself has a holistic insight in connection with three pillars of sustainability.

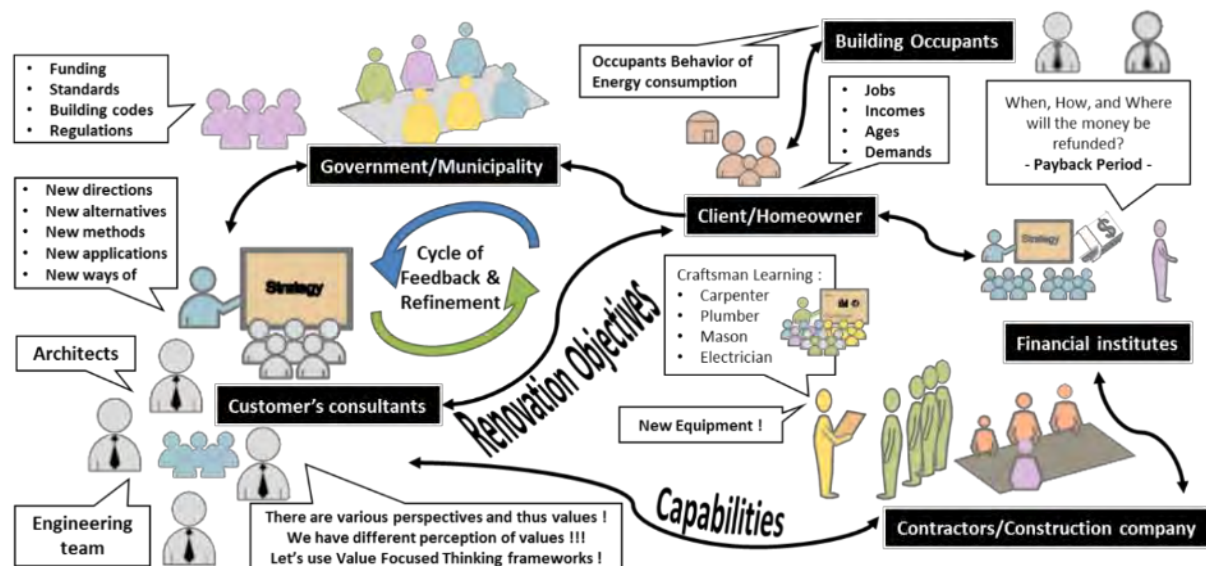

Figure 32: Different stakeholders involved in building renovation context

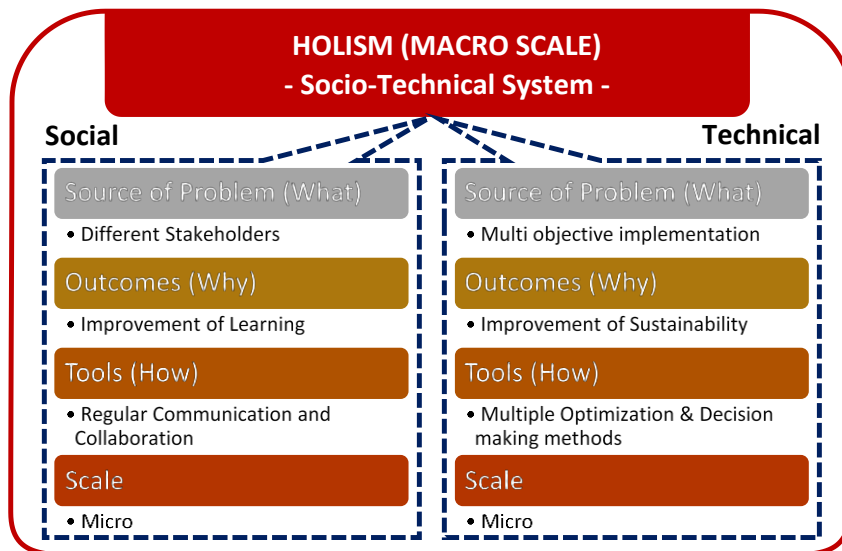

Figure 33: Concept of Holism in retrofitting context

A recent review on existing assessment tools related to building renovation, highlights that 'holism' in relation to building renovation is not an unequivocal quantity. The tools represent a number of different approaches to holism, giving weight to different sustainability indicators (Jensen et al., 2016). The included tools span from process management tools to certification schemes and from a delimited focus to a more evenly weighting of the three sustainability indicators. The major number of the present tools and methodologies are not able to fully address non-technical values alongside quantitative values, especially in relation to social sustainability indicators in aforementioned context.

A retrofitting problem is a complex system because it cannot be fully addressed and evaluated without comprehension of the relationships between its technical objectives and society as well as the influences of its development impact on its environment and world (its neighbors and city in a bigger scale) as whole. Therefore the architects/designer should not only unravel a well technical problem examination, but formulate the problem based on the present circumstances once they begin another. This issue is equivalent from many views to the **problems which known as messy/wicked problems. The phrase 'wicked problems' (Churchman, 1967) were** originally used in the context of social planning and it used to demonstrate problems that were difficult to overcome, since they address complex social interdependencies. There are at least two attributes of the wicked nature of problems; initially it is difficult to formulate solutions, because of the complexity of a socio-cultural interactions and interdependencies which it happens in; this leads to the inability to foretell long-term effects of decisions since the recognition of the source of the problem is highly complicated. Secondly the definition of objectives due to various circumstances is provisional, and it entails different features, ideas and interests (Estkowski, 2013). Similarly the characteristics of the concern problems in retrofitting discipline involves many qualitative and quantitative factors and criteria that are provisional case to case. In other words, the alternative solutions for an existing building frequently cannot be applied for others due to the changes in environmental circumstances and various decision makers including customers, designers etc. In this perspective its nature is quite similar the problems discussed above as messy/wicked problems. Therefore the practical needs for improvement in this context is calling for new approaches.

In summary then, the decision regarding retrofitting of existing building is initially a highly complex problem subjected to lack of an appropriate methodology and decision support tool to influence its society and technical part simultaneously. It means the methodology should take retrofitting projects into the consideration, initially in **order to address its wicked nature resulting by 'Learning Improvement' among the stakeholders and then 'Multiple Optimization' through identify, manage, and evaluate the building objectives among the different renovation criteria** and retrofitting alternatives with a holistic vision (subject to the macro scale - see Figure 2) regarding to functionality, feasibility, accountability, or sustainability in its full sense (Kamari et al., 2016). This explanation informs the next section of the present paper in order to detect the existing methodologies which are able to deal with complexity in retrofitting context and hence gives a short description on the suitability of SSM and MCDM towards proposing a qualified methodology which is structured within mix of methods.

3. DEVELOPING A HOLISTIC METHODOLOGY IN SUSTAINABLE RETROFITTING

3.3 Appropriateness of soft systems methodology (SSM)

SSM was developed by Peter Checkland in 1970s at Department of Systems, University of Lancaster. The SSM approach stems from the 'systems movement', which Checkland (1999) considers as an effort to give holistic approaches in socio-technical problems. It is a method that in a systematic way attempts to establish and framework a debate regarding actions for enhancing the complex and messy situations. Maqsood et al. (2001) describe it as a framework for iterative enquiry and learning about the organization which provides a well-defined action research approach to help address wicked problems. The concept of SSM has been explained more in **details by Checkland (2000); he has referenced SSM in an evolutionary path primarily defined as 'seven stages model (1981)' and being developed through 'two main stream approach (1988)' and finally concluded by 'four main activity research method (1990)'. SSM through the last updated approach (four main activity) encourages group learning and is ideal as a group decision-making approach. It is strengthened by the active participants and stakeholders, and encourages joint ownership of the problem solving process. Eventually, SSM is recommended where an organization is seeking to achieve changes in workplace culture and transformation into a learning organization (Rose, 1997). In this perspective using SSM in building renovation context being able to develop an integrated design process which keeps the society involved in all the design stages. It is able to deal with complexity, capture it and communicate it among the key players. Therefore it enables us to address major part of the problem formulated in section 2.2.**

3.4 Appropriateness of multiple criteria decision making (MCDM)

MCDM is a sub-discipline of operations research. It has been developed to help decision makers throughout **complex decision analysis. The term 'decision analysis' can be explained as a body of knowledge and professional practice for the logical shining of decision problems. Parnell et al. (2013) discuss it as "a philosophy and a social-technical process to create value for decision makers and stakeholders facing difficult decisions involving multiple stakeholders, multiple (possibly conflicting) objectives, complex alternatives, important uncertainties, and significant consequences. Decision analysis is founded on an axiomatic decision theory and uses insights from the study of decision making". In this regard the term MCDM defines as decision analysis involving multiple criteria.** The purpose is to support decision-makers facing complex problems based different aims and objectives. According to the reviewed literatures, MCDM is categorized into two main sub-group, Multi-Objective Decision Making (or MODM) and Multi-Attribute Decision Making (or MADM). MODM studies decision problems in which the decision space is continuous. MCDM can be applied in building renovation (Phdungsilp et al., 2004) context through both MODM and MADM and as such being able to equip the design process to primarily deal with existing complexity and different criteria driven from a sustainable perspective.

2.3 Mixing SSM with MCDM

The utilization of different approaches from different methodologies and domains is not a new concept and there are researchers who have put it into the consideration theoretically and also exploited it practically in the past (Jackson, 2003). It is another way of strengthening the Multiple Perspectives view of the complex problems due to the inefficiency of traditional approaches to confront the actual situation. Similarly, the needs for retrofitting context within different situations was considered diverse and complex and thus could not be served by a single methodology; for this reason present section tries to justify use of mixing methods including SSM and MCDM in retrofitting context. It needs to be addressed primarily through their potential benefits and individual lacks in facing a complex problem and secondarily from the dimension/shape of the formulated problem earlier.

The potential of using methodologies such as SSM or MCDM [in addition to preceding sections 3.1 & 3.2] can be considered from their vast application in other complex domain or over developing more complex products; above all, the availability of the various tools and software in making and implementation of decisions in using SSM or MCDM is the other reason that increases their appeals. However, according to the reviewed literatures the most important weakness regarding to SSM is the lack of support given by it during the Selection and Implementation phases and for MCDM it is in problem exploration and structuring stage which relies for the definition of the model only on brainstorming (Jayaratna, 1994). Petkove et al. (1997) underline that it should not be viewed as a rejection of these techniques as a systems science tool. On the contrary, on the basis of Critical Systems Thinking one can find a common foundation for the complementarist use of MCDM techniques with soft systems approaches

belonging to the field of problem structuring methods. The authors conclude that there is considerable scope for new and fruitful combined application of MCDM method with different strands of systems thinking and the result enriching both. By use of multiple methods [according to sections 3.1, 3.2, and 3.3], the formulated problem in retrofitting context on one side is fitted to be addressed where we need a regular communication, collaboration and brainstorming among the stakeholders in order to promote learning and participation in a bottom up way by using SSM; and on the other side the criteria can be selected, weighted, and balanced in order to choose the most appropriate retrofitting alternative into a sustainable perspective in using MCDM. As a result of this interventions, the stakeholders can concentrate on building a common appreciation about the most essential issues corresponding to the technical, cultural and political aspects of the problems on hand. Moreover it propel better informed management decision related to the particular situation.

4. The proposed holistic step by step methodology in sustainable retrofitting

The preceding discussions provided indications for developing a methodology including mix of methods. The question then arises how techniques are selected and considered suitable for specific tasks. There are assumption of the various methodologies in order to justify choice of the methods (Mingers et al., 1997; Vo et al., 2001; Jackson, 2003; Petkove et al., 2007) and for the space reason we have to just refer to their works. Comprehensive overview of the methods and approaches belonging SSM and MCDM revealed the suitable methodology and methods which can be exploited in retrofitting context. They were identified through the guidelines provided from cited research works, mapping of the selected methods onto the world of building renovation and inclusion of key players in the problem solving frameworks (see Table 1).

Stage 1	Finding out about a problem situation, including culturally/politically	
	Step 1	Problem formulation
	Step 2	Selecting the main design criteria and sub-criteria
	Step 3	Developing measurement scales for the sub-criteria
<i>Proposed methods: Root definition, Rich picture, CATWOE, PQR (What, How, Why), and Delphi method [03,04,20]</i>		
Stage 2	Formulating some relevant purposeful activity models	
	Step 4	Generating alternative solutions
	<i>Proposed methods: Process modeling in SSM [04,15,21]</i>	
Stage 3	Debating the situation, using the models, seeking from that debate both	
	a) changes which would improve the situation and are regarded as both desirable and (culturally) feasible	
	b) the accommodations between conflicting interests which will enable action to improve to be taken	
	Step 5	Weighing the main criteria and sub-criteria
<i>Proposed methods: POT or SAST + Pairwise comparison and/or TOPSIS and/or AHP [12,13,15,19,20]</i>		
Stage 4	Taking action in the situation to bring about improvement	
	Step 6	Predicting performance
	Step 7	Aggregating scores
	Step 8	Analyzing results and making decisions
	<i>Proposed methods: AHP and/or TOPSIS [13,20]</i>	

Table 1: Holistic step by step methodology in sustainable retrofitting

The major framework of the above methodology has been developed from “four main activity approach in SSM”; the original methodology can be described as a four main activities process of analysis which uses the concept of a human activity system as a means of getting from “finding out” about a situation to “taking action” and improve the situation (Checkland, 2000). There also eight steps have been outlined that facilitates the avail of the methodology step by step. For each stage the required methods from SSM and MCDM have also been identified; although there is no space in this paper to discuss them one by one but instead the references have been provided to them for further studies.

5. CONCLUSION

The significant discrepancy in a deep building renovation and an ordinary one is a commitment to holistic approach. Looking at a project holistically for potential energy savings invariably means using an integrated design process. It is then developing a design process which explores the interdependency between different building systems and renovation goals towards achieving sustained prosperity at the end of the day. This paper explored the nature of the problem in retrofitting context as a highly complex and socio-technical system and subsequently investigated and addressed the concept of Holism. It represented a methodology throughout mixing some certain SSM and MCDM in order to support decision-making process. Following the outlined methodology can overcome the problem formulated in earlier section (see section 2.2) based on the nature and mechanism of the methods which are applied in there. It is initially able to deal with the existing complexity and wicked nature of the problem in building renovation domain and subsequently to address the present issues throughout its society (subjects to improve the **building occupants' learning**) and **technical part (subjects to sustainability in it full sense)** simultaneously. However the concept of the using mix of methods in retrofitting context stands on the beginning of its path and to utilize the full potential of this concept it needs to be tested in various circumstances and uses of **different methods**. **"Using a multi-methodology reflects the conflicting nature of the criteria guiding decision makers in complex situations and harness their potential to support learning about the problem and more effective decision support", adopted from Petkov et al. (2007).**

REFERENCES

- [1] Booth, A.T. and Choudhary, R., (2013). Decision making under uncertainty in the retrofit analysis of the UK housing stock: Implications for the Green Deal. *Energy and Buildings*, 64, 292–308.
- [2] BPIE - **Buildings Performance Institute Europe**, (2011). **Europe's buildings under the microscope**. Retrieved from: <http://bpie.eu/wp-content/uploads> (Retrieved on 18 May 2015).
- [3] Checkland, P. (1999). *Systems Thinking, Systems Practice*, John Wiley & Sons, Chichester, UK.
- [4] Checkland, P., (2000). Soft Systems Methodology: A Thirty Year Retrospective. *Systems Research and Behavioral Science*, 17(1), 11-58.
- [5] Churchman, C., (1967). Wicked Problems. *Management Science*, 14(4), 141-146.
- [6] Estkowski, T., (2013). *Towards a Generative Design System Based on Evolutionary Computing*. Thesis (PhD). The Oslo School of Architecture and Design.
- [7] Jackson, M.C., (2003). *Systems Thinking: Creative Holism for Managers*, John Wiley & Sons, Chichester, UK.
- [8] Jayaratna, N., (1994). *Understanding and Evaluating Methodologies: NIMSAD, A Systemic Framework*, McGraw-Hill, London.
- [9] Jensen, S.R., Kamari, A., Strange, A. and Kirkegaard, P.H., (2016). **'Towards a holistic approach to retrofitting: A critical review of state-of-the-art evaluation methodologies for architectural transformation'**, paper presented at the *Sustainable Building Regional Conference (SBE 2017)*, Hong Kong, China.
- [10] Kamari, A., Corrao, R. and Kirkegaard, P.H., (2016). A Holistic Sustainability Decision-making Framework to support and assess Building Renovation. *Sustainable science*, under review.
- [11] Maqsood, T., Finegan, A.D., and Walker, D.H., (2001). Five case studies applying soft systems methodology to knowledge management. Retrieved from: <http://eprints.qut.edu.au/27456/> (Retrieved on 11 August 2015).
- [12] Mingers, J. and Brocklesby, J., (1997). Multimethodology: Towards a Framework for Mixing Methodologies. *Omega, Int. Journal of Mgt. Sciences (IJMS)*, 25(5), 489-509.
- [13] Parnell, G.S., Bresnick, T.A., Tani, S.N. and Johnson, E.R., (2013). *Handbook of Decision Analysis*, John Wiley & Sons, Hoboken, New Jersey, NJ.
- [14] **Petkov, D. and Petkova, O., (1997). 'The Analytic Hierarchy Process and Systems Thinking'**, *Trends in Multicriteria Decision Making*, paper presented at the *13th International Conference on MCDM Cape Town*, South Africa, Springer.
- [15] Petkov, D., Petkova, O., Andrew, T. and Nepal, T., (2007). Mixing Multiple Criteria Decision Making with soft systems thinking techniques for decision support in complex situations. *Decision Support Systems*, 43(1), 1615–1629.
- [16] **Phdungsilp, A. and Martinac, I., (2004). 'Multi-Criteria Decision-Making Method for the Retrofitting of Designated Buildings in Thailand'**, paper presented at the *21th Conference on Passive and Low Energy Architecture (Plea2004)*, Eindhoven, The Netherlands.

- [17] Rose, J., (1997). Soft systems methodology as a social science tool. *Systems Research and Behavioral Science*, 14(4), 249–258.
- [18] SBI - Ministry of Climate, Energy and Building - Danish government, (2014). Strategy for energy renovation of building: The route to energy-efficient buildings in tomorrow's Denmark. Retrieved from: <http://www.kebmin.dk/> (Retrieved on 10 July 2014).
- [19] Vo, H.V., Paradise, D.B. and Courtney, J.F., (2001). 'Problem Formulation in Inquiring Organizations: A Multiple Perspectives Approach', paper presented at the *Seventh Americas Conference on Information Systems (AMCIS 2001)*, Boston, MA.
- [20] Wang, J., Jing, Y., Zhang, C. and Zhao, J., (2009). Review on multi-criteria decision analysis aid in sustainable energy decision-making. *Renewable and Sustainable Energy Reviews*, 13(9), 2263-2278.
- [21] Yin, H. and Menzel, K., (2011). Decision Support Model For Building Renovation Strategies. *World Academy of Science, Engineering and Technology*, Computing in Civil Engineering, 76, 834-841.

A Multidimensional Optimization Approach to Refurbishment Design on a Multi-Building Scale

Claudio NÄEGELI^a, York OSTERMEYER^b, Mohamad KHARSEH^c, Izabela KURKOWSKA^d, Holger WALLBAUM^e

^a Chalmers University of Technology, Sweden, claudio.naegeli@chalmers.se

^b Chalmers University of Technology, Sweden, york.ostermeyer@chalmers.se

^c Chalmers University of Technology, Sweden, mohamad.kharseh@chalmers.se

^d Chalmers University of Technology, Sweden, izabela.kurkowska@chalmers.se

^e Chalmers University of Technology, Sweden, holger.wallbaum@chalmers.se

ABSTRACT

European countries face a large challenge in retrofitting their aging building stock, which they need to embark on, in order to reach European Union (EU) energy and emission reduction targets. Despite significant policy interventions, refurbishment rates remain low and the refurbishments that are carried out often do not meet the energy savings targeted by the EU, for example nearly Zero-Energy Building standards (nZEB). One of the key reasons for the lower than expected energy savings is that current refurbishment approaches tend to focus predominantly on energy efficiency improvements for individual buildings. The integrated energy systems perspective that can be leveraged at a multi-building scale – and is related to possible interactions between building sizes, scales, and the different systems – is not taken into consideration in most refurbishment concepts. The result are suboptimal renovation solutions which do not reach the full energy demand reduction potential of the refurbished building(s).

This paper introduces a methodology for a tool that aims to develop economically and environmentally optimal nZEB refurbishment concepts for multi-building scale refurbishment actions. Increasing the scale of a refurbishment from a single building to a multiple building, or even a building portfolio, will allow to generate economies of scale (both for solution and workforce cost) and facilitate the integration of renewable energy generation. The tool applies the Lifecycle Assessment (LCA) and Lifecycle Cost Assessment (LCC) methods, which makes it possible to optimize refurbishment concepts, both with respect to economic and environmental criteria. Thanks to a multidimensional optimization approach, based on an evolutionary algorithm that can automatically find the Pareto-boarder for a given design space, Pareto-optimal refurbishment concepts are generated. Refurbishment options presented this way can help housing companies prioritize refurbishment needs and actions in their building portfolios, as well as evaluate and select between different refurbishment approaches in line with overarching targets.

Keywords: multi-building perspective, refurbishment, energy efficiency, renewable energy generation, multidimensional optimization, LCA, LCC

1. INTRODUCTION

Buildings account for around 40% of the energy used in European countries. In order to increase the energy efficiency of buildings, decrease energy use and associated greenhouse gas emissions, European countries need to foster the retrofit of their building stock. This is a challenge considering the structure of the European building stock - over 35% of the buildings are more than 50 years old and therefore often do not adhere to current energy standards. The European Union has addressed this issue through the two key directives: the Energy Performance of Buildings Directive [1] and the Energy Efficiency Directive [2]. Through these directives the EU aims to introduce nearly Zero-Energy Building (nZEB) standards across all member states by 2020 and to put in place frameworks, fostering the refurbishment of the existing building stock. However, the current refurbishment rate is still stagnating at around 1% per year (opposed to the targeted 3% annually) and the majority of refurbishment actions performed so far do not meet the high energy demand reduction standard the EU aims for (i.e. nZEB standards).

Numerous decision support tools for building refurbishment exist already to help building owners and designers plan energy efficiency refurbishments. Nielsen et al. [3] and Ferreira et al. [4] give a comprehensive overview of the state of the art. They show that the majority of the existing tools focus on the technical performance estimation of refurbishment design alternatives generated by engineers. However, tools that support the generation of refurbishment design alternatives in line with concrete quantifiable targets beyond technical requirements (e.g.

economic and environmental targets) are lacking [3]. The goal setting phase is a crucial one, as indicators used by housing companies to evaluate different refurbishment alternatives vary significantly. Some decide based on purely economic-driven return on investment. Others might focus on spending their renovation budget as effectively as possible, taking into account also political and social targets. Consequently, refurbishment concepts that are purely technically driven lead to sub-optimal solutions.

There has been a large body of research in the recent decade on the optimization of building and refurbishment design. A comprehensive overview and review is given by Evins [5]. A lot of these optimization approaches are focused predominantly on technical and not enough on the economic and environmental aspects. This is not ideal, the more so, as even economic aspects housing companies would base their decisions on vary (e.g. only Investment cost vs. life cycle costing) and the calculation frameworks applied differ as well (discount rate, life cycle timespan, etc.). Thus, even optimized refurbishment design approaches that do not take into account the possible variety of indicators within one category will lead to sub-optimal refurbishment concepts.

In addition to this, building refurbishment approaches often do not aim at scale and do not take advantage of all the possible options for nZEB refurbishment design. Especially a joint application of both energy demand reduction and on site-energy generation (e.g. through PV or CHP plants) including the energy management between the two is often not considered. Such concepts increase in viability when going from single building to a multi-building scale, where demand fluctuations are less pronounced and therefore a higher share can be covered through on-site energy generation. Moreover, increasing the scope of the building refurbishment design increases the optimization potential, both in technical and economic terms (e.g. through economies of scale). Increasing the scale can therefore help housing companies get more value for their money, as well as prioritize and plan their refurbishment actions in line with an overarching target.

In this paper we present the methodological approach taken in the DREEAM project, which aims at addressing the issues raised above by developing a tool that can be used to develop strategies for large-scale refurbishment actions. We make use of the ongoing research in building design optimization, life cycle assessment (LCA) and life cycle costing (LCC) for the development of this building refurbishment assessment tool. The suggested methodology extends the design space of refurbishment design to include both the energy demand and supply side and combines this with the application of optimization routine to be used not just to single building refurbishment design but extending it to be used as part of the refurbishment concept development on a multi-building or portfolio scale. The optimization routine can be used for a multidimensional optimization of refurbishment concepts based on stakeholder-tailored environmental and economic indicators.

2. METHODOLOGY

The DREEAM tool is based on a modular structure. The main modules are: the energy module, and indicator assessment module, the optimization module, and different databases that serve as a basis for the performed calculation (see Figure 1). Firstly, the energy module calculates the energetic performance of the buildings through the application of established norm-based calculation methods (see below for details). Secondly, the output serves the indicator assessment module as an input to generate different economic and environmental indicators. Lastly, the indicators then serve the optimization module as a basis to evaluate and optimize the different refurbishment concepts. The tool makes use of a multidimensional evolutionary optimization algorithm, which automatically generates the Pareto-boarder for a given set of indicators. The output of the optimization module is a set of overarching refurbishment concepts for all assessed buildings which make up the Pareto-boarder. Each concept is a combination of refurbishment solutions for each building and each component of these buildings which can be further evaluated by the user and from which most applicable refurbishment options can be selected.

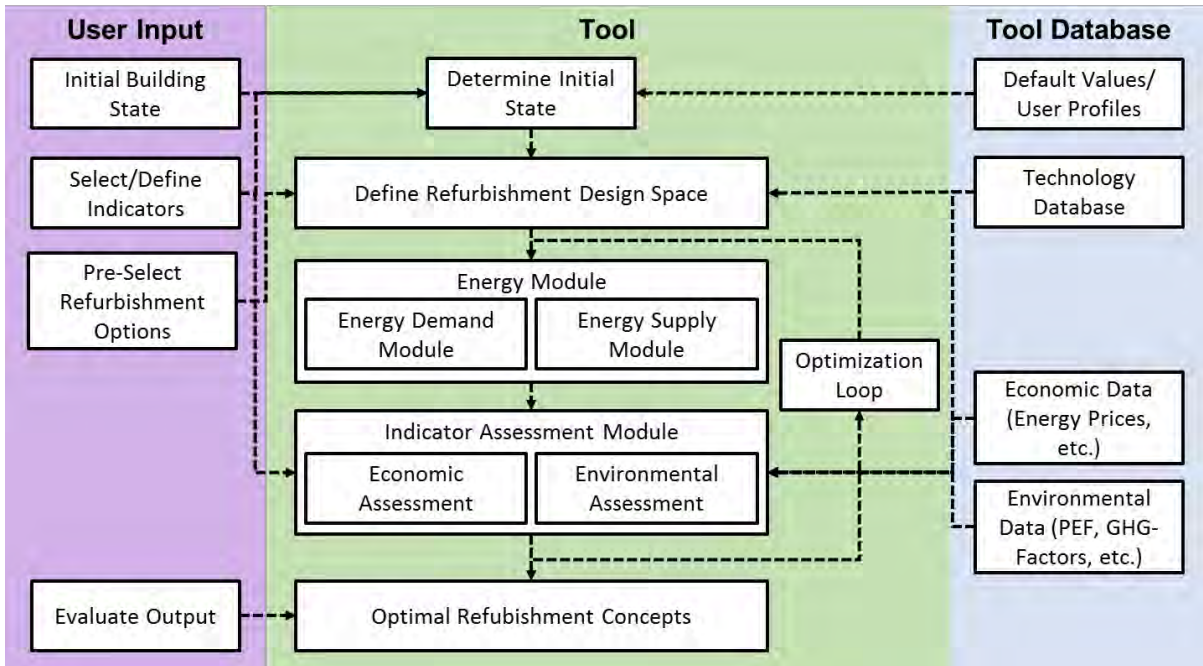

Figure 1: Overview of DREEM-tool structure

2.1 Energy module

The energy module consists of two main sub-modules, the energy demand module and an energy supply module. The energy demand module calculates the energy demand of the buildings, based on current norms and standards (see Figure 2). The heating and cooling demand is calculated, based on the simple hourly method of the EN 13790 [6]. These standard calculation methods were chosen instead of more detailed dynamic models (e.g. EnergyPlus), due to the fact that the optimization module will have to run many iterations of the model, and the computational demand low for a single iteration should be kept low. The energy demand module is complemented with a module that calculates the on-site energy supply through photovoltaic modules or combined heat and power. Through the combination of these modules, the energy module calculates the energetic performance of the building in its current state or for a potential refurbishment alternative. The output of this module is used by the indicator assessment module to calculate the running costs and environmental impact of the building.

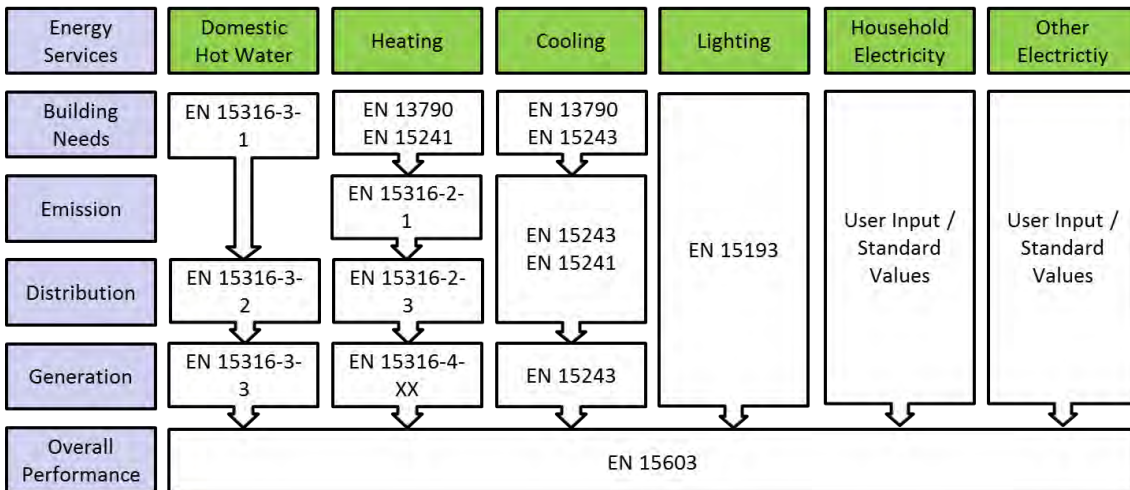

Figure 2: Overview of the building energy demand module and the European standards used for calculation

2.2 Technology database

The technology database is a key part of the tool, in that it constitutes the basis from which the refurbishment concepts can be developed. The database is structured according to the different building components and systems (see Figure 3). For each component the database lists different refurbishment solutions and for each of these solutions it then contains a detailed list of the materials and work needed to install this technology beside the technical performance data. This data is generated using national construction cost catalogues such as [7] for Sweden, [8] for Germany or [9] for Spain and France. The material information is then linked to the data from the database ecoinvent [10], so that the embodied environmental impact of the materials used is also assessed. The cost and environmental data included in the database is then used by the assessment module to assess the refurbishment solutions against economic and environmental indicators.

Building Components		Refurbishment Solutions		Material and Labour Breakdown						
Passive Components	Reference Unit	D	Solution	Insulation	D	Materials	Reference Material Unit	Cost [SEK]	Labour [h]	Labour Costs [SEK]
1. Outer walls against air	m ² surface area	1.1.	External Insulation		1.	Scaffolding	1.15m ²	33	0.18	35.1
2. Outer walls against earth	m ² surface area	1.1.1.	Brickwall	50 mm	2.	Façade plaster	1m ²	0	0.4	78
3. Basement floor	m ² surface area	1.1.1.	Brickwall	80 mm	3.	Cardboard, demolished	1m ²	0	0.02	3.9
4. Floors against unheated	m ² surface area	1.1.1.	Brickwall	100 mm	4.	Lock panel	1m ²	105.4	0.78	152.1
5. Ceiling against unheated	m ² surface area	1.1.1.	Brickwall	120 mm	5.	Lath	3m	8.45	0.03	5.85
6. Flat roof	m ² surface area	1.1.1.	Brickwall	150 mm	6.	Gypsum board, windshield	1m ²	40.95	0.14	27.3
7. Tilted roof	m ² surface area	1.1.1.	Brickwall	170 mm	7.	Mineral wool board	1m ²	41.6	0.09	17.55
8. Windows in Wall	m ² surface area	1.1.2.	Sandwich	50 mm	8.	8.45x70 Bars	3.5m	8.9	0.08	15.6
9. Windows in Tilted Roof	m ² surface area	1.1.2.	Sandwich	80 mm	9.	Plank wall, retained	1m ²	0	0	0
10. Windows in Flat Roof	m ² surface area	1.1.2.	Sandwich	120 mm	10.	Plastic foil incl. Tape	1m ²	7.55	0.09	17.55
		1.1.2.	Sandwich	150 mm	11.	Gypsum board	1m ²	40.7	0.16	31.2
		1.1.2.	Sandwich	200 mm						
Active Components	Reference unit	1.1.3.	Wooden Facade	45mm						
11. Heating System	kW _{Thermal}	1.1.3.	Wooden Facade	70 mm						
12. Heat Distribution	kW _{Thermal} or m ²	1.1.3.	Wooden Facade	120 mm						
13. Ventilation	m ³ /h	1.1.3.	Wooden Facade	170 mm						
14. Cooling System	kW _{Cooling}	1.1.3.	Wooden Facade	220 mm						
15. Lighting	m ² floor area	1.2.	Internal insulation							
16. Shading	m ² window	1.2.1.	Wooden Substructure	45 mm						
17. Solarthermal	m ² collector	1.2.1.	Wooden Substructure	70 mm						
18. Storage Tank	m ³ tank volume	1.2.1.	Wooden Substructure	120 mm						
19. PV	kW _{peak}	1.2.2.	Steel Substructure	45 mm						
20. Control Systems	kWh _{Capacity}	1.2.2.	Steel Substructure	70 mm						
21. Battery Systems	kWh _{Capacity}	1.2.2.	Steel Substructure	120 mm						

Figure 3: Structure of the component specific technology database listing labour and material cost

2.3 Assessment module

The assessment module generates the indicators that can be used to evaluate different refurbishment options during the optimization routine as well as evaluate the generated output of the optimization module. The assessment module is divided into two submodules, an economic assessment module and an environmental assessment module.

The economic module applies a lifecycle costing (LCC) assessment methodology based on [11], which can calculate the overall life cycle costs as well as other economic indicators such as the Return on Investment (ROI) or the Net-Present Value (NPV). The different cost components are structured according to [11] (see Figure 4). Investment costs are calculated, based on the input out of the technology database which includes labour, material and additional costs. Other costs such as professional fees (planning costs), taxes and profit margins depend on the optimization scenario and can be adapted by the user. The annual costs are calculated based on replacement and running costs. The running costs are based on operational, maintenance and energy costs. The energy costs are calculated based on energy prices included in the tool database and the output of the energy module.

The environmental assessment module applies a simplified lifecycle assessment (LCA) calculating the environmental impact of the current status of the refurbishment approach. Currently only the primary energy demand and the greenhouse gas emission are assessed. Adding further impact categories such as e.g. abiotic depletion potential (ADP) might be considered at a later stage of the tool development. The assessment is carried out by evaluating both the impact of the building use phase through the output of the energy module as well as the embodied impact in the materials. The impact of the use phase is assessed by multiplying the energy consumption with GHG-Emission and primary energy factors of the energy carrier used in the building. The embodied impact is calculated by multiplying the materials used in the refurbishment with factors from the ecoinvent database [10].

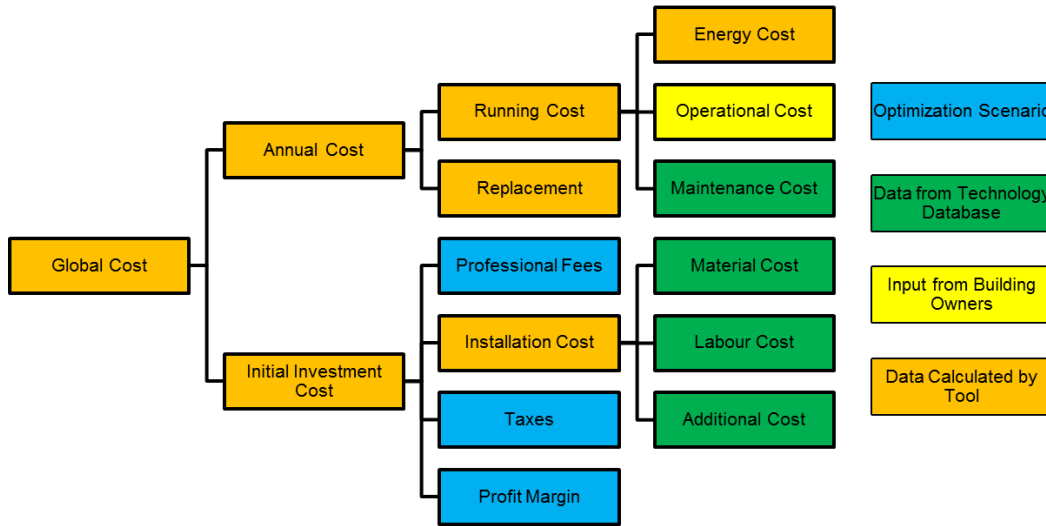

Figure 4: Cost Structure applied in the DREEAM-tool (adapted from [11])

Table 1 shows a list of currently implemented economic and environmental indicators the user can choose from. The tool has also the possibility to add new indicators based on the output of the energy module as well as currently implemented assessment indicators. Especially the combination of both environmental and economic indicators might be of interest to future users (e.g. GHG-Emission savings per Investment Cost). This enables the user to optimize the refurbishment concept beyond best economic solution and evaluate options on how to achieve additional GHG-Emission savings through additional investment. This enables the housing companies to evaluate how much additional investment is needed from subsidies or other funding sources in order to reach a given nZEB standard for their buildings.

Indicators	Calculation
Environmental Indicators	
Final Energy Demand	$E_{final} = \left(\sum_{es = \text{energy service}} E_{final,es} \right) - E_{production}$
Final Energy Savings	$E_{final,saving} = \frac{E_{final,SQ} - E_{final,RC}}{E_{final,SQ}}$
Electricity Production	$E_{production} = \sum_{p = \text{production system}} E_p$
GHG Emissions	$GHG = \sum_{ec = \text{energy carrier}} E_{ec} \cdot GHG_{Fec} + GHG_{embodied}$
Primary Energy	$PE_{tot} = \sum_{ec = \text{energy carrier}} E_{ic} \cdot PEF_{ec,tot} + PE_{embodied,tot}$ $PE_{nonrenew} = \sum_{ec = \text{energy carrier}} E_{ec} \cdot PEF_{ec,nonrenew} + PE_{embodied,nonrenew}$
GHG Emission Savings	$GHG_{saving} = \frac{GHG_{SQ} - GHG_{RC}}{GHG_{SQ}}$
Primary Energy Savings	$PE_{tot,saving} = \frac{PE_{tot,SQ} - PE_{tot,refurbished}}{PE_{tot,SQ}}$ $PE_{nonrenew,saving} = \frac{PE_{nonrenew,SQ} - PE_{nonrenew,RC}}{PE_{nonrenew,SQ}}$
Economic Indicators	

Investment Costs	$C_{Investment} = C_{Material} + C_{Labour} + C_{Additional} + C_{Fees} + C_{Taxes} + C_{Margin}$
Running Costs	$C_{Running} = C_{Maintenance} + C_{Operational} + C_{Energy}$
Total Life Cycle Cost	$LCC = C_{Investment} + \sum_{t=1}^{calculation\ period} C_{Running} + C_{Replacement}$
Net Present Value	$NPV = \sum_{t=1}^{calculation\ period} \left(\frac{C_{Earnings} - C_{Running} - C_{Replacement}}{(1+r)^t} \right) - C_{Investment}$
Internal Rate of Return	$NPV = 0$ $= \sum_{t=1}^{calculation\ period} \left(\frac{C_{Earnings} - C_{Running} - C_{Replacement}}{(1+IRR)^t} \right) - C_{Investment}$
Return On Investment	$ROI = \frac{(C_{Earnings,SQ} - C_{Running,SQ}) - (C_{Earnings,RC} - C_{Running,RC})}{C_{Investment}}$
Cost Savings	$C_{savings} = \frac{C_{Running,SQ} - C_{Running,RC}}{C_{Running,SQ}}$

Table 1: Selection of the main Indicators currently implemented in the Tool from which the user can choose from

2.4 Optimization module

The optimization module makes use of the implementation of the evolutionary optimization algorithm NSGAI (Non-dominated Sorting Genetic Algorithm) [11]. Evolutionary algorithms such as NSGAI are widely employed in the field of energy efficient building design [5]. The algorithm iteratively generates and evaluates different refurbishment options and thereby searches for the Pareto-boarder based on the indicators selected by the user giving as an output the solutions that make up the Pareto-boarder. A more detailed description of evolutionary optimization algorithms and how they are used in building design is given in [5]. Next to optimization objectives, the user can also define boundary conditions, which constrain the optimization routine for a component (e.g. by defining a maximum insulation thickness that can be applied to a certain component due to space limitations), between components (e.g. choosing different insulation thicknesses for connected components such as neighbouring walls) or on a building level (e.g. by defining a minimum building standard that must be reached). While some of this logic can be included in the tool, a feasibility check and selection process of the output generate by an expert will still be necessary.

3. CONCLUSION

This paper presents the initial methodological framework of the DREEAM tool which is currently being developed into a decision support tool for housing companies. The methodology is based on the integration of building energy demand modelling in combination with LCA and LCC methodologies and an optimization approach. The tool is aimed for supporting the refurbishment process in the early design stage from goal setting to generation and evaluation of aligned design alternatives through the optimization module. By designing the tool for the use on a multi-building or portfolio scale, the tool is aimed for the development of refurbishment concepts that leverages the synergies between buildings and making use of economies of scale. The generated results should therefore help housing companies develop a refurbishment strategy for multiple-buildings or even their whole portfolio.

The next steps will be to advance the development of the tool and an application in three different building sites across Europe (Sweden, Italy and UK). This development will focus on advancing the functionalities presented in this papers, generating a graphical user interface and integrating cost databases of different countries.

AKNOWLEDGEMENTS

This project has received funding from **the European Union's Horizon 2020 research and innovation programme** under the Grant Agreement no 680511. This document does not represent the opinion of the European Union, and the European Union is not responsible for any use that might be made of its content..

REFERENCES

- [1] European Commission. (2010). Directive 2010/31/EU of the European Parliament and of the Council of 19 May 2010 on the energy performance of buildings. June.
- [2] European Commission. (2012). Directive 2012/27/EU of the European Parliament and of the Council of 25 October 2012 on energy efficiency. November.
- [3] Nielsen, A.N. et al., 2016. Early stage decision support for sustainable building renovation e A review. *Building and Environment*, 103, pp.165–181.
- [4] Ferreira, J., Pinheiro, M.D. & Brito, J. De, 2013. Refurbishment decision support tools : A review from a **Portuguese user's perspective**. *Construction and Building Materials*, 49, pp.425–447.
- [5] Evins, R. (2013). A review of computational optimisation methods applied to sustainable building design. *Renewable and Sustainable Energy Reviews*, 22 (2013): 230-245.
- [6] European Committee for Standardization. Energy performance of buildings –calculation of energy use for space heating and cooling (EN 13790:2007); 2008.
- [7] WIKELLS (2015). "Sektionsfakta ROT 15/16", available at: http://www.wikells.se/sf_rot.aspx
- [8] SIRADOS (2015). "Baupreise.de", available at: <http://www.baupreise.de>
- [9] CYPE INGENIEROS (2015). "Generador de Precios. Rehabilitación. España", available at: <http://www.generadordeprecios.info/rehabilitacion>
- [10] Ecoinvent 3.1 (2014) Ecoinvent data version 3.1. Swiss Centre for Life Cycle Inventories, Dübendorf, Switzerland. website: www.ecoinvent.ch
- [11] EUROPEAN COMMISSION (2012). "COMMISSION DELEGATED REGULATION (EU) NO 244/2012 OF 16 JANUARY 2012 SUPPLEMENTING DIRECTIVE 2010/31/EU", European Commission
- [12] K. Deb and A. Pratap and S. Agarwal and T. Meyarivan, "A Fast and Elitist Multiobjective Genetic Algorithm: NSGA-II", *IEEE Transactions on Evolutionary Computation*, 2002.

Development of Regenerative Design Principles for Building Retrofits

William James CRAFT, Lan DING, Deo PRASAD

a University of New South Wales, Australia, w.craft@unsw.edu.au

b University of New South Wales, Australia, lan.ding@unsw.edu.au

c CRC for Low Carbon Living, Australia, d.prasad@unsw.edu.au

ABSTRACT

Regenerative design within the built environment arises from the need to shift from the current fragmented sustainability approaches of ‘doing less harm’, towards a whole system that actively co-evolves with the living world around us. This idea is starting to become well established in new developments, but this paper will explore how regenerative design can be applied specifically to existing buildings. A ‘proactive’ retrofit approach is proposed to explore how net-positive, restorative and regenerative concepts can be integrated into building retrofit design process. A regenerative design model is developed to establish a set of regenerative design principles for building retrofits. This model will enable the extraction of key interactions between physical, human and natural systems in the built environment to emphasise how a single building retrofit can positively interact with its surrounding systems. Identifying emerging technologies and building case studies to address these key interactions provides clear and practical guidance for developing a set of regenerative design principles to achieve these ‘proactive’ retrofit outcomes.

Keywords: design process, building retrofit, regenerative design

1. INTRODUCTION

To move beyond current ‘mechanistic’ approaches to sustainable design and development, du Plessis and many others suggest that we need a fundamental shift in worldview towards regeneration (du Plessis, 2012). The prevailing fragmented sustainability approaches are grounded in a technological driven mindset which reduces a system to its parts to achieve greater efficiency. The direction of current building retrofits exemplifies this by reducing a building to its components with the aim of greater cost and resource efficiency. While this has an important role within the retrofit process, Figure 1 highlights that without this fundamental transition towards regeneration, it is impossible to go beyond simply slowing the rate of depletion of degradation (Mang & Reed, 2012). Making this transition requires moving away from fear-based approaches with a focus on scarcity of resources, uncertainty and sacrifice, towards a positive model which aligns humanity within a larger community of life (Hes & du Plessis, 2015).

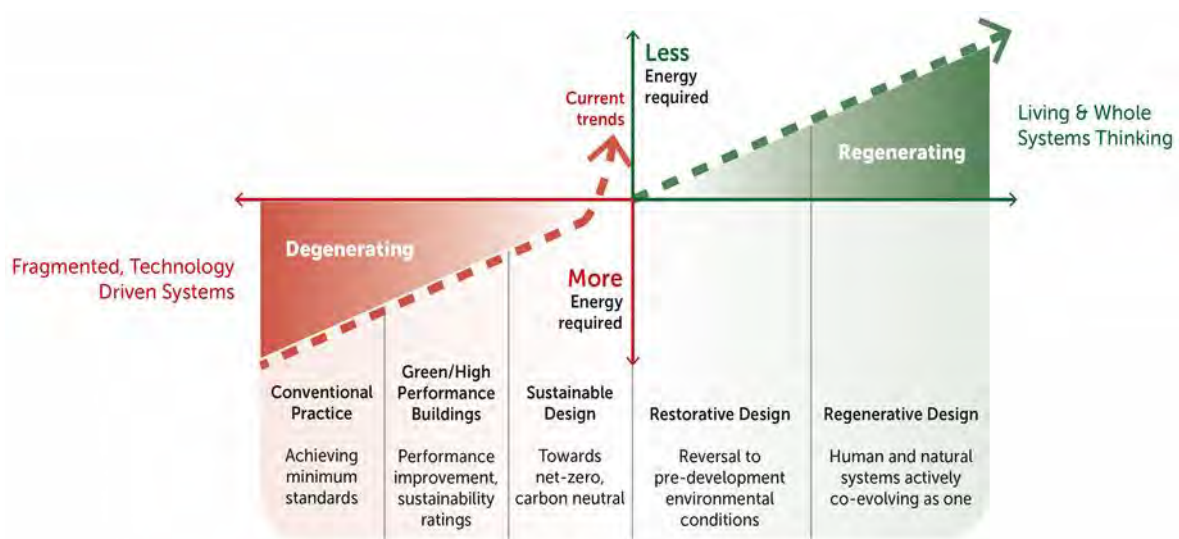

Figure 1: Range of sustainability approaches (Developed from Reed, 2007)

Regenerative design can be roughly defined as the ‘reconnection of human aspirations and activities with the evolution of natural systems – essentially co-evolution (Mang & Reed 2012).’ Within the context of building retrofits, it is therefore crucial that the role of the building itself be to add value to a system in which it is part (Cole & Fedoruk, 2014). So for a building retrofit to shift towards regeneration, more emphasis needs to be placed on a design process that focuses on the evolution of the whole system and less on the individual building or components. Despite this, Bill Reed suggests that the sustainability approaches presented in Figure 1 are a progression and not exclusive as all practice levels are necessary to achieving this change towards regeneration (Reed, 2007).

Regenerative design concepts are becoming well established in the development of frameworks and tools such as the REGEN tool (Svec et al., 2012), and the LENSES framework (Plaut et al., 2012), alongside existing frameworks such as the Living Building Challenge and One Planet Living. These frameworks provide clear and detailed guidance for achieving regenerative systems and outcomes, but the resulting designs predominantly seem to be new buildings or developments. Whilst this has produced some very promising outcomes, it is critical that building retrofits start to make this shift towards regeneration as the majority of buildings which will exist in developed countries by 2050 are already built (UNEP, 2009).

This paper will explore how regenerative concepts can start to be applied to building retrofits. A ‘proactive’ retrofitting approach is proposed which seeks to integrate net-positive, restorative and regenerative concepts into the intervention design process. A regenerative design model which explores the interactions between physical, human and natural systems is also proposed as a means of developing a set of regenerative design principles for building retrofits. By extracting the key interactions between these systems, the retrofit focus can now be on the positive interactions a building can have with its surroundings. Emerging technologies and building case studies will be identified to address these key interactions in order to provide clear and practical guidance to achieving ‘proactive’ retrofit outcomes.

2. REGENERATIVE DESIGN MODEL FOR BUILDING RETROFITS

2.1 Towards ‘proactive’ retrofitting

Figure 2 highlights the four levels of work in which every living system must continually engage to increase its vitality, viability and capacity for evolution (Mang & Reed, 2012). This ‘Levels of Work’ framework is applied here to propose a ‘reactive’ and ‘proactive’ approach to retrofitting. The below-the-line concepts of operating and maintaining deal only with what is in existence whilst the above-the-line concepts of improving and regenerating explore the creativity and potential in relationship to the larger system (Mang & Reed, 2012). Conventional building retrofits that are focused on efficiency and cost are simply ‘reacting’ to a negative event or circumstance, and are therefore below-the-line. A ‘proactive’ building retrofit seeks to integrate net-positive, restorative and regenerative concepts by considering the positive interactions with its surroundings. Despite this, what is crucial to a system’s ongoing health and capacity for evolution is its ability to work at all four levels (Hes & du Plessis, 2015). This means that reducing a building’s ‘negatives’ is still crucial to the retrofit process, and in some cases can provide the foundation on which to expand positive interactions with its surrounding systems.

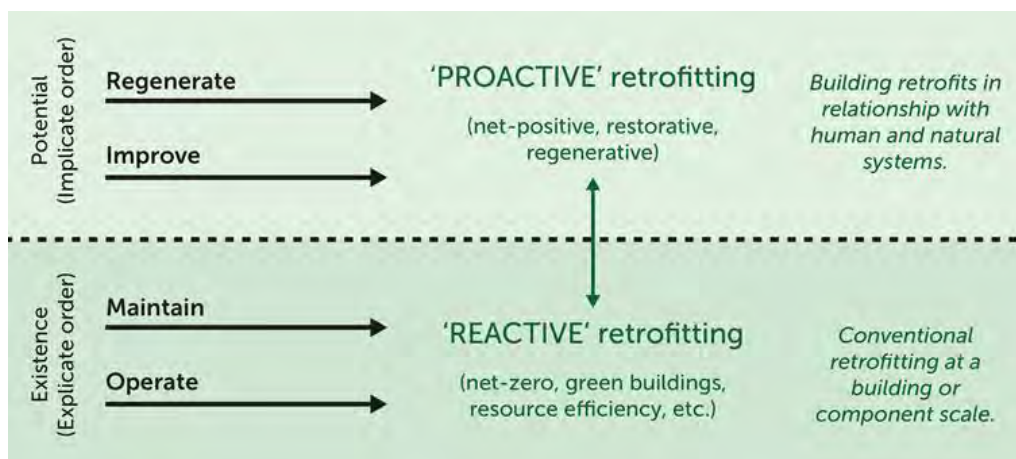

Figure 2: ‘Proactive’ and ‘Reactive’ retrofitting (Developed from original by Charles Krone, in Mang & Reed, 2012)

2.2 Preliminary regenerative design model

Achieving proactive retrofit outcomes requires not only an understanding of the existing building so as to improve resource efficiency, but a consideration of how this could enhance social connections and strengthen a connection nature. Figure 3 highlights the preliminary regenerative design model developed in this research. This model explores how an energy efficient building retrofit could also improve the health of its occupants and enhance local ecosystems. The **cost-benefit is also a crucial aspect of a 'proactive' retrofit, but as it is heavily influenced by contextual factors it will be discussed later in this paper.** Identifying and extracting the key interactions between physical, human and natural systems provides a strong foundation on which to develop a set of regenerative design principles by emphasising the positive impact a building retrofit can have on its surroundings.

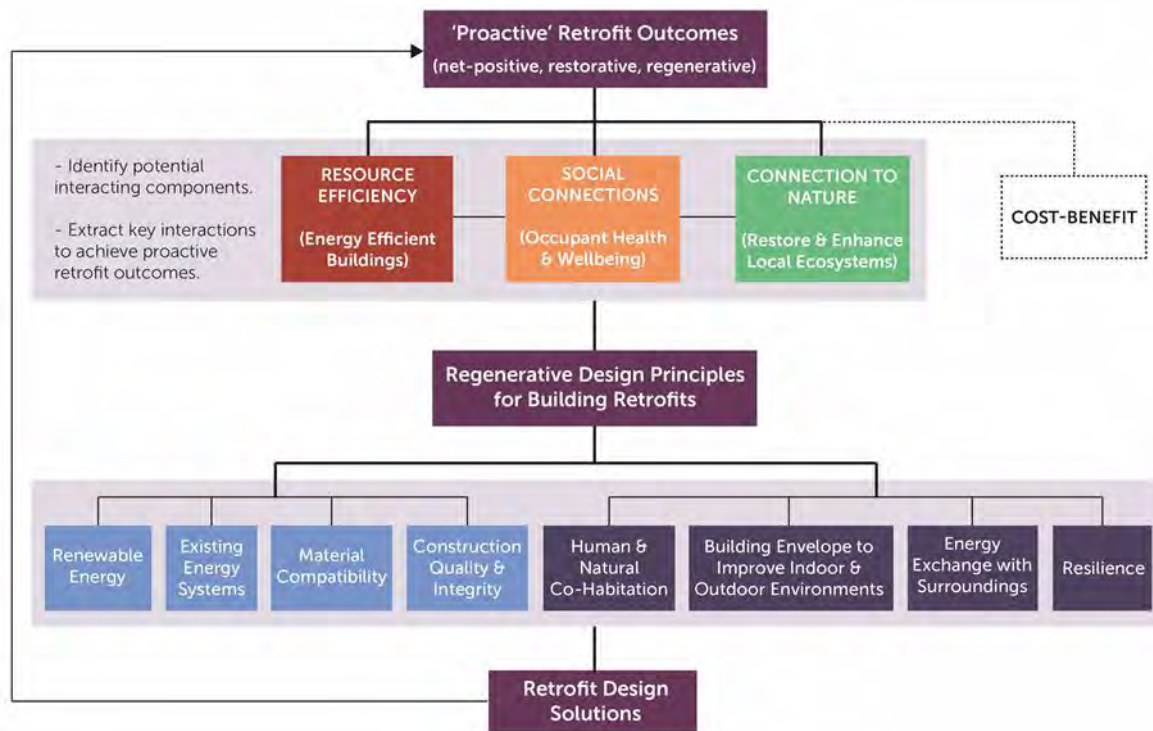

Figure 3: Preliminary regenerative design model for building retrofits

3. DEVELOPMENT OF REGENERATIVE DESIGN PRINCIPLES FOR BUILDING RETROFITS

The development of regenerative design principles for building retrofits is primarily enabled through exploring these key interactions between physical, human and natural systems. Identifying suitable emerging technologies and building case studies exploring these key interactions will ensure these principles are innovative as well as feasible. This first involves identifying and extracting a key interaction between physical, human and natural systems to **achieve a 'proactive' retrofit outcome.** An interaction between all three of these dimensions will enable a building to not only improve its own performance but also the health of its occupants and its surrounding ecosystems. Relevant examples can then be explored to achieve this key interaction. This involves consideration of how and where these strategies and technologies can be integrated specifically for a building retrofit.

This process will provide the basis to develop a set of regenerative design principles for building retrofits but before they can be **applied to a specific building, a deeper understanding of its 'place', and the cost and risk of retrofitting must be considered.** An understanding of 'place' as well as the people and technologies already present will highlight the major issues of a specific building. Ultimately this will enable designers to make informed decisions on the appropriate retrofit principles, strategies and technologies to address these contextual-based issues. For the purposes of this paper, one key interaction will be extracted to briefly demonstrate this process highlighted in Figure 4.

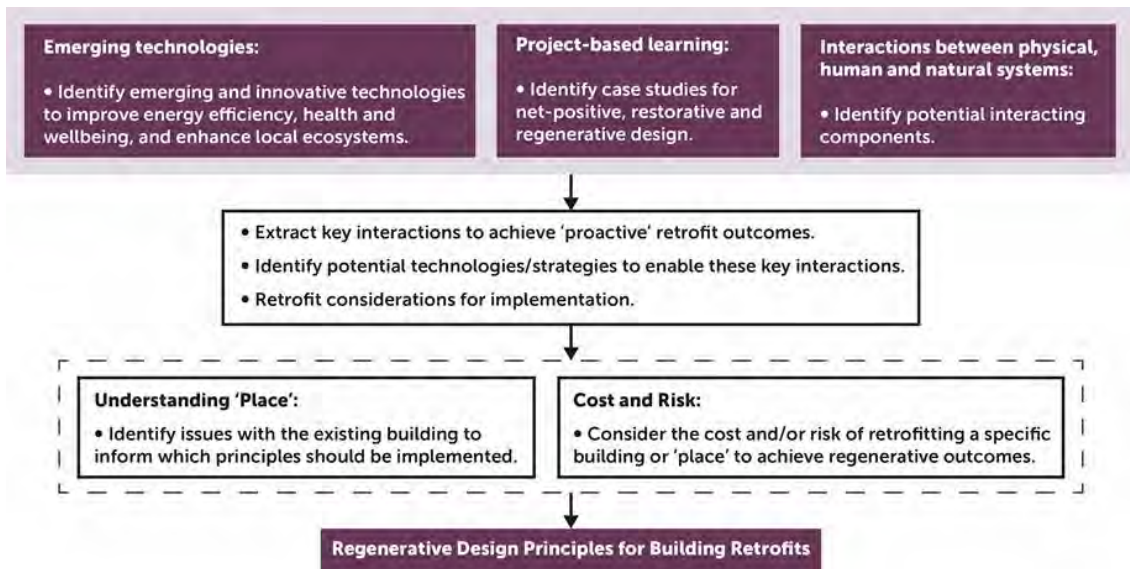

Figure 4: Development of regenerative design principles

3.1 Development of principles through the interactions between physical, human and natural systems

This paper will briefly explore the potential interactions of a building's façade so as to improve energy efficiency and occupant health, and restore local ecosystems. Current façade retrofits are predominantly focused on improving energy efficiency and/or occupant health and wellbeing, with some exploring the connections between the two. Figure 5 highlights that achieving 'proactive' outcomes for a building façade retrofit involves extending this relationship beyond energy efficiency and occupant health to the restoration of local ecosystems. For example, this could involve exploring how a façade retrofit material choice could reduce energy demand, improve thermal comfort and mitigate the surrounding microclimate.

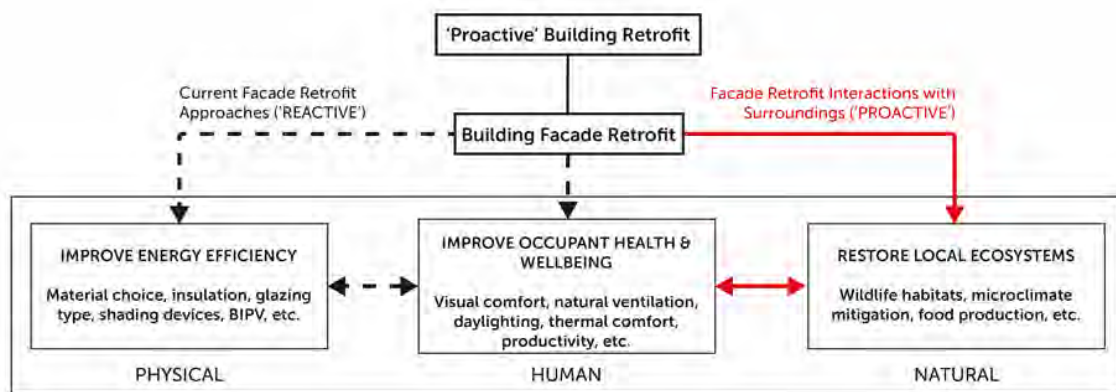

Figure 5: Necessary interactions for a building façade retrofit to achieve 'Proactive' outcomes

By extracting a key interaction which addresses the physical, human and natural systems, the building retrofit focus can expand beyond its site boundaries to positively impact its surroundings. In this way, retrofitting a building's façade can be seen as an opportunity to improve both indoor and outdoor environments. The development of a regenerative design principle entitled 'building envelope to improve indoor environment and restore local ecosystems' therefore has the potential to achieve 'proactive' outcomes for a façade retrofit.

3.2 Examples to inform regenerative design principles

The following examples are briefly introduced here to explore the necessary façade interactions for achieving the principle 'building envelope to improve indoor environment and restore local ecosystems' (Figure 5). In doing so, these examples will provide innovative and feasible solutions for how a façade retrofit can start to improve energy efficiency and occupant health and wellbeing, as well as restore its surrounding environment.

The success of current façade designs, both retrofits and new developments, lies in the ability to link energy efficiency to occupant health, wellbeing and productivity. While this interaction between energy and health may not be 'proactive' in its outcomes, it is still a crucial aspect of retrofitting a building's façade. In some cases this can provide the foundation on which to expand a façade's positive impacts to its surroundings. Deloitte's Amsterdam office, named the 'Edge', is one building which explores these interactions between energy efficiency and occupant wellbeing. The roof and south façade of this building incorporate the largest array of PV panels of any European office building (BREEAM, 2016). This BIPV façade (Figure 6a) assists in powering all smartphones, laptops and electric vehicles connected to this smart building (Marks, 2015), resulting in improved occupant productivity. The Edge also improves the health of occupants upon entry via a fifteen-storey glass atrium (Figure 6b) which provides steady northern daylight and visually connects occupants to the surrounding landscape (BREEAM, 2016). While this building was not a retrofit, the underlying ideas and design intentions behind these façade systems could be adapted into the retrofit process.



Figure 6: (a) BIPV on the South Façade of the 'Edge' (Source: Ossip van Duivenbode);
(b) Fifteen-Storey North-Facing Entrance Atrium (Source: Raimond Wouda).

Although the current approaches to façade retrofits present some promising outcomes for energy and health, the principle 'building envelope to improve indoor environment and restore local ecosystems' requires additional consideration of the external environment. Microclimate mitigation through the use of retro-reflective (RR) materials is one way a façade can start to extend these interactions to restore its surrounding ecosystems. Rossi et al. assessed the angular reflectance of RR films for different angles and concluded that RR materials could be effectively applied as a coating on building envelopes to reduce the circulating energy into the urban canyon (Rossi et al., 2015). Yuan et al. took this one step further to develop a more durable RR material with a glass covering and discovered that RR materials can successfully increase the albedo of urban canyons as well as reduce a building's thermal loads (Yuan et al., 2015). Another way a façade retrofit can restore surrounding ecosystems is through the provision of wildlife habitats. In addition to the already proven benefits of green walls and facades, artificial wildlife habitats integrated into the building envelope have the potential to increase local biodiversity and challenge the traditional rejection of wildlife in an urban context. Lamphier explores this idea by developing a façade system which is specifically designed to attract birds to enhance the dialogue between buildings, occupants and wildlife. This modular cladding system (Fig. 7) offers shading to the building and provides artificial habitats for pigeons while maintaining a high aesthetic quality (Stokes & Chitrakar, 2012).

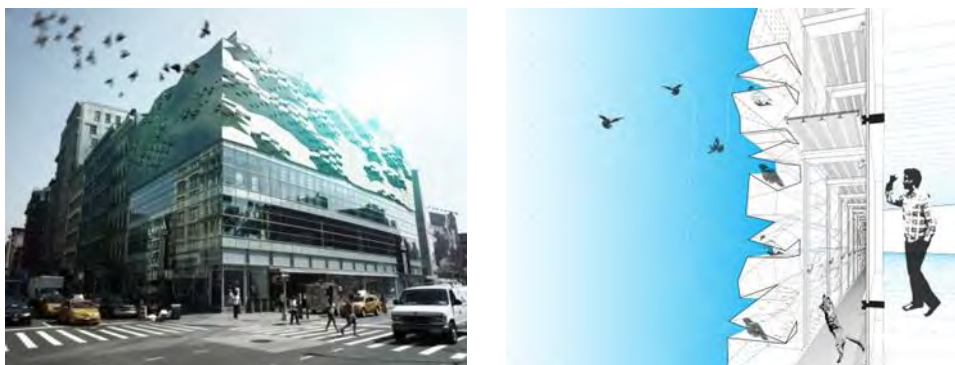

Figure 7: Artificial habitat modular façade system (Source: Trevor Lamphier)

These examples have briefly shown that if we start retrofitting façades towards achieving this design principle, there can be multiple health and performance benefits for physical, human and natural systems within the built environment. More importantly, introducing these examples has emphasised that we already have the means and technology to achieve the necessary interactions for a 'proactive' façade retrofit. What is required to make this transition to regeneration is therefore not a change of techniques but a change of mind (Mang & Reed, 2012).

4. DISCUSSION AND FUTURE WORK

In developing a regenerative design principle for building façade retrofits, this paper has highlighted that we already have the ability to start designing within this regenerative worldview. This idea that a change of mind-set is of more importance than specific techniques, strategies or technologies emphasises that the true benefit of these design principles is in the way they could promote a new or 'proactive' approach to building retrofits. Although the brief examples introduced in this paper have shown specific strategies and technologies which can support this principle, it is the fundamental design intention of a façade positively impacting its surroundings that enables this principle to have a 'proactive' outcome.

This proposed regenerative design model will enable further development of a set of design principles for building retrofits to achieve 'proactive' outcomes. It should be noted that these regenerative design principles will be further developed through a qualitative rather than quantitative approach. Ultimately these principles will provide high-level guidance to designers in order to expand rather than prescribe potential retrofit solutions. Once these regenerative design principles are developed, a process model will be established to guide the application of these principles into practical retrofit solutions. This will involve further consideration of a building's 'place' as well as the people and technologies already present. By doing so, a designer can then make an informed decision about which retrofit principles and strategies are appropriate to address the issues of 'place' and add positive value to the surrounding environment.

REFERENCES

- [1] BREEAM, 2016. The Edge, Amsterdam, BREEAM [online]. Retrieved from: <http://www.breeam.com/index.jsp?id=804> [Retrieved on 28 Sept 2016].
- [2] Cole, R. J. and Fedoruk, L., 2014. Shifting from net-zero to net-positive energy buildings. *Building Research & Information*, 43(1), 111-120.
- [3] Du Plessis, C., 2012. Towards a regenerative paradigm for the built environment. *Building Research & Information*, 40(1), 7-22.
- [4] Hes, D. and Du Plessis, C., 2015. *Designing for Hope: Pathways to Regenerative Sustainability*, Routledge, New York.
- [5] Mang, P. and Reed, B., 2012. Designing from place: a regenerative framework and methodology. *Building Research & Information*, 40(1), 23-38.
- [6] Marks, P., 2015. Office of coded light. *New Scientist*, 227(3034), 18.
- [7] Plaut, J. M., et al., 2012. Regenerative design: the LENSES Framework for buildings and communities, *Building Research & Information*, 40(1), 112-122.
- [8] Reed, B., 2007. Shifting from 'sustainability' to regeneration. *Building Research & Information*, 35(6), 674-680.
- [9] Rossi, F., et al., 2015. Retroreflective façades for urban heat island mitigation: Experimental investigation and energy evaluations. *Applied Energy*, 145, 8-20.
- [10] Stokes, M. and Chitrakar, R.M., 2012. 'Designing 'other' citizens into the city: Investigating perceptions of architectural opportunities for wildlife habitat in the Brisbane CBD', paper presented at the QUThinking Conference: Research and Ideas for the Built Environment, Brisbane, 9 November.
- [11] Svec, P., et al., 2012. REGEN: toward a tool for regenerative thinking, *Building Research & Information*, 40(1), 81-94.
- [12] United Nations Environment Programme, 2009. *Buildings and Climate Change: Summary for Decision-Makers*.
- [13] Yuan, J., et al., 2015. Development of a retro-reflective material as building coating and evaluation on albedo of urban canyons and building heat loads. *Energy and Buildings*, 103, 107-117.

Passive Building: Energetic Refurbishment of a Secondary School

Antonio FRATTARI^a, Irene FERRO^b

^a University of Trento, Italy, antonio.frattari@unitn.it

^b University of Trento, Italy, irene.ferro89@gmail.com

ABSTRACT

The Department of Civil, Environmental and Mechanical Engineering (DICAM) of the University of Trento (UNITN) has developed an analysis procedure finalized to the school buildings energy retrofitting. For this experimental **project was identified the high school “Istituto Floriani”, located in Riva del Garda (Italy), as case study to verify the developed methodology.**

The procedure consists on the analysis of the energy behaviour of the whole existing building and the consequent design solutions for the retrofit of the building envelope and the building energy systems. The aim of these possible solutions is the improvement of the living comfort and of the energy efficiency too.

The methodology of this procedure was divided in five steps:

- Monitoring of thermal comfort and energy consumption of the building.
- Propose of construction solutions to improve the energy efficiency of the whole building.
- Testing of the predicted solutions through the Passive House Planning Package (PHPP software) to reduce the annual heating demand (< 20 kWh/m²y) and improve the living comfort of the school building.
- Preliminary project of the energy retrofit solutions.
- Executive project.

The preliminary project is ended. It involved, a large number of **operators as students and teachers of “Istituto Floriani” coordinated by the DICAM researchers at the different steps of research activity.** The DICAM researchers, coordinated by Professor Antonio Frattari, devised the scientific methodology and supervised the whole project especially: the monitoring, the design of the constructive details, the energetic analysis and the final design work **aiming to optimize the financial and energy convenience of reclamation.** The experts of the “Provincial Agency for Water Resources and Energy (APRIE) of the Autonomous Province of Trento (PAT)” have been involved in the project to define the feasibility of energy retrofit operations and the financing.

Keywords: deep building renovation, energy saving, passive house

1. INTRODUCTION

Old and inefficient buildings have been identified as one of the biggest contributors to energy wastage in the EU. **Improving energy efficiency is one of the pillars of the EU's policy response to addressing the challenges of climate change and the reduction of greenhouse gas emissions.**

The good news is that in the past 25 years, significant progress has been made in the development of new building with very low heating demand. Good experience with passive house buildings was one reason for the European Commission to state the Nearly Zero Energy Building (NZEB) as the goal in the second decade of the 21st century. The real challenge now is the existing building stock – mainly built during times where energy seemed to be abundant and cheap and efficient components were not available on the market, these buildings consume between 150 and 250 kWh/(m²a), about a factor 10 more than well – designed NZEBs.

Therefore, existing buildings can be improved during a thorough retrofit process. All the solutions, which have **been proven successful in the construction of new NZEB's can also be applied for retrofits.** Through a deep analysis on the Italian building scenario it was defined that a huge amount of residential and non-residential buildings need real renovations, including energy efficient measures. Many schools, built before the '50s and currently used, have a significant effect on energy consumption, but a much more relevant impact on the level of thermal comfort of the occupants.

2. CASE STUDY

However, most of the existing schools have been constructed without any concern for the comfort of the occupants and the adaptation of the buildings to the local climate. The quality of indoor environment has a great influence on **the students' learning performance and ability** to learn in indoor spaces. It is necessary to improve the quality of these schools, to provide healthy and comfortable study spaces for the students with the use of passive design strategies to minimize the energy loads of the buildings as the school buildings are one of the major energy consumers. **This research study is a Secondary school "Istituto Floriani" located in Riva del Garda, in the north of Italy.** The methodology developed for the case study was divided into two main phases: the analysis of the existing building conditions and the consecutive renovation project in relation to different constructive and engineering solutions to promote and improve energy efficiency. The entire work plan was drawn up on two years and based on a series of steps that started from the monitoring of thermal and environmental humidity conditions up to the definition of the construction details for the retrofit measures according to criteria of minimum energy consumption.

The case study (Figure 1) is placed in the flat area and enclosed in a mountain landscape all around. The building is oriented at 16 ° from the north, then the main facades are pointed to East and West.



Figure 1: Map showing the school position

The building has four floors above ground and attic space. The structure has a regular distribution through two stairs climbing from the ground floor up to the roof level. The classrooms look out on the entrance garden in the east facade. The windows on the west side illuminate directly the long corridor that extends for the entire length of the body of the building (Figure 2)

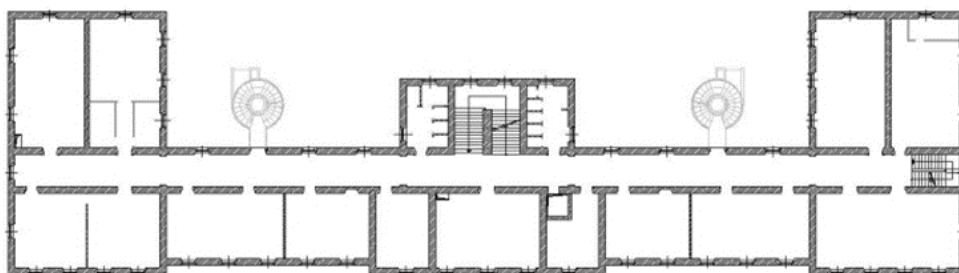

Figure 2: Building floor plan

3. THERMAL COMFORT ANALYSIS

The building taken into account for energy efficiency research project is a secondary school, the age range of occupants is between 13 - 19 years. The comfort analysis according to Fanger's principles has been done on this age range. As level of comfort Temperature ($^{\circ}\text{C}$) has been assumed $T = 20^{\circ}\text{C}$, if the type of school was different (nursery, kindergarten), had to be reset the conditions of comfort, since the occupants' age range changed.

The condition of thermal comfort, can be defined, from the psychological point of view, as the psychophysical state in which the subject expresses satisfaction with the thermal environment (ASHRAE definition) or, from the sensitive point of view, as the condition in which the subject has no feeling of hot or cold sensation, that is a condition of thermal neutrality (Fanger definition). The parameters on which the comfort feeling depends are numerous: air temperature and radiant surfaces, relative humidity and air velocity, clothing thermal resistance, level of activity of the occupants. The creation of a good living space, from the thermal comfort point of view, is one of the most important objectives to be achieved in building design. As mentioned previously, the thermal comfort is just one of the variables that defines the well-being of occupants, in any home-business-school environment must also take into account other factors such as indoor air quality, light and noise.

3.1 Field measurements

In this study, the indoor air temperatures and relative humidity levels were measured with a data logger in the spring period, from 14th to 24th of April. The measurements took place in four classrooms located on the first and second floor of the school building, facing on the four different facades. The monitoring unit was formed by a multi-measure instrument (Babuc/A) mounted on a tripod at the height of 60 cm on the floor. The proper position has been referred to the requirements of UNI EN ISO 7726 and according to the minimal disturbance for the activity of students and teachers. Different measuring probes were installed on it and a central unit measured environmental values were directly recorded. During the measurement of the thermal parameters in a confined environment, it is important to remember that the human thermal sensation does not depend on the environmental temperature, but on the amount of energy that people's bodies consume in the environment.

3.2 Questionnaire survey

To complete the measurement campaign were distributed to students and teachers the questionnaires drawn from the templates contained in the UNI EN ISO 10551. This questionnaire is a good method to understand directly the level of thermal comfort of the occupants in the environment.

In relation to Fanger's studies, the analysis of thermal comfort is based on six parameters, four of these were measured through the Babuc and its sensors (microclimatic variables); the others, called individual variables, depend from the activity and the clothes resistance of the occupants were determined by a questionnaire survey carried out in the same days of the measurement campaign. All the students of each classroom had to fill in the questionnaires and also describe thermal sensations and thermal preferences during lesson hours based on the 7-point of Fanger scale.

3.3 Calculation results

A person is characterized by a thermal comfort condition if he/ she does not feel any type of thermal discomfort. The first condition for the comfort is the thermal neutrality, neither too cold nor too hot.

Through the elaboration of questionnaires and the analysis of measurement campaign it was possible to determine the PMV index (Predicted Mean Vote) and the PPD value (Predicted Percentage of Dissatisfied) for each analysed **classroom. At the end of the research was defined that in the school classrooms of the "Istituto Floriani" there is a general condition of thermal discomfort and a high percentage of dissatisfied students. The uncomfortable condition is due by "localized discomfort conditions". Lots of classes are too small for the students that are inside.** The internal heat gains are too high and students have to open the windows also in the winter season to decrease the inner temperature. In this way, the students near to windows feel cold sensation and the other students in the opposite position feel too hot. The total PMV defines a situation nearly neutrality but in reality, a lot of people are in uncomfortable condition.

4. MONITORING SCHOOL ENERGY CONSUPTION

Parallel to the comfort analysis, started the monitoring school energy consumption. The main goals of the energy monitoring activity are:

- To make the students and all school staff aware of school energy consumption;
- To show how is the influence on the consumption in different season and for activity types in the school.

The results of the monitoring increase the knowledge about energy issues and create a basis for the school refurbishment plan and changing the behavior of people so that energy consumption is reduced.

The first step of analysis was to determine the energy sources and define the type and the number of installations and devices attached to these sources. Then it was possible to access to energy meters and evaluate the yearly consumption total bills from school site staff. In the Table 1 are summarized the energy consumption data, collected in the years 2013 and 2014.

HEATING				ELECTRICITY			
2013		2014		2013		2014	
0,1003 €/kWh heating		0,1001 €/kWh electricity		0,23 €/kWh heating		0,23 €/kWh electricity	
kWh/mq	€/mq	kWh/mq	€/mq	kWh/mq	€/mq	kWh/mq	€/mq
112,629	€ 11,30	100,412	€ 10,05	35,617	€ 8,20	33,845	€ 7,78

Table1: Energy consumption for heating and electricity during the years 2013 and 2014.

5. SCHOOL REFURBISHMENT CONCEPT

Now is time to refurbish our old existing buildings and give them other life chances. This is one of the main concepts at the basis of this research. The overall strategy to reuse, refurbish, extend and adapt the existing building proved to be a more economic and sustainable solution than demolition and new build.

5.1 New functional spaces

As mentioned before, "Istituto Floriani" is an old building that in origin was a military barrack. Many years ago, all the inner areas were converted to transform the barrack in a Secondary school that can guest around 800 students. The proposal provides for the functional refurbishment of 4 existing floors and the addition of a wooden elevation to introduce additional space needed for new educational activities.

On the ground floor is provided an entrance hall for public activities, integrated with relational spaces for students, teachers and external visitors. The first, second and third floors are characterized by traditional classrooms utilized by 800 students. The new fourth floor contains an Auditorium (100 seats) and new flexible classrooms; their movable walls can create different spaces in relation to the flexible number of students and provide various training activities based on new teaching criteria.

5.2 Common environmental problems in schools

Before the refurbishment step of entire school, common environmental problems, typical of old buildings, were listed and analysed in detail. They include:

- Overheating and solar glare in summer
- Lack of sufficient daylight, requiring frequent use of artificial lighting
- Inadequate ventilation, resulting in a stuffy environment
- Thermal bridges.

These problems can affect the concentration of students and teachers, and are counter to the principles of inclusive design. The most comfortable classrooms tend to be those that have good daylight and natural ventilation, and include direct views and links to the outside, and windows that minimize direct sunlight penetration and associated **heat and glare problems. The orientation of classrooms has a crucial effect on users' comfort.**

6. ENERGY EFFICIENCY STRATEGY FOR REFURBISHMENT

Very substantial energy savings are possible with refurbishments of existing buildings. The main focus is on the following aspects:

- **Thermal protection of building's components: the passive refurbishment is referred to the components which** define the continuous thermal envelope as external walls, roof, basement slab and all the transparent elements (doors and windows). A high level of thermal insulation is the essential key for the passive house concept.
- Minimisation of thermal bridges: All the refurbishment strategies which improve the thermal insulation of the building envelope have to take into account the analysis of principal thermal bridges through the use of specific software. This calculation is necessary to choose the best solutions to minimize the thermal bridges problem.
- Improved airtightness: The airtightness of the insulated construction is important for various reasons. The cold air from outside only leads to an increased heating demand and drafts effects. Then the airtightness protects as well from a flow from inside to the outside that is always critical, because warm and humid air condenses on cold areas of building components and can lead to constructional damage.
- Use of excellent quality windows: The U-values of windows (0.8 W/(m²K)) are almost five times as high than those of the opaque building components (0.1...0.15 W/(m²K)). The heat losses through the windows are therefore disproportionately high compared to their relative area. For this reason, the building component **'window' requires such special attention during design and implementation.**
- Ventilation with efficient heat recovery: The main aim of a ventilation system, whatever it is and wherever it is installed, is first of all to provide fresh air for the environments, diluting or removing contaminants and so obtaining a good indoor air quality. The attention to indoor air quality in schools is even shown by the development of many guidelines and regulations concerning the appropriate ventilation rates to be used for these spaces.

7. RESULTS

In order to reach a correct energy refurbishment, all the different retrofit steps have to be summarize in a common master plan. It includes information about order and quality of all energy retrofit measures as well as general definitions of the position of the airtightness layer and the thermal insulation layer in each part of the building envelope. The refurbishment plan has been calculated with the Passive House Planning Package (PHPP), a tool for energetic planning of new buildings and retrofits. In the figure below is shown the results table for the refurbishment measures planned for the case study.

Specific building characteristics with reference to the treated floor area			The PHPP has not been filled completely, it is not valid as verification		
			Criteria	Alternative criteria	Fulfilled? ²
Space heating	Treated floor area m ²	4611,8			
	Heating demand kWh/(m ² a)	7	≤ 20	-	yes
	Heating load W/m ²	9	≤ -	-	-
Space cooling	Cooling & dehum. demand kWh/(m ² a)	-	≤ -	-	-
	Cooling load W/m ²	-	≤ -	-	-
	Frequency of overheating (> 25 °C) %	10	≤ 10	-	yes
	Frequency excessively high humidity (> 12 g/g) %	2	≤ 20	-	yes
Airtightness	Pressurization test result n ₅₀ 1/h	1,0	≤ 1,0	-	yes
Non-renewable Primary Energy (PE)	PE demand kWh/(m ² a)	38	≤ 120	-	yes
Primary Energy Renewable (PER)	PER demand kWh/(m ² a)	22	≤ -	-	-
	Generation of renewable energy kWh/(m ² a)	0	≥ -	-	-

² Empty field: Data missing; - : No requirement

I confirm that the values given herein have been determined following the PHPP methodology and based on the characteristic values of the building. The PHPP calculations are attached to this verification.

Task: _____ First name: _____ Surname: _____
 _____ issued on: _____ City: _____

EnerPHit Classic? yes
 Signature: _____

Figure 3: PHPP – EnerPHit verification

EnerPHit protocol is the new certificated standard created by the Passive House Institute (PHI) in Darmstadt for old buildings, differs from other standards for its higher quality of design, components, manufacturing, and construction. Now it is possible to reach high energy standards even with the refurbishment and not only with the construction of new buildings.

8. DISCUSSION

This research started at the beginning of the 2015 and was based on an accurate methodology that guides every single step of this work. Each phase is important and essential for the next. This case study would want to be a pilot project for the deep refurbishment action for a large number of Italian schools. At the base of the intervention there is the purpose to increase the living comfort of indoor environment. Passive house, bioclimatic architecture, Zero Energy Building are different approaches to obtain the indoor comfort and at the same time reduce the annual **heating demand. Here we wanted, for the first time in Italy, to follow the criterion of the “Passive house” applying it on a school building.** It is a new idea, there are not other examples in similar climate conditions for a comparison and we hope that the Autonomous Province of Trento, our sponsor, will believe in this project and will do the refurbishment following our recommendations.

REFERENCES

- [1] Blücher M., 2016. Implementing deep energy step-by-step retrofits. EuroPHit: Increasing the european potential, Darmstadt, Germany.
- [2] Commission for Architecture and Built Environment: Creating excellent primary schools, 2010.
- [3] Fanger, P. O., 1970 Thermal comfort: analysis and applications in environmental engineering, Malabar, Fla.: R.E. Krieger Pub.,
- [4] Gadotti A. and Albatici R.: A survey of evaluation methods used for holistic comfort assessment. Proceedings of 9th Windsor Conference: Making Comfort Relevant Cumberland Lodge, Windsor, UK, 7-10 April 2016.
- [5] Malcolm B.B. and Lippincott J.K., 2003 Learning Spaces: More than meets the eyes. With the advent of technology on campus comes a shift from classroom to learning space as technology is incorporated in teaching and learning.
- [6] Passive House Institute, Refurbishment with PH components. www.passivehouse.com
- [7] Peper S., Feist W., Sariri V: Airtight project planning of Passive Houses – a guidance. Thechnical information PHI 1999/6, PHI, Darmstadt, 2008.
- [8] Sahar Zahiri and Hasim Altan: The effect of Passive Design strategies on Thermal Performance of Female secondary school Buildings during Warm season in a hot and Dry climate, The University of Sheffield, Sheffield, UK; Sustainable Design of the Built Environment (SDBE), Faculty of Engineering; The British University in Dubai, Dubai; Cardiff University, Cardiff, UK.
- [9] Voss, K.: What is Really New about Zero-Energy Homes? Proceedings of 12th Inter Conf. on Passive Houses 2008, Nuremberg, Germany pp. 187-190.

Factors Affecting High Performance Building Designs in Nigeria's Built Environment: "The Architects Perception"

Abubakar Yahaya MUHAMMAD^a, Bashir Abdulmalik MOHAMMED^b, Usman Aliyu JALAM^c, Nma Yakubu MOHAMMED^d

^a AbubakarTafawa Balewa University (ATBU) Bauchi, Nigeria, yayarisadiq@yahoo.com

^b AbubakarTafawa Balewa University (ATBU) Bauchi, Nigeria, bmadulmalik@atbu.edu.ng

^c AbubakarTafawa Balewa University (ATBU) Bauchi, Nigeria, usman_jalam@yahoo.com

^d AbubakarTafawa Balewa University (ATBU) Bauchi, Nigeria, marksdestiny33@yahoo.com

ABSTRACT

The paper examines the predicaments, prospects, as well as factors affecting High Performance Buildings (HPBs) **design in Nigeria's built environment. The study identifies the weak institutional** frame work, poor policy implementation, inadequate financing and lack of awareness to socio-economic, technology and sustainable built environment. A questionnaire survey was conducted and directed at the various academic Architects and professional **Architects in the Nigeria's construction industry which were selected randomly. A significant and positive correlation** was discovered among Architects knowledge of HPBs within the Nigeria built environment and the implementation which necessitate the certain factors. Moreover, the study affirms that a paradigm shift is required to the current socio-political and techno-economic dynamics of the current HPBs in Nigeria's built Environment. This will require the adoption of HPBs pedagogy in recurrent academic literature. This study is **concluded by highlighting the future prospects of HPBs development in Nigeria's built environment.**

Keywords: built environment, design, factors affecting, high performance building

1. INTRODUCTION

In the prevailing situation, where the global wheel for future socioeconomic growth and sustainable development will require energy efficient building and renewable source of energy (Turkenburg et al., 2000). Africa needs to incline toward sustainable development of the global challenges as well as Nigeria. Nigeria is one of the most resources rich nation in Africa with estimated of 35 billion barrels of crude oil, 180 trillion cubic feet of natural gas, 40 billion metric tons of coal as well as tar sands precious metals, ores which accounts of 90% for GDP annually (Ohimain, 2014).

The construction industry is one of the largest industries that contribute to global warming, traceable to various human activities (Odebiyi et al., 2010). Thus the construction industry features has heavy energy consumption and construction consumes lots of natural resources according to study of Liqun and Yanqun, (2013). Generally, the construction industry in Nigeria is developing rapidly over decades with emphasis on infrastructures due to the uncompromised demand of such facilities. Numerous studies on sustainability and green building had been conducted in Nigeria by some researchers, (Dahiru 2014; Daramola, et al., 2012; Oludaisi 2015; Michael, 2013; Muhammad et al., 2015; Olufunto 2013; Ogunsote, 2011; Waniko, 2013) with the view of assessments, improvement, rating, construction and awareness.

Effort to improve energy efficiency of new building have being reported in many studies of (Chukwu et al., 2014; Diamond et al., 2013; Gidado and Kumo, 2016; Fjola 2016; Gomes 2016; Ogunsanmi and Nduka, 2015) and also Architects Registration Council of Nigeria (ARCON) hold Architectural forum yearly; Architects colloquium (2010; 2011; 2012; 2013; 2014 and 2015) on sustainable built environment to extenuate energy consumption in the country (Nigeria) with the perspective of ameliorating occupant productivity and protecting the environment.

A trivial study has provided information on design of high performance buildings (HPBs) without considering the factor that affect such design in Nigerian content. Cho and Haberl, (2006) explained that to build a high performance building it is necessary to consider the whole building design concept during the design phase that integrate all the subsystem of the building to work together.

The study examines the predicaments, prospects, as well as factors affecting High Performance Buildings (HPBs) design in Nigeria. Thus, the study also identify the weak institutional frame work, poor policy implementation, inadequate financing, lack of awareness to socio-economic and socio-technological factors which affect the renaissance of HPBs/ green building designs in Nigeria. Hes, (2007) stipulated that the greatest chance to reduce the environmental impact of a building is to tackle the minimisation of impacts at the design stage, through good guidance with a building brief.

1.1 Research problem

Green building projects design and construction are characterised by the problem of lack of shared perception (Gidado and Kumo, 2016). Thus the key problem facing green building is limited knowledge, experience, and limited technical know-how to apply ecology to construction design (Hankinson and Breytenbach, 2012). In Nigeria, the cardinal predicament of getting HPBs into building industry is the designers hesitation into new innovative technology without the in depth knowledge of design and practice.

1.2 Research aim

The aim of the study is to identify, assess and rank the factors that affect HPBs with the view of improving their design and implementation in Nigeria construction industry.

1.3 Research hypotheses

The hypotheses were formulated for this research include; Chi- square statistical tool was used for testing the hypotheses:

- Null hypothesis (H₀); there is no uniform perception on factors affecting HPBs design by Architects in **Nigeria's built environment**.
- Alternative hypothesis (H_A); there is limited knowledge and technical know-how on factors affecting HPBs **design by Architects in Nigeria's built environment**.

2. LITERATURE REVIEW

2.1 Current green building/ HPBs polices in Nigeria

The actions and policies of national governments can significantly influence the development and diffusion of novel technology such as HPBs and renewable Energy in Nigeria. Emodi, (2016) Highlighted that the national renewable energy and energy efficiency policy outline the global thrust of the policies and measures for the promotion of renewable energy and energy efficiency with the objectives of setting out a frame work for action to address **Nigerian's challenges. The current practices must** consider Social capital, Economic capital and Natural capital to ensure that building and community create value for all stakeholders (Oliyide, 2015). In addition, these rudiments require government support through the creation of protected vibrant framework. Policy enforcement becomes easy for public adherence when the government is committed to its goals especially by keeping to ethical values (Odebiyi et al., 2010).

Furthermore, the Federal government of Nigeria (FGN) has enacted a number of key energy polices to guide and direct the development and diffusion of renewable energy such can be applicable to HPB. The umbrella policy for energy development in Nigeria is the National Energy Policy enacted in 2003 (National Energy Policy, 2003). In the recent study of David and Olabode (2015), that the policy is aimed at highlighting the dynamic relationship between energy and socio-economic growth and sustainable development in Nigeria.

The study of (Sani and Ahmad, 2011) concluded that strategies towards effective energy code development, implementation and compliance at all levels of government in Nigeria. Thus, the inconsistency in policies implementation couple with the lukewarm attitude of the Federal Government of Nigeria hinders the implementation of building code due to socio-political factors. In the recent study of (Bajere et al., 2016a) highlighted that at the moment, the country does not have a building code setting the minimum design standards for health, safety and welfare of occupant and the government is yet to pass a 2006 Building codes and standards into law.

3. CURRENT PRACTICES AND CHALLENGES OF HPBs IN NIGERIA

3.1 Barriers to HPBs implementation in Nigeria

The development and diffusion of HPBs into Nigeria Energy Economy is a plagued to numerous challenges. As highlighted by (Hekkert et al., 2007), novel technologies such as renewable energy encounter problems competing with conventional technologies.

In Nigeria context, these challenges can be broadly categorized into: socio-political and techno-economic factors. The study of (Bajere et al., 2016b) concluded that the literature revealed the existence of several environmental laws and policies, and the fact that most Nigerian legislations crumble at the implementation stage. This is probably due to inconsistencies in government policies sometimes caused by change in regime and the limited understanding of the process of transferring the laudable provisions into effective tool for managing the environment. This section of the study will examine the crucial barriers and challenges affecting HPBs in Nigeria.

3.2 Socio-political factors

The socio-political factors hampering HPB development and diffusion in Nigeria are largely centred on policy enactment, execution and monitoring. Despite numerous green building polices energy generation, Environmental policy, Building code and power distribution in Nigeria remains dismally low. However, according to Eleri et al., (2012). The poor integration of renewable energy into the Nigerian power mix can be attributed to weak institutional framework, poor policy implementation and lack of awareness. Thus, recent studies of (David and Olabode, 2015) upshot that Nigerian built environment professional are aware of the green building practices applicable to construction projects. There appears to be moderate interest in the practice. The group posit that poor government commitment and unsupportive regulatory framework have stifled development and diffusion of green building.

To curb the socio-political challenges, the Federal Government of Nigeria (FGN) must harmonize green building laws, polices, design, rating, construction guidelines and re-direct national effort towards HPB by focusing on potential sources such local materials, solar and biomass. In addition, the policy implementation must be prioritized and monitored by all ministries, government agencies such as professional bodies charge with green buildings in the Nigeria. The proposed reform required drastic awareness of ministries, government agencies; National Orientation Agencies (NOA) and media in Nigeria can improve awareness and stimulate meaningful significant to underlying on socioeconomic growth and sustainable development in the country.

3.3 Techno-economic factors

The techno-economic factors of HPBs diffusion in Nigeria are centred on the technology and economic aspects of development. Thus, (Jie, 2013)) highlighted that many factor should be taken into consideration in protecting environment and developing the economy, whereby environmental and economic balance should be achieved. The study of (Hekkert et al., 2007) that innovation system theories, the development and diffusion of novel technologies require the participation of stakeholders within the technovation climate. Theses strategic of stakeholder can be broadly categorized into technology producers and technology regulators.

The Technology Producers (TP) comprises technology entrepreneurs, utility companies, power equipment, manufacturers and power distribution companies. The Technology Regulatory (TR) includes; government regulators and supervisor agencies charged with implantation and monitoring energy policies. The role of TPs and TRs is to design, develop and execute innovative technologies and processes for HPBs.

The study of Eleri et al., (2011), concluded that low Renewable Energy Technology development could also be due to lack of local manufacturing capacities, and barriers to financing technologies. Other techno-economic factors hindering HPBs in Nigeria includes; poor state of educational system generally which prevented the development of innovation technologies.

4. RESEARCH METHOD

This research work adopted two sources of data; the secondary and the primary sources of data.

- Secondary sources of data such as journals, conference/seminar/workshop papers, text books, magazines **and the internet etc. were used to review literatures in the HPBs field within the Nigeria's context and at large.**
- A 5-point Likert scale questionnaire survey (as the primary source of data) was Administered to professional and practicing Architects.

Architects working in the Clients, Consultants, Contractors and the Academic organisation were administered the questionnaires randomly. Mean item score and Chi square-test statistics were used for data analyses.

5. DATA ANALYSIS AND FINDING

5.1 Respondents profile

The questionnaire survey forms were distributed to various Architects practising within Abuja, Bauchi, Enugu, Kaduna, Lagos, and Jos states of Nigeria. A total of 250 questionnaires were distributed and 153 completed questionnaires were received. **The Table 1 below summarizes the respondents' profile.**

Category Respondents		
Business Category	Respondents	
	Number	%
Developer/Client	19	12
Architects in Academic/Researchers	59	39
Contractor's Architects.	21	14
Consultant's Architects	37	24
Architects in Government Parastatal	17	11
Year of Experiences		
Less than 5 years	6	4
5-10 years	37	24
10-15 years.	53	35
15-20 years.	47	30
More 20 years.	10	7

Table 1: Respondent's profile

The highest participants of the survey were 39% of Architects in academic/ **researchers, 24% were consultant's Architects, 14% were Contractor's Architects, 12% were Developer/Client and 11% were Architects in government parastatal.** The years of experiences plays a significant role in relation to the respondents; the richer the experiences the vital the information. The respondent with less than 5years of experiences had 4% while that of 7% were those above 20 **years' experience, 24% of those with 5 -10years, 30% of those with 15-20 years and 35% of 10 -15years of experience.** The results indicated that 35% is the highest years of experiences (10-15 years) of **the respondents' participation.**

5.2 Factors affecting HPBs design practices

The respondents were asked to provide their perceptions on the factors affecting High Performance Buildings Design and level of impact associated during the process of design practice in Nigeria as showed in the table 1 below.

FACTORS AFFECTING HPBs	Strongly disagree =1	Disagree= 2	Neutral =3	Agree =4	Strongly agree=5	Mean item score	Remarks	Ranking
Limited knowledge, technical know-how and Understanding by the design professionals	11	9	5	45	83	4.18	Agreed	1st
Lack of design expertise on HPBs	2	15	7	74	55	4.08	Agreed	2nd
Not comfortable with novel technology	15	47	27	56	8	2.97	Neutral	9th
Lack of operational standards for new construction	14	29	7	67	36	3.54	Agreed	6th
Unavailability of local HPBs materials for sustainable design.	3	10	12	93	35	3.96	Agreed	3rd
Lack of adoptable rating tool for Green building.	10	27	37	56	23	3.36	Agreed	7th
Lack of Availability of technology suitable for green Design	9	19	11	87	27	3.68	Agreed	5th
Complicated and unique designs.	4	9	29	81	30	3.81	Agreed	4th
Design operation tends to introduce control risk.	47	65	8	13	20	2.31	Disagreed	11th
High cost of sustainable materials and product.	14	35	67	21	16	2.93	Neutral	9th
Client budget	9	14	5	87	38	3.86	Agreed	4th
Price inflation of construction materials.	17	29	43	57	7	3.05	Neutral	8th
End-User Purchasing/Spending Power.	7	32	20	82	12	3.39	Neutral	7th
Absent of HPBs National building code.	5	29	30	78	11	3.40	Neutral	7th
Political will in government.	9	13	11	47	73	4.06	Agreed	2nd
Tendency of sustaining HPBs practices.	12	47	78	11	5	2.67	Neutral	10th
Absence of statutory law/regulation on HPBs	3	9	37	89	15	3.68	Agreed	5th

Source: Author's field work 2016.

Table 2: Factors affecting HPBs design practices

The affiliated factors affecting HPBs design practices in Nigeria's built Environment are summarized in Table 2 above whereby lack of knowledge and understanding by the design professionals (MS = 4.18) rank first, lack of design expertise on HPBs and political will in government rank second (MS = 4.08) simultaneously, Unavailability of local HPBs materials for sustainable design (MS = 3.96) rank third, Client budget (MS = 3.86) rank fourth, lack of availability of technology suitable for green design and Absence of statutory law/regulation on HPBs (MS = 3.68) rank fifth. These results depicted that limited knowledge, technical know-how and understanding by the design professionals, lack of design expertise on HPBs, political will in government where the ultimate impediment for HPBs designs practices. Price inflation of construction materials (MS = 3.05) rank eighth, high cost of sustainable materials and product (MS = 2.93) rank ninth, tendency of sustaining HPBs practices (MS = 2.67) rank tenth, design operation tends to introduce control risk (MS = 2.31) rank eleventh.

5.3 Testing of hypotheses

Chi-square was used for testing of the hypotheses. The values for mean item score were used for data for statistical computation as showed in the table below.

FACTORS AFFECTING HIGH PERFORMANCE BUILDINGS DESIGN.	Level of significance	DF	X ² Cal	X ² tab0.05, 64
NUMBERS OF ROWS	17			
	5%	64	1078.51	83.6754
NUMBER OF COLUMNS	5			

Table 3

From the table above, with 64 degrees of freedom (DF) and 5% level of significance, the Chi-square tabulated (X²tab0.05, 64 = 83.6754) is lower than the Chi-square calculated (X²cal = 1078.51). Therefore, the Null hypothesis

is unaccepted; which put forward that there exist a concrete perception on factors affecting HPBs design by **Architects in Nigeria's built environment.**

6. CONCLUSION

This is further attested by the Chi-square statistical test which accepts the alternative hypothesis of the research. With the established validated hypothesis that there exist a concrete perception on factors affecting HPBs design by **Architects in Nigeria's built environment.**

To subdue the existing challenges that were revealed in this research in relation to the Architects perception on factors that affect HPBs design, it will require the adoption of HPBs pedagogy in recurrent academics literature. The perceived factors, such as limited knowledge and technical know-how on HPBs, lack of political will in government and unavailability of local HPBs materials for sustainable design in Nigeria can be initiated into green building movement using local existing materials, resources and training of professionals. With the strategy of incremental adoption and implementation will gradually assist HPBs/green building practices in the future development in **Nigeria's built environment. On a global scale, these findings can be utilised as checks for the** developed countries that have established benchmarks for HPBs and for upcoming developing nations, these factors may be set as milestones for accomplishments of HPBs.

REFERENCES

- [1] Bajere, P.A., Isa, R.B., Shittu, U.A., 2016. Stakeholders Awareness of Green Building and Sustainable Development Issues in Abuja, Nigeria, in: *Strategies, Stakeholders, Success Factors*. Presented at the Sustainable Built Environment Conference 2016 in Hamburg, Druckerei in St. Pauli, Große Freiheit 70, 22767 Hamburg, Germany, Hamburg, Germany, pp. 1068–1077.
- [2] Cho, S., Haberl, J.S., 2006. A Survey of High Performance Building in United States,. *Energy Syst. Lab. Eng. Exp. Station. AM Syst. Coll. Stn.*
- [3] Chukwu, P.U., Ibrahim, I.U., Ojosu, J.O., Iortyer, H.A., 2014. Sustainable Energy Future for Nigeria: The Role of Engineers. *J. Sustain. Dev. Stud.* 6 (2), 242–259.
- [4] Daramola, S.A., Adebayo, T., Alabi, D., 2012. Geen Architecture and Sustainable Development in Nigeria. *J. Sustain. Dev. Environ. Prot.* Vol.2 No.2.
- [5] **David, O.N., Olabode, E.O., 2015. Construction Professionals' Perception on Green Building Awareness and Accruable Benefits in Construction Projects in Nigeria. Covenant J. Res. Built Environ. CJRBE Vol3 No2.**
- [6] Diamond, R.C., Ye, Q., Feng, W., Yan, T., Mao, H., Li, Y., Guo, Y., Wang, 2013. Sustainable Building in China—A Green Leap Forward? *Open Access Build.* 3030639 PP639-658.
- [7] **Eleri, E., Ugwu, O., Onuvae, P., n.d. 'Low carbon Africa: Nigeria.,** in: International Centre for Energy, Environment and Development (ICEED). Abuja.
- [8] Emodi, N.V., 2016. Energy policies for Sustainable Development strategies: The case of Nigeria. James cook University caims, QLD Australia: Springer, Australia.
- [9] Gidado, D., **Salisu, Kumo, A.H., 2016. Success Criteria for Green Building Projects in the Nigeria's Construction industry: "The Stakeholders' perception,"** in: *Strategies, Stakeholders, Success Factors*. Presented at the Sustainable Built Environment Conference 2016 in Hamburg, Druckerei in St. Pauli, Große Freiheit 70, 22767 Hamburg, Hamburg, Germany, pp. 1094–1103.
- [10] Hankinson, M., Breytenbach, A., 2012. Barriers that impact on the implementation of sustainable design, In, in: *Proceedings of Cumulus Conference, Hosted by Aalto University School of Art and Design, . Helsinki, Finland.*
- [11] Hekkert, M.P., Suurs, R., Negro, S., 2007. Functions of innovation systems: A new approach for analysing **technological change."** *Technol. Forecast. Soc. Change* 74(4), 413–432.
- [12] Hes, D., 2007. *ESD DESIGN GUIDE Office and Public Building*. Printed on recycled paper using vegetable based inks by Focus Press, certified EMS ISO 14001., Austria.
- [13] **Jie, L., 2013. Research on the Balance between Green building's Environment and Economy in China, in: Green Building Technologies and Materials II.** Presented at the 2nd International Conference on Green Buildings Technologies and materials, Trans Tech Publications, Wuhan, China.
- [14] Liqun, G., Yanqun, G., 2013. Research on Green Building Technology and Design-Take **I.M Pei's** architecture design works for Example, in: *Green Building Technologies and Materials II.* Presented at the

2nd international Conference on Green Building Technologies and Materials., Trans Tech Publications, Wuhan, China, pp. 193–197.

- [15] Michael, B.O.A., 2013. Assessment and Adaptation of an Appropriate Green Building Rating System for Nigeria. *J. Environ. Earth Sci.* 3, No1.
- [16] Muhammad, A.Y., Akali, I.A., Yakubu, M.M., 2015. High Performance Office Building a Low-Carbon Cities Initiative. *Int. J. Sci. Res. Sci. Eng. Technol.* 1, 177–181.
- [17] Odebiyi, S., O., Suneetha, S., Braimoh, A.K., 2010. Green Architecture: Merits for Africa (Nigerian Case Study). *J. Altern. Perspect. Soc. Sci.* Vol 2 No 2 746–767.
- [18] Ogunsanmib, O.E., Nduka, D.O., 2015. Stakeholders Perception of Factors Determining the Adoptability of Green Building Practices In Construction Projects In Nigeria. *J. Environ. Earth Sci.* Vol.5, No.2,
- [19] Ogunsoye, B.P., 2011. Towards the Establishment of a Green Building Council and the Development of a Green Building Rating System for Nigeria.
- [20] **Ohimain, E., I., 2014. can Nigeria generate 30% of her electricity from coalby” . *Int. J. Energy Power Eng.* 3(1), 28–37.**
- [21] Oliyide, S., 2015. Evolution of Green Building: a Myth or a reality. Alpa Meead facilities and management services limited., Lagos, Nigeria.
- [22] Turkenburg, W., Beursken, J., Faaji, A., Fraenkel, P., Fridleifsson, I., Lysen, E., Mills, D., Moreira, J., **Nilsson, L., Schaap, A., 2000. Renewable energy technologies” . *World Energy Assess. Energy Chall. Sustain.* 219–272.**
- [23] Waniko, D.P., 2013. Green Building in Nigeria:Emerging Opportunities for the Quantity Surveying Profession.

Poster Session

Building High on Sustainable Use of Water: Hong Kong's Effort

Stephen CATLIN Kit-wai^a, KWAN Kai-yin^b

^a Water Supplies Department, Government of the HKSAR, Hong Kong SAR, stephen_kw_catlin@wsd.gov.hk

^b Water Supplies Department, Government of the HKSAR, Hong Kong SAR, ky_kwan@wsd.gov.hk

ABSTRACT

To attain sustainable use of water to meet the challenge of climate change, Hong Kong is transforming itself into a water efficient society. However, success will require actions at various levels. This paper introduces Hong Kong's efforts pitched at individual buildings, driving them to perform better for efficient and sustainable use of water through an array of measures. On the supply side, not only does the Government advocate the use of sustainable water resources such as recycled grey water and harvested rainwater, but private sectors are also encouraged through a green building certification scheme to implement water recycling in new developments. In the meantime, existing buildings are offered with other options on the demand side. Flow controllers are distributed and installed to transform taps and showers into water-saving ones, and water efficiency audits are conducted to guide facilities and trades within buildings to more efficient use of water. Use of water efficient products is being promoted through the voluntary Water Efficiency Labelling Scheme with work in progress on mandating their use in new developments and major renovation. With an aim to enhancing water loss management in inside service, a new voluntary scheme for buildings on leak detection is also being developed. Riding on the advancement in the information and communication technology, the pilot scheme on use of smart water meters can facilitate consumers' self-monitoring of water consumption for conservation and loss reduction. The above measures which touch on the hardware side are coupled with software promotional elements, as it is believed that buildings can only truly make great strides in conservation if their occupants are on the same track. With buildings becoming more water-efficient and occupants more water-conscious, a sustainable use of water can be realised with holistic actions from city, building and individual levels in Hong Kong.

Keywords: high performance building, sustainable use of water, water conservation

1. INTRODUCTION

Providing an adequate water supply for Hong Kong has always been difficult because there are no natural lakes, rivers or substantial underground water sources. As Hong Kong flourished in the past with population and economic growth, impounding reservoirs were constructed and about one-third of the land was designated as water gathering grounds to cope with the increasing water demand. Among the 17 impounding reservoirs of Hong Kong, two reservoirs were innovatively built in the sea, i.e. the Plover Cove and High Island reservoirs. Hong Kong has also implemented an innovative scheme of using seawater for toilet flushing since the 1950s, and has been importing raw water from Dongjiang since 1965. This three-pronged supply structure comprising local yield, imported Dongjiang water and flushing seawater has supported Hong Kong with an uninterrupted and reliable water supply for the past decades, yet demand for water in Hong Kong, like many other cities, is still subjected to the pressure of continual population and economic growth as well as climate change.

To ensure water security and sustainability against the many challenges ahead, a Total Water Management Strategy (TWMS) was promulgated by the Hong Kong Special Administrative Region Government (the Government) in 2008, emphasising the importance of curbing the growth of water demand on one hand and strengthening overall water supply management on the other. Hong Kong has a high density of high-rise buildings. This offers great potentials for efforts pitched at individual building level to contribute towards transforming Hong Kong into a water efficient society.

2. SUSTAINING SUPPLY IN BUILDINGS

In tackling challenges in water resources, measures on both sides of the water balance should be explored. On the supply side, one key initiative under the TWMS is to explore the use of new and sustainable water resources, such as water reclamation (including grey water recycling and rainwater harvesting).

2.1. Sustaining supply in buildings

The Government has been taking the lead to promote and implement water reclamation in buildings. Apart from establishing quality and technical standards for grey water recycling and rainwater harvesting, the Government is taking forward plans to include grey water recycling and rainwater harvesting systems for non-potable uses in suitable new public works projects. So far, grey water recycling systems or rainwater harvesting systems have been introduced in over 60 works projects including schools and various government facilities.

A joint circular on **green government buildings was issued in April 2015 by the Government's Development Bureau** and the Environment Bureau, highlighting the policy on the use of recycled water in government buildings. Under the circular, all new government buildings with the potential of reducing fresh water demand for non-potable applications through rainwater harvesting or grey water recycling are required to have on-site water treatment and recycling facilities installed as far as reasonably practicable. The general principle is that so long as the operating and maintenance costs can be offset by the saving of the production cost for the fresh water saved, installation of such facilities should actively be pursued. Moreover, all new government buildings should aim at maximising the use of reclaimed water from treated sewage effluent, if available, for non-potable applications such as toilet flushing.

Under the policy of the circular, existing government buildings should also aim at maximising the use of reclaimed water, where available, and exploring the use of recycled grey water and harvested rainwater for non-potable applications, whenever there are large-scale relocation or interior renovation works taking place.

2.2. Buildings in the private sector

For private developments, the implementation of water recycling is encouraged through a green building certification scheme, namely the Building Environmental Assessment Method (BEAM) Plus. BEAM Plus sets out best practice criteria on how buildings should be designed, constructed, operated, etc. to reduce their environmental impacts thereby increasing their overall sustainability. For both new buildings and existing buildings, the BEAM Plus assessment confers ratings (Platinum, Gold, Silver and Bronze) according to scores attained.

There is a "Water Use" aspect included in the BEAM Plus with assessment features intended to improve water utilisation and conservation. Apart from encouraging water conservation initiatives such as the use of water efficient devices, credits are granted for utilising sustainable water sources to reduce fresh water consumption. Other than implementing water recycling through harvesting of rainwater and/or recycling of grey water, buildings can also obtain credits for the establishment of an irrigation system which requires limited use of fresh water, or deploying highly efficient irrigation technologies and/or making use of recycled water to reduce fresh water consumption for irrigation.

The Government has been providing support in the reviews for the BEAM Plus Existing Buildings and New Buildings, putting forth more initiatives, hence more credits, in relation to efficient and sustainable water utilisation in the assessment tool.

3. REDUCING DEMAND IN BUILDINGS

On the other side of the water balance, it is also important to manage well and reduce water demand. In fact, water conservation is the cornerstone in the TWMS. After all, a droplet saved is a droplet gained. For existing buildings where implementation of supply initiatives like grey water recycling or rainwater harvesting is often much constrained by space and layout problems of the buildings themselves, options on the demand side is particularly important and useful, as demand management measures can be more easily implemented to facilitate them on the sustainable use of water. Transforming existing devices into water-saving ones

Existing plumbing fixtures installed in buildings are more often than not less water efficient. Retrofitting them with water saving devices is a direct means to reduce water consumption. To this end, the Government has been retrofitting plumbing fixtures with water saving devices in existing government buildings and schools.

Apart from retrofitting the fixtures, an alternative is to transform existing devices into water-saving ones by installation of flow controllers, which restrict the water flow. The Government has rolled out programmes where flow controllers are either distributed or installed to transform taps and showers into water-saving ones.

The “Let’s Save 10L Water” Campaign, unveiled in March 2014, encourages the public to implement water saving practices and monitor their own water saving performance by signing a “Water Conservation Declaration”. Each participating household is entitled to a pair of complimentary flow controllers for water taps to help conserve water. As of September 2016, complimentary flow controllers have been delivered to nearly 140,000 participating households.

Since August 2014, the Government has also dedicated efforts to install flow controllers to taps and showers at public rental housing estates, government buildings and schools.

3.2. Water Efficiency Labelling Scheme (WELS)

Since 2009, the Government has been implementing a voluntary WELS to cover different plumbing fixtures and water-consuming appliances in phases. By providing consumers with information on nominal flow rates and water efficiency grades, consumers can select water efficient fixtures and appliances by simply reading the WELS labels affixed to the products and their packages. Besides, WELS can promote public awareness on water conservation and efficiency issues, and achieve water savings.

Five types of plumbing fixtures and water-consuming appliances have come under WELS since 2009, namely showers for bathing (in September 2009), water taps (in September 2010), washing machines (in March 2011), urinal equipment (in March 2012) and flow controllers (in August 2014). At the same time, the Government is constantly striving to extend the coverage of the scheme and include more products in WELS.

Positive results of WELS can motivate consumers’ use of these products, thereby expanding their market penetration. With increasing market migration to water saving devices, considerable amounts of water can be saved. To step up the gear in water conservation, WELS and the use of water efficient products will be further promoted, with the first move being the implementation of mandatory use of registered WELS products in all new domestic buildings and existing domestic buildings under major renovation together with the toilets in new non-domestic buildings and existing non-domestic buildings under major renovation.

3.3. Water efficiency audits and development of best practice guidelines for trades

With buildings accommodating domestic and non-domestic water users, it is important that demand management measures are formulated and implemented for both sectors. Non-domestic water use accounts for a substantial proportion of the overall fresh water consumption in Hong Kong, and could make significant contributions to water conservation by implementing water efficiency measures.

The Government has conducted water efficiency audits (WEAs) and developed best practice guidelines (BPGs) for water use efficiency for public facilities like public swimming pools, parks and markets, as well as major high water-consuming commercial operations including hotel and catering.

Through the WEAs, information on operation procedures are collected, and typical water use practices and consumption patterns are studied for development of BPGs. In WEAs, water use entities and plumbing arrangement are identified and staff interviewed to obtain information on water use practices and operational data. Monitoring and review of water consumption and flow trend and pattern is also carried out with a view to recommending short, medium and long term measures to improve water use efficiency. Upon completion of the WEA, staff are debriefed of the water consumption status and the recommended improvement measures.

BPGs are developed encompassing improvement or modification to water use hardware, good maintenance practices, as well as education for both staff and clients. The Government also provided support and collaborated with the catering and hotel industry stakeholders by holding a forum in November 2014 to share experiences about implementing best water use practices and water conservation measures. The BPGs for catering and hotel industries will be promulgated in the Water Conservation Week (WCW), a large-scale event to promote water conservation to various sectors in the community to be held in November 2016.

4. MANAGING LOSS IN BUILDINGS

In the course of managing demand, apart from reducing consumption, one must not forget the need to reduce water loss brought by leakages. As property management companies are responsible for the maintenance of the communal service including the underground inside service within a building, the Government sees them as a partner to enhance water loss management at building level.

4.1. Voluntary scheme on leak detection in buildings

The Government is reviewing and formulating a voluntary scheme on leak detection in buildings. The scheme aims to assist property owners and management agents in conducting leak detection for underground inside services to identify areas in advance for necessary maintenance, thus minimising wastage of water arising from leakage and reducing the extent of repair works. Through participating in the scheme, the building management agent could strengthen its capability to achieve value-added performance in meeting the expectation of tenants with respect to the reliability of the inside service whilst earning recognition for being capable of demonstrating consistent compliance with the prescribed criteria under the scheme.

Applications will be assessed based on the methodology, staff qualification, frequency of leak detection works and report submission. Successful applicants will be awarded certificates, as recognition of their efforts to maintain the healthiness of the water supply systems they manage, having fulfilled the criteria concerning leak detection of their inside service and rectification of any irregularity identified.

5. UTILISING SMART TECHNOLOGIES IN BUILDINGS

Monitoring one's water consumption can enhance one's awareness and trigger water conservation and rectification actions. With technological advancement, the application of smart metering for water supply can enable close monitoring of water consumption by consumers themselves and the Government.

5.1. Automatic meter reading system

With automatic meter reading (AMR) system, water consumption data can be read automatically from smart water meters for purposes of billing and also better planning of water supplies. Timely water consumption information can be provided to the consumers through the internet and mobile phone to raise their awareness on water conservation and help stimulate behavioural change. In gist, smart water meters are equipped with units to collect metering data, which will eventually be transmitted to a master station in the Government through 3G/broadband networks.

Benefits of AMR include:

- Improving meter reading efficiency (i.e. Reducing human error);
- Detecting abnormal water consumption (e.g. Leakage of plumbing);
- Allowing better planning and management of water supplies;
- Enhancing services through provision of timely water consumption information via internet and mobile phone; and
- Providing an ideal platform for promotion of water conservation.

5.2. Smartphone application

The Government is conducting a pilot project for smart metering of water supply in selected government quarters and public housing blocks. In addition, a mobile phone application (the App) is being developed to review the feasibility and the effectiveness of using mobile phone for dissemination of timely consumption data to consumers. Apart from consumption data, the App can also provide a **benchmark of consumers' water usage and generate alert** on detection of suspected leakage of their pipework.

Upon launching of the system, consumers for whom AMR infrastructure has been installed can access their water consumption data and other related information through the App on their smartphone.

The App also has a function for benchmarking the user's water consumption against Hong Kong's overall per capita consumption. Such function can help consumers to gauge how efficient water is being used by them so as to raise their awareness on water conservation.

In addition, based on the consumptions recorded, the system is able to generate alert to the customer's mobile phone on detection of suspected leakage of their pipework (probably due to seepage or dripping tap). Such a function would enable timely action be taken by customers to avoid wastage of water.

6. EDUCATING OCCUPANTS IN BUILDINGS

While many of the implemented measures focus on the hardware, success will not be possible if building occupants are not on the same track. To this end, the Government has taken on a range of key software promotional initiatives **to raise the public's awareness and commitment to water conservation.**

6.1. Educating the youngsters

Early education has all along been known as an effective means to inculcate the younger generation about adopting good water saving habits that will last for a lifetime. Since 2009, the Government has run a series of well-received school educational programmes, such as school water audits and roadshows to help primary school children establish effective water saving practices and encourage them to promote water conservation to their **peers and family members.** In furtherance, the Government has rolled out a **"Cherish Water Campus" Integrated Education Programme (IEP)** in primary schools in the 2015/16 school year, consolidating and combining existing and new school initiatives to keep the concept of sustainable water conservation a key area of study in schools. The IEP integrates theory with practice, with an aim to enhancing students' knowledge about protection of water resources and the global water crisis, and facilitates them to adopt water conservation practices at school and at home, as well as to spread the water-saving message to their peers, families and the community.

6.2. Water Resources Education Centre

In 2012, the Government set up a temporary Water Resources Education Centre (WREC) to enhance the younger **generation's knowledge about water conservation.** The Government has commenced the design of a permanent WREC at Tin Shui Wai. With an expanded exhibition area, four times that of the temporary WREC, the new WREC will be able to introduce more new initiatives and in-depth materials covering various aspects of water conservation and water resources to cater for a wider spectrum of visitors. The new WREC is expected to be opened in 2018/2019.

7. FUTURE OUTLOOK

Rome was not built in one day, neither was it built by one person. Success on water sustainability in Hong Kong relies on actions at multiple levels, from city to buildings, from community to individuals.

At city level, the Government is pursuing to exploit new water resources that are not susceptible to climate change in addition to the existing three water sources. Hong Kong is now progressing from its current three-pronged water supply structure to a six-pronged structure that comprises local yield, imported Dongjiang water, seawater for flushing, desalinated water, recycled grey water and rainwater harvesting as well as reclaimed water. **The six-pronged water supply structure will be the pillars that together support Hong Kong's enhanced water security, reliability and resilience.**

At building level, the Government has introduced an array of measures to make buildings more water-efficient. These include the promotion of using sustainable water supply sources, use of water efficient devices, better water loss management and utilising smart technology. The combination of supply and demand measures on both sides of the water balance provides a well-rounded solution for buildings to use water more efficiently and more sustainably.

At the same time, the Government has also adopted a multi-pronged approach which covers software measures targeted to occupants and individuals, for it will be impossible for a building to achieve sustainability if the occupants are not committed to operate them in a sustainable manner. At community and individual levels, efforts have been made to raise water-consciousness through promotion and education, with an aim of enhancing awareness of

building occupants on water sustainability. By further transforming the awareness into actions, a building can achieve much more on water conservation, water efficiency and water sustainability.

The concerted effort and holistic actions at city, building and individual levels will enable Hong Kong to build high on sustainable use of water for the future generations.

Costs and Benefits of Implementing Green Building Policy

FAN Ke^a, GU Wei^b, Queena QIAN^c, Edwin CHAN^d

^a The Hong Kong Polytechnic University, Hong Kong SAR, ke.fan@connect.polyu.hk

^b The Hong Kong Polytechnic University, Hong Kong SAR, wei.gu@connect.polyu.hk

^c Delft University of Technology, The Netherlands, k.qian@tudelft.nl

^d The Hong Kong Polytechnic University, Hong Kong SAR, edwin.chan@polyu.edu.hk

ABSTRACT

Green building (GB) policies have been implemented to promote GB and address climate change. Most of the **existing literatures have studied the costs and benefits of developing GB, without considerations of GB policies' impacts. This paper aims to study costs and benefits of implementing GB policy from developers' perspective. It takes the Gross Floor Area (GFA) Concession, which is a popular policy and has been implemented in the US, Singapore and Hong Kong, as an example, to compare its implementation in three regions and analyze how it affects developers' costs and benefits. Findings show that Hong Kong has relatively lower threshold to acquire GFA concession for developers and it is the right time to adjust the GFA concession incentive to reflect the market transformation and further encourage developers to go for higher levels of GB.**

Keywords: policy and regulation, costs and benefits, GFA concession

1. INTRODUCTION

Building energy consumption contributes to one-third of greenhouse gas emissions in the world (UNEP, 2009). Besides, building sectors also affect the built environment in other ways, like environmental damage, resource depletion and solid waste generation in the process of building construction and operation. Against this background, green building (GB) as a solution to the environmental problems become popular. However, constructing green building costs more than traditional buildings, which is one of the main barriers to prevent GB development. To promote the GB, various economic incentives have been implemented to reduce or cover developers extra costs, such as GFA concession, tax reduction, and subsidies.

Among all these economic incentives, the GFA Concession Scheme becomes a popular one because it would not affect government income and be subject to government financial situations (Fan, Qian, & Chan, 2015). The GFA Concession Scheme is designed to reward developers extra GFA for their contributions to the public facilities or sustainability and government could save that amount of money in the meanwhile. However, too many GFA concessions would impose additional social costs (Feiock, Tavares, & Lubell, 2008), and few GFA concessions are not enough to motivate developers to construct different levels of green building. Therefore, how to use this instrument to promote GB remains a question. This paper studies the GFA Concession Scheme in the US, Singapore, and Hong Kong and analyzed how the scheme affect **developers' costs and benefits and how to adjust** it to reflect market transformation of GB.

2. COSTS AND BENEFITS TO CONSTRUCT GREEN BUILDING

The additional costs of green building have been discussed in a lot of articles. For example, Yu and Tu (2011) stated that Green Mark buildings require a range of 1%-3% extra cost compared with non-green mark buildings in Singapore. Their Building and Construction Authority (2015) stated that the cost premiums for GM Platinum, and GoldPlus are S\$123/m² and S\$97\$/m² in the residential sector. Kats et al. (2003) claimed 0.66% extra cost for LEED certification, 2.11% for Silver, 1.82% for Gold, and 6.50% for Platinum in the US. Davis Langdon (2007) suggested 3%-5% greater cost for five-star and 6% for six-star in Australia where the Green Star rating system is employed. In Hong Kong, under the Hong Kong Building Environmental Assessment Methods (BEAM), there were 0.8%, 1.3% and 3.2% cost premiums for Silver, Gold and Platinum building respectively (Burnett et al., 2008). However, the HKBEAM has been upgraded to BEAM Plus and experienced two versions for new buildings and three versions for existing buildings. The construction cost of green building has increased with the upgradation of the BEAM Plus. Similar situation also happened in the US. The improvement of the LEED increased the construction costs of green building, which in return influences the updates of the green building incentive.

In terms of financial benefits to construct green building, Fuerst and McAllister (2008) claimed that green buildings have price premiums, 10% and 31% premiums for GB certified by Energy Star and LEED respectively. Yu and Tu (2011) stated that Green Mark buildings have a price premium that increases with the rating of Green Mark. Miller, Spivey, and Florance (2008) suggested 9.94% price premium for LEED and 5.76% for Energy Star per square foot. However, there are few studies discussing the selling price of GB in Hong Kong. The most relevant one finished **by Burnett et al. (2008) studied the financial benefit of GB from the life cycle's perspective, such as reducing sewage charges and energy consumption.**

3. Green building incentive schemes

In order to promote green building, customized incentive schemes are acknowledged as one of the most effective approaches for government intervention (Qian & Chan, 2007). Their purpose is to motivate the market and attract **the stakeholders' business** interests in green building investment through reasonable incentive policies. To fulfill this objective, the incentives should be attractive to business and also be administratively easy for government to implement. The main reasons for instituting incentives for GB promotion are: 1) To correct for external costs; 2) To supply information (when the incentive is tied to a specific action or investment); 3) To reduce investor risk in a new technology; and 4) To accelerate the pace of adoption of efficient technologies.

3.1. The GFA Concession Scheme and developers' costs and benefits

The GFA Concession Scheme is designed to reward developer additional gross floor area for their contributions to the public facilities so that government could save money to invest (Tang & Tang, 1999). It has a long history and been applied to renewable energy of buildings in New Zealand, Japan, France and US (Paetz & Pinto-Delas, 2007), affordable housing incentive scheme in the US, Australia and UK (Fox & Davis, 1975), and green building promotion in the US, Singapore and Hong Kong (Fan, Qian, & Chan, 2015) where different terminologies sharing the same meaning, such as density bonus, GFA concession and GFA bonus, are used. The GFA Concession Scheme addresses the market barriers of higher upfront cost and corrects the misplaced incentives of green building.

3.1.1. US

The Arlington County is the first one to implement the GFA bonus in the US. It started in 1999, and was revised in 2003, 2009, 2012 and 2015 on the basis of the increase in knowledge and market demand for green buildings.

Table 1 illustrates the development history of the GFA bonus incentive scheme in Arlington County. The adjustment of the GFA bonus incentive is based on the market transformation that buildings achieved lower levels of LEED more frequently. Obviously, the assessment criteria and the calculation method of the GFA bonus were becoming more difficult and complicated from 1991 to 2015. The Table 1 indicates that to reflect the market transformation, the adjustment of GFA bonus could start from four aspects: 1) to expand the range of GFA bonus; 2) to reduce the level of GFA bonus; 3) to improve the criteria to acquire GFA bonus by upgrading the green building assessment methods, and adding additional conditions (like energy efficiency); 4) to increase GFA bonus for meeting higher rating of GB or additional conditions, and decrease bonus for lower ratings. From 2009, the incentive for office buildings is separated from and less than that for residential buildings in that office buildings have more market demand. Government incentives were given more to the residential sector. From 2012, the energy efficiency requirement was added in the incentive scheme to further promote sustainability. In 2015, Energy Star certification becomes mandatory to apply for the GFA bonus for the office buildings. Every time to adjust the incentive, **developers' costs and benefits were considered. For example, LEED version 4 leads to more construction cost than LEED 2009 and Energy Star certification also costs developers.** Therefore, in 2015, the incentive level increases a little to motivate developers to adopt new standards.

3.1.2. Singapore

The Building and Construction Authority (BCA) in Singapore and the Urban Redevelopment Authority (URA) jointly released the Green Mark (GM) GFA Incentive in 2009, which stated that developers and building owners could apply for up to 2% GFA bonus (subject to a cap of 5,000 sqm) in exchange for constructing GM Goldplus building and 1% GFA bonus (subject to a cap of 2,500 sqm) for constructing GM Platinum buildings. During 2009-2013,

the total GFA of green buildings increased 34.2 million m², while before this GFA scheme, the increased total GFA of green buildings only increased 14.2 million m² within 4 years from 2005 to 2009.

In 2010, BCA announced that under government land sale program, all the new developments on the land sold on or after 5 May 2010 in the Strategic Growth Areas should be designed to meet a higher GM certification (Building and Construction Authority, 2014). In Downtown core, it is required that building should reach GM Goldplus Rating. This policy could help improve building energy efficiency and release heat island effect in city core. Therefore, it is mandatory to construct green building in the Downtown core.

	1999	2003	2009	2012	2015
Objective	To guide the building design and construction	To include all LEED levels and all the projects	To adjust the bonus to reflect market transformation	To focus on energy efficiency to align with the Community Plan goals, minor bonus adjustment	To encourage developers focusing on the incorporation of energy efficiency into the site plan and on the ongoing energy consumption
Assessment criteria	<ul style="list-style-type: none"> LEED Silver only (commercial office only) 	<ul style="list-style-type: none"> LEED Certified, Silver, Gold or Platinum 	<ul style="list-style-type: none"> LEED Certified, Silver, Gold or Platinum 	<ul style="list-style-type: none"> LEED 2009 Silver, Gold or Platinum Energy efficiency for commercial office buildings 	<ul style="list-style-type: none"> LEED version 4 Energy Star Building certification within four years of occupancy (commercial office building) Community Priority credits (optional)
Calculation of GFA concession	<ul style="list-style-type: none"> Up to 0.25 FAR (floor area ratio) 	<ul style="list-style-type: none"> 0.15FAR (Certified) 0.25FAR (Silver) 0.35FAR (Gold) 0.35FAR (Platinum) 	<p>For office buildings</p> <ul style="list-style-type: none"> 0.05FAR (Certified) 0.15FAR (Silver) 0.35FAR (Gold) 0.45FAR (Platinum) <p>For residential buildings</p> <ul style="list-style-type: none"> 0.10FAR (Certified) 0.20FAR (Silver) 0.40FAR (Gold) 0.50FAR (Platinum) 	<p>For office buildings</p> <ul style="list-style-type: none"> 0.20 FAR (Silver+20% energy efficiency) 0.35FAR (Gold+20% energy efficiency) 0.45FAR (Platinum+20% energy efficiency) <p>For residential buildings</p> <ul style="list-style-type: none"> 0.25 FAR (Silver) 0.40FAR (Gold) 0.50FAR (Platinum) <p>Multifamily residential buildings</p> <ul style="list-style-type: none"> Additional 0.05FAR (LEED +18% energy efficiency) 	<p>For office buildings</p> <p>Silver</p> <ul style="list-style-type: none"> 0.25 FAR (Energy Star score of 75) 0.275 FAR (Energy Star score of 75+ one Community Priority credit) 0.30 FAR (Energy Star score of 75+ Two Community Priority credits) <p>Gold</p> <ul style="list-style-type: none"> 0.35FAR (Energy Star score of 75) 0.375 FAR (Energy Star score of 75+ one Community Priority credit) 0.40FAR (Energy Star score of 75+ two Community Priority credits) <p>Platinum</p> <ul style="list-style-type: none"> 0.50FAR (Energy Star score of 75) 0.525FAR (Energy Star score of 75+ one Community Priority credit) 0.55FAR (Energy Star score of 75+ two Community Priority credits) <p>For residential buildings</p> <p>Silver</p> <ul style="list-style-type: none"> 0.25 FAR 0.275 FAR (one Community Priority credit) 0.30 FAR (Two Community Priority credits) <p>Gold</p> <ul style="list-style-type: none"> 0.35FAR 0.375 FAR (one Community Priority credit) 0.40FAR (Two Community Priority credits) <p>Platinum</p> <ul style="list-style-type: none"> 0.50 FAR 0.525 FAR (one Community Priority credit) 0.55 FAR (Two Community Priority credits) <p>LEED Gold plus Two Community Priority credits plus Net Zero Energy certification may earn extra density bonus above 0.55 FAR</p>

Table 1: The GFA bonus scheme in the US Source: Arlington County Government (2016), Chris Cheatham (2009), Arlington County Government (2014), Office of Sustainability and Environmental Management (2013)

3.1.3. Hong Kong

Hong Kong has implemented the GFA Concession Scheme since 2011, which grants developers GFA concession if they register the BEAM Plus or reach any level of BEAM Plus, fulfill the Sustainable Building Design Guidelines (SBDGs) and provide the prescribed building features. The floor areas of these building features they designed could be exempted from the calculation of the GFA. The prescribed building features are tailored for the specific built environment in Hong Kong to address the urgent city problems. To some extent, it is mandatory to integrate the features in order to applying for the GFA concession. For Hong Kong government, few construction costs of these building features could improve the built environment. However, for the developers and architects, design the building features and get approval from government takes time and involve approval risks, especially at the beginning of implementing the GFA Concession Scheme. With the practice of participating the scheme, industry is becoming more and more familiar with the SBDGs. The Figure 1 illustrates the statistics of applications for the GFA concession from 2011 to 2014. It is obvious that there are more and more applications and the approval rate is becoming high. This reflects the market transformation that developers could benefit from the participating the GFA Concession Scheme, and the knowledge and market demand for green buildings have increased.

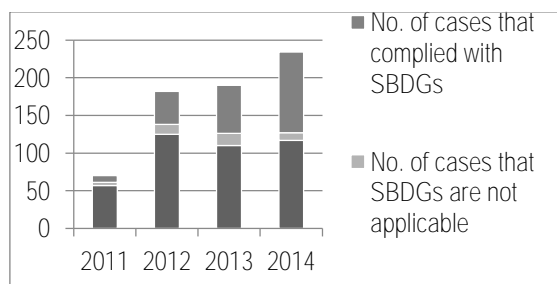

Figure 1: Statistics of applications for the GFA concession Source: Building Department (2014)

3.1.4. Comparison of US, Hong Kong and Singapore

US have longer history of GFA concession incentive to promote green building than Hong Kong and Singapore. It has developed criteria to assess market transformation of green building and detailed methods to adjust the GFA bonus with the market transformation, which has been illustrated in previous section. On the contrast, Hong Kong and Singapore are experiencing the period of trial and error. It takes time to understand how market works and improve the incentive scheme, especially for the **construction industry with several years' construction period**. Besides, unlike Hong Kong and Singapore, the Arlington County have not considered too much about local built environment. It may be because Hong Kong and Singapore has high development density and land price. The amount of GFA bonus and how to grant it would influence market and built environment more.

Hong Kong and Singapore have integrated GFA concession incentive scheme into the development control system in a different way. In Hong Kong, GFA concession is subject to the floor area of certain building features illustrated in the Building Ordinance. And the BEAM Plus and SBDG are the prerequisites of being granted GFA concession. Only obtaining the BEAM Plus certification and fulfilling the SBDG are not enough to be granted GFA concession. In Singapore, GM Platinum or Goldplus is the only requirement of getting GFA bonus. However, in the new growth **strategic areas, it's mandatory to achieve GM Platinum or Goldplus because they are the land sale conditions**. This indicates that, when Singapore government made Master Plan, they already made the plan of GB distribution.

There are different methods to calculate GFA concession in Hong Kong and Singapore as showed in the Table 2, which is closely related to the development control. In Singapore, GM GFA is relevant to land value, total GFA regulated in Master Plan and the prescribed green premium. As the prescribed green premium increases with the rating of GM, and further increase the GM GFA bonus that means more salable area, developers are motivated to construct higher ratings of GM. The land value and total permitted GFA are fixed and could be estimated, which reduce the risks to participate the GM GFA Incentive Scheme for developers in Singapore. On the contrast, in Hong Kong, most of the land value is determined by land auction and how many GFA concession developers could acquire is uncertain, bringing more uncertainties to developers. Additionally, not all the exempted floor area could be salable area. It depends on the property market and economic situations. Therefore, under the current systems, developers in Singapore have fewer risks than those in Hong Kong if they participate in the GFA Concession Scheme. In other words, the system in Singapore costs developers less.

On the other hands, the threshold (minimum standard to grant GFA concession) to participate in the GFA Concession Scheme in Hong Kong is lower than that in Singapore (Table 2). Developers only need to register the BEAM Plus that costs them much less than reaching the higher ratings of GB. This little extra cost can help them acquire the GFA concession and make profits from it. That is why after implementing the GFA Concession Scheme, the registered BEAM Plus projects have increased almost one third within one year (Liu & Lau, 2013). Moreover, developers in Hong Kong do not have to provide security deposit like Singapore to guarantee that they would achieve the certain rating of BEAM Plus they committed they apply for the GFA concession. This largely decreases the investment risks for developers. However, with the increase in GB knowledge and market demand, it is the time to adjust the incentives to reflect the market transformation.

	Hong Kong Gross Floor Area concession (since 2011)	Singapore Green Mark Gross Floor Area incentive scheme (Since 2009)
Objective	To attract developers to construct BEAM Plus building and integrate sustainable building design guideline (SBDG)	To encourage the private sector to develop buildings that attain higher tier Green Mark ratings (i.e. Green Mark Platinum or Green Mark Gold PLUS)
Assessment criteria	<ul style="list-style-type: none"> • BEAM Plus Registration (Prerequisite) • Sustainable building design guideline (Prerequisite) • Building features illustrated in the Joint Practice Notes (e.g. green features, amenity features.) 	<ul style="list-style-type: none"> • Green Mark Platinum could be awarded 2 % GFA bonus at most (subject to a cap of 5,000 sqm). • Green Mark Gold plus could be awarded 1% GFA bonus at most (subject to a cap of 25,000 sqm)
Calculation of GFA concession	GFA Concession = Exempted GFA + Disregarded GFA + GFA bonus	$GM\ GFA = \frac{\left[\begin{array}{c} \text{Proposed GFA (sqm)} \\ \text{(subject to MP allowable intensity)} \end{array} \right] \times \left[\begin{array}{c} \text{Prescribed Green} \\ \text{Premium (\$/sqm)} \end{array} \right]}{\text{Land Value (\$/sqm) (determined by proxy using DC rates)}}$
Mandatory / Voluntary basis	<ul style="list-style-type: none"> • Voluntary to participate in GFA concession incentive scheme; • Mandatory to acquire BEAM Plus certification and fulfill SBDG if developers want all the building features granted GFA concession 	<ul style="list-style-type: none"> • Voluntary for new private development (non-public sector), redevelopments and reconstruction developments to join the scheme; • For the sites where the GM Platinum or Goldplus standards are mandated as part of land sales condition, it's mandatory to reach GM Platinum or Goldplus without GFA bonus. • For the sites where the Goldplus standard is mandated, it's voluntary for developers to attain the higher GM Platinum standard and acquire an incremental GFA incentive (the difference between GFA incentives for GM Platinum and GM Goldplus).
Enforcement	NA	<ul style="list-style-type: none"> • Security deposit to guarantee that developers achieve the GB grading they committed
Minimum standard to grant GFA concession	<ul style="list-style-type: none"> • BEAM Plus registration • Provision of prescribed green features • Fulfilling the SBDGs 	<ul style="list-style-type: none"> • GM Gold Plus

Table 2: Comparison of the GFA concession scheme in Hong Kong and Singapore

4. DISCUSSION AND CONCLUSION

This paper discussed how the GFA Concession Scheme affects the costs and benefits of developers. The amount of the GFA concession and calculation method, minimum standard to grant GFA concession, as well as the costs **to fulfil different GB assessment system influence developers' costs and benefits. Hong Kong has relatively lower** threshold to apply for the GFA concession, compared with Arlington, US and Singapore, mainly because the BEAM Plus requirement to qualify for the GFA concessions is simply to register the projects, which means that buildings do not get certifications and only need to fulfil the prerequisite in each section of the BEAM Plus which costs developers little. After 5 years of implementing the GFA Concession Scheme, there are 66% (860 out of 1312) projects have registered BEAM Plus, and 21% (270 out of 1312) projects have achieved Provisional Bronze or above (Building Department, 2014). It is the right time to adjust the scheme to encourage developers to go for higher levels of GB.

Borrowing the experience from Arlington County, the adjustment of the GFA Concession Scheme could start from three aspects: 1) the prerequisite that register the BEAM Plus should increase to the BEAM Plus Provisional Bronze; 2) grant different levels of BEAM Plus buildings different amount of the GFA concession on the basis of the extra construction costs; 3) give more GFA concessions to the higher levels of GB (like Gold and Platinum).

REFERENCES

- [1] Arlington County Government. (2014). Updates to the Green Building Incentive Policy for Site Plan Projects Arlington, US: Retrieved from https://arlingtonva.s3.amazonaws.com/wp-content/uploads/sites/13/2015/08/Board_Report_291.pdf.
- [2] Arlington County Government. (2016). Green Building Bonus Density Program. Retrieved Sep. 15th, 2016, from <https://environment.arlingtonva.us/energy/green-building/green-building-bonus-density-program/>
- [3] Building and Construction Authority. (2014). Leading the Way for Green Buildings in the Tropics. Singapore.
- [4] Building and Construction Authority. (2015). Prescribed Green Premium. Retrieved June 6, 2016, from [https://http://www.bca.gov.sg/greenmark/others/Green_Premium_Rates_\(updated_Mar_2016\).pdf](https://http://www.bca.gov.sg/greenmark/others/Green_Premium_Rates_(updated_Mar_2016).pdf)
- [5] Building Department. (2014). Building Department Environmental Report 2014. Retrieved June 05, 2016, from http://www.bd.gov.hk/english/documents/COER2014_eng.pdf
- [6] Burnett, J., Chau, C.-k., Lee, W.-l., & Edmunds, K. (2008). Costs and financial benefits of undertaking green building assessments: summary report of the CII-HK research project.
- [7] Chris Cheatham. (2009). Arlington County Revises Green Building Density Program. Retrieved Sep.15th, 2016, from <http://www.greenbuildinglawupdate.com/2009/03/articles/codes-and-regulations/arlington-county-revises-green-building-density-program/>
- [8] Davis Langdon. (2007). The cost and benefit for achieving green buildings. Philadelphia PA, US.
- [9] Fan, K., Qian, Q. K., & Chan, E. H. W. (2015). Floor area concession incentives as planning instruments to promote green building: A critical review of International practices. Paper presented at the Smart and Sustainable Built Environments (SASBE) conference 9–11, Pretoria, South Africa.
- [10] Feiock, R. C., Tavares, A. F., & Lubell, M. (2008). Policy instrument choices for growth management and land use regulation. *Policy Studies Journal*, 36(3), 461-480.
- [11] Fox, G. M., & Davis, B. R. (1975). Density bonus zoning to provide low and moderate cost housing. *Hastings.Const.LQ*, 3, 1015.
- [12] Fuerst, F., & McAllister, P. (2008). Green noise or green value? Measuring the price effects of environmental certification in commercial buildings.
- [13] Kats, G., Alevantis, L., Berman, A., Mills, E., & Perlman, J. (2003). The costs and financial benefits of green buildings. **A Report to California's Sustainable Building Task Force.USA.**
- [14] Liu, Y., & Lau, S. S. Y. (2013, 2013). WHAT IS A GREEN POLICY AN ANATOMY OF GREEN POLICY THROUGH TWO ASIAN CITIES: HONG KONG AND SINGAPORE. Paper presented at the The World Sustainable Building (SB) Conference.
- [15] Miller, N., Spivey, J., & Florance, A. (2008). Does green pay off? *Journal of Real Estate Portfolio Management*, 14(4), 385-400.
- [16] Office of Sustainability and Environmental Management. (2013). Green Buildings and the Community Energy Plan. Arlington, US: Retrieved from <http://www.mwcog.org/asset.aspx?id.../aF1bWF1Y20130516115658.pdf>.
- [17] Paetz, M. M. D., & Pinto-Delas, K. (2007, 2007). From Red Lights to Green Lights: Town planning incentives for green building. Paper presented at the Talking and Walking Sustainability International Conference February.
- [18] Qian, Q. K., & Chan, E. H. W. (2007, 2007). Government measures for promoting Building Energy Efficiency (BEE): a comparative study between China and some developed countries. Paper presented at the The **CRIOCM2007 International Symposium on "Advancement of Construction Management and Real Estate**, Sydney, Australia.
- [19] Tang, B.-s., & Tang, R. M. H. (1999). Development control, planning incentive and urban redevelopment: evaluation of a two-tier plot ratio system in Hong Kong. *Land Use Policy*, 16(1), 33-43.
- [20] UNEP. (2009). Buildings and climate change: a summary for decision-makers. United Nations Environmental Programme, Sustainable Buildings and Climate Initiative, Paris, 1-62.
- [21] Yu, S.-M., & Tu, Y. (2011). Are green buildings worth more because they cost more. IRES Working PaperSeries IRES2011-023.

A Framework towards Low-carbon Heritage Conservation of Hong Kong: with Analysis of Embodied Carbon

GUO Nan^a, GU Wei^b, Edwin CHAN^c, Esther YUNG^d

^a The Hong Kong Polytechnic University, Hong Kong SAR, gail.guo@connect.polyu.hk

^b The Hong Kong Polytechnic University, Hong Kong SAR, wei.gu@connect.polyu.hk

^c The Hong Kong Polytechnic University, Hong Kong SAR

^d The Hong Kong Polytechnic University, Hong Kong SAR

ABSTRACT

Since the industrial revolution, increasing amount of CO² has been released due to the human economic activities. The human society attempt to find a balance in the game of protection and development, which not only protects the unique patterns and traditional way of life, but also allows the residents living here to enjoy the convenience that modern life has brought. To maintain and release the new vitality of the city, and tap the potential value and attraction, and respect the ecological environment, as well as make rational use of the advantages of the geographical environment in order to establish a green and sustainable living environment. Compared to new **buildings, conservation projects can reuse the existing constructions' fabric, which can reduce construction debris** through the reclamation of carbon embodied in the existing materials. The paper analyzes average embodied carbon intensities and construction costs differences of the major building components between new-build projects and heritage conservations. It aims to establish a carbon cycle model through **"calculate-reduce-offset" for the goal** of low-carbon city. The authors stress that this framework can enable balanced decision-makings concerning heritage buildings redevelopment in the context of environmental and economic sustainability.

Keywords: embodied carbon, deep building renovation, heritage conservation

1. INTRODUCTION

In the process of modernization, one of the most serious problems the human society facing is global warming, which is believed to be caused by the greenhouse gas, especially, the carbon dioxide. Since the industrial revolution, increasingly amount of CO² has been released due to the human economic activities like the combustion of the fossil fuel, the change of the land use method, etc. (IPCC, 2007). The lifestyles of human beings must be to **blame. In recent years, with the rapid development of Hong Kong's economy, the problem of the carbon emissions in new building has aroused the society's concern. In refurbished buildings, historic building and urban areas,** however, there is still not being paid enough attention.

2. BACKGROUND

Hong Kong, a region represents the economic and cultural prosperity since ancient times, attracts bunch of people to settle down with the benefits of its suitable climate, high quality of living environment and the unique scene of seaside city style. When talks about the rich historical heritage and the extraordinary beautiful urban form in contemporary Hong Kong, it must be owing to the Ming and Qing Dynasties which lasted several centuries. Finally, it formed what we can see today—a characteristic life fulfilled with Hong Kong features.

Currently, the protection mechanism of the heritage is becoming more and more perfect. A great deal of manpower and material resources has been devoted to protect the historical and cultural city by government. In March 2009, the Antiquities Advisory Board announced that the assessment of 1444 historic buildings was completed. Up to 10 September 2013, there have been a total of 942 historic buildings on the key protection list. Well, the 162 buildings with Grade 1 status in Hong Kong take up 17.2%, the 329 buildings with Grade 2 status account for 34.9% and 451 buildings with Grade 3 status account for 47.9%. Compared to new buildings, conservation projects can reuse the existing **constructions' fabric, which can reduce construction debris through the reclamation of carbon** embodied in the existing materials.

In addition, many experts and organizations set up the concept of low-carbon district or city. It is required for intensive, intelligent, green and low carbon. Therefore, the establishment of a new type of Hong Kong not only has a very broad prospect, but also has a profound and lasting significance.

Such as Tai O, which is regarded as the representative of ancient water towns, is a typical case of urban heritage in Hong Kong. The historical preservation practice of Hong Kong government advocates the exploration pioneer spirit in the world, which always plays a leading role in the whole process of heritage protection. (Yao C.L., 2009) It allows the historical and cultural heritage conservation practice in Hong Kong urban areas to be at the forefront position. In this study, the Hong Kong region as a pilot case, it takes the city representatives of historic districts, respectively. Then it plans to establish a carbon cycle model which is suitable for Hong Kong in order to establish a new-type low-carbon ancient City.

As early as 1987, the “Washington Charter” proposed that “the protection of historic urban areas should become an integral part of the overall effect of social and economic development, and also should be taken into account at all levels of urban planning and management plans.” In the process of modernization, the only if the development of ancient city will be integrated into the entire city and its operating mechanism, it’s possible to pursue the more efficient and slow-release cultural values by a spirit with more rationality and responsibility in a wider geographical area.

3. METHOD

The methods are as follow:

- Literature review method:

Obtain the information through referring to literature in order to comprehensively and correctly understand the relevant knowledge in the field of low-carbon, and also seek for the calculation method of embodied carbon and carbon emissions, as well as find out the related research factors which are needed to be collected in the survey method.

- Survey method:

Collect the practical condition of related study objects purposefully and systematically through the field visits, then use the conversation, testing and other methods to conduct a deep investigation of heritage buildings or districts so that a lot of data are collected to be used for analysis, comparison and induction.

- Case study:

The calculation methods of embodied carbon and carbon emissions are applied into the research of heritage buildings or districts to determine the value of carbon emissions per unit area in Hong Kong and emission coefficient.

- Comparison method:

Adjust the practical value which is used to build the mechanism and policy of the new-type historical and culture areas through the comparison of the different ancient districts in Hong Kong, even in Pearl River Delta.

4. MODEL

The study attempts to establish a carbon cycle model through “Calculate-Reduce-Offset”, and wishes to achieve the goal of low-carbon or even zero-carbon new-type city, in order to make the sense of sustainable development of Hong Kong come true.

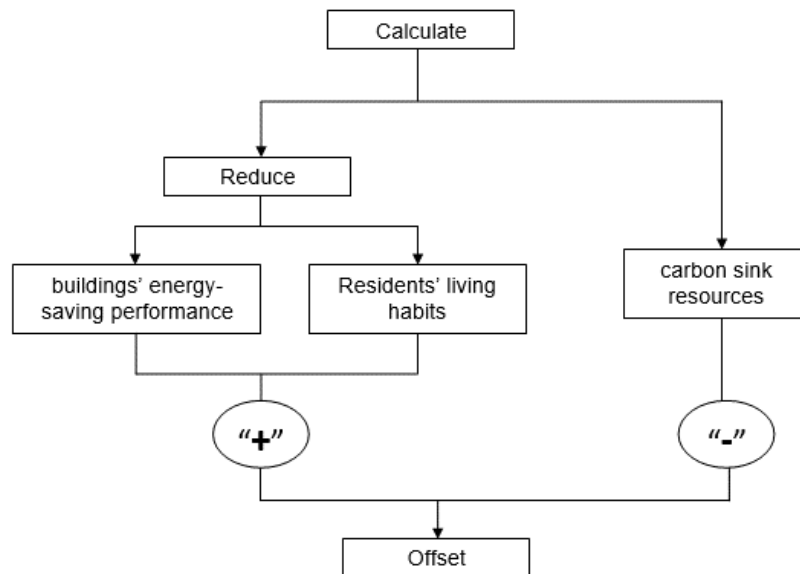

Figure 1: Carbon cycle model

4.1. Step 1: Calculate

Because of the similarity of climate conditions, natural environment, and people's living habits in Hong Kong, the value of carbon emissions per unit area can be calculated through the embodied carbon of the buildings and the carbon emissions of daily life. Thus, we can deduce the amount of carbon emissions that the same type of ancient buildings or district made in Hong Kong.

4.2. Step 2: Reduce

In comparison with the standardized modular system in modern urban constructions, the form of buildings in Hong Kong have in common is that they all have built by seas, so the embodied carbon emissions can be reduced **through the optimization of buildings' energy-saving performance.**

There is a part of residents still persists the environmentally-unfriendly living habits. By combing and optimizing the living habits of residents in Hong Kong, **the ancient districts' carbon emissions of daily life can be reduced.**

4.3. Step 3: Offset

As we all known, the majority of historic districts are constructed near seas, and some of them fronting water and with hills on the back. According to this unique natural environment, the carbon sink resources are fully abundant, which plays a very important role in ecosystem services. This study based on the unique geographical environment of historic areas, aims to finding methods for carbon neutrality.

This model aims to **establish a carbon cycle model through "calculate-reduce-offset"** for the goal of low-carbon historic districts, in order to make the sense of sustainable development of Hong Kong come true. It uses the special environment (water area, wetland, vegetation, etc.) of seaside city, mines the carbon sink resources and makes carbon offsetting strategy. In order to formulate the mechanism and policy framework for the construction of the new-type urbanization.

5. CONCLUSION

With the rapid development of economy and culture in modern society, a lot of modern crisis come into being naturally, such as the large energy consumption, ecological deterioration, disappeared culture and indifferent human feelings. **The historic buildings in Hong Kong have a beautiful historic character, and they're regarded as the intangible cultural heritage to be valued and protected.** However, the ancient buildings as the carrier of real life rather than the ornamental scenic region are inevitable to be involved in the process of modernization. As a result, **the residents' living and tourists' influx as well as a lot of carbon emissions problems come into being naturally.**

The study achieves a virtuous circle of “computing-reduction-offset” through the research of carbon cycle model of ancient districts. Such a model conducts a case study on a single village so as to seek the carbon emission coefficient which is suitable to Hong Kong and takes the unit area as a unit, and optimizes the traditional way of life to reduce carbon emissions, and actively uses the geographical environment to conduct the carbon offsets. Then it develops the mechanism to build the new-type low-carbon ancient districts through the experiment of all the historic buildings and districts in Hong Kong.

The study attempts to find a balance in the game of protection and development, which not only protects the unique patterns and traditional way of life of Hong Kong, but also allows the residents living here to enjoy the convenience that modern life has brought. To maintain and release the new vitality of ancient town and village, and tap the potential value and attraction, and respect the ecological environment, as well as make a rational use of the advantages of the geographical environment in order to establish a green and sustainable living environment.

Hong Kong has accumulated a rich experience in the protection of historical and culture buildings and villages, and has always played the important role of leader on a national scale. As the reform forward position of famous historical and culture districts, this study takes Hong Kong as a pilot case, which has a very profound significance and impact.

REFERENCES

- [1] Al-hagla, K. (2010). Sustainable urban development in historical areas using the tourist trail approach: A case study of the Cultural Heritage and Urban Development (CHUD) project in Saida, Lebanon. *Cities*, 27(4), pp.234-248.
- [2] Bullen, P. (2007). Adaptive reuse and sustainability of commercial buildings. *Facilities*, 25(1/2), pp.20-31.
- [3] Chen, T., Burnett, J. and Chau, C. (2001). Analysis of embodied energy use in the residential building of Hong Kong. *Energy*, 26(4), pp.323-340.
- [4] Chukwuma, C. (1996). Perspectives for a sustainable society. *Environmental Management and Health*, 7(5), pp.5-20.
- [5] Dalmas, L., Geronimi, V., Noël, J. and Tsang King Sang, J. (2015). Economic evaluation of urban heritage: An inclusive approach under a sustainability perspective. *Journal of Cultural Heritage*, 16(5), pp.681-687.
- [6] Gan, V., Cheng, J., Lo, I. and Chan, C. (2017). Developing a CO₂-e accounting method for quantification and analysis of embodied carbon in high-rise buildings. *Journal of Cleaner Production*, 141, pp.825-836.
- [7] ICOMOS. (1987). Charter on the conservation of historic towns and **urban areas: ‘The Washington Charter’**. Paris: ICOMOS.
- [8] Langston, C., Wong, F., Hui, E. and Shen, L. (2008). Strategic assessment of building adaptive reuse opportunities in Hong Kong. *Building and Environment*, 43(10), pp.1709-1718.
- [9] Langston, Y. & Langston, C. (2008). Reliability of building embodied energy modelling: an analysis of 30 Melbourne case studies. *Construction Management and Economics*, 26(2), pp.147-160.
- [10] Pendlebury, J., Townshend, T. and Gilroy, R. (2004). The Conservation of English Cultural Built Heritage: A Force for Social Inclusion?. *International Journal of Heritage Studies*, 10(1), pp.11-31.
- [11] Ridler, N. (1986). Cultural identity and public policy: An economic analysis. *Journal of Cultural Economics*, 10(2).
- [12] Tam, V., Fung, I. and Sing, M. (2016). Adaptive reuse in sustainable development: An empirical study of a Lui Seng Chun building in Hong Kong. *Renewable and Sustainable Energy Reviews*, 65, pp.635-642.
- [13] Throsby, D. (2016). Investment in urban heritage conservation in developing countries: Concepts, methods and data. *City, Culture and Society*, 7(2), pp.81-86.
- [14] Torres-Valcárcel, Á., Harbor, J., Torres-Valcárcel, A. and González-Avilés, C. (2014). Historical differences in temperature between urban and non-urban areas in Puerto Rico. *International Journal of Climatology*, 35(7), pp.1648-1661.
- [15] Wang, H. and Zeng, Z. (2010). A multi-objective decision-making process for reuse selection of historic buildings. *Expert Systems with Applications*, 37(2), pp.1241-1249.
- [16] Watson, P. (2009). The key issues when choosing adaptation of an existing building over new build. *J Build Apprais*, 4(3), pp.215-223.
- [17] Whitehead, M. (2003). Analysing the sustainable city: nature, urbanisation and the regulation of socio-environmental relations in the UK. *Urban Studies*, 40(7), pp.1183-1206.

- [18] Yan, H., Shen, Q., Fan, L., Wang, Y. and Zhang, L. (2010). Greenhouse gas emissions in building construction: A case study of One Peking in Hong Kong. *Building and Environment*, 45(4), pp.949-955.
- [19] Yung, E. and Chan, E. (2012). Implementation challenges to the adaptive reuse of heritage buildings: Towards the goals of sustainable, low carbon cities. *Habitat International*, 36(3), pp.352-361.
- [20] Zhang, X. and Wang, F. (2016). Assessment of embodied carbon emissions for building construction in China: Comparative case studies using alternative methods. *Energy and Buildings*, 130, pp.330-340.
- [21] Zhao, Y., Pan, W. and Ning, Y. (2015). Challenges for Modeling Carbon Emissions of High-rise Public Residential Buildings in Hong Kong. *Procedia Engineering*, 118, pp.614-621.

A Discussion on the Benefits of Environment Performance of the Promotion of Kaohsiung Green Building Specialties Policy -the Case Study on Residential Building in Kaohsiung City

KUO Yi-chun^a, OU Po-cheng^b, SHIE Chih-chang^c, SHIE Yu-chun^d

^a Shu Te University, Taiwan, kuo597@gmail.com

^b Shu Te University, Taiwan paul@stu.edu.tw

^c Kaohsiung City Government, Taiwan jimmy028@kcg.gov.tw

^d Kaohsiung City Government, Taiwan kuo597@gmail.com

ABSTRACT

"Water resource is the necessary natural resource for the development of a country's economy. According International Water Association, the total amount of annual precipitation in Taiwan is 2.6 times of the average amount of annual precipitation in all countries in the world. Thus, Taiwan should not suffer from water scarcity. However, Taiwan ranks as the 18th country with physical water scarcity.

Microclimate observation data is acquired from Central Weather Bureau of Taiwan in this research study. Other than analyzing and calculating the information from the database in order to identify the exterior microclimatic factors, the volume of the rainwater collection tanks in Kaohsiung will be calculated for its accuracy in correlation with rainwater overflow and tap water replenishment. Finally, the characteristics of Kaohsiung microclimatic factors collected in this research will be reflected with quantitative data on to the actual design for buildings in Kaohsiung. The main focuses of this research are the following:

- Analyze foundational microclimatic data in Kaohsiung
- The calculation of the volume of the rainwater collection tanks in Kaohsiung
- Provide method to incorporate and reconfigure rainwater collection tanks in accordance with Kaohsiung characteristics.

Keywords: Kaohsiung buildings, water resource, innovative design policy.

1. INTRODUCTION

According to a statistics generated from the United Nations-**Water**, **"household water consumption" makes up 10%** of global water withdrawal, indicating that disproportionate water consumption has become a common problem faced by several countries around the world. Taiwan Water Corporation reveals that in the past few years (2004~2015), domestic water consumption is maintained at a level between 257 and 265 liters per capita per day. **In terms of industry types, "industrial water consumption" and "commercial water consumption" account for the largest proportion of total water consumption, while "household water consumption" closely followed next, implying that domestic Taiwan Kaohsiung local government must take action to promote guidance policies on water recycling. However, since rainwater collection can be affected by local water production, local water consumption, microclimate change at Kaohsiung Metropolitan District, and architectural volume, while considering about water circulation, considerations in the control parameters such as "overflow" and "shortage" related to water tank's spatial volume must be included, so as to increase benefit in water resource circulation. All this have become the major motivation for this study.**

In this study, "Water Resource Sustainability Index" promoted by World Green Building Council is adopted as a solid foundation for analyzing long-term microclimate data of Kaohsiung Metropolitan District generated from Central Weather Bureau. Aside from performing statistical analysis on the big database to grasp outdoor microclimate influencing factors, total input and output volume is estimated for deciding water circulation balances in architectures located at Kaohsiung Metropolitan District. Based on the quantitative data, recommendations that suit local circumstances are proposed in response to rainwater collection analysis and global compliance rate for green buildings constructed in Kaohsiung Metropolitan District.

2. LITERATURE REVIEW

2.1. Specification related to architectural regulation in technicality in Taiwan

“Total daily water demand volume in a building” (W_t) must be calculated based on the standard given in Table 1. In other words, W_t must be calculated based on “daily water demand for individual building category” (W_f) and “floor area not including non-dwelling area” (A_f) with spatial area such as parking lot, engine room and warehouse excluded. As to building categories not included in the Table (such as gymnasium and museum), W_t must be calculated based on water demand of the architectural design. However, since there is no prominent relationship between water consumption and floor area when it comes to residential building, W_t must be calculated based on the standard of “4 members per household”, “250L of water consumption per person per day” and “total households in a residential building”.

Construction Category	Scale Category	Water consumption per unit area W_f	Total Water Consumption of Whole buildings (liters / $m^2 \cdot$ day)
Offices	Exclusively Offices	7	$W_t = W_f \times A_f$ $W_t = W_f \times A_f$ among them : A_f is the total floor area except the areas for the parking lot, the engine room, storage and elevators, stair cases and other services spaces (m^2).
	Mixed Uses	9	
Malls and Department Stores	With Food Court	20	
	Without Food Court	10	
Lodging	City Business Hotels	15	
	Multipurpose Hotels	20	
	Medium and Large Recreational Hotels	25	
Medical Centers	Local clinics, Nursing Homes	15	
	General Hospitals	21	
	Academic Hospitals	24	
School Buildings	Administrative and Academic Buildings	10	
	other	References to Others	
Dormitory	----	10	
Residential	----	----	$W_t = 250 \text{ liters} / (\text{person} \cdot \text{day}) \times 4.0$ $(\text{person} / \text{household}) \times N_f$, where N_f is the total number of households in residence, hence water consumption is calculated uniformly as households of four.
other	----	----	Calculated according to the actual demand of water construction.

Table 1: Assessment and evaluation standards for water consumption in various building categories

Daily tap water substitution volume (W_s) must be decided based on the smaller value of either daily rainwater collection volume (W_r) or daily rainwater use volume (W_d). The main reason behind this principle is that once daily rainwater collection volume (W_r) is greater than daily rainwater use volume (W_d), excessive rainwater resource will be lost without adding any benefit to water conservation.

Since “request volume of rainwater storage tank” (V_s) can affect the usage rate of rain water collection volume, total value of “daily tap water substitution volume” (W_s) multiplied by “rational multiplier of the daily rainwater use volume” (N_s) is applied as the “minimum request volume of rainwater storage tank” (V_{sm}).

Since rainwater cannot be served as drinking water, tap water substitution rate (R_c) cannot be maintained at a level that surpasses 32% of the substitutable reclaimed water, with the exception of the introduction of high-end water quality processing techniques.

“Daily rainwater collection volume” (W_r) is calculated based on overall rainwater collection system and dynamic analysis on local precipitation frequency. This kind of evaluation will present a relatively negative result in rainwater collection volume and “tap water substitution rate” (R_c) of districts with lower precipitation frequency per day.

EEWH Water Resource Indicator for Domestic Green Building

The Water Resource Indicator is one of the threshold indicators of EEWH-RS; indicator score RS8 must be greater than 1.5 to pass. WI is first calculated by tallying the points for the following water-saving sub-indicators and then converted to indicator score RS8. The calculations and scoring are as follows:

$$WI=a+b+c+d+e+f$$

Equation 1

$$\text{Water Resource Indicator Calculation } RS8=2.50 * (WI-2.0) / 2.0 + 1.5 \geq 1.5, 0.0 \leq RS8 \leq 8.0$$

Equation 2

Amongst them, RS8 stands for Water Resource Indicator Score; WI stands for water resource indicator (without unit); a stands for Toilet Score (without unit); b stands for Urinal Score (without unit); c stands for Tap for Public Use Score (without unit); e stands for Rainwater Equipment Score (without unit); while f stands for AC Water Conservation Score (without unit).

Residential Design and Encouragement Practices of Kaohsiung Metropolitan District

Article 10: Buildings under five stories with solar power facilities or greening facilities installed at roofs, roof protruding parts, or exposed platforms taking up more than 50% of legal building area can be installed with green power facilities that come with rainwater collection function.

Rainwater collection area generally refers to a part of the building such as roof and the wall. Rainwater storage system, on the other hand, is a part of the building that must be carefully considered for installation; with its volume **not only affecting overall systematic benefit but also the building designs itself**. In this research, “The Simulation and Evaluation of The Rainwater Utilization on Building Design (2000)” of Architecture and Building Research Institute (Ministry of the Interior) was adopted, with the rainwater utilization calculating software (given in Table 1) **directly derived from water recycling calculation of “The Society of Heating, Air Conditioning and Sanitary Engineers of Japan”**.

2.2. Precipitation data analysis of Kaohsiung metropolitan districts

Based on different landscapes of plain area, hilly area, alpine area, and coastal area in Kaohsiung Metropolitan District, precipitation observatory data for over a decade is applied from Central Weather Bureau as a fundamental data in this research.

Kaohsiung Metropolitan District is located in the subtropical zone with warm temperature and sufficient sunlight throughout the year. Statistics from Central Weather Bureau has revealed that minimum temperature of the district is maintained at a range between 9.6 and 11.5 degree Celsius while maximum temperature of the district is maintained at a range between 36.4 and 36.9 degree Celsius, with average precipitation volume kept at 1,845 mm over the past ten years. Despite the abundant rainfall, precipitation period is generally concentrated in a short timespan that lasts from June to August, with a periodic precipitation volume of 1,199 mm that accounts for 65% of annual precipitation volume (as presented in Table 2). In terms of season, typhoon season usually lasts from May to October while drought season usually lasts from November to April of the next year, indicating a concentrated precipitation volume **in the typhoon season**. Compared to northern district, a ratio of “precipitation volume during typhoon season” to “precipitation volume during drought season” is merely 6:4, which is not at all beneficial for water utilization.

2.3. **Citizen’s water consumption** from various building equipment

The term “water consumption per capita per day” can be referred to as “livelihood water consumption per capita per day”. According to a calculation result, water consumption per capita per day in 2013 is 284 liters, which is 34 liters more than the international standard value of 250 liters. Due to a combine factors of raising living standard, subtropical climate, warm and humid weather, and higher demand for environmental sanitary and disease control, overall water consumption per capita per day is 250 liters.

Under “Water Consumption per Capita per Day of 250 Liters” proposed by the Ministry of Interior, recycled water can be applied to replace residential water used for toilet, cleaning and other purposes, which takes up 32% of total household water consumption. Tap water substitution rate can be evaluated through the following formula:

$$PCW = Qu / (\text{Household Water Consumption} \times 0.32)$$

Usage Water Amount	Parts that cannot be replaced by Recycled water 68%				Parts that can be replaced by Recycled water 32%			total
	Bathe	Washing Food	Wash up	kitchen usage	Toilet	Cleaning	other	
Daily average	50	60	20	40	60	10	10	250

Table 2: Water consumption per capita per day of 250 liters

3. CASE CALCULATION

In this research, rainwater utilization calculation software is taken as basic calculation approach, precipitation observation value over the past 10 years is applied as fundamental data, residential buildings in Kaohsiung Metropolitan District is considered as study subjects, and rainwater utilization rate or tap water substitution rate are utilized as referential indicators for rainwater storage tank. Base area: 3478.61 m², basic Information

The above mentioned household water consumption is more difficult to be controlled by the engineering design of rainwater collection system. Under condition where rainwater collection area is kept constant, higher rainwater tank capacity and precipitation usually yield greater rainwater collection and utilization volume, which in turn increases tap water substitution rate. Please be noted that this article is written to discuss two indicators of rainwater storage design – rainwater utilization rate PRU (%) and substitution rate of tap water PCW (%), which are **different from the tap water substitution rate Rc stated in the “Technical Regulations for Rainwater Storage Design on Buildings” proposed by Construction and Planning Agency (Ministry of Interior)**. The tap water substitution rate Rc stated in the regulations can be considered as tap water substitution volume / total building water consumption.

4. CALCULATION RESULTS

4.1. General climate

According to “Technical Regulations for Rainwater Storage Design on Buildings” proposed by Ministry of Interior, recycled water can be applied to replace water used for toilet, cleaning, and other purposes. Since water volume of this kind takes up approximately 32% of total household water consumption, under condition where rainwater can be applied to replace a maximum 32% of total household water consumption, tap water substitution rate can be evaluated through the following formula (Table 3):

Calculate the average rainwater collection volume CRW (m³) per day per m².

(a) Alpine areas: $269 \text{ m}^2 \times 8.4 \text{ mm} \times 0.85 \times 10^{-3} = 2.25 \text{ m}^3$

(b) Coastal areas: $269 \text{ m}^2 \times 2.4 \text{ mm} \times 0.85 \times 10^{-3} = 0.54 \text{ m}^3$

(c) Hilly area: $269 \text{ m}^2 \times 5.6 \text{ mm} \times 0.85 \times 10^{-3} = 1.28 \text{ m}^3$

(d) Plains area: $269 \text{ m}^2 \times 4.2 \text{ mm} \times 0.85 \times 10^{-3} = 0.96 \text{ m}^3$

Calculate the average water overflow volume (m³/day).

(a) Alpine areas : $2.25 \text{ m}^3 + 156 \text{ m}^3 - 97 \text{ m}^3 = 61.25 \text{ m}^3$ (No water overflows)

(b) Coastal areas: $0.54 \text{ m}^3 + 156 \text{ m}^3 - 97 \text{ m}^3 = 59.54 \text{ m}^3$ (No water overflows)

(c) Hilly area : $1.28 \text{ m}^3 + 156 \text{ m}^3 - 97 \text{ m}^3 = 60.28 \text{ m}^3$ (No water overflows)

(d) Plains area : $0.96 \text{ m}^3 + 156 \text{ m}^3 - 97 \text{ m}^3 = 59.96 \text{ m}^3$ (No water overflows)

Calculate rainwater utilization rate PRU (%) and substitution rate of tap water PCW (%).

(a) Alpine areas : 0.38% (Rainwater Utilization Rate)

(b) Coastal areas : 1.5% (Rainwater Utilization Rate)

(c) Hilly area : 0.6% (Rainwater Utilization Rate)

(d) Plains area : 0.8% (Rainwater Utilization Rate)

4.2. Typhoon season

Calculate the average rainwater collection volume CRW (m^3) per day per m^2 .

(a) Alpine areas : $269 \text{ m}^2 \times 1487 \text{ mm} \times 0.85 \times 10^{-3} = 340 \text{ m}^3$

(b) Coastal areas : $269 \text{ m}^2 \times 601 \text{ mm} \times 0.85 \times 10^{-3} = 137 \text{ m}^3$

(c) Hilly area : $269 \text{ m}^2 \times 836 \text{ mm} \times 0.85 \times 10^{-3} = 191 \text{ m}^3$

(d) Plains area : $269 \text{ m}^2 \times 763 \text{ mm} \times 0.85 \times 10^{-3} = 174 \text{ m}^3$

Calculate the average water overflow volume (m^3/day).

(a) Alpine areas : $340 \text{ m}^3 + 156 \text{ m}^3 - 97 \text{ m}^3 = 399 \text{ m}^3$ (With water overflows 302 m^3)

(b) Coastal areas : $137 \text{ m}^3 + 156 \text{ m}^3 - 97 \text{ m}^3 = 99 \text{ m}^3$ (With water overflows 302 m^3)

(c) Hilly area : $191 \text{ m}^3 + 156 \text{ m}^3 - 97 \text{ m}^3 = 250 \text{ m}^3$ (With water overflows 153 m^3)

(d) Plains area : $174 \text{ m}^3 + 156 \text{ m}^3 - 97 \text{ m}^3 = 233 \text{ m}^3$ (With water overflows 136 m^3)

Calculate rainwater utilization rate PRU (%) and substitution rate of tap water PCW.

(a) Alpine areas : 10% (Rainwater Utilization Rate)

(b). Coastal areas : 25% (Rainwater Utilization Rate)

(c) Hilly area : 18% (Rainwater Utilization Rate)

(d) Plains area : 20% (Rainwater Utilization Rate)

In this study, rain water utilization rate of 30%, 50%, and 70% in “Water Consumption Efficiency” under LEED and rainwater utilization rate of 30%~80% under SBTool are both applied as a grading and evaluation standard. Based on rainwater storage and utilization design in “Building Technical Regulation”, new buildings with total floor areas more than 10,000 m^2 must have their rainwater storage and utilization system adequately installed.

5. CONCLUSION

The study takes into account the items specified by the LEED Green Building Evaluation of the United States which states the efficiency of rainwater usage as 30%, 50%, 70%, and the evaluation basis of rainwater recycle rate of SBTool of 30% to 80%, and is in accordance with the rainwater storage and recycling policy from “**Specification Related to Architectural Regulation in Technicality in Taiwan**” which emphasizes that new constructions with the total floor surface area greater than 10,000 m^2 is required to install rainwater recycling system. Hence, the study focuses on the data gathered from collective housing as an example and establishes the rainwater recycling rate at 30%, 50%, and 70% to calculate the average mean of the data collected. The result of the rain water recycling

rate is calculated as 1m³ per each of the studied region, and the results of each region's requirement for rainwater storage volume and the replacement rate of tap water are specified in Figures 4.

In other words, in order to satisfy the specification of "Silver Level Rainwater usage rate" of 30% declared by LEED association, the example of the collective housing in the hilly area examined in this study would only need 3m³ of rain water collection volume; for the "Gold Level of Rainwater usage rate" of 50%, the rainwater collection volume should be 25m³. In order to obtain the "Platinum Level of Rainwater usage rate" of 70%, the volume should be 35m³.

Regions in Kaohsiung and Rainwater Usage (%)	Mountainous Region	Coastal Region	Hilly Region	Plains Region	Tap Water Replacement Rate (%)	
Suitable Goal for Rainwater Recycling Usage	30%	7.5(m ³)	4.2(m ³)	3(m ³)	15(m ³)	
	Annual Saving on Water Bill	2,664 NTD / household	2,892 NTD / household	2,988 NTD / household	1,620 NTD / household	Increase 17.90%
	50%	12.5(m ³)	7.1(m ³)	5(m ³)	25(m ³)	
	Annual Saving on Water Bill	1,896 NTD / household	2,640 NTD / household	2,820 NTD / household	540 NTD / household	Increase 31.70%
	70%	17.5(m ³)	10(m ³)	7(m ³)	35(m ³)	
	Annual Saving on Water Bill	1,356 NTD / household	2,400 NTD / household	2,652 NTD / household	The same amount	Increase 43.00%

Figure 3: Calculation for the amount of increase needed for the rainwater collection volume in each of the collective housing region in Taiwan

6. ACKNOWLEDGEMENTS

Full gratitude towards Public Works Bureau of Kaohsiung City Government for giving the guidance, assistance and funding toward this study.

7. REFERENCES

- [1] Chiang, C.M.; Kuo, Y.C.; Chou, P.C., 2011, A Study on Response to Global Climate Change the Community Environment of Taiwan in the Construction of Evaluation System, Journal of Applied Mechanics and Material, EI, Vols. 71-78, Pages 3237-3241.
- [2] David Walker, Nathan Forsythe, Geoff Parkin, John Gowing, 2016, Filling the observational void: Scientific value and quantitative validation of hydro meteorological data from a community-based monitoring, Journal of Hydrology, EI, Volume 538, Pages 667-676.
- [3] Chou, P.C.*; Lee, C.Y.; Chang, K.F and Chiang, C.M., 2008, An Evaluation Index for Assessing the Indoor Environment of Sustainable Buildings in Taiwan, Indoor and Built Environment.
- [4] Chang, K.F. & Chou, P.C.*, 2010, Measuring the Influence of the Greening Design of the Building Environment on the Urban Real Estate Market in Taiwan, "Building and Environment" , EI, 45(10): 2057-2067.

Thermal Behavior of a Low-Cost House Coated with Transparent Infrared Reflective Paint

Ochuko Kelvin OVEREN^a, Edson Leroy MEYER^b, Golden MAKAKA^c

^a Fort Hare Institute of Technology, University of Fort Hare, South Africa, ooveren@ufh.ac.za

^b Fort Hare Institute of Technology, University of Fort Hare, South Africa, emeyer@ufh.ac.za

^c Physics Department, University of Fort Hare, South Africa, gmakaka@ufh.ac.za

ABSTRACT

Low-cost housing was introduced in South Africa by the newly elected government in 1994 as part of the reconstruction and development programme. Uncontrolled heat transfer in the thermal envelope of these houses result in indoor thermal discomfort. To maintain indoor thermal comfort, occupants spend excessive amount of energy on space heating. Due to total internal reflection, transparent coats can be used to reduce heat propagation through the thermal envelope. This study presents the thermal behavior of a low-cost house with the walls inner surface coated with transparent infrared reflective paint. The thermo-optical properties of the paint were analyzed using Scanning Electron Microscopy/ Energy Dispersive X-ray spectroscopy (SEM/EDX), Fourier Transform Infra-Red (FTIR) and thermal photographic technique. Meteorological indoor and ambient parameters such as; air temperature, relative humidity, solar radiation, wind speed and direction of a low-cost house were monitored. The monitoring period covers both winter and summer seasons before and after coating. The SEM image reveals that the coat is transparent to light. The presence of Al as Al₂O₃ and other elements were revealed by the EDX spectrum. In the winter season, the indoor heating degree hours were 6674.72 °C h, equivalent to 4.86 kWh/m². It was found to drop by 56% with a heating demand of 2.15 kWh/m² and 2954.33 heating degree hours, after coating. The paint was able to reduce heat lost through the building walls. It could serve as an immediate and long term remedy to low-cost housing and the emerging energy crisis in South Africa.

Keywords: community empowerment, energy saving, low-cost house

1. INTRODUCTION

Low-Cost Housing (LCH) were first introduced in South Africa by the democratically elected government, in the Reconstruction and Development Program (RDP) in 1994. The program was part of the scheme to reduce the historical inequalities due to the apartheid system of government (Madubansi & Shackleton 2006). As a result of poor craftsmanship and use of inferior building materials, LCH are often characterised by poor thermal performance (Donaldson-Selby et al. 2007; Makaka et al. 2008). Low-cost householders spend significant amount of their income on space heating to achieve indoor thermal comfort. Whereas, household that cannot afford electrical energy, result in the use of coal, paraffin heaters or thick clothing to keep warm (Klunne 2002; Department of Energy 2012).

Thermal insulation can reduce uncontrolled heat transfer through the building envelope. Thereby creating a stable year-round indoor thermal comfort. This paper presents the thermal behavior of a LCH with the wall inner surface coated with transparent infrared reflective paint.

2. METHODOLOGY

2.1 Description of the house

The Low-cost house used in this study is located in Golf Course, Alice under the Nkonkobe Municipality in the Eastern Cape of South Africa. Golf Course is geographically located at 32°S latitude and 26°E longitude at an altitude of 571 m. The local climate is characterized by a summer and mild (no snow) winter conditions, with an average dry bulb temperature of 29°C and 15°C, respectively. An average wind of 2.5 m/s is experienced in Golf Course throughout the year (South Africa Weather Service 2013). Figure 1 shows the location of Golf Course settlement and photo of the LCH used as case study.



Figure 1: Location of golf course settlement
(Source: Google earth map imagery date 10/02/2016 accessed on 12/09/2016) and photo of low-used in the study

With over 200 LCH in the settlement, a LCH with 16°NE orientation and large North facing windows was selected; compliant with the South African National Standards (SANS) 204 building design. Due to lack resources and cooperation of householders, one LCH was used as representative of the entire LCH in the settlement. Giving that more than 97% of the LCH in the settlement share the same design and building materials. The house used, comprises of a bedroom, bathroom, open plan living room and kitchen, with a floor area 41 m². The roof is made of galvanized, corrugated iron sheets with no ceiling or any form of roof insulation. The walls are made of M6 (0.39 x 0.19 x 0.14 m) hollow concrete blocks, with no plaster or insulation.

2.2 Characterization techniques

Before the walls inner surface of the house were coated, the coat was subjected to Scanning Electron Microscopy/ Energy Dispersive X-ray spectroscopy (SEM/EDX) and Fourier Transform Infra-Red (FTIR) characterisation. SEM/EDX technique were used to determine the surface morphology and the elemental constituent of the coat that is responsible for its thermal resistance (Goldstein et al. 2012). A drop of the coat sample was spread on a stub. After 24 hours, the cured film was coated with gold palladium (Au-Pd) to increase its conductivity. A JEOL (JSM-6390LV) scanning electron microscope was used to perform the SEM analysis. FTIR technique was used to determine the infra-red transmission of the coat film. The coat sample was painted on a glass slit and allowed to cure for 24 hours. The cured sample was scanned for 5 minutes to produce the infrared spectrum.

2.3 Data acquisition system

The following sensor, equipment were used to monitor the thermal performance parameters of the house. A total of 13 thermocouples were used to measure of the roof, floor, and walls inner and outer surface temperature. HMP50 temperature-humidity probe, hung at a height of 1.80 m was used to measure the indoor air temperature and relative humidity. Figure 2 shows the sensor map of the house and photo of the data acquisition system.

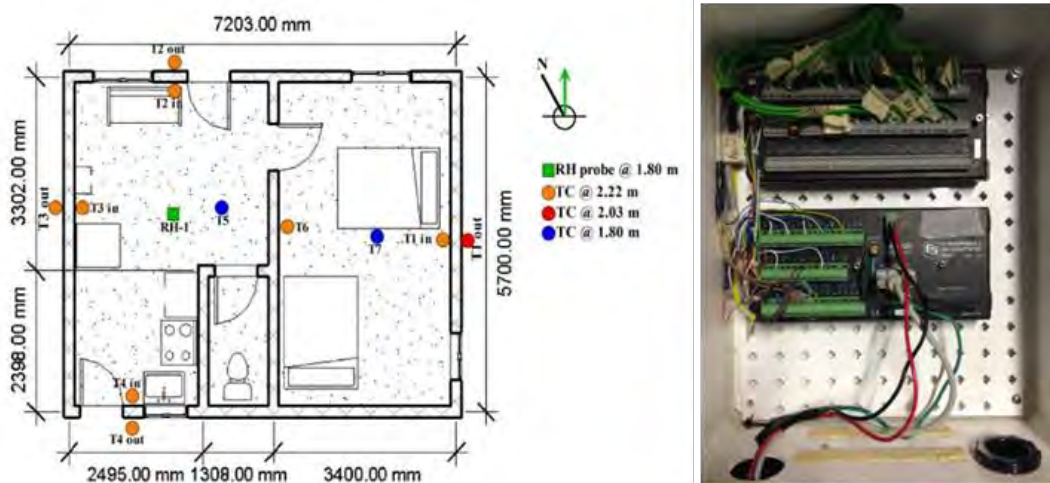

Figure 2: Location of meteorological sensors and data acquisition system

Outdoor weather parameters such as temperature, relative humidity, solar radiation, wind speed and direction were monitored by HMP50 temperature-humidity probes, LI-COR pyranometer and 03001 wind sentry anemometer and vane, respectively. The outdoor metrological sensors were installed on a weather station bracket, mounted 0.44 m above the roof of the house. Indoor and outdoor sensors were then connected to a CR1000 data logger supported by an AM 16/32 relay multiplexer, powered by a 20 V battery charged by a 20 W solar panel.

2.3.1 Thermal performance calculation

Degree-hours method of estimating thermal loads is based on the fact that thermal energy consumption in buildings is directly proportional to the difference between the indoor and outdoor temperatures. In this study, thermal load on the demand side was calculated using degree-hours. Degree-hours is determined by comparing the average indoor air temperature (T_{av}) and a reference based temperature (T_b). Therefore the number of heating (T_h) and cooling (T_c) degree-hours are given as (Kalogirou 2014)

$$DH_h = \sum_m (T_b - T_{av})^+ \quad \text{Equation 1}$$

$$DH_c = \sum_m (T_{av} - T_b)^+ \quad \text{Equation 2}$$

The +ve sign implies that only positive values are considered. Monthly or seasonal thermal load can be determine by

$$Q_{h,c} = \frac{UA}{\eta_{h,c}} DH_{h,c} \quad \text{Equation 3}$$

Where $Q_{h,c}$, is cooling or heating load (kWh/m²); $DH_{h,c}$, is the total heating or cooling degree-hours (°C h). $\eta_{h,c}$ is the efficiency of the heating or cooling system and UA is the overall heat loss coefficient (WK⁻¹) of the building.

3. RESULTS AND DISCUSSIONS

3.4. Characterisation analysis

The SEM images were produced in three different magnifications (1600X, 3700X, & 9500X), as shown in Figure 3 (a) – (c). It was revealed in Figure 3a that the coating sample is transparent to visible light and the particles are in different sizes and shapes. Penetrated infrared rays are reflected by these particles, creating a non-linear distribution of the rays. Consequently, reducing the heat transferred to the substrate.

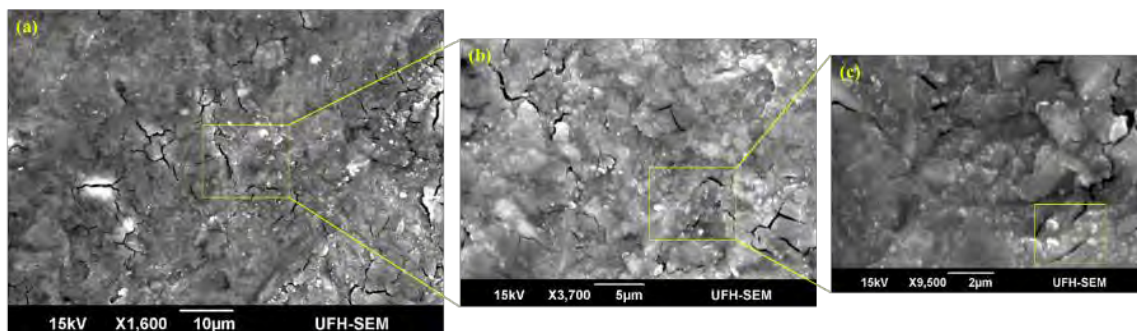

Figure 3: SEM images of coating material at 1600X (a), 3700X (b) and 9500X (c)

The elemental content of the coating sample, measured in weight (%) was determined from the yellow highlighted areas. The EDX scan shows that Al which is present as Al₂O₃ is the most dominant element. Other elements present in the coating sample and their percentage content were also identified and are summarized in the table below.

Elements	Symbols	wt (%)	Elements	Symbols	wt (%)
Carbon	C	16.45	Chlorine	Cl	3.10
Oxygen	O	31.47	Potassium	K	3.00
Sodium	Na	6.72	Calcium	Ca	0.57
Aluminum	Al	36.41	Titanium	Ti	0.04
Silicon	Si	0.91	Arsenic	As	1.04
Sulfur	S	0.27			

Table 1: Elemental composition of coating material

The FTIR spectrum of the coat sample was measured at a range of 8.0 μm to 20 μm . considering that the human body and building environment radiate maximum heat at 10 μm to 15 μm (Fang et al. 2013; Hass et al. 1997). Thus the human body and building environment is within the range of the measurement. Figure 4 shows the FTIR spectrum of the coating material.

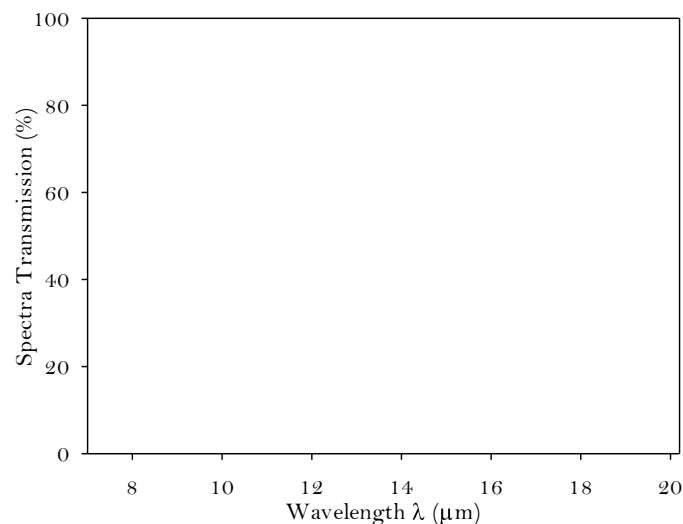

Figure 4: FTIR spectrum of coating material

The dip observed in Figure 4 implies that the coating sample has the ability to reflect infrared radiation in the thermal region. As such, it is capable to reduce heat transfer across the perimeter walls of the house.

3.2 Thermal behavior of studied house

The studied house was occupied by a middle-aged, working class lady with her daughter and toddler. It was noticed that the house is usually unoccupied during the day on weekdays, as the occupants go about their daily activities and only return at night. Also, no mechanical or fossil source of heating or cooling system were used in the house. They often use thick clothes and blankets to keep warm during the winter nights.

3.2.1 Influence of ambient weather conditions

The house was monitored for a period covering all seasons in South Africa, which are autumn, winter, spring and summer. For thermal performance analysis; June to August were considered as winter seasons while September to May represent summer seasons (South Africa Weather Service 2012; Eskom 2016). Figure 5 (a) and (b) show the indoor temperature response to the ambient wind speed and solar radiation in summer and winter seasons, respectively.

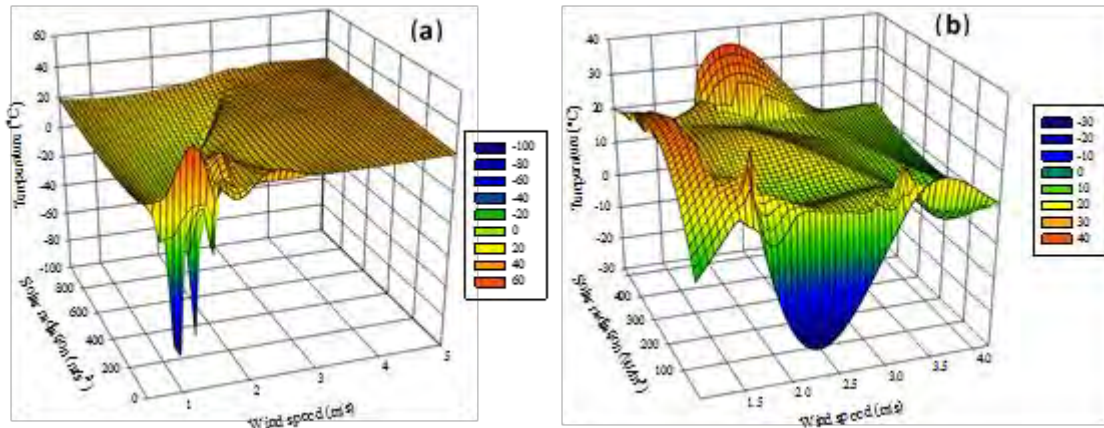

Figure 5: Seasonal indoor temperature response to solar radiation and wind speed

From Figure 5 (a) and (b), it was observed that the ambient solar radiation and wind speed have significant influence on the indoor temperature in both seasons. Increase in solar radiation results in the increase of the indoor temperature. In the summer season, increase in wind speed drifts warm air into the house. Consequently, increasing the indoor temperature; a reverse process was observed in the winter season. This behaviour of the house shows the inability of the thermal envelope to protect the habitable space from the ambient weather conditions. Although, the response to solar radiation indicate a good passive solar design features; that is useful in space heating during the winter season. It could result in overheating in the summer season. It should be noted that the temperature values in Figure 5 (a) and (b) does not depict the exact measured indoor temperature. The extreme values were as a result of the mesh stretching to fit all points.

3.2.2 Influence of thermal envelope

Figure 6(a) and (b) shows the indoor temperature and components of thermal envelope surface temperature on a typical summer and winter day, respectively. On both seasons, the roof and middle-wall temperatures were more dominant. The roof had a maximum surface temperature of 76.70°C in summer and 42.28°C in winter during the day. Whilst, the middle-wall maximum surface temperature in summer and winter season were 62.10°C and 31.90°C, respectively

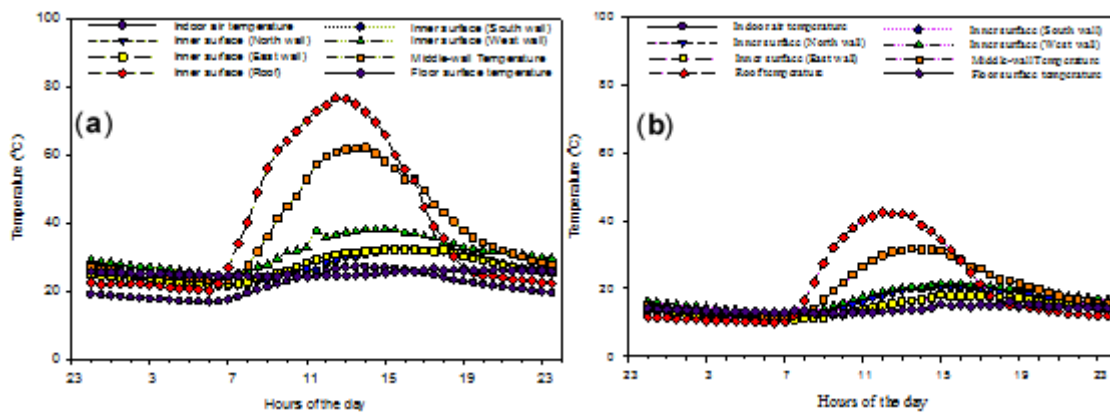

Figure 6: Typical summer daily (a) and winter daily (b) indoor and thermal envelope temperature distribution

However, the indoor temperature with an average summer and winter daily fluctuation of 10.29°C and 7.29°C, respectively was found to closely follow the perimeter walls surface temperatures. The perimeter walls average daily surface temperatures were 11.38°C in summer and 7.75°C in winter season.

3.3 Thermal impact of the coatings

The perimeter walls inner surface of the house were coated in mid-July. The entire process took three days, each day serve as a full curing period for the coats. Before applying the coats, the walls surface were wiped to remove dirt, grease or any contaminations that may lead to flaking or peeling of the coat. All thermocouples mounted on the walls surface were removed and reinstalled after curing. To determine the impact of the coatings, a reference based temperature of 20°C for heating and 24°C for cooling; was assumed (SABS 2011). Figure 7 is used to illustrate the thermal impact of the coated walls surface.

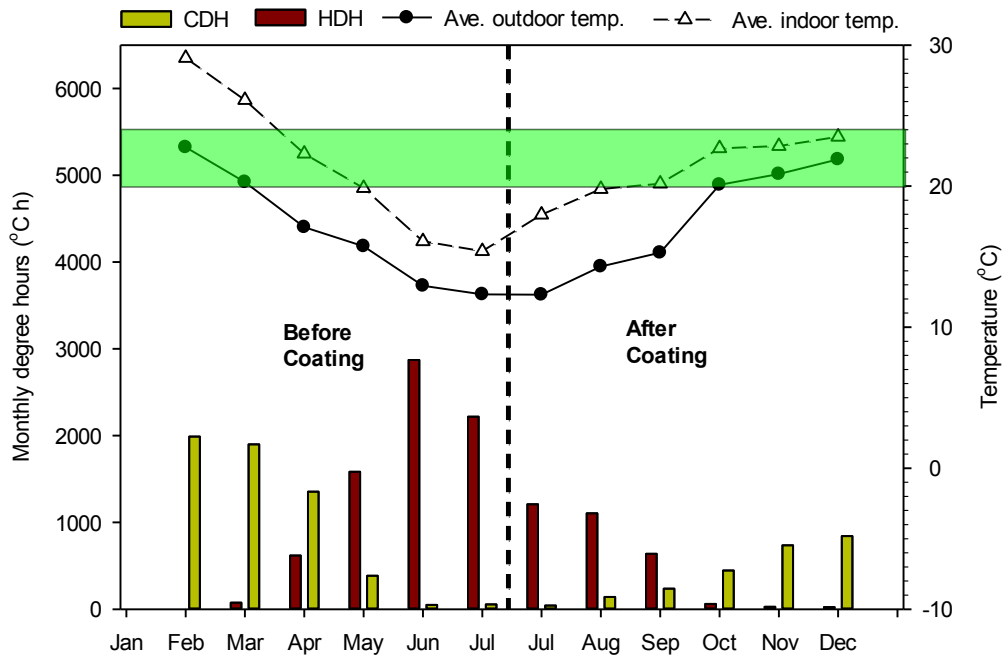

Figure 7: Seasonal thermal performance of the house

The peak thermal load period was observed in the winter season, as seen in Figure 7. During this period, the indoor temperature was completely below the thermal comfort zone. This will require 6674.72°C h of heating degree-hours to maintain the indoor temperature in the comfort zone; corresponding to a thermal load of 4.86 kWh/m². After coating, the thermal load during the peak period was reduced by 56%, resulting in a thermal load of 2.15 kWh/m². Table 2 contains the summary of the annual thermal load of the house before and after coating.

Period	Month and season	HDH	CDH	Load (kWh/m ²)	
				heating	Cooling
before coating	February – April (summer)	696.01	5243.56	0.506301	3.814341
	May – Mid-July (Winter)	6674.72	492.28	4.855415	0.358101
After coating	Mid-July – September (Winter)	2954.33	421.59	2.149078	0.306679
	October – December (Summer)	116.3	2025.57	0.084601	1.473467

Table 2: Annual thermal load

4. CONCLUSION

Energy crisis has been one of the ongoing issues in South Africa. This has seen the country experience a series of load shedding, resulting in the increase in cost of electricity tariffs. Hence, the luxury of excessive energy consumption for space heating is not economically viable to low-cost householders and result in enormous strain on the national grid. The findings of this study show that the coating material has the ability to reduce heat transfer through the perimeter walls of a house; thereby reducing the thermal load in both seasons. Adopting the coating material in newly built or existing low-cost house, will ensure year-round thermal comfort, thus reduce the thermal load.

REFERENCES

- [1] Department of Energy, 2012. A survey of energy-related behaviour and perceptions in South Africa.
- [2] Donaldson-Selby, G., Hill, T. & Korrubel, J., 2007. Photorealistic visualisation of urban greening in a low-cost high-density housing settlement, Durban, South Africa. *Urban Forestry & Urban Greening*, 6(1), pp.3–14.
- [3] Eskom, 2016. Tariff and charges booklet. Eskom Holdings SOC LTD, (April 2015), pp.1–53. Available at: http://www.eskom.co.za/CustomerCare/TariffsAndCharges/Documents/tariff_booklet_proof1.pdf.
- [4] Fang, V. et al., 2013. A review of near infrared reflectance properties of metal oxide nanostructures. , (July).
- [5] Goldstein, J. et al., 2012. Scanning electron microscopy and X-ray microanalysis: a text for biologists, materials scientists, and geologists, Springer Science & Business Media.
- [6] Hass, D.D. et al., 1997. Reflective Coating on Fibrous Insulation for Reduced Heat Transfer. , (August), p.24.
- [7] Kalogirou, S., 2014. Chapter 6 - Solar Space Heating and Cooling, Available at: <http://www.sciencedirect.com/science/article/pii/B9780123972705000066>.
- [8] Klunne, W.E., 2002. Energy efficient housing to benefit South African households. *Boiling point*, 48(48), pp.27–29. Available at: https://practicalaction.org/our-work/docs/energy/docs48/bp48_pp27-29.pdf.
- [9] Madubansi, M. & Shackleton, C.M., 2006. Changing energy profiles and consumption patterns following electrification in five rural villages, South Africa. *Energy Policy*, 34(18), pp.4081–4092.
- [10] Makaka, G. et al., 2008. The Behaviour of Low-Cost Passive Solar Energy Efficient House , South Africa. INTeh.
- [11] South Africa Weather Service, 2012. How are the dates of the four seasons worked out? WeatherSA, pp.1–4. Available at: <http://www.weathersa.co.za/learning/weather-questions/82-how-are-the-dates-of-the-four-seasons-worked-out> [Accessed May 4, 2013].
- [12] South Africa Weather Service, 2013. Climate South Africa. Available at: <ftp://ftp.weathersa.co.za> [Accessed January 1, 2013].

Dynamic Solar Shading in Sustainable Buildings

Anders HALL^a

^a *European Solar Shading Organization / SOMFY, anders.hall@somfy.com*

ABSTRACT

Never before has there been such a focus on designing buildings that work in a responsible and sustainable way. Both for the occupants, the owner and the environment. It is a well-known fact today that buildings account for significant part of the energy consumption in society. Combine this with the issues we face connected to global climate, CO₂ emissions, urbanization and overheating of buildings – and the challenge becomes obvious.

How can we assure that our buildings become energy efficient, sustainable providing a healthy working and living environment?

This Paper does not claim to have “the solution” but aims to describe an important contribution answering to this challenge. How smart and dynamic solar shading is a vital component in both new and existing buildings for health and sustainability.

Yet solar shading alone will not solve the problems. The solution lies in an intelligent combination of different measures, managed via a holistic planning/execution approach supported by local regulation and green rating systems. We will take a closer look at some of the key factors for success based on the knowledge and experience gathered via the international work done by ES-SO (the European Solar Shading organization.)

Keywords: climatic responsive architecture, high-performance building, building energy simulation

1. INTRODUCTION: THE ROAD MAP

We know where we are and have a good view of where we need to go. So we need a Road Map to show the way but, even more importantly, to anticipate eventual obstacles in our way and how to overcome them securing a successful result. Based on this we have identified the following main steps to be addressed and this Paper will mainly focus on the Awareness and Design stages.



Figure 1: The ES-SO road map

1.1 Awareness and knowledge

Today solar shading is typically referred to as a “building accessory” categorized together with furniture, carpets, curtains etc. Choice of products and fabrics has mainly been done based on colours – and not the way it should be - based on energy performance and daylight distribution properties. This need change and solar shading needs **to be identified as a “building necessity”**. But in order to achieve this we must start by addressing Awareness and Knowledge amongst Owners, Architects, Consultants, Builders, Tenants and our own Industry. The University giving a proper education on solar shading to Architects and HVAC engineers is still to be found. Further there is a common misperception that a fixed Solar Heat Gain Coefficient (SHGC), via the coated Glass alone, is the solution. Science and experience show over and over again that the SHGC’s needed are far below what coated Glass alone can provide. Then we need to add the growing demand to provide sufficient daylight for the well-being of people occupying the building. On top of it all – the weather changes constantly. Looking closer on this complex matter makes it clear that solar shading must be both smart and dynamic in order to provide the required benefits.

Early 2017 ES-SO will launch a Training Program to educate our own industry to be able to answer to all new questions relating to our products and solutions that will arise. We plan to have a certification system in place providing a quality mark for those participating and passing the exam. Further we will address the level of

knowledge within all different sectors in the building industry. But we also actively work to create a positive and co-operative approach with other industries like Glass, Facade, HVAC and Lighting.

Finally, it is vitally important to create awareness with those involved in the creation of local building regulations **and different “green rating systems”** in order to reward paying attention to optimized solutions both in terms of technical design and in working models. I would even argue that the ratings should reflect the level of investment **as well to avoid just building to achieve the “cheapest points”**.

It will be in the intelligent combination where we will find the needed solutions for tomorrow. Single smart components will only take us part of the way. To reach success we must allow for working in new conceptual ways and models.

Further to support and substantiate the claims of benefits of smart shading there is a need for Scientific and Practical research studies and documenting Best Practice examples.

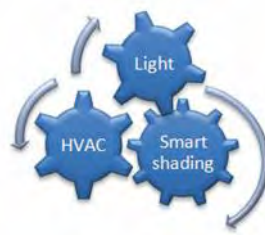

Figure 2: Authors own illustration

1.2 Design and specification

This area is where we see a strong need to **address the old “codes of conduct”**. Personally, I feel this is one of the main sections of the process where we can define the way to success or failure fulfilling the overall energy strategies and CO₂ targets being expressed by governments globally. The challenge is well illustrated by the following:



Figure 3: Source - American Institute of Architects, AIA. Authors own layout.

In most projects, at present, the main Contractor (and the Sub contractors) is involved very late in the process. At this point all specifications and detailed planning is already done leaving no room to influence or advice for better solutions in material or products to be used. It also means that the budget frames are already set limiting the room for flexibility. If this change into a more holistic and integrated approach, inviting the Contractor and Sub’s much earlier in the process, it would significantly increase the success factor when the building is brought to life, lead to better quality of integration and decrease the risk for costly mistakes. It would also optimize quality versus budget and allow for a correct way making the ROI and LCA calculations.

Co-operation is working together – not working at the same time!

2. CONTRIBUTION IN CONCRETE TERMS

Let us take a closer look at the focus areas defined for this Paper.

2.1 Awareness: Information and training

As mentioned it all starts with knowledge as it empowers people to dare facing change and to try something new. This is why we have, at ES-SO, been working on several pro-active initiatives in recent time.

- White Paper published 2015. To summarize all potential benefits via use of smart solar shading solutions both in the perspective of energy consumption, CO₂ emissions, indoor climate quality but also in terms of social economic factors
- Technical Guidebook. A free of charge reference guide to calculations and the ISO Standards and EN norms involved
- REHVA Guidebook. A co-production with the European HVAC Organization, REHVA, explaining all aspects of using solar shading as an active part of the HVAC solution in buildings
- **Training program. To be ready for implementation early 2017 and a system for “certification of competence”**
- Numerous seminars globally at Green Building Councils, Architects, M&E consultants etc

2.2 Awareness: Scientific studies

For the purpose of this Paper we have chosen to share some of results from two different and important studies carried out recently.

2.2.1. “High performance dynamic shading solutions for energy efficiency and comfort in buildings, 2015”

In 2015, to support the publication of our White paper, we commissioned a scientific study to Prof Mick Hutchins at Sonnergy Ltd, UK. This study is a combination of a) summarizing results from a selected number of published studies and b) conducting additional simulations based on technologies and material from our industry of today.

This research shows when using external shading (most effective), for Europe, a 40 - 70% cut of energy use for cooling control bringing a 10% reduction of CO₂. These numbers will of course vary depending on the global climatic zone – but we know today that, in general, the saving potential is always significant.

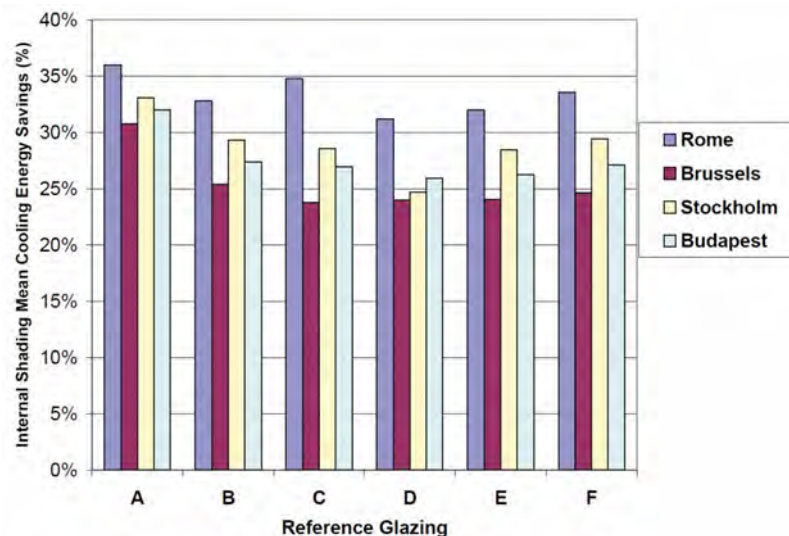

Figure 4: Potential energy savings from use of internal solar shading, ES-SO Study, 2015

This illustration is an example showing the average savings on energy for cooling using automated internal roller shades with various fabrics and combined with EN 14501 and EN 13363-1 reference glazing's.

The savings range between 24 - 36%.

Conclusion from the Study

“Efficient and effective automated control of solar shading is of the highest importance and needed to be seen within the context of the entire building design. Synergies and integration of solar shading with other building technologies is necessary to realise cost-optimal packages of energy saving measures. Highly glazed commercial buildings will not function effectively without intelligent use of automated shading.” Prof Mick Hutchins

2.2.2 “ESTIA: Global lightning performance, 2015”

This study was commissioned by the Swiss energy authorities to ESTIA SA, Mr Bernard Paule, in order to establish facts from live buildings to be used as input for updating the local building regulations on retrofitting of light installations.

The study also included a live recording on how the manual solar shading (external blinds) was actually used in real life. This is vitally important information as there are various, often wrong, assumptions being made in many leading energy simulations used by HVAC Consultants and Designers globally.

Webcams were mounted to take pictures, every office hour during one year, of the East, South and West facades resulting in approximately 500.000 pictures. Next step was to analyse the manual movements as shown below...

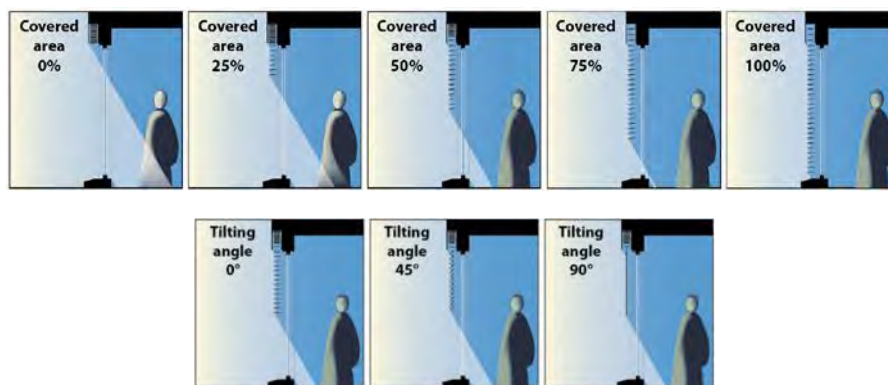

Figure 5: Criteria's for analyze of movements of manual blinds, ESTIA study, 2015

...and then to summarize the result. As shown in the table below the weighted average number of movements per week was 1.74 times only. This proves that manual shading will not be used in accordance with common simulation assumptions resulting in significant loss of potential benefits in regards of daylight provisions. Shading needs to be motorized and automated.

	East façade		South façade		West façade	
Number of blinds observed	27		40		58	
Movements 'up'	990	36.7	1115	27.9	1189	20.5
Movements 'down'	1062	39.3	1226	30.7	1421	24.5
Slat angle change	365	13.5	697	17.4	3505	60.4
Total number of movements	2417	89.5	3038	76.0	6115	105.4
Number of movements per week	48.5	1.72	58.4	1.46	117.6	2.03
Weighted average per week	1.74					

Figure 6: Summary of manual movements, ESTIA study, 2015

Conclusion from the Study

“The main conclusion of this study is that the implementation of a CONTINUOUS automation system (hourly adaptation of the blind up or down) allows a gain of several hundred hours of natural light reducing the electricity consumption for artificial lighting up to 35% while preserving the visual comfort and freedom of choice for the users.” Bernard Paule

2.3 Design: Simulation software and input data

Normally the facade specification (choice of glass) is set quite early in the design process. Not knowing enough about the potential benefits of the dynamic SHGC, U or LT values smart and dynamic shading can provide leads to specifications based on fixed values and misleading information – with overheating or very low daylight levels as a consequence. **So with the ambition to create a positive development and change in “codes of conduct” ES-SO has supported two very important and useful initiatives.** It is important to note that both these tools below are made available totally free of charge to anyone with an interest and that the information and data provided can be used globally.

This Paper cannot host a full description of all the functions and possibilities in these tools but the live presentation will give a full insight and allow for any questions to be answered.

2.8 The ESSDA database on performance information

The EU organization Qualicheck, co-funded by the European Commission, has a mission they describes follows:

“The challenges to implement Nearly Zero-Energy Buildings (NZEB) and achieving minimum shares of Renewable Energy are tremendous. There are various indications raising concerns regarding the reliability of Energy Performance Certificate (EPC) declarations and the quality of the works. Achieving a significant improvement requires strong commitment from authorities and other major players.”

This means in simple terms that all building material defined must establish an accurate way to present reliable (peer reviewed) performance data to the market and public. In response to this initiative ES-SO has created a web based platform called ESSDA (the ES-SO database). Besides general information about smart shading any global visitor will have full, and free of charge, access to performance data on a wide range of shading fabrics or obtain information that could be used in various other simulation models.

Work is also being done to establish ESSDA as an international reference platform and several simulation software providers are contacted.

This will become an important tool for Consultants and Specifiers enabling them to make sure their specifications are in line with the local compliance regulation.

For free access see References below for the web link.

2.3.2 The ESBO simulation software (early stage building optimization)

As the name suggests it is a tool that can be used for guidance in the early stages of designing a project or making choices of shading for a private residence – before it is too late to change. ESBO was created on the initiative of the SSF (Swedish Solar Shading organization), together with a leading building simulation software developing company in northern Europe, and is today fully endorsed by ES-SO Technical Committee.

In practical terms it is a simplified user interface on top of the equation based calculation model from the master software created for high level professionals.

This free version presents three possible levels of simulations:

Level 1

With just a few choices made you will receive all key values for the Shading/Glass combination selected, both with and without shading for comparison, and the calculation is made in accordance with ISO 15099.

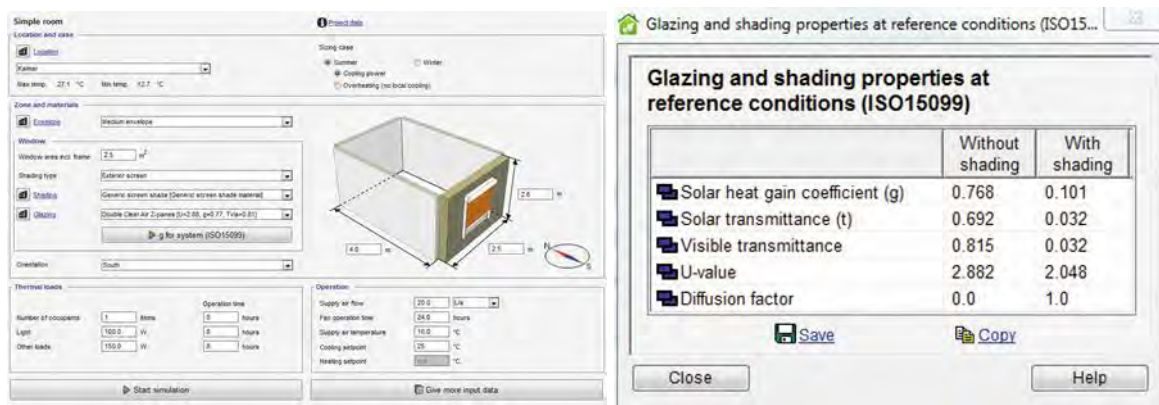

Figure 7: Screen shots from the ESBO simulation software

Level 2

By selecting global location, based on Ashrae climate data, combined with basic settings for the HVAC operation you will be able to run simulations for Cooling or Heating design cases, estimated number of annual overheating hours etc.

Level 3

This level presents a wide variety of input parameters on HVAC, floor heating, chilled beams etc. It also allows for experimenting with different control strategies on the solar shading.

For link to free download see References below.

2.4 Retrofit of existing buildings

In EU, new buildings account for 1-1,5% of the total building stock, which is probably comparative to many developed countries globally. By making only these buildings energy efficient and up to standard means a lot of years needed before we reach even close to NZeB (Nearly Zero Energy Buildings) levels set now for 2030, 2050 etc in many countries. Most buildings have already been built. To refurbish them with dynamic and smart solar shading offers an easy and cost effective alternative compared to many other options at hand like adding facade/roof insulation, changing all glass etc. It can also be applied with a minimum of interference with the present tenants.

2.5 Best practice buildings

Even if many countries still have the levels of compliance set on a quite low and simplified level there are Investors, Consultants and Architects out there that has already obtained a good understanding about the use of smart **dynamic shading having the interest and willingness to do more, do better and go that "extra mile"**.

We will share two interesting projects. 1 Bligh Street in Sydney, Australia (recently awarded Green Star 6) and the BD building in Gothenburg, Sweden (GBC Gold). Both buildings use highly glazed facades providing daylight, showing very low energy consumption and a working indoor environment with very high quality – much to the credit of the intelligent use of smart and dynamic shading solutions.



Figure 8: BD building, Sweden. Authors own picture.

Through this Paper we hope to have triggered some inspiration to start looking at the concept of smart solar shading as a new and interesting addition to the energy efficient measures needed in our buildings and the comfort, productivity and wellbeing benefits that effective solar shading brings to those who live and work in them.

(All relevant documents and free download of the ESBO software can be provided upon request.)

REFERENCES

- [1] Beck, Wouter / Dolmans, Dick / Hall, Anders / Dutoo, Gonzague. (2009). How to integrate solar shading in sustainable buildings. REHVA, Brussels
- [2] European Solar Shading organization. (2015). A new vision on solar shading. ES-SO, Brussels
- [3] Free download of simulation software, ESBO / Early Stage Building Optimization, <http://www.solskyddsforbundet.se/ssf-esbo-english>
- [4] Hutchins, Michael. (2015). High performance dynamic shading solutions for energy efficiency and comfort in buildings. Sonnergy report 15/498, UK
- [5] Paule, Bernard. (2014). Performance globale en éclairage. ESTIA SA, Switzerland
- [6] The ES-SO information database, ESSDA, <http://es-so-database.com/essodata/database.html>

The Third Success Factor of Renovations with Energy Ambitions

Anke VAN HAL^a

^a *Nyenrode Business University, The Netherlands, a.vanhal@nyenrode.nl*

^b *Delft University of Technology, The Netherlands, a.vanhal@nyenrode.nl*

ABSTRACT

Everyone acknowledges the importance of sufficient financial resources and well-functioning technologies when it comes to renovation processes with energy ambitions. However, Dutch experiences show that these two factors **alone do not automatically result in success. More is needed, and this 'more' has to do with less concrete, but in the existing living environment very influential factors such as emotions and wellbeing.** This hard to grasp factor is called **'the third success factor of energy friendly renovation processes'**.

In the Netherlands, the questions 'What exactly is this third success factor?' and 'How to integrate knowledge about this third success factor in the rational-oriented building industry?' have been put high on the agenda of people who want to achieve the national energy goals related to the built environment. Research that combines knowledge from human sciences with energy efficient renovation experiences, the development of new educational methods, and a search for success stories has been part of joined efforts to find answers to these questions. A national **knowledge platform called 'HomeMates'** has been established to bundle and share all these findings.

The Dutch experiences are described and discussed in this paper. They are also linked to Canadian experiences, based on the results of a project of Parallel52^o, the Dutch Canadian Sustainable Building and Planning network. In this project, Dutch findings and findings in the Toronto area were compared and discussed.

Keywords: renovation, housing, energy, success factor

1. INTRODUCTION

There is a widely supported feeling of urgency regarding climate change. The Paris Climate Conference in 2015 resulted in a worldwide agreement. In the swirl of activities surrounding the negotiations, cities launched initiatives too. By the time of closing, the portal listed commitments from 2250 cities. Evidently cities are taking responsibility.

In the Netherlands, climate change is also a hot topic. The national government has set goals to reduce it, several times already. The latest and most important initiative is the 2013 Energy Agreement for Sustainable Growth (Energieakkoord voor duurzame groei). In this agreement, more than forty organizations, including local governments, have laid the basis for an energy and climate policy. The purpose of the Energy Agreement is to achieve a wholly sustainable energy supply system by 2050.

Many Dutch local governments set climate change-related goals high on their agenda and many activities focus on the built environment. The built environment in the Netherlands is responsible for about 20% of the Dutch CO₂-emissions. Privately owned houses create 40% of the emissions produced by the built environment while rented houses create 25%. Housing associations own 70% of the rented houses. Since the Dutch population keeps growing, the energy consumption of the housing stock will continue to rise.

2. DUTCH ENERGY EFFICIENCY POLICIES

The Dutch national Meer-met-Minder (More-with-Less) program was initiated in 2009, with the goal to insulate 300.000 houses a year in a way that improves the energy quality with two Dutch label steps. Unfortunately, a recent evaluation shows that the program does not meet the expectations. Between 2009 and 2012 the number of dwellings that were insulated fluctuated between 200,000 and 250,000, and did not show any signs of an upward trend.

The activities of municipalities are focused mainly on privately owned houses. In this sector, many energy efficiency measures are taken. There is an upward trend in the number of houses that improved the energy quality with one measure (e.g. floor, wall, roof or window insulation, solar cells), so not the preferred combination with other energy efficiency measures (which is necessary to reach the two-label-step).

Housing associations have been active in this field for a long time as well. However, they are not as successful as expected either. The previously mentioned evaluation shows that the current target of the association of housing corporations Aedes, to bring the housing stock of their members up to an average of energy label B, will not be reached if the current pace of the progress holds.

One of the main reasons for the disappointing results is that many residents are not taking the step to a combination of measures. This is caused by the fact that for residents this is a complex decision where many aspects have to be taken into consideration. The behavioral model for energy saving behavior of tenants and homeowners (see Figure 1) show the complexity from the perspective of the government, that has to take all these factors into account. The model clearly shows that there are several motives to decide to, or to decide not to take energy efficient measures (e.g. comfort, money savings, certainty, safety, care for the environment and several emotional motives) and that there are many physical and social issues that affect the decision (e.g. age and energy performance of the dwelling, savings and income of the residents, opinion of neighbors and family). Some practical questions will come up, such as: 'Will I be living here long enough to benefit from this financially?' and 'Are the adjustments to my dwelling easy to implement or not?' But also more emotional considerations can play a part, such as: 'Will my neighbors be doing the same?' and 'Am I going to spend my money on saving energy or on a new kitchen?' Some considerations can even be very emotionally charged, like 'I'd want to, but I'm afraid of the mess and nuisance' and 'I don't want strangers in my house'.

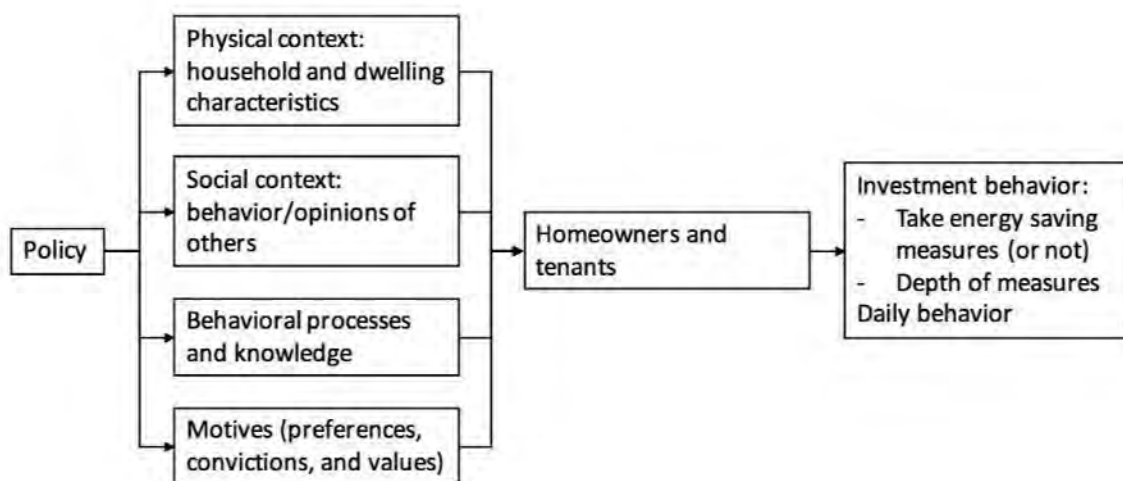

Figure 1: Behavioral model for energy saving behavior of tenants and homeowners

These last two issues introduce another factor that followed from the evaluation: professionals often assume that residents make rational decisions. Despite the fact that most governmental policies are based on the idea of a **rational and calculating 'homo economicus'**, also behavioral processes affect the decision (like loss aversion, fear for nuisance, etc.). Decisions are not always rational.

3. A MERGER OF INTERESTS

Professionals should be well prepared to handle these two aspects (complexity and emotionality). To do so, a perspective and a strategy that will be described in this paper is helpful. One of the bases of the perspective and strategy is that energy efficiency (and sustainability overall) is not an important issue for most residents. This means that it is not enough to just bring up good arguments for energy saving measures, more is needed. To compete with other products, taking energy efficiency measures in their homes has to awake some kind of enthusiasm. This **idea forms the basis of the 'Mergers of Interest'**-Perspective. This is a way of looking at the issue which assumes that people will start taking sustainable measures sooner when they also contribute to their personal desires. What keeps them up at night? What are their dreams? If professionals would succeed in combining their knowledge of energy efficiency measures with such desires, chances that the previously described problem of residents will choose for a more ambitious improvement of the energy quality of their houses will increase sharply.

A quote from the book *'Mindfield'* serves as a metaphor: **"Every time someone – male or female – saw a product that they genuinely found to be attractive, the blood flowed to a small area at the front of the cerebral cortex. The medial prefrontal cortex lit up on the photo like a flame."** Like I wrote in *'the Merger of Interests 2.0'*: **"I realized when reading Frank's words that what has occupied me now for more than twenty-five years, is this: will it ever be possible on a large scale to get people's medial prefrontal cortexes to light up if they see sustainable building materials or measures, or just think about them?"**

The Merger-of-Interest Perspective and the resulting Merger-of-Interest Strategy are related to this line of thought. The strategy enhances the chance of sustainable innovations with an integral quality, so with more qualities than just sustainability ones, which makes them more attractive for many more reasons than just energy or environmental ones. The strategy consists of three steps with a fixed sequence:

Step 1: Drawing up an inventory of the interests of people here and now (including all those involved in a project, thus including the offering parties).

Step 2: Defining sustainability measures that promote these interests.

Step 3: Seeking (innovative) funding models that make investments in such measures possible.

The following logic lies at the heart of this sequence: if you offer people something that meets their needs (helps to resolve their problems or helps to embody their ideals), an inner wish is created to have access to it (the medial prefrontal cortex lights up). Then preparedness to be creative in seeking innovative funding models also increases.

An example that illustrates the operation of the Merger of Interests approach will now be outlined: the shoe rack example. When a few years ago a graduate of the Delft University of Technology asked the residents of some portico flats about their feedback after the replacement of their heating system by a more energy efficient alternative, most of them were negative. They complained about the mess, the nuisance of the strangers in their home, the noise of the new system, and that they now had less storage space. However, the feedback of one of the projects was very positive. In that project, they installed the new systems in the hallway, in front of all the front doors. So, in this case, everyone was left with more storage space instead of less, and no strangers had to come inside the homes to maintain the system. Moreover, the system was combined with a shoe rack. This solved the nuisance of the pile of shoes in front of the front door. There was clearly a win-win situation here. After this, the residents generally appeared to have a more positive attitude towards energy saving measures. Without a thorough analysis of what is important to the residents, this solution would have never been achieved.

This example also shows the emotional charge that is associated with renovation. The previously mentioned irrational behavior is deeply studied by several scientists and is not as unpredictable as thought at first sight. The title of the inspiring book by Dan Ariely illustrates this very well: *predictably irrational*. However, psychology and behavioral economics are part of a school of science that is often neglected in the education of Dutch housing specialists. Knowledge from human sciences like psychology, behavioral economics, sociology and anthropology, is hardly integrated.

This is a missed opportunity which is clearly illustrated by the example of the payback time:

Virtually every professional who wishes to have a resident opt for energy measures works with a payback period. It concerns a simple sum: the amount of the investment is paid back over a certain period of time, because the costs for energy are lower than they were previously. Nevertheless, residents are often less enthusiastic than the professionals expect them to be. Knowledge from human sciences explains why. For example, the concept known as *loss aversion* is the natural tendency of people to attach greater importance to avoiding loss than to making a profit. Another concept that applies is *delay discounting*, where the value of something decreases instinctively with time, thus with delay. What made perfect sense rationally, becomes emotional and thus the perception changes completely.

Based on the previous, it can be concluded that to enlarge the enthusiasm of residents, professionals should look beyond just the energy efficiency measures. They have to broaden their view and not only focus on the success factors they are mainly educated in: sufficient financial sources and well-functioning technologies. Working towards a merger of interests and using existing knowledge of human sciences are important steps that should be taken.

4. THE THIRD SUCCESS FACTOR

Striving for a merger of interests by broadening the scope and using the knowledge of human sciences is what we call **'the third success factor'** (next to sufficient financial sources and well-functioning technologies), which explains the title of this paper. **This third success factor can be compared to what often is called 'the X-factor' of a successful singing performance** (next to good looks and a great voice): it also concerns a seemingly vague but undeniably influential element of success.

To support professionals by handling the aspects of complexity and emotionality several Dutch professionals, specialized in housing renovations with energy ambitions, joined forces to find an answer to the following question: **'How to integrate knowledge about this third success factor in the rational oriented building industry?'** Supported by the Dutch government they established a knowledge platform to integrate this existing knowledge in practice. **This knowledge platform is called 'HomeMates': professionals with energy ambitions working together to improve the overall quality of dwellings.**

The term 'together' is key to the message that is conveyed by the knowledge platform. It has three different meanings: wanting together (not only the professionals, but also the residents have to want it, that is why their interests have to be determined), bringing together (the interests of the residents have to be combined with the challenge of energy efficiency), and to achieve this, people have to work together.

In 'wanting together' and 'bringing together', the first two steps of the Merger of Interests strategy can be found. The third one, 'working together', relates to the fact that connecting the needs and interests of the residents with energy measures requires intense collaboration between various parties.

To communicate the third success factor as appealing and efficient as possible, various ways of transferring knowledge are conceived through the knowledge platform. Because it is known that good examples are usually being followed, **'success stories' are gathered. For professionals who really want to delve into all success factors** of housing renovations with energy ambitions, the Delft University of Technology developed a blended education program in which professionals work together with students of the university. For professionals who only want to take the online classes, an online program is currently being created. This will be in English, so interested people who are not Dutch can follow the course as well.

Since **it is known that 'experiencing' increases the chance that knowledge will actually be applied**, a half-day reality game has been developed. A lifelike situation is outlined where the professionals try to seduce residents to invest in a combination of energy efficient measures for their dwellings. In the game, professionals place themselves into the position of the different stakeholders. Besides transferring practical knowledge, the goal of this game is to improve cooperation skills.

Additionally, several half-day master classes for specific subjects are being offered, ranging from **'collaborating with residents' to 'the consequences of the third success factor on the organization of companies'**. A network of experts with a lot of experience and knowledge in the field is involved with the knowledge platform HomeMates. They developed a master class as well. When a project encounters a specific problem that can possibly be solved by using the knowledge of the third success factor, some of these experts come over for an afternoon to help them. And of course, literary sources are distributed by the knowledge platform. The knowledge about the third success factor is also transferred through blogs, tweets and discussion boards.

5. CONCLUSION

This paper will be concluded with the question if the third success factor of housing renovations with energy ambitions is typical Dutch or not. During the year 2014 this was one of the questions a group of Dutch and Canadian sustainable stakeholders focused on through a series of themed video conferences and a workshop. In this project of Parallel52°, the Dutch Canadian Sustainable Building and Planning network, they shared their experiences, insights, and recommendations, also related with housing renovations with energy ambitions.

From all of the sessions, where more questions were discussed, the outcome was assimilated into "10 Best Things to Know". **Two of these 'things' were closely related to the ideas and knowledge behind the 'third success factor': 'Energy cost alone isn't a big enough motivator for change', and 'Climate change talk is a turn off'.**

Overall, it became clear that the Dutch and Canadians have a lot in common. They are more alike than they are different. They can inform and inspire each other much more than they do now. For this reason, more knowledge about and experiences with the third success factor of renovations with energy ambitions should be exchanged.

ACKNOWLEDGMENTS

Special thanks go to Claire Broeders, Maurice Coen, Birgit Dulski, and Eleanor McAteer.

REFERENCES

- [1] Center for Climate and Energy Solutions (2015). Outcomes of the U.N. Climate Change Conference in Paris. <http://www.c2es.org/docUploads/cop-21-paris-summary-02-2016-final.pdf>. Accessed March 22, 2016.
- [2] SER (2013). Energy Agreement for Sustainable Growth: Implementation of the Energy Agreement, Summary of Energieakkoord voor duurzame groei. <https://www.ser.nl/en/publications/publications/2013/energy-agreement-sustainable-growth.aspx>. Accessed March 22, 2016.
- [3] Vringer, K., M. van Middelkoop, N. Hoogervorst (2014). Energie besparen gaat niet vanzelf. Evaluatie energiebesparingsbeleid voor de gebouwde omgeving, p16-17.
- [4] Huisman, C. (2013) Regionale prognose 2013–2040, Vier grote gemeenten blijven sterke bevolkingstrekkers, Statistics Nederland/Planbureau voor de Leefomgeving.
- [5] Meer met Minder, Wat is Meer met Minder. <http://www.meermetminder.nl/102/over-ons.html> . Accessed March 22, 2016.
- [6] Vringer, K., M. van Middelkoop, N. Hoogervorst (2014). Energie besparen gaat niet vanzelf. Evaluatie energiebesparingsbeleid voor de gebouwde omgeving, p 38.
- [7] Vringer, K., M. van Middelkoop, N. Hoogervorst (2016). Saving energy is not easy. An impact assessment of Dutch policy to reduce the energy requirements of buildings. Energy Policy 93, p23-32.
- [8] Schoots, K. and P. Hammingh (2015), Nationale energieverkenning 2015. ECN, p158.
- [9] Frank, L. (2009). Mindfield: How Brain Science is Changing Our World. Oneworld Publications (translation based on the Dutch edition of the publication).
- [10] Hal A.van (2014). The Merger of Interests 2.0, the story behind a perspective shift, Nyenrode Business Universiteit, p5.
- [11] Hal A.van (2014). The Merger of Interests 2.0, the story behind a perspective shift, Nyenrode Business Universiteit, p49.
- [12] Ariely D. (2010). Predictably irrational, the hidden forces that shape our decisions. Harper Collins Publishers.
- [13] Hal, A. van and E. Stutvoet (2015). Energy Friendly Renovation Processes, lesson 4. Blended education Delft University of Technology.
- [14] www.homemates.nl. Accessed March 22, 2016.

Thermal Performance as a Parameter of Choice of Materials: Brazilian Antarctic Station

Bruna Perovano SIRTULI^a, Filipe Galina COSTALONGA^b, Cristina Engel de ALVAREZ^c, Edna Aparecida NICORODRIGES^d

^a Universidade Federal do Espírito Santo, Brazil, brunapsirtuli@gmail.com

^b Universidade Federal do Espírito Santo, Brazil, filipegcostalonga@gmail.com

^c Universidade Federal do Espírito Santo, Brazil, cristina.engel@ufes.br

^d Universidade +A53Federal do Espírito Santo, Brazil, edna.rodrigues@ufes.br

ABSTRACT

In the atypical context of Antarctica, it must be considered the specific environmental conditions of the region in order to make the correct selection of more sustainable and efficient materials. Among them, there are the climatic characteristics, the isolation and the need to preserve the natural environment. The main goal of this research was to evaluate the thermal performance and the energy efficiency of new buildings of the EACF, (Comandante Ferraz Antarctic Station), expected to be finished in 2018, aiming to get and establish parameters for the new Brazilian buildings in Antarctica. To obtain the performance results of the station it was used the software Design Builder, and the study was conducted in two stages: at the first, the definition of the model, the characteristics and the properties of the materials specified in the project; and in the second stage it was determined the methodology for evaluations and the simulations. The results demonstrated the performance of the building envelope, allowing to evaluate the materials used, pointing out possible improvements. Alternatively it was proposed to replace the galvanized steel coating specified for the envelope, for PVC (Polyvinyl Chloride), material that showed better results regarding the thermal performance and sustainability indicators.

Keywords: antarctica, thermal performance, envelope

1. INTRODUCTION

Performance rating systems, analysis tools and certification schemes serve to contribute to a better performance of buildings; however, there are still difficulties in establishing concrete environmental criteria for buildings, which is due to the broad interpretation of the word sustainability (Smith, 2003). In this context, the concern with sustainability becomes even more important when the place to build in Antarctica where environment, landscape and architectural impact are more critical in comparison to consolidated urban areas (Reis & Alvarez, 2015).

The first Brazilian occupation in the Antarctic occurred in 1984, with eight modules of the EACF (Secirm, 2014). The Station underwent successive reforms over time, and with no formal or environmental concern (Alvarez et al., 2004). In February 2012 a fire destroyed the main body of EACF and in the surroundings were installed the MAE (Antarctic Emergency Modules), which are serving to continue the activities of the station (Mech, 2013). After the event, a public procurement process was initiated for the project of the new permanent buildings through the development of the Terms of Reference, which were aimed at the reconstruction of the Research Station in order to meet the needs of the scientific community and to serve as reference for future buildings in Antarctica (Secirm, 2014).

Considering that the new Brazilian buildings in Antarctica were designed to use innovative techniques it is justified the need for studies on the types of materials proposed especially with regard to thermal performance, aimed at improving comfort conditions. The atypical characteristics of the region suggest systemic studies to gather with less environmental impact and materials that provide energy efficiency, especially about the reduction in fuel consumption for heating. To develop the Terms of Reference that guided the design competition for the Brazilian station, several stations were studied and, among them, the Princess Elisabeth (2007), belonging to Belgium, whose technology envelope is composed of elements in laminated wood and seals composed of a set of nine layers and clad with stainless steel blades.

The Amundsen-Scott Station (2008) belonging to the USA, was built in steel with composite panels by sealing two sheets of OSB - Oriented Strand Board, and the insulation EPS, Expanded Polystyrene (Montarroyos, 2015).

Another reference is the Indian station, Bharati, 2012, built using prefabricated containers wrapped in a sealing structure in sandwich panels with external coating of steel (Montarroyos, 2015).

The old EACF facilities were composed of metal containers made of sealing sandwich, filled with polyurethane. Now, the new facilities will use major structures of high-strength steel (Montarroyos, 2015), to obtain favourable conditions for the improvement of performance and thermal comfort. Considering the technology adopted for the new buildings of EACF, the research aimed to evaluate the thermal performance of a room with high exposure - at the corner of the building - considering as conditioning the material proposed in the project and the possible use of PVC as outer covering of sandwich panels.

2. METHODOLOGY

The research was established from three main stages: characterization of Antarctica and the Comandante Ferraz Antarctic Station; modeling and simulations; and evaluation of thermal performance.

2.1 Characterization of antarctica and the comandante ferraz antartic station

Antarctica has unique environmental characteristics: low temperatures, strong wind gusts, isolation and preservation of the natural environment, which induce a process of human occupation in a sustainable way (Cruz et al., 2007). The Comandante Ferraz Antarctic Station was established in 1984 in the Keller Peninsula of King George Island (Alvarez, 1995). Since its settlement, the EACF passed through several expansion and modification processes, performed with the inherent concerns about the environmental impact and the possible interferences in the local ecosystem, due to poor planning of the previous design (Alvarez et al., 2007).

The new buildings of EACF are being built on the same site of the former, on Keller Peninsula (Figure 1). Its design dates from 2013 and its construction has forecast for completion in the year 2018, according to the Air Defence and Naval (Defesa Aérea e Naval, 2016). The various proposed settings for the station have a total built area of 4,500 m² formed by functional blocks and UIS - Isolated Units (Unidades Isoladas), which in its full configuration will form the basis for the operation of activities and research.

The area of laboratories was designed to meet many requirements, emphasizing the priority of the PROANTAR (Brazilian Antarctic Program) for scientific activities (Brazil, 2012). The project was developed considering the best practices of sustainability and should result in a facility of excellence, the highest quality, to promote its main goal, scientific research (Estudio 41, 2013). The set was designed from containers, which will later be covered by a system composed of insulating material with properties that mitigate the effect of salt spray and low temperatures (Figure 2).



Figure 1: Scheme of keller peninsula location. Source: Brasil (2012)



Figure 2: Comandante ferraz antarctic station. Source: Comissão Interministerial para os Recursos do Mar (Interministerial Commission for Sea Resources) (2013)

2.2 Modeling and simulations

The climatic conditions of Antarctica were obtained through the weather file EPW, *EnergyPlus Weather* for the year 2002 (Laboratório..., 2015). For the simulations, the conditions of the study area were considered, the windows do not have the any ventilation function and, thus, the model was configured as a closed space. The architectural typology adopted for the simulations was the design of the new EACF buildings of and the room, a laboratory with two external walls (worst situation). The reference values of thermal properties of building components related to the envelope, as well as the characteristics of clothing and activities performed by the laboratory users are shown in Table 1. The clothing and the activity simulate the real indoor working conditions in Antarctica, as well as the type of environment used.

The proposed design for the envelope are sandwich panels consisting of two external surfaces made from galvanized steel coil of 0.75 mm thick, each one coated with PVDF (Polivinilideo Fluoride) paint, internal layer of rigid PUR (Polyurethane) foam, with a distance of 50 cm between the wall of the container and the envelope. The panel is used to cover the outer vertical seal. The floor and has two types, one with 220mm and other with 170mm (Reis & Alvarez, 2015).

It was adopted for the comparative study an exterior coating of PVC, replacing the steel sheet while maintaining the same thermal insulation. PVC is a material consisting of 57 % of chlorine and 43% of ethylene, thermoplastic material and is the second most produced worldwide (Instituto do PVC, 2016).

The simulations were carried out for the Laboratory of Molecular Biology and its environmental conditions (Figure 3). This room is located in the functional block, 5.29 m above the ground (Figure 4). The Laboratory is located at one end of the blocks, having two of its walls exposed to the weather, one facing north and the other facing east. The simulations were carried out for the summer period (21/ Dec to 21/ Mar) and the winter period (21/ Jun to 23/ Sep).

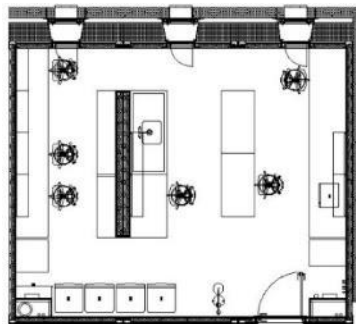

Figure 3: Floor plan of molecular biology laboratory.

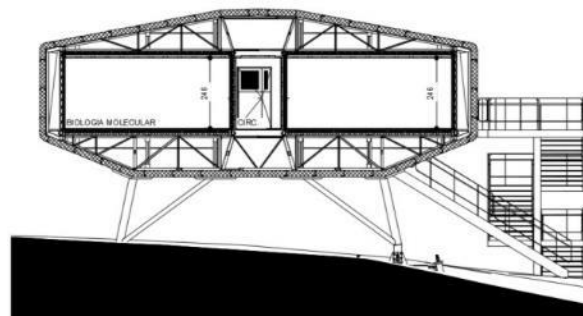

Figure 4: Section plane of the function block where the laboratory of molecular biology is located. Source: ESTÚDIO 41, 2013

Internal walls and envelope		
Internal Walls: corrugated steel plate (container), stud "C" in galvanized steel (70 mm), rock wool 70kg / m ³ (70 mm), polyethylene sleeving 2.5 kg / m ³ (2 mm) , cast on 2 plates with non-combustible fiber additive (12,5 mm each)	15 cm (thickness)	
Thermal transmittance floor, walls and ceiling (U)	0,185 W/(m ² .K)	
Ceiling	12 cm (thickness)	
Thermal transmittance of the triple insulating glass (U)	1,1 W/m ² .K	
Thermal transmittance of the window aluminum frame	5,8 W/m ² .K	
Envelope modeling (1): galvanized steel sheet (0.75 mm), polyurethane (205 mm), galvanized steel sheet (0.75 mm)	22 cm (thickness)	
Envelope modeling (2): PVC (2 mm) , polyurethane (205 mm) PVC (2mm)	24,5 cm (thickness)	
Occupied environment and internal loads		
Density and Occupation	0,15 person/m ²	
Metabolism Activity: light work of laboratory	123 W/person	
Occupancy Standard: 6 people- 07h00 – 20h00		
Walls and ceilings	*Emissivity (ϵ)	** Absorptance (α)
Steel plate	0,30	0,30
Metal stud	0,30	0,30
Rock wool	0,90	0,60
Polyethylene sleeving	0,90	0,70
Plasterboard	0,90	0,50

Table 1: Properties of the materials of the layers of the walls, ceiling and floor. Source: Drawn from Studio 41 (2013) and Design Builder (2015)

2.3 Thermal performance evaluation

For the evaluation of thermal performance conditions it was used the hourly operating temperatures and comfort temperature defined by ISO - International Standard 7730 (International ... 2005). The criterion to define the comfort temperature was based on the type of activity involved in the laboratory work; clothing of 0.5 clo for summer and 1.0 clo for winter, considering the best category (A), and from this combination resulted a comfort temperature of 23 °C. For environmental thermal performance evaluation indicators proposed by Nico-Rodrigues (2015) were used, which made possible to analyse the hourly changes in operating temperature, for summer and winter.

2.4 Indicators

The indicators used for the systematization of data were the FDT – Frequência de Desconforto Térmico (Frequency of Thermal Discomfort) and GhDT – Graus-horas de Desconforto Térmico (Degrees-hours of thermal discomfort). These results were used as input in the buoyancy diagram.

The FDT quantifies the number of hours of discomfort, in percentage during a certain time interval, and its maximum value refers to the maximum time limit. To set this percentage of the whole time, the the percentage at which the operating temperature is above the maximum comfort temperature is used. In this study, the proposal was to analyze daily periods, of 24 hours, corresponding to a maximum frequency of 100%.

The GhDT is the difference between the hourly operating temperature and the comfort temperature when the operating temperature exceeds the defined value of the comfort temperature established for the month under study. To obtain the maximum reference value it was adopted the highest value of GhDT, considering all the features of the model and climatic conditions. For the analysis of FDT and GhDT indicators was adopted the buoyancy diagram, which considers the assessment of the frequency on two levels: temporary and frequent; and the intensity condition for the degree-hours, light and intense levels (Figure 5).

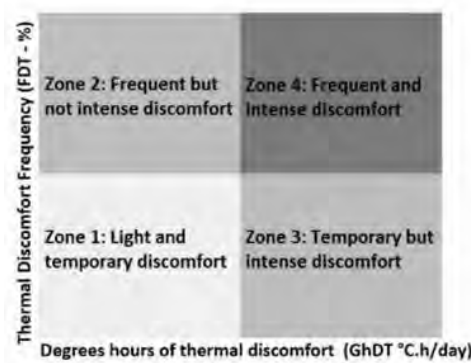

Figure 5. Buoyancy diagram FDT and GhDT indicators. Source: Nico-Rodrigues, 2015

3. RESULTS AND DISCUSSIONS

3.4 Determination of conditions

The results defined the internal hourly air temperature of the Molecular Biology Laboratory aiming to determine the environmental thermal performance with emphasis on thermal comfort using in your envelope galvanized steel and PVC. The results were subjected to statistical treatment to set the maximum amounts of daily GhDT, which is the reference value used for laboratory analysis with the two materials (Table 2).

Seasons	Material	GhDT
Winter	Galvanized Steel	170,20 °C.h/day
	PVC	170,15 °C.h/day
Summer	Galvanized Steel	166,4 °C.h/day
	PVC	300,5 °C.h/day

Table 2: Maximum reference values for GhDT at each station. Source: Authors

3.5 Simulations

The simulations made possible to assess the environmental thermal performance according to the materials used in the envelope, especially the use of artificial heating as a strategy for thermal comfort. The first series of results showed the internal conditions of the Molecular Biology Laboratory with the use of galvanized steel in the envelope and, afterwards, the results that would be achieved with the PVC replacement.

The values of FDT and GhDT obtained for each day are shown in the buoyancy diagram, characterizing the conditions for thermal comfort (Figure 6). It should be noted that the buoyancy diagram relates the values of FDT with the highest value of GhDT of each season of the year, demonstrating the daily situations, being the best condition that converges to the origin.

The results of performance simulations have shown that the use of galvanized steel in the envelope, partially meets the conditions for thermal comfort determined by the ISO 7730 standard as well as the use of PVC, using a comfort temperature of 23°C. The ISO standard allows some temperature variations, being temperatures of 19 °C be still within the norm, which increases the amount of hours within the comfort limit. And with the use of PVC obtained better performance results compared to the previous situation, especially in the summer season. It was observed that the results of the FDT and GhDT indicated two levels of discomfort for the simulations with the steel - being them levels (A) and (B) - and three levels for the simulations with PVC - which are (A), (B) and (C) - where (A) means days of frequent and slight discomfort; (B) days of frequent and intense discomfort; and (C) days of temporary and mild discomfort.

The results showed both for summer and winter an uncomfortable environment, but the comparative analysis between the two simulated materials showed that a better indoor environment is achieved if the PVC is used in the envelope. Observing the analysis of materials separately in both seasons, it was found that in the envelopment with galvanized layers, the temperature values remained constantly below the comfort threshold, classifying the discomfort as intense, and a FDT common in winter. In summer the temperatures remained below the limit, but the discomfort is rated as mild to intense, and the FDT remained intense.

In the simulations with layers of PVC, temperature values remained below the comfort limit in winter, with a few days with some hours within the limit, classifying discomfort as frequent, and an often FDT. In summer there was an improvement in the results, almost all days are presenting all hours within the comfort limit, but with a few days still below the threshold, being the discomfort classified as intense or temporary, and FDT ranging from heavy and light.

The adoption of PVC, as an alternative material, would improve the results; however, it is not enough to achieve the optimal results. It is suggested that the wall exposed to the weather also has a spacing of approximately 50 cm, already adopted in the other external wall, serving as attenuator space, which holds a layer with temperature at 10 °C, since this construction proposal has proved effective in other situations analyzed. It is possible to obtain better results using different types of thermal insulation defined according to the physical and thermal properties, greater or lesser thermal inertia. It is noteworthy that the Belgium station, for example, is classified as the most efficient among the studied station due to, between other factors, the adoption of nine insulation layers with properties that potentiated the thermal efficiency of building.

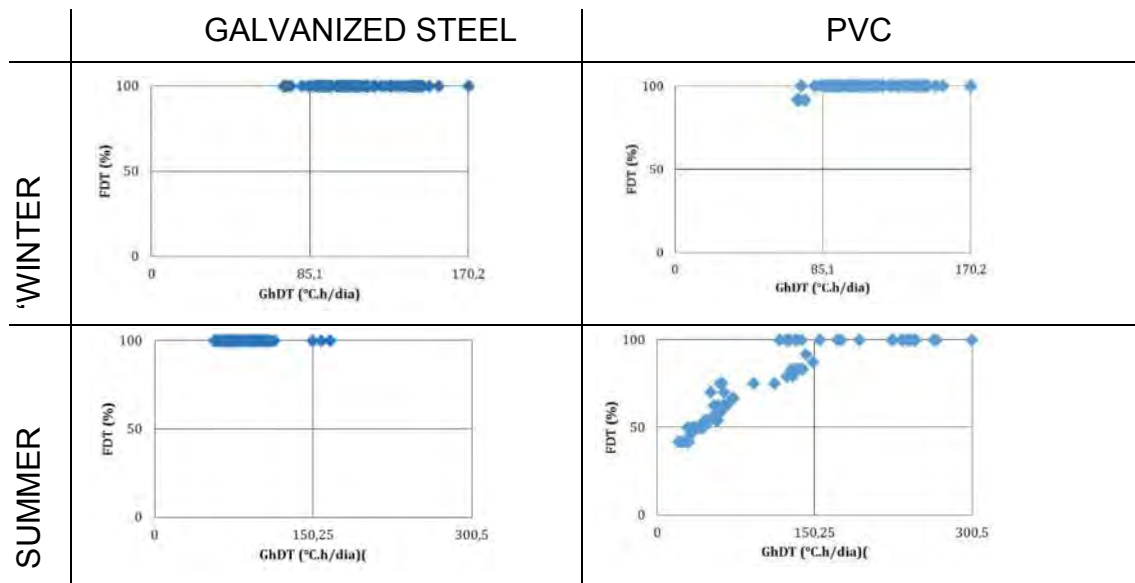

Figure 6: Buoyancy diagrams of the summer and winter seasons. Source: Authors

Another likely factor responsible for improving internal conditions is the incidence of solar radiation and the different behaviour of steel and PVC in the outer layer. In the summer period, the amount of solar radiation is much bigger and keeps the temperature in the space between the panels heated a lot longer. Although the PVC is thinner, its performance is better than the steel plate, as it can be observed in the Spanish station Juan Carlos in which was used a similar material in the form of modular rings of plastic fiber.

4. CONCLUSIONS

From the analysis made with the methodology adopted, it was possible to understand the environmental performance for the buildings in Antarctica, focusing on thermal comfort. The daily fluctuations in the operating temperature guided to solutions aimed at improving the thermal comfort and the indicators allowed the understanding of the internal conditions of the environment.

It is important to know that the building system from containers surrounded by a second outer layer coating on the sandwiches panels is a technique whose maintenance activities may be carried out by the Navy in Rio de Janeiro, which has a lot of experience in such activities in Antarctica. Studies with the use of PVC in the Antarctica environment are still in the initial process, and those results are an incentive for continuity, because it was realized that the model with PVC had an improvement in the results when compared to model that used steel. However, it should be noted that the two construction solutions still require further developments to meet the requirements of the adopted standard.

ACKNOWLEDGMENTS

This research was supported by the National Council for Scientific and Technology - CNPq and the Foundation for Research of Espírito Santo- FAPES.

REFERENCES

- [1] Alvarez, C. E. de. 1995. Arquitetura na Antártica: ênfase nas edificações brasileiras em madeira. 1995. Dissertação. Faculdade de Arquitetura e Urbanismo da Universidade de São Paulo (FAU/USP), São Paulo.
- [2] Alvarez, C. E. de; Casagrande, B.; Soares, G. R. 2007. Resultados alcançados com a implementação do plano diretor da Estação Antártica Comandante Ferraz (EACF). In: Encontro Nacional, 4 e o Encontro Latino Americano sobre Edificações e Comunidades Sustentáveis, 2. Campo Grande: 2007.
- [3] Alvarez, C. E. de; Casagrande, B.; Cruz, D. O.; Soares, G. R. 2004. Estação Antártica Comandante Ferraz: um exemplo brasileiro de adequação ambiental. In: I Conferência Latino Americana de Construção Sustentável e 10a. Encontro Nacional de Tecnologias no Ambiente Construído, São Paulo. Anais do **ENTAC'04. São Paulo: ANTAC, 2004. P. 1-15.**
- [4] Brasil. Comissão Interministerial para os Recursos do Mar. SECIRM. 2014. Retrieved from: <<https://www.mar.mil.br/secirm/documentos/reconstrucao/caracterizacaoEACF.pdf>> [Retrieved on 1 april 2016].
- [5] Brasil. 2016. Defesa Área e Naval. DEFESA AÉREA E NAVAL. Retrieved from:<<http://www.defesaaereanaival.com.br/tag/estacao-antartica-comandante-ferraz-eacf/>>. [Retrieved on 1 april 2016].
- [6] Carlos, E. 2016. Aplicação do PVC na Construção Civil. São Paulo. Retrieved from: <http://www.institutodopvc.org/publico/?A=conteudo_link&co_id=122>. [Retrieved on 16 May 2016].
- [7] Cruz, D. O.; Alvarez, C. E. de; Reis, N. C. 2007. A qualidade do ar interior da Estação Antártica Comandante Ferraz – EACF. In: Encontro Latinoamericano de Edificações e Comunidades Sustentáveis, Campo Grande, 2007. ELECS.
- [8] DesignBuilder. 2015. DesignBuilder Software Ltda. Version 4.5.0.128. 2015.
- [9] Estúdio 41. 2013. Memorial descritivo de especificações: caderno de encargos. Curitiba.
- [10] Fanticele, F. B. 2011. Avaliação de conforto térmico na Estação Antártica Comandante Ferraz. 2011. 118f. Dissertação (Mestrado em Engenharia Civil) – Universidade Federal do Espírito Santo, Vitória.
- [11] ISO International Organization for Standardization. 2005. ISO 7730 Ergonomics of the thermal environment– Analytical determination and interpretation of thermal comfort using calculation of the PMV and PPD indices and local thermal comfort criteria. Switzerland.
- [12] Laboratório de eficiência energética em edificações. 2015. Seção Downloads. Arquivos climáticos em formato EPW. Retrieved from: <<http://www.labee.ufsc.br/downloads>>. [Retrieved on 16 april 2015].
- [13] Mech, K. 2013. How hard-wall Expandable Containers helped Brazil recover from Antarctic disaster. 2013 Innovation: Journal of the association of professional Engineers and Geoscientists of BC (British Columbia), Burnaby, 17(3): 200-22.
- [14] Montarroyos, D. C. G. 2015. Indicadores de sustentabilidade para edificações na Antártica. 2015. 150f. Dissertação (Mestrado em Arquitetura e Urbanismo) – Universidade Federal do Espírito Santo, Vitória.
- [15] Nico-Rodrigues, E. A. 2015. Influência da janela no desempenho térmico de ambientes ventilados naturalmente. 2015. 202f. Tese (Doutorado em Arquitetura e Urbanismo) – Univercidad del Bio- Bio, Concepción.
- [16] Reis, T. C. dos; Alvarez, C. E. de. 2015. Análise do ciclo de vida da Envoltória da Estação Antártica Comandante Ferraz. In: Euro-ELECS. Portugal.
- [17] Silva, V. G. 2003. Avaliação da sustentabilidade de edifícios escritórios brasileiros: diretrizes e base metodológica. 2003. Tese (Doutorado). Escola Politécnica da Universidade de São Paulo.

Track 3: Advancing SBE Assessments

Session 1.5 SBE Assessments - Green Neighbourhoods (1)

LEED Certification and the New Standard of Sustainable Construction in Colombia

Andres PELAEZ^a, Alexander GONZALEZ^b, Laura MARIN^c

^a Universidad Pontificia Bolivariana, Colombia, andres.po.6@hotmail.com

^b Universidad Pontificia Bolivariana, Colombia, alexandergonzalez@upb.edu.co

^c PVG Arquitectos, Colombia, lauramarin@pvgarquitectos.com

ABSTRACT

The Decree 1285 of 2015 is the new standard for sustainable construction in Colombia, with technical parameters and design guidelines adopted by Resolution 0549. This normative has increased public and private interest in the subject, in order to develop a sustainable construction industry. However, there is a lack of technical and practical knowledge in architects and builders, and the recent process of training on sustainability guidelines and its relation to the standard are insufficient to shape a critical mass for its application in architectural process. This situation constitutes a commercial opportunity for the promotion of LEED certification in Colombia and their representatives. They having publicity stated in academic events and media, that compliance with a LEED certification is enough to fulfil the guidelines of the Sustainable Construction standard. However, this statement lacks technical support, turning a model of visual, media and distorted sustainability. This paper evaluates the real water and energy consumption of an office building with LEED Gold certification in Medellín and its relation to the sustainable construction standard, with the aim to determine if a building with LEED certification can reach the goals established by the Colombian standard. The results show differences of 172% in energy consumption and 81% in water consumption between the real and the expected consumption. This suggests that there is no guarantee to meet the standard through a payment of a foreign system, but it threatens the expectation of sustainable construction in Colombia.

Keywords: sustainable design education, sustainable construction, LEED certification

1. INTRODUCTION

The Decree 1285 of 2015 is a new standard in Colombia that proposes sustainable construction guidelines for buildings, aimed to improving the quality of life of inhabitants and to promote the implementation of actions with environmental and social responsibility from the construction industry (Ministerio de Vivienda Ciudad y Territorio Republica de Colombia 2015a)

In order to apply the Decree 1285, technical parameters and design guidelines were adopted by Resolution 0549 of July 10th, 2015 (Ministerio de Vivienda Ciudad y Territorio Republica de Colombia 2015b). This resolution is intended to establish minimum percentages of consumption and saving strategies of water and energy in buildings, through the adoption of the Sustainable Construction Guide (Annex 1 of Resolution 0549), with the intention to project an efficient operational life of buildings.

While these situations occur, either a positive application of the rule from the updating and training of professionals or a critical rejection against to implementation of a regulation that can be weakly promoted by the State, it is also expected a model of commercial opportunism, associated with the sale and purchase of LEED certification in Colombia. In other words, the construction sector is in risk of continuing and increasing the practices of pseudo-sustainability as Greenwash, in response to the standard of sustainable construction (González et al. 2012)

According to the previous statement, professional associations assigned to the United States Green Building Council (USGBC), are seeking the implementation of LEED certification system in the country without a critical review of it, from a technical and economic point of view. The process of analysis and marketing of LEED system, developed for seasonal weather conditions, is applied without any consideration of geographical and climatic conditions of the diverse regions of Colombia. In opposite to this condition is necessary to emphasise that

Resolution 0549, have as a starting point for the energy efficiency and saving water analysis, the incidence of four types of climate differentiated for major regions of the country.

However, after the publication of the Decree 1285 in 2015, academic events and public declarations took place, in which it was stated that 182 projects in Colombia, until July 2015, where LEED certifications were applied, which sums up to a total of 3.7 million m², "... [They] come surpassing the minimum efficiency established by the guidelines for saving water and energy in buildings..." (Consejo Colombiano de Construcción Sostenible 2015).

Given this situation, it is necessary to establish from an objective point of view, if the application of the LEED system in Colombia is valid and a guarantee to fulfil the requirements of the Decree 1285, with its statutory Resolution 0549. This analysis is, therefore, the overall objective of this article, developed by professionals and researchers in the field of bioclimatic design, energy efficiency and sustainable construction in the Colombian context, with more than 15 years of experience.

2. METHODOLOGY

To perform this research, an office in Colombia, was taken as a study case. This building has a LEED Gold certificate, under the application of the system LEED O + M: Existing Buildings v3 - LEED 2009 (U.S. Green Building Council 2009), which focuses on existing buildings and certifies the operations and maintenance activities, has implemented. The study case is localised in Medellín, Colombia, city with a mild weather according to the Resolution 0549 (Annex 2). The building has a built office area of 50,000 m², and an average population of 4,000 people.

Based on the consumption data on energy and water obtained from an internal source of the analysed building (Alis Restrepo 2014), correlations between aspects of LEED certification and Decree 1285 were made, with analytical work performed in two stages:

2.1 Analysis of LEED O + M and the respective results of the case study

The scope of the first stage corresponds to the study of the chapters of the LEED certification, with the purpose of identifying the requirements to obtain it. The information is reviewed from the certification guide in the web page of LEED System (U.S. Green Building Council 2009). In this process, the points of energy efficiency and water efficiency are checked to determine the level of sustainability that compliance with these factors represent for the classification.

Finally, public information recorded in the study case "scorecard" is reviewed to determine its particular level of performance in energy and water, connecting their level of certification as a sustainable building. This information is available online in the LEED system, from where it was taken (USGBC 2016).

2.2 Theoretical exercise of application of resolution 0549 on the building

In a second stage, verification of energy and water performance of the study case building were made. Real consumption of energy and water were analysed, regarding energy consumption and water from the guideline of resolution 0549. It was calculated the level of savings required in the study case, according to the percentages of mandatory reduction in water and energy consumption, according to their use and the climate zone where the project is located.

The analysis conditions for the study case correspond to an office building located in mild weather. The baseline type indicated by the resolution 0549 is presented in Table 1. The table shows the values for all the weathers and it is highlighted the mild weather, where the building is located.

Office Building Baseline	Cold	Mild	Warm dry	Warm humid
Energy Consumption (kWh/m ² /year)	81,2	132,3	318,2	221,3
Water Consumption (l/per/day)	45,0	45,0	52,0	45,8

Table 2: Baseline of energy and water consumption for an office building according to resolution 0549. Adapted of Ministerio de Vivienda Ciudad y Territorio (2015b)

Starting from the consumption per m² benchmark, the expected water and energy consumptions were projected, considering the building area and its population. It is important to emphasize that the estimated data will correspond to a building that does not include sustainability criteria. Afterwards, the savings percentages established by the Resolution were applied, considering those percentages that will be required at a national level from 2017. The percentages of water and energy savings are presented in Table 2.

Saving percentages relative to baseline of office buildings (%)	Cold	Mild	Warm dry	Warm humid
Energy	30	30	40	30
Water	30	35	45	20

Table 3: Percentages of savings for office buildings in the second year of implementation of the resolution. Adapted of Ministerio de Vivienda Ciudad y Territorio (2015b)

With the projections of the buildings consumption and the reductions needed according to the parameters of the Resolution, the case should ensure savings of 30% in energy and 35% in water, regarding the benchmark defined for the weather of Medellin. Therefore, it will be expected that a building with energy efficiency and water saving criteria should reach the consumptions calculated. Regarding the objective of this paper, especially a building with LEED certification, as the study case, should have a consumption with the savings calculated, according to the affirmations of the Consejo Colombiano de Construcción Sostenible (2015).

3. RESULTS

3.6 LEED certification O+M and score of study case

According to the checklist of the LEED v4 for Operations & Maintenance: Existing Buildings, there are 110 potential points. Figure 1 shows the range to different certificates depending on the obtained points.



Figure 34: LEED certification rating system. Based of online checklist (USGBC 2014)

The points are classified into 7 categories: Sustainable sites (26 points), water efficiency (14 points), energy & atmosphere (35 points), material & resources (10 points), indoor environmental quality (15 points), innovation (6 points) and regional priority (4 points). Figure 2 shows the seven categories and its respective points.

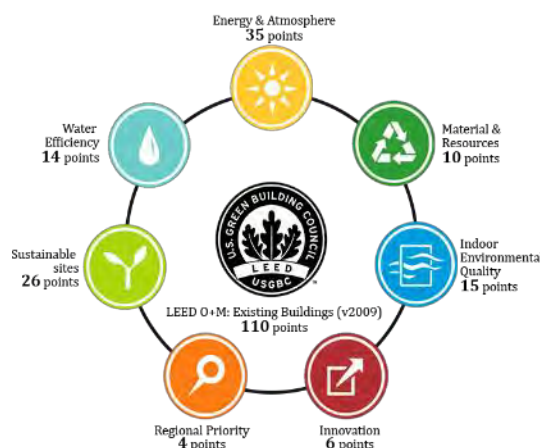

Figure 35: Categories LEED O+M and assigned points. Based of online checklist (USGBC 2014)

With this information, it is possible to deduce that, even if no significant scores are reached in energy and water, whose values added are equivalent to 49 points, it could be obtained from a Certified to a Gold certification level, with the 61 points remaining in the other categories.

The LEED certification process requires the fulfilment of three conditions related to energy and atmosphere: Monitoring the consumption of the building, not using cooling gases with high impact on the greenhouse effects and to be subjected to an assessment of energy performance, executed under Energy Star system's parameters. The report on that last condition will only determine the points to be certified for energy, without conditioning the level of certification for a minimum range of compliance. The water efficiency category only has one prerequisite, a minimum indoor plumbing fixture and fitting efficiency. Is worth noting that the use of efficient fittings, is part of the national normative about hydraulic performance of buildings since 1998.

Figure 3 shows the case study scorecard summary. The study case reached a total of 73 points of 110 possible. Only 33 of those are related to the performance of the project on water and energy use, out of a total amount of 49 achievable points on these topics in the LEED system.



Figure 36: Study case scorecard. Source: USGBC (2016)

The energy and water points obtained by the case study, only represent 45% of the possible certification points. A detailed view of the points in water and energy categories does not find a direct relation to the requirements associated to Resolution 0549 (Figure 4), although energy certification points are developed under a model of analysis Energy Star that may be used in the methodology for the Colombian standard. However, this analysis is developed with a database of buildings in climate, economic and cultural contexts different to the Colombian context.

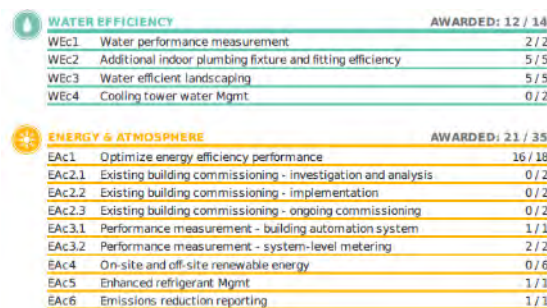

Figure 37: Detailed points for water and energy categories. Score obtained by the study case

3.7 The study case expected performance according to resolution 0549 and real consumption of the building

If is considered that a LEED certified building can exceed the minimum ranges of energy and water efficiency established by Resolution, a LEED Gold certification should be near or above to the maximum level range to reach the application of the regulation in its full implementation. In order to determine this aspect, it is necessary to know the real consumption of the building and its relation with the expected performance according to Resolution 0549.

The data of annual energy consumption of the study case over the past six years, are presented in Figure 5. It is important to highlight that since the entry into operation of the building in 2010, it has reduced its energy consumption by 23% by 2015, passing from a consumption of 16,640,867 kWh in 2010 to 12,762,052 kWh in 2015, thanks to the internal management.

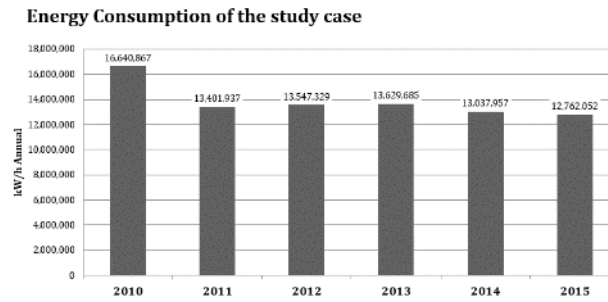

Figure 38: Annual energy consumption of study case 2010 to 2015. Source: Building operator, 2015

The energy consumption includes spaces for a different use from offices, which are responsible for 3% of annual energy consumption of the building, equivalent to 7623 kWh of the 12,762,052 kWh consumed in 2015. Consequently, the analysis will be performed with a value of 12,634,428 kWh annual, corresponding only to the office consumption.

The results of the energy consumption projection and energy consumption goal according to the baseline in the Resolution 0549 are presented in Table 3. The energy consumption projection is calculated based on the built office area of the building, excluding parking lots and areas with different uses, equivalent to 50,000 m².

Energy	
Built area Case of Study (m ²)	50,000
Baseline (kWh/m ² annual)	132.3
Average annual energy consumption of study case (kWh)	6,615,000
Mandatory percentage reduction (%)	30%
Annual energy consumption goal of study case (kWh)	4,630,500

Table 4: Energy consumption projection and energy consumption goal. Based in Ministerio de Vivienda Ciudad y Territorio (2015b)

The data in Table 3 show that in the study case, an office building located in a mild weather, with 50,000 m², would have a baseline annual consumption of 6,615,000 kWh. Applying the 30% mandatory reduction is determined that the annual energy consumption, should be 4,630,500 kWh. Faced this benchmark, the consumption of the last year of the building, estimated at 12,634,428 kWh, exceeds the baseline in 8,003,928 kWh annual, i.e. 172%.

Regarding water sub-item, Figure 6 shows the values of global consumption the years 2014 and 2015, only data available from the building operator.

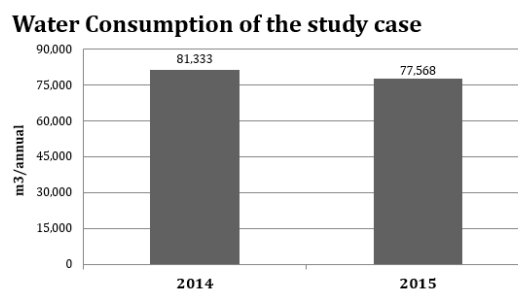

Figure 39: Annual water consumption of study case 2014 and 2015. Source: Building operator, 2015

The results of the water consumption projection and water consumption goal according to the baseline in the Resolution 0549 are presented in Table 4. The water consumption is calculated based on 4000 people, average population in the building.

Water	
Total of people in the building	4000
Baseline (l/person/day)	45
Average annual water consumption of study case (m³)	65,700
Mandatory percentage reduction (%)	35%
Annual water consumption goal of study case (m³)	42,705

Table 5: Water consumption projection and energy consumption goal. Based in Ministerio de Vivienda Ciudad y Territorio (2015b)

In relation to the baseline of the Resolution, the study case with 4000 people using the building, would have an annual base water consumption of 65,700 m³ as shows Table 5. Applying the mandatory percentage of reduction corresponding to 35%, a total of 42,705 m³/ year of water is obtained as consumption goal. Therefore, it is established that the current consumption, corresponding to 77.568 m³/ year of water in 2015, is 81% above the limit of savings defined by the Resolution.

4. CONCLUSION

The analysis carried out in the study case as a benchmark of a certificated LEED Gold building and its comparison with Resolution 0549, allows to identify the level of complexity that must be anticipated by architects and builders to face the immediate implementation of the new standard for sustainable construction in Colombia, the Decree 1285, from several aspects. The first one refers to a necessary criticism approach, to the analysis process of baseline and savings percentages defined by Resolution 0549.

However, this theoretical exercise was made with an existing building and it is possible that the differences found in this research may be produced because they were not originally designed under efficiency parameters and recommendations of the guide attached to the Resolution, even when it is a sustainable building with a LEED certification. Remains then the possibility that only new buildings, designed under efficiency parameters and according to the Design Guide, have the option of reaching the level of demand required by the Decree. This affirmation should be the subject of an investigation, after this work and in an urgent way, because the imminent entry into effect of the Decree 1285 and its Resolution 0549.

The results of the study case, a building with a LEED Gold certification, facing the efficiency ranges of Resolution 0549, show differences in performance of 172% in energy consumption and 81% in water consumption. This suggests that the guarantee to achieve the requirements of the Resolution, through a payment of a foreign seal, distorted in its own origin, is not only naive but an ethical irresponsibility against the expectation of sustainable construction.

Furthermore, a review of the LEED system allows identifying that according to its operation, the certification can be obtained without significant scores on energy and water items. Although it is necessary to fulfil some prerequisites, the level of energy efficiency and water consumption that these can mean for a building in a context like the Colombian, and its relationship to the new standard of sustainable construction in this country, is still a topic under review.

However, this highlights the need for local responses to achieve a real systemic sustainability, through public policies that are already being implemented in some cities, and the real commitment of the building sector to reach goals beyond a certification or standard compliance. The paper should finish with a conclusion which provides the major points of your paper.

REFERENCES

- [1] Alis Restrepo, J.E., 2014. Metodología para la evaluación energética de edificios comerciales en Colombia basados en estándares y normas internacionales. Universidad Nacional de Colombia.
- [2] AMVA & UPB, 2015. Política Pública de Construcción Sostenible para el Valle de Aburrá. Lineamientos 1st ed., Medellín. Available at: <http://www.metropol.gov.co/construccionsostenible/Pages/inicio.aspx>.

- [3] Consejo Colombiano de Construcción Sostenible, 2015. Gobierno Apoya la Construcción Sostenible con la Guía para el Ahorro de Agua y Energía en Edificaciones. Observatorio de la Construcción Sostenible, pp.1–5.
- [4] Edwards, B., 2006. Guía básica de la Sostenibilidad 2nd ed., Barcelona: Gustavo Gili.
- [5] González, A., Isaza, J.C. & Penagos, G., 2012. LEED certification in Colombia :At the edge between sustainable design and greenwash. Proceedings - 28th International PLEA Conference on Sustainable Architecture + Urban Design: Opportunities, Limits and Needs - Towards an Environmentally Responsible Architecture, PLEA 2012, (November). Available at: <http://www.scopus.com/inward/record.url?eid=2-s2.0-84886800469&partnerID=tZOtx3y1>.
- [6] Menassa, C. et al., 2012. Energy Consumption Evaluation of United States Navy Leed Certified Buildings. Journal of Performance of Constructed Facilities, 26(February), pp.46–53. Available at: <http://scholar.google.com/scholar?hl=en&btnG=Search&q=intitle:Energy+Consumption+Evaluation+of+U+.+S+.+Navy+LEED-Certified+Buildings#3>.
- [7] Ministerio de Vivienda Ciudad y Territorio, 2015a. Decreto 1285 de 2015, por el cual se modifica el decreto 1077 de 2015 - Decreto Único Reglamentario del Sector de Vivienda, Ciudad y Territorio, en lo relacionado con lineamientos de construcción sostenible para edificaciones, Colombia.
- [8] Ministerio de Vivienda Ciudad y Territorio, 2015b. Resolución 0549, Colombia. Available at: <http://www.minvivienda.gov.co/ResolucionesVivienda/0549-2015.pdf>.
- [9] Scofield, J.H., 2009. A Re-examination of the NBI LEED Building Energy Consumption Study. Energy Program Evaluation Conference, (October), pp.764–777.
- [10] U.S. Green Building Council, 2009. LEED 2009 for Existing Buildings Operations and Maintenance Rating System, Washington. Available at: <http://www.usgbc.org/resources/leed-2009-existing-buildings-current-version..>
- [11] USGBC, 2014. Checklist: LEED v4 for Building Operations and Maintenance. Available at: <http://www.usgbc.org/resources/checklist-leed-v4-building-operations-and-maintenance>.
- [12] USGBC, 2016. Proyectos LEED en Colombia. Available at: <http://www.usgbc.org/projects?keys=Colombia>.

Comparison Study of China's Eco-City Key Performance Indicator Systems

DENG Wu^a, Ali CHESHMEHZANGI^b, Ayotunde DAWODU^c, WANG Bingyu^d

^a University of Nottingham Ningbo China, Mainland China, wu.deng@nottingham.edu.cn

^b University of Nottingham Ningbo China, Mainland China, ali.cheshmehzangi@nottingham.edu.cn

^c University of Nottingham Ningbo China, Mainland China, ayotunde.dawodu@nottingham.edu.cn

^d University of South California, United States of America, bingyu022@outlook.com

ABSTRACT

China's rapid expansion of urbanisation level has inevitably brought severe pressures on resource conservation and environmental protection in Chinese cities. China has initiated policies, strategies and pilot projects at both national and local level to address these urban challenges. China appears in the frontline of reshaping and redeveloping the urban environments by promoting eco-city projects in recent years. Key performance indicator (KPI) system has been long time used for evaluating the success of urban projects. It has become a pivotal to guide the development of eco-city projects in China. This research paper first elaborates the current practice of using KPI systems as a mean to achieving eco-city development; and will then take a comparison study between various eco-city KPI systems currently being used in China. By identifying the common issues and specific issues from the reviewed KPI systems, this research indicates that there are some convergences amongst different systems. Future eco-city KPI systems may need to consider these common issues, and incorporate the local contexts in tandem.

Keywords: KPI, eco-city, China, urban sustainability

1. INTRODUCTION

A plethora of new city concepts have entered policy and planning discourse all in the wake of understanding that man cannot continue to prosper socially and economically without careful consideration of how it affects the environment. Experts suggest that **our activities can no longer be sustained by 1 earth alone, with man's ecology** resources and services being used at rate of 1.5 earths and if nothing is done would require more than 2 earths to replenish (Global Footprint Network 2013).

These concepts stem from various literature seeking to identify and achieve sustainability largely based on the triple bottom approach i.e. society, economy and environment, thus concepts such as sustainable cities, eco-cities, green cities, knowledge cities, smart cities, low carbon cities, resilience cities etc. have become titles which policy makers and developers aspire to achieve in pursuit of their own innovative contextual understanding of sustainability (de Jong, 2015). In order to achieve these cities, which represent at some level, a focus on all or particular dimension in sustainability, embedded eco-city wide projects have been embarked on by various nation particularly China. This concept is guided by the use indicators that identify important urban development issues, measure and set standard to be achieved in order to address sustainable development. However, de Jong (2015) identifies the interchangeable use and mix up in terminologies particularly by policy makers, planners and developers. A good example is the Chinese city of Guangzhou which is working with the Singaporean government on an urban development project named the Guangzhou Knowledge city yet the indicators used are noted to be **"eco-city indicators"**(Crane et al. 2012; de Jong et al. 2013). Another pitfall is the contextual nature which these indicators are noted to be developed by i.e. what might be noted as important in one region may not necessarily be deemed worthy in another e.g. compact design versus dispersed city design (Sharifi, 2013). This would suggest that indicators used to define Eco-cities for instance in Dongstan China may fall short of the mark in Shanghai. Nonetheless, indicators are noted to be the flywheel of this debate and by understanding their divergence and convergence we move closer to developing a set of standardised indicators which may be uniformly adopted in a region or sub region with particular emphasis on eco-cities. This then begs the question what are eco-city indicators, why such interchangeability? And how do we achieve parity?

In pursuit of answering this question, Neighborhood Sustainability Assessment Tools (NSATs) is also reviewed due to their international origins, and will be compared and contrasted with embedded eco-city frameworks within the region of China. As such this papers aims to tackle the question raised by practically identifying common and

context specific indicators for eco-city, by establishing there points of convergence and divergence with case study focus of 6 tools, 4 city wide and 2 Neighborhood sustainability based tools within Location in ChinaContent

1.3 The eco – phenomenon

The ideology of an Eco system dates back to the 1970s by members of a voluntary organization Arcology group who strived to redevelop the concept cites living in tandem with nature (Dongtan 2008). Richard Register a co funder of urban ecology as well as the author of eco-city Berkely building cities for healthy future, defined eco-city as a conceptual city focused on the governance and living within the means of the natural environment (Premalatha et al. 2013). With looming environmental crises due to climate change as well, as other related issues such as health and energy poverty. The need for this concept and form of governance has been embraced by a myriad of academics policy makers and developers, with various attempts to interpret this general definition into practical and workable principles city wide construction and implementation (de Jong, 2015).

This venture, however, has not led to a definitive definition of eco-city as no agreeable definition has emerged till date (Premalatha et al. 2013; de Jong, 2015). Joss (2015) addresses the plausible reasons for this event. Firstly, it is suggested that diversity and ideas set in specific locales and governed by traditions as well as competition between various actors has led to the lack of cohesion. Secondly, this lack of coherence is simply an inevitable process towards agreeance, as the current phase could be seen as experimental to be followed by a phase of consolidation leading to more agreeable international norms. However, Joss (2015) also warned that this lack of agreeance by definition may lead to a conceptually vacuous principle i.e. lacking content with a threat of its application being applied for promotional and market fashionable services. Nonetheless, de Jong (2015), who also identifies the terminological fuzziness and confusion, stresses a need for clarification into distinct categories in relation to specific application. This argument invariably endorses the context dependency of eco city and its implementation of its indicators.

Joss (2015), however still argues that irrespective of its contextual proclivities another major reason for lack of definition is that eco cities are inherently future oriented. The reasoning here is that unlike other conceptual cities such as low carbon cities and resilient cities which more definitive in purpose, e.g. reduced pollution, renewable energy use, liveability etc. The form to which eco-city will take is still invisible looking towards the future. This **argument is further solidified Richard Registers claims, suggesting that “eco city is an Ecological city, and no such city Exist”**

Nonetheless, this should and has not stopped academics and practitioners from striving ever closer towards a unified definition as such Literature provides a myriad of definitions and indicators, qualitative and qualitative in nature which address the eco-city dimensions. For instance Newman and Jennings (2008) link eco cities closely with ecosystem thus creating indicators and principles based on that dimension, Lehman (2010, 2015) relates eco-city to urban development principles with emphasis on infrastructure and environmentally friendly buildings. Suzuki et al innovatively linked eco-city to economic prosperity with the terminology Eco2city, with the basis of its principle being ecologically considerate and economically viable. However de Jong (2015) argues that this leads the concept away from ecology and into a more sustainable arena. This can be seen in older publications by Roseland (1997, 2001) research, which identified 10 attributes pertinent to eco-city. Yet at least 5 out of the 10 refer to socio-economic issues.

- Prioritize land use and create a diverse and compact diverse, green and safe mixed use communities surrounding public transport facilities
- Should focus on transportation systems that would discourage driving and focus on proximity access
- Prioritize the remediation and restoration of damaged urban environment
- Prioritize affordable, safe and economically mixed housing
- Should promote equity and social justice and create improved opportunities for the impoverished
- Prioritize and focus on local, agriculture, community gardening and urban greening
- Promotion of recycling and resources conservation in addition to the reduction hazardous waste and pollution
- Should focus on ecologically derived and sound activities while discouraging those that increase pollution
- Focus on simple and environmentally conscious lifestyle while discouraging excessive consumption of material goods

- Prioritize the promotion of public awareness on the environment and bioregion through education and outreach programs

These descriptions while containing environmental and ecological prerogative have other concepts which promote economic prosperity and social consciousness. Over time the onset of eco-city has acquired a variety of conceptual meanings as shown above, especially as the process of eco-city drives towards policy development and practical implementation, especially in Asia and as such interweaving concepts such as social and economic dimension have become prominent, thus leading to softened environmental focus (de Jong 2013). Moving from the principles of Roseland and Register to the near future of post Brundtland report, the eco-city dimensions are noted to drive from the principles of triple bottom line approach or the 3 pillars of sustainability which is further conditioned by sustainability led dimensions such as urban design, governance and systems (World Commission on Environment and Development 1987). These dimensions are also generally categorized by indicators, specified with details, based on time frames and with a set of targets for the given project (Table 1). An example is the Tangshan Caofeidian International eco-city which has been in construction since 2009 and defines these dimensions with 141 indicators (Joss and Molella, 2013). With a target of 95% energy demand to be met by onsite renewable energy, 60% waste recycling and 20 targets for water preservation and recycling. Furthermore 68 of the indicator apply to city scale 14 on neighbourhoods scale and 25 at site level.

The main points to take away from the eco dimension is the lack or confusion in definition and indicators used to identify what can be termed eco-city however, in the post Brundtland report era, the 3 pillars will be one of the inherent concept used to categorise eco-cities. This process will however start with the understanding of eco-city development in China as the main topic of this paper followed by definition and understanding of underlying principles such as indicators and its utilization in pursuit of eco-city development. This will then provide the tools necessary to may comparison with other similar yet different frameworks such as BREEAM and LEED.

Environmental Sustainability	CO2/GHG	Reducing GHG emissions/energy consumption; promoting renewable energy generation
	Buildings	Reducing energy use; promoting carbon-neutral buildings
	Water	Reducing water consumption; improving water recycling
	Transport	Promoting integrated public transport
	Waste	Reducing waste; increasing waste recycling and waste-to energy generation
Economic sustainability	Biodiversity	Protecting green spaces; promoting biodiversity
	High-skilled, 'green' jobs and employability	Investing in the knowledge economy; attracting 'green' business
	Competitiveness and resilience	Enhancing international competitiveness; promoting community self-reliance
	Smart technology	Promoting 'smart' technological innovation
	Well-being	Improving individual and social well-being
	Housing	Providing affordable housing and mixed usage
	Urban agriculture	Promoting urban agriculture and local food networks
Social sustainability	Liveability	Creating socially inclusive, vibrant communities
	Equity	Fostering equity within and between generations
	Civic engagement	Encouraging participation in public life
	Cultural diversity	Promoting cultural engagement and diversity
Urban design and systems	Compactness	Increasing density of housing, along transport arteries

	Scale	Improving integration across neighbourhood, district, city, and regional levels
	Ecosystems management	Improving information management of urban infrastructure and systems (water, energy, etc.)
Urban governance	Policy coordination	Enhancing multilevel policy coordination
	Public-private partnerships	Promoting partnerships involving public, private, and nongovernmental actors
	Political accountability	Ensuring transparency, openness, and participation; collaborative planning

Table 1: Eco-city dimensions: general dimensions and related targets, based on a sustainability 'triple bottom line' applied to the urban context (Reference: Joss 2015)

1.4 Eco-city development in China

China is undergoing the largest scale of urbanisation in history and at an unprecedented pace. Between 1991 and 2012, China's urban population has increased from 302 to 712 million, or 26.4% to 52.6% in percentage terms (Table 1-2, China Statistical Yearbook 2013). To accommodate the increased population in cities, the built up urban areas have expanded from 12,856 to 45,566 square kilometers over the same period, an increase of 3.5 times greater in about two decades (Table 12-3, China Statistical Yearbook 2013). Also a more radical increase may be expected since urbanization is considered as a major development strategy by the Chinese governments to maintain long-term economic growth. The International Energy Agency (IEA 2012:39) has projected an urbanization rate of 65% by 2035, resulting in an annual increase of 14 million urban populations to reach this predicted ratio.

Cities in general and the built environment in particular, during their life-cycle, have a significant environmental impact both at local and global levels (Graham 2004:12; Girardet 2003:5). The rapid expansion of urbanization level has inevitably brought severe pressures on resource conservation and environmental protection in Chinese cities. The increasing pollution, traffic and energy consumption in the urban areas are becoming alerting matters in China. Only 8, out of 74 major Chinese cities, have satisfied the national air quality standards in 2014 (MEP, 2015). Recognizing these resource and environmental constraints, and moreover, the significance of developing a "resource-conserving and environmental friendly society", China has initiated policies, strategies and pilot projects at both national and local level to address the urban challenges.

Conventionally sustainable city efforts have been focused on individual issues such as urban energy, urban transport, land use, wastes, water and urban health. In recent years there is a growing interest in China to find a new integrated model for urban development as a whole. Effort to create such a new urban development model is manifested in the form of developing eco-cities.

China appears in the frontline of reshaping and redeveloping the urban environments (Joss et al 2011; Zhou et al. 2015; Flynn et al. 2016). Currently there are around 280 Chinese cities that have declared an ambition to develop "eco-city" or "low carbon city" (China Society for Urban Studies 2012, p10). A global survey conducted by the University of Westminster in 2011 recognised 25 eco-city projects in China according to the methodical criteria in that research. This makes china the country with the largest number of eco-city projects, followed by the USA with 17, and the UK and Japan with 16 each (Joss et al. 2011).

China's 12th Five Year Plan for Green Building and Green Eco-city Development, issued by the Ministry of Housing and Urban and Rural Development (MOHURD) in March 2013, requires selection of 100 new urban areas (e.g. new urban districts, industrial park, hi-tech zones), with a minimum size of 1.5 square kilometres, for pilot demonstration of eco-city concept. Till now, throughout the country three batches of city projects, totalling 19, were launched as the national level eco-city pilot projects by. Financial support has been provided to these projects from the Chinese central government. Table 2 gives some basic information about the first batch of national level eco-city pilot projects.

Eco-City projects	Area (km ²)	Projected population (k)	Current status
Sino-Singapore Tianjin Eco-City	30	350	Being constructed and operated
Tangshan Eco-City	150	1000	Being constructed and operated
Wuxi Eco-City	150	1000	Being constructed and operated
Changsha Eco-City	7.6	178	Being constructed and operated
Shenzhen Brightness New District	156	800	Being constructed and operated
Chongqing Eco-City	10	300	Being constructed
Guiyang Eco-City	9.6	170	Being constructed
Kunming Eco-City	160	950	Being constructed and operated

Table 2: The first batch of national level eco-city pilot projects

This research will use 'eco-city' to represent all the efforts that try to create an urban development model which is ecologically sound, economically feasible and socially satisfied. Furthermore, this research is focused on the Key Performance Indicator (KPI) systems of eco-cities. Literature review indicates that there is little research conducted in this area. This paper will take a comparison study between various KPI systems, currently being applied to eco-city development in China, including international rating systems, national standards and local practices. But before this process it is essential to understand the origin of urban indicators and ratings systems in relation to this study.

1.5 Eco-city indicator development

Cities can be defined by population, by administrative jurisdictions, by functions and by territory. As cities have evolved, so has population increased with associated increase in knowledge, improvement in science and technology but so has the carbon foot print. This has ranged from increased demand in energy supply to environmental and ecological damage to the surroundings. These are but a few of the very reasons why a pursuit of sustainable development emerged, with the eco-city being one of the conceptual manifestations of this quest (Lehmann 2015). However, as far as sustainability is concerned various programs and projects of cities exist with self-proclaimed titles of meeting the criteria of what is termed or described as sustainable by the Brundtland report or eco-friendly by developers (Flynn, 2016). It then becomes imperative to reveal the truth behind these claims as well as compare what a city is doing better in the quest to towards sustainable development (Voula, 2005). As such to achieve and repeat eco-cities status it is essential to understand what recipe was used, with the aim of quantifying sustainability progress. In essence understanding the successes and failures in initiatives, better equip future development and in the case of working principle can lead to a repetition of such initiative, keeping into consideration the contextual understandings. As such, indicators, termed as the recipe plays a vital role in achieving this not only for Eco cities but various other frameworks including NSATs initiative and other conceptual cities.

Indicators are generally described to provide information about a known phenomenon (Guy and Kibert, 1998). It is also described by the World Bank as performance measure that combines information to usable forms. In essence they are described as being the summation of complex situations, which provide an indication of the problem at hand (Premalatha et al. 2013). As relates to eco-city, indicators and sub indicators are used to define the problems to be addressed in order to achieve the prescribed ecological, social and economic aims. In essence the indicator can be used to determine the route or direction to be taken to address the problem, usually based on empirical, quantitative and sometimes qualitative evidence and driven by the theme of the project in question (Reed 2006). According to Keirstead (2007) indicators have to 2 critical roles, they reduce the amount of data used to describe the situation and the promoting or facilitating communication between the audiences. A good example is Alberti (1996), where the concept of ecology is used in pursuit of urban sustainability. This is described as the total natural flow that a city requires in attaining its long term requirements of the populaces. In the development of this

definition, Alberti (1996) emphasizes the need of indicators to establish clear linkages between urban pattern and natural resource base with evidence being scientifically founded, implementation being policy relevant and applicability being readily Justifiable for planning.

In summary, As eco-cities are concerned, indicators is a method of simplicity derived from scientific evidence used to inform the audience on key directions to be taken and implemented to achieve ecological and environmental parity in cities with the support of policy sound frameworks and practical usability with in the overall aim of striving towards sustainable urban development (SUD). However, the post Brundtland report era has made SUD unsustainable without the consideration of social and economic dimensions, as such these will be added facet to the description of Eco city indicators. As such indicators used for their contextual aim of achieving any conceptual city goal will be termed Key Performance Indicators (KPI).

2. NEIGHBORHOOD SUSTAINABILITY ASSESSMENT TOOLS (NSATs)

NSATs evolved from environmental building assessment tools. These tools where established 2 decades ago on the environmental motivations highlighted in the Brundtland Report, however they have been initially focused on buildings with tools such as BREEAM New Construction and LEED New construction being developed and with the Evolutionary extension being BREEAM Community and LEED Neighbourhood (Nguyen, 2011). This extension was largely based on the widening scope covered by sustainability which shifted from environmental to social and economic. As such, the inability of buildings assessment to address abstract and community based elements such as connectivity and transport infrastructure and urban form as well as principles like urban heat Island effect (UHIE), led invariably to the development of NSATs (Sharifi, 2014). Similar to the concept of cities these Neighbourhood based tools are governed by indicators, which has been largely identified by experts to be context specific i.e. rooted to locale and location of development but also exhibit universal traits based on global and more uniform environmental and economic issues such as improving employment rate, reducing poverty levels and dampening the effects of climate change. As such Ameen et al. (2015) categorises indicators into common and local urban context with argument that there exist no specific indicators that suits all countries but however, perhaps we can establish a concept which does not suit all locales but developed to suit specific concepts such as Eco or smart indicators.

2.1 Current urban scale KPI systems in China

An urban area physically encompasses multiple buildings and their sites, and the public environment such as roads, open spaces, and landscaping features which exist in between those sites. It also embraces socio-economic features such as social interactions that are generally more intensive at this spatial scale. Currently there are several urban sustainability rating systems being applied at urban scale such as LEED-ND and BREEAM-Communities. As mentioned earlier, they all represent a larger scale of the built environment beyond single building sites and can be applied to any 'organized urban area' that is beyond a single building site. Both LEED and BREEAM have been used in China, for example, 7 projects were certified by LEED-ND in 2012 with a minimum construction area of 200,000 square meters and a maximum of 3.28 million meter square (Green Building Map, 2015).

In China, there are two main eco-city related national standards, which are known as 'National Standards for Eco Garden City' from MOHURD and 'National Eco-District/County Standards' from Ministry of Environmental Protection (MEP). Both of them use KPIs to evaluate environmental performance of urban areas. Currently 11 cities, including Hangzhou, Suzhou and Guilin, have been selected as "National Eco-Garden Pilot Cities" by MOHURD. Moreover, forty-six cities, counties, and districts have been designated by MEP as national "Eco-counties" or "Eco-districts".

At local level, some eco-city projects have launched their own KPI systems to make them more specific to the local contexts. Often these local systems are more ambitious and have higher requirements in comparison with the national standards. For example, all buildings must be certified by a green building rating system required by SSTECH and Wuxi Eco-City; minimum 20% energy consumption must be sourced from renewables in SSTECH and 8% is required in Wuxi Eco-City New City. These indicators and their corresponding benchmarks have not been incorporated in the national standards, which are more focused on urban infrastructure and pollution control.

2.2 Comparison study between urban scale KPI systems

This section will conduct a comparison study between the international urban rating systems, eco-city related national standards and local eco-city KPI systems. The purpose is to identify the common issues as well as the individual issues from these KPI systems. This would be helpful for informing future eco-city projects to develop their own KPI systems. These KPI systems reviewed include LEED-ND, BREEAM-Communities, National Eco Garden City Standard, National Eco-County/District Standard, SSTECH, Wuxi Eco-City, Changsha Eco-City and Tangshan Eco-City. The four local initiatives are all recognized as the national eco-city pilot projects by in 2013. **The main reason for selecting these KPI systems lies in the fact that they all have been implemented in China's** urban sustainability development and represent the efforts from both the central government and the local governments. Some key features of the KPI systems reviewed are presented in Table 3.

System features	LEED-ND	BREEAM Communities	National eco-garden city	National eco-city	Tianjin	Tangshan	Changsha	Wuxi
Developer	USGBC	BRE	MOHURD	MEP	Blue Path	SWECO	CABR	ARUP
Purpose	Labeling	Labeling	National assessment	National assessment	Guiding planning & management	Guiding planning & management	Guiding planning & management	Guiding planning & management
Approach	Point score	Point score	Benchmark	Benchmark	Benchmark	Benchmark	Benchmark	Benchmark
Application	New/existing urban area	New/existing urban area	Existing urban area	Existing urban area	New urban area	New urban area	New urban area	New urban area
Structure	3 layers	3 layers	3 layers	3 layers	3 layers	3 layers	3 layers	3 layers
Number of categories	5	6	4	3	4	7	8	7
Number of indicators	56	41	22	19	26	141	47	62
Indicator decomposition	No	No	No	No	Yes	Yes	N/A	N/A
Timeframe	2007	2009	2004	2007	2010	2011	2013	2013

Table 3: The key features of the KPI systems reviewed (source: Based on the authors' elaboration)

All these KPI systems reviewed have a similar structure. They all adopt multi-level approach (i.e. categories, indicators and benchmarks) to evaluate the overall urban sustainability performance. All of them have a number of indicators and corresponding benchmarks, which are classified into different assessment categories. It should be noticed that the number of indicators varies greatly between different systems. The Tangshan Eco-City has the greatest number of indicators: 141 indicators being classified into 7 assessment categories. The National Eco-city Standard issued by MEP has the least number of indicators with only 19 categorized into 3 assessment categories. The use of a greater number of indicators may complicate the data collection and assessment process, and in some cases, it may weaken the overall goal (Zhou et al, 2012). However, on the other hand, small number of indicators may not be sufficiently enough for a comprehensive evaluation.

Table 4 presents the assessment categories from the KPI systems reviewed in this study. It is apparent that all of them try to take a comprehensive view on sustainability by addressing environment, society and economy simultaneously. Land use, infrastructure, transport, resource and energy are some common themes in these systems. The comparison of the assessment categories only gives a vague idea on the scopes of different KPI systems. Opinions diverge on what aspects of an assessment category should be examined, i.e. what indicators should be employed to interpret an assessment category. Thus, further analysis is needed to explore individual indicators included in these assessment categories.

National Standards		International Standards	
MOHURD	MEP	LEED-ND	BREEAM-Communities
Living Environment	Social Development	Regional Priority	Governance
Natural Environment	Environment Protection	Neighborhood Pattern and Design	Social and Economic Wellbeing
Infrastructure	Economic Development	Smart Location and Linkage	Resource and Energy
		Green Infrastructure and Buildings	Land Use and Ecology
		Innovation and Design Process	Transport and Movement
			Innovation
Local Eco-Cities			
Tianjin	Tangshan	Changsha	Wuxi
Society	Urban Function	Green Culture	Society Harmony
Environment	Water Resource	Urban Planning	Urban Function
Resources	Energy	Ecological Environment	Ecological Environment
Economy	Waste Management	Energy	Energy and Resource
	Landscape and Public Spaces	Water Resource	Green Transport
	Transportation and Communication	Solid Waste	Green Building
	Building and Building Industry	Transport	
		Green Building	

Table 4: Assessment categories in different KPI systems

It is challenging to put the indicators side by side and conduct comparisons directly between them. Some systems generally have similar assessment categories (e.g., society, resource, transport, ecology, energy), but the number of indicators and their corresponding benchmarks included within each assessment category varies widely across the systems. Different systems also often classify similar indicators and benchmarks under different categories. For example, LEED-ND classifies the indicators used to measure building performance into Green Infrastructure and Buildings, while they are categorized into Resource and Energy in BREEAM-Communities. Alyami and Rezgui (2012) analyze the similarities and differences of 4 different green building rating systems by consolidating the initial categories and indicators into new schemes. Thus, using Alyami and Rezgui (2012) method of classification all the indicators from the 8 KPI systems reviewed in this research are roughly classified into six broad urban sustainability assessment categories to facilitate comparisons. These assessment categories comprise Culture and Economy, Ecology and Livability, Site and Planning, Resource and Environment, Green Building and Infrastructure, and Traffic and Linkage.

Table 5 shows each of the assessment categories encompasses a number of sustainability issues that are synthesized from the eight urban KPI systems currently being used in China. In total there are 44 individual sustainability issues drawn out from maximum of 141 possible indicators. Such a framework allows evaluation of the convergence and divergence of various KPI systems and further identification of both the contextual issues and specific issues. The box will be ticked if an issue is addressed by a KPI system. If an issue is addressed in 6 or above systems it will be singled out as a common issue. On the contrary an issue is seen as specific if it is included in 3 or below systems. Such an effort is useful to understand how the current eco-city KPI systems work and how they inform the development of future eco-city KPI systems. Table 6 indicates the level of convergence of the KPI systems to the proposed framework by examining the number of issues addressed in each of the KPI systems reviewed.

	MoHURD	MEP	Tianjing	Tangshan	Changsha	Wuxi	LEED ND	BREEM Communities
Culture & Economy (7)								
Business Development				✓			✓	✓
Regional Coordination			✓				✓	✓
Cultural Inheritance	✓		✓	✓			✓	✓
Inclusive Community	✓		✓	✓	✓	✓		✓
Sustainable Property Management				✓	✓	✓	✓	
Social Security (Housing & Employment)	✓	✓	✓	✓	✓	✓	✓	✓
Green Economy	✓	✓	✓					
Ecology & Livability (11)								
Ecological Greening & Landscape	✓	✓	✓	✓	✓	✓	✓	✓
Public Space	✓	✓	✓	✓		✓	✓	✓
Public Satisfaction		✓			✓	✓		✓
Shaded Street						✓	✓	✓
Adaptability to Climate Change								✓
Site Environment (Wind & Solar radiation)				✓	✓	✓	✓	✓
Acoustic Environment	✓	✓	✓	✓		✓		✓
Accessibility to Communal Facilities	✓	✓	✓	✓	✓	✓	✓	✓
Diversity of Species	✓		✓	✓	✓	✓	✓	✓
Green & Facilitated Community					✓	✓	✓	✓
Risk Management (e.g. flood)	✓			✓			✓	✓
Site & Planning (3)								
Mixed-Use Development			✓	✓	✓	✓	✓	✓
Land Use & Planning	✓			✓	✓	✓	✓	✓
Site & Neighborhood Scale				✓	✓	✓	✓	✓
Resource & Environment (10)								
Carbon Emission Reduction		✓	✓	✓				✓
Water Resource Management	✓	✓	✓	✓	✓	✓	✓	✓
Energy Management		✓		✓	✓	✓	✓	✓
Waste Management	✓	✓	✓	✓	✓	✓	✓	✓
Outdoor Air Quality	✓	✓	✓			✓		
Low Impact Construction Materials				✓	✓	✓	✓	✓
Natural Environment Protection	✓	✓	✓	✓	✓	✓	✓	✓
Daylight Utilization				✓		✓		
Heat Island Effect	✓			✓		✓	✓	✓
Unconventional Water Source Utilization	✓		✓	✓		✓	✓	✓
Green Building & Infrastructure (9)								
Passive Solar Design				✓			✓	✓
Green & Civilized Construction Plan					✓	✓	✓	
Intelligent Building Management System				✓	✓			
Green Building	✓		✓	✓	✓	✓	✓	✓
Artificial Lighting Design	✓			✓			✓	✓
High-Efficiency HVAC System				✓		✓	✓	✓
Renewable Energy Utilization	✓		✓	✓	✓	✓	✓	✓
Regional Energy Supply Planning	✓	✓	✓	✓	✓	✓	✓	✓
Building Energy Consumption	✓	✓	✓	✓	✓	✓	✓	✓
Traffic & Linkage (4)								
Public Transport Facilities	✓		✓	✓	✓	✓	✓	✓
Green Transport	✓		✓	✓	✓	✓	✓	✓
Transportation Demand Management							✓	✓
Accessibility to Public Transport				✓	✓	✓		✓

Table 5: Eco-city development index checklist

	MOHURD	MEP	Tianjin	Tangshan	Changsha	Wuxi	LEED -ND	BREEM Communities
Culture & Economy (7)	4	2	5	5	3	4	5	5
Ecology & Livability (11)	7	5	5	7	6	9	8	11
Site & Planning (3)	1	0	1	3	3	3	3	3
Resource & Environment (10)	6	6	9	9	5	9	7	8
Green Building & Infrastructure (9)	5	2	3	8	6	6	8	7
Traffic & Linkage (4)	2	0	4	3	3	3	3	4
Total Sustainability Coverage (44)	25	15	27	35	26	34	34	38
Sustainability Coverage (%)	56.8	34.1	61.4	79.5	59.1	77.3	77.3	86.4

Table 6: Sustainability coverage of the KPI systems reviewed

Table 7 shows the common issues and specific issues identified according to the methodology discussed earlier on. In total 20 issues are regarded as common issues. Among them, eight issues are addressed by all of the systems. These issues are:

- Social security (housing and employment)
- Ecological greening and landscape
- Accessibility to community facilities
- Water resource management
- Waste management
- Natural environmental protection

- Regional energy supply planning
- Building energy consumption

Common Criteria (20)	Specific Criteria (9)
Culture & Economy	
Inclusive Community	Business Development
Social Security (Housing and Employment)	Regional Coordination
Ecology and Livability	
Ecological Greening and Landscape	Shaded Street
Public Space	Adaptability to Climate Change
Acoustic Environment	
Accessibility to Communal Facilities	
Diversity of Species	
Site and Planning	
Mixed-Use Development	
Land Use and Planning	
Resource and Environment	
Water Resource Management	Daylight Utilization
Energy Management	
Waste Management	
Natural Environment Protection	
Unconventional Water Source Utilization	
Green Building and Infrastructure	
Green Building	Passive Solar Design
Renewable Energy Utilization	Green and Civilized Construction Plan
Regional Energy Supply Planning	Intelligent Building Management System
Building Energy Consumption	
Traffic and Linkage	
Public Transport Facilities	Transportation Demand Management
Green Transport	

Table 7: Identification of common issues and specific issues

3. DISCUSSION

From Table 6, we can see BREEAM-Communities and Tangshan Eco-City have the greatest convergence rates with 86.4% and 79.5% respectively. The two national eco-city related standards have the least of 34.1% and 56.8%. The examination of convergence gives an indication of the comprehensiveness of an eco-city KPI system. It seems that the international assessment systems have a broader view on urban sustainability, while the national standards are more limited to environmental and resource issues. The different assessment coverage between them may be due to their intended roles. The international rating systems are used to certify urban sustainability performance which requires greater involvement of social and economic consideration to present a full sustainability assessment. The national standards are set to assess the environmental performance of existing urban contexts, thus they attempt to involve indicators which are easy to collect data from the current statistical sources. This would avoid data inconsistencies between cities which are under assessment. So it is not a surprise that they attempt to involve more environmental and resource issues which are well recorded in the current statistical databases. This also may be attributed to the fact that the national standards were published by MOHURD and MEP separately and both have their own definitions on eco or green city. The four local KPI systems are designed to guide the whole development process of a new city project from planning, design to operational management. Thus they need to consider the local contexts as well as include those internationally (e.g. carbon emission) and nationally recognized indicators (e.g. air pollution, water pollution).

The eight issues, addressed in all systems reviewed, reflect the common concerns for eco-city development in China. It is noted that two issues, i.e. Social Security and Accessibility to Community Facilities, are addressing the socio-economic dimensions of sustainability. The rest are mainly related to the environmental and resources dimension. The other 12 common issues are included in 6 or 7 systems. It is not surprising that the main environmental issues, ranging from energy, water, wastes, land-use to site preservation. These issues are seen

as common practice in eco-city development. Mixed-use development is fundamental to urban sustainability as it will help to form an inclusive community and provide employment opportunities to local residents. Moreover, it directly affects travel behavior and enhances walkability to local facilities. Such major impacts will lead towards achieving a more healthy and livable urban environments, resulting in promoting quality of life and well-being of the communities. Furthermore, the provision of Green Landscape, Public Space, and Community Facilities plays an important role in urban sustainability. It can encourage people to interact and forge a sense of community, and improve resident satisfaction. These issues are crucial for new urban developments to attract residents. In addition, green landscape can provide local habitat, facilitate the use of rainwater and increase walking. Providing Public Transport Facilities can effectively reduce car dependence which is a key priority of urban sustainability. Green Building Certification has also become a compulsory requirement in eco-city development as building energy consumption is a significant factor determining the energy performance of a city. All the four eco-city projects require buildings to be certified by a green building rating system, such as LEED or China Green Building Evaluation System.

In addition to the common issues, there are nine specific issues that are used by 3 or below systems. However, this does not mean those issues are less important. These issues represent the divergent part of KPI systems currently being used in China. The lack of commonality in the use of these specific issues can be attributed to the following 2 factors, including:

- Purpose: labeling, national standards and local initiatives assessment;
- Local contexts.

Most specific issues are also relevant to some specific building technologies, such as, passive solar design, daylight utilization, building intelligent system and shaded streets. The involvement of such technologies would be depending on the local conditions, e.g. cost and adaptability of technologies.

4. CONCLUSION

KPI systems have played an important role in guiding the current eco-city development in China. This study elaborates the importance of KPI systems in the planning system as a potential mean to achieve sustainable eco-development. The analysis of the current eco-city related KPI systems indicates that they have different assessment focuses and priorities; however, there are still some convergences from the issues commonly addressed by the KPI systems reviewed. Future eco-city KPI systems may need to consider these common issues, and incorporate the local contexts in tandem.

REFERENCES

- [1] Alberti M (1996), Measuring urban sustainability, *Environmental Impact Assessment Review*, 16 (4), pp381-424.
- [2] Alyami, S. H. and Y. Rezgui (2012). "Sustainable building assessment tool development approach." *Sustainable Cities and Society* 5(0): 52-62.
- [3] Ameen R.F.M., Mourshed M, Li H.J.A critical review of environmental assessment tools for sustainable urban design *Environmental Impact Assessment Review* Volume 55, November 2015, Pages 110–125
- [4] BRE Global. (2015). "BREEAM." Retrieved March 16th, 2015, from <http://www.bre.co.uk/page.jsp?id=829>.
- [5] China Society for Urban Studies 2012, China low carbon and ecological cities annual report 2012, China Building Industry Press.
- [6] Crane, K., Schatz, H.J., Nataraj, S., 2012. Strategies for Building an Innovation System for the Knowledge City. RAND Corporation, Santa Monica (CA).
- [7] de Jong, M., S. Joss, D. Schraven, C. Zhan and M. Weijnen (2015). "Sustainable-smart-resilient-low carbon-eco-knowledge cities; making sense of a multitude of concepts promoting sustainable urbanization." *Journal of Cleaner Production* 109: 25-38.
- [8] de Jong, M., Wang, D., Yu, C., 2013b. Exploring the relevance of the eco-city concept in China: the case of Shenzhen Sino-Dutch low carbon city. *J. Urban Technol.* 20, 95e113.
- [9] Dongtan Castle H. China's flagship eco-city. *Architectural Design* 2008; 78:64–9.
- [10] Roseland M. Dimensions of the eco-city. *Cities* 1997; 14:197–202.
- [11] Flynn, A., L. Yu, P. Feindt and C. Chen (2016). "Eco-cities, governance and sustainable lifestyles: The case of the Sino-Singapore Tianjin Eco-City." *Habitat International* 53: 78-86.

- [12] Girardet H. (2003), *Creating sustainable cities*, Green Books, Devon.
- [13] vGlobal Footprint Network. (2013, 9th April 2014). "Earth Overshoot Day." Retrieved March 16th, 2015, from http://www.footprintnetwork.org/en/index.php/GFN/page/earth_overshoot_day/
- [14] Graham P. (2004), *Building ecology: first principles for a sustainable built environment*, Blackwell Publishing, London.
- [15] Green Building Map 2015, <http://www.gbmap.org/article1.php?id=533>
- [16] Grierson, D. (2011). *Towards a Sustainable Built Environment*.
- [17] Guy GB, Kibert CJ. Developing indicators of sustainability: US experience. *Build Res Inf* 1998; 26:39–45.
- [18] IEA, *World Energy Outlook 2012*, International Energy Agency, 2012
- [19] Joss, S. (2015) *Sustainable Cities: Governing for Urban Innovation*. Palgrave Macmillan, London
- [20] Joss, S., Molella, A., 2013. The eco-city as urban technology: perspectives on Tangshan Caofeidian International Eco-city (China). *Journal of Urban Technology* 20 (1), 115–137.
- [21] Joss, S., Tomozeiu, D., Cowley, R., 2011, *Eco-Cities — A Global Survey 2011*, University of Westminster.
- [22] Keirstead J. *Selecting sustainability indicators for urban energy systems*. International Conference on Whole Life Urban Sustainability and its Assessment Glasgow; 2007.
- [23] Lehmann, S. (2015). *Low Carbon Cities: Transforming Urban Systems*. London & New York, Routledge.
- [24] MEP 2015, official website of the Ministry of Environmental Protection, http://www.mep.gov.cn/gkml/hbb/qt/201502/t20150202_295333.htm
- [25] National Bureau of Statistics, *China Statistical Yearbook 2013*, China Statistics Press
- [26] Newman, P., Jennings, I., 2008. *Cities as Sustainable Ecosystems: Principles and Practices*. Island Press
- [27] Nguyen, B. K. and H. Altan (2011). "Comparative Review of Five Sustainable Rating Systems." *Procedia Engineering* 21(0): 376-386.
- [28] Premalatha, M., S. M. Tauseef, T. Abbasi and S. A. Abbasi (2013). "The promise and the performance of the world's first two zero carbon eco-cities." *Renewable and Sustainable Energy Reviews* 25: 660-669.
- [29] Reed, R., A. Bilos, S. Wilkinson and K.-W. Schulte (2009). International Comparison of Sustainable Rating Tools *The Journal of Sustainable Real Estate*. 1: 22.
- [30] Roseland M. *How Green is the City? Sustainability assessment and the management of urban environments* New York: Columbia University Press; 2001.
- [31] Sharifi, A. and A. Murayama (2013). "A critical review of seven selected neighborhood sustainability assessment tools." *Environmental Impact Assessment Review* 38(0): 73-87.
- [32] Sharifi, A. and A. Murayama (2014). "Neighborhood sustainability assessment in action: Cross-evaluation of three assessment systems and their cases from the US, the UK, and Japan." *Building and Environment* 72(0): 243-258.
- [33] SSTEK Project Team (2010), *Guiding Eco City: SSTEK KPI implementation model*, China Building Industry Press.
- [34] Voula M. *Sustainable development, energy and the city: a civilization of concepts and actions*. New York: Springer Science-Business Media; 2005.
- [35] World Commission on Environment and Development (1987). *Our Common Future*, Oxford Press.
- [36] Zhou, N., G. He, C. Williams and D. Fridley (2015). "ELITE cities: A low-carbon eco-city evaluation tool for China." *Ecological Indicators* 48: 448-456.

A Human-Oriented Study of the Assessment Method for Sustainable Urban District in China - Comparison of LEED Neighbourhood Development, BREEAM Community, CASBEE-Cities and DGNB Urban Districts

Edison ZHANG Zhidong^a, Stephen LAU Siu-yu^b, Edward SHEN^c, April HAO Tong-ping^d

^a GB Tech Consulting Ltd., Hong Kong SAR, edison@srtdesign.com

^b Department of Architecture, University of Singapore, Singapore, laustephensy@gmail.com

^c SRT (S&P) Architects Ltd., Hong Kong SAR, shene@srtdesign.com

^d GB Tech Consulting Ltd., Hong Kong SAR, april@srtdesign.com

ABSTRACT

The development of “Green and Eco-Urban District” is one of the major tasks in the “national promotion of the construction of ecological civilization (生态文明建设)”, which has also significant impact on the implementation of new urbanization (新型城镇化) in China. Consideration for humanities and humanism, which reflects the qualitative factors besides quantitative ones, is one of the assessment aspects in the Chinese national standard “Evaluation Standard for Green and Eco-Urban District”. This research will first compare the definition of humanities and humanism between China and western countries. Secondly, it will compare the human oriented issues of the four world leading green assessment standards – the US LEED Neighborhood Development, UK BREEAM Community, Japan CASBEE-Cities and German DGNB Urban Districts. Through the above comparisons, this research attempts to establish the assessment method and framework for the humanism aspect (人文章节) of the Evaluation Standard for Green and Eco-Urban District in China.

Keywords: sustainable neighbourhood, humanism, China GBL

1. BACKGROUND

1.2 Definition of humanities and humanism

The character 「人文」 which means humanity in China first came up in the Book of Changes (中文名称：《易经》) (Xu, 1992), whose core spirit is the unity of man and nature in Confucian philosophy. While, in the West, humanism means a doctrine, attitude, or way of life centered on human interests or values, in particular it is a philosophy that usually rejects supernaturalism and stresses an individual's dignity and worth and capacity for self-realization through reason (University, 2014). Therefore, it could be found that there are certain differences in meanings of humanity between China and the West.

1.3 Human-oriented content in green and eco-urban district

In 1975, the United Nations set up the United Nations Habitat and Human Settlements Foundation (UNHHSF) and committed itself to the Habitat Agenda with issues as adequate shelter for all, sustainable human settlements, enablement and participation, gender equality, financing shelter and human settlements, and international cooperation and assessing progress (UNHHSF, 1996). We summarized the four principles of the above commitment as sustainability, openness, engagement and equality.

In China, the national urbanization plan for the 2014-2020 period, issued in 2014 (MOHURD, 2014), put forward the human-oriented city construction topic in part three, which contained chapter eighteen including history & culture conservation, cultural and sports facilities and free of charge public facilities.

Through comparative analysis between the United Nations' **Habitat Agenda and National Urbanization Plan (2014~2020)**, we found out their common principles and different points of focus, shown as Table 1.

Principles	UN Habitat Agenda	Chinese Urbanization Plan (2014-2020)
Public Open Spaces/ Facilities	✓	✓
Public Engagement	✓	✗
Equality	✓	✗
Sustainability	✓	✓
Green Education	✗	✓
History & Culture Conservation	✗	✓

Table 1: Comparison of the principles of human-oriented city between China and the United Nations

From Table 1 above, it could be found that the UN Habitat Agenda focuses on the human-oriented urban planning issues and environmental sustainability issues, but lacks due consideration for green education, promotion of green lifestyle and cultural sustainability. In contrast, China pays less attention on human-oriented issues, especially on public engagement and equality. Thus, some form of integration of global and local principles is necessary and may point to a more comprehensive framework on the aspect of humanism. Hence, the integrated framework of the humanism aspect in the Evaluation Standard for Green and Eco-Urban District should include four sub-categories – human-oriented design, green lifestyle, green education, and history and culture conservation.

1.4 Methodology

To establish the detail requirements of the four sub-categories in the aspect of humanism, this research used a comparative study method to compare the human-oriented and social related credits in LEED, BREEAM, CASBEE and DGNB with the aim to extract common and particular requirements in the four standards.

Since presently there are very few standards for defining green and ecological urban districts and the scale for an urban district is different in different countries, the scope for comparison covered three different urban scales, neighbourhood, urban district and city scale. It aimed to identify the human-oriented social issues that are of urban district scale and suitable for adoption in China.

2. LITERATURE REVIEW

2.1 LEED ND, BREEAM communities, CASBEE for cities, DGNB UD

In the 1990s, Americans put forward the concept of smart growth after realizing development problems resulting from loose expansion from urban to suburban. Green districts under the frame work of smart growth becomes the development mode based on a human-oriented concept (Huang, 2008). A community's smart growth means the communities provided well open space, farmland, and expanded the range of transportation, employment, and housing choices. As a guideline for sustainable neighbourhood development, initiated in 2004 (Xin, 2014), LEED ND encompasses not only transportation, ecological environment and economy aspects (Xiaoqian Teng, 2014), but also human-oriented aspects that integrates humanity into the rating system. LEED ND is primarily concerned with site location and land use to the neighbourhood scale, and explores integrated strategies from three parts including smart location and linkage, neighbourhood pattern and design, and green infrastructure and buildings and the human-oriented issues are mainly elaborated in the last two parts. LEED ND-certified developments improve building performance, energy conservation, greenhouse gas emissions reduction, and provide healthier and more productive environment for the occupants.

First launched in 1990, the UK BREEAM was the world's first environmental assessment method for new buildings design (BRE, 2012). The BREEAM Communities that came out in 2009 is an independent, third party assessment and certification standard based on the established BREEAM methodology (Ziping Xu, 2002). The assessment criteria in BREEAM Communities consider human-oriented issues in two aspects, namely governance and social and economic wellbeing. On governance aspect, public consultation and engagement are considered a necessary process in sustainable social development and addresses numbers of related credits that require local community and stakeholders involvement in each development stages in various forms. While economic wellbeing aspect addresses demographic needs and priorities issues to ensure that the development makes provision for housing, services, facilities and amenities on the basis of local demographic trends and priorities and public realm issues to encourage social interaction by creating comfortable and vibrant spaces, by analysis and regulating the multiple uses for different development users, barrier free design and community identity.

Comprehensive Assessment System for Built Environment Efficiency (CASBEE) in Japan, also known as **“CASBEE for Cities”** (hereinafter referred to as CASBEE-City) was a tool designed specifically for city assessment and was developed in close cooperation with the central government and local governments in Japan to support local governments and other stakeholders to identify environmental, social, and economic characteristics of their cities and in quantifying the effectiveness of city policies (S. Kawakubo, 2014, IKAGA Toshiharu, 2010). Development of the initial version of the tool began in 2008 and it was released in 2011 after extensive discussion among experts in the field (JSBC, 2011, Murakami, 2011). We studied the second, revised version that was released in 2012 for this paper. In CASBEE-City assessment tool, the categories in social aspect included living environment, social services and social vitality, which the assessment is based on quantitative indicators. In living environment category, crime prevention was put forward under the topic of district security and crime prevention was included as a factor to assess of sustainable social development. With the population-aging reality, CASBEE-City conducts quantitative analysis of the population in social services and social vitality aspects. Under social services aspect, it analyses the adequacy of childcare services and adequacy of services for the elderly by indication of the number of childcare and senior care facilities respectively. Besides, evaluate the education and culture quantitatively to show its emphasis on compulsory education as well as the culture communication richness. In social vitality aspect, it addresses regional living population according to the rate of population change due to **both births & deaths and migration as people is the basis of a city's development and the key factor of regional sustainability.**

The DGNB System was developed in close collaboration with the German Federal Ministry of Transport, Building, and Urban Affairs (BMVBS) and began a pilot phase in 2011 then released in 2012 (Zhu, 2010). In DGNB UD, the credits related on the humanity could be found mainly in two aspects, both sociocultural and functional quality including diversity of social functions, subjective and objective safety and security, comprehensive accessibility and public art setting and process quality (Lu, 2010). Overall, the evaluation is primarily based on qualitative **indexes, which the assessment requires corporation approach in certain case that promoting communities' sustainability while in turn increasing the difficulties of communities' development.**

2.2 Summary

Although the assessment scale of LEED ND, BREEAM Communities, CASBEE-City and DGNB UD are different, they all address human-oriented and social sustainability issues in different considerations. LEED ND seems more **concerned about human's green behaviour. And** BREEAM Communities make effort to provide adequate facilities for different needs. While CASBEE-City **assessment tool expands the assessment concept of urban development's sustainability and positively responds to social problems and development trends by emphasizing regional security, cultural education and service facilities as well as the relationship between growth trends, childcare and senior care service facilities under Japan's unique aging social structure. DGNB UD in the other hand place emphasis on community accessibility and connectivity.**

3. COMPARATIVE STUDY

Latest version of BREEAM-Communities, CASBEE-Cities and DGNB UB were all released in 2012 while LEED ND were updated in 2014. In these 4 rating systems, BREEAM-Communities and LEED ND launched and developed earlier than CASBEE-Cities and DGNB UB. We shall conduct a comparative analysis between the four different rating systems from three aspects, including human- oriented design, green education, and history and culture conservation. The comparative analysis result can be found below in Table 2.

Key Indicators of Humanity Aspect		Credit Requirements				
		LEED-NB	BREEM-Communities	CASBEE-Cities	DGNB-Urban Districts	
Human-oriented Design	Engagement	Community Outreach and Involvement	Consultation plan	—	Participation level	
			Consultation and engagement			
			Design review			
			Community management of facilities			
	Public Open Spaces/ Facilities	Access to Civic and Public Spaces	To encourage social interaction by creating comfortable and vibrant spaces in the public realm	Adequate provision of parks and open spaces	Adequacy of cultural services	Society and economy infrastructure
				Access to Recreation Facilities		Adequacy of cultural services
	Equality	Mixed-Income Diverse Communities	Affordable rented, social rented and intermediate affordable housing		Crime prevention	
				Visitability and Universal Design		Demographic needs and priorities
	Visitability and Universal Design	Enhancing, diversifying or adding employment opportunities and/ or skills training	Adequacy of services for the elderly		Adequacy of services for the disabled	
				Social vitality		
Green Lifestyle	—	—	—	—		
Green Education	—	—	—	—		
History & Culture Conservation	Historical resources conservation and adaptive reuse	—	—	—		

Table 2: Comparison results of the four world-leading standards

3.1. Human - oriented design

3.1.1 Engagement

Except CASBEE Cities, LEED-ND, BREEAM-Communities and DGNB-UD have requirements on public engagement from planning stage to construction stage, especially in BREEAM-Communities. BREEAM has detailed procedures and guidelines for the implementation of public engagement form both top-down and bottom-up approaches. It is suggested that public engagement should be regulated into sustainable and green community **development to enhance the awareness of public participation during community's planning and development process.**

3.1.2 Public open spaces/ facilities

All the four rating systems place emphasis on provision of the public open spaces and facilities but from different point of view. LEED ND requires the provision of sufficient public open spaces within community, initiating the integration of infrastructure and public spaces as there is great potential for green infrastructure to be made available as neighbourhood facilities like roof garden, children garden, orchard, vegetable garden, street greenery and backyard garden. While BREEAM-Communities emphasizes the multi-functional open spaces from user-demand-side, aiming to create more communication spaces for residents. DGNB UB, on the other hand, focuses on the connectivity and walkability of the open spaces design. Both BREEAM-Communities and DGNB UB regulate for public spaces/ facilities and provide guidance on the accessibility between community and city by enhancing connecting residents to more transportation selections. CASBEE-Cities evaluate quality by the adequacy of cultural services, calculated as number of community centres, together with the number of libraries/ land area of municipality, so as to guide and encourage the provision of public spaces and facilities.

3.1.3 Equality

CASBEE-Cities, BREEAM-Communities and DGNB for UD have social indicators on housing and social mix, education level, and criminal rate. However, the detailed requirements on such indicators are different due to different population configuration in each country. CASBEE focuses more on facility provision for the elderly and children, which reflects the actual situation in Japan. BREEAM-Communities, on the other hand, focuses more on the provision of affordable housing and job opportunities within the communities (Gu, 2013). Whereas DGNB UD has similar requirement on the evaluation of unemployment rate. For LEED ND, it not only requires the provision of affordable housing but also stipulate the different mix of residence types, aiming to encourage better social mix within the communities.

Accessibility for disables is another important indicator for equality. LEED ND and DGNB UD both have credits for barrier-free and universal design. LEED ND gives credits for visitability and universal design to increase the **proportion of areas usable by a wider spectrum of inhabitants' mobility, regardless of age or ability**. DGNB UD also gives credits on visitability and universal design as being one of the unique features of the system.

3.2. Green lifestyle and education

All four standards have no credits on the promotion of green lifestyle and education. However, behavioural change is given same importance as the technical requirements for environmental sustainability. Thus, the humanity aspect **in our country's green building label for urban district (GBL for UD) established requirements for these two indicators**, to become an issue of innovation and a special characteristic of this research. It is suggested that credits should be given not ungenerously but should be based on practical results to avoid green education being reduced to just hollow pledge with no accountable achievement on outcome in practice.

3.3. History and culture conservation

For this indicator, only LEED sets requirements for the conservation of historical buildings. Nevertheless, cultural sustainability is a vital part of sustainable development and the humanity aspect in GBL for UD extends the **requirements from buildings to the protection of intangible heritage relevant to the country's culture**.

4. CONCLUSION AND SUGGESTION

Human-oriented design is the key principle for human-oriented city construction, and is also the core concept for Green and Eco-Urban District development, of which public engagement is an important tool to understand human-oriented planning and design, construction and operation of a Green and Eco-Urban District. It is suggested that criterion should be established to help the Evaluation Standard for Green and Eco-Urban District in China, and **guide and ensure the operation of public engagement to safeguard residents' participation**. Meanwhile, the standard should also require provision of **accessible and inviting public open spaces to improve communities' communication and interaction**. In addition, barrier-free-design and senior services facilities should also be considered in the GBL for UD, as well as the free of charge public service facilities to ensure the provision of humanistic care for all different users.

Green education is the important guarantee for Green and Eco-Urban District construction. All four standards, including LEED ND, BREEAM-Communities, CASBEE-Cities and DGNB-Urban Districts have no credits on the promotion of green lifestyle and education, while this aspect was highlighted in GBL for UD. Nevertheless, this part should be scientifically and logically based on practise experience and results covering the whole spectrum of students of different ages to avoid green education being reduced to just hollow pledge with no measurable outcome. Besides, it is suggested in the research to actively promote green life-style starting with changing **people's mind**-set and behaviour. Districts and communities could compile a green life-style to educate residents how to achieve energy and water saving, waste reduction and travel by public transportation.

History and culture conservation is an integral part of planning and design of Green and Eco-Urban District. For this aspect, BREEAM-Communities, CASBEE-Cities and DGNB-Urban Districts other than LEED set no requirements for the conservation of historical buildings. To revitalize and reuse old historical and cultural buildings is not only a means **to save resources but also a good way to preserve our city's historical**. In addition, setting urban design guidelines are recommended and helpful to integrate building form and design language, facade treatment and material expression to record the historic evolution of the city, to reflect the regional and climatic characteristics, as well as cultural heritage connotations.

REFERENCES

- [1] BBRE 2012. BREEAM Communities Technical Manual the United Kingdom, BRE Global Limited.
- [2] GU, X. 2013. Comparative study on overseas assessment systems of green community. *Construction Economy*, 83-87.
- [3] HUANG, X. 2008. Smart growth and green building--an introduction to the LEED-ND system. *urban environment design*, 3, 10-11.
- [4] IKAGA TOSHIHARU, B. P., WEILIN CUI 2010. State of the art on comprehensive assessment system for building environment efficiency. *Eco-city and green building*, 20-23.
- [5] JSBC 2011. CASBEE for Cities Technical Manual, Tokyo, The Committee for the Development of an Environmental Performance Assessment, Japan Sustainable Building Consortium.
- [6] LU, Q. 2010. DGNB of Germany: Generation 2 of sustainable building assessment of the world. *World Architecture*, 1.
- [7] MOHURD 2014. National Urbanization Plan (2014-2020). Beijing: Ministry of Housing and Urban-Rural Development.
- [8] MURAKAMI, S., KAWAKUBO, S., ET AL. 2011. Development of a comprehensive city assessment tool: CASBEE-City. *Building Research and Information*, 39, 195-210.
- [9] S. KAWAKUBO, T. I., S. MURAKAMI 2014. Comparison of CASBEE-City assessment results and citizen satisfaction with cities. *World Sustainable Built Environment Conference 2014*. Barcelona.
- [10] UNHHSF 1996. *Habitat Agenda the United Nations: The United Nations Habitat and Human Settlements Foundation*
- [11] UNIVERSITY, O. 2014. *humanity*. Oxford English Dictionary Oxford University Press.
- [12] XIAOQIAN TENG, H. Z. 2014. the difference research of our country green residential area evaluation criteria and USA LEED-ND. 10th International conference on green building and building energy conservation. Beijing.
- [13] XIN, J. 2014. Development of Ecological Residential Community. 10th International conference on green building and building energy conservation. Beijing.
- [14] XU, S. 1992. *the Book of Changes*, Hefei, Anhui people's publishing house.
- [15] ZHU, H. 2010. German DGNB certification system for building sustainability assessment *Civil Construction*. *Construction science and technology*, 18.
- [16] ZIPING XU, S. L. 2002. Introduction to the building research establishment environment assessment method (BREEAM) in UK. *New architecture*.

Reducing the Impacts of the Built Environment on the Environment through the Integration of Socio-economic Indicators in Certification Standards

Francesco CAPPAL^a, Daniel FORGUES^b, Mathias GLAUS^c

^a GRIDD-ÉTS École de technologie supérieure, Canada, cappai.francesco@gmail.com

^b GRIDD-ÉTS École de technologie supérieure, Canada, daniel.forgues@etsmtl.ca

^c STEPPE-ÉTS École de technologie supérieure, Canada, mathias.glaus@etsmtl.ca

ABSTRACT

Some cities are recognized for their successful application of forms of revitalization of their habitat, while other cities are clogged and choked with traffic and pollution. The inclusion of "sustainable development" in the field of construction is behind new methodologies for achieving a more sustainably built environment. The use of tools to measure the degree of sustainability of cities is the method that receives the most attention in developed countries. However, none of the tools used to date covers all three pillars of sustainability (environmental, social and economic). Previous studies show that the participation of citizens and experts is not taken into consideration. This study (paper) will aim to explain the process of our research for integrating socio-economic aspects in the CASBEE-UD standard (neighbourhood level). First, the study will seek to analyse the existing built environment through a geographic system (GIS) for the identification of spatial indicators. In addition, from the use of social and economic data through the use of statistical analysis, we will select the data that present a true picture of our territory (either an existing district or a new district). The criteria selected in these analyses will be used in a (in an advanced analytic tool) multi-criteria tool to establish the most efficient indicators in order to integrate them into the CASBEE-UD standard.

Keywords: neighbourhood sustainability assessment, sustainability coverage, applicability

1. INTRODUCTION

In recent decades, much has been written about the concept of the need for sustainability in cities. The reason for this is that during the last century, the world has witnessed many social, economic and urban. Everyone knows that the construction sector has a huge impact on the consumption of resources. According to data disclosed by the leading research institutes (World Commission on Environment and Development (WCED), European Commission, 2009), construction industry uses globally about 40% of energy and 40% of natural resources (raw materials and other materials) and produces 25% of waste. Several communities and institutions have developed new methodologies for monitoring the sustainability status of their cities. Some communities (United States, European Community, United Kingdom, Japan, etc.) have launched tools to ensure that the hardware requirements of their cities strive towards sustainability. Three sets of certification have been developed recently: LEED-ND (1998) developed by the Green Building Council in the US, BREEAM Communities (1992) developed by the British organization BRE Global, and CASBEE-UD (2004) developed by IBEC Institute for strengthening the environment and energy conservation in Japan. All these standards are developed at the neighbourhood level. Certification standards mentioned above are the most known and used, but several weaknesses especially the socio-economic aspects. To measure progress towards this desirable state of sustainability, measurable indicators are required to assess urban efforts in the economic, social, environmental. Therefore, the importance of the issue of sustainability in general and in particular on sustainable urban planning in communities, has emerged as one of the key issues that must be taken into account by the authorities and experts. In the same context, at present, there are many areas that have experienced a marked change in their own style and their quality of use. To achieve these objectives, it is necessary to develop clear objectives and effective sustainability criteria. Also, it is necessary to understand and analyse existing certifications, specifically the criteria, which structure and guide the entire evaluation process. The goal is that the knowledge of the certification standards should help in the future development, for a more complete and efficient certification in order to have a tool based on strong sustainability criteria "triple bottom line". The aim of this study is to develop additional indicators to those existing in the certifications of tools to assist planners and citizens to improve the assessment of the built environment (neighbourhoods). Our research is guided by the development of an appropriate methodological approach based on the integration of socio-economic aspects to the CASBEE-UD standard. The article is structured in the following

manner: Chapter 1- context; the second chapter is dedicated to the review of the literature; and, the third chapter describes the methodology of our approach; the fourth chapter describes the application of our methodology framework for CASBEE-UD standard; the results and discussion will finish this study.

1.1. Context

In the second half of the twentieth century, the world's urban population has quadrupled from 732 million in 1950 to 2.8 billion in 2000 to over 3.2 billion in 2006 (Redman, 2010; United Nations, 2006). The year 2007 marked a turning point in history when half the world's human population lived in cities (Cities Alliance, 2007). This growth has caused a lot of pressure on a lot of resources and contributed to the depletion of natural and environmental resources. Urban society recognizes that activities that are developed for the production and processing of urban space influence and determine the survival of natural systems. There is now a consensus on the importance and the need for strategies to mitigate these problems and gradually increase the benefits of cities. In addition, the need for corrective actions reinforces the idea of developing new models to replace the current models, to reorient activities and human technology towards sustainability, and to ensure the survival of contemporary urban society. In recent years, there have been various collaborations in the field of construction to environmental objectives and sustainable development. Certification standards are an example of the principle tools that encourage market competitiveness "green." In addition, standards are working to improve the quality of products and services while introducing new criteria and values of productive activities. In the field of construction, the certifications are used in several countries (e.g. USA, European Community, Japan). They are used mainly to guide architects to techniques for the construction of buildings based on rigorous energy efficiency. The standards in the field of urban planning are a recent phenomenon. They have recently developed initiatives which aim to introduce sustainability criteria in the planning process (e.g. the construction of new neighbourhoods or rehabilitation of urban areas). In addition to these tools, which are used for products and value-added services, communities use them as an instrument of local politics. They are also used as means of verification of compliance with regulatory guidelines, or for granting financial credits and investment or to the development of private projects.

1.2. Justification of context

The scale of the neighbourhood is the area where we find all the dimensions to determine the design of a more sustainably built environment. This scale between the scale of the city and the building is very interesting in this context, in operational terms, as it is well suited to the testing of specific practices to increasing urban sustainability. It makes it possible to grasp tangibly urban issues that clearly exceed the size of a single building. The need for coordinated control of urbanization and mobility, the creation of joint dense clusters and the search for a better quality of urban life can be addressed through concrete solutions. It is in this perspective that emerges the concept of "sustainable neighbourhood", namely the realization of urban centres, dense and mixed, whose overall quality meets a thorough vision of sustainability. A number of parameters are however needed to apply the concept of sustainable neighbourhood.

2. THE NORMATIVE EVOLUTION

In the context of urban planning, there is now a broad consensus that sustainability has four main dimensions: environmental, social, economic and institutional. All these dimensions should be taken into account for sustainable development (Valentin and Spangenberg, 2000; Conte and Monno 2012). The evaluation of sustainability is considered the latest generation of impact assessment tools, and can be defined as "a process that directs decision making towards sustainability". Many methodological approaches were used to assess sustainability. All of these approaches use indicators as tools to generate relevant information. From the data, they acquire a wide range of sources. To a large extent, the effectiveness of the sustainability assessment depends on the robustness and rigor of the evaluation methodology. A research framework consisting of indicators and relevant criteria and poorly defined can misinform and mislead policymakers. Despite the relatively short history of the tools, evaluation of neighborhood sustainability (NSA = neighborhood sustainability assessment) has received considerable attention from the scientific community. Most studies have focused on the theoretical and unrealistic aspects. In one of the few studies on this issue, Saynajoki et al. (2012) found that some of the indicators used in the NSA's tools are not relevant. Similar results were obtained in studies that conducted respectively to examine the relevance of LEED-ND for use in England and Germany. This raises concerns that the results of these evaluations can mislead and misinform policymakers. Although there is still some controversy surrounding this issue, different tools have been used to assess the evolution of the neighbourhood in several countries. For example, LEED-ND has been used

outside the United States and some countries of the European Community. BREEAM Communities has been used in several countries in the European Community. On the other hand, the CASBEE standard was used, from the beginning, within the country and only by some Japanese cities. After underutilization, this standard has found greater consideration in his country, through its development and its methodology. Now the Japanese government imposed the standard for all major projects. The non-use of CASBEE in other countries is due to its young age and also because the standard to be used needs qualified experts.

2.1 Weaknesses in standards

The information available in the literature demonstrates that the tools need refinement. The most significant weaknesses found in standards and literature are: 1) The extent of sustainability (or sustainability); 2) The inclusion of prerequisites; 3) Adaptation to the locality; 4) The participation of stakeholders and citizens; 5) Placement of the actors in the project phases; 6) The presentation of results; 7) The application of the standard to different contexts.

The purpose of the sustainability assessment is to provide decision makers with a comprehensive and integrated local assessment system in the short and long-term prospects (LEED-ND, 2011 BREEAM Communities, 2009, CASBEE for Urban Development, 2007). Such a system would help them judge what actions should or should not be used in an attempt to create a more sustainable society. For coverage of sustainability, developers can use a better sustainability approach while improving the resilience of neighbourhoods through the provision of communities with strong local economy that are autonomous and have good infrastructure. These criteria are highlighted in a study on the relationship between urbanization and sustainable urbanization led by Oswald & McNeil, 2010; Waheed Khan, and. Veitch, 2009. These criteria are important when addressing affordable housing to inclusive communities, social networks, mixed use, and the local economy. They improve the ability of an area to resist the various social and economic status regardless of their inhabitants. Therefore, the context-specific criteria should be included as well as the weights to be assigned to the values of the relevant specific communities. This could impose an additional economic burden on the developer, but it's the only way we can ensure the viability and reliability of the assessment results. In terms of adaptation to the location, it was stressed that evaluation systems should vary depending on the type of development and also specific questions to the site. Other criticisms are the lack of citizen participation at the time of writing of the project, only because they are written by experts. The importance of the participation of different political and academic actors and the community during the various stages of planning is widely recognized by Khakee (1998). By focusing on the inseparability of planning and evaluation, it suggests that the evaluation should be a discourse between all the actors who are somehow affected by the assessment, and should take the form of negotiations rather than pursuing a solution to a problem. Finally, citizens can participate by providing feedback that planners use for system update. As for the use of such assessments, planners and developers can decide which changes are needed to bring the economic development activities in alignment with the ecological limits and social needs. The evaluation results can be potentially used by different stakeholders, including planners, designers, local authorities, the real estate market and residents. The central objective of most assessment tools is to act as a decision support tool. The final results must provide an adequate and reliable picture of the situation on the ground. They have the potential to guide decisions for planning, guide the evaluation of actions and the degree of progress towards sustainable development and to educate residents. The results should be simple and transparent to avoid greenwashing and unfounded decisions. The results are analysed to assess their ability to meet specified characteristics. BREEAM and LEED-ND Communities have a similar way of presenting the final results. The only difference between the two is that in BREEAM Communities, the projects that fail to acquire threshold points are also labelled. In most cases, certified projects receive a label based on the rankings they have achieved. CASBEE-UD, addressed, to some extent, deficiencies identified by presenting the results of each theme. In addition, there are scales (weak, good, very good, excellent) that can be used to highlight some performances. Although the tools are tailored to the priorities and conditions of their countries, the differences in climate parameters, social, and economic and type of developments are essential to make a customization of standards. However, this may not be possible due to various constraints. In such situations, the adopted standard should be adapted and customized using benchmarks and appropriate weightings to be used as part of the assessment. Due to significant changes in scope, planners should be aware that one size does not fit all. A personalized and customized tool with additional information is required for each development.

3. THE METHODOLOGICAL APPROACH

In this first stage, the opportunity to engage citizens in an urbanization project and the use of certain methods to help communities develop a list of indicators will be discussed. This approach to decision making is primarily a political responsibility. It enables decision makers to explain and justify their choices and objectives to citizens. The methodology is planned in three steps (Figure 1). In the first step, an area will be selected in order to perform a statistical analysis of data.

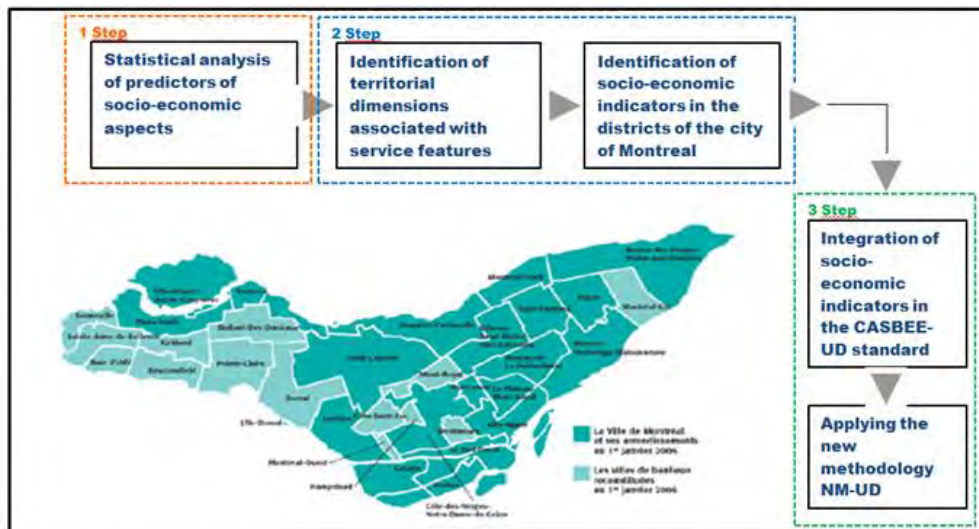

Figure 1: The methodological approach

With the statistical analysis, the independent variables of socio-economic aspects will be selected. In the second step, an analysis of the territory of each district to identify territorial dimensions (average distance of clinics, hospitals, public transportation, etc.) associated with the service functionality will be completed. In the same step, socio-economic and territorial indicators of each selected neighbourhood will be identified. In the third step, socio-economic and territorial indicators will be integrated into the CASBEE-UD standard and the new standard will be applied to the selected territory.

3.1. First step: Search for independent variables

In this stage, the criteria that have been selected are analyzed in four districts of the city of Montreal to measure their degree of sustainability. We initially chose to take the data that were used by the boroughs of Ahuntsic-Cartierville, Plateau Mont Royal, Sud-Ouest and Lachine to test the methodology through a statistical evaluation (see Table 1). The choice of these districts was made to combine the of each district (e.g. economics) in order to create a better sample. For this assessment, a statistical analysis is used for research of independent variables. After testing the results of these four districts, the analysis will be extended to all districts of Montreal for the assessment to be statistically representative. In this first stage, it was found that there are differences between the criteria selected by the standards and those used by the boroughs. To normalize the data, the equation was used to find the value for which our indices are to be divided. This statistical analysis gives the possibility of finding the weighting for each criterion. These statistical analyses will meet the first objective of our research. In this first stage, it was noted that there is an absence of territorial criteria in the characterization of citizen satisfaction. So the next step in an analysis of the territory will be carried out to identify the missing criteria.

Equitable social value and social responsibility	Strengthening cohesion and social equity	Accessibility Public spaces Density Distribution of services Inclusion Security	
	Enhancement of architectural heritage (buildings and materials) and historical (preservation of historical memory)	Structure Materials Technology Protection Care and maintenance Form Architectural fragmentation Architectural quality	
	Cost reduction	Waste management Distribution of functions Use - activity Contiguity	
	Increased cohesion (accessibility and transport) and economic dynamic (jobs and enterprises)	Streets frame Public transport Ease of movement Traffic flow Parking Link, connection Economic diversification	
	Multi-functionality of the territory, territorial competitiveness	Location Connection Partition areas Urban frame Public areas Historical activities	
	Economic strategy		

Table 1: Independents variables

3.2. Second step: The location of the essential functions

To meet the second objective, considering the territorial dimension, the proposed approach will be based on the use of geographic information systems (GIS) to study urban form. GIS is composed of different layers of geographic reference information. This will allow the user to combine the desired information and view it on a map. A multi-criteria analysis model will be used to synthesize geographic information to select indicators satisfying citizens' preferences. So the territorial dimensions will be identified to associate with the service capabilities across the GIS software for urban information and geographical shape. This information will include the criteria that are based on territorial characteristics and the location of critical functions for the quality of life of citizens. This approach was made to represent the diversity and distribution of the functions in the territory. Following this approach, the socio-economic and territorial indicators will be identified through a tool for decision support through a multi-criteria analysis method of hierarchical (Analytic Hierarchy Process (AHP)). With this method (AHP) it will be possible to determine the benefit / cost ratio of a project as for the advantages and disadvantages of its implementation that cannot be measured with money. All information is available both quantitatively and qualitatively. With this method, it is possible to treat problems with qualitative data type. This step will meet the second objective.

3.3. Step Three: Integration of indicators and application of the new standard

The third step is structured in two parts. First, the socio-economic indicators identified will be included in the CASBEE-UD standard and this standard will be applied to the selected territory. The application of the new standard (CASBEE-UD new version) validate its power through the comparison between the selected standard and the new standard. The validation will be given either by the presence of socio-economic indicators, either through using hierarchical approach to the decision that will compare the two methods of assessment and see the improvements. For a confrontation with targeted problems, this type of approach leads to innovative solutions, both through the application of certain technological developments by redefining the governance process. This creative dimension is integral to the philosophy of this type of project and often also a success factor for the implementation on the ground of an increased number of sustainability criteria.

4. DISCUSSION

A sustainable neighbourhood should also be considered a closed system and turned in on itself. By its size and quality, it will add value to an urban area far beyond its physical boundaries. In the literature, we realize that certification standards are, however, looking for a common measure. It is important to ensure that all certification steps are measured in the same manner to give a consistent message to the industry. This does not mean adopting a universal certification system. Overall, the various systems have many differences. A rough comparison, carried

out by researchers BREEAM, buildings with a score of "Platinum" (the highest) for LEED, reach a score lower in the ranking of BREEAM. In Europe, where the certification standards are more stringent than in the USA. Europe has also adopted the analysis of life cycle assessment (LCA) to a greater degree than in North America. In recent years, Japan, on the other hand, has developed innovative policies with respect to the state of its cities (Tokyo, Osaka). This is one reason why, in this study, the use of CASBEE-UD was chosen as a comparison standard. In its structure CASBEE-UD uses not only concepts linked to the building but also concepts related to the entire site's external environment. However, in this standard, the mainstreaming of social acceptability and identification of relevant indicators are not present. It is believed that the integration of these brings an improvement and a more concrete assistance in the design of a more sustainably built environment. We are of the opinion that this study is not comprehensive, but its structure is possible to highlight the fixed points that could help others seek to improve the structure of existing standards and make them independent of the interests of the furniture market which is oriented more towards labelling rather than take to heart the expectations of citizens.

REFERENCES

- [1] AlQahtany, A., Y. Rezgui, and H. Li, A proposed model for sustainable urban planning development for environmentally friendly communities. *Architectural Engineering and Design Management*, 2013. 9(3): p. 176-194.
- [2] Bramley, G. and S. Power, *Urban Form and Social Sustainability: The Role of Density and Housing Type*. *Environment and Planning B: Planning and Design*, 2009. 36(1): p. 30-48.
- [3] Burnett, J., *City buildings—Eco-labels and shades of green!* *Landscape and Urban Planning*, 2007. 83(1): p. 29-38.
- [4] Chang, Ni-Bin, G. Parvathinathan et Jeff B. Breeden. 2008. « Combining GIS with fuzzy multicriteria decision-making for landfill siting in a fast-growing urban region ». *Journal of Environmental Management*, vol. 87, no 1, p. 139-153.
- [5] Choguill, C.L., *Developing sustainable neighbourhoods*. *Habitat International*, 2008. 32(1): p. 41-48.
- [6] Daugareilh, Isabelle. 2009. « La responsabilité sociale des entreprises, un projet européen en panne ». *Sociologie du Travail*, vol. 51, no 4, p. 499-517.
- [7] Holden, M., Sustainability indicator systems within urban governance: Usability analysis of sustainability indicator systems as boundary objects. *Ecological Indicators*, 2013. 32: p. 89-96.
- [8] Holden, Meg. 2013a. « Sustainability indicator systems within urban governance: Usability analysis of sustainability indicator systems as boundary objects ». *Ecological Indicators*, vol. 32, no 0, p. 89-96.
- [9] Kyrkou, Dimitra, et Roland Karthaus. 2011. « Urban sustainability standards: predetermined checklists or adaptable frameworks? ». *Procedia Engineering*, vol. 21, no 0, p. 204-211.
- [10] Luederitz, C., D.J. Lang, and H. Von Wehrden, A systematic review of guiding principles for sustainable urban neighborhood development. *Landscape and Urban Planning*, 2013. 118: p. 40-52.
- [11] Maleki, M. Z., M. F. M. Zain et Amiruddin Ismail. 2012. « Variables communalities and dependence to factors of street system, density, and mixed land use in sustainable site design ». *Sustainable Cities and Society*, vol. 3, no 0, p. 46-53.
- [12] Mori, K. and A. Christodoulou, Review of sustainability indices and indicators: Towards a new City Sustainability Index (CSI). *Environmental Impact Assessment Review*, 2012. 32(1): p. 94-106.
- [13] Sharifi, A. and A. Murayama, A critical review of seven selected neighborhood sustainability assessment tools. *Environmental Impact Assessment Review*, 2013. 38: p. 73-87.
- [14] Sharifi, A. and A. Murayama, Neighborhood sustainability assessment in action: Cross-evaluation of three assessment systems and their cases from the US, the UK, and Japan. *Building and Environment*, 2014. 72: p. 243-258.
- [15] Sharifi, A. and A. Murayama, Viability of using global standards for neighbourhood sustainability assessment: insights from a comparative case study. *Journal of Environmental Planning & Management*, 2015. 58(1): p. 1-23.

Development of a Comprehensive City Assessment Tool Applicable to Various Type of Cities Around the World: CASBEE-City (worldwide use version)

Shun KAWAKUBO^a, Shuzo MURAKAMI^b, Toshiharu IKAGA^c, Yasushi ASAMI^d, Junya YAMASAKI^e

^a Hosei University, Japan, kawakubo@hosei.ac.jp

^b Institute for Building Environment and Energy Conservation, Japan, murakami@ibec.or.jp

^c Keio University, Japan, ikaga@sd.keio.ac.jp

^d The University of Tokyo, Japan, asami@csis.u-tokyo.ac.jp

^e Keio University, Japan, woodenbat@a6.keio.jp

ABSTRACT

This paper introduces the concept and assessment framework of a sustainability assessment tool for cities around the world, called Comprehensive Assessment System for Built Environment Efficiency (CASBEE)-City (worldwide use version). CASBEE offers systemized tools that can be applied to a variety of spatial scales, such as individual buildings, urban districts, and cities. CASBEE-City (worldwide use version) is specifically designed for city-scale assessment and can be applied to various types of cities globally. The tool enables users to understand target cities comprehensively based on environmental load and quality, comprising environmental, social, and economic quality and activities. A city that achieves high quality measures while imposing a low environmental load is recognized as a more sustainable city within the framework. Assessment items and indicators must be carefully selected to enable assessment of cities in both developing and developed countries. To this end, candidate indicators were selected after reviewing various materials issued by international organizations such as the United Nations and its related organizations (UN-Habitat, UNESCO, World Bank, World Health Organization), the International Organization for Standardization, and the Organisation for Economic Co-operation and Development. Indicators were selected taking several key criteria into account, including data availability, simplicity, reliability, policy relevance, and balance among items. Cities were assessed by aggregating the information from selected indicators. Seventy major cities in the world were assessed using the tool and practicality of the tool has been verified.

Keywords: green rating tool, sustainable cities, comprehensive assessment

1. INTRODUCTION

Twenty fifteen was an important year for reconsidering how we can achieve sustainable development globally. The Sendai Framework for Disaster Risk Reduction 2015–2030 (HFA2) was adopted in March, the Addis Ababa Action Agenda (AAAA) was adopted in July, the Sustainable Development Goals (SDGs), officially referred to as Transforming our world: the 2030 Agenda for Sustainable Development, were adopted in September, the Paris Agreement under the United Nations Framework Convention on Climate Change was adopted in December.

As highlighted in Goal 11 of the SDGs, making cities and human settlements inclusive, safe, resilient, and sustainable is currently a priority. Cities and local and subnational governments (referred to as cities and communities hereafter) are key players in achieving sustainable development by implementing effective local policies, promoting financing, developing high-quality infrastructure, delivering basic services for the citizens, and functioning as a hub of meta-governance or multi-level governance.

To make steady progress toward achieving SDGs, it is vital to assess the effectiveness of implemented policies, and to understand the current conditions in cities and communities by using appropriate indicators and publically collectable data. Consequently, the Committee for the Development of an Environmental Performance Assessment Tool for Cities (2015) has developed a tool that enables all stakeholders to assess cities and communities.

2. STUDY METHODOLOGY

The Comprehensive Assessment System for Built Environment Efficiency (CASBEE)-City (pilot version for worldwide use) tool was developed for assessing cities and communities around the world. CASBEE allows a comprehensive assessment of the target with respect to quality (Q) and environmental load (L). CASBEE

calculates the Built Environment Efficiency (BEE) value, defined as Q divided by L as shown in Fig. 1. Cities and communities with high BEE values are more sustainable.

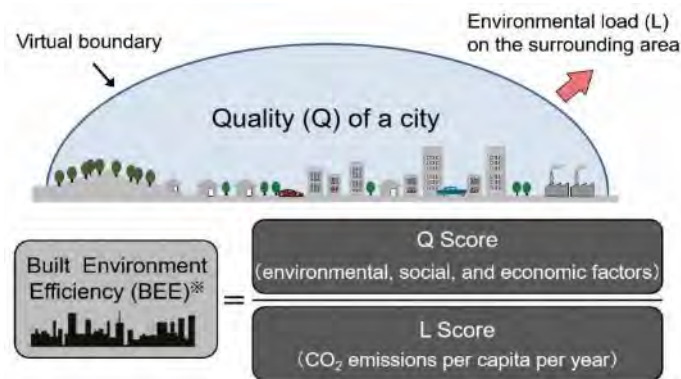

Figure 1: Overall structure of CASBEE-City (pilot version for worldwide use)

The assessment of Q is based on the concept of the triple bottom line, in which the quality of a city or community is comprehensively assessed from environmental, social, and economic perspectives that are the three pillars of sustainability. Assessment of L is based on greenhouse gas (GHG) emissions resulting from daily human activities. Decarbonization requires urgent action, and cities and communities that emit less GHGs are more eco-friendly.

The assessment results for cities and communities are plotted on a two-dimensional graph, called a BEE chart, with the Q score on the vertical axis and the L score on the horizontal axis (left side of Fig. 2). Cities and communities where Q is high and L is low are plotted on the top left of the BEE chart and are more sustainable (right side of Fig. 2). In contrast, cities and communities with low Q and high L are less sustainable under the CASBEE assessment structure.

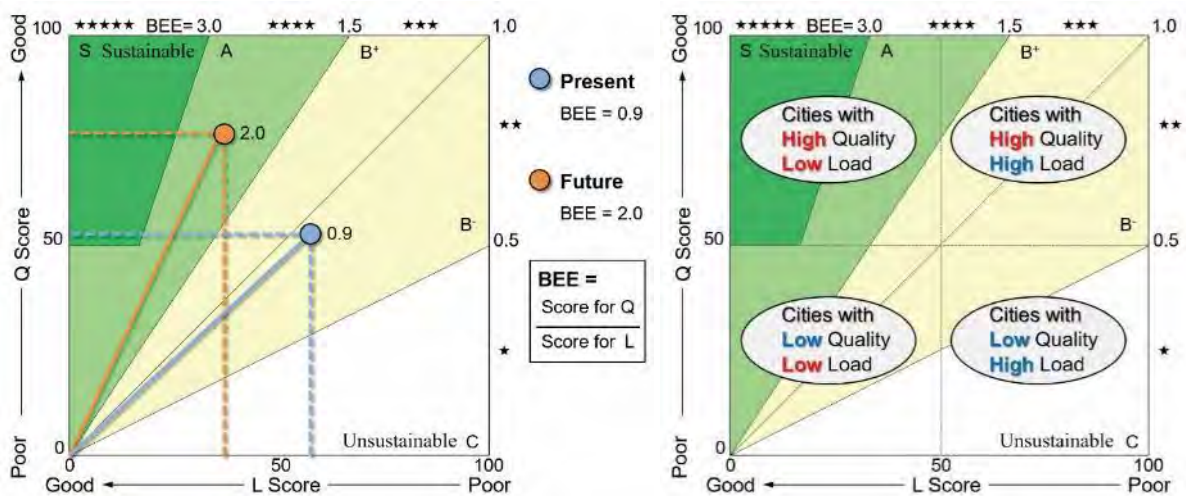

Figure 2: Visualization of assessment results on BEE chart

CASBEE uses a relative assessment system, and a city or community is assessed by each indicator on a scale of 1–5. The CASBEE-City tool was initially developed to assess municipalities in Japan and the worst scoring city or community was assigned as 1 on the scale, 3 indicated an average score, and 5 was the highest score (Murakami et al., 2011; Kawakubo et al., 2011). In this study, the assessment targets are cities and communities all over the world (Fig. 3). These scores are multiplied by a weighting coefficient and the score for Q on the five-point scale is obtained. Finally, 1 is subtracted from the score for Q, and then multiplied by 25 to convert it to 100-point scale (Q Score).

The assessment of L in CASBEE-City is limited to GHG emissions. GHG emissions are converted to their carbon dioxide equivalents and evaluated based on annual GHG emissions per capita (t-CO₂ eq/person/year) to ensure a fair assessment regardless of the population size. A L Score on a scale of 0 to 100 is calculated by applying a

logistic function where the global emissions average per capita (approximately 5 t-CO₂ eq/person/per year) is represented as a median value of 50.

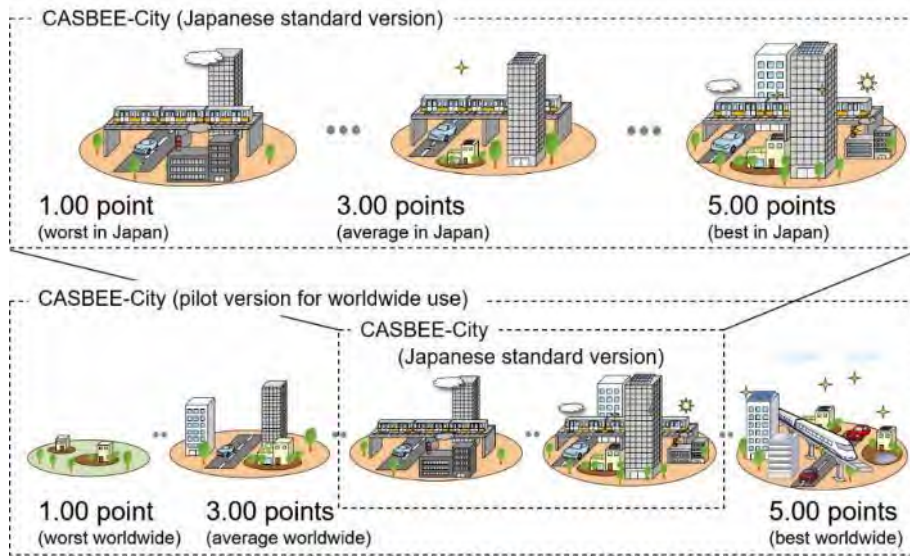

Figure 3: Relative assessment system of CASBEE-City (pilot version for worldwide use)

Assessment indicators that are applicable to cities and communities were selected from the SDGs indicators and ISO 37120 indicators, and some indicators were altered slightly (Fig. 4) (IAEG-SDGs, 2015; ISO, 2014).

Initially, there were more than 300 candidate indicators. The indicators were selected considering the following criteria: 1) data availability, 2) simplicity, 3) reliability, 4) applicability to public policy, and 5) balance among assessment items. The selected indicators are shown in table 1.

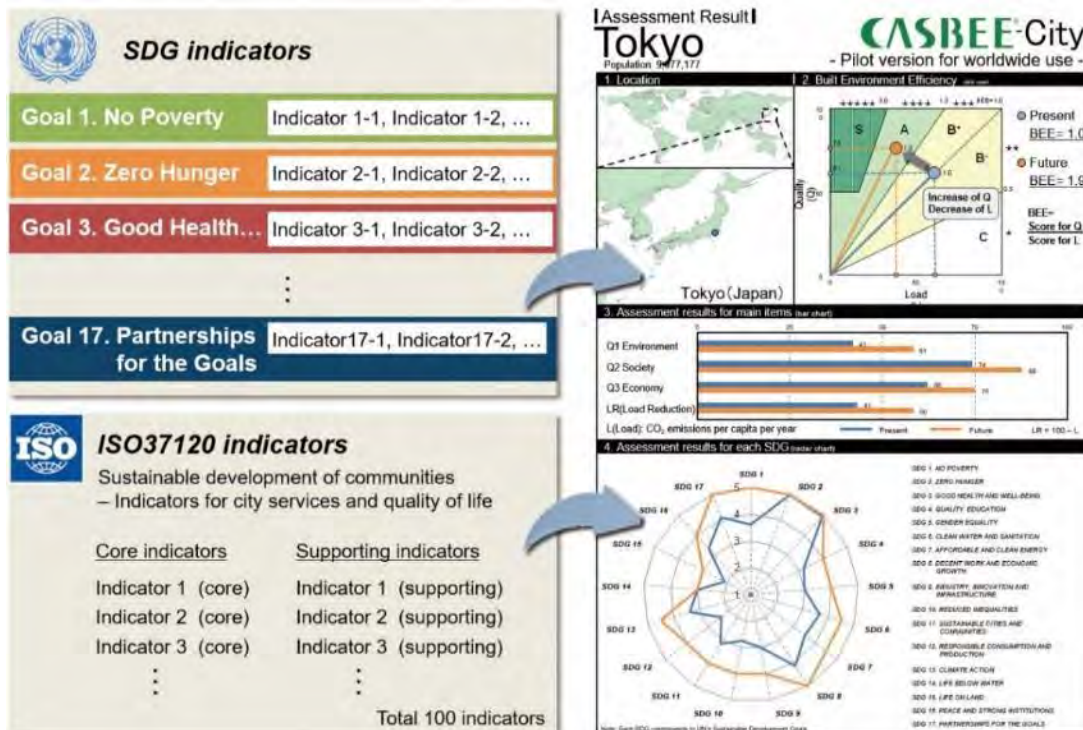

Figure 4: Selection of indicators from SDGs indicators and ISO 37120 indicators

Q1: Quality (environmental aspect)	
Q1.1	Percentage of population using safely managed water services
Q1.2	Percentage of population using safely managed sanitation services
Q1.3	Annual domestic water consumption per capita
Q1.4	Percentage of a city's total energy consumption derived from renewable sources
Q1.5	Mean urban particulate matter air pollution (PM2.5)
Q1.6	Area of public green space as a proportion of total city space
Q1.7	Percentage of urban solid waste regularly collected and well managed
Q1.8	Consumption of ozone-depleting substances per capita
Q1.9	Percentage of the urban solid waste that is recycled
Q1.10	Implementation of a transparent and detailed deep decarbonization strategy
Q1.11	Share of coastal and marine areas that are protected
Q1.12	Percentage of forest area under sustainable forest management
Q1.13	Red List Index
Q2: Quality (social aspect)	
Q2.1	Total fertility rate
Q2.2	Proportion of population below minimum level of dietary energy consumption
Q2.3	Prevalence of stunting in children under 5 years of age
Q2.4	Infant mortality rate
Q2.5	Death rate associated with HIV/AIDS, death rate associated with all forms of tuberculosis, death rate associated with malaria
Q2.6	Probability of dying between exact ages of 30 and 70 from cardiovascular disease, cancer, diabetes, or chronic respiratory disease
Q2.7	Road traffic deaths per 100,000 population
Q2.8	Average life expectancy
Q2.9	Number of physicians per 1,000 population
Q2.10	Preprimary enrollment rate (% of relevant age group)
Q2.11	Primary completion rate (% of relevant age group)
Q2.12	Tertiary enrollment rate (% of relevant age group)
Q2.13	Percentage of women aged 20-24 who were married or in a union before age 18
Q2.14	Primary enrollment rate of girls (% of relevant age group)
Q2.15	Women as a percentage of total elected to city-level office
Q2.16	Annual number of public transport trips per capita
Q2.17	Number of fire related deaths per 100,000 population
Q2.18	Violent deaths per 100,000 population
Q2.19	Percentage of children under age 5 whose birth is registered with a civil authority
Q2.20	Existence of a national law or constitutional guarantee on the right to information
Q2.21	Number of homicides per 100,000 population
Q3: Quality (economic aspect)	
Q3.1	Proportion of population below \$1.25 (PPP: purchasing power parity) per day
Q3.2	Proportion of population living below national poverty line
Q3.3	Share of the population using reliable electricity
Q3.4	GNI per capita (PPP: purchasing power parity)
Q3.5	Youth employment rate (aged 15-24)
Q3.6	Unemployment rate
Q3.7	Mobile broadband subscriptions per 100 population
Q3.8	Number of internet connections per 100 population
Q3.9	GNI share of richest 10%
Q3.10	Percentage of urban population living in slums or informal settlements
Q3.11	Domestic revenues allocated to sustainable development as percent of GNI
Q3.12	Debt service ratio (debt service expenditure per municipality's own source revenue)
Q3.13	Share of SDG Indicators that are reported annually
L: Environmental load	
L	Annual CO ₂ emissions per capita

Table 1: Selected assessment indicators for CASBEE-City (pilot version for worldwide use).

Seventy major cities in the world were assessed to check how the tool works, its feasibility, and the accuracy of the assessment results. Cities were chosen from every continent, and included developing and developed

countries to determine the progress of SDGs in each region. The tool is theoretically applicable to all cities and communities, including small towns and villages where statistical data exists; however, major cities were chosen as assessment targets because it is easier to collect data for the assessment and to evaluate whether results are reasonable. Figure 5 shows the number and distribution of the assessed cities.

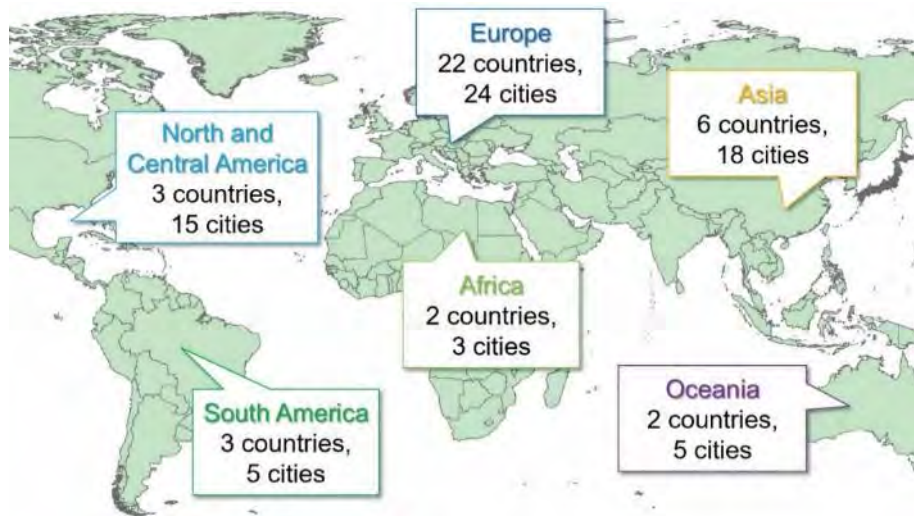

Figure 5: Number and distribution of the cities assessed with the CASBEE tool

3. ASSESSMENT RESULTS

Selected major cities were assessed with CASBEE, and the results are plotted on the BEE chart. Figure 6 shows the assessment results by region, and a single plot represents a city.

Cities in developing regions, such as Southeast Asia and Africa (except some exceptions such as Singapore), tend to have lower Q scores than other cities. In contrast, many cities in developed regions, such as Europe, North America, East Asia, and Oceania, have higher Q scores. However, these results are reversed for L. Many cities in developing regions emit less GHGs than the world average, whereas many cities in developed regions emit more than the world average. Therefore, some cities in developing regions have better BEE (= Q/L) values than cities in developed regions, indicating that more decarbonization is required for cities in developed regions.

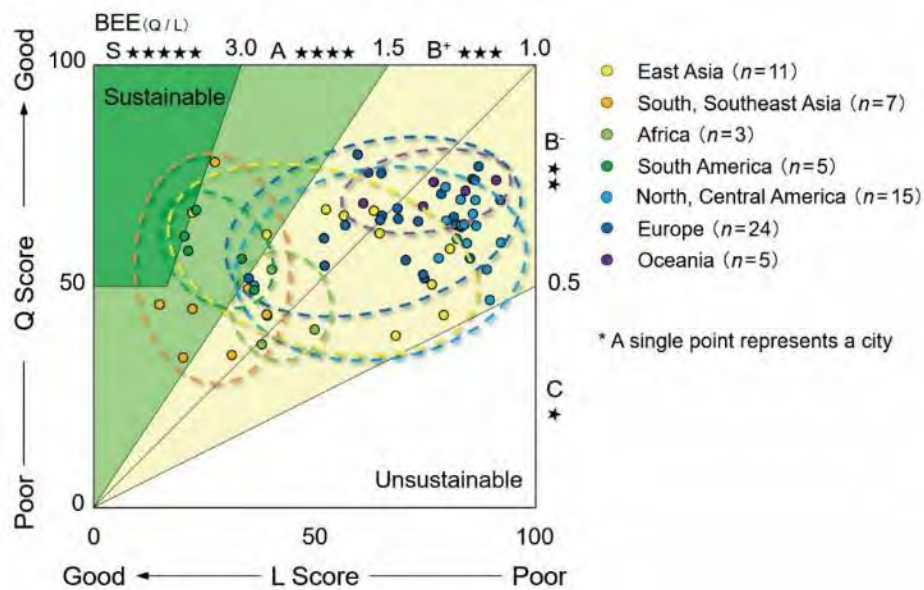

Figure 6: Assessment results for selected cities using the CASBEE tool

Preferred development paths for each city or community group are shown in Fig. 7. Cities and communities in developed regions should drastically reduce L, whereas those in developing regions should increase Q without increasing L. Further international collaboration is required to achieve this goal.

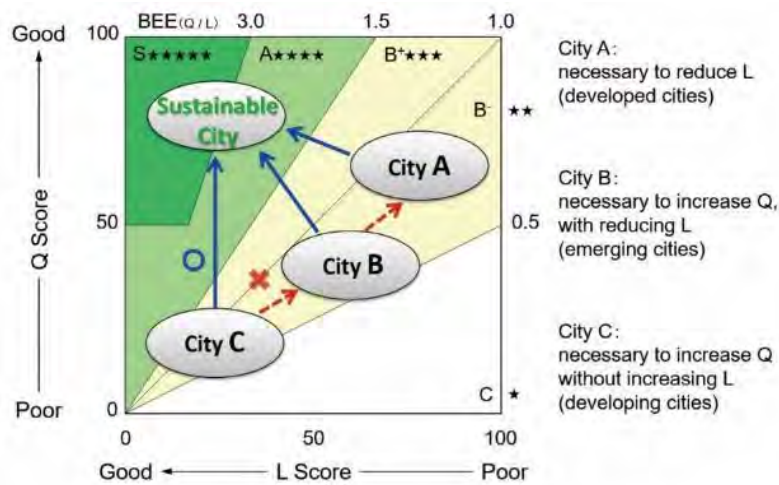

Figure 7: Preferred development paths for each city or community group

4. CONCLUSIONS

The concepts and assessment framework for a sustainability assessment tool for cities around the world, called CASBEE-City (worldwide use version) have developed. The tool consists of approximately 50 indicators that are selected from SDGs and ISO 37120 indicators. The trial assessment of major cities with the tool confirmed that cities in developed regions achieve a high Q score by emitting large amounts of GHGs, whereas cities in developing regions show the opposite trend.

This type of assessment should be performed continuously to monitor progress toward achieving SDGs and other global agendas in cities and communities. It is also important to determine best practices and share the experience of the most sustainable cities and communities to be sustainable in more efficient manner. International collaboration among countries and also at a subnational scale is critical for achieving global agendas.

Although a tool for assessing cities and communities have described to support all stakeholders in understanding the status of their cities and communities, and to help them identify key problems, it is still necessary to improve the assessment structure of the tool. For example, the selection of indicators should be reconsidered because it strongly affects the assessment results. Developing effective, easy-to-use assessment tools is essential for sustainable management of cities and communities, and thus further studies are required in this field.

REFERENCES

- [1] Committee for the Development of an Environmental Performance Assessment Tool for Cities, 2015. CASBEE-for Cities; Pilot version for worldwide use version (2015). Institute for Building Environment and Energy Conservation (IBEC), ISBN 978-4-9907-4259-1.
- [2] International Organization for Standardization, 2014, Sustainable development of communities – Indicators for city services and quality of life, ISO 37120:2014(E).
- [3] Inter-agency and Expert Group on Sustainable Development Goal Indicators (IAEG-SDGs), 2015. Agenda Item 4 - Review of proposed indicators - 2 Nov 2015, Second meeting of the IAEG-SDGs, Bangkok, 26–28 October.
- [4] Kawakubo, S., Ikaga, T. and Murakami S., 2011. Nationwide Assessment of City Performance Based on Environmental Efficiency. International Journal of Sustainable Building Technology and Urban Development, 2(4), 293–301.
- [5] Murakami, S., Kawakubo, S., Asami, Y., Ikaga, T., Yamaguchi, N., and Kaburagi, S., 2011. Development of a comprehensive city assessment tool. Building Research & Information, 39(3), 195–210.

Session 2.5: SBE Assessments – Green Neighbourhoods (2)

Value Management as Tool for Delivering Sustainable Rail Projects

Ayodeji Emmanuel OKE^a, Clinton Ohis AIGBAVBOA^b, Njabulo Sydney NGUBANE^c

^a University of Johannesburg South Africa, emayok@gmail.com

^a Federal University of Technology Akure, Nigeria, emayok@gmail.com

^b University of Johannesburg South Africa, calgbavboa@uj.ac.za

^c University of Johannesburg South Africa, njabulons@gmail.com

ABSTRACT

Value Management (VM) is a multi-disciplinary tool developed to ensure that projects are delivered to the best function at the lowest possible overall whole life cycle cost. This implies that VM will not only provide value for money for construction projects but will also enhance projects that are financially, socially and environmentally sustainable. This research therefore, explores the drivers, barriers, benefits and factors affecting application of VM to rail construction projects. Using quantitative approach, data were collected through well structure close-ended questionnaires that were personally distributed and administered on built environment professionals. It was ensured that the respondents have ample experience of construction projects and adequate knowledge of value management concept. Findings from the study revealed that, professionals in rail environment are aware of VM and agreed that its application will not only eliminate unnecessary costs in design, materials and labours but will enhance that projects are conceived and executed in sustainable manner. This is as a result of the fact that VM creates change on purpose rather than letting change happen accidentally. The rate of application of VM to rail construction projects is very low and this is due to reluctance to change as well as lack of guidelines, information, knowledge and experience of the discipline among professionals and other stakeholders in the industry. It is therefore expedient for stakeholders involved in rail construction to pay special attention to the application of VM in their quest to enhance project success and deliver projects that are sustainable in all ramifications.

Keywords: infrastructure development, sustainable neighbourhood, value engineering

1. INTRODUCTION

Value management (VM) is an intensive, interdisciplinary problem solving activity that focuses on improving the value of functions that are required to accomplish the goal, or objective of any product, process, service, or organization (Elayache, 2010). The technique helps in determining the unnecessary costs which can be eliminated to save costs while not jeopardizing the function and quality of the final product. According to Chougule, et al., (2014), the technique was introduced by an engineer named Larry Miles as value analysis in 1947. The term has been used synonymously with value engineering and value analysis. However, Oke and Ogunsemi (2013a) noted that some school of thought believe that value management is a combination of value engineering and analysis. The process is referred to as value analysis at the pre-construction stage and value engineering at construction and evaluation stage. It is not a cost-cutting exercise but the purpose is to improve the value project by eliminating unnecessary costs, which could result in production of product/project at a minimal cost (Oke, et al., 2015).

Value management was initially introduced for manufacturing firms but it has gained wider popularity in the construction industry due to its ability to reduce project cost thus enhancing project value (Bowen, et al., 2010). Oke and Ogunsemi (2011) observed that value management is widely accepted as an important tool in the management of construction projects. While this may be so for construction industries in developed countries, Bowen et al. (2010) noted that the situation is by no means so clear for developing nations like South Africa. This indicate that the technique of value management can aid production and sustenance of sustainable projects. In view of this, this study examined the level of application of value management in rail projects in South Africa and benefits associated with the usage in the quest for continuous delivery of sustainable projects.

2. CONCEPT AND BENEFITS OF VALUE MANAGEMENT

Saving money and, at the same time, providing better value is a concept that is necessary and important in satisfying owners of construction projects and other stakeholders (Bharathi and Paranthaman, 2014). Behncke, et al., (2014) stated that value management is not just focusing on cost reduction, but on the principle of increased value. The principle of value management then becomes necessary in quest for achieving better value of construction projects. An important construction process where effective planning and assurance of value for money are ensured is the design stage. Based on traditional procurement approach, design process begins with **the architect's asset, core competencies and desire to create a product that ideally matches the client's priorities** (Al-Yousefi, 2007). This indicate that value management should be adopted right from this stage. Rich (2000) noted that the technique assist in terms of achieving the best practice with which to develop an optimal design. More so, in cases where the designer see the need to change the design, the technique allows the changes to be incorporated formally.

Value management has been introduced in the 1950's in the United States and since its introduction, it has been employed in various countries around the world (Chen, et al., 2009). Value Engineering (VE) was developed during World War II as a method to find alternative methods and materials for processes and products that were limited and challenged by rationing. Since its creation, the use of the VE process has extended to the construction industry as a way to maximize the value of a project (Seidel, 2012).

Value management has been considered as an organized approach which can obtain the most optimum value of the unit cost, while assures the quality, safety, reliability, and maintainability of a construction project (Oke, et al., 2015). It is a systematic application of recognized techniques by multidiscipline teams which identify the function of a product or service; establish a worth for that function; generates alternatives through the use of creative thinking; and provides the needed function, reliabilities, at the lowest overall cost or Life Cycle Cost (Simpkins, 2000). Basically, value management is finding alternative ways of eliminating unnecessary cost without having any effect on the quality and functionality of the project. According to Aghimien and Oke (2015), the approach is a strategic thinking process that involves the systematic and objective assessment of project component alternatives. Oke, et al., (2015) explained that value management can be considered as a systematic and innovative multidisciplinary method that examines the functional needs of a product, service and project design as well as facility and system in achieving greater value and optimum cost without affecting the level of performance in the programme and project.

Value management has been internationally recognized as an efficient modern management methods and it has unique benefits of reducing costs while improving product value. Domestic and international practice shows that the application and promotion of value engineering can get great economic benefits (Oke and Ogunsemi, 2011). According to Bowen, et al., (2009), one of the benefits of VM is the provision of good engineering judgement to produce better projects to the clients. It was further revealed that application of VM in any project actually lowers the project cost with a certain percentage which is a benefit to clients. Practitioners apply VM methodology to products and in industries such as the following: corporations and manufacturing, construction, transportation, government, health care and environmental engineering. This is due to the fact that VM methodology easily produces savings of 30 % of the estimated cost for manufacturing a product, constructing a project or providing a service (Chougule, et al., 2014). Chavan (2013) noted that the principle aid correct and cost effective solutions to various construction problems by ensuring functional correctness before deciding on the solution to be implemented.

According to Oke and Ogunsemi (2013b), value management has been practiced for half a century in the construction industry with an intention to bring into existence innovative ideas and solutions for enhancing project value. It concentrates on effectiveness through stating functions, goals, objectives, needs, requirement and desires, then define the quality features that make the product more acceptable (Al-Yousefi, 2007). At the end the value management exercise, it is expected that report and proposal emanating from the process should meet functional requirements at the least possible whole life cost.

3. RESEARCH METHODOLOGY

Due to the nature of this research and information obtained from existing literature in the area of value management and sustainable construction, a descriptive survey design was adopted. This is in line with the assertion of Polit and Hungler (1993) as well as Mouton (2001) that surveys may be used for descriptive, explanatory and exploratory research. More so, the method is useful for obtaining basic characteristics data relating to behaviour, beliefs, abilities, knowledge and opinions of a individual, group of people or situation. Quantitative research technique was preferred in soliciting required information from respondents since needed variables are available in literature. The population include professionals who are directly employed by various organizations specializing in rail projects and consultants working as clients representatives for the projects. Purposive sampling was used in sampling the respondents with a view to involving only individuals with relevant and adequate experience of value management principles and rail construction in the study area.

Close-ended questionnaire was designed for the study due to the advantage of high response rate. The questionnaire was designed in English language as all the respondents were expected to understand the language and could read and answer the questions. In the cover letter, they were given assurance of their anonymity in responding to the questions and that the outcome of the study will solely be used for academic purpose. Instructions and guidelines to completing the instruments as well as the average duration it will require to respond to the questions were also provided. The first part of the instrument was aimed at gaining demographic data relating to level of experience, education etc. of respondents for the purpose of better interpretation of the findings. The other part was structured to obtain information on the application and implementation of value management in rail construction projects.

Due to the require experience of rail projects, the instruments were administered through personal hand delivery and electronic mail on identified respondents. The instruments were retrieved through the same means. 107 questionnaires were distributed but at the end of the collection period, 89 were returned while 82 were correctly and completely completed and found worthy of further analysis. Frequencies and percentage were adopted to analyse questions regarding background information of respondents. 5-point Likert scale was adopted for the main aspect of the instrument and mean item score (MIS) was employed to analyse the data. This is to identify the level of importance of the identified variables in order to rank them accordingly.

4. RESULTS AND DISCUSSION

4.1. Biographical information of respondents

Academic qualification of respondents reveals that 22%, 49% and 29% possess post-graduate degree, bachelor's degree and post matric diploma or certificate respectively. In term of their professional qualification, 24% are construction project managers, 12% are construction managers, 15% are project managers, 17% are engineers, 15% are quantity surveyors, 5% are architects while the remaining 12% are experts in the field of general management, planning, materials procurement, etc. All the respondents have more than 5 years experience in the construction industry and the larger percentage have been in the industry for more than 16 years. All of them are aware of value management principles through seminars, workshops and practical application on construction projects. These findings indicate that information supplied by the respondents are reliable and trustworthy to draw conclusion concerning value management and sustainability of rail projects.

4.2. Benefits of value management for rail projects

Value management is currently utilized in the organisation of about 63% of the respondents, while the reaming 37% are yet to adopt the technique in the development and planning of their projects. More so, 37% have not adopted the technique in any projects, 22% have applied the principle in approximately 1 to 5 projects, about 20% have used the method in approximately 5 to 10 projects, 12% have employed it in approximately 10 to 15 projects while the reaming 10% have applied the principle in more than 15 projects.

Table 1 represents the advantages of the application of VM in the rail environment. The major benefits are concerned with the elimination of unnecessary costs and costly design elements. The study further shows that value management fosters innovation and makes a difference to the way a project is conceived and executed. It could be deduced that all the identified benefits are important judging by the least calculated mean item score of

3.72 (out of the possible 5.00). This supports the findings of Oke and Ogunsemi (2011) that value management mainly focuses on eliminating unnecessary costs and costly design elements, and also do foster innovation within the industry. Wilson (2005) also stated that the right application of the principle improve the quality of project, reduce duration, lower cost and enhance overall function through the provision of alternatives.

Benefits	MIS	Rank
VE has a certain scope in the rail environment in South Africa	4.52	1
Eliminates unnecessary costs and costly design elements.	4.52	1
Fostering innovation.	4.44	3
Certainly makes a difference to the way a project is conceived and executed.	4.42	4
Provides cost effective solutions to the problems faced within the project.	4.40	5
Is with advancement in project management tools.	4.37	6
VE enhances the value of the project.	4.34	7
The project cost reduces to a certain percentage.	4.34	7
Provides good engineering judgement to produce better project.	4.32	9
Better defines the purpose of the project.	4.27	10
Provides alternatives of executing the project.	4.25	11
The function of the project gets improved.	4.22	12
Define project functions, goals, objectives, requirements, design criteria and scope of work.	4.17	13
Reduce complicated projects into basic components by analysing its functions.	4.14	14
Improve project quality.	4.09	15
Lowers life cycle cost of the project.	4.07	16
Develop implementation procedures.	4.07	16
The project period will reduce.	3.72	18

Table 1: Application of VE in rail projects

4.3. Influences to implementing VM in rail projects

This section explores various factors affecting the implementation of VM techniques. It could be observed from table 2 that lack of guidelines and information as well as lack of knowledge and practice of the technique of VM are the most important factors influencing the choice and adoption of the practice for construction projects. These factors are followed by reluctance to change, lack of training opportunities, negative attitude, lack of commitment and conflict of objectives by stakeholders. The least influencing factors are concerned with the impression that it interrupt normal work schedule, notion that it not suitable for low cost projects and believe that it is too expensive to carry out. This support the findings of Oke, et al., (2015) as well as Bowen, et al (2010). The top 5 hindrances of value management were identified to include lack of local guidelines and information, lack of knowledge and practices, reluctance to change, lack of training opportunities and negative attitudes and failure to recognize creativity or innovativeness

Factors	MIS	Rank
Lack of guidelines and information about VE/ VM.	4.27	1
Lack of knowledge and practice in VE/ VM.	4.20	2
Reluctance to change.	4.10	3
Lack of training opportunities in VE/ VM.	4.01	4
Negative attitudes and failure to recognize creativity or innovativeness.	3.99	5
Lack of commitment of leadership/ management.	3.93	6
Lack of trained professionals in VE/ VM.	3.93	6
Lack of good communication, misunderstanding, jealousy, and normal friction between professional team.	3.84	8
Conflict of objectives by different stake holders.	3.79	9
Speculations on the project team members and jumping to conclusions, without properly gathering information.	3.77	10
Lack of involvement of the higher management.	3.65	11
Non conducive environment for team work in a project.	3.53	12
The "problem" not describable in function terms.	3.36	13
Human relations are not respected during the VE study.	3.19	14
Interruption to normal work schedule.	3.02	15
Not suitable for low cost projects.	2.35	16
Too expensive to carry out.	2.06	17

Table 2: Factors affecting implementation of VM techniques

5. CONCLUSION AND RECOMMENDATIONS

This research is intended to give ideas to the organizations working within the rail environment on the application of value management for improvement of value and function of their projects. The study evaluated the level of application of value management in construction projects and despite the level of awareness, knowledge and understanding of value management by construction professionals, it was clear that most project managers do not apply the technique for their projects and in their organizations. Value management has proven to be one of the best tool for enhancing value of construction projects by eliminating unnecessary costs.

The findings revealed a number of factors that affects the application of VM techniques, the most important ones are related to lack of guidelines and information about VM; Lack of knowledge and practice in VM; Reluctance to change; Lack of training opportunities in VM; negative attitudes; and failure to recognize creativity or innovativeness. These are therefore essential factors that should be evaluated by organisations and stakeholders in the rail environment in their quest for adoption of value management for sustainable project. More so, Organisations in the rail environment should be concerned about the training of their employees through VM workshops where the employees will be equipped with knowledge about the technique. Professionals involved in rail construction projects should also be ready to adopt changes and innovation by accepting new ideas and technologies.

REFERENCES

- [1] Aghimien, D. O. and Oke, A. E. (2015). Application of value management to selected construction projects in Nigeria, *Developing Country Studies*, 5(17), 8-14.
- [2] Al-Yousefi, A.S. (2007). Value engineering application benefits in sustainable construction. [online] Retrieved from <http://www.pmi-agc.com/techdocs/> on [Retrieved 20 September, 2015]
- [3] Behncke, F.G., Maisenbacher, S. and Maurer, M. (2014). Extended model for integrated value engineering. *Procedia computer science*, 28, 781-788.
- [4] Bharathi, V. and Paranthaman, R. Application of value engineering in construction building, *Indian Journal of Applied Research*, 4(4), 135-138
- [5] Bowen, P., Edwards, P., Cattell, K. and Jay, I. (2010). The awareness and practice of value management by South African consulting engineers: Preliminary research survey findings. *International journal of project management*, 28(3):285-295.
- [6] Chavan, M.A.J. (2013). Use of plastic waste in flexible pavements. *International journal of application or innovation in engineering and management (IJAIEM)*, 2(4): 540-552
- [7] Chen, W.T., Chang, P. and Huang, Y. (2010). Assessing the overall performance of value engineering workshops for construction projects. *International journal of project management*, 28(5):514-527.
- [8] Chougule, A., Gupta, A. and Patil, S. (2014). Application of value engineering technique to A residential Building—Case study, *International Journal of Innovative Research in Advanced Engineering*, 1(12), 115-118
- [9] Elayache, F. (2010). Value Engineering Methodology in Construction. [online] Retrieved from <http://documents.mx/documents/> [Retrieved on 16 August, 2016]
- [10] Mouton, J. (2011). **How to succeed in your master's and doctoral studies: A South African perspective.** Van Schaik Publishers: Pretoria, South Africa.
- [11] Oke, A. E., Aghimien, D. O. and Olatunji, S. O. (2015). Implementation of value management as an economic sustainability tool for building construction in Nigeria, *International Journal of Managing Value and Supply Chains*, 6(4),55-64.
- [12] Oke, A. E. and Ogunsemi, D. R. (2011). Value Management in the Nigerian Construction Industry: Militating factors and perceived benefits. *Proceeding of the second international conference on advances in engineering and technology*, Faculty of Technology, Makerere University, Uganda, 30 January – 1 February, Pp 353-359.
- [13] Oke, A. E. and Ogunsemi, D. R. (2013a). Areas of competencies of quantity surveyors and their relevance to value management discipline, *Proceeding of the 1st NIQS Annual Research Conference*, Shehu Musa Yar'Adua Centre, Abuja, Nigeria, 3rd-5th September, Pp 359 - 368.
- [14] Oke, A.E. and Ogunsemi, D. R. (2013b). Key competencies of value managers in Lagos state, Nigeria. *Proceeding of the West Africa Built Environment Research (WABER) conference*, British Council, Accra, Ghana, 12th-14th August, Pp 773 - 782.

- [15] Polit, D and Hungler, B.P. (1993). Essentials of nursing research. Methods, appraisal and utilization. 3rd edition. Lippincott publishers, Philadelphia.
- [16] Rich, N. and Holweg, M. (2000). Value analysis, Value engineering: Innoregio: Dissemination of innovation and knowledge management techniques, Report produced for the EC funded project. Lean Enterprise Research Centre Cardiff, United Kingdom.
- [17] Seidel, J. K. (2012). Value engineering trends in the construction industry, Construction Systems Management Program of The Ohio State University, [online] Retrieved from <https://kb.osu.edu/dspace/> [Retrieved on 18 September, 2015]
- [18] Simpkins, W. J. (2000). Value engineering in government and private sector construction, Thesis (PhD), University of Florida. [online] Retrieved from <http://www.dtic.mil/dtic/tr/> [Retrieved on 18th September, 2015]
- [19] Wilson, D. C. (2005). Value Engineering Applications in Transportation: A Synthesis of Highway Practice (Vol.352). Washington DC: Transportation Research Board.

Calculation Methodology of GHG Emissions from a Low Carbon Urban Development in an Underdevelopment Country – Case Study from a LEED ND Certified Project in São Paulo City, Brazil

Maria Carolina FUJIHARA^a

^a Green Building Council Brasil, Brazil, mfujihara@gbcbrasil.org.br

^a University of São Paulo, Brazil, mfujihara@gbcbrasil.org.br

ABSTRACT

Total anthropogenic greenhouse gas (GHG) emissions have continued to increase over 1970 to 2010, even with the implementation of several efforts and reduction policies. Globally, the economic and population growth is directly related to the increase of CO₂ emissions resulting from fossil fuels combustion and industrial processes. Consequently, the direct action in urban areas is essential to the success of global climate change adaptation. **Urban areas concentrate today more than half of world's population and much of its constructive aspects and economic activities.** All cities activities, and how they manage their impacts on the environment are central parts of the problem. However, to create measures and emissions management policies, and therefore air pollution, soil and water management; it is imperative the creation of measurement mechanisms and qualification of each polluting activity inside an urban development context.

This paper presents the greenhouse gas emissions calculation method for a neighbourhood located in São Paulo city, considered as a low-carbon urban development by having a recognized international environmental certification for its project and construction – the first LEED (Leadership in Energy and Environmental Design) Neighborhood Development in Brazil.

The GHG emissions were calculated for the three main urban activities in this neighborhood - stationary power, ground transportation and household waste - using as a base, reputable internationally calculation methodologies adapted to the scale of the neighborhood.

In order to provide a better view and comparability of emissions scenario accounted for, GHG emissions were adapted and calculated for two other Brazilian cities inventories, São Paulo and Recife, according to measurement scales and compared the final results. The results collected from the urban low-carbon development had showed **that it's possible to reduce emissions over time and its applicability is feasible to any other neighborhood/ city in the world, promoting better places to live and less impact on the environment.**

Keywords: climate change, sustainable neighborhood, LEED certification

1. INTRODUCTION

The data presented in the Fifth Assessment Report (AR5) of the United Nations Intergovernmental Panel on Climate Change (IPCC, 2014), states that total anthropogenic GHG emissions have continued to increase over 1970 to 2010, even with the implementation of several efforts and reduction policies. In all instances, national, regional and local (cities), increased data were presented over time, mainly, due to fossil fuels combustion and industrial processes.

Globally, the economic and population growth is directly related to the increase of CO₂ emissions resulting from fossil fuels combustion. When demographic data is compared to national GHG emissions, **it's possible to observe** that seven of the top ten most populated countries are also the top ten biggest GHG emitters in the world, including: China, India, USA, Indonesia, Brazil, Russia and Japan.

Urban areas concentrate today more than half of world's population and much of its constructive aspects and economic activities. All cities activities, and how they manage their impacts on the environment are central parts of the problem, considering each city as a live organism and with differences from each other depending on their **growth's profile. To create measures and emissions management policies related to air, soil and water pollution,** cities must create measurement mechanisms and qualification of each polluting activity inside of a sustainable urban development context.

Recently, there have been developed many advanced approaches to account GHG emissions from a city context, **but none of them related to the neighborhood scale. Its crucial thought, to take a closer to the city's formation and each neighborhood growth's profile separated, to better understand flaws and needs for each individual community and how they are related to the bigger context as the city evolves.**

This paper presents the results from the GHG emissions calculation method for a neighborhood located in the city of São Paulo, considered as a low-carbon urban development by receiving the first LEED Neighborhood Certification in Brazil, a recognized environmental certification for its project and construction. Using a local case study as a reference, it was calculated GHG emissions of three main urban activities in the neighborhood - stationary power, ground transportation and household waste - using as a base, reputable internationally calculation methodologies adapted to the scale of the neighborhood.

In order to provide a better view and comparability of emissions scenario accounted for, GHG emissions were **adapted from two other Brazilian cities' inventories, São Paulo and Recife, according to measurement scales and compared the final results.** This model created is feasible to be applied in any other district or city around the globe, encouraging improvements in urban **low-carbon developments and incentives for a more sustainable city's management.**

2. COMPACT AND SUSTAINABLE CITIES CONCEPT AND THE CASE STUDY 'PARQUE DA CIDADE'

Cities are key elements to global sustainable development given that the population of the planet becomes increasingly urban, with increasingly larger cities, giving rise to megacities and mega regions. Cities are composed of complex interdependent systems that have influence to support adaptation on climate change through government support backed by cooperative governance between different levels of society. To this point, it is possible to create synergies between maintenance and creation of new urban infrastructure, protection and land use management and support of ecosystem environmental services.

It is common to think that the creation of public spaces is a government's task, being impossible to depend on its provision by the private sector. The criticism lies, contrarily, in the creation of public spaces from private initiative that benefits all involved parties, including the population, the entrepreneur, the environment and the city as a whole. Spaces which are not enclosed, no barriers to entry, no-cost access to the end user, inserted in urban areas (where the cost of land is high), financed by the private sector, and yet, they were not the result of legislation that induced or forced their conception, but the intention of those who undertook the space; are fundamental to the sustainable dynamic conception of a city. In this way, a sustainable neighborhood within a city or a metropolis, induces a necessary change of culture to design larger sustainable interventions.

According to these principles, the choice of a sustainable neighborhood in the city of São Paulo, serving as a case study for the calculation and projection of its GHG emissions in the medium and long term, becomes essential to create sustainable parameters and perspectives in large urban centers, megacities, within under development countries.

The 'Parque da Cidade', multipurpose complex developed by OR - Odebrecht Real Estate Developments, was inspired by the concept of compact cities, which consist of limited space and relatively small, where all the essential activities of a city are concentrated, and which have the premise of sustainability.

The general concept states that Compact Cities are usually assigned by highly dense urban developments, with high socioeconomic diversity and improvement of the public sphere (with appropriate, qualified and planned interventions), establishing ample opportunities for social interactions and exchanges. Promote better sense of public safety by creating a sense of community through proximity, mixed-use practices and sidewalks and spaces for collective use, friendly to pedestrians and located within a small urban grid. It also promotes equitable access to goods, services and facilities available, providing a short commute (home - work - shopping), optimizing the use of existing urban infrastructure and stimulating the reduction of car use. In such a way, the compact cities minimize environmental degradation and provide adequate sustainability for improving the quality of life.

Studies show that four key concepts guide the paradigms of urban form of compact cities and GHG emissions directly related to its activities: Population Density, Mixed-use Activities, Connectivity and Accessibility. All these concepts, in contrast, are directly related to priority transportation that citizens use to move daily.

Glaeser states that it would be better for the planet if the urban population starts to live in dense cities built around the elevator, instead of expanded regions built around vehicles. If urbanization is not directly related to high densities (more people living in less space), GHG emissions tend to increase dramatically, mainly because of two internal factors related to cities: daily commuting in individual transportation and; low demand to create public transportation infrastructure away from condensate centers locations and their related emissions originated from individual transportation. Mixed-use compact core reduces the displacement needs and create sustainable neighborhoods full of vitality.

Apart from being compact, the city must be sustainable and review its cycles of demand and consumption, represented by linear and circular metabolisms cities. According to Girardet cited Rogers (2005), "the solution is in search of a circular 'metabolism' in cities, where consumption is reduced by implementing efficiencies and where the reuse of resources is maximized." The resilience of cities is related to its location and its associated secondary processes, located along its boundaries. According to Tickell cited Rogers (2005), "[...] cities are living organisms that absorb resources and produce waste. The larger and more complex they are, the greater will also be its dependence on surrounding areas, and the greater their vulnerability to changes in their surroundings. "

The current linear processes of extraction, manufacture and disposal must not only be replaced by circular process, including reuse, recycling and polluting processes offsets, but should also be reduced to smaller demands, avoiding losses and minimizing waste generation. Therefore, Sustainable Compact Cities replace the city as the ideal habitat for a society based on community. According to Rogers, it is a type of established urban structure that can be interpreted in any way in response to all cultures.

Following Jacobs line of thought (2011), where she suggests that cities must reinvent and propose new uses and improvements in its already established urban fabric, it can be concluded that in the light of sustainable urban development, grow back into the metropolis and not expand its constructions is another highly important aspect: recycle the territory is more intelligent than replace it. Restructure it productively is possible and desirable in the metropolitan strategic planning. In other words, to regenerate productive existing metropolitan territories must be the same aspect of new economic and technological innovation processes.

3. METHODOLOGY AND TECHNIQUES

Launched in 2012 and still under construction, the '**Parque da Cidade**' is a large real estate urbanization project, developed by the private sector Odebrecht Real Estate Developments (OR), with other partner companies, which aims to be an urban landmark for the city of São Paulo and the most sustainable neighborhood in Latin America, after its completion in 2022.

The development consists of a multipurpose complex with over 600.000m² of built area, including: five corporate towers, a tower with commercial offices, a hotel, a mall (shopping center), two residential towers and leisure facilities, living and entertainment spaces as cafes, restaurants and public squares. The project has as main axis a large linear park of 62.000 m² with 22.000 m² of green area, open to the public and provided with services and leisure infrastructure. To ensure that the compact city and circular metabolism concepts will be addressed in this project, the enterprise is seeking various types of environmental certifications, among them the LEED for Neighborhood Development and the Climate Development Program, launched in 2009 in partnership with the C40, the Clinton Climate Initiative and the U.S. Green Building Council, in order to highlight urban projects that seek to achieve positive levels of carbon emissions worldwide.

If on one hand the LEED ND Certification promotes the construction of more sustainable, connected communities and with less pollution; on the other it does not guarantee the emissions quantification of activities occurring inside the city, even though they are activities that promote low carbon emissions. Thereby, cities GHG emissions **assessments by GHG inventories' become an essential principle of assessment and early establishment of** guidelines and suggestions for the solution of several issues related to public policies and investments.

However, until recently, there was no global implementation methodology that provided consistent guidelines for **conducting GHG emissions inventories' at cities' level. So far, cities have used several methods based on national, local or even their own creation references.** Nevertheless, since 2012, due to a joint effort between ICLEI organizations, WRI and C40 (including a global collaboration of various stakeholders), was created a comprehensive new option for the measurement and reporting of greenhouse gases applied to cities called GPC Protocol (Global Protocol for Community-Scale Greenhouse Gas Emissions).

The GPC specifies the principles and rules for the creation of a GHG inventory report for a city; although, it does not specify the calculation methodology to be used to generate emission data. Based on this scenario, the GHG Protocol Brazil tool allows the calculations more quickly and consistently, because it has the data of the activities and secondary values already adapted to the Brazilian reality. Worldwide, it is currently the most commonly used method by companies and governments to conduct GHG inventories and is compatible with the ISO 14064 standard and the quantification methods of the Intergovernmental Panel on Climate Change (IPCC).

3.1. Applying the methodology in the case study

The first step to calculate the GHG emissions of a city or neighborhood is the definition of project's basic items assisted for a GHG inventory, such as the Project Boundary (identification of the geographical area of the city or neighborhood); setting the Period; the Greenhouse Gases that will be calculated and reported; and the Emission Sources (activities inside the project's boundary that emit greenhouse gases).

A unique item of this work consists **on the boundary's definition using the scale of a neighborhood and not a city, where it is commonly applied. Another unique item of this work is the time chosen for emissions' evaluation. Traditionally, GHG cities' inventories are carried out after completion** of the calendar year, accounting for emissions that have already happened last year. As this neighborhood has not yet been finished, all future emissions will be calculated for the year of its completion: 2022. The emissions were also calculated for the year 2030, not only to create a comparative basis between the projected emissions of past and future years, but also to allow comparison **with other cities' inventories.**

For this work it was considered the quantification of all greenhouse gases, but only presented the carbon dioxide (CO₂), considered the most relevant and important gas in terms of urban emissions. Still, the sectors and subsectors that have been chosen from the case study to evaluate the sources of emissions were due to its great importance within the context of the neighborhood and the city, as well as its applicability and ease existing data collection for each sector, which are: Stationary Energy, Ground Transportation and Solid Waste.

In general, for almost all sources, cities will need to estimate its emissions by multiplying the 'given activity' generated by an 'emission factor' associated with the activity being measured.

The application of the method in the case study consists on basically to collect existing data of the case study, develop premises of future projections related with the activities that will be evaluated (transport, energy and waste management), based on existing historical data. After the projections are settled, the emissions are calculated for future years, using **the emissions' factor for each activity. Then, the indicators with the results are listed and compared with available data from other cities' inventory. The results should be appropriate for comparison within** each other, allowing adaptations of other inventories to meet the ranges defined by the case study.

4. CONCLUSION

Total emissions' projection in the 'Parque da Cidade' in 2022 corresponds to 650.900,12 tCO₂e; and in 2030 corresponds to 596.189 tCO₂. There has been a reduction of general emissions over the years, and it can be concluded that this is due to the reduction of incentives regarding the use of individual transportation in the neighborhood, from the sector that emits most CO₂: the Ground Transportation, which for being the most significant, can influence largely the total reduction of emissions in a neighborhood, and a city.

To carry out a comparative model between the selected cities (São Paulo and Recife), it was necessary to calculate the total per capita emissions in each of the examples, taking into account the comparative base scenario of a city with an isolated and measured individually neighborhood.

	Population	Stationary Energy (tCO ₂ e/hab)	Household Waste (tCO ₂ e/hab)	Ground Transportation (tCO ₂ e/hab)	TOTAL Emissions per hab. (tCO ₂ /hab)
Parque da Cidade 2022	56.030	0,11	0,037	11,46	11,61
Parque da Cidade 2030	65.000	0,16	0,035	8,97	9,17
São Paulo 2022	12.367.932	0,40	0,038	0,84	1,25
São Paulo 2030	13.171.543	0,49	0,038	1,05	1,58
Recife 2022	1.687.971	0,13	0,042	1,21	1,38
Recife 2030	1.796.222	0,17	0,042	1,74	1,95

Table 1: Final comparison of GHG emissions from the 'Parque da Cidade', the city of São Paulo and the city of Recife

While the 'Parque da Cidade' emits relatively more carbon per capita than the two other cities, basically due to the high emission value of the transport sector, it is the only example presented that reduces their emissions over time to the Waste Sector, Transportation Sector and Total emissions per capita. The high value of per capita's emissions in the transport sector is due to the fact that the neighborhood has only two residential buildings and ten other commercial buildings, not really promoting mixed-use compact cores.

Regarding the energy consumption of residential and commercial buildings in the case study, the lowest consumption is observed in comparison to other cities, foreseeing to emit 27.5% less energy than the average of São Paulo city in 2022, and up to 32.7% less energy than the average of São Paulo city in 2030. The emissions from the transport sector will be reduced by around 21% over eight years (between 2022 and 2030).

How sustainability occurs only in long term and the policies that promote behavior change and vision within a city must be observed and monitored over time, presently, the studied neighborhood presents an enormous potential for urban and environmental sustainability, mainly promoted by the desired environmental certification criteria. The emissions reduction in long-term still favors the alignment of existing public policies, such as national policies on Climate Change, and international policies as the Conference of the Parties, within a macro economic and urban perspective.

In this scenario it is possible to assess that the key to the reduction of GHG emissions from large urban centers is reducing the use of private cars for commuting, clearly shown to be the greatest emissions inducer. Another major problem arises when countries like China and India begin to develop in the same way that the modern era has developed: depending on the automobile. India currently has the largest road complex in the world, 5.800 kilometers of highways connecting its four largest cities, the Golden Quadrilateral, while launching a very cheap car and accessible to the majority of its population. China invests heavily in huge, generic and aseptic housing estates on the outskirts of their megacities to meet the immigrant population (model failed in the West and widely publicized since the reconstruction of Europe after the war). Obviously, none of the models adequately respond to the needs of a more harmonious planet.

If these super populous countries and others under development countries, including Brazil, continue with the same car cult culture and urban sprawl, investing heavily in public policies that promote their use, our little planet will not be enough to support the high demand for emissions pollutants and greenhouse gases to be released into the atmosphere in the coming years. The biggest concern at this point is to understand how developing countries can align their development policies with its GHG emissions and the role of developed countries in this context.

REFERENCES

- [1] GLAESER, EDWARD, 2010. Os Centros Urbanos: A Maior Invenção da Humanidade. Rio de Janeiro, Rio de Janeiro.
- [2] Global Protocol for Community-Scale Greenhouse Gas Emission Inventories. World Resources Institute, 2014. Retrieved from: http://ghgprotocol.org/files/ghgp/GHGP_GPC.pdf [Retrieved on: 07 July 2016].
- [3] HAWKEN, PAUL, 2010. The Ecology Of Commerce: A Declaration Of Sustainability. Sausalito, California.
- [4] IPCC 2006, 2006 IPCC Guidelines for National Greenhouse Gas Inventories, Prepared by the National Greenhouse Gas Inventories Programme, Eggleston H.S., Buendia L., Miwa K., Ngara T. and Tanabe K. (eds). Published: IGES, Japan.
- [5] JACOBS, JANE, 2011. Morte e Vida de Grandes Cidades. São Paulo, São Paulo.
- [6] ONU HABITAT and ICLEI. Urban LEDS. Retrieved from: <http://sams.iclei.org/o-que-fazemos/promovemos-a-acao-local/projetos-em-andamento/urban-leds.html> [Retrieved on: 04 July 2016]
- [7] UNITED NATIONS. Framework Convention on Climate Change. Retrieved on: http://unfccc.int/ghg_data/items/4133.php [Retrieved on: 09 July 2016]

A Stakeholder-Based Assessment Model (SAM) For Resource-Efficiency Measures in the Construction Industry

Richard Carl MÜLLER^a, Olga SCHAMBER^b, Rebekka VOLK^c, Frank SCHULTMANN^d

^a Karlsruhe Institute of Technology (KIT), Germany, richard.mueller@kit.edu

^a Institute for Industrial Production (IIP), Germany, richard.mueller@kit.edu

^b Karlsruhe Institute of Technology (KIT), Germany, olga.schamber@gmx.d

^b Institute for Industrial Production (IIP), Germany, olga.schamber@gmx.de

^c Karlsruhe Institute of Technology (KIT), Germany, rebekka.volk@kit.edu

^c Institute for Industrial Production (IIP), Germany, rebekka.volk@kit.edu

^d Karlsruhe Institute of Technology (KIT), Germany, frank.schultmann@kit.edu

^d Institute for Industrial Production (IIP), Germany, frank.schultmann@kit.edu

ABSTRACT

In recent decades, the shortage of natural resources like primary raw materials has increasingly shifted into the focus of public discussion and research. Especially in the resource-intensive construction sector the implementation of a circular economy can strongly contribute to a reduction of primary resource demand. Positive developments can be noticed already, but the desired goal of an effective circular economy is still not being reached. For instance, the usage of recycled raw materials as substitutes for primary resources could be significantly higher.

In order to implement the protection of resources in the construction sector, it is essential to assess **resource-saving measures and their impact on conservations as well as stakeholder's motivation to implement them**. For this purpose, a Stakeholder-based Assessment Model (SAM) is developed to provide recommendations for political actions and potent measures to foster the circular economy in the construction sector to increase reuse and recycling of construction materials. In SAM, relevant stakeholders are identified and their characteristics and preferences as well as the level of influence on each other are modelled and validated for Germany. Moreover, available resource-conserving measures concerning the construction sector are identified and related measures are grouped together. Thereupon the influence of measures on stakeholders and their willingness to take positive actions in terms of a circular economy have been investigated and modelled. Relevant model data has been gathered by intensive literature review, surveys and expert interviews.

The results show that measures regarding lifecycle oriented planning of buildings as well as the development of stakeholder cooperation are the most effective ones to save resources and to reduce the disposal of construction material. Furthermore, the results demonstrate that a leading role of public authorities is crucial to foster a circular economy.

Keywords: waste management, resource-efficiency measures, stakeholder-based assessment model

1. INTRODUCTION

In recent decades, the shortage of natural resources like primary raw materials has increasingly shifted into the focus of public discussion and research. Especially in the resource-intensive construction sector the implementation of a circular economy can strongly contribute to a reduction of primary resource demand. Positive developments can be noticed already, for example the quality assurance system for recycled construction materials in Germany, but the desired goal of an effective circular economy is still not being reached. For instance, the usage of recycled raw materials as substitutes for primary resources in building construction could be significantly higher.

In order to implement the protection of resources in the construction sector, it is essential to assess **resource-saving measures and their impact on conservations as well as stakeholders' motivation to implement them**. For this purpose, a Stakeholder-based Assessment Model (SAM) is developed to provide recommendations for political actions and potent measures to foster a circular economy in the construction sector that lead to increased reuse and recycling of construction materials.

2. SCOPE AND RESEARCH APPROACH

As resource usage is still quite high in the construction sector, this contribution poses the research question of how relevant stakeholders can be incentivized to reduce their resource consumption or increase the share of recyclables and recycling materials in their current practice? In order to achieve a rethinking on **stakeholders'** parts and to implement efficient resource usage and resource protection as an integral element of every construction, also certain aspects have to be considered by authorities: Who are the key stakeholders? What is their role in achieving that goal? What are the most effective measures to incentivize the relevant stakeholders? This holistic view on a problem is suggested by the systems approach by Arbnor and Bjerke. Therefore, the developed model has to consider not only the effects of measures on the environment but also on the entire stakeholder network. That means that the effects of internal objectives of stakeholders, their ability to influence resource protection and their influence on each other are also relevant factors in the system.

Therefore, in the following subsections current literature is reviewed regarding their ability to derive political measures and incentives for stakeholders based on analysis and simulation of stakeholder objectives, of economic effects on stakeholders and stakeholder interactions (See section 3). To answer the research question, a model (SAM) is developed in section 4 to evaluate resource-saving or resource protection measures (Political instruments) with regard to the addressed stakeholders and the related stakeholder interactions. For this purpose, several political instruments are evaluated not only by their economic effects but also by their ecological impact. **Furthermore, the stakeholders' willingness to act according** to the political measure is considered. To compare political measures with each other and to provide decision support for the respective authorities an effectivity value is calculated and recommendations are proposed. Then, the application of SAM in the German construction industry is described in section 5 and model results are shown and analysed. This is followed by a conclusion and an outlook on future re-search.

3. STAKEHOLDER ANALYSIS AND LITERATURE DISCUSSION

The enormous relevance of stakeholder management in the construction industry results from the higher number of stakeholders involved in building projects. Stakeholders follow different objectives and have different **motivations. According to Kua, the stakeholders' willingness for pro-environmental behaviour** is influenced by willingness conditioning factors such as incentives (given by policy measures or other stakeholders), responsibility and capability influence. The comprehension and consideration of their interests, needs and effects on a project can determine the success of a project. In order to comprehend outcomes of a system, also interdependences and influences within a system are of importance. Stakeholders are highly important as they might have essential information and expertise that are necessary for a project to succeed. Involving those and ensuring their support can help to avoid conflicts and failures. Summing up, stakeholder management helps to understand how applied measures and current situations are perceived and what it means for the project or initiative. There are several definitions for the term stakeholder. According to Mitchell et al., stakeholders are not only a moral, personal or **financial interest group of a project or a company because they are affected by project's success** or effects, but also those have to spend for instance resources in order to obtain those profits. Moreover, there can be stakeholders without any entitlement to any part of the success and are not affected in any way by its actions but who can still influence other stakeholders. For the purposes of this paper, the focus lies on the definition of Mitchell et. al.

The consideration of stakeholders in a model poses the challenge of quantifying mostly qualitative measures. Some already developed tools might be supportive for quantification and are described in the following. Johnson et al. have concluded that it is not sufficient to understand the needs and positions of stakeholders. Also, the ability and power to enforce their interests has to be considered. At the same time interest can reflect the strength of their desire to enforce their position in a project. Bourne and Walker suggest a stakeholder circle to visualize **stakeholders' power and influence within a project. However, in order to wholly understand stakeholder decisions**, it is important to consider their interest. Bourne and Walker go one step further by arguing that in addition the effects of interests have also to be considered. Therefore, they use the stakeholder Vested interest Intensity Index (VIII) to measure power.

$$ViII = \sqrt{\frac{v * i}{25}}$$

where, v = strength of personal interest in the project of a stakeholder, i = influence of a stakeholder and 25 = 5x5 (Both variables can be valued between 1-5)

Equation 1

Olander combines Bourne and Walker's idea of the Vill with the power legitimacy urgency model by Mitchell et al. The latter claims that one should differentiate between stakeholders who have influence, independently of the legitimacy of their claims, and those stakeholders, who might have claims, whether justified or not, but who are, at the same time, without any power. Using both models as a basis, Olander suggests, that instead of measuring the power, it is better to measure its effects. He uses the position of stakeholders (Pos) according to McElroy and Mills and also the attributes (A) of the power-legitimacy-urgency-model by Mitchell et al. In addition, Olander applies the vested interest index in order to create a Stakeholder Impact Index (SII), which reflects what effects the stakeholder has on a company.

$$SII = ViII * A * Pos$$

where, A = Attributes and Pos = Position of Stakeholders

Equation 2

These methods provide valuable instruments for the measurement of stakeholder influence and are used in SAM (see section 4.3). At the same time, they pose a difficulty, as in construction there is no central company towards which the relation-ship can be analysed. For that reason, the analysis has to be extended to observe the whole network. It is not relevant in the analysed construction stakeholder net-work how a manager can interact with different stakeholders, but what the mutual interaction of stakeholders means for the set target. Knoeri et al. provides a structural agent analysis by an agent based modelling approach and applies it to the resource use in construction. However, in both approaches the relationship between the stakeholders and mutual influences are **hardly considered. Thus, based on current literature the observation of measures' effects on the network is not possible yet.** Therefore, in the following a stakeholder-based assessment model (SAM) is developed.

4. DEVELOPMENT OF A STAKEHOLDER-BASED ASSESSMENT MODEL (SAM)

The depicted model consists of two parts. First, the network defines the constants of the model (Section 4.1). On the one hand, those are the success functions which reflect what is important for the different stakeholders. On the other hand, those are the relationships/ interactions between the stakeholders. Second, the effects of measures on the environment are considered. Here, a new way will be introduced to integrate those effects into the stakeholder model by developing the SAM.

4.3 Definition of stakeholder's characteristics

Firstly, stakeholders have to be identified and categorized. Stakeholders' needs, interests and motivations have to be understood. In order to do it in a comparative way, an objective function has to be elaborated, which reflects their targets and reflects achievements thereof. Secondly, the relationships between stakeholders have to be made obvious. According to the reviewed literature, their influence on each other and their influence on the group result - resource conservation in this case - was modelled. Thirdly, the possible measures have to be identified as well as their effect on the goal. Lastly, those steps have to be brought together into a corresponding model that enables the joint analysis of all factors.

A stakeholder-network comprises a set of rational stakeholders $A = \{a_1..a_i..a_j..a_n\}$ and a set of possible measures $M = \{m_1...m_k\}$. The first step is to determine how the stakeholders can be defined. As for any economically deciding stakeholder, it is assumed, that his economic success is of a great value for him. Diederichs suggests to use the balanced score card in the construction industry to evaluate target achievements and success. That means that the aspired success is not only defined by financial results, but also through customer orientation, process excellence, customer relationship as well as education and growth. Diederichs also integrates the environmental

perspective into this evaluation of success. Finally, that results in the success function of a stakeholder Z_a (Equation 3). The weights of the success function are the basis for the following modelling approach in section 4.2.

$$Z_a = g_{fin_a} * fin_a + g_{cust_a} * cust_a + g_{process_a} * process_a + g_{dev_a} * dev_a + g_{env_a} * env_a$$

where, **fin** = financial success of stakeholder **a**, **cust** = customer satisfaction of stakeh. **a**, **process** = success of process design of stakeh. **a**, **dev** = development/ innovation success of stakeh. **a**, **env** = success of environmentally responsible behavior of stakeh. **a**, **g_{factor}** = weight of the variables and has to be defined for each stakeh. **a** (sum of all **g** = **1**)

Equation 3

4.4 Impact of measures on stakeholders

Measures, executed by either process or environmental stakeholders, have an effect of $w_{m, factor_a}$ on the factors of the stakeholder's success based on the values in the balanced score card. To determine the total impact of a measure on the stakeholder's success ($w_{m,a}$) the various effects are weighted using factors weightings.

$$w_{m,a} = g_{fin_a} * w_{m,fin_a} + g_{cust_a} * w_{m,cust_a} + g_{process_a} * w_{m,process_a} + g_{dev_a} * w_{m,dev_a} + g_{env_a} * w_{m,env_a}$$

where, $w_{m,a}$ = Impact of measure **m** on stakeholder **a**, w_{m,fin_a} = Imp. of meas. **m** on financial success of stakeh. **a**, $w_{m,cust_a}$ = Imp. of meas. **m** on customer satisfaction of stakeh. **a**, $w_{m,process_a}$ = Imp. of meas. **m** on process design of stakeh. **a**, w_{m,dev_a} = Imp. of meas. **m** on development/ innovation success of stakeh. **a**, w_{m,env_a} = Imp. of meas. **m** on environmentally responsible behaviour of stakeh. **a**.

Equation 4

Moreover, stakeholders can be influenced by measures with different intensities $s_{m,a}$. This value can be compared with the legitimacy value according to Mitchell et al. At the same time, it creates a certain urgency for their position and interest, which can motivate them to act and give more strength to their claims. Stakeholder's readiness to act or accept a measure is preliminary described as $B_{a,m}$. Interactions between the stakeholders are not yet included.

$$B_{a,m} = w_{m,a} * s_{m,a}$$

where, $B_{a,m}$ = Readiness to act or acceptance of stakeholder **a** while realizing measure **m**, $s_{m,a}$ = intensity-level for the impact of measure **m** on stakeholder **a**

Equation 5

4.5 Formulation of SAM

In a network, stakeholders decide dependently or independently from each other. Depending on the effects of measures on their own business, they influence other stakeholders to act in a certain way. This influence of stakeholder a_i on stakeholder a_j in dependence of measure **m** is quantified by $E_{a_i,a_j}(m)$

$$E_{a_i,a_j}(m) = w_{m,a} * s_{m,a} * e_{a_i,a_j}$$

where, $E_{a_i,a_j}(m)$ = Influence of stakeholder a_i on stakeholder a_j in dependence of measure **m**, e_{a_i,a_j} = General level of influence of stakeholder a_i on stakeholder a_j

Equation 6

The influence of other stakeholders on a stakeholder create an additional readiness to act which is caused for example by neighbourhood effects, voluntary commitments and market adaption, image or competitiveness reasons. Therefore, an additional (Dis)motivation for the stakeholder's readiness to act is considered (Equation 7) based on the average mutual stakeholder influence $E_{a_i, a_j}(m)$ and the general level of influence e_{a_i, a_j} of two stakeholders a_i and a_j .

$$Infl_a = \frac{\frac{1}{n} \sum_{i,j=1}^n (E_{a_i, a_j}(m))}{\frac{1}{n} \sum_{i,j=1}^n (e_{a_i, a_j})}$$

where, $Infl_a$ = Additional readiness to act/ acceptance of stakeholder a , n = total number of stakeholders

Equation 7

Since the optimization of success (formulated by their respective objective) is the foremost goal of any stakeholder, it has to be considered, that the success factors affect the readiness to act stronger then the influence $Infl$ does. Accordingly, $B_{a,m}$ is expanded to:

$$B_{a,m} = \frac{Infl_a + 2 w_{m,a} * s_m}{3}$$

where, $B_{a,m}$ = Readiness to act or acceptance of stakeholder a while realizing measure m , $Infl_a$ = Additional readiness to act/ acceptance of stakeholder a

Equation 8

The magnitude of a possible effect of the measure on conservations of resources is named l_{m_k} . In a general case, when all data is available, l_{m_k} includes economical, ecological and social aspects of sustainability.

The effectivity of a measure is defined as the impact of a measure on the protection of resources. The effectivity of a measure $Eff(m_k)$ depends on the influence of each stakeholder on resource conservation and on the strength of stakeholders' readiness to act. Referring to the introduced structure of *VIII* (Equation 1), the effectivity of a measure consists of the effect of a measure on environment (effect of the interest $l_{m_k} * r_{a_i}$), and the readiness to act (Interest B_{a_i, m_k}). By averaging those values, a joint effectivity is calculated by:

$$Eff(m_k) = \frac{1}{n} \sum_{i=1}^n \sqrt[3]{\frac{(l_{m_k} * r_{a_i}) * B_{a_i, m_k}}{250}}$$

where, $Eff(m_k)$ = Effectivity of the measure m_k , l_{m_k} = Impact of the measure m_k on the conservation of resources, r_{a_i} = Influence of stakeholder a_i on the conservation of resources, B_{a_i, m_k} = Readiness to act or acceptance of stakeholder a_i while realizing measure m_k

Equation 9

5. APPLICATION OF THE MODEL AND RESULTS

In this section, SAM is applied to the construction industry. Therefore, various current and future resource-saving measures in the construction industry have been analysed and grouped together to sets of measures. In total, 21 sets of measures have been created (see Figure1). Based on surveys and expert interviews with identified stakeholders and detailed literature research, the parameter values for the model were acquired. For this purpose, nine stakeholders of different stakeholder types (builders, department of the environment, architects, constructions engineers and demolition and recycling companies) were interviewed with a survey. The influence of resource saving measures on stakeholders have been evaluated with points in the range of [-2;2]. The influences between different stakeholders have been evaluated with points in range of [1;5]. In general, all sets of measures in the right upper right quadrant of Figure 1 should be preferred as they contribute the most to a conservation of resources and show a high effectivity as well as a high readiness to act. Sets of measures with the highest effectivity are such as set 12 (need to develop cooperation's between the stakeholders), set 18 (necessary improvement of the

image of recycling construction materials), set 6 (stronger awareness of resource efficient construction) and set 2 (reducing barriers for resource-efficient behaviour).

The sets of measures 8, 12, 15, and 18 in the upper right quadrant have the highest readiness to act/ acceptance. With set 8 (need of stronger investments for resource efficient research) and set 15 (importance of a high quality in construction to extend the life cycle of buildings).

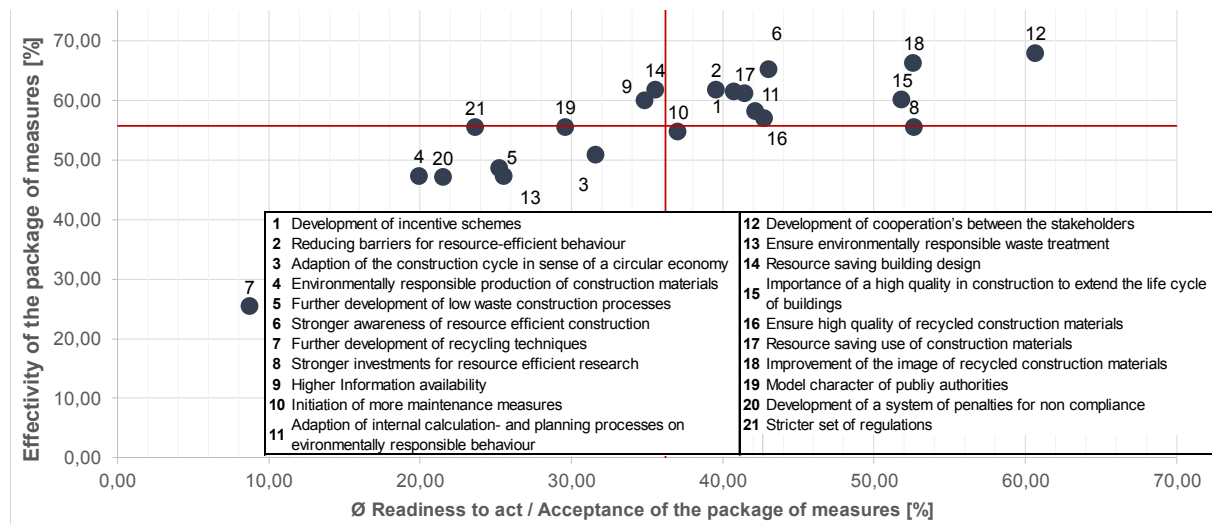

Figure 1: Effectivity $Eff(m_k)$ of the sets of measures and stakeholder's readiness to act/ acceptance of the measure

Furthermore, based on literature research, survey and interviews it became obvious that the public sector has the highest influence on other stakeholders in the construction sector with respect to their resource-saving decision making. Specifically, it became clear that the public sector must take the leading role, whether in the form of incentives, or the removal of barriers. In particular, the leading role of the public sector in its own resource-saving actions is of central importance, e.g. by explicit preference for RC materials in public construction tenders.

6. SUMMARY AND DISCUSSION

In this contribution, a stakeholder-based assessment model is developed to evaluate the effect of political resource-saving or resource-supporting measures and to provide decision support to public authorities. The model is applied for a stakeholder network in the construction industry in Germany. Main results are that additional cooperation between stakeholders could be beneficial, the image of recycling materials has to be improved and barriers for resource-saving construction (materials) should be reduced. Furthermore, the public sector has a leading role with respect to the usage of recycling materials. To further improve the model results, interviews and surveys will be performed in the construction sector to detail the modelled stakeholders. Furthermore, the ecological effect of a resource-saving set of measures or single measures have to be related to resulting mass flows to better evaluate the impact on the environment. And, the consideration of interdependence of the measures themselves (a measure might be more successful, if another measure has been adopted) and the integration of rebound effects could be promising in future research.

REFERENCES

- [1] Arbnor, I. and Bjerke, B. (2009), Methodology for creating business knowledge, 3rd ed., Sage, Los Angeles, London.
- [2] Atkinson, G. (2008), "Sustainability, the capital approach and the built environment", Building Research & Information, Vol. 36 No. 3, pp. 241–247.
- [3] Binder, C.R. (2007), "From material flow analysis to material flow management. Part II: The role of structural agent analysis", Journal of Cleaner Production, Vol. 15 No. 17, pp. 1605–1617.
- [4] Bourne, L. (2010), Stakeholder relationship management: Using the Stakeholder Circle methodology for more effective stakeholder engagement of senior management.
- [5] Bourne, L. and Walker, D.H. (2005), "Visualizing and mapping stakeholder influence", Management decision, Vol. 43 No. 5, pp. 649–660.

- [6] Cleland, D.I. (1995), "Leadership and the project-management body of knowledge", International Journal of Project Management, Vol. 13 No. 2, pp. 83–88.
- [7] Diederichs, C.J. (2012), "Bauwirtschaft und Baubetrieb", in Zilch, K., Diederichs, C.J., Katzenbach, R. and Beckmann, K.J. (Eds.), Handbuch für Bauingenieure: Technik, Organisation und Wirtschaftlichkeit, 2., aktualisierte Auflage, Springer, Berlin, Heidelberg, pp. 379–965.
- [8] Freeman, R.E. (2010), Strategic management: A stakeholder approach, 2nd ed., Cambridge Univ. Press, Cambridge.
- [9] Harding, R. (1998), Environmental decision-making: The roles of scientists, engineers, and the public, Federation Press.
- [10] Johnson, G., Scholes, K. and Whittington, R. (2006), Exploring corporate strategy, 7th ed., Financial Times Prentice Hall, Harlow u.a.
- [11] Kaplan, R.S. and Norton, D.P. (1992), "The balanced scorecard - Measures that drive performance", Harvard Business Review, No. 92105.
- [12] Knoeri, C., Binder, C.R. and Althaus, H.-J. (2011), "An agent operationalization Approach for Context Specific Agent-Based Modelling", Journal of Artificial Societies and Social Simulation, Vol. 14.
- [13] Kua (2016), "A New Integrated Framework for Stakeholder Involvement in Sustainability Policymaking—A Multidisciplinary Approach", Sustainable Development, 24, 5 281-297.
- [14] McElroy, B. and Mills, C. (2003), "Managing stakeholders", in Turner, J.R. (Ed.), People in project management, Gower, Aldershot, pp. 757–775.
- [15] Mitchell, R.K., Agle, B.R. and Wood, D.J. (1997), "Toward a Theory of Stakeholder Identification and Salience: Defining the Principle of Who and What Really Counts", Academy of Management Review, Vol. 22 No. 4, pp. 853–886.
- [16] Olander, S. (2006), External stakeholder analysis in construction project management, Construction management publications, Lund University, Lund.
- [17] Olander, S. (2007), "Stakeholder impact analysis in construction project management", Construction Management and Economics, Vol. 25 No. 3, pp. 277–287.
- [18] Olander, S. and Landin, A. (2005), "Evaluation of stakeholder influence in the implementation of construction projects", International Journal of Project Management, Vol. 23 No. 4, pp. 321–328.
- [19] Semaan, N. and Sarkis, S. (2015), "Stakeholder impacted cost contingency model (SICC)", International Journal of Science, Environment and Technology, Vol. 4 No. 3, pp. 690–700.
- [20] Yang, J., Shen, G.Q., Ho, M., Drew, D.S. and Xue, X. (2011), "Stakeholder management in

Comparative Rich-Picture-Diagram for Assessment of Building Sustainability Labels

Sasha Nikolaus CISAR^a, Guillaume HABERT^b

^a Chair of Sustainable Construction, ETH Zürich, Switzerland, cisar@ibi.baug.ethz.ch

^b Chair of Sustainable Construction, ETH Zürich, Switzerland, habert@ibi.baug.ethz.ch

ABSTRACT

This paper's goal is a framework for a comparative depiction of sustainability labels for buildings and other scales. Applying the method of a Comparative Rich-Picture-Diagram (cRPD) allows a multi-scalar and multi-objective analyse of building standards and labels for sustainable construction. This paper presents a two-step part of the method to display the structure of the label, weighting of indicators and translation into a multi-dimensional feature space. It entails the visualisation of the dimensions or pillars of sustainability (society, economy, environment), space (components, integrated systems or building, neighbourhood) and time (phases). The method is exemplified with the Standard Sustainable Construction Switzerland (SNBS) to display and evaluate the functioning of the label. The paper concludes the weighting of indicators show a diverging picture and thus allows to identify hidden drivers and barriers for sustainable construction.

Keywords: policy and regulation, sustainability labels, sustainable construction

1. INTRODUCTION

The aim of this paper is to present a theoretical framework for analysis and comparison of sustainability building labels applying the method Comparative Rich-Picture-Diagram (cRPD). Typically these labels, certifications or tools assess the environmental impact and overall sustainability and are sometimes referred to Green Buildings. Due to the complexity of the subject, the authors utilise the term labels to enable a comparison of on the scale of both buildings and neighbourhoods.

The UNEP (2011) states **the development of the 20th Century poses a “significant progress of civilisation”, which was accompanied by an enormous demand of resources including for the construction sector.** The environmental impact of said economic activity has left its marks. The IPCC (2013) showed the impact of anthropogenic CO₂-emissions as a main driver of Climate Change. Resource scarcity and Climate Change are accordingly two of the major societal challenges according to both UNEP and IPCC. They identify the construction sector and the increased construction activity as a main driver of the environmental impact. According to UNEP the above progress is accompanied by an unprecedented and ongoing urbanisation. To cope with the development of the increased construction activity results extensive demand of construction materials. The Global Alliance for Buildings and Construction (2016) concludes that **“the global building sector consumed (...) over 30% of total final energy consumption”, “buildings also accounted for half of the global electricity demand” and “the building sector therefore represents roughly 20% of global-related CO₂ emissions”.** Considering indirect and direct emissions **“buildings and construction represent nearly 40% of energy-related CO₂ emissions.**

To tackle the responsibility of the building sector towards the environmental degradation Herazo et al. (2015) and Perez-Lombard et al. (2009) describe the emergence of Green Building labels from 1990's onwards which introduced an assessment of green or environmental performance of buildings. Two recognized examples include **the Building Research Establishment's Environmental Assessment Method (BREEAM) from the UK and the Leadership in Energy and Environmental Design (LEED) from the U.S.A.** Although a second generation of building labels move towards a more holistic approach concluding societal, economic and life-cycle aspects according to Markelj et al. (2013) and Herazo et al. (2015), LEED remains the most popular certification for buildings.

In Switzerland building labels have developed also according to the societal challenges. Similarly, to first generation labels, only covering energy aspects, then including environmental and then second generation aiming for more holistic approaches. The Minergie-Label exemplifies this development. The initial focus was on the criteria of energy efficiency. Later criteria comfort, indoor air quality, material availability and embodied energy were included for the further development into Minergie-Eco. Further consideration of the criteria thermal comfort and energy consumption in the use phase lead to the development of Minergie-P. To conclude the Minergie-A

implemented a holistic approach towards assessing and labelling sustainability for buildings. A different example in Switzerland is the 2000-Watt-1t-CO₂-society that combines the criteria life-cycle, use and mobility towards a normative goal of sustainability. Aside of assessing buildings it includes a label for districts. Furthermore, the Swiss government responded to the challenges with introducing the Energy-Strategy 2050 to increase energy efficiency and later a Strategy for Sustainable Development. Sustainability and sustainable development is cited in the constitution to seeks a „balanced relationship between nature, its capacity for renewal and supply for human demand“, the implementation of said strategies is aimed for at federal and state levels. The Swiss Network Sustainable Construction (NNBS) initiated by the Swiss Federal Office of Energy explicitly builds upon the federal Strategy of Sustainable Development. The strategy identifies construction as a key component for the scale of buildings and sustainable neighbourhood and district development. The three pillars of sustainability, society, environment and economy should find application and certification in sustainable construction through the newly founded “Standard Sustainable Construction Switzerland (SNBS)”. This building label integrates the existing Minergie labels in Switzerland, attempting to “close existing gaps and thus connect the three pillars of sustainability through a number of different criteria”. Consequently this paper focuses on SNBS to exemplify and visualise the suggested cPRDframework.

1.1 Are building standards and labels expedient?

The societal challenges pose clear demands for sustainable construction and thus exists a need for building standards and label. However, are the so called “eco-label” or “green building label” really “green”? Or put differently, are the building standards and labels expedient for sustainable construction? The efficiency of the building standards and labels is unclear considering the goals of sustainable construction. The federal office for energy (BFE) conducted a study on the success monitoring of the label “Minergie” and showed that “planned values are only in part congruent with energy consumption values in use phase”. This leads to the question how building standards and labels function.

1.2 Functioning and structure of building standards and labels

Building standards and labels are typically difficult to understand and complex structured. In literature different studies on building standards and labels focus solely on comparing the qualitative difference regarding the structure and aim. Sutrisna et al. (2007) have applied the “Rich Picture Diagram (RPD)” to model and visualise the complex interactions and procedures between different stakeholders in construction processes. This paper expands their approach to building standards and label that match the complexity of the statement of a problem to construction projects. It should facilitate the application of building standards, the communication thereof and reveal hidden drivers and potential barriers.

In literature only few studies suggest a common framework on the comparison of building standards and labels. This paper builds on the work of Wallhagen et al. (2012) who propose a generic framework with an underlying graphic method to display the hierarchical structure of building standards and labels.

2. APPROACH

2.1 Focus on SNBS

The approach of the proposed framework of a “comparative rich-picture for sustainability label and building standards” is introduced and exemplified in this paper with SNBS. The NNBS promotes the SNBS and establish as building standard. The SNBS states to equally weigh the three pillars of sustainability. The structure of SNBS is the following: The three pillars of sustainability are represented as the three “themes” society, economy and environment. The themes are divided into different categories, which contain each a number of criteria and finally indicators. During writing of this paper SNBS version 1.5 (office) was considered that contains 3 themes, 12 categories, 25 criteria and 76 indicators. On 24 August 2016 the SNBS version 2.0 was introduced that drastically reduced the amount of indicators and thus was also considered as a way to communicate the differences. SNBS 2.0 contains 3 themes, 12 categories, 24 criteria and 45 indicators.

2.2 Comparative rich picture diagram

This paper applies the RPD suggested by Sutrisna et al. to display building standards and label similarly to construction projects. The modelling and display of the hierarchical structure of building standards is applied from Wallhagen et al.. A further steps extends the analytical modelling expanded to a multi-dimensional feature-space which should enable to reveal the hidden drivers and potential barriers in building standards and labels. Therefore, it allows a comparative analysis of different labels revealing the structure and function. The approach of the adapted comparative Rich-Picture Diagram (cRPD) framework is divided in to several iterative steps: Structural display, weighting, translation into the feature-space.

The structure the themes, categories, criteria and indicators of the SNBS are summarised and displayed. The individual components build on each other and are brought together in the three themes of sustainability. The assessment of the SNSB calculates the weighting of indicators. The SNBS is equally divided into three themes. These are then divided by the amount of categories, criteria and indicators. This reveals the resulting weighting of individual indicators and their percentage on the entire building standard. The last step translates the individual components of the building standard into a three-dimensional feature-space. The three considered dimensions or features are sustainability, space and time. The sustainability feature has three magnitudes society, economy and environment. The magnitudes of the spatial feature has the magnitudes building components, integrated systems or buildings and neighbourhood. The temporal feature has the magnitudes of phases from planning, construction and use.

3. RESULTS

3.1 Weighing of Indicators

The results of the first two steps, structure and weighting of SNBS, show that the three themes society, economy and environment are equally weighted (Figure 1). The 3 themes are equally divided into 4 categories. The 25 criteria however are not equally distributed to the four categories. Furthermore, the 76 indicators are also unequally distributed to the 25 criteria. The initial 100%, which are divided equally at 33% to the three themes result in a range of 0.24% - 8.33% for individual indicators.

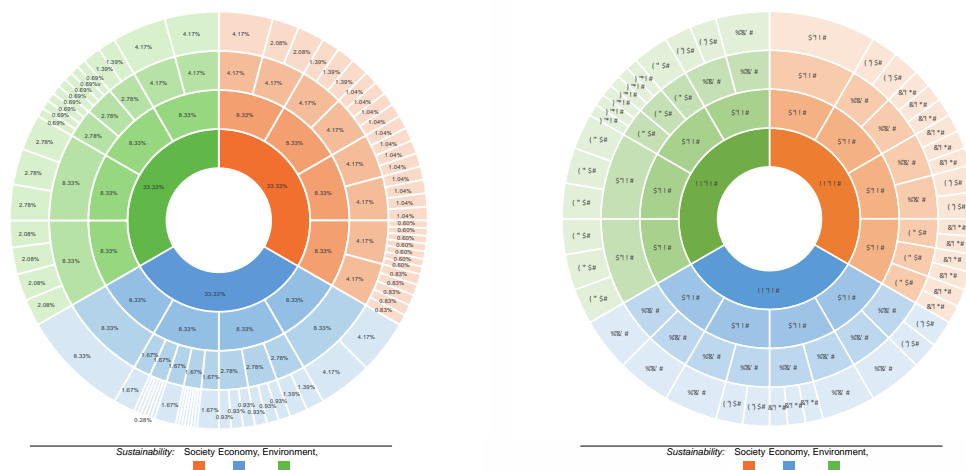

Figure 1: Structure of the label SNBS – Standard Sustainable Construction Switzerland. The innermost circle represents the themes (society = orange, economy = blue, environment = green) respectively the pillars of sustainability, then the categories and outside the indicators. The next circle are the categories, followed by the amount of criteria which are unequally distributed. The outermost circle are the indicators and their weighting in percentage. Left SNBS 1.5 with 76 indicators and right SNBS 2.0 with 45 indicators.

The indicators can be ranked according to their percentage. It displays which indicators have the largest influence on the assessment (Figure 2). The initial distribution on the themes society, economy and environment shift their relevance. The indicators of the theme economy receive the most weight with the largest weighted indicators. The theme economy is then followed by environment. The theme society falls to the third place with the most indicators weighted the smallest.

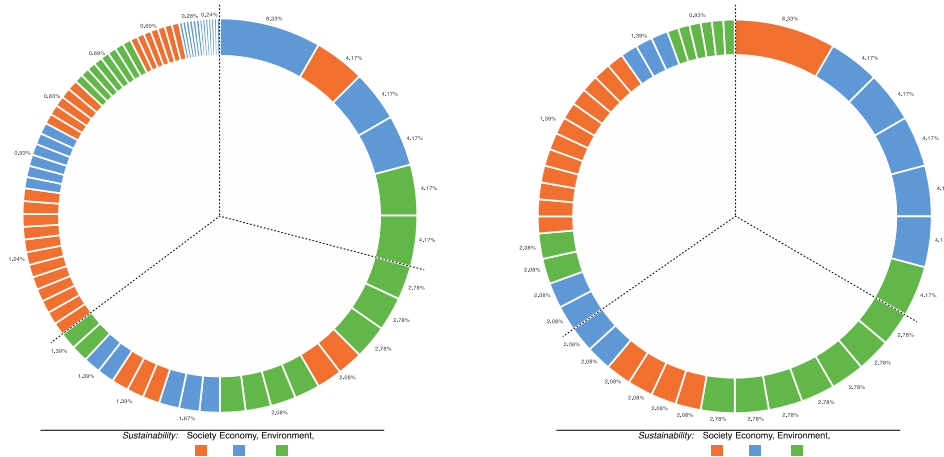

Figure 2: Structure of the label SNBS – Standard Sustainable Construction Switzerland displays the ranked indicators (society = orange, economy = blue, environment = green). Left SNBS 1.5, right SNBS 2.0. The indicators were ranked according to their percentage. The five most important indicators for SNBS 1.5 are the regional economic potential (8.33%), urban and architectural themes, life-cycle costs, total costs, use concept, flora and fauna (each 4.17%). The five most important indicators for SNBS 2.0 are the aims and functional description (8.33%), building materials and building substance, decision making, rent and retail price, demand and available uses (each 4.17%).

3.2 Positioning of indicators in a three-dimensional feature-space

The indicators are translated to their respective dimensions in to a three-dimensional feature-space. The result shows (Figure 3) that the themes society, economy and environment differ and are located in different dimensions or features.

The theme society is the first of the feature sustainability. The largest percentage of indicators of the theme society is located in the feature time during the phase of planning and during the feature space on the scale of the building. We could interpret that the societal focus of the indicators is on the user perspective.

The theme economy is the second magnitude of the feature sustainability. The largest percentage of indicators of the theme economy is located in the feature time during the phase of planning and in the feature space on the scale of the neighbourhood – meaning on a higher level. We could interpret that the economical focus displays the investor perspective.

The theme environment is the third magnitude of the feature sustainability. The largest percentage of indicators of the theme environment is located in the feature time during the phase of use and in the feature space divided between the scale of the neighbourhood and components. We could interpret that the environmental focus displays the embodied energy of construction materials.

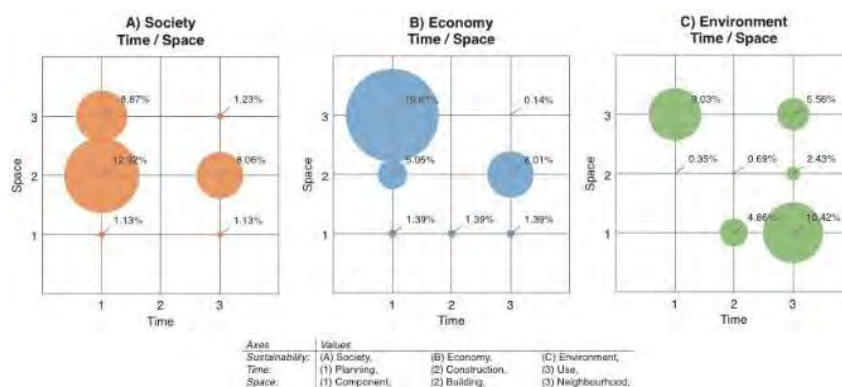

Figure 3: Translation of the indicators into the three-dimensional feature-space. Represented here are the temporal and spatial features regarding the magnitudes of sustainability (society, economy and environment). The size of the circle indicates the amount of indicators at each node.

This displays the focus of individual and potentially conflicting themes of sustainability. Furthermore, it reveals possible gaps and missing indicators. The theme society shows a balance between the planning and use phase.

Accordingly, user and comfort are important indicators. At the same time there is no indicator that covers the construction phase. The theme economy reveals that the focus of a higher level can be attributed to the investor and developer rather than the user of a building. The theme environment shows the opposite where the use phase is the main focus, which means which construction materials are planned and how they are implemented.

4. CONCLUSION

The aim of this paper is to present a cRPD framework that enables better understanding of function and comparison of building sustainability.

This is exemplified by the application of the framework on SNBS to display the label's function and weighting of individual indicators. The results show that the intended equality of the sustainability dimensions in SNBS collide with the unequal weighting of individual indicators. This allows the identification of hidden drivers which for SNBS results in a ranking of the sustainability dimensions according to importance, first economy, second environment and third society. Related to the sustainability dimensions, the feature-space displays drivers also related to temporal and spatial dimensions. For SNBS the societal focus is on the user perspective, the economical perspective is on the investor perspective and the environmental focus displays the embodied energy of construction materials. This clearly indicates diverging and possibly conflicting interests.

The proposed cRPD framework creates the possibility to reveal and discuss openly the potentially conflicting indicators and associated interests. The diverging interests of individual stakeholders from the planning process can be displayed to create a platform for their negotiation. Because the presumptive common goal amongst the stakeholders is sustainable construction. Lastly it would enable to include and consult missing stakeholders and integrate their interests in critical situations. The authors hope for a discussion on sustainable construction and how this is achieved by means of building standards and labels.

REFERENCES

- [1] United Nations Environment Programme UNEP, 2009: „Buildings and climate change. Summary for Decision Makers“, Sustainable Buildings and Climate Initiative, UNEP-SBCI, Paris.
- [2] Intergovernmental Panel on Climate Change IPCC, 2014: „Climate change 2014: Synthesis Report“, IPCC, Geneva.
- [3] Global Alliance for Buildings and Construction GABC, 2016: “Global Status Report, Towards Zero-Emission Efficient and Resilient Buildings”, GABC, Paris.
- [4] Herazo, B., Lizarralde, G., 2015: “The Influence of green building certifications in collaboration and innovation processes”, *Construction Management and Economics*, 33/4, pp. 279-298.
- [5] Pérez-Lombard, L., Ortiz, J., González, R. and Maestre, I. R., 2009: “A review of benchmarking, rating and labelling concepts within the framework of building energy certification schemes”, *Energy and Buildings*, 41/3, pp. 272-278.
- [6] BREAM. [online]. Retrieved from: <http://www.breeam.com/communities> [Retrieved on 10 August 2016].
- [7] LEED. [online]. Retrieved from: <http://ch.usgbc.org/articles/getting-know-leed-neighborhood-development> [Retrieved on 10 August 2016].
- [8] Markelj, J., Kuzman, M. K. and Zbašnik-Senegačnik, M., 2013: “A review of building sustainability assessment methods”, *Arhitektura Raziskave*, 1, pp. 22-31.
- [9] Herazo, B., Lizarralde, G., 2015: “The Influence of green building certifications in collaboration and innovation processes”, *Construction Management and Economics*, 33/4, pp. 279-298.
- [10] Minergie. [online]. Retrieved from: <http://www.minergie.ch/baustandards.html>.
- [11] 2000-W-Gesellschaft. [online]. Retrieved from: <http://www.2000watt.ch/die-2000-watt-gesellschaft/> [Retrieved on 1 August 2016].
- [12] Bundesamt für Energie BFE, 2016: „Energie Strategie 2050“. [online]. Retrieved from: <http://www.bfe.admin.ch/energiestrategie2050/index.html?lang=de> [Retrieved on 10 January 2017].
- [13] Bundesamt für Raumentwicklung ARE, 2016: „Strategie Nachhaltige Entwicklung“. [online]. Retrieved from: <http://www.aren.admin.ch/themen/nachhaltig/00262/00528/index.html?lang=de> [Retrieved on 15 August 2016].
- [14] Bundesverfassung der Schweizerischen Eidgenossenschaft, P 1, Art. 2, Ziffer 2. [online]. Retrieved from: <https://www.admin.ch/opc/de/classified-compilation/19995395/index.html#a2> [Retrieved on 10 January 2017].

- [15] SNBS. [online] Retrieved from: <http://www.nbbs.ch/nachhaltiges-bauen/> [Retrieved on 1 August 2016].
- [16] Bundesamt für Energie, 2016: „Erfolgskontrolle Gebäudeenergiestandards 2014-2015 Schlussbericht“. [online] Retrieved from: <http://www.bfe.admin.ch/energie/00588/00589/00644/index.html?lang=de&msg-id=61121> [Retrieved on 1 September 2016].
- [17] Ameen, R. F. M., Mourshed, M., Li, H.; „A Critical Review Of Environmental Assessment Tools For Sustainable Urban Design“, *Environmental Impact Assessment Review*, 55, pp. 110-125.
- [18] Drupp, A. M., 2010: „Does the Gold Standard Label Hold Its Promise In Delivering Higher Sustainable Development Benefits? A Multi-Criteria Comparison Of CDM Projects“, *Energy Policy*, 39/3, pp. 1213-1227.
- [19] Happio, A., Viitaniemi, P. A., 2008: „Critical Review of Building Environmental Assessment Tools“, *Environmental Impact Assessment*, 28, pp. 469-482.
- [20] Cole, R.J., 1999: „Building Environmental assessment methods: Clarifying Intentions“, *Building Research & Information*, 27, pp. 230-246.
- [21] Todd, J.A., Crawley, D., Geissler, S., 2001: „Lindsey, G. Comparative assessment of environmental performance tools and the role of the Green Building Challenge“, *Building Research & Information*, 29, pp. 324-335.
- [22] Sutrisna, M., Barrett, P., 2007: „Applying rich picture diagrams to model case studies of construction projects“, *Engineering Construction & Architectural Management* 14/2, pp.164-179.
- [23] Giesekam, J., Barret, J. R., Taylor, P., 2015: „Construction Sector Views on Low Carbon Building Materials“, *Building Research & Information*, 44/4, pp. 1-22.
- [24] Wallhagen, M., Glaumann, M., Eriksson, O., Westerberg, U., 2013: „Framework for Detailed Comparison of Building Environmental Assessment Tools“, *Buildings* 3, pp. 39-60.

More Than Green: The DGNB Certification System for Sustainable Buildings and Districts

Alexander RUDOLPHI^a, Stephan ANDERS^b, Johannes KREISSIG^c, Christine LEMAITRE^d, Anna BRAUNE^e

^a DGNB - German Sustainable Building Council, Germany, ar@rudolphi-rudolphi.com

^b DGNB - German Sustainable Building Council, Germany, s.anders@dgnb.de

^c DGNB - German Sustainable Building Council, Germany, j.kreissig@dgnb.de

^d DGNB - German Sustainable Building Council, Germany, c.lemaitre@dgnb.de

^e DGNB - German Sustainable Building Council, Germany, a.braune@dgnb.de

ABSTRACT

The sustainability concept of the DGNB system covers the well-known three-pillar model of ecology, economy and social issues, as well as technical quality, process quality and location features.

The system's holistic approach promotes innovation by focusing on overall building performance thus, promotes uncompromising quality, new ideas and innovative concepts. Order: Certification follows a holistic approach: the DGNB System assesses the entire life cycle of the building. This makes it possible to define sustainability goals right at the start in the planning phase.

Moreover the DGNB offers a tailored approach to suit Chinese green building policies, market requirements or climate conditions.

Several projects in China and other Asian countries have already been awarded with the DGNB Certificate.

In the paper, we are going to present our experience in the development and evaluation of sustainable buildings and districts and will give an outlook on new developments at the DGNB, like the certificate for “buildings in operation” or the guidance of design and quality of projects. Particularly latter emphasizes our focus not only on lowering resource consumption but also on how we feel in our buildings.

Keywords: certification system, life cycle assessment, DGNB

1. THE DGNB SYSTEM – A HOLISTIC APPROACH

Cities worldwide are facing major challenges due to increasing urbanisation. Traffic, smog, and polluted rivers are **only some of the visible signs**. **The distinguishing features of today's future-oriented cities** are that they offer resource and energy efficient construction and operating systems as well as enduring high living standards and distinctive quality of place. Achieving this offer requires proactive, comprehensive, and transparent planning.

1.1. DGNB System in general



Figure 1: The basic DGNB evaluation structure

The DGNB is the German and international knowledge platform for **sustainable building and provides the world's** most advanced sustainable building certification system. Its aim is the planning and assessment of sustainable buildings and districts. More than 1,200 projects worldwide are pre-certified or certified Further the DGNB is market leader in Germany.

The certification schemes of the German Sustainable Building Council (DGNB) for buildings, districts and industrial locations help consider all aspects of sustainability early in the design phase. Aspects of a district **or location's** economic, environmental, socio-cultural, and technical qualities are given equal consideration throughout the entire **life cycle**. The **DGNB assessment methodology** also addresses the project's process quality and award certificates in silver, gold or platinum, according to the project's overall performance.

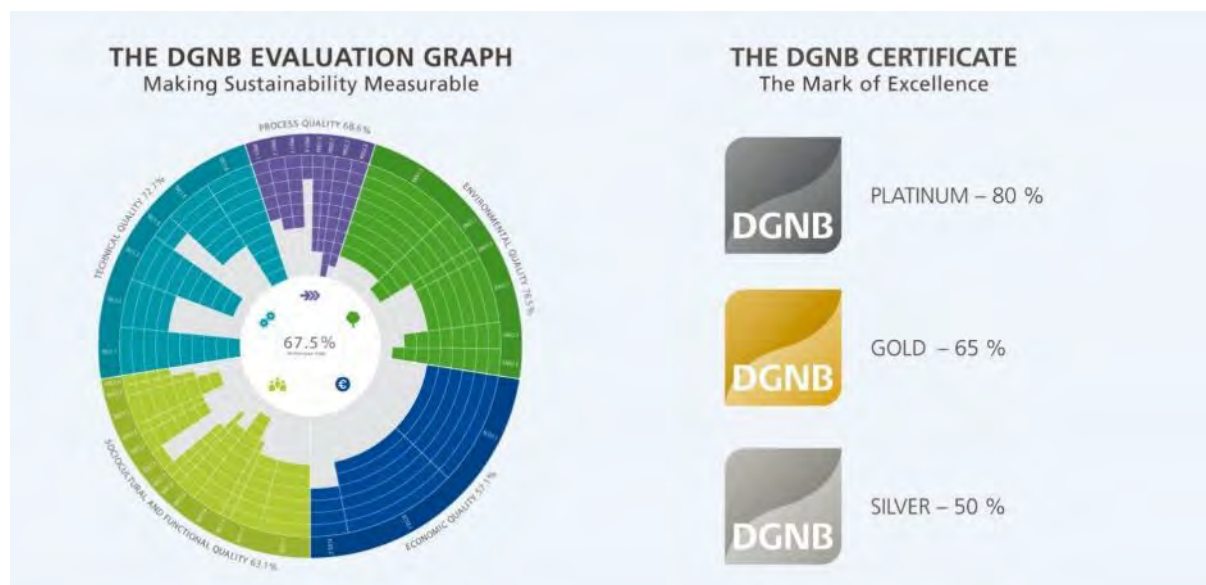

Figure 2: The DGNB evaluation graph and DGNB award's

1.2. From China to Brazil – **The DGNB system's global progress**

The DGNB system's unique holistic view of sustainability fundamentally sets it apart from other rating tools. For instance, the DGNB system gauges buildings' and districts' overall performance rather than allocating points for individual measures. This outcome-oriented flexibility promotes innovative and project-tailored solutions.

The certification system enables transparency, quality control, and eliminates planning risk from project conception to completion. In applying the criteria, the system evaluates all the relevant sustainability factors, and reflects costs **and benefits over the district's entire life cycle. Integrating aspects of sustainability, such as resource consumption, mobility, and future user needs in the early design stages results in greater user comfort and higher living standards as well as adding to the district's financial value. This is sustainability "Made in Germany".**

1.3. The DGNB system – **Where's the difference?**

In the public perception three of the world's leading systems for certification of buildings as DGNB, LEED and BREEAM are often mentioned in the same breath. Besides the obvious similarities there are some fundamental differences between systems.

Sustainable vs. Green

The term "green building" is very closely linked to the area of energy efficiency, which can be only one aspect of sustainable construction. So the DGNB System is based on the classic understanding of sustainability with the triad of ecology, economy and social. For the purposes of the DGNB a building must always be designed and constructed that it

- Is built and can be operated environmentally friendly and resource-efficient,
- Economically viable, long-term cost-saving and flexible,
- Sets the man in focus by enabling health and comfort.

Life-cycle costs and life cycle assessment

The basic idea behind the DGNB System is the analysis of the entire lifecycle of a project. This begins with the extraction of raw materials and ends with the demolition of the building, and the recycling of components. For the other certification systems available on the market, this is done only to a lesser extent.

Better Projects vs. Individual measures

Whether a measure is useful for a project depends on a variety of factors. In this sense, no individual measures (for example, use of photovoltaic) but targets (for example, 50% less energy demand) are valued at the DGNB system. Here, the result is always evaluated, not the measure itself. The optimum for the individual project is left to the builder itself.

Adaptation of the requirements vs. One system for all

In more than 20 countries worldwide buildings have been certified with the DGNB system. The special, as compared to LEED is that the DGNB adapts the criteria on the regional circumstances. This includes, for example, the regulatory framework, the specific market conditions and the climatic conditions. **In LEED projects for example you have to use US standards in Europe, which doesn't make so much sense. Thus, it is not adapted to country-specific circumstances.**

Measurement of indoor air quality

Because man is in focus, the indoor air quality is a very important point in the DGNB system. Here a real measurement of the pollutant content has been made in the air after completion of the building.

Serial and multiple certification

Furthermore, the DGNB provides a series or multiple certification for buildings that are identical but created at different locations. These include, for example, supermarkets or manufactured homes. There is the possibility of a simplified, faster and thus cost-effective certification of the individual buildings.

Design quality

As the first certification systems for sustainable buildings worldwide, the DGNB has launched a pilot phase to evaluate the design quality in 2015. Together with the Federal Chamber of Architects and in cooperation with the Association of German Architects BDA an appropriate methodology has been developed. One approach here are recommendations that are given to the project participants in parallel with the pre-certification at an early planning stage of a DGNB Design Committee

1.4. The DGNB systems for districts and industrial locations

The Urban Districts scheme focusses on the spaces between the buildings and the quality of the district's wider location as well as considering overarching concepts for energy, water, and waste, the urban climate, and biodiversity. The aim is to create urban districts which offer their inhabitants high quality of life while making the most efficient use of resources and protecting the environment. Buildings within the urban district are only considered in terms of their basic parameters and need not be certified for an urban district to achieve a DGNB certification.



Figure 3: Urban district "Carlsberg City District" in Copenhagen (DK),
Pre-certificate in Silver (© Carlsberg Byen p/s, rendering made by Entasis) AND Mairdar EcoCity+, near Ulaan Baatar (Mongolia), DGNB
Pre-certificate in platinum, © Mairdar City LCC

Business districts combine all aspects of an attractive work and leisure environment. Approaches to improve the **quality of place, and the worker's child care and retail amenities are just as relevant as environmental performance** and energy technology. Establishing synergies and mutually beneficial relationships between businesses and their urban setting is another important objective in designing sustainable districts. This efficiently reduces costs in the long term. The quality of life is consistently enhanced and joins forces with cost effectiveness and improved productivity to create decisive added value.

Industrial locations are moving ever closer to the heart of the sustainability debate. DGNB has developed criteria for industry which have been tested in pilot projects for companies such as Volkswagen, Daimler, and Porsche at locations in Germany **and abroad. Next to the building's quality and resource requirements, this scheme takes** open areas, infrastructure, urban context and planning and production processes into account.

Evaluation Area	No.	Criterion
Environmental Quality 22.5%	1	Life Cycle Assessment – emissions, environmental effects
	2	Biodiversity
	3	City climate
	4	Environmental risks
	5	Water and soil protection
	6	Life Cycle Assessment – resource consumption
	7	Water cycle systems
	8	Land use
Economic Quality 22.5%	9	Life Cycle Costs
	10	Fiscal Effects on the Municipality
	11	Resilience and adaptability
	12	Space efficiency
	13	Stability of value
Socio-cultural and Functional Quality 22.5%	14	Thermal comfort in open space
	15	Open space
	16	Emissions/ immissions
	17	Accessibility
	18	Urban Design
	19	Social and functional mix
Technical Quality 22.5%	20	Social and economic infrastructure
	21	Energy infrastructure
	22	Waste Management
	23	Smart Infrastructure
	24	Mobility infrastructure I
Process Quality 10%	25	Mobility infrastructure II
	26	Integral planning
	27	Participation
	28	Project management
	29	Governance
	30	Monitoring

Table 1: Criteria overview of the DGNB Districts system, Version 2016

1.5. The DGNB system for buildings in use – Slim, practically oriented, economically

The new DGNB system "buildings in operation" complements existing DGNB certificates to the assessment of existing buildings with the focus on operational aspects. The usage profile is an easy to handle tool to evaluate and improve the sustainability of the building involving operators and users over only 9 criteria of the sustainability of buildings is evaluated in operation. Applicable for any type of building.

1.6. The DGNB award for design quality

To complement the existing certification system the DGNB takes also the design quality of a Building into account. This should be judged in addition to technical and often quantitative requirements for sustainable building now also the first time the qualitative aspects. There is a two-stage approach, responding to the following target groups:

- Projects at an early stage, which are registered for the DGNB pre-certificate or certificate.
- Projects after completion, which have already received a DGNB Certificate or are shortly before the test.

1.7. The use of the DGNB system in Asia

The unique feature of the DGNB system is its flexible structure, which allows it to adapt to country specific conditions. This is fundamental since a city in Asia, for example, is in many aspects – such as climatic, cultural, and legal frameworks – not comparable to a city in Europe.

The advantages of the DGNB system are now acknowledged by relevant bodies in the construction and real estate sectors. Particularly in Asia, the interest for the DGNB Certification system increased in recent years, and up to date several buildings have been certified or have started the certification process. Also, there are many requests for certification of urban districts and industrial locations. One of these projects is the Sino-German Ecopark in Qingdao (CN) for instance.

To increase awareness about sustainable construction and the DGNB System in China, the DGNB regularly offers training events on related topics. In addition, the DGNB is continuously expanding its network to governmental and non-governmental organisations in Asia, such as Deutsche Gesellschaft für Internationale Zusammenarbeit (GIZ). **It also takes part on relevant events such as the “BAU Congress China” and the “China Green Building Conference”.**

Reference Projects in China and Mongolia: The most advanced sustainable building certification system – made in Germany, applied in China:

- Maidar EcoCity+, global model of sustainable urban development, 300.000 Inhabitants, DGNB Pre-Certificate in Platinum, 30 km to the south of the capital Ulaan Baatar (Mongolia)
- The Bruck Passive House residential building, DGNB Certificate in Platinum, Region of Changxing (China)
- German Enterprise Centre, Mixed-used Building, DGNB Certificate in Platinum, Qingdao (China)
- BASF R&D Service Plattform, Laboratory Building, DGNB Pre-Certificate in Silver, Shanghai (China)



Figure 4: Awarding ceremony, Passivhouse Bruck (Landsea), Changxing (CN), DGNB Certificate



Figure 5: The German Enterprise Centre, Qingdao, DGNB Pre-certificate, Source: Sino-German Ecopark Real Estate AND BASF R&D Center Shanghai, DGNB Certificate, Source: BASF

The most advanced sustainable building certification system – made in Germany, applied in China:

- Internationally recognised quality standard for excellence
- Tailored to suit Chinese green building policies, market requirements and climate conditions
- More than 1,200 certified projects worldwide
- 200 Chinese experts trained as DGNB Consultants
- Holistic approach facilitates focusing on overall building performance

2. DGNB ACADEMY – KNOWLEDGE ON SUSTAINABLE CONSTRUCTION

The key to sustainable building goes beyond the projects that are submitted for certification. Trained experts are needed who understand where changes are required in order to ensure that sustainability is more deeply embedded during planning and construction.

With this goal in mind, the DGNB offers a targeted training concept for Chinese experts that enables them to qualify as a DGNB Consultant. Over the course of three days, the participants are taught everything there is to know about the application of the certification system. The training is aimed at all actors involved in the construction process, from the planning and construction to the operation of sustainable buildings or districts. In the design and planning processes, the DGNB Consultant is responsible for the **implementation of the DGNB's requirements and priorities.**

The training aims at enabling the participants to apply appropriate strategies to effectively address the impacts and interdependencies between social, economic and ecological sustainability criteria in the planning and construction phases. At the same time they learn to use the DGNB System as a planning tool. As early as in the design phase, they will be able to identify optimization potential that can improve the performance and quality of the project.

Session 3.5: Performance Review of Green Buildings (1)

Strategic Study on the Benefit Evaluation of Solar Photovoltaic Promotion Policy in Kaohsiung

CHAO Chien-chiao^a, LI Yenyi^b, HUANG Chi-ming^c, LIU Chung-ang^d, CHUNG Po-ren^e

^a Bureau of Public Works, Kaohsiung City Government, Taiwan, Jhyming1013@gmail.com

^b ShuTe University / TSSBE (iSBE-Taiwan), Taiwan, hamaLee@gmail.com

^c Bureau of Public Works, Kaohsiung City Government, Taiwan, Jhyming1013@gmail.com

^d Bureau of Public Works, Kaohsiung City Government, Taiwan, chungang@kcg.gov.tw

^e Graduate School of Architecture, National ChengKung University, Taiwan, benjamin6686@gmail.com

ABSTRACT

Kaohsiung City's urban landscape is adorned by its majestic mountain, streaming river, wavy ocean, and abundant sunshine. To further complement the city's vibrant atmosphere, the Kaohsiung City Government initiated a project to adjust its industrial structure to promote Kaohsiung as a green eco-city. The goal of the project is to provide a greener, safer, and most importantly, a more sustainable environment for Kaohsiung's citizens so as to create a truly happy and prosperous living environment.

To reach these goals, the Kaohsiung City Government took action with a series of policies to increase solar energy production. Firstly, it established an operating network by forming an inter-departmental task force to promote photovoltaic (PV) systems in the public and private sectors. It also linked professional organizations with local communities, and set up a dedicated hotline for consultation and inquiries. Secondly, it strengthened its photovoltaic infrastructure through formal statutes and regulations. This includes the announcement of a series of official solar photovoltaic policies, the promulgation of a floor area ratio incentive, and the enforcement of mandatory policies to increase photovoltaic implementation. Thirdly, it designated target sites to serve as examples of the project. This includes installing photovoltaic systems on public rooftops, building photovoltaic demonstration zones, transforming illegal structures into solar power providers, and assisting the fishing and agricultural sectors in building photovoltaic systems.

In total, Kaohsiung's 557 cases in 2015 oversaw an instalment capacity increase of 28,491 kW (or 28.491 MW), generated 37 million kWh of power annually, decreased carbon emissions by 23.3 thousand tons, and created a PV industry with a net worth of NTD 2,841.1 million. This study looks at the evidence of achievements the city has made promoting scientifically meaningful architectural aesthetics in its innovative green buildings and energy technology, as well as the success it has seen pushing the policies through a bottom-up structure. In conclusion, it can be said that, using a model based on a project developed by our institute, the Kaohsiung City Government has successfully made the renewable energy become an integral part of Kaohsiung's lifestyle, creating a threefold win for the government, the institute, and the people of Kaohsiung.

Keywords: solar photovoltaic, policy, suit locally, the city of green daylight, low carbon

1. INTRODUCTION

Despite having transformed itself from a wholly industrial city into a thriving metropolis, Kaohsiung City was still marked by its over-concentrated population, lack of green spaces, and excess of artificial heat sources. Kaohsiung is also much hotter compared to its neighbourhood areas, and its temperatures may well continue to rise while its **humidity simultaneously lowers as Kaohsiung's population, commercial activities, and density in land use all continue to grow, leading the city to become what is commonly known as the urban heat island. As a result, increasing the city's green spaces has become a priority in its efforts to lower the rising temperatures.**

Over the years, Kaohsiung City has gone through extensive measures to become its own city. Not only has it upgraded its hardware and software to create a healthy, sustainable, ecological, and cultural environment, it has also established itself as a diverse and sophisticated municipality, and rolled out innovative policies such as the Green Building Self-Governance Ordinance and the Regulations Governing the Establishment of Rooftop Solar Photovoltaic Systems so as to achieve its five core values of "ecology, economy, liveability, creativity, and

internationality.” Its strategies, which have been widely recognized, also include inserting an aesthetic sense of technology into the city’s photovoltaic systems, promoting innovative green buildings and renewable energy technology, and using a bottom-up incentive to encourage owners of illegal structures to spontaneously come forward. Evidence of the city’s efforts can be identified throughout the city as the government continues to build a greener, healthier, and more sustainable city.

2. OBJECTIVES

Working in coordination with Kaohsiung’s climate, the Kaohsiung City Government set the goal to generate 150 MW worth of solar photovoltaic power within four years. It set up an interdepartmental task force to collectively promote the photovoltaic systems within the following five categories: general constructions, public buildings, schools, factories, and fishing and agricultural facilities.

The Kaohsiung City Government set the four-year goal as a mean to fulfil its global responsibilities against greenhouse effect as well as to take care of its citizens in the long run by implementing its core values of bringing “ecology, economy, liveability, creativity, safety, and internationality” into their daily lives.

3. POLICIES AND STRATEGIES

With global warming on the rise, the Kaohsiung City Government was ahead of its time when it initiated its photovoltaic project prior to the promulgation of Taiwan’s Renewable Energy Development Act. While the city’s geological climate rendered it a suitable candidate for solar energy, the reality on the ground was that current building regulations, the conditions of existing structures, and the price of setting up photovoltaic panels had made it hard to promote solar power on a city-wide scale. Having identified these obstacles, the government saw a need to relax existing laws while aggressively pushing, promoting, and subsidizing photovoltaic constructions. It also listed the photovoltaic project among its priority policies for better effect. Therefore, the Kaohsiung municipal government proposed the four year plan and the specific ten action plan. (Table 1)

<i>Creating an Operating Network</i>	Appointing an interdepartmental task force.
	Giving local communities professional assistance
	Setting up a dedicated hotline
<i>Utilizing Policy as Promotional Tools</i>	Formulating statutes and regulations
	Providing floor-to-area ratio incentives
	Making photovoltaic systems mandatory
<i>Push the subject</i>	Installing photovoltaic systems on public rooftops
	Building photovoltaic demonstration zones
	Transforming illegal structures into solar power providers
	Building photovoltaic systems in the fishing and agricultural sectors

Table 1: Kaohsiung government put forward the specific ten action plan

3.1 Creating an operating network

Appointing an interdepartmental task force

The interdepartmental photovoltaic project task force was established with Kaohsiung deputy mayor as convener, deputy director general of the Secretariat as deputy convener, and the Public Works Bureau as chief managerial office. The task force is in charge of supervising the promotion of the photovoltaic project within the five categories of general constructions, public buildings, schools, factories, and fishing and agricultural facilities. The major and assisting offices in charge of the categories (as shown in Figure 1) **work together to fulfil the city’s innovative vision.**

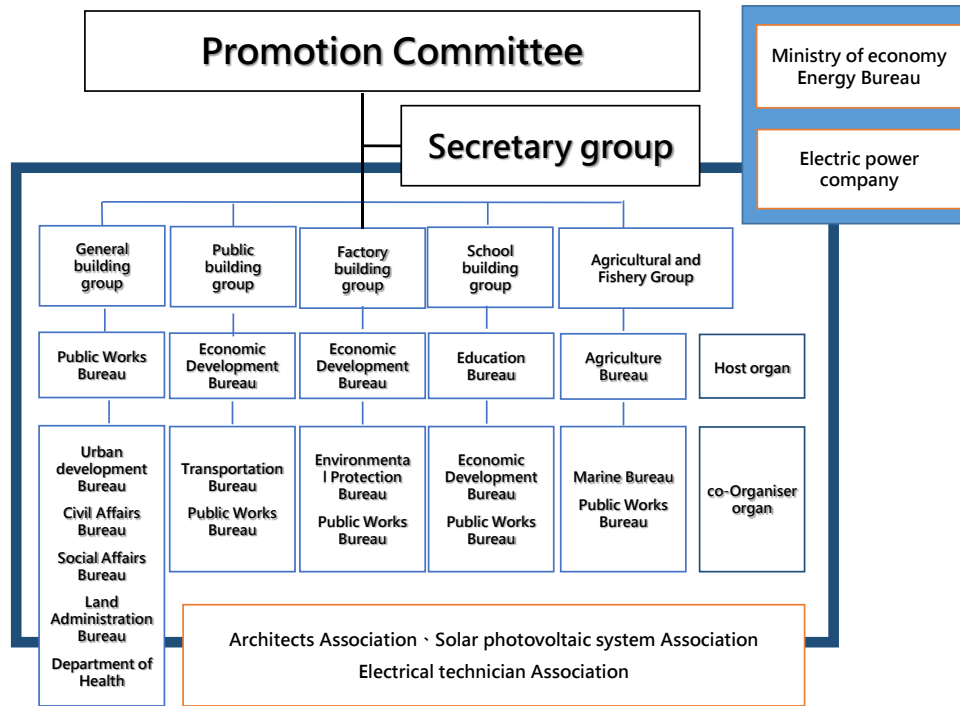

Figure 1: Plans to promote the organization chart

Giving local communities professional assistance

To promote widespread installation of photovoltaic systems across the city, the Kaohsiung City Government sought the assistance of professional associations (Figure 2). This includes the Kaohsiung Architects Association, the Kaohsiung Professional Civil Engineers Association, the Real Estate Development Association of Kaohsiung, the R.O.C. Solar Photovoltaic System Trades Association, the Taiwan Professional Electrical Engineers Association, the Taiwan Photovoltaic Industry Association, the Taiwan Electrical Contractors Association, and the Taiwan Solar Thermal Energy Association. In addition to signing official MOUs with the associations and hosting public briefing sessions to provide more information for the public, the government set up a platform to help pair citizens interested in installing photovoltaic systems with suitable vendors.



Figure 2: Combination of professional groups and community participation in the operation of the photovoltaic project.

Setting up a dedicated hotline

A dedicated service hotline was set up so as to increase the efficiency and efficacy of installation requests. The service hotline not only takes inquiries and applications, but it is also in charge of collecting statistics and data.

3.2 Utilizing policy as promotional tools

Formulating statutes and regulations

The Kaohsiung City Government has since 2012 formulated four architectural laws governing the instalment of photovoltaic systems. The laws were created so as to promote the generation and utilization of the renewable solar energy.

In 2014, the laws were incorporated into a comprehensive project consisting of six laws, a platform pairing individuals with professional instalment vendors, and a subsidization program. Through the formulation, execution, **as well as review and revision of these statutes and regulations, Kaohsiung's solar photovoltaic systems, intelligent energy management operations, and green building standards have been significantly improved.** As the scale of income from promoting green buildings grows, the city is able to continue expanding solar power instalments and energy-saving buildings.

Providing floor-to-area ratio incentives

Another important promotional policy is the floor-to-area ratio (FAR) incentive. Areas with lower FARs will be granted a 30 percent FAR incentive with the instalment of photovoltaic systems. This allows areas consisting mostly of low-rise buildings become so-called **"sunshine communities."** Meanwhile, residential areas with an FAR of 180 percent must install a rainwater storage capacity that is at least 0.132 times the measurement of the area, build a green roof, or install photovoltaic panels that generate more than 2 kW power per building.

Making photovoltaic systems mandatory

The Kaohsiung City Government was able to make photovoltaic instalments mandatory in urban areas, open spaces, and the Kaohsiung LOHAS Housing Project by providing construction businesses with incentives during the initial reviewing stages in urban design projects and the licensing review of construction permits.

3.3 Designating exemplary demonstration sites

Installing photovoltaic systems on public rooftops

As action always speaks louder than words, the Kaohsiung City Government took the lead to install solar photovoltaic systems on the roofs of government buildings and public schools using a rental program. In having vendors set up the solar panels, the government is estimated to have saved around NTD 500-700 million in installation and maintenance fees. In addition to giving the city solar energy, the model also creates economic **value for the local solar power industry, and at the same time serves as an example of the project's benefits,** attracting public attention and recognition. **In doing what's best for the environment, Kaohsiung increases its use of renewable energy, helps the solar photovoltaic related industries grow, and ultimately strengthens the city's economic structure and overall competitiveness.**

Building photovoltaic demonstration zones

The Kaohsiung City Government has chosen the area surrounding the Pier-2 harbour, the Jhongdou **redevelopment zone, and the area of the 2014 Kaohsiung gas explosions as the city's photovoltaic demonstration zones.** The goal is to gradually have the installation of photovoltaic systems expand around the zones and ultimately link up to form a photovoltaic power city.

Transforming illegal structures into solar power providers

Kaohsiung City prides itself in its counselling rather than punishing attitude when it comes to illegal structures. It encourages owners of illegal structures to convert their illegal rooftop dwellings into photoelectric facilities (Figure 5). It also provides loans and subsidies as incentives to increase interest as well as lower installation thresholds.

The new structures, on the one hand, help solve the two most common problems seen in illegal rooftop dwellings, i.e. leaking and overheating, and on the other hand, can be legally built with an additional sunroom compartment. While the city is significantly beautified, the power generated can be sold to the Taipower Company for additional income. As a result, the original hot and stuffy city has the opportunity to be transformed into a pleasant and a steady provider of renewable energy.

Building photovoltaic systems in the fishing and agricultural sectors

Kaohsiung encourages its farmers' associations, traditional wholesales markets, animal protection units, agricultural facilities, and 95 livestock and poultry farms to install solar photovoltaic systems. It is also working with the various agricultural and fishery associations in encouraging the conversion of idle building rooftops into solar panel units.

4. RESULTS

Due to the nature of its development, Kaohsiung City's heavy-industry based economy has come with the price of serious air and environmental pollution. According to statistics, Kaohsiung's annual carbon emissions of 97 million tons make up 25 percent of the nation's total. What's more, each citizen's personal carbon emission is 2.67 times the nation's average. Nonetheless, the city's 2015 statistics show that the 557 photovoltaic application cases successfully created an instalment capacity of 28,491 kW (or 28.491 MW), generated 37 million kWh of power annually, decreased carbon emissions by 2.33 million tons, and created a PV industry with a value output of NTD 2,841.1 million.

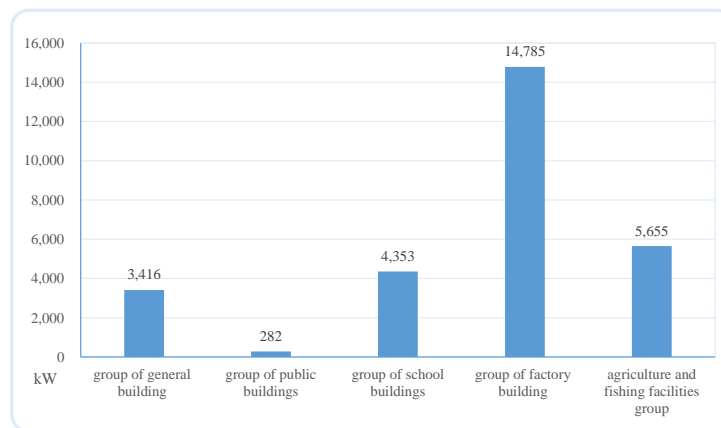

Figure 3: Various groups have been set up photovoltaic capacity

As indicated in Figure 5, factories have the largest photovoltaic power output at 14,785 kWp; fishing and agricultural facilities come in second at 5,655 kWp. It can be said that these traditionally high carbon emission industries are now fulfilling their social responsibilities in reducing greenhouse effect.

Shown in Figure 4, Kaohsiung City, the implementation of the solar photovoltaic policy has a number of specific implementation of the case, According to the situation of different groups, The presentation of the optoelectronic aesthetics of different buildings, Not only create a new state of the city state, Kaohsiung is also the specific contribution to the global energy conservation and carbon reduction.



(a) General constructions



(b) Factories and traffic facilities



(c) Public buildings



(d) Agricultural and fishery facilities



(e.) School buildings

Figure 4: Example of solar photovoltaic systems installed in various types of buildings

5. STAGE CONCLUSION

With the combined use of six laws, one subsidy plan, and one pairing platform, Kaohsiung City's solar photovoltaic project has been deemed a success. According to statistics, the city is estimated to see photovoltaic output of at least 30MW annually. The new regulations have also helped increase the overall number of green buildings in Kaohsiung. **Kaohsiung's creative and diverse efforts to create a greener city have set an example of what could be achieved. It's achievements between 2000-2016 (as of May) are as follow:**

- The total of 3,027 applications has a joint capacity of 152,615 kW (152.615 MW), generates 180,741 kWh annually, has reduced carbon emissions by 15,366 tons, and has created a NTD 15.26615 billion output value for the photovoltaic industry.
- With the talk of an international carbon tax of NTD 1,940 (EUR 50) per ton of emission likely to become a **reality, Kaohsiung City's estimated 30 MW annual photovoltaic output may help lower carbon emissions by 24,276 tons per year.** This would amount to saving NTD 47.1 million annually, and a cumulated NTD 924 million in 20 years.
- The cost saved from having to dismantle illegal rooftop structures, including paying personnel fees, dispatching vehicles, and processing construction waste, is estimated at NTD 135 million per year, which adds up to NTD 27 billion in 20 years.
- As the metal roofs of illegal rooftop structures are converted into solar panels, sunshine is absorbed and **transformed into electricity, resulting in a drop in the city's scorching temperatures.**
- **The photovoltaic project's annual value output of NTD 20 billion helps increase employment opportunities.**

REFERENCES

- [1] Michael P. Gallaher, Albert N. Link, Alan O'Connor, (2012), Public Investments in Energy Technology, Edward Elgar Publishing.
- [2] Sawin, J. L. (2001). The role of government in the development and diffusion of renewable energy technologies: Wind power in the United States, California, Denmark and Germany, 1970--2000.
- [3] Sawin, J. L. (2004). Mainstreaming renewable energy in the 21st century (Vol. 169). Worldwatch Institute.
- [4] Thomas Friedman, Hot, Flat and Crowded (Picador: New York, 2008)
- [5] Ayoub, Nasser, and Naka Yuji. "Governmental intervention approaches to promote renewable energies— Special emphasis on Japanese feed-in tariff.", Energy Policy 43 (2012): 191-201.
- [6] Butler, Lucy, and Karsten Neuhoff. "Comparison of feed-in tariff, quota and auction mechanisms to support wind power development." Renewable Energy 33.8 (2008): 1854-1867
- [7] Couture, Toby, and Yves Gagnon. "An analysis of feed-in tariff remuneration models: Implications for renewable energy investment." Energy policy 38.2 (2010): 955-965.
- [8] Campbell, M., Aschenbrenner, P., Blunden, J., Smeloff, E., & Wright, S. (2008). The drivers of the levelized cost of electricity for utility-scale photovoltaics. White Paper: SunPower Corporation.
- [9] Flood, D. J. (2001). Space photovoltaics—history, progress and promise. Modern Physics Letters B, 15(17n19), 561-570.

- [10] Fthenakis, V. M., & Moskowitz, P. D. (2000). Photovoltaics: environmental, health and safety issues and perspectives. *Progress in Photovoltaics: research and applications*, 8(1), 27-38.
- [11] Hammond, A. L. (1977). Photovoltaics-The semiconductor revolution comes to solar. *Science*, 197, 445-447, p. 445.
- [12] Hasnain, S. M., Elani, U. A., Al-Awaji, S. H., Aba-Oud, H. A., & Smiai, M. S. (1995). Prospects and proposals for solar energy education programmes. *Applied Energy*, 52(2), 307-314.
- [13] Huang, Yun-Hsun, and Jung-Hua Wu. "Assessment of the feed-in tariff mechanism for renewable energies in Taiwan." *Energy Policy* 39.12 (2011): 8106-8115.
- [14] Haas, Reinhard, et al. "A historical review of promotion strategies for electricity from renewable energy sources in EU countries." *Renewable and sustainable energy reviews* 15.2 (2011): 1003-1034.

A Baseline Study on Thermal Performance of Prefabricated Modular Buildings in Australia

Sareh NAJI^a, Valentin PLOYET^b, Masa NOGUCHI^c, Lu AYE^d

^a The University of Melbourne, Australia, snaji@student.unimelb.edu.au

^b The University of Melbourne, Australia, valentinployet@yahoo.fr

^c The University of Melbourne, Australia, masa.noguchi@unimelb.edu.au

^d The University of Melbourne, Australia, lua@unimelb.edu.au

ABSTRACT

Prefabricated modular construction is one of building solutions that has positive effects on construction time and waste management. In general, thermal performance of the building envelope is an important parameter which dictates the operational energy consumption. There are some prefabricated modular buildings available in Australia. However, their thermal performance benchmarks have not been well documented in the literature. Innovative panel systems have been proposed to improve the cost competitiveness and to achieve better performance. It is essential to know the current performance so that newer panels can be proven to be better. This paper investigates the thermal performance of four prefabricated modular buildings currently available in the Australian market. The buildings were selected to represent single-family houses with different floor areas. A building energy performance simulation tool was used to predict the cooling and heating loads of each building. The findings based on the simulations are presented in this paper.

Keywords: modular buildings, thermal performance, heating and cooling, energy simulation

1. INTRODUCTION

Due to the increasing trend of energy usage and greenhouse gas (GHG) emissions, various sectors throughout the world give priority to reducing GHG emissions and increasing energy efficiency. Building sector accounts for **almost one third of world's total energy consumption** while it is the source for intense GHG emissions as well. For instance in Europe, Buildings account for 40% of the energy consumption and 36% of the CO₂ emissions. Energy consumption of the buildings in the US was about 40% of total energy consumption in 2012. Furthermore, in 2015 around 20% of total energy consumption of Australia was associated with residential and commercial buildings.

Modular buildings are the outcome of off-site manufacturing technology in which up to 70% of the construction is carried out in factory. They are factory constructed three dimensional units and transported to the building site. Prefabricated modular construction offers benefits in terms of construction time, cost and waste management. These benefits lead to reductions in materials and energy use and waste during onsite construction. Further benefits are improvement in environmental performance and building overall quality due to standardisation of methods and components.

Previous researches show that up to 70% of buildings' energy consumption is associated with the operational phase. The reduction of energy usage by applying engineered materials and appropriate designs are well documented in the literature. Several studies have been carried out focusing on the environmental performance of residential buildings considering different stages of building life ranging from whole life cycle environmental assessment to merely construction or operation. They have emphasised on various effective factors such as building design, physical properties, passive strategies and occupants. A few researches have been carried out focusing on life cycle costs of prefabricated and modular buildings using life cycle assessment (LCA) method. However, the thermal performance of the prefabricated modular residential buildings is not well documented in the literature. It is necessary to investigate the current baseline performance of these buildings in order to prepare a guideline to improve the new buildings to be constructed in future.

This study investigates the thermal performance of four prefabricated modular buildings as a part of baseline performance evaluation of modular construction in Melbourne, Australia. The materials and systems investigated in this paper are applied in Australian modular construction industry. EnergyPlus was used to simulate the building and estimate the building cooling and heating loads. The main focus of this study is on the building size and

envelops design. The results of energy performance simulations for four sample buildings are presented in this paper.

2. THERMAL PERFORMANCE EVALUATION

2.1 Sample buildings

Four floor plans (Wattle, Banksia, Territory and Outback) which are available in the Australian market were investigated. These sample buildings exemplify the typical residential plans constructed by modular construction method. The detailed building data were obtained from the website of a modular construction company in Australia. All selected modular buildings are single story residential buildings. The location considered was Melbourne, Australia. Figure 1 shows the floor plans of the selected buildings. The smallest building is Wattle constructed with only one module (12192 x 3000x 3100 mm at 17 t) and the largest building is Outback constructed of four modules. Banksia and Territory are constructed by using two and three modules respectively.

2.2 Simulation method

The 3D models of the buildings were generated using “OpenStudio” plugins in Sketchup environment. Afterwards all required features of the building were defined in OpenStudio. In this paper the main focus of simulations is to investigate thermal performances for different building sizes. In this respect, other factors that affect the energy consumption of buildings such as location, orientation, annual climate and environmental conditions are considered fixed for simulations. No internal heat loads related to occupancy and equipment were considered. The materials used in building construction, their thicknesses and properties are presented in Table 1.



Figure 1: Floor plans of the four sample buildings

EnergyPlus website provides weather data for different locations based on various data resources. The provided data relevant to the site for Victoria, Australia are based on RMY data source which is Australia representative

meteorological year climate files developed by “Australia Greenhouse Office”. In order to acquire representative long term data, the weather file was generated by using “Meteonorm”. Meteonorm is a Swiss made software providing worldwide weather data in various export formats. Data source used by this software is “world meteorological organization” (WMO) which is providing accurate scientific weather information.

For all buildings ‘Ideal Air Load’ option was selected in EnergyPlus. The schedules for heating and cooling were defined according to local seasons. According to Lhendup et al the heating season is from 1 May to 31 October; whilst the cooling season is from 1 December to 28 February. During the remaining months the heating and cooling systems are not active. The thermostat set points for heating were 21°C during the day (6 am – 10 pm) and 18°C during the night (10 pm – 6 am). The thermostat set point was assigned as 24°C for the cooling season. Table 2 shows the main features of the buildings defined in OpenStudio.

Component	Material	Thickness mm	Conductivity W m ⁻¹ K ⁻¹	Density kg m ⁻³	Specific heat J kg ⁻¹ K ⁻¹
Exterior Wall	Steel wall panel	1.6	54	7800	450
	OSB board	25	0.13	640	840
	Insulation	90	0.043	91	837
	OSB board	25	0.13	640	840
	Plasterboard	10	0.19	1300	840
Interior Wall	Plasterboard	10	0.19	1300	840
	OSB board	25	0.13	640	840
	Air space	20	-	-	-
	OSB board	25	0.13	640	840
	Plasterboard	10	0.19	1300	840
Floor	Light wt concrete	100	0.53	1280	840
	Membrane	9	0.16	1121	1460
	Cement Mortar	15	1.60	2000	1000
	Vinyl covering	15	17	1390	900
Roof	Metal roofing	1.5	45	7680	418
	OSB board	25	0.13	640	840
	Insulation	17	0.049	265	836
	Roof membrane	9	0.16	1121	1460
	Gypsum	12	0.16	784	830
Interior Door	Wood	25	0.15	608	1630
Exterior Door	Metal Surface	0.8	45	7824	500
	Insulation board	25	0.03	43	1210

Table1: The properties of selected materials for each components of the building

Category	Item	Value
Location, Melbourne, Australia	Latitude [deg]	-37.817
	Longitude [deg]	144.967
	Time Zone [h]	10
	Elevation above sea level [m]	38
	Site ground temperature [°C]	18
Window glazing	U-Factor [W m ⁻² K ⁻¹]	2.10
	Solar transmittance [-]	0.237
Thermostat settings	Heating set point:	Day:21°C, Night:18°C
	Cooling set point:	24°C
Space infiltration rate	Flow per space floor area [ms ⁻¹]	0.0007
Design ventilation rate	Outdoor Air flow per floor area [ms ⁻¹]	0.0003

Table 2: Main features of the buildings defined in OpenStudio

3. RESULTS AND DISCUSSION

3.1 Effect of building size

Building size can affect the total energy consumption and energy consumption per unit floor area. While the total cooling and heating loads tend to increase by growth of building size, the loads per floor area is expected to decrease. Table 3 shows the total floor area and floor area of conditioned spaces for four sample buildings. The **conditioned spaces are living room, bedrooms and study rooms for which 'Ideal Air Load' option has been set in EnergyPlus.** The unconditioned spaces include the bathrooms and storages. Table 3 shows that the ratio of conditioned spaces has been decreased as the total floor area increases. While 92% of the spaces in the Wattle building are conditioned, this percentage decreases to 85% in the Outback.

Building	Area (m ²)				Window to wall ratio (%)				
	Floor	Conditioned	Walls	Window	North	East	South	West	Overall
Wattle	40.2	36.9	85.21	11.75	3.74	27.88	3.64	78.38	14
Banksia	68.4	61.8	104.12	6.91	9.26	5.04	5.61	5.04	7
Territory	109.7	94.4	116.56	12.34	7.03	14.69	3.33	21.01	10
Outback	135.7	114.8	148.20	18.34	30.55	4.84	11.33	5.15	12

Table 3: Areas and window to wall ratios of the buildings investigated

3.2 Effects of wall to window ratio and conditioned area

The components and configurations of building envelope highly affect the energy consumption of the buildings. The location and size of the windows, the construction of exterior walls and roof, window and wall areas and the window-wall ratio are some of the envelope parameters that highly affect the amounts of heat gain in summer and heat loss in winter. An increase in window area especially on north façade can increase the cooling load during summer. Table 3 shows the window and wall areas as well as window to wall ratios on the exterior walls facing different directions for all simulated buildings.

Banksia has smaller window area than Wattle which causes a dramatic fall in window to wall ratio of Banksia (see Table 3). Wattle has large windows and a big glass door on the east and west façade respectively. Regarding the fact that Wattle is the smallest building and therefore wall area is lower than other three buildings the high value of window to wall ratio can be justified.

3.3 Cooling and heating loads

The simulations of four sample buildings were carried out in order to evaluate the thermal performance. According to the results, the cooling load is considerably lower than heating load for all buildings. This is due to the climate conditions of Melbourne in which the heating season is longer and more heating load is required to fulfill indoor thermal comfort. The annual cooling load is maximum among all simulated buildings for Wattle being equal to 0.43 GJ. This can be explained due to higher window to wall ratio and larger total surface area to volume ratio which can result in higher load per unit floor area. The annual cooling load per unit area for Bankisa, Territory and Outback are relatively close (0.18, 0.17, and 0.19 GJ respectively). The cooling load for Banksia is slightly higher than the one that of Territory. This can be explained by the fact that the window to wall ratio on north façade is higher for Banksia which caused more heat gain during the summer. The heating load increases with a rise in total building area. Since window area has less influence on heating load compared to cooling load, the heating load increased consistently from Wattle to Outback. The values of annual heating loads are 13.08, 21.06, 26.09 and 33.25 GJ for Wattle, Banksia, Territory and Outback respectively. The maximum and minimum cooling loads occur during January and December respectively. The heating load is maximum in July and minimum in October.

Figures 2a and 2b show the values per unit floor area for heating and cooling loads respectively. The heating energy per floor area decreases with the rise in the floor area. **However, it increases slightly from "Territory" to "Outback". This pattern verifies the fact that rather than floor area other factors such as building envelope design parameters can influence the energy consumption of the buildings.** For instance, the addition of shading devices can significantly reduce the cooling load since it limits the amount of solar heat gain received from glazed areas. Similarly the glazing type and properties of glazing affect the heat transfer between indoor and outdoor environments and the heating and cooling loads accordingly [25]. Building orientation is another factor that affects the building energy consumption since the amount of solar heat gain can vary by changing the orientation. Other

factors such as occupation and compartmentalisation can affect the building loads. However, the occupancy was not considered in this paper. Also compartmentalisation is expected to have small impact on the loads of the sample buildings investigated in this paper. Cooling load per unit floor area decreases consistently with increasing floor area (Figure 2b). To justify the change in heating load per unit floor area the trend of increase in floor area as well as window to wall ratio should be considered.

The sharp change in the cooling load between Wattle and Banksia can be explained by considering the high amount of total cooling load for Wattle. Since the total cooling load of other three buildings were of close values, the consistent reduction of the cooling load per floor area from Banksia to Outback is reasonable.

Figure 3 shows the annual electricity consumption per floor area for the sample buildings. These values have been calculate according to peak demand of each building and by selecting appropriate equipment with adequate capacity from Australian energy star rated equipment list. Table 4 provides the capacities, cooling and heating coefficient of performances (COPs) of the heat pumps selected. It is apparent from Figure 3 that the electricity consumption per floor area decreased consistently from Wattle to Territory, but increased from Territory to Outback. The increase in the electricity consumption for Outback is due to the lower COPs of the heat pump available and selected to meet the higher peak loads (see Table 4).

Building	Heat pump model	Heating (kW)	Heating COP	Cooling (kW)	Cooling COP
Wattle	Daikin FFO25C2 / RXS25K3	3.2	4.00	2.5	4.46
Banksia	Daikin FTXM50P / RXM50P	6.0	4.23	5.0	4.24
Territory	Daikin FTXM60P / RXM60P	7.0	4.07	6.0	3.87
Outback	Daikin FTXS71L / RXS71L	8.0	3.67	7.1	3.41

Table 4: Capacities and COPs of heat pump selected

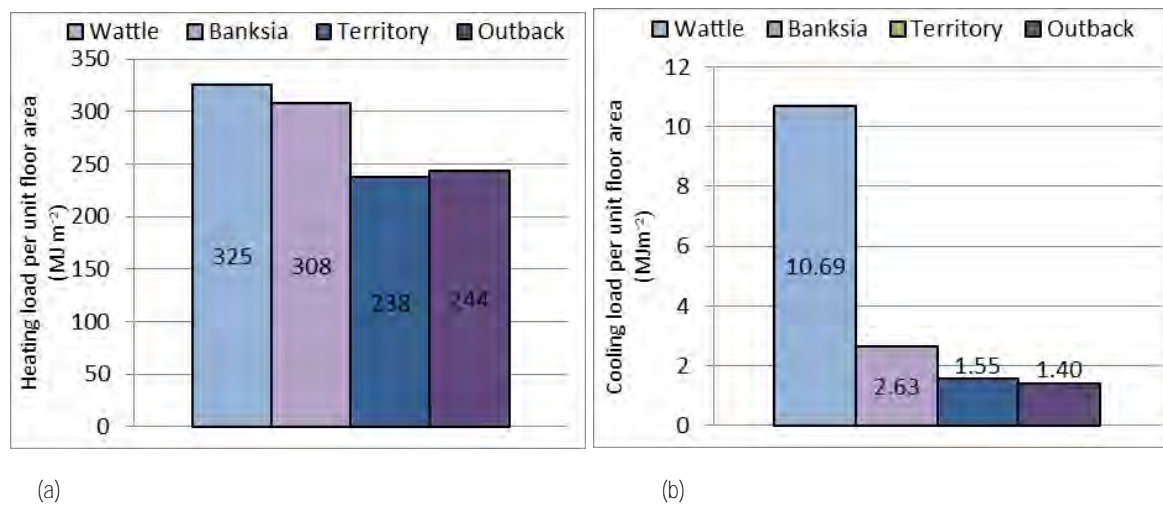

Figure 2: (a) Heating and (b) Cooling load per unit floor area for all simulated buildings

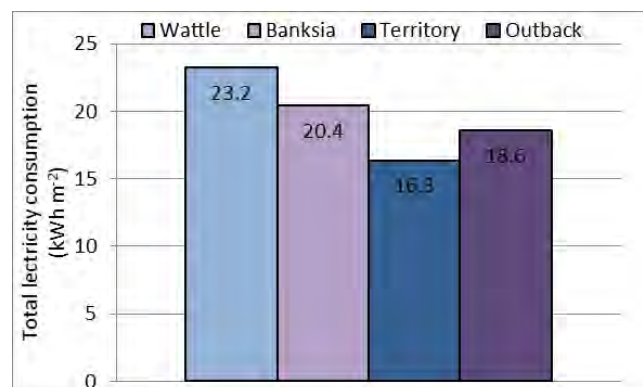

Figure 3: Annual electricity consumption

4. CONCLUSION

In this paper energy performance simulations of four prefabricated modular houses have been carried out using EnergyPlus interface with OpenStudio. The buildings have been selected from a supplier available on the market. The number of selected sample buildings was limited to four which are representatives of single family residential houses with different floor areas. A larger number of sample buildings that could provide better opportunity for more expanded results and discussion is to be considered in future works. Except building envelope parameters and floor area all other effective factors have been remained constant throughout the simulations. The heating and cooling seasons for Melbourne have been defined according to literature and applied in the simulations.

The results reveal that heating and cooling load of the buildings highly depend on both floor area and window to wall ratio. While the energy required for heating showed increase in buildings with larger floor area, the cooling load followed a different pattern that indicated the impact of envelope parameters. Results showed that for Melbourne climate the heating load is significantly larger than cooling load. The monthly results show that the highest heating load occurs in July for all buildings. The highest cooling energy is consumed during January for all buildings. The heating and cooling energy per floor area show a decreasing trend with increase of floor area. Results also indicate that window to wall ratio has higher impact on cooling load compared to heating load.

REFERENCES

- [1] Aye L, Ngo T, Crawford RH, Gammampila R, Mendis P, 2012. Life cycle greenhouse gas emissions and energy analysis of prefabricated reusable building modules. *Energy and Buildings* 47:159-68. doi:10.1016/j.enbuild.2011.11.049
- [2] BOM, 2016. World Meteorological Organization [Internet]. Australian Government Bureau of Meteorology. Available from: <http://www.bom.gov.au/wmo/> [Retrieved on 20 November 2016].
- [3] Cao X, Li X, Zhu Y, Zhang Z, 2014. A comparative study of environmental performance between prefabricated and traditional residential buildings in China. *Journal of Cleaner Production* 109:131-43. doi:10.1016/j.jclepro.2015.04.120.
- [4] Chung WH, Okudan Kremer GE, Wusk RA, 2014. Life cycle implications of product modular architectures in closed-loop supply chains. *The International Journal of Advanced Manufacturing Technology* 70(9):2013-28. doi:10.1007/s00170-013-5409-8.
- [5] Cowie J, Blamire M, 1998. Climate change and energy use. *Physics World* 11(6):15. doi:10.1088/2058-7058/11/6/16.
- [6] Dave M, Bilbao J, Dickson J, Watson B, Presad D, Sproul A, 2014. Towards sustainable modular housing: A case study of thermal performance optimisation for Australia. PLEA 2014, 1-8. http://www.plea2014.in/wp-content/uploads/2014/12/Poster_PD_2418_PR.pdf.
- [7] Department of Industry and Science, 2016. Australian Energy Update 2016. 1-25. Available from: <https://industry.gov.au/Office-of-the-Chief-Economist/Publications/Documents/aes/2016-australian-energy-statistics.pdf>
- [8] Depecker P, Menezo C, Virgone J, Lepers S, 2001. Design of buildings shape and energetic consumption. *Building and Environment* 36(5):627-35. doi:10.1016/S0360-1323(00)00044-5.
- [9] EnergyPlus, 2016. EnergyPlus weather data [Internet]. Available from: <https://energyplus.net/weather> [Retrieved on 20 November 2016].
- [10] Equipment Energy Efficiency Program, 2016. Air Conditioners - AS/NZS 3823.2 [Internet]. A joint initiative of Australian, State and Territory and New Zealand Governments. Available from: http://reg.energyrating.gov.au/comparator/product_types/64/search/ [Retrieved on 3 January 2017].
- [11] Gill ZM, Tierney MJ, Pegg IM, Allan N, 2010. Low-energy dwellings: The contribution of behaviours to actual performance. *Building Research & Information* 38(5):491-508. doi:10.1080/09613218.2010.505371.
- [12] Gupta R, Chandiwala S, 2010. Understanding occupants: Feedback techniques for large-scale low-carbon domestic refurbishments. *Building Research & Information* 38(5):530-48. doi:10.1080/09613218.2010.495216.
- [13] Kamal MA, 2016. Material characteristics and building physics for energy efficiency. *Key Engineering Materials* 666:77-87. doi:10.4028/www.scientific.net/KEM.666.77.
- [14] Lawson M, Ogden R, Goodier C, 2014. *Design in Modular Construction*, CRC Press.
- [15] Lei J, Yang J, Yang E, 2016. Energy performance of building envelopes integrated with phase change materials for cooling load reduction in tropical Singapore. *Applied Energy* 162:207-17. doi:10.1016/j.apenergy.2015.10.031

- [16] Lhendup T, Aye L, Fuller RJ, 2012. Seasonal coolth storage system for residential buildings in Australia. *Journal of Central South University* 19(3):740-7. doi:10.1007/s11771-012-1066-6.
- [17] Mangan SD, Oral GK, 2016. Assessment of residential building performances for the different climate zones of Turkey in terms of life cycle energy and cost efficiency. *Energy and Buildings* 110:362-76. doi:10.1016/j.enbuild.2015.11.002.
- [18] Meteonorm, 2016. Meteonorm Features [Internet]. Available from: <http://www.meteonorm.com/> [Retrieved on 20 November 2016].
- [19] Naji S, Keivani A, Shamshirband S, Alengaram UJ, Jumaat MZ, Mansor Z, Lee M, 2016. Estimating building energy consumption using extreme learning machine method. *Energy* 97:506-16. doi:10.1016/j.energy.2015.11.037.
- [20] Neto AH, Fiorelli FAS, 2008. Comparison between detailed model simulation and artificial neural network for forecasting building energy consumption. *Energy and Buildings* 40(12):2169–76. doi:10.1016/j.enbuild.2008.06.013.
- [21] Persson M, Roos A, Wall M, 2006. Influence of window size on the energy balance of low energy houses. *Energy and Buildings* 38(3):181–8. doi:10.1016/j.enbuild.2005.05.006.
- [22] Premrov M, Zegarac V, Mihali K, 2016. Influence of the building shape on the energy performance of timber-glass buildings in different climatic conditions. *Energy* 108:201–11. doi:10.1016/j.energy.2015.05.027.
- [23] Sadineni SB, Madala S, Boehm RF, 2011. Passive building energy savings: A review of building envelope components. 2011; *Renewable and Sustainable Energy Reviews* 15(8):3617-3631. doi:10.1016/j.rser.2011.07.014.
- [24] Szokolay SV. *Solar energy and building*. Halsted Press, New York, NY; 1977.
- [25] Thomsen KE, Rose J, Mørck O, Jensen SØ, Østergaard I, Knudsen HN, Bergsøe NC, 2016. Energy consumption and indoor climate in a residential building before and after comprehensive energy retrofitting. *Energy and Buildings* 123:8-16. doi:10.1016/j.enbuild.2016.04.049
- [26] Wu MH, Ng TS, Skitmore MR, 2016. Sustainable building envelope design by considering energy cost and occupant satisfaction. *Energy for Sustainable Development* 31:118–29. doi:10.1016/j.esd.2015.12.003

Energy Saving Potential of Thermal Broken Fenestration System in Hot Climate Counties

Simon WONG^a

^a *Technoform Bautech Hong Kong Ltd., Hong Kong SAR, simon.wong@technoform.hk*

ABSTRACT

The unprecedented volatility in energy prices of the last few years and rising global warming problems, has led the **topic of “Energy Conservation” to become the most important and relevant topic worldwide**. Building, Industrial and Transportation are the three major sectors contributing to the energy consumption globally. Building energy accounts for more than one third of the global consumption and thus, many countries take top priority in increasing the building energy efficiency.

Hong Kong is located in southern China with typical maritime subtropical climate. The long summer begins from April till October with hot and humid weather conditions, with occasional tropical typhoons. Temperatures in the afternoon are usually hottest, especially in July and August with an average temperature higher than 31°C, while it could be as high as 33°C in the New Territories. In addition, Hong Kong as a metropolitan city, with a high density of high-rise buildings, is affected by the heat island effect.

With greater awareness in building energy efficiency and green building codes, there is a rise in demand for high-performance window systems. However, the common fenestration systems used in Hong Kong combines high-performance glazing with non-thermal insulated frames. Such design combination results in a significantly lower overall thermal performance of a window system.

In this paper, we investigate how the thermal transmittance of frames (U_f value) has a direct influence on solar heat gain of fenestration system with a experimental and simulation analysis to understand the importance of using high performance fenestration system with low U_f value in tropical and sub-tropical countries such as Hong Kong.

Keywords: U value, solar heat gain coefficient SHGC: overall thermal transfer value OTTV

1. INTRODUCTION

1.1. Background

With the rapid economic development and increasing quality of living, Hong Kong's construction industry has developed rapidly and a comfortable living environment is essential to meeting the people's increasing demand for better living conditions.

Hong Kong is located in the South China region and is connected with mainland China in the northern part of the island, while the south faces in the direction of the South China Sea. Summer are hot and humid with temperature between 27 ~ 33°C with typical subtropical monsoons; winter are cool and dry, but rarely falls below 5°C. **Hong Kong is a cosmopolitan city with the world's third highest population density. Crowded commercial and residential high-rise buildings form Hong Kong's urban landscape. This is a reason for the urban heat island effect.**

In cities like Hong Kong, with a long period of high temperature. Building energy consumption accounts for more than 90% of the total energy consumption. Improvements should be made on the thermal performance of building envelope, thereby reducing the building air conditioning load, achieving better building energy efficiency.

At present, the OTTV is the only mandatory criteria to evaluate the thermal performance of building envelope; this evaluation includes the thermal transmission through the opaque walls and roofs, and the solar radiation through the window glass.

In the sub-tropical and tropical climatic regions, building envelope is constantly exposed to solar irradiation all year round. The traditional method of improving the thermal performance of fenestration is by adding a shading system to prevent sunlight from passing through the glazing, thereby reducing the solar heat gain through the fenestration.

However, building designer tends to neglect the solar heat gain effects through the overall fenestration system in the building envelope.

In this paper, we will find out how the solar heat gain coefficient SHGC is directly influenced by the Uf value of the **fenestration system's opaque frames and how the thermal performance of building envelope can be effectively improved** by the thermal broken aluminium fenestration system.

1.2. Concept of OTTV and development

The OTTV (Overall Thermal Transfer Value) concept was introduced by the US in the 70's. It was widely used to measure the thermal performance of building in Asia Pacific countries, and Hong Kong is one of them. According to the "Code of Practice for Overall Thermal Transfer Value in Building 1995", the OTTV calculation equation is

$$\text{OTTV} = (A_w \times U \times \alpha \times T_{\text{DeqDw}}) + (A_{\text{fw}} \times \text{SC} \times \text{ESM} \times \text{SF}) / A_{\text{ow}}$$

Equation 1

The formula considers the heat gain through the opaque wall and roof, as well as the solar radiation through the glazing. **However, it ignores the conductivity and solar heat gain effects from the fenestration system's frame.**

Singapore is another Asia country which has implemented the OTTV concept and the country later modified it as ETTV (envelope thermal transfer value, the calculation equation is:

$$\text{ETTV} = 12(1 - \text{WWR})U_w + 3.4(\text{WWR})U + 211(\text{WWR})(\text{CF})\text{SC}$$

Equation 2

The formula considers three key criteria, the heat gain through the opaque wall, heat gain through the windows and solar radiation through the glazing. Basic concept is similar to OTTV's but the TDeq (annual equivalent temperature difference) and SF (annual equivalent solar factor) are simulated by actual climate condition.

The weather conditions and humidity levels between Singapore and Hong Kong are similar. Therefore, the experimental results for thermal broken fenestration system could give significance reference to Hong Kong.

2. ALUMINIUM PROFILES HEAT GAIN

2.1 Solar heat gain coefficient

With reference to the ETTV equation, we assume a room with a window wall ratio of 1 (window only, without opaque wall), and CF=1 (based on south-east facing vertical window), the ETTV equation can be expressed as:

$$\text{ETTV} = 3.4U + 211\text{SC}$$

Equation 3

From the above equation (3), it can be illustrated that the thermal transmittance of the window (U value) has a less significant influence to the ETTV than compared to the shading coefficient SC value. Based on this concept, it is understandable why building designers are more concerned with the SC value of the fenestration in hot climate areas. With this design concept, energy-saving windows and doors designs with low U-values are not often considered as an important design parameter.

In fact, there is a big misconception of designs taking into consideration only the SC values. The SHGC solar heat gain coefficient, also known as solar radiation admitted through a window, is the fraction of the solar radiation heat passing through the window. The SHGC includes two parts; solar radiation heat entering directly through the glass and the heat gain through the window frame component which absorbs and re-radiate inwards.

At present, both Hong Kong and Singapore both assumes that the U value and SC value of a window system is equal to the U value and SC value of the center-of-glazing. However, consideration of the solar heat gain through the window frames should be accounted for in evaluating the energy performance of the building. This can be done **by converting the equation's SC value to SHGC value by dividing the SC value by a factor of 0.87.**

2.2 Frames sample test

The following is a test conducted by Solar Energy Research Institute of Singapore (SERIS) to analyse the solar radiation absorption by the window frames and re-radiation inwards as a heat gain. Figure 1 is the actual test site, with its façade facing west and it is not shaded by trees or other structures. The room is air-conditioned during typical office hours. 10 aluminium profile samples with different colour and performance (with thermal break or without thermal break) were placed into the window opening as shown in Figure 2 and Table 1. All test samples are monitored by the many sensors located in the test facility, recording in 2 seconds intervals, and the data are then stored in the computer.



Figure 1: Test site



Figure 2: Aluminium profile samples

1	No thermal break, light color	AL_LC	2	No thermal break, dark color	AL_DC
3	With low performance thermal break, light color	TBL_LC	4	With low performance thermal break, dark color	TBL_DC
5	With moderate performance thermal break, light color	TBM_LC	6	With moderate performance thermal break, dark color	TBM_DC
7	With high performance thermal break, light color	TBH_LC	8	With high performance thermal break, dark color	TBH_DC
9	No thermal break, light color		10	No thermal break, dark color	

Table 1: Aluminium profile samples for testing

Figure 3 shows on a representative day during 14:00-18:00 hours, with solar radiation intensity being highest in the day. Outdoor air temperature was up to 38°C, while the indoor temperature maintained stable at 22-23°C by air-conditioning. Figure 4 shows the heat flux through the black aluminium non-thermally broken sample is the highest, with more than 400W/m², much higher than the light coloured high-performance thermal break aluminium samples which recorded a low heat flux of 60W/m².

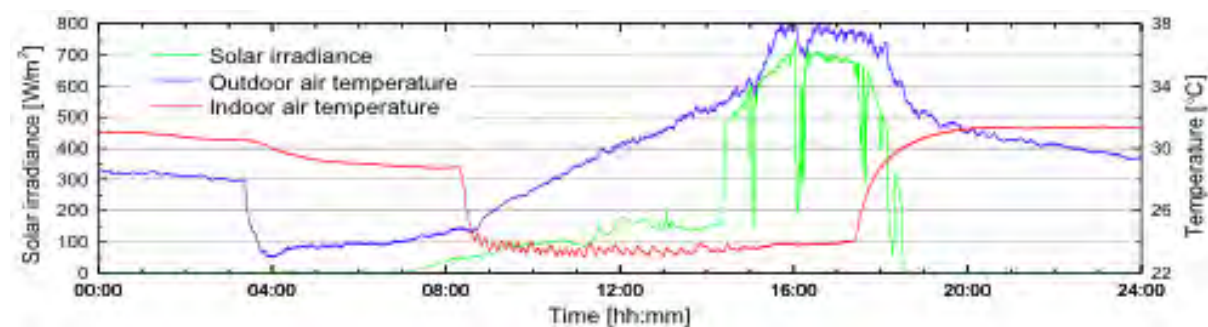

Figure 3: Solar irradiance and indoor/ outdoor air temperature

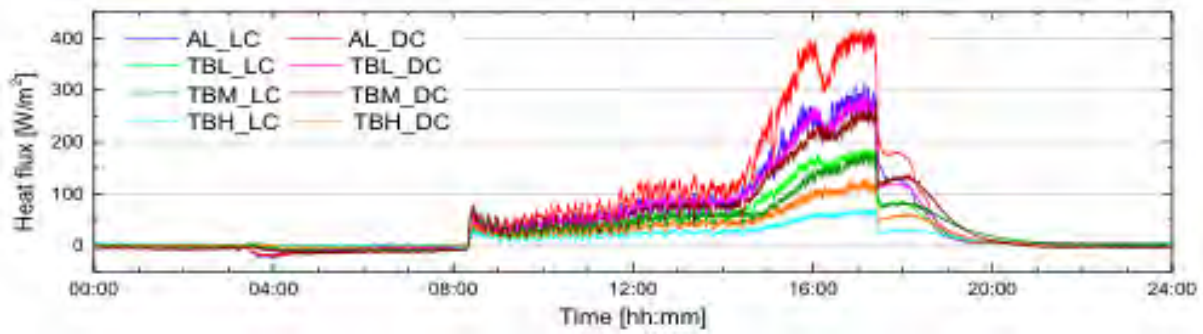

Figure 4: Heat flux through frame samples

Frame heat gain is correlated to its U-value and solar absorptance

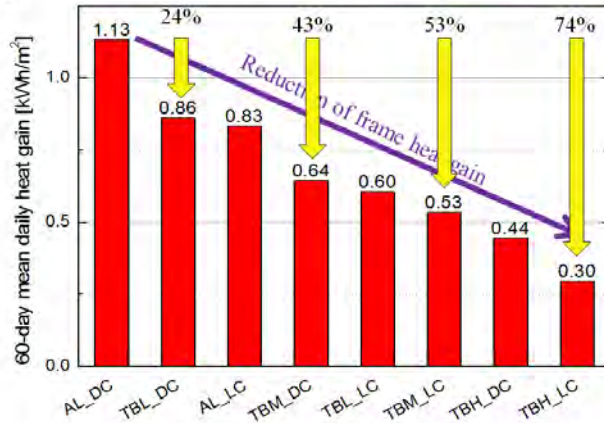

Figure 5: 60-day mean daily heat gain [kWh/m²]

By comparing the average daily heat of the non-thermal broken aluminium profiles in black colour with other thermally broken profiles, we could find that by using light-colour high-performance thermal broken profile the heat gain could reduce by 74%, relating to 0.83kWh/m².

This experiment proves that the solar radiation could be re-radiated to the interior through the absorption by the aluminium profiles. It is also affected by the surface colour and the thermal transmittance value of the profiles. The darker the surface colour, more solar radiation is being absorbed. The higher the thermal transmittance value of the profile, more heat flux per unit area, therefore more heat is transferred from the outside to the inside.

2.3 The relationship between U value and SHGC

In general, like Singapore, the SHGC only considers the centre-of-glazing and is then used to calculate the ETTV. But with reference to ISO 15099, NFRC200 or JGJ/T 151-2008, the solar heat gain coefficient of the frame is:

$$g_f = \alpha_f \cdot \frac{U_f}{A_{surf} \cdot h_{out} + U_f}$$

Equation 4

And the SHGC of the whole curtain wall is:

$$g_{cw} = \frac{\sum g_g A_g + g_p A_p + g_f A_f}{A}$$

Equation 5

The above equation shows that the SHGC of the curtain wall is obtained by the area weighted average method of the solar heat gain from the frame, glass and the opaque panel.

After the conversion between shading coefficient SC and SHGC value, it can be substituted into the ETTV formula to calculate the thermal performance of the building envelope. The above formula shows that the U value and the shading coefficient were directly correlated, in the calculation process, the solar heat gain of the window frame is very important.

3. HIGH PERFORMANCE THERMAL BROKEN WINDOWS

3.1 Simulation analysis

By using the simulation software THERM, calculation of the U value of non-thermal broken aluminium profiles, thermal broken aluminium profiles and Passive Window profiles was done. We further substituted it into equation (4) to obtain the SHGC results as below:

	Non- Thermal Broken Aluminium Profile	Thermally Broken Aluminium Profile	Passive Window Profile
Uf value (W/m ² K)	6.96	2.02	1.13
SHGC	0.18	0.05	0.03

Table 2: SHGC of different aluminium profiles

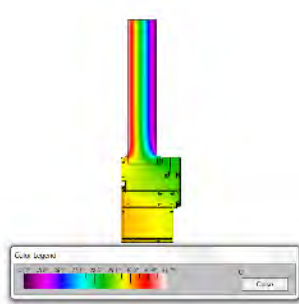

Figure 6: Non-thermal broken



Figure 7: Thermal broken

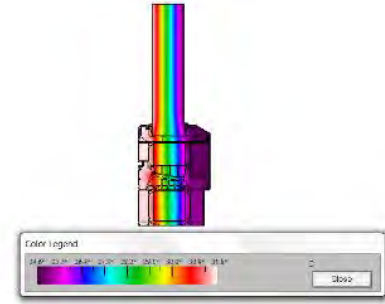

Figure 8: Passive window

The Uf value of non-thermal broken profile is 6.96 W/m²K and the SHGC is 0.18, while the Uf value of thermal broken profile is 2.02 W/m²K, the SHGC is 0.05, the Uf value is reduced by 71% and the SHGC is reduced by 72%. Similarly, the use of Passive windows, compared with the non-thermal broken profiles, Uf values and SHGC can be large reduced by 84% and 83% respectively.

3.2 Thermal performance of different windows

Below we evaluate the possible reduction of heat gain by high performance thermal broken windows. We assumed that other parameters of the windows are fixed, with a the glass to frame ratio is 75%, and with a single open sash.

	Non-thermal Broken Window	Thermal Broken Window	Passive Window
Project Area of the Frame Af		0.5m ²	
Project Area of the Glass Ag		1.5m ²	
Project Area of whole Window Aw		2.0m ²	
Perimeter of glass vision area, lg		4.5m	
Glass Frame ratio		75%	
Solar absorptance of the outside the Frame Surface α_f		0.7	
Outdoor surface heat transfer coefficient h_{ex}		22W/(m ² K)	
Frame Outside Area (m ²) Frame Projected Area (m ²) Asurf/Af		1.2	
U value of Glass		1.6W/(m ² K)	
SHGC value of the glass		0.35	

Linear Thermal Transmittance ψ_g	0.05 W/(mK)	0.11 W/(mK)	0.11 W/(mK)
U Value of the Frame	6.96 W/(m ² K)	2.02 W/(m ² K)	1.13 W/(m ² K)
SHGC Value of the Frame	0.18	0.05	0.03
U Value of the Window U_w	3.05 W/(m ² K)	1.95 W/(m ² K)	1.73 W/(m ² K)
SHGC Value of the Window	0.31	0.28	0.27
ETTV (WWR=1, CF=1)	85.6 W/m ²	74.5 W/m ²	71.4 W/m ²

Table 3: Parameter table of different windows

By the using the same SHGC glass, the results illustrated the following:

1. The SHGC value of window could show reductions of 9.7% and 12.9% by using thermally broken profile and Passive window profile respectively;
2. The ETTV of window could show reductions of 13.0% and 16.6% by using thermally broken profile and Passive window profile respectively.

The above results show that the window frame U value is closely related to the overall thermal performance of a window system. The use of thermal broken aluminium window can reduce the overall envelope heat gain more than 10%. With rational choice of window frame, reasonable configuration, the high performance thermal broken window can achieve the desired energy saving effect for the building.

4. CONCLUSION

The comparison shows that the U value of the window frame is an important factor in influencing the shading coefficient and the solar heat gain of the building envelope.

Today building energy consumption is the major part of Hong Kong total energy consumption and is increasing annually. However, awareness of building energy efficiency is low, while the concept of energy conservation is relatively weak. The primary task of reducing energy consumption can be achieved by increasing the energy efficiency of buildings; and we can start by improving the building envelope thermal performance.

Window frames, although only a small part of doors and windows, contributes significantly to the overall thermal performance of a window. High performance thermally broken window systems can effectively reduce the heat gain through the fenestration and thus reduce the energy consumption of the entire envelope to achieve the desired energy saving effect.

REFERENCES

- [1] ASHRAE. ASHRAE Standard 90-1975 Energy Conservation in New Building Design. American Society of Heating Refrigerating and Air-conditioning Engineers, 1975.
- [2] Building and Construction Authority Code on envelope thermal performance for buildings, 2008.
- [3] Building Authority, HongKong. Code of Practice for Overall Thermal Transfer Value in Buildings, 1995.
- [4] ISO 15099:2003. Thermal performance of windows, doors and shading devices — Detailed calculations[S].
- [5] JGJ/T 151-2008 : Thermal calculation of glass curtain wall for building doors and windows. [S] Beijing: China Architecture & Building Press, 2009.
- [6] NFRC 200:2004. Procedure for Determining Fenestration Product Solar Heat Gain Coefficient and Visible Transmittance at Normal Incidence[S].
- [7] Peng Yang, Shen You-zhu and etc.: Based on LBNL Software to Analysis the Thermal Performance and Numerical Simulation of Building Exterior Window [C] 2016: 2003 Annual Conference Proceedings of Aluminum Door, Window and Curtain Wall, 2016: 222-227
- [8] Wan Cheng Long, Wang Hong Tao and etc.: Research and measurement analysis of ultra-low energy consumption passive house exterior window thermal performance in China, Window Door Façade Expo China Industrial Conference Paper Collection, 2016:214-216
- [9] Li Jin, Liu Jun and etc. Research of Passive House Aluminum Window Use in China [J]. Construction Structure Metal in China, 2016 (04) : 54 – 56

Potentials of Energy Efficiency and Generation Strategies for High-rise Office Buildings in Hong Kong

YU Cong^a, PAN Wei^b

^a The University of Hong Kong, Hong Kong SAR, yucong@connect.hku.hk

^b The University of Hong Kong, Hong Kong SAR, wpan@hku.hk

ABSTRACT

Office buildings are a major building type responsible for a large proportion of the total electricity consumption in Hong Kong where most office buildings are high-rise due to the scarce developable land resources. There are more limitations to the selection of energy saving strategies for high-rise office buildings compared with low or medium ones, as high-rises are associated with more complex design on the fabric, envelope and service systems. It is therefore vital to explore measures for reducing energy consumption of high-rise office buildings.

This paper aims to examine the potential of energy efficiency and generation strategies for high-rise office buildings in Hong Kong, and to develop scenario-based design strategies. A reference building model was first established using a typical real-life high-rise office building in Hong Kong. Using the reference building, the energy consumption was estimated with the aid of the energy simulation tools DesignBuilder and EnergyPlus. The potential of various energy saving and generation strategies was then investigated using the reference building and the tools. The strategies included chiller system selection, daylighting control, cooling setpoint temperature, PV system, and wind system. The results show that adopting water-cooled HVAC type and daylighting control system can reduce approximately 10% and 11% of the total energy consumption, respectively. The cooling setpoint was found to lead to an energy use saving by 4%. The use of PV systems was found to offset 4% of the total building energy use. The wind turbine however was found to have little effect on energy efficiency. The strategies together can help achieve up to 30% of building energy use reduction, yielding an optimised scenario. The findings inform future high-rise energy use parametric research and are useful to engineers for designing energy-efficient office buildings. Future research should also explore building fabric measures in order to maximise energy reduction potential.

Keywords: energy use, energy modelling, high-rise office building

1. INTRODUCTION

Buildings are proved to be the biggest single contributor to total energy consumption in many countries, accounting for as much as half of their primary energy resources (Pan and Garmston 2012). Commercial buildings account for a substantial proportion of energy consumption in Hong Kong. According to the Hong Kong Energy End-use Data published by EMSD (2015), electricity consumption in the commercial sector rose by 19.5% from 84921 Terajoule in 2003 to 101480 Terajoule in 2013. Due to the scarce developable land resources in Hong Kong, the majority of buildings in the city are high-rise; approximately one in five are office buildings, which offer a considerable energy saving potential (Rating & Valuation Department 2000). To realize such potential, it is vital to **examine the existing building's energy performance and make comparison with the estimated energy performance** of buildings with energy saving strategies. There has been increasing pressure on architects and engineers to design more energy-efficient buildings and building services systems (Yu and Chow 2007, Lam, Wan et al. 2008, Pan 2014). However, there is a limited understanding of the selection of energy-saving measures for high-rise office buildings that require more complex designs for both building fabric and building services compared with low or medium-rise counterparts (Pan, Qin et al. 2016).

It is generally accepted that computer energy analysis techniques are valuable design tools for the design and analysis of buildings and building services installations, particularly for large office buildings. DesignBuilder and EnergyPlus are two typical examples **of widely used computer simulation tools for estimating buildings' energy** consumption. This paper aims to examine the potential of energy efficiency and generation strategies for high-rise office buildings in Hong Kong, and to develop scenario-based design strategies. For this research, a typical real-life high-rise office building in Hong Kong was selected to be the reference building for investigating measures that affect energy consumption. Five energy strategies, namely, chiller system selection, daylighting control, cooling setpoint temperature, PV system and wind system, were analysed utilizing the tools DesignBuilder and EnergyPlus.

Integrating the results, the paper presents an optimised scenario with maximised energy use reduction from employing these energy efficient measures and draws conclusions.

2. THE REFERENCE BUILDING

Hong Kong Monthly Digest of Statistics (2016) conducted a survey of investigating the existing commercial buildings. It contains the existing buildings basic information in Hong Kong, for instance, building construction, address, number of storeys, building cost, usable floor area and gross floor area. The most prevailing storeys in Hong Kong were found to be between 20 storeys to 40 storeys through the Hong Kong Monthly Digest. Lam (2000) considered that the main type of high-rise office buildings in Hong Kong is with either square or rectangular configurations. Therefore, a 26-storey office building (Figure 1) with square configurations located in Kowloon was selected as the reference building to represent the typical office buildings in Hong Kong for investigating the potentials of energy efficiency and generation strategies. Due to the limited access to the actual metered energy use data, a top-down approach was adopted to establish the reference energy model by using the end-use energy distributions reported by EMSD (2015). As there is a set of standard energy modelling inputs for office buildings in Hong Kong, the use of this top-down approach was considered practical and effective.

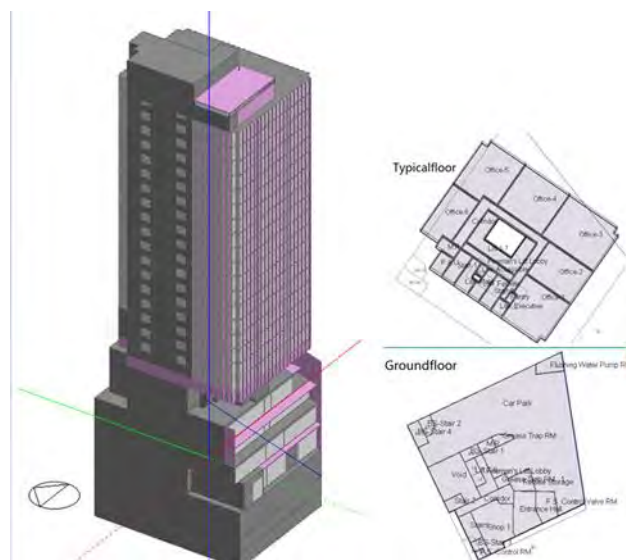

Figure 1: The private office case building and composition of different floors

This building has a total of 26 storeys that the podium layer (1 - 5F) is used for food and beverage and the tower part (6F - 26F) is designated used for offices. The office is designed as core tube type that it has a core area to place lift and lobbies and equipment room surrounded with open office area. This building has the overall area above ground 24698.74m²; underground 4603.43m². The geometric model was built by the architectural drawings and design specifications. The data inputs of the energy model of the prototype were based on the drawings and relevant information provided by the design team, supplemented by the optimisation design and the overall building performance comparison as set in the Performance-based Building Energy Code (PB-BEC 2007). The weather file used in the energy simulation is provided by Energy Plus weather database (CHN_Hong.Kong.SAR.450070_CityUHK.epw). The office is assumed to be opened from 9 am to 6 pm from Mondays to Fridays and from 9 am to 12 am on Saturdays. Occupancy and operation schedules from PB-BEC are used in this study. The lighting of parking is assumed to be on operation all day. The minimum shading coefficient is 0.25. Lighting luminance is 300 Lux for office building according to the Standard for Lighting Design of Buildings (GB50034 2004). The design temperature in summer is assumed as 24°C.

Cooling is provided by a set of centrifugal chillers and no heating is provided. Air Handling Unit (AHU) is adaptable in the spacious space because it provides both fresh air and returned air. All the food areas at 1 - 3F are served by AHU system with variable speed control. However, due to the limited height in the office room, the FCU (Fan Coil Unit) system has smaller size than AHU system. Thus, all the office areas at 6 - 26F are served by FCU system with dedicated outdoor air system. A split-type AC system is provided for the control room since the control room does not have the same schedule compared with other areas. The VRF (Variable Refrigerator Flow) system is

used by management office in 1F and lift machine room in 18/ 19F. Table 1 displays the input parameters of the reference building.

Item	Details
Building Type	High-rise office building
Location	Kowloon, Hong Kong, China
Building Height	112.75m (26 above ground, 3 basements)
U value (W/m ² K)	Opaque Wall 3.3, Below grade walls 1.99, Window 1.57, Opaque Roof 0.39
Curtain wall type	Low-E Glass with SC=0.25, VLT=42
Fresh air rate	Office, lobby, corridor, retail area 10 l/s/person, parking & mechanical room 6 ACH, restroom 15 ACH, kitchen 50 ACH
Equipment power density	Office 25 W/m ² , retail-sales area 15 W/m ² , restaurant 20 W/person
Occupancy density (m ² /persons)	Office 8, lobby 10, restaurant 5, corridor 50
Lighting power density (W/m ²)	Lobby 14, office 17, parking 2, corridor 5, restroom 10

Table 1: Input parameters of the reference building

3. ENERGY USE IN THE REFERENCE BUILDING

The reference building was established through an iterative process and energy simulation and verification drawing on EMSD released end-use energy data and engagement with professionals. The EUI was estimated to be 282.4 kWh/m², and covered in order of significance, cooling electricity (41.9%), fans (23.6%), appliances (17.5%), interior lighting (16.5%), and then pumps (0.4%) (Figure 2).

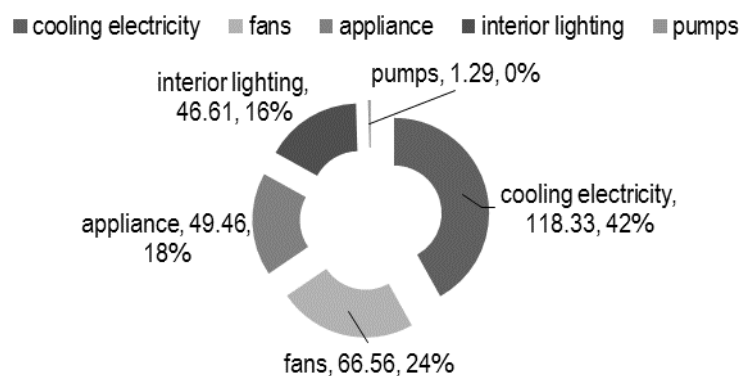

Figure 2: Energy use of the reference building (kWh/m²)

The whole energy use is in agreement with that reported in previous studies, e.g. 259.2 kWh/m² by (Yu and Chow 2007). The total HVAC system consumes 66% of the overall energy use, which reveals substantial energy saving potential. Energy use of appliances is mainly caused by the use of office equipment, such as computers, printers and so on, and also depends on human behaviours with uncertainties to a great extent. The appliances are therefore not considered in the analysis in this paper. Although the proportion of interior lighting is not high (16%), it still has the conservation space by adopting the energy efficiency measures.

4. ANALYSES OF ENERGY EFFICIENT STRATEGIES

Previous studies indicated that the following strategies showed remarkable energy saving potential. Those are chiller system selection, daylighting control, cooling setpoint temperature, PV system and wind system. Ellis and Mathews (2002) estimated that energy savings could be maximum around 70% through the use of better design technologies to coordinate the building demand with its HVAC system capacity. The Hong Kong government, with the support of EMSD, encourages the owners of non-domestic premises to use water-cooled chiller system (EMSD 2015). Yu and Chow (2007) modelled daylighting for offices using Trance 600 and found that applying daylighting strategy will save as much as 41% of the lighting energy use and 16% of the overall building energy use. In the year 2006, the Hong Kong Environmental Protecting Department (EPD 2006) suggested a recommended temperature (25.5°C) of the indoor cooling setpoint temperature to reduce the energy use. There is a belief that

operating at the high end of this range or above it will reduce the total energy use in the office buildings by making the cooling system more efficient. Fong and Lee (2015) indicated that the high-rise office buildings in Hong Kong had the energy saving potentials by adopting PV system. However, based on site survey, the existing office buildings in Hong Kong are normally air-cooled with low temperature and do not utilize daylighting control or energy generation strategies. It is significant to analyze whether these strategies are still applicable in Hong Kong. Therefore, the energy efficiency and generation strategies investigated in this paper are: (1) Chiller plant system optimisation, (2) Indoor air setpoint temperature, (3) Daylighting control, (4) Photovoltaic system, and (5) Wind power generation. The design parameters of these five strategies are listed in Table 2. Table 3 displays the energy saving comparison of five energy saving measures. By adopting these energy efficient strategies, the performance of energy use for the high-rise office building ranged to different extents as detail explained below.

Energy saving strategies	Original	Optimisation
Chiller type optimisation	Air-cooled with COP 3	Water cooled with COP 5
Indoor air setpoint temperature	24°C	26°C
Daylighting control system	No	Yes
PV panels & BIPV	No	Roof (15% efficiency) and facades (4.5% efficiency)
Wind turbine	No	Roof

Table 2: Design parameters of five strategies

	Water-cooled chiller	Indoor air setpoint temperature	Daylighting control	Original	PV system	Wind turbine
HVAC system (kWh/m ²)	157.43 (-15.44%)	171.20 (-8.04%)	177.57 (-4.62%)	186.18 (0%)		
- Cooling	71.45	105.35	110.37	118.33		
- Fans	66.56	64.63	65.91	66.56		
- Pumps	11.46	1.23	1.29	1.29		
- Heat Rejection	7.96	0.00	0.00	0.00		
Interior Lighting (kWh/m ²)	46.43 (0%)	46.61 (0%)	25.03 (-46.30%)	46.61 (0%)		
Interior Equipment (kWh/m ²)	49.34	49.46	49.46	49.46		
Electricity generation (kWh/m ²)	0	0	0	0	-11.64	-1.72
Total End Uses (kWh/m ²)	253.34 (-10.29%)	270.41 (-4.25%)	252.06 (-10.74%)	282.40 (0%)	270.76 (-4.1%)	280.68 (-0.35%)

Table 3: Comparison of energy saving measures

Chiller plant system optimisation (Compared with water-cooled chiller)

Most existing commercial buildings in Hong Kong adopt air-cooled chiller system with a typical COP of 3, which is adopted for the reference building. The government, with the support of EMSD, encourage the owners of non-domestic premises to use water-cooled chiller system by joining Scheme for Wider Use of Fresh Water in Cooling Towers in Air Conditioning Systems for their fresh water cooling towers installations (EMSD 2015). Water-cooled chiller systems are therefore adopted with the COP of 5, which are analysed in comparison with the air-cooled system.

The scenario adopting water-cooled chiller system consumes much lower energy (282.4 kWh/m²) than the reference building adopting air-cooled chiller system (253 kWh/m²). This is mainly because of the significantly reduced (by 65.6%) cooling energy of the water-cooled chiller (71.45 kWh/m²) from that of the air-cooled chiller (118.33 kWh/m²).

Indoor air setpoint temperature (24°C to 26°C)

Theoretically, the higher indoor air setpoint temperature will lead to the lower cooling demand, and thus it will save energy. However, the consideration of the conflict between human comfort degree and energy saving is significant as well. By comprehensive consideration, the recommended cooling setpoint is set as 26°C. The cooling setpoint was found to lead to an energy use saving by 4%.

Daylighting control in office area

Daylight control is an energy management technique that reduces overhead lighting use by utilizing the ambient (natural & artificial) light present in a space and dimming or switching off lighting when sufficient ambient light is present or when space is unoccupied. It is quite useful in the open office area with plenty of windows. Daylighting control is proved to be a good strategy to decrease the **overall building's energy consumption by around 11%**.

Photovoltaic system

The electricity generation of PV system would be closely related to the availability of solar irradiation of a place. In this paper, the building-integrated photovoltaics (BIPV) on facades and PV panels on the roof are investigated. BIPV and PV panels for the reference building are assumed with the efficiency rate of 4.5% and 15% respectively. Seventy-two solar cells in each m-si PV module. The size of the solar cells is 125 mm × 125 mm. Table 4 displays the detail input parameters for PV system at standard testing conditions. The annual cumulative global solar radiations on the vertical walls facing different directions are investigated. The result indicates that the PV system can generate 11.64 kWh/m² electricity annually, which can afford approximately 4% of the overall energy use.

System	BIPV system (facade)	PV system (roof)
Solar cell type	a-si	m-si
Rated power at the maximum power point (P_{mp})	105 W	180 W
Rated voltage at the maximum power point (V_{mp})	30.2 V	35 V
Rated current at the maximum power point (I_{mp})	3.48 A	5.14 A
Open-circuit voltage (V_{oc})	38.8 V	43.5 V
Short-circuit current (I_{sc})	4.3 A	5.53 A
Size of module	1.4 m × 1.1 m × 7 mm	1.580 m × 0.808 m × 50 mm
Temperature coefficients of I_{sc}	0.00559 A/K	0.002765 A/K
Temperature coefficients of V_{oc}	-0.13968 V/K	-0.1479 V/K
Photovoltaic efficiency	6.8 %	14 %

Table 4: The operational data of a-si and m-si PV modules at standard testing conditions (STC) (AM1.5, 1000 W/m², 298 K)

Wind power generation

Wind velocity at the height of wind turbine rotor center can be calculated by $V = V_{TMY}(Z/Z_{TMY})^{1/7}$. Where, V_{TMY} is the wind velocity at the data collection site, here wind velocity in the TMY weather data used, m/s; Z and Z_{TMY} are the wind turbine rotor center height and data collection site height, respectively. The annual average wind speed: 7.3 m/s (113 m) 7.4 m/s (124 m). Detail information is showed in Table 5. The result shows that the wind turbine has little effect on the energy use.

Manufacturer	Windspot
Model	Windspot 3.5kW
Rated power	3.5 kW
Reference annual energy output	18 MWh
Cut-in wind speed	3 m/s
Rated wind speed	12 m/s
Cut-out wind speed	20 m/s
Rotor diameter	4.05 m
Hub height	12 m

Table 5: Details of the small horizontal axis wind turbine (HAWT)

5. CONCLUSION

The reference high-rise office building was established through an iterative process and energy simulation and verification drawing on EMSD released end-use energy data and engagement with professionals. The EUI of the building was estimated to be 282.4kWh/m², and covered in order of significance, cooling electricity (41.9%), fans (23.6%), appliances (17.5%), interior lighting (16.5%), and pumps (0.4%).

Five energy strategies, namely, change of chiller type, daylighting control, increase of cooling setpoint temperature, PV systems and wind turbine, were then investigated. By adopting these strategies individually, the EUI was found to range from 252 to 282.4kWh/m²/year. More specifically, the adoption of water-cooled HVAC type and daylighting control system can reduce approximately 10% and 11% of the total energy consumption, respectively. The cooling setpoint was found to lead to an energy use saving by 4%. The use of PV systems was found to offset 4% of the total building energy use. The wind turbine, however, was found to have little effect on energy efficiency. Thus, **should the four measures (i.e. excluding wind turbine) be adopted, the building's energy use reduction could sum up to 30%**, yielding an optimized scenario. Nevertheless, further energy use reduction can be enabled through addressing passive energy saving factors such as building design and fabric (e.g. envelope, infiltration), which should be explored in future research.

The findings contribute to a better understanding of the energy saving measures influencing energy use in high-rise office buildings and should inform energy-efficient building design in urban contexts. These findings have significant implications for future high-rise energy use parametric research and practices of engineers and architects in both building initial design and retrofit stages.

ACKNOWLEDGEMENT

The work described in this paper was supported by research funding (CICR/01/13) from the Construction Industry Council (CIC) and a grant from the SFC/RGC Joint Research Scheme sponsored by the Scottish Funding Council and the Research Grants Council of Hong Kong (X_HKU711/14). Its contents are solely the responsibility of the authors and do not necessarily represent the official views of the funding bodies.

REFERENCES

- [10] Ellis, M. W. and E. H. Mathews (2002). "Needs and trends in building and HVAC system design tools." *Building and Environment* 37(5): 461-470.
- [11] EMSD (2015). *Hong Kong Energy End-use Data 2015*. EMSD. Hong Kong.
- [12] EPD (2006). t. H. K. E. P. Department, The Government of the Hong Kong.
- [13] Fong, K. F. and C. K. Lee (2015). "Performance analysis of internal-combustion-engine primed trigeneration systems for use in high-rise office buildings in Hong Kong." *Applied Energy* 160: 793-801.
- [14] GB50034 (2004). *Standard for Lighting Design of Buildings*. M. o. C. N. N. o. 2004.
- [15] *Hong Kong Monthly Digest of Statistics* (2016). Statistical Information Services Section Census and Statistics Department.
- [16] Lam, J. C. (2000). "Shading effects due to nearby buildings and energy implications." *Energy Conversion & Management*.
- [17] Lam, J. C., K. K. W. Wan and L. Yang (2008). "Sensitivity analysis and energy conservation measures implications." *Energy Conversion and Management* 49(11): 3170-3177.
- [18] Pan, W. (2014). "System boundaries of zero carbon buildings." *Renewable & Sustainable Energy Reviews* 37: 424-434.
- [19] Pan, W. and H. Garmston (2012). "Building regulations in energy efficiency: Compliance in England and Wales." *Energy Policy* 45: 594-605.
- [20] Pan, W., H. Qin and Y. Zhao (2016). "Challenges for energy and carbon modeling of high-rise buildings: The case of public housing in Hong Kong." *Resources, Conservation and Recycling*.
- [21] PB-BEC (2007). *Performance-based Building Energy Code*. EMSD. Hong Kong.
- [22] Rating & Valuation Department (2000). *Hong Kong property review-2000*, Hong Kong: Government Printer.
- [23] Yu, P. C. H. and W. K. Chow (2007). "A discussion on potentials of saving energy use for commercial buildings in Hong Kong." *Energy* 32(2): 83-94.

Effect of Corridor Design on Energy Consumption for School Buildings in the Cold Climate

ZHANG Anxiao^a, SUN Yanchen^b, HUANG Qiong^c, Regina BOKEL^d, Andy VAN DEN DOBBELSTEEN^e

^a Tianjin University, Mainland China, Delft University of Technology, The Netherlands, zhang anxiao9012@gmail.com

^b Tianjin University, Mainland China, Delft University of Technology, The Netherlands, sunyanchen@tju.edu.cn

^c Tianjin University, Mainland China, qhuang@tju.edu.cn

^d Delft University of Technology, The Netherlands, r.m.j.bokel@tudelft.nl

^e Delft University of Technology, The Netherlands, a.a.j.f.vandendobbelsteen@tudelft.nl

ABSTRACT

This paper discusses the energy impact of corridor design for school buildings in the cold climate of China. Local school buildings were classified into three types in terms of the corridor design patterns. Architectural related parameters of corridors which could have a potential impact on the energy consumption were summarized and discussed, including: form and orientation, temperature control, opaque envelope components, glazing, ventilation and infiltration. The annual heating, cooling, lighting and total energy consumption were compared. Results showed that form and orientation have the most significant influence on building energy consumption while opaque envelope insulation of corridors shows the least effect on energy demand. By combining the most beneficial strategies at each step, this study resulted in a better performing corridor design that increases the energy-saving by around 6% for the double-sided corridor building type and 17% for the one-sided enclosed corridor type of school building respectively.

Keywords: school building, corridor design, energy saving

1. INTRODUCTION

School buildings account for a considerable proportion of public buildings. Research has shown that school campuses are among the major energy consumers and energy conservation enforcement of school campuses would reduce Carbon Dioxide emissions up to 25% (Zhou et al., 2013). There is a large body of research on the relationship between school building design and energy or environmental performance. The focuses have been put on the classroom due to the large proportion of school surface they occupy in school buildings (Perez et al., 2009). However, little attention has been paid to the common area in school buildings such as the corridor space. Their energy consumption also accounts for a certain proportion of the school energy consumption (Pitts and Saleh, 2007). Besides, such common areas play an important role in the ability for students to rest and communicate. **A comfortable common area can have a potential impact on students' study results (Kwong et al., 2009).**

The performance of transitional space in schools did not get a lot of attention from researchers. Though some researchers have investigated specific energy saving measures for transitional spaces like temperature control (Pitts and Saleh, 2007), but other parameters like the geometry or the glazing design of corridors are seldom considered. Furthermore, the relative importance of these strategies on the energy consumption is much less studied. Thus, the effect of school transitional space such as corridors on building energy consumption needs to be studied.

2. METHODOLOGY

The main objective of this study is to find energy-saving solutions for the corridor design of school buildings in the cold climate of China. First, local school buildings were characterized to establish specific school corridor models. Secondly, the design parameters of the corridor space that can have a potential influence on the performance were classified and then tested by category using Designbuilder software (Designbuilder, 2014). Then a sensitivity analysis was done to compare the relative importance of the different strategies. Last, integrated design solutions were defined by combining the strategies that provided the highest energy benefits for the building in each step. These combined strategies were also tested to examine the energy saving potential of corridor design.

School building model

The corridor typologies to be studied were identified based on literature and on the investigation of local school designs in the cold climate of China (Zhang and Li, 2000). In total, three corridor designs were identified (Figure 1): Double-sided corridor (Type A), in which classrooms are on both sides of a corridor, one-sided enclosed corridor (Type B), in which classrooms are positioned on one side of an enclosed corridor, one-sided open corridor (Type C), in which classrooms are positioned on one side of an open corridor.



Double-sided corridor school building (Type A)



One-sided enclosed corridor school building (Type B)



One-sided open corridor school building (Type C)

Figure 1: Classification of three types of school buildings according to corridor design in the cold climate of China

To simulate the three corridor designs in Designbuilder, a rectangular volume was selected as the basic shape since the rectangular shape accounts for a large proportion of school buildings in China. The size and numbers of various rooms were kept identical for each type as shown in figures in Table 1. The U values of external walls, internal walls and roofs were set as 0.35, 1.05 and 0.49 W/m²K separately. Moreover, the zones were assumed to be occupied between 8:00-12:00 & 14:00-17:00 (Monday–Friday). Typical Chinese school holidays including vacations in the hot summer and cold winter accounting for 95 days in a year were considered. In addition, the minimum required illuminance level of classrooms is 300 lux and the corridor and staircase require at least 100 lux (Code for design of school, 2011).

Corridor space characteristics

Corridor design parameters were classified into five categories: form and orientation, temperature control, opaque envelope components, glazing, ventilation and infiltration. A summary of the corridor design variables are presented in Table 1 and introduced as below.

	Double-sided corridor (Type A)	One-sided enclosed corridor (Type B)	One-sided open corridor (Type C)
Configuration.			
Floor plan.			
Orientation.	0°, 90°, 180°, 270° ^a	0°, 90°, 180°, 270° ^a	0°, 90°, 180°, 270° ^a
Corridor width	1.5m ^a , 2.4m ^a , 3m ^a	1.5m ^a , 2.4m ^a , 3m ^a	1.5m ^a , 2.4m ^a , 3m ^a
Temperature control.	16°C-26°C*, 14°C-28°C, 12°C-30°C	16°C-26°C*, 14°C-28°C, 12°C-30°C	-
Wall insulation.	0.35 ^a , 0.30, 0.25 ^b W/m ² K	0.35 ^a , 0.30, 0.25 ^b W/m ² K	-
Roof insulation.	0.49 ^a , 0.35, 0.15 ^b W/m ² K	0.49 ^a , 0.35, 0.15 ^b W/m ² K	-
Glazing type.	Single glass, double glass*, triple glass, double low-e glass	Single glass, double glass*, triple glass, double low-e glass	Single glass, double glass*, triple glass, double low-e glass
Window to wall ratio of external surfaces.	20%, 30%, 40%*	20%, 30%, 40%*	20%, 30%, 40%*
Mechanical ventilation.	10, 19*, 30 m ³ /h·p	10, 19*, 30 m ³ /h·p	-
Infiltration.	0.75, 1.0*, 1.5 ac/h	0.75, 1.0*, 1.5 ac/h	-

* The base case settings of the reference model.
^a Mean value of different periods of school design in China from the 1980s to the present (Wang, 2007).
^b Best practice building from Designbuilder (Designbuilder, 2014).

Table 6: Three school building models and investigated corridor design parameters

The four principal orientations: 0° (south), 90° (west), 180° (north), and 270° (east) were considered. The orientation variations were obtained by rotating the whole building clockwise. The width of corridor were set as 1.5m, 2.4m and 3m, which represent the mean value of three periods (before 1980, 1980s, 1990s to now) of school design in China (Wang, 2007). In accordance with the code for school design (Code for design of school, 2011) the standard temperature range of corridors in schools is 16°C-26°C. Two of these ranges for internal temperature in the enclosed corridor spaces were also simulated with following values: 14°C-28°C and 12°C-30°C. This strategy is inapplicable for the open-sided corridor building type. For Types A and B, the U values of external corridor walls were changed to 0.30 and 0.25 W/m²K, and the U values of roof insulation changed to 0.35 and 0.15 W/m²K. The double glazing was set as the base case of the experiment, and then replaced by single glazing, triple glass and low-e double glazing. Table 2 shows the different characteristics of each glazing type. For Type A and B, the variations were applied to the exterior corridor walls, and for Type C changes were applied to the external walls of the classrooms adjacent to corridor. The range of exterior window to wall ratio was 20% to 40% according to local standards (Code for design of school, 2011). Lastly, different mechanical ventilation rates combined with various basic infiltration rates for enclosed corridors were also simulated for Types A and B.

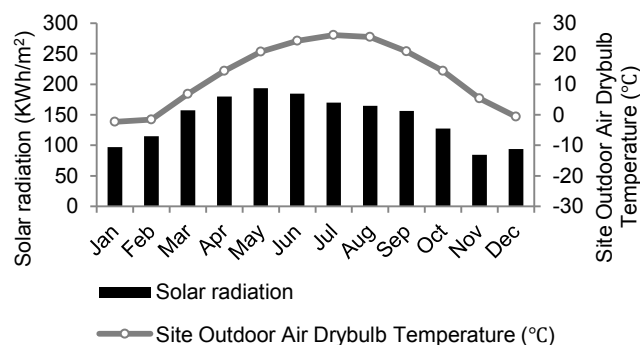

Figure 2: Yearly solar radiation and outdoor air temperature of Tianjin

Glazing description	Solar transmittance	U-value (W/m ² K)
Type A. [Sgl: Clr 6 mm]	0.82	5.78
Type B. [Dbl Clr 6mm/13mm Air/6mm]	0.70	2.70
Type C. [Trp: Clr 6mm/6mm air/6mm/6mm air/6mm]	0.61	2.13
Type D. [Dbl LoE (e2=0.1): Clr 6mm/13mm Air/6mm]	0.57	1.76

Table 7: Characteristics of the different glazing types

Climate data

This study employed the climate data of Tianjin (39.13N, 117.20E) in China, known as a cold climate city based on the climatic classification of Köppen–Geiger. The solar radiation and outdoor dry air temperature are presented in Figure 2.

3. RESULTS AND DISCUSSION

3.1. Effect of each corridor design parameter

Figure 3 shows the influence of form and orientation on the energy demand of school buildings. As expected, Type C consumes the least energy in most cases with no extra air conditioned corridor space, while Type B has the highest energy demand in all cases. Moreover, buildings with 0°(south) and 180°(north) rotation angle show less energy use than other orientations. This is explained by the significant variation in cooling energy demand. For heating and lighting, there are only small variations. Considering corridor depth, the energy demand increases steadily as the corridor width increases except for Type C where the effect is marginal. In addition, it can be observed that for the two enclosed corridor types (Type A and B), the energy variation can primarily be attributed to the increased energy demand of the corridor itself (Figure 4).

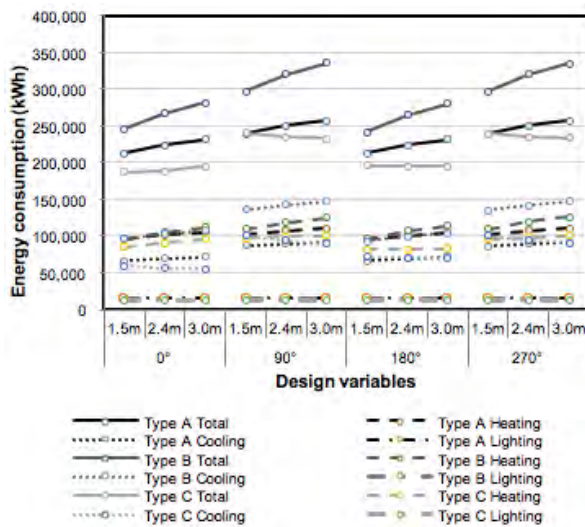

Figure 3: Annual energy consumption for different forms and orientations

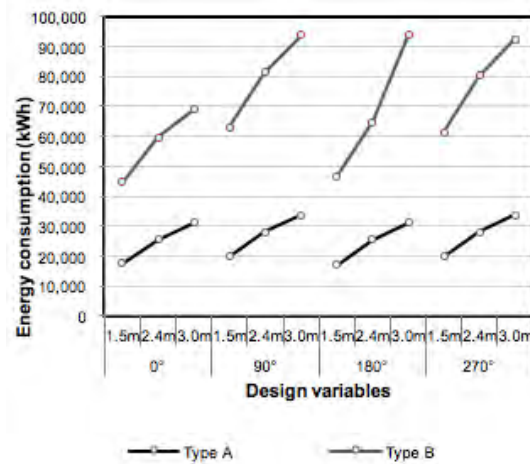

Figure 4: Annual energy demand of corridor space for different forms and orientations

Figure 5 shows that building energy demand decreases with the increase of the allowed temperature range in the corridor; however the trend is much more apparent for Type B but becomes less obvious for Type A. It can be explained by the fact that the corridors in Type A have less interfaces connected to the outside and it therefore becomes easier to maintain the indoor temperature. Figure 6 shows that annual energy savings of corridor space can reach 29,000 kWh for Type B but only 11,000kWh for Type A.

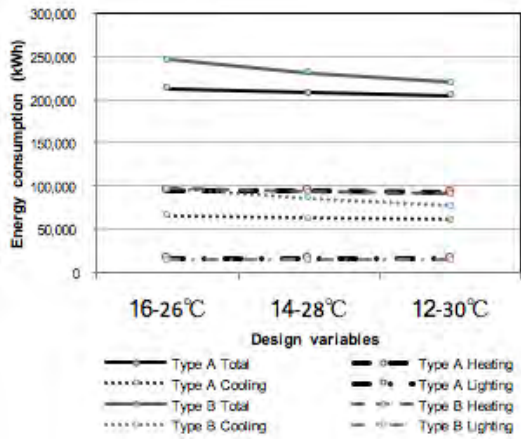

Figure 5: Annual energy consumption for different temperature control

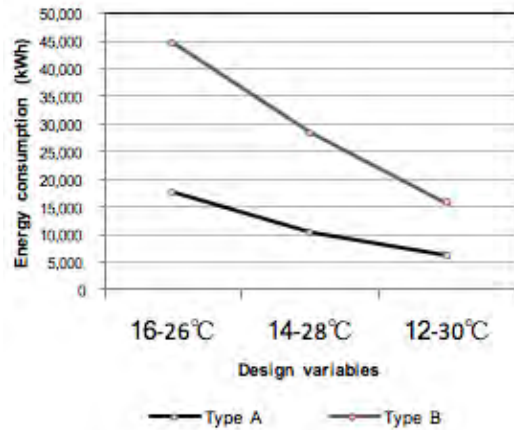

Figure 6: Annual energy demand of corridor space for different temperature control

For opaque envelope component design (Figure 7 and Figure 8), the change in building energy demand is only marginal and does not appear to be affected by varying the U values for corridor walls and roofs. This result suggests that simply increasing corridor wall and roof insulations regardless of other parameter designs may not lead to expected energy savings in the cold climate of China.

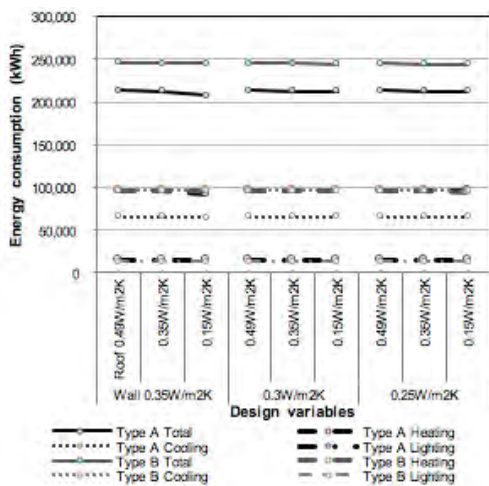

Figure 7: Annual energy consumption for different opaque envelope designs

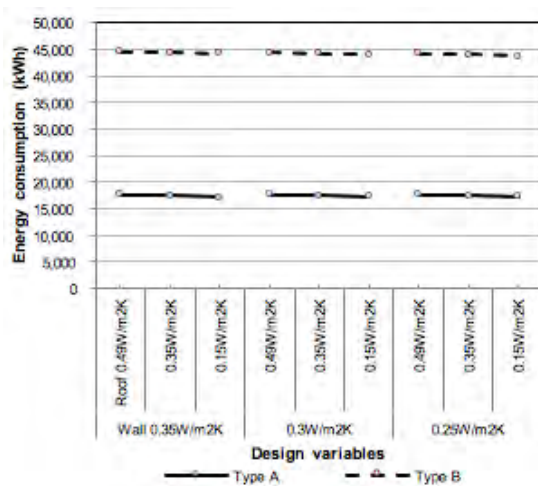

Figure 8: Annual energy demand of corridor space for different opaque envelope designs

Figure 9 shows the effect of various glazing ratios and types on the energy demand. Low-e double glazing performs slightly better than the other three glazing materials for Type B. But it has almost no effect for Type A and C. Moreover, for Type B and C, heating energy demand increases when the WWR decreases while cooling energy demand steadily decreases with the decrease of WWR. This leads to a marginal decrease of the total energy demand of Type B and a slow energy increase for Type C when the WWR decreases. Furthermore, Figure 10 shows that the energy savings with the decrease of the window to wall ratio is more obvious in low performance glazed rooms (double and single glazing) but becomes less significant in high performance glazed rooms (triple and low-e glazing). In addition, for Type A the energy variation in all aspects is negligible due to much less window area of the corridor space.

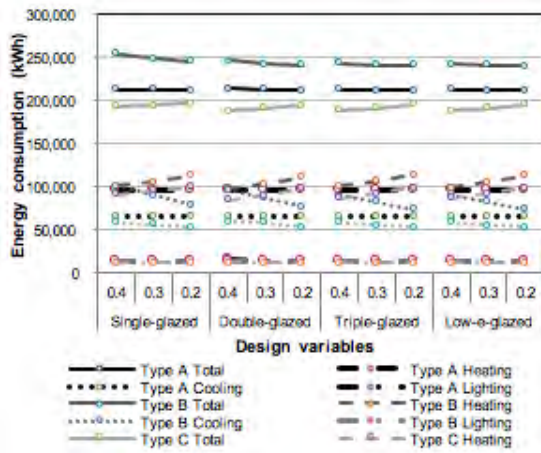

Figure 9: Annual energy consumption for different glazing

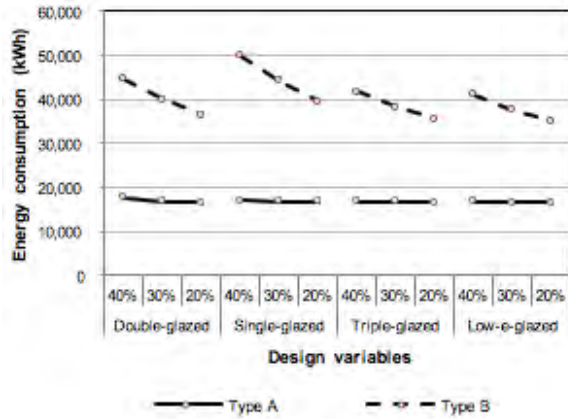

Figure 10: Annual energy demand of corridor space for different glazing

Figure 11 and Figure 12 show that both the total building energy demand and the corridor energy demand increase steadily as the ventilation and infiltration values increase. The reason is that the heating energy growth rate is larger than the decrease rate of cooling energy demand. In winter, a higher air exchange rate allows more cold air into the building, thus leading to the increase of heating energy demand. In contrast, in summer, a higher air exchange can dissipate indoor heat more quickly to the outside resulting in a lower energy demand.

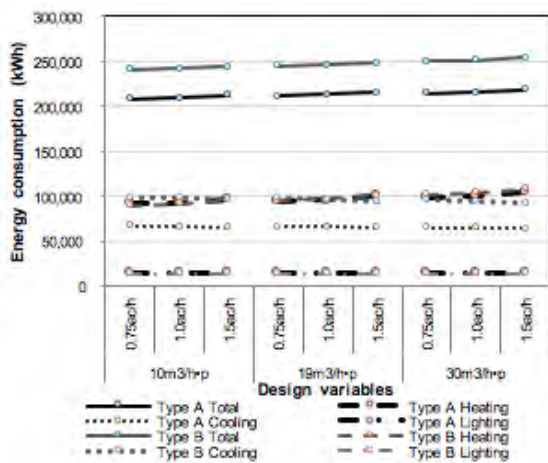

Figure 11: Annual energy consumption for different ventilation and infiltration

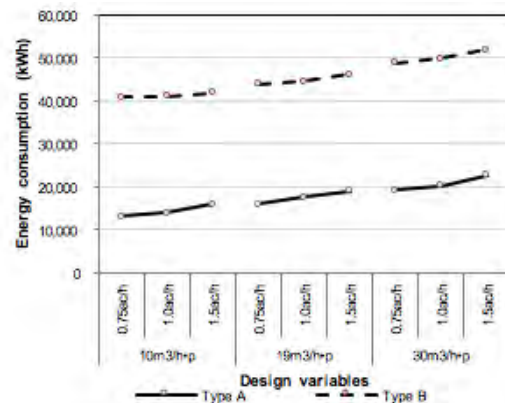

Figure 12: Annual energy demand of corridor space for different ventilation and infiltration

A sensitivity analysis was set up in order to understand the influence of each corridor design variable series. The total building energy consumptions for five design series were summarized and displayed using a boxplot shown in Figure 13. Form and orientation of corridors has the highest effect on total energy consumption for all building types especially for Type B, of which the energy variation can be 93,000kWh. This indicates that inappropriate design of form and orientation may result in very high energy consumption. Contrary, opaque envelope design results in a minimal energy change. Both glazing ratio and the corridor material have a relatively larger influence on the total energy demand of building types B and C while the effect on Type A is marginal. In addition, temperature control in corridors is more influential for Type B whereas the ventilation and infiltration strategy has a similar modest effect on building types A and B.

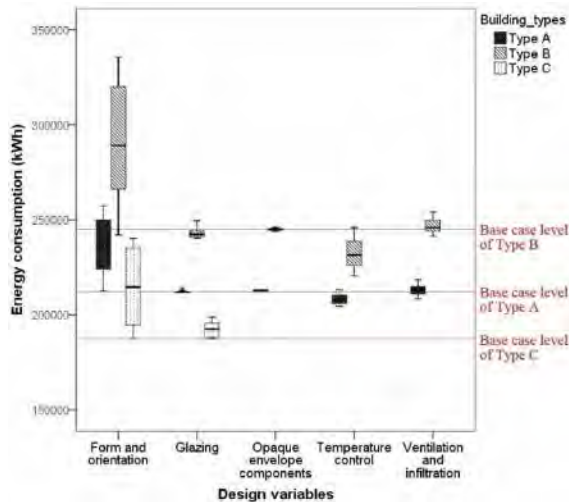

Figure 13: The relative importance of corridor design variables

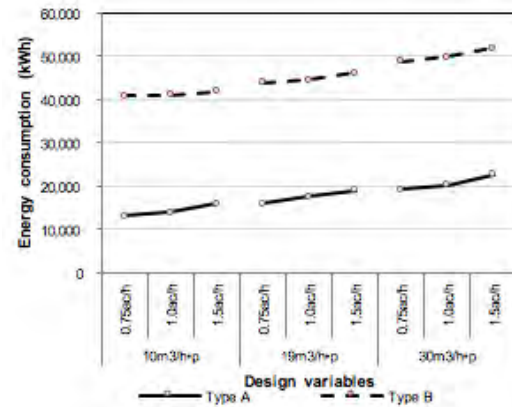

Figure 14: Comparative energy analyses of the optimized design and the basecase design

3.2. Integration of corridor design strategies

According to the results obtained from the previous analyses, an integrated design solution was defined. The final combination of the design of the corridor was selected based on the strategies that provided the highest energy benefits for the building in each step. Comparing the results of the optimized design to the base case shows that the strategies are quite effective. The combination of energy-saving measures reduces the total energy consumption by 6% for Type A and 17% for Type B (Figure 14). It is noteworthy that for Type C the base case has the best energy performance parameters thus there is no energy variation for the optimized design.

4. CONCLUSION

In this study, the effect of corridor design parameters on building energy demand was assessed for three types of school buildings in cold climates. Considered design strategies are: form and orientation, temperature control, opaque envelope components, glazing, ventilation and infiltration. The main findings of this study are as follows:

- Generally, Type C consumes the least energy annually while Type B has the highest energy demand.
- Form and orientation of corridors can significantly affect the total building energy consumption. Buildings with 0° and 180° rotation angle perform better than other orientations. Narrow corridors have the best performance for Type A and B while the effect is only marginal for Type C.
- Considering glazing, we found that corridors equipped with a 20% WWR of low-e double glazing results in the highest energy-savings for both Type A and B. For Type C a double glazing with a 40% WWR has the lowest energy demand. Moreover, the influence of glazing on the building energy consumption is larger for Type B and C whereas the effect on Type A is marginal.
- The design with the widest temperature range and the lowest ventilation and infiltration rates can achieve the minimal building energy consumption. However, temperature control brings more energy benefits for Type B than A while ventilation and infiltration strategy has a similar, modest, effect on both types.
- The design of the opaque envelope component for corridors has little effect on the energy demand.
- Finally, the integration of the corridor design solutions offers a saving in total energy by around 6% and 17% for Type A and B respectively. For Type C, the base case has the best energy performance.

This study indicates that corridor parameters should be carefully addressed when designing school buildings. Proper design of form and orientation combined with other elements, such as glazing, temperature control, ventilation and infiltration will noticeably reduce building energy demand. Further research will try to clarify other corridor design parameters like shading which could also have potential effect on the energy consumption.

ACKNOWLEDGMENTS

This research was funded by the National Key Research and Development Program of China (Grant No.2016YFC0700201) and the National Natural Science Foundation of China (Grant No.51338006).

REFERENCES

- [1] Code for design of school (GB50099—2011) [M], 2011. Beijing: Guangming Daily Press, pp.40-51.
- [2] DesignBuilder Software Limited, 2014. London: DesignBuilder EnergyPlus simulation documentation for DesignBuilder v4.3 [online].
- [3] Kwong Q. J., Adam N. M., Tang S. H., 2009. Effect of environmental comfort factors in enclosed transitional space toward work productivity [J]. *American Journal of Environmental Sciences*, 5(3), pp.315.
- [4] Perez, Y. V., & Capeluto, I. G., 2009. Climatic considerations in school building design in the hot-humid climate for reducing energy consumption. *Applied Energy*, 86(3), pp.340-348.
- [5] Pitts, A., & Saleh, J. B., 2007. Potential for energy saving in building transition spaces. *Energy and Buildings*, 39(7), pp.815-822.
- [6] Wang X., 2007. The study on the constitution and design of the contacting space in the urban elementary school. Thesis (MSc). Xi'an University of Architecture and Technology, pp.55-57.
- [7] Zhang, Z., Li, Z, 2000. Architectural design of primary and secondary schools[M]. Beijing: China Building Industry Press.
- [8] Zhou, X., Yan, J., Zhu, J., et al., 2013. Survey of energy consumption and energy conservation measures for colleges and universities in Guangdong province [J]. *Energy and Buildings*, 66, pp.112-118.

Session 4.5: Performance Review of Green Buildings (2)

The Importance of Understanding The Material Metabolism of The Built Environment

Danielle DENSLEY TINGLEY^a, Hadi ARBABI^b, Michael DURKIN^c

^a The University of Sheffield, United Kingdom, d.densleytingley@sheffield.ac.uk

^b The University of Sheffield, United Kingdom, harbabi1@sheffield.ac.uk

^c The University of Sheffield, United Kingdom, mdurkin1@sheffield.ac.uk

ABSTRACT

Construction materials are a crucial part of our built environment, but whilst the energy use of buildings is often discussed, rarely is their material consumption. Furthermore, with increasing populations and urbanisation, demand for these materials continues to increase, and in turn, so will the embodied environmental impacts created from the extraction, processing, transport and maintenance of these materials. Shorter building lifetimes are also becoming more prevalent, in part due to densification in urban areas. This creates both wasted materials and embodied impacts. A suggested greenhouse gas mitigation strategy is therefore to extend the lifetime of materials/components, e.g. through reuse, in order to displace the need for new materials and their associated impacts.

However, this calls for a new way of thinking about the built environment, it becomes a system of stocks and flows, where the output flows should be redirected into inputs. However, this requires a much greater understanding of this system, which is in essence the material metabolism of the built environment. To date, research in this area has largely focused on single buildings, and techniques such as design for deconstruction and reuse that seek to improve the availability of reused materials, this could be thought of as a circular economic approach. However, for a true assessment of circular economic potential, a single building is not sufficient, as it provides a limited feedstock for future buildings. To capture the full extent of flow interactions, a wider system should be investigated – that of a neighbourhood/city - enabling better identification of the interdependencies that exist and potential synergies to be made between these flows, across multiple scales. This paper presents the background literature and an initial scoping exercise of such an assessment, focusing on a neighbourhood in Sheffield, England.

Keywords: circular economy, material metabolism, embodied energy

1. INTRODUCTION

With the Paris agreement at COP21 there was a global consensus to act on climate change, and to mitigate greenhouse gas emissions. All countries in the agreement must regularly report on their emissions, and define **their 'Nationally Determined Contribution' (NDC), with the aim that temperature rises will be kept well below a 2 degree rise** (United Nations, 2006). As countries ratify the agreement and propose their NDC targets they will need to be implementing mitigation strategies that maximise all opportunities. Cities account for 75% of global greenhouse gas emissions, so will likely be the focus of these strategies (UNEP, 2016). Transport emissions and those from energy use in buildings are two commonly targeted areas. However, emissions associated with the materials that construct cities are rarely considered, these emissions are termed embodied and include all those emissions attributed to material extraction, processing, transport, manufacturing, maintenance and end of life. The carbon dioxide associated with the production of the steel and cement that goes into the built environment contributes at least 3.2 GtCO₂/year (estimated from Allwood et al. 2012). Thus, to maximise potential reductions, **material choices and construction strategies should be a part of all countries' greenhouse gas mitigation strategies.** Hand in hand with this, is a need to preserve natural resources, which the built environment has a huge draw on. If materials in the built environment are thought about as a system then there are three key components, the inputs, the stock (those materials in-use) and the outputs, which are frequently thought of as demolition waste. This system could be termed the material metabolism of the built environment and could be studied at many different scales, from neighbourhood, to city, to country. If the environmental impacts of material metabolisms are to be reduced, then a good understanding of the volume and types of materials is required throughout the system. This would also open up the opportunity to understand the potential for redirection of material flows, turning outputs into inputs.

This approach has most recently been termed a circular economic approach, as championed by the Ellen MacArthur Foundation (2015), where the emphasis is on maintaining the asset value of resources. Keeping materials in circulation for as long as possible should reduce the requirement for new materials and thus their associated embodied impacts. This approach has been successfully deployed where product sharing/leasing is beneficial, such as tool sharing (Ellen MacArthur Foundation, Unknown date), products which have a relatively short life span have also been identified as a priority and studied, where examples include mobile phones. (Ellen MacArthur, 2012). However, the longer life spans in the built environment do present some challenges, particularly around traceability and evolving standards. There is also currently little understanding of the material stock in sufficient detail to understand circular economic potential.

This paper presents a summary of existing research on the application of the circular economy in the built environment, as well as an overview of analysis techniques that could be applied and adapted to understand circular economic potential at a neighbourhood scale. A pilot case study is then summarised to demonstrate the potential of the approach.

2. STATE OF THE ART

There are two key areas of existing research that contribute to this idea of understanding and optimising the material metabolism of the built environment: (1) research that explores circular economic approaches in construction – these ideas could be applied to optimise the system; and (2) material flow analysis of the built environment as these methods can be applied to quantify system inputs, outputs and stock. The following two sub-sections provide a summary of some of the key literature in these areas.

2.1 The circular economy in construction

The circular economy encapsulates a series of different ideas that focus on moving away from linear waste streams to closed loop, circular systems, effectively prioritising the higher levels of the traditional waste hierarchy, such as reuse. A key distinction of the circular economy as outlined by the Ellen MacArthur Foundation (2015) is the emphasis on maintaining asset value and explicit separation between biological and technical material streams. **The introduction of a 'share' resources/products to the system is also new** when compared to the traditional waste hierarchy, and could be applied to the sharing or co-occupancy of space in a built environment context or potentially leasing of a product or service. The technical side of the Ellen MacArthur Foundation diagram (2015) has the following strategies in order of priority: share, maintain/prolong, reuse/redistribute, refurbish/remanufacture and recycle. These strategies aim to keep resources in circulation at a high a value as possible.

Introduction of a circular economic approach into construction can be seen at a building level, as identified in the case studies explored by Cheshire (2016). Magdani (2016) also outlines a building level approach taken at BAM Construct UK, discussing their first circular project, Brummen Town Hall in the Netherlands. This project was particularly suited to this approach as the client wanted a building that would last 20 years, but occupancy was uncertain after this time frame. This meant that the project was designed for deconstruction and material reuse, so that elements could be easily separated at end of life, elements such as structural timber could be returned under a contract to the suppliers, retaining value (Magdani, 2016).

A broader country wide approach to introducing the circular economy in construction is suggested by Esa et al. (2016), who explore strategies to manage construction and demolition waste in Malaysia from a circular economic approach. A review of existing research on the reduction of construction and demolition waste is conducted, using this as a basis for the development of a theoretical framework to introduce a circular economy that works across scales (Esa et al., 2016).

However, whilst a circular economic approach could be introduced to simply prioritise and manage construction and demolition waste, for the opportunities to be most clearly recognised it would be useful to have a clear understanding of existing stocks of materials and to estimate the circular economic potential of these. Thus, when a decision is taken whether or not to demolish, the circular economic value would be known, which could in turn influence the demolition strategy, so for example, if a high reuse potential was identified, the building might be systematically deconstructed to facilitate maximum material/element salvage with minimal damage. Literature to date has not explored circular economic potential of neighbourhoods or cities. However, the academic fields of

urban metabolism and material flow analysis are applied in order to understand material metabolisms, although this is often at high level. The next section presents an overview of research in this area.

2.2 Material flow analysis in the built environment

This section summarises some of the key studies that have conducted material flow analyses of the built environment in order to improve understanding of material metabolism. The global growth in demand for materials, from 1900-2005, was estimated by Krausmann et al. (2009). They show that the pace of use of materials has increased, and predict that due to the relationship between the demand for materials and economic development there will be a sharp rise in material demand from developing countries as they grow their economies. Tanikinawa et al. (2015), Ortlepp et al. (2015) Brattebo et al (2009), Wang et al. (2015), Huang et al. (2013) and Fernandez (2007) take a country level approach to assess the material metabolism (or elements of it). Whereas, Wiedenhofer et al. (2015) take a regional approach, Rosado et al. (2016) focus on the material metabolism of cities, and Marcellus-Zamora et al. (2016) take a more neighbourhood approach, exploring a 3km² area of Philadelphia. There are however methodological similarities across these. Tanikinawa et al. (2015) provide a comprehensive analysis of the different material flow analysis methods that have been used to assess material stocks, categorising these into bottom-up accounting, top-down accounting, demand-driven modelling and remote sensing approaches. Their definitions can be summarised as follows: bottom-up accounting is a snap-shot inventory of objects within a defined area; top-down accounting uses time series, statistical data to follow material inputs, stocks and outputs within a system; demand driven modelling explores the demand for materials for certain end uses over time, using indicators such as population to model future demand; finally, remote sensing pinpoints areas of human activity and associated stocks using satellite based data, making it particularly useful for areas with insufficient statistical data.

A bottom up approach is taken by Tanikinawa (2015) to estimate the historical material stocks in the built environment of Japan, mapping the masses of materials across the country, and highlighting the build-up in stock of construction materials such as cement and aggregate. Ortlepp et al. (2015) calculate material composition indicators, extrapolating these with a bottom up approach that estimates floor areas for non-domestic buildings in Germany, in order to estimate total material stocks in **non-domestic buildings in Germany**. **Ortlepp do highlight 'that greater knowledge is required of the quantity and quality of materials within the built environment in order to calculate output flows accurately and thus to support resource recovery', this is indeed is key if the circular economic potential of material stocks is to be assessed.** Brattebo et al. (2009) take a more top down approach, supplemented with demand modelling to explore the energy and material metabolism of the building stock in Norway, focusing on residential stock and road bridge stocks, mapping historical use and scenario modelling future options. The use phase was shown as the dominate area when life cycle energy is estimated for these residential stocks. Associated masses of concrete and wood stocks and flows are also estimated, although as this is total mass, without use type there is insufficient detail to estimate circular economic potential.

There are a series of studies that investigate the material metabolism of China, with Wang et al. (2015) estimating **the iron and steel stocks throughout China's economy, including the construction sector**. They combine bottom-up sampling with top down mass balancing, concluding that reinforced concrete construction was the major driver for stock growth, but only a fraction of these stocks are currently recovered at end of life. This is particularly troublesome when the circular economy is considered as the value of materials is not being maintained when buildings reach the end of their life. In reality, with current design approaches, the best circular economic outcome for reinforcement steel would be to separate from concrete contamination and recycle the scrap in electric arc furnaces. Huang et al. (2013) take a broader approach, combining top down and demand modelling to estimate the material demand of construction in China, suggesting that the demand for iron ore and limestone will begin to decrease after 2030. They also suggest that increasing building lifetimes and recycling demolition material would reduce the demand for new material. This starts to come in line with a circular economic approach, although the data resolution is insufficient for a full assessment that incorporates reuse potential. An earlier study by Fernandez (2007) also estimated the material demand of new construction in China, assessing the material intensity of three major building types and scaling to estimate demand. The circular economy is also explicitly addressed in this work, suggesting two key areas to target (1) building design and (2) urban planning. Fernandez (2007) stresses the need to analyse the **metabolism of cities, and suggests that 'material and energy flows are tracked, recorded, and used to develop future targets'**, it is also suggested that this type of analysis should be used to inform city planning.

Wiedenhofer et al. (2015) model the material metabolism of residential buildings and transport networks in the EU25, using a dynamic bottom-up modelling strategy. They suggest that for non-metallic minerals, maintenance-related inputs are significant, varying between 34% and 58% of domestic material consumption. They also highlight the significance of recycling, suggesting that if all recycled materials are used for stock maintenance they could account for 75% of this input demand.

Rosado et al. (2016) take a city wide, top-down approach to the material metabolism, analysing historical use in three metropolitan areas in Sweden. They highlight the problem that 80% of resources consumed are non-renewable, thus requiring a circular economic approach to this material to maintain value. The role of recycling to reduce the demand for import of materials and to retain non-renewable resources is also emphasised. However, **they state 'there is an imbalance between the types of materials consumed and stocked, which limits the proportion of the consumption that could potentially be recovered by recycling'** (Rosado et al., 2016).

Existing material flow analysis studies have predominately focused on the recycling potential of stocks when considering end of life scenarios. This is appropriate as the majority of studies estimate masses of different materials, so recycling potential can be estimated, whereas the preferred circular economic strategies, which maintain higher value of material require a more detailed understanding of the material metabolism. To ascertain opportunities to prolong building life, or reuse elements a much more detailed understanding is required of individual buildings, for example what is the construction technique, how are elements joined together, what is the age of the building and how does this influence the former details. Creating this understanding will require multiple datasets and combined material flow analysis approaches. The next section gives an overview of a pilot study conducted in order to explore and test the validity of this approach.

3. CASE STUDY ASSESSMENT

A bottom up approach was taken to conduct a material flow analysis on Walkley, a neighbourhood of Sheffield in the UK, with an emphasis on using existing, freely available data. Two main datasets were utilised: Light detection and ranging (LiDAR) and digimap, and Geographic Information System (GIS) software was used to handle and manipulate the data. LiDAR uses a pulsed laser to measure variable distances, the dataset used from the UK Environment Agency was collected from the air, and provides terrain mapping, which is typically used for flooding analysis (Environmental Agency, 2016). By subtracting the Digital Terrain Model from the Digital Surface Model, a dataset can be created which shows all objects above ground level, including buildings and vegetation. When this data set is combined with digimap, which gives geospatial data from ordnance survey, building massing can be derived. It was found from spot surveys that LiDAR provides better height data than digimap, so combining these two datasets gives a more accurate building stock massing. An example output showing a highlighted street, which was studied in detail, is shown in Figure 1.

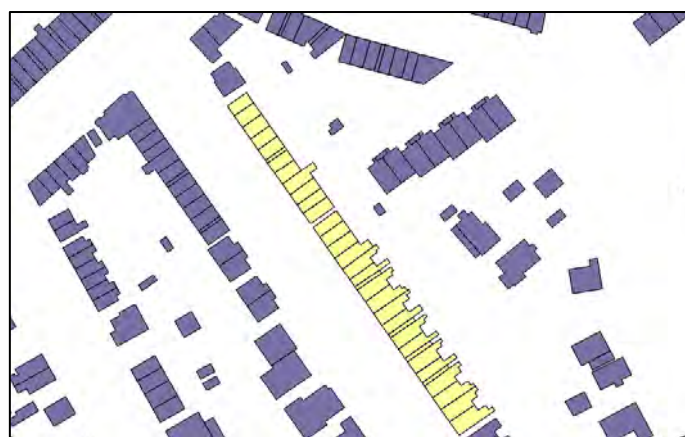

Figure 40: Example mapping output, with the street selected for detailed assessment shown in yellow.

Walkley, the case study neighbourhood, consists of largely low-rise residential buildings, the age profile of the housing in this area is shown in Figure 2. This shows that the housing stock in the area is relatively old, with 75% of the housing constructed pre-1925, 3% 1925-1955, and 22% post 1955. The street under assessment consists

of brick construction. The GIS model was used to estimate the total volume of bricks in this street (see Durkin & Densley Tingley, 2016 for details of this calculation and the associated assumptions). The number of bricks in this street was estimated at 475,000. Norby et al. (2009) assess criteria for brick reusability, which is largely dependent on mortar type, Table 1 summarised their findings. If the age profile of the area is assumed to be reflective of this street, an estimated 364,800 bricks could be salvaged for reuse. Considering the value of this future resource, the price of a new brick in the UK is approximately 75p, so this asset of bricks can be valued at £273,600, and when using current embodied carbon factors, equates to an expended embodied carbon of 200,640 kgCO₂.

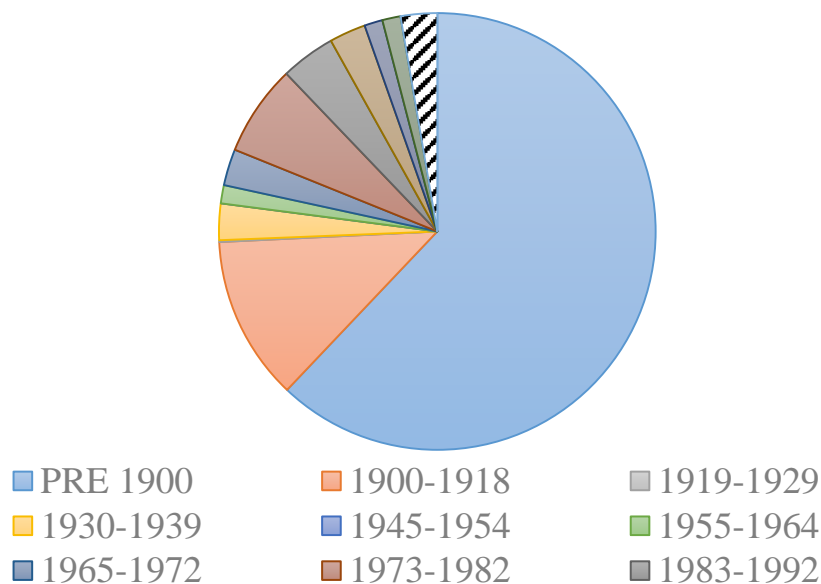

Figure 41: Housing Stock Age Profile, data taken from Consumer Data Research Centre (2016)

Age	Mortar types in Europe	% Brick Reusability
Pre-1925	Likely to be lime mortar	100%
1925-1955	Could be lime, cement, or a mixture	60%
Post-1955	Likely to be cement	0%

Table 1: Mortar Types in Europe and Brick Reusability Assumptions

4. CONCLUSIONS

This paper has summarised some of the key literature on the use of the circular economy in the construction sector, and has reviewed a range of material flow analysis techniques to ascertain the state of the art in these areas and explore their current limitations. A pilot case study on a street in Walkley, Sheffield is then conducted to test a bottom-up, remote sensing method that seeks to gather information at a high resolution. This pilot case study demonstrates the potential of this approach to develop a detailed understanding of the material metabolism of a neighbourhood, and estimate its circular economic potential. Further work will seek to develop this approach, reducing the number of assumptions required, expanding to time series data and estimating the uncertainty in results. The potential for automation of material recognition will also be explored. Furthermore, additional datasets, for example planning information will be sought, testing their use and integration into GIS to provide further detailed information on the building stocks. The current approach focuses on the façade materials, but if this is combined with material intensity estimates, such as those used by Ortlepp (2015), a greater understanding of the whole material metabolism could be developed. Although defining material use type e.g. steel reinforcement, steel I-Beam will be required so the range of circular economic potential can be assessed. By advancing techniques to develop a detailed understanding of the material metabolism of cities more strategic decisions can be made about **a neighbourhood's building stock, enabling the value of resources to be maintained at the highest level possible**, and environmental impacts from new resource use reduced. This paper is the first step in a piece of work to generate a detailed understanding of these material metabolisms and thus shape more strategic use of existing and new buildings.

REFERENCES

- [1] Allwood, J., & Cullen, J. 2012. Sustainable Materials with both eyes open. UTI Cambridge Ltd: Cambridge.
- [2] Brattebo, H., Bergsdal, H., Holck Sandberg, N., Hammervold J., and Muller, D.B. 2009. Exploring built environment stock metabolism and sustainability by systems analysis approaches. *Building Research and Information*, 37(5-6), 569–582. DOI: 10.1080/09613210903186901
- [3] Cheshire, D. 2016. *Building Revolutions: applying the circular economy to the built environment*. RIBA Publishing. ISBN: 9781859466452
- [4] Consumer Data Research Centre. 2016. Dwelling Age Group Counts (LSOA). Available at: <https://data.cdrc.ac.uk/dataset/house-ages-and-prices/resource/4f1956b2-3128-4297-ba97-059e1fbc1fcc> [accessed 04/09/16]
- [5] Durkin, M., & Densley Tingley, D. 2016. Applying material flow analysis to estimate surface areas of housing stock in Sheffield for reusing material or retrofitting insulation. Conference Proceedings, Government and Housing in a time of Crisis, Policy, Planning, Design and Delivery, Liverpool 8-9th September 2016.
- [6] Ellen MacArthur Foundation, 2012. In-depth: mobile phones. Available at: <https://www.ellenmacarthurfoundation.org/circular-economy/interactive-diagram/in-depth-mobile-phones> [accessed 10/01/17]
- [7] Ellen MacArthur Foundation, 2015. Circular Economy System Diagram. Available at: <https://www.ellenmacarthurfoundation.org/circular-economy/interactive-diagram> [accessed 30/09/16]
- [8] Ellen MacArthur Foundation, unknown date. How tool sharing could become a public utility. Available at: <https://www.ellenmacarthurfoundation.org/case-studies/how-tool-sharing-could-become-a-public-utility> [accessed 10/01/2017]
- [9] Environment Agency: 2016. Environment Agency Datasets. Available at: <https://data.gov.uk/publisher/environment-agency> [Accessed 25/08/16]
- [10] Esa, M. R., Halog, A., Rigamonti, L. 2016. Developing strategies for managing construction and demolition wastes in Malaysia based on the concept of circular economy. *Journal of Material Cycles Waste Management*. In press. DOI: 10.1007/s10163-016-0516-x
- [11] Fernández, J. E. 2007. Resource consumption of new urban construction in China. *Journal of Industrial Ecology*, 11(2), 99–115. <http://doi.org/10.1162/jie.2007.1199>
- [12] Huang, T., Shi, F., Tanikawa, H., Fei, J., & Han, J. 2013. Materials demand and environmental impact of buildings construction and demolition in China based on dynamic material flow analysis. *Resources, Conservation & Recycling*, 72, 91-101 <http://doi.org/10.1016/j.resconrec.2012.12.013>
- [13] Krausmann, Fridolin, Simone Gingrich, Nina Eisenmenger, Karl-Heinz Erb, Helmut Haberl, and Marina Fischer-Kowalski. 2009. Growth in Global Materials Use, GDP and Population during the 20th Century. *Ecological Economics* 68, no. 10: 2696–2705. doi:10.1016/j.ecolecon.2009.05.007
- [14] Magdani, N. 2016. Design for Deconstruction. *Nature*, 531 (7595): 446.
- [15] Marcellus-Zamora, K. A., Gallagher, P.A., Spatari, S. and Tanikawa, H. 2016 Estimating Materials Stocked by Land-Use Type in Historic Urban Buildings Using Spatio-Temporal Analytical Tools. *Journal of Industrial Ecology*, 20, no. 5: 1025–37. doi:10.1111/jiec.12327
- [16] Nordby, S. N., Berge, B., Hakonsen, F., & Hestnes, A, G. 2009. Criteria for salvageability: the reuse of bricks. *Building Research & Information*, 37 (1): 55-67
- [17] Ortlepp, R., Gruhler, K., & Schiller, G. 2015. Material stocks in Germany's non-domestic buildings: a new quantification method. *Building Research & Information*, 3218, 1–24. <http://doi.org/10.1080/09613218.2016.1112096>
- [18] Rosado, Leonardo, Yuliya Kalmykova, and João Patrício. "Urban Metabolism Profiles. An Empirical Analysis of the Material Flow Characteristics of Three Metropolitan Areas in Sweden." *Journal of Cleaner Production* 126 (July 10, 2016): 206–17. doi:10.1016/j.jclepro.2016.02.139.
- [19] Tanikawa, H., Fishman, T., Okuoka, K., & Sugimoto, K. 2015. The Weight of Society Over Time and Space: A Comprehensive Account of the Construction Material Stock of Japan, 1945-2010. *Journal of Industrial Ecology*, 19(5): 778-791. <http://doi.org/10.1111/jiec.12284>
- [20] United Nations. 2016. Framework Convention on Climate Change, the Paris Agreement. Available at: http://unfccc.int/paris_agreement/items/9485.php [accessed 22/08/16]
- [21] United Nations Environment Programme (UNEP). 2016. Cities and Climate Change. Available at: <http://www.unep.org/resourceefficiency/Policy/ResourceEfficientCities/FocusAreas/CitiesandClimateChange/tabid/101665/> [accessed 30/09/16]

- [22] Wang, Tao, Daniel B. Müller, and Seiji Hashimoto. 2015. The Ferrous Find: Counting Iron and Steel Stocks in China's Economy. *Journal of Industrial Ecology* 19, no. 5: 877–89. doi:10.1111/jiec.12319.
- [23] Wiedenhofer, D., Julia K. Steinberger, Nina Eisenmenger, and Willi Haas. 2015. Maintenance and Expansion: Modeling Material Stocks and Flows for Residential Buildings and Transportation Networks in the EU25. *Journal of Industrial Ecology* 19, no. 4: 538–51. doi:10.1111/jiec.12216.

Net Environmental Loads of Mineral Admixtures and Portland Blended Cements

Marcella Ruschi SAADE^a, Maristela Gomes SILVA^b, Vanessa Gomes SILVA^c

^a University of Campinas, Brazil, marcellarms@hotmail.com

^b Federal University of Espírito Santo, Brazil, margomes.silva@gmail.com

^c University of Campinas, Brazil, vangomes@gmail.com

ABSTRACT

Using industrial outputs (coproducts) of multiple product (multifunctional) processes as mineral admixtures in cement making became a consolidated practice, driven by CO₂ reduction oriented strategies adopted over the past decades. Brazilian cement makers now revise their strategic planning for the years to come. Life cycle assessment (LCA) allows consideration of manifold environmental impact categories to provide a broad evaluation of both material and process loads. Multifunctional processes modelling remains, however, as a challenging task within LCA practice. The most common approach used for such modelling credits the avoided burdens related to the substituted product **to the multifunctional process that generated the recycled coproduct. Still, the 'avoided burden' approach fails to fairly distribute recycling effects across the partnering industries that enable it. This paper assesses the 'net avoided loads' by using four mineral admixtures to replace clinker in cement production: blast furnace slag, fly ash, calcined clay and limestone. LCA platform and impact method used were, respectively, SimaPro 7.3 and CML 2001 (baseline). For coproduct mineral admixtures (blast furnace slag and fly ash), we fully modelled the recycling effects and assigned the corresponding avoided and generated loads to each player in the joint industrial system, following the 'avoided problem' approach. From the admixtures studied, calcined clay clearly performed worst in all impact categories predicted by CML, whilst ggbs and fly ash behaved similarly and avoided the largest net loads in all categories. For blended cements, low clinker replacement ratio cements had environmental results very close to the reference. Despite its medium clinker replacement ratio, CP-IV-32 (28%-calcined clay) results were clearly biased by that admixture's poor performance. The cements with the highest clinker replacement ratio performed best: 66%-slag CP III-32, followed by 50%-fly ash CP IV-32. The 'avoided problem approach' allowed a complete and coherent modelling of recycling implementation within cement manufacturing. Information on 'net' impact avoidance enlightens and can scientifically ground cement industry's strategic agenda for sustainable practices.**

Keywords: life cycle assessment, multifunctional processes, cement mineral admixtures

1. INTRODUCTION

Brazilian cement production increased from 39.4 Mt in 2001 to 72.0 Mt in 2014 [1]. This manufacturing magnitude, however, is followed by environmental impact significance. Cement making is responsible for 5% of total global anthropogenic emissions [2], and is one of the great contributors to natural resources depletion.

To decrease its impact potentials, Brazilian cement industry has long profited from collaboration with different industrial sectors, to replace carbon intensive clinker with varied mineral admixtures. Table 1 describes the normalized types of Portland cement available in the country, along with respective clinker replacement ratios.

Type	Acronym	Content (% in mass)				National standard
		Clinker	ggbfs ^a	Pozzolana	limestone	
Portland Cement	CP I	100		0		[3]
	CP I-S	99-95		1-5		
Portland-Composite cement	CP II-E	94-56	6-34	0	0-10	[4]
	CP II-Z	94-76	0	6-14	0-10	
	CP II-F	94-90	0	0	6-10	
Portland-Blast furnace slag cement	CP III	65-25	35-70	0	0-5	[5]
Portland-pozzolana cement	CP IV	85-45	0	15-50	0-5	[6]

^a Ground granulated blast furnace slag

Table 1: Brazilian Portland cement types and compositions (adapted from ABCP, 2002)

Life cycle assessment (LCA) stands out as a robust method to account for a material's environmental performance, however, some methodological issues hinder its thorough application. The choice of impact distribution methods in multifunctional processes gives rise to extensive debates, which directly affect strategic decision making by companies that use coproducts as alternative input material.

National studies aiming to document Portland cement's environmental loads typically disregard coproduct impacts, considering bfs or fly ash as mere residues. Such practice therefore disregards international LCA trends, especially a EU directive [7], which shifted some types of waste to coproduct status, which would then bear corresponding environmental loads.

Saade, Silva and Gomes (2015) [8] assessed how different impact distribution methods affect bfs attractiveness to the cement industry, and considered the avoided burden approach as the most coherent method to model recycling processes, though it needed adaptation to the recycler's perspective. Further research then proposed an 'avoided problem' approach to adjust distribution of recycling effects into the industry partners enabling it [9].

This paper applies such 'avoided problem' approach in LCA to calculate the 'net' avoided loads that arise from using calcined clay, limestone and two coproducts (blast furnace slag and fly ash) as clinker replacements in blended cement production.

2. METHODOLOGICAL APPROACH

Given our focus on modelling multifunctional (steelmaking and coal-based electricity generation) or monofunctional (calcined clay and limestone making) processes, we performed cradle-to-gate LCAs and excluded use and end-of-life stages.

Firstly, actual avoided burdens were calculated using the 'avoided problem approach' [9], following Equation 1.

$$I_{net} = I_{subst} - [I_{proc} + I_{other} - I_{EOL}]$$

Equation 1

Where I_{net} is the 'net' avoided burden; I_{subst} is the impact avoided by replacing a giving product with a coproduct; I_{proc} is the coproduct processing impact, I_{EOL} is the coproduct's end-of-life impact, if not productively used; and I_{other} are all other loads that may arise to enable coproduct recycling, e.g. transportation loads.

In the case of monofunctional process outputs, such as calcined clay and limestone, I_{proc} represents the manufacturing loads, and I_{EOL} equals zero.

Secondly, the avoided/added burden related to solving coproduct end of life or material supply problems is respectively assigned to the multifunctional and recycling partners, following the 'avoided problem approach' illustrated in Figure 1.

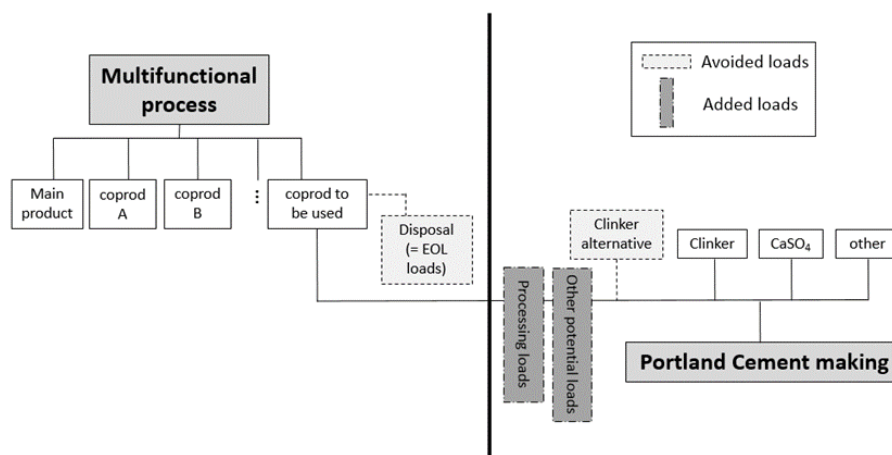

Figure 1: Impact distribution according to the avoided problem approach (adapted from [9])

Blended cement production cycle modeling used foreground data collected from national reports [10]. Due to the lack of national information, fly ash and blast furnace slag processing were modeled after [11], whilst end of life data came from adapted Ecoinvent v 2.2 data, by switching the default energy grid to the Brazilian correspondent. Limestone foreground data was also adapted from Ecoinvent v 2.2 in the same way. Calcined clay foreground data was obtained from a local cement making company. As it only produced CP IV-32 with 28% of clinker replaced, that was the only cement with calcined clay modeled. All background data came from the Ecoinvent v 2.2 processes, adapted with Brazilian energy mixes.

Table 2 summarizes technical properties, cement composition, LCA inputs and tools used in the assessments. Impact assessment results covered natural resources depletion, human health and ecosystem quality, divided in the ten impact categories calculated by CML 2001 (baseline).

	CP I-S-32	CP II-E-32	CP II-Z-32	CP II-F-32	CP III-32	CP IV-32	CP IV-32
% clinker replaced	5%	30%	10%	10%	66%	50%	28%
Functional unit	Step 1: 1 ton of blended cement*						
Reference flow	50kg CaSO ₄	50kg CaSO ₄	50kg CaSO ₄	50 kg CaSO ₄	50 kg CaSO ₄	50kg CaSO ₄	40kg CaSO ₄
	900kg clinker	650kg clinker	850kg clinker	850kg clinker	290 kg clinker	450kg clinker	680kg clinker
	50kg ggbfs/fly ash/limestone	300kg ggbfs	100kg fly ash	100kg limestone	660kg ggbfs	500kg fly ash	280kg calcined clay
Impact evaluation method	CML 2001 (baseline)						
LCA platform	SimaPro 7.3						

* Step 2: the functional unit was the 'equivalent binding capacity of 1 ton of clinker', and the reference flow was the corresponding mass of each admixture analysed

Table 2: Technical properties, compositions and tools used in cement LCAs

In the first analysis step, the functional unit only considered the replacement of clinker with the same mass of admixtures, disregarding their binding capacity. In the second step, the equivalent binding capacity [12] of the clinker replacement materials was factored in (Equation 2).

$$BE = cem + k.SCM$$

Equation 2

Where BE stands for **binding equivalent value**, **cem** stands for **remaining clinker dosage**, **k** is the admixture's coefficient and **SCM** is the admixture dosage.

K-values for ggbfs and fly ash are 0.9 and 0.6, respectively [11]. Thienel and Beuntner (2012) [13] determined a range of **calcined clay's k-values** between 0.6 and 1.0.

Some researchers try to calculate limestone's contribution to cement mechanical strength development [14]. Addition of limestone itself does not form calcium silicate hydrates (C-S-H), but rather increases particle dispersion and triggers nucleation, which accelerates C-S-H formation. Due to its reduced binding capacity, limestone was excluded from this analysis phase.

3. RESULTS PRESENTATION AND DISCUSSION

3.1. Clinker replacement net loads

The net environmental loads resulting from replacing clinker with the same mass of the different admixtures studied were calculated according to Equation 1. Calcined clay clearly performed worst in all impact categories predicted by CML, whilst ggbfs, fly ash and limestone achieved similar avoided loads (Table 3).

Impact category	Unit	ggbfs	fly ash	calcined clay	limestone
Abiotic depletion	kg Sb eq	1.42	1.49	-0.26	1.56
Acidification	kg SO ₂ eq	1.03	1.31	0.84	1.25
Eutrophication	kg PO ₄ ⁻⁻⁻ eq	0.24	0.25	0.18	0.23
Global warming	kg CO ₂ eq	866.45	885.19	858.20	887.89
Ozone layer depletion	kg CFC-11 eq	1.45E-05	1.54E-05	-2.00E-05	1.53E-05
Human toxicity	kg 1,4-DB eq	47.27	51.82	21.16	46.81
Freshwater ecotox.	kg 1,4-DB eq	14.22	15.77	10.29	14.60
Marine ecotox.	kg 1,4-DB eq	37933.71	40967.65	15376.48	39558.91
Terrestrial ecotox.	kg 1,4-DB eq	1.10	1.22	1.03	1.18
Photochemical oxidation	kg C ₂ H ₄ eq	0.03	0.05	0.02	0.05

Table 3: Net avoided loads associated to replacing 1 ton of clinker with 1 ton of different mineral admixtures

When binding capacity was taken into account (Table 4), clinker replacement with calcined clay again performed worst, particularly in terms of abiotic and ozone layer depletion categories. Top calcined clay k-value limit equals **clinker's equivalent binding** capacity, but at an environmental cost that makes its replacement counterproductive. When working at the lowest calcined clay k-value, binding capacity rivals that of fly ash, but also at a negative environmental performance.

Impact category	Unit	ggbfs (k=0.9 [11])	fly ash (k=0.6 [11])	calcined clay (k=0.6 [14])	calcined clay (k=1.0 [14])
Abiotic depletion	kg Sb eq	1.40	1.39	-1.53	-0.26
Acidification	kg SO ₂ eq	1.00	1.31	0.53	0.84
Eutrophication	kg PO ₄ ⁻⁻⁻ eq	0.24	0.25	0.13	0.18
Global warming	kg CO ₂ eq	862.49	873.62	828.52	858.20
Ozone layer depletion	kg CFC-11 eq	1.42E-05	1.42E-05	-4.48E-05	-2.00E-05
Human toxicity	kg 1,4-DB eq	46.71	51.44	0.13	21.16
Freshwater ecotox.	kg 1,4-DB eq	14.05	15.74	6.53	10.29
Marine ecotox.	kg 1,4-DB eq	37489.52	40294.90	-2638.01	15376.48
Terrestrial ecotox.	kg 1,4-DB eq	1.08	1.21	0.90	1.03
Photochemical oxidation	kg C ₂ H ₄ eq	0.03	0.05	0.004	0.02

Table 4: Net avoided loads due to replacement of 1 ton of clinker with mass of ggbfs (1.11 ton), fly ash (1.67 ton) or calcined clay (1.0-1.67 ton) with equivalent binding capacity

Fly ash and ggbfs use as clinker replacement avoided the largest net loads in all categories. Due to its higher **binding capacity, less ggbfs is needed than fly ash to deliver the same 'service'** as clinker. This advantage is, however, nearly neutralized by processing impacts, which are higher for ggbfs than for fly ash and explains their similar performances.

3.2. Net loads distribution: Portland cement impacts

Results in Tables 3 and 4 indicate fly ash and ggbfs as similar, best performing alternatives from all admixtures studied. Nevertheless, overall environmental performance is also influenced by clinker replacement ratio in blended cements. Figure 2 displays the impact profiles of the analysed **blended cements, calculated using the 'avoided problem approach'** (Equation 1 and Figure 1) and normalized in relation to CP I-S-32 with limestone.

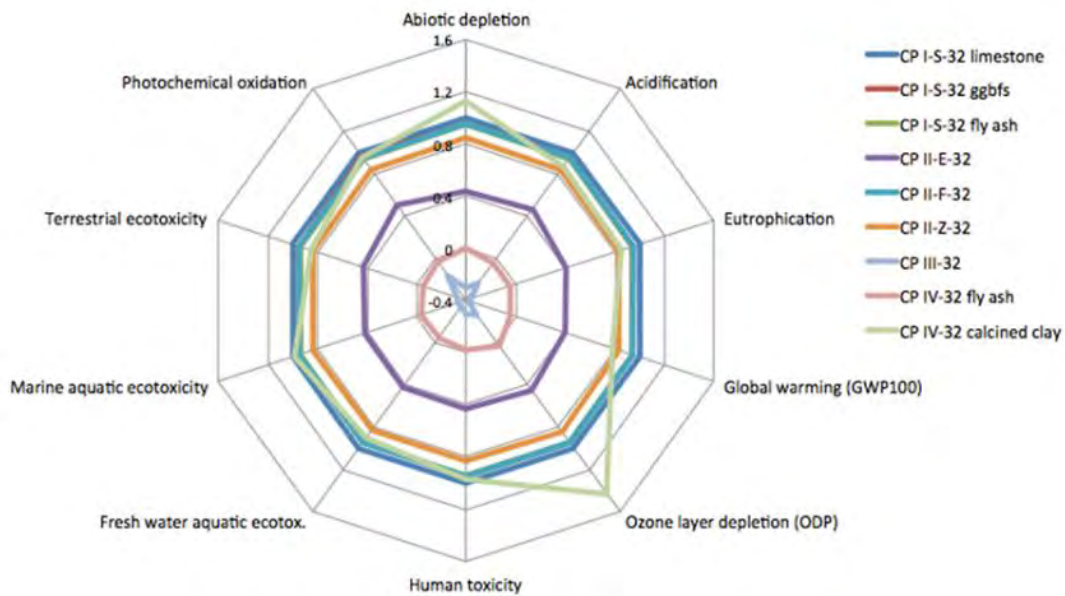

Figure 2: Portland cements impact profiles, normalized in relation to CP I-S-32 with limestone

Analyzed cements can be grouped into: low (up to 10%), medium (around 30%) and high (over 50%) clinker replacement ratios. CP-II-F-32 (10%-limestone) and CP-II-Z-32 (10%-fly ash) had discouraging environmental results, very similar to the reference CPI-S-32 (5%-limestone). Despite its medium clinker replacement ratio, performance of CP-IV-32 (28%-calcined clay) was clearly biased by that admixture's poor performance - particularly regarding ozone layer and abiotic depletion potentials - which shifted its final performance towards those of low clinker-replacement ratio cements. Intermediate performance was achieved by 30%-slag CP II-E-32, whilst the cements with the highest clinker replacement ratio performed best: 66%-slag CP III-32, followed by 50%-fly ash CP IV-32.

Although not considering EOL loads in impact distribution (those are credited to the multifunctional processes, according to Figure 1), use of the 'avoided problem approach' allows a coherent view of actual impacts associated to recycling implementation within cement manufacturing. Information on 'net' impact avoidance enlightens and can scientifically ground cement industry's strategic agenda for sustainable practices.

4. FINAL CONSIDERATIONS

The Brazilian Cement Roadmap, launched in 2014 by the Cement Sustainability Initiative (CSI) and the International Energy Agency (IEA), identified a need for immediately prospecting alternatives to supply clinker substitutes. Use of LCA to model such practices is paramount, but challenged by the multifunctional nature of processes generating potential alternatives.

Current recycling modeling approaches are incomplete and fail to distribute recycling effects into the industry partners enabling it. The 'avoided problem approach' helps to prevent those issues and offers a consistent and complete GHG emissions modeling backdrop to adequately inform the cement industry's decision making.

The 'net avoided burden' indicator carries valuable information for all industries involved, and can be used as reference metric to assist alternatives ranking, independently from the impact distribution method chosen.

Specifically to the cement industry, the proposed calculation procedure and results shown in this paper can assist in screening potential admixtures before advancing on technical feasibility investigation, as well guide environmental feasibility assessment of typical procedures for obtaining and using mineral admixtures.

Steelmaking speed is not keeping up with Brazilian cement industry's growth, so the industry not only uses other coproducts, but started to import bfs. Although not contemplated here, transportation-related impacts would enter Equation 1 as 'other loads' (I_{other}), and can significantly alter the impact profiles of admixtures and cements alike. This topic is currently addressed in complementary studies.

ACKNOWLEDGEMENTS

Authors sincerely thank CNPq and FAPESP for their generous support.

REFERENCES

- [1] Stafford, F. N., Raupp-Pereira, F., Labrincha, J. A., Hotza, D. Life cycle assessment of the production of cement: A Brazilian case study. *Journal of Cleaner Production*, v.137, pp. 1293-1299, 2016.
- [2] Humphreys K, Mahasen M. *Toward a sustainable cement industry. Substudy 8: climate change*. Geneva: WBCSD; 2002.
- [3] Associação Brasileira de Normas Técnicas NBR 5732. *Cimento Portland Comum*; 1991.
- [4] Associação Brasileira de Normas Técnicas NBR 11578. *Cimento Portland Composto*; 1991.
- [5] Associação Brasileira de Normas Técnicas NBR 5735. *Cimento Portland de Alto Forno*; 1991.
- [6] Associação Brasileira de Normas Técnicas NBR 5736. *Cimento Portland Pozolânico*; 1991.
- [7] European Union. Directive 2008/98/EC of the European parliament and of the council on waste and repealing certain directives. *Off J Eur Union* 2008; 2008(312), pp.3–30.
- [8] Saade, M.; Silva, M.; Gomes, V. Appropriateness of environmental impact distribution methods to model blast furnace slag recycling in cement making. *Resources, Conservation and Recycling*, 2015, 99: pp. 40-47.
- [9] Saade, M.; Silva, M.; Gomes, V. A novel perspective on the avoided burden approach applied to steel-cement making joint system. In: G. Habert, A. Schlueter (eds.): *Expanding Boundaries* © 2016 vdf Hochschulverlag AG an der ETH Zürich DOI 10.3218/3774-6_50. pp. 310-314.
- [10] Silva MG. *Concreto de alto desempenho com elevados teores de escória de alto forno: estratégia para consolidar o mercado da escória de alto forno*. NEXES Report. Vitória, Brazil: Technology Center, University of Espírito Santo; 2006.
- [11] Chen C, Habert G, Bouzidi Y, Jullien A, Ventura A. LCA allocation procedure used as an incitative method for waste recycling: an application to mineral additions in concrete. *Resour Conserv Recycl* 2010;54:1231–40, <http://dx.doi.org/10.1016/j.resconrec.2010.04.001>.
- [12] CEN, European Committee for Standardization. *NF EN 206-1. Concrete—part I: specification, performance, production and conformity*; 2004.
- [13] Thienel, K.C., Beuntner, N. Effects of calcined clay as low carbon cementing materials on the properties of concrete. M.R. Jones, M.D. Newlands, J.E. Halliday, L.J. Csetenyi, L. Zheng, M.J. McCarthy (Eds.), et al., *Concrete in the Low Carbon Era*, University of Dundee – Concrete Technology Unit, Dundee, UK (2012), pp. 504–518.
- [14] Boubitsas, D, Use of Limestone in Cement: The Effect on Strength and Chloride transport in Mortars. *Nordic Concrete Research* v.47, pp. 61-80, 2013. Available at: <http://www.nordicconcrete.net/ikbViewer/Content/897749/008%20-%20S135%20-%20Boubitsas%202013-06-04.pdf>.

Embodied Energy and Global Warming Potential in Construction: Perspectives and Interpretations

Maria BALOUKTSI^a, Thomas LÜTZKENDORF^b, Seongwon SEO^c, Greg FOLIEN^d

^a Karlsruhe Institute of Technology (KIT), Germany, maria.balouktsi@kit.edu

^b Karlsruhe Institute of Technology (KIT), Germany, thomas.luetzkendorf@kit.edu

^c UrbanPanaceas, Australia, seongwon@urbanpanaceas.com

^d Department of Infrastructure Engineering, The University of Melbourne, Australia, gfoliente@nbluesystems.com

^d BLue Pty Ltd., Australia, gfoliente@nbluesystems.com

ABSTRACT

The effective application of the generally recognised concept of embodied environmental impacts depends on a common and clear understanding of definitions and scope of analysis. This is especially important in the construction sector because of the range in focus from product level to the whole building level, and the varied nature of different life cycle phases. This paper addresses these considerations from a systems perspective, but particularly focused on embodied energy and embodied global warming potential (GWP) indicators, to inform their assessment methods, and the interpretation of results. Existing knowledge gaps are identified and a consistent and expansive set of recommendations to assist the calculation of embodied impacts datasets, and the interpretation and application of these data in the practical design process of buildings is presented.

Keywords: embodied energy, embodied GWP, embodied carbon

1. INTRODUCTION

A systems view of global resource depletion and environmental impact implies that a design approach to buildings focused on their operation stage alone may lead to a sub-optimal solution, resulting in great loss of significant opportunities to conserve our resources and reduce the potential adverse effects on the environment. For example, it may be possible to design an energy efficient building solution focused only on the operation stage but associated with an increased embodied energy consumption and greenhouse gas emissions (GHG) due to the selection and use of building products and technology systems that are themselves highly energy- and emissions-intensive to produce. **The building design process should take into account, among other aspects, the environmental “areas of protection”, as intended in life cycle analysis (de Haes et al, 1999), during the full life cycle of the “final product”.** In building and construction, the ultimate or final product should be the whole building, which in itself is an assembly of different construction products and materials. The indicators selected in this paper that consider the areas of **“natural resources” and “natural environment” protection are embodied energy and embodied global warming potential (GWP)**, sometimes also called embodied GHG emissions or partial carbon footprint.

In the existing life cycle oriented standards dealing with the sustainability assessment of buildings within ISO/TC 59/SC 17 (ISO 21931-1:2010 and ISO 21929-1:2011) and CEN TC 350 (EN 15643-2:2011 and EN 15978:2011), the quantification of embodied energy is performed as part of the assessment of the indicators measuring the use of non-renewable and renewable primary energy resources or measuring the abiotic resource depletion potential (ADP) of fossil fuels (included only in CEN TC 350 standards for expressing the concern over the scarcity of fossil energy resources) for the lifecycle stages other than the operation. Likewise, the quantified embodied GHG emissions are represented by the environmental impact indicator GWP. For this purpose, this paper refers to embodied GWP as part of the life cycle GWP. However, the standards do not provide a complete picture and a detailed understanding of the various perspectives and practices, as well as their overlaps. This leaves room for a range of interpretations and misunderstandings that could lead to mis-applications or sub-optimal decisions. Many stakeholders who are now considering these aspects much more frequently in their decision-making (like designers, construction product manufacturers, procurers and others) need consistent and technically-sound information about important aspects of embodied energy and embodied GWP (Balouktsi et al., 2016).

Towards this goal, this paper clarifies the definitions of, and the scope or boundary of analysis for, embodied energy and embodied GHG emissions/ embodied GWP, and addresses the following specific questions: How the calorific value of feedstocks is treated? Should both the energy-related and material (non-energy)-related use

(feedstock) of fuels be accounted for as part of the embodied energy? What is embodied GHG emissions and what is its relationship with “embodied global GWP”, “embodied carbon” or the widely used term “carbon footprint”? How the biogenic carbon stored in wooden and other biogenic products is treated? What is the difference between the “virtual” embodied energy and carbon, and the “real” embodied energy and carbon in a product or building? What are the possible interpretations emerging from the different approaches? Is there any difference about the embodied energy when designing a building and the embodied energy of an existing building? The analysis presented herein draws partially on the contributions of the authors to the discussions within the International Energy Agency (IEA) EBC Annex 57 “Evaluation of Embodied Energy and CO₂eq. for Building Construction”.

2. LIFE CYCLE RELATED SYSTEM BOUNDARIES

Following the current international and European standards, a building’s life cycle consists of four main stages (Figure 1): product stage, construction process stage, use stage, and end-of life stage. In EN 15978:2011, there is also an additional and separate information module (module D: benefits and loads beyond the system boundary). Each stage is further divided into several modules. In stages A and C, the included modules describe a logical sequence of building-creation and end-of life processes (activities usually occurring in a linear way), while in stage B the processes occur usually in parallel (use, operational energy use, operational water use, etc.) or cyclically/regularly during the building use (e.g. use - maintenance - use). This results in a diversity of interactions. For example, module B4 – replacement includes the production, transportation and installation (replacement process) of the replaced components (A1-5 for replaced components) and the end-of life stage of the removed component (C1-4 for the removed component). Furthermore, a selective deconstruction (C1) is a prerequisite for exploiting the recycling potential of recyclable construction products and materials (environmental benefits reported in module D).

BUILDING LIFE CYCLE														ADDITIONAL INFORMATION		
PRODUCT STAGE			CONSTRUCTION PROCESS STAGE		USE STAGE							END OF LIFE STAGE		POTENTIAL BENEFITS & LOADS		
A1	A2	A3	A4	A5	B1	B2	B3	B4	B5	B6	B7	C1	C2	C3	C4	D
Raw material supply	Transport	Manufacturing	Transport	Construction- installation process	Use, installed products	Maintenance	Repair	Replacement	Refurbishment	Operational Energy Use	Operational Water Use	Deconstruction	Transport	Waste processing	Disposal	Recovery – Reuse – Recycling - potential
Embodied	✓	✓	✓	✓	✓*	✓	✓	✓	✓			✓	✓	✓	✓	(✓)
Operational										✓	✓					(✓)

* is relevant for materials or products emitting or binding GHGs in the use stage

Figure 1: Embodied and operational impacts (Energy & GHG) in life cycle of buildings based on the modular approach of EN 15978:2011 Standard. Module D must always be reported separately.

The exact presentation of the included life cycle phases is a prerequisite for transparency and comparability, e.g. see Ref. (Lützkendorf et al, 2015).

3. PERSPECTIVES AND INTERPRETATIONS OF EMBODIED ENERGY

3.1 Types of primary energy resources

The scope of the indicator(s) used for quantifying embodied energy consumption is strongly influenced by the purpose of each respective study and the information that is available. In any case embodied energy should always be expressed in primary energy terms, thus calculated at the natural resource level. At the same time, it should always be clearly specified which energy resources are quantified and considered in the indicator(s). For this purpose, a clear differentiation between the various types and uses of primary energy resources is needed. For example, different levels of disaggregation of total embodied energy into its individual parts are illustrated in Figure 2. The first level is the total (aggregated) embodied energy without any differentiation between renewables and non-renewables. At the second level, a distinction should be made among the following types of energy:

- Use of renewable energy resources (biomass, solar energy, geothermal energy, wind power and others)
- Consumption / depletion of non-renewable energy resources (fossil and nuclear energy resources (Frischknecht et al., 2015)).

At the third level – which is the one the authors suggest – a further distinction should be made (and this applies to energy resources that can serve diverse purposes) between:

- Energy resource consumption as a result of energy-related use of energy resources
- Energy resource consumption as a result of non-energy related (usually called feedstock) use of energy resources. These can be either renewable (e.g. biomass as feedstock) or non-renewable (fossil resources as feedstock).

Within the group of biomass, it is also useful to distinguish between wood-based biomass and other types of biomass because of the effects of carbon sequestration associated with this specific type of biomass.

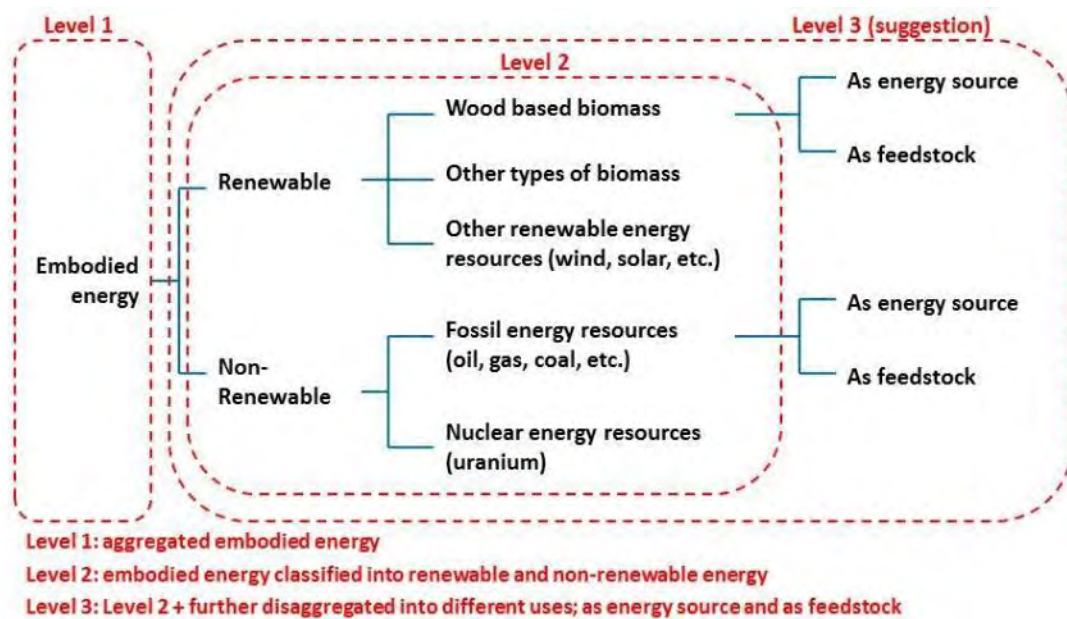

Figure 2: Aggregation levels in embodied energy indicator based on the types and uses of resources

3.2 Non-renewable energy resources: focus on fossil fuels

Often, fossil energy resources can serve two different purposes; their consumption can be both energy-related and non-energy-related (feedstock energy). In the first case, the primary energy resources are consumed as a fuel (e.g. fossil energy resources are combusted and as a consequence CO₂ is released into the atmosphere). This type of **energy is not a physical part of the product, but is associated with it; therefore, it is embodied in a “virtual” sense** as a way of allocating the energy consumed along the supply chain of a product or building to the specific product or building (Type I in Figure 3). On the other hand, feedstock energy is the primary energy (resources) which is not consumed as a fuel, but used as a raw material (this applies to specific products embodying fossil materials without using them as a fuel, e.g. petrochemicals may be used as feedstock to make plastics and rubber). This energy (calorific value) is not released but retained (contained in the product) throughout the product lifecycle, and therefore, is available for use as fuel energy outside the system boundary. Thus, there is the potential to be partially released and recovered at the end of life stage, usually through incineration. This type of energy is a physical part **of the product, and thus, is embodied in a “real” sense (Type II in Figure 3)**. Processes that use fossil fuel resources as a fuel have very different impacts from those that use them as a feedstock to produce another product. To reflect these differences, and to get an accurate idea of the different impacts, the calorific value of a feedstock should be included in an embodied energy indicator as a separate stream of information. This is in line with CEN TC 350 standards, which include two different indicators (among others) to describe these two cases of resource use:

- Use of non-renewable primary energy excluding energy resource used as raw material

- Use of non-renewable primary energy resources used as raw material

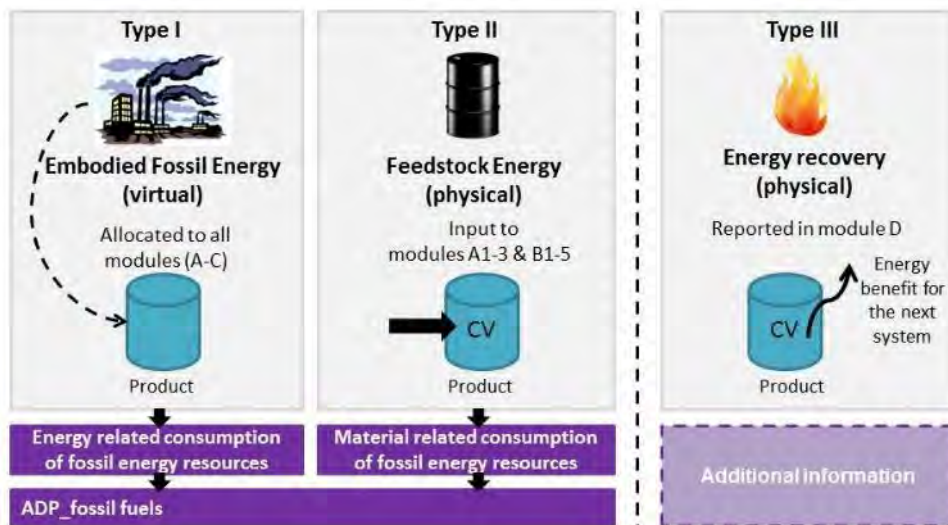

Figure 3: Classification of embodied energy (Fossil) into different types distinguishing between the energy embodied in a “Virtual” sense and in a physical sense (Calorific Value - CV) in a product.

Feedstock energy, considering that it represents a permanent loss of fossil energy resources, is also part of the environmental impact related indicator “abiotic resource depletion potential for fossil fuels (ADP_fossil)” within the same group of standards. In addition, since any feedstock energy from a building product may result in an energy benefit through its recovery, this must be identified and reported separately in Module D as additional information (Type III in Figure 3). However, care must be taken to ensure that there is no double-counting here.

3.3 Renewable energy resources: focus on wood-based biomass

Similar to the fossil energy resources also biomass can be used both as a fuel and as a feedstock. Again, CEN TC 350 standards include two specific indicators, among others, for describing these two different perspectives:

- Use of renewable primary energy excluding energy resource used as raw material
- Use of renewable primary energy resources used as raw material

However, in many studies the calorific value of timber is excluded from calculations when used as a feedstock, since it does not represent a permanent loss of resources. It is only identified and reported in Module D, as a potential energy benefit for its future use as a fuel. Here, it is suggested that a description of the material use of renewable primary energy resources is provided separately in Module A.

4. PERSPECTIVES AND INTERPRETATIONS OF EMBODIED GWP

4.1 Types and sources of GHG emissions

In literature, the term “carbon” contained in the concepts of “embodied carbon”, “grey carbon”, “carbon footprint” and other related concepts is often used as a catch-all term and can mean:

- carbon dioxide (CO₂) alone;
- the six main (groups of) gases identified in the Kyoto Protocol (CO₂, CH₄, N₂O, HFCs, PFCs and SF₆); or
- the numerous GHGs specified by the 5th IPCC report (2013).

GHG emissions are generally reported, using the GWPs of the individual GHG gases expressed in units of kg carbon dioxide equivalent (kg CO₂e), taking into account the different impact of GHGs on global warming. In some cases, the fluorocarbon gases (F-gases) regulated under the Montreal Protocol may be also included in the embodied GWP, besides the ones specified in IPCC report. Here, it is recommended to quantify the embodied GWP by including in the CO₂e all GHGs specified by the 5th IPCC report and to include the F-gases only where

relevant. However, to clearly understand what may be included in an embodied GWP, the determination of the emission types included in the calculation of CO₂e is not sufficient; the different sources of embodied GHG emissions related to construction products and buildings have also to be identified.

The majority of them arise directly from the energy-related use of fossil energy resources (fuel-related) – thus, they are directly linked to the “virtual” embodied energy (most significant). But these do not give the whole picture. There are also the non-fuel related CO₂ emissions occurring from the manufacturing processes (process emissions) as a result of specific chemical effects (e.g. CO₂ is emitted as a chemical reaction in cement manufacture). Both of these types of emissions are related to processes allocated to the product; therefore they represent a GWP in a “virtual” sense not a physical one (Type I, Figure 4). Another special type of emission is the carbon contained in the body of a product. Carbon that is stored in a material, previously absorbed from the atmosphere, is usually described as “sequestered” or “stored”. Biomass based materials like wood absorb the carbon during growth and lock it away safely in the wood product as installed in the building until the building is demolished (or the product is replaced) and the biomass incinerated. Thus, here the carbon is a physical part of the product, and thus, is embodied in a “real” sense (Type IIa in Figure 4). It is a highly debatable issue how to treat biogenic carbon stored in wood-based products. In case the biomass used can be assumed to originate from sustainable forest sources, biogenic carbon emissions can be regarded as zero based on the idea of biogenic carbon neutrality. In this sense, carbon storage in wood products is balanced during natural decay or incineration of the products. However, it can also be included in the assessment result as additional environmental information.

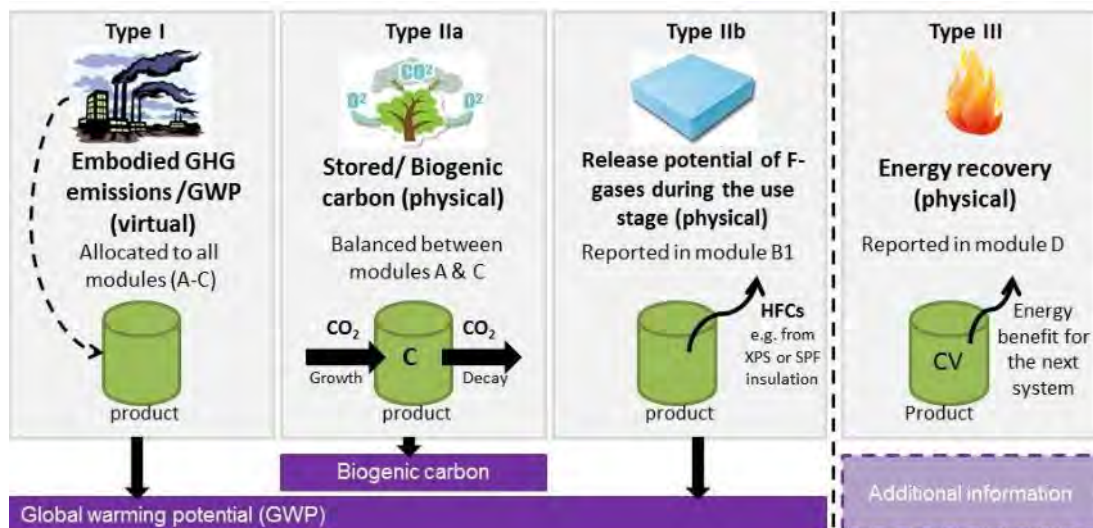

Figure 4: Classification of embodied GHG emissions/GWP into different types distinguishing between the emissions embodied in a “virtual” sense and in a physical sense (carbon and HFCs) in a product.

Finally, there is the potential for some materials and products to emit F-gases during their use in the building’s operation. F-gases, which contain HCs, HFC, HCFC etc., can be used in the insulation material (e.g., as blowing agent) and cooling systems (as a refrigerant) in buildings. These gases are released to atmosphere from the insulation material and leaks from cooling system over the building life. However, they do not come from fossil fuel burning, rather than used as feedstock in insulation material and are released into the air in the use stage of building. Similarly, coolant leaks over the use of building and end of life phase of building. These have, sometimes in specific areas of the world, a significant influence (Type IIb in Figure 4). So far, there is no clear guidance on which stages these emissions should be included (embodied or operational). The way these gasses are considered differs depending on the stakeholder group.

As described above, the authors recommend to clearly describe and identify the items included in Table 1 when quantifying embodied energy and embodied GHG emissions. Further, it would be ideal to report separately the “virtual” embodied impacts and the physical embodied impacts.

Aspects/ Indicators	Virtual (allocation of processes)	Physical (real)
Embodied Energy	Use of fossil energy resources as energy source	Use of fossil energy resources as feedstock (energy recovery potential)
	Use of nuclear energy resources as energy source	
	Use of wood-based biomass as energy source	Use of wood-based biomass as feedstock (energy recovery potential)
	Use of other renewable energy resources as energy source	
Embodied GWP	Fuel-related GHG emissions	F-gases released during the use stage
	Process GHG emissions	
		Biogenic carbon stored in wooden materials

Table 1: Summary of “Virtual” and “Physical” part of embodied impacts (Energy & GHG Emissions)

5. DISCUSSION

In the design stage of buildings, the indicator embodied energy can be used for the description, assessment and targeted influencing of the use of primary non-renewable and renewable energy resources for the lifecycle stages other than the operation. The prevailing design objective is, among others, the conservation of resources by limiting the consumption of fossil energy resources and the optimization of the life cycle primary energy consumption. **(“design for environment”) The use of resources is interpreted as an “environmental load”. Another approach to conserving resources is to influence the durability, and easy dismantling and recycling of the building already in the design stage. It is possible to specify the existing potential, provided the use of appropriate procedures and a future possible demand, in terms of material recycling and energy recovery. This potential may, inter alia, be expressed as recoverable or saved energy for the next system. Assuming scenarios for deconstruction, such information can be described in module D as additional information, besides the information related to the life cycle of buildings. Embodied energy in this case will thus become a “potential” for reuse. The embodied energy in existing buildings can be interpreted as “potential” that can be tapped by demolition and recycling (urban mining). So it is an “ecological value” that is preserved through building maintenance and modernization or unlocked through demolition and recycling.**

6. CONCLUSIONS

Different terms and definitions are currently used to describe embodied energy and embodied GHG emissions. To alleviate the confusion surrounding these topics, consistent and technically-sound information about important aspects of these embodied impacts are required. Specifically, the paper has focused on providing clarifications about the boundary or scope of analysis, and the different types and uses of primary energy resources that can be considered in an embodied energy indicator on the one hand, and the different types and sources of GHG emissions considered in an embodied GWP on the other hand. **We also made the distinction between “virtual” embodied impacts as a result of an allocation of energy consumed and GHG emissions occurring along the supply chain of a product or building to the specific product or building and the impacts embodied in a “real” sense constituting a physical part of the product.**

REFERENCES

- [15] Balouktsi, M., Lützkendorf, T., and Foliente, G., 2016. “Embodied impacts in stakeholder decision-making in the construction sector”, paper presented at the Sustainable Building Regional Conference, Hamburg, 8-11 March
- [16] de Haes, H.A.U., Jolliet, O., Finnveden, G., Hauschild, M., Krewitt, W., and Müller-Wenk, R., 1999. Best available practice regarding impact categories and category indicators in life cycle impact assessment. The International Journal of Life Cycle Assessment, 4(2), 66-74.
- [17] Frischknecht, R., Wyss, F., Knöpfel, S.B., Lützkendorf, T., and Balouktsi, M., 2015. Cumulative energy demand in LCA: the energy harvested approach. The International Journal of Life Cycle Assessment, 1-13.
- [18] Lützkendorf, T., Foliente, G., Balouktsi, M., and Wiberg, A.H., 2015. Net-zero buildings: Incorporating embodied impacts. Building Research & Information, 43(1), 62-81.

Study of Human Embodied Energy for Masonry Work During Building Construction

Pinky Devi L.^a, Sivakumar PALANIAPPAN^b

^a Indian Institute of Technology Madras, India, pinkydevi@gmail.com

^b Indian Institute of Technology Madras, India, sp@iitm.ac.in

ABSTRACT

The embodied energy of a building is expected to be a significant component of life cycle energy for naturally ventilated or partially air-conditioned buildings in developing nations. This necessitates a detailed understanding of various aspects of embodied energy. The non-renewable energy embodied in a building in the form of construction materials and site processes has been well explored in the literature. However, the energy expended by the human workforce during building construction has not been explored in developing nations like India. While the construction industry is heavily mechanized in developed countries, substantial amount of construction work is done manually using human workforce in developing countries. This study presents a method to estimate the human embodied energy associated with masonry work and determines the relative proportion of non-renewable embodied energy due to transportation and equipment use with the human embodied energy. Volume of masonry work completed per month and the number of masons and helpers associated with masonry work were gathered for 16 months. The total volume of masonry work completed during 16 months is 4441 cu.m. The non-renewable embodied energy required for materials manufacturing, transportation of materials to site and the equipment use for lifting blocks to the required floor was determined. Further, the human embodied energy used for masonry work was assessed. The energy used for transporting materials to site is 67 MJ/ cu.m. The energy used for lifting equipment is 0.92 MJ/ cu.m. The human energy used is found to be 29 MJ/ cu.m. It is found that the human energy is close to 1/3 of the total energy used for on-site construction processes.

Keywords: embodied energy, human energy, masonry work

1. INTRODUCTION

The construction industry consists of building of new structures, repair, maintenance or renovation of buildings and infrastructure projects (Behm, 2008). It involves the use of resources namely materials, machineries, manpower and money. The Indian construction industry is one of the fastest growing economies and ranks second in providing employment next to the agricultural sector (Swarup, 2007). The construction industry in India is witnessing a rapid growth and there is a tremendous movement towards sustainable development.

The major phases of a building life cycle are production (mining of raw materials, transportation, manufacturing of building materials and transportation to suppliers and contractors), on-site construction (transportation to the site and installation of building components), use (heating, cooling, lighting and ventilation), maintenance/repair and end-of-life (demolition, transportation, land filling, recycling and reuse). The typical distribution of energy in the building life cycle is as follows: initial embodied energy - 10 to 20%; operating energy - 80 to 90% and the demolition energy - <1% (Ramesh et al. 2010; Kofoworola and Gheewala 2009, Keoleian et al. 2000).

Studies have been carried out to find the embodied energy of buildings in India (Reddy et al. 2003, Ramesh et al. 2012, Varun et al. 2012, Devi and Palaniappan 2014). However, these studies do not provide the energy expended by the human workforce during on-construction. Held et al. (2013) estimated the embodied energy including human energy related to water treatment and supply. Dixit et al. (2015) included human energy while calculating embodied energy of construction materials. The embodied energy associated with human workforce during building construction has not been investigated adequately for construction projects. This article presents a case study on human energy associated with masonry work using a construction project in India.

2. CASE STUDY

The data was collected for 16 months from a residential building construction project. The building consists of 5 blocks. Each block has a material hoist which is used for lifting of materials. The total volume of masonry work is 4441 cu.m. Table 1 presents the quantity of work done and the number of workers deployed.

Months	Masonry work (cu.m)	Number of Masons	Number of Male helpers	Number of Female helpers
1	70.68	89	135	119
2	221.9	252	384	327
3	285.25	321	487	418
4	216.39	259	399	338
5	202.62	233	355	303
6	293.35	319	484	417
7	294.77	317	479	416
8	384.62	401	610	527
9	433.8	457	695	600
10	435.6	451	682	592
11	536.27	541	817	701
12	308.39	359	541	471
13	256.16	302	459	397
14	124.78	162	250	215
15	181.99	229	350	292
16	194.43	230	350	294
Total	4441	4922	7477	6427

Figure 42: Masonry work quantity and construction workers

3. METHODOLOGY

This study calculates the energy required for manufacturing, transportation, lifting of materials and the laying of masonry work. The quantitative data were collected from the site. The total work volume is 4441 cu.m (75% block work and 25% cement mortar by volume). The thickness of masonry work is 230 mm. Cement concrete block is used for masonry work. The mix proportion of cement mortar is 1:4. The thickness of cement mortar used for binding the cement concrete blocks is 6 mm. The quantity of cement mortar presented in this study excludes the cement mortar use for plastering on the exterior and the interior sides of the wall. The embodied energy of cement, sand and cement concrete blocks are based on the Indian data (Reddy et al. 2003, Shukla et al. 2009 and Development Alternatives, 1995). For material transportation, this study assumes suitable vehicle mileage vehicle and the transportation distance to calculate the diesel fuel usage and transportation energy. The energy required for on-site construction processes has two important components. The first one is the equipment energy which is normally used for lifting materials and the second is the human energy which is used for placing of block work and mixing of cement mortar. Each worker is assumed to work for 8 hours per day. For calculating the energy used for material hoist, the energy data were collected from the site. The percentage of lift cycles for each material lifted per month is quantified for material hoist. In addition, the contractor also maintains the electricity meter data and operating hours of each material hoist used for lifting block, cement, sand, debris and other miscellaneous items. During the study, it is assumed that material hoists lifted the same amount of weight in each lift cycle, thereby electricity consumed is considered the same irrespective of the load lifted. The total lift cycles for each material lifted, operating hours and electricity use are documented on a daily basis. The study found that the energy used by material hoists for lifting the block work and cement mortar are 0.05 kWh/cu.m and 0.15 kWh/cu.m respectively. All material hoists are run using electricity.

The human energy is calculated based on the framework shown in Figure 1 and this study used the methodology provided by Held et al. (2013). The age of the workers is derived based on work sampling done at the site. Most of the workers are of 18-30 years (including the mason and the helper) with an average weight 62.5 kg for male worker and 57.5 kg for female worker.

Based on the equation provided by Food and Agriculture Organization (FAO) 2001, Basal Metabolic Rate (BMR) is derived for each category. A Physical Activity Ratio (PAR) is the energy spent for a specific activity per unit of time, expressed as a multiple of BMR. The FAO report (Food and Agriculture Organization, 2001) compiled results

from a number of studies of PARs of various activities. The embodied human energy is calculated using the Eq. (1) (Held, 2010; Held et al. 2013).

Embodied human energy (MJ) =

$$(PAR-1) \times (BMR \text{ (MJ/hr)}) \times (\text{Number of work hours per day}) \times (\text{Number of days work performed}) \times (\text{Workers per activity}) \times (\text{Number of activities})$$

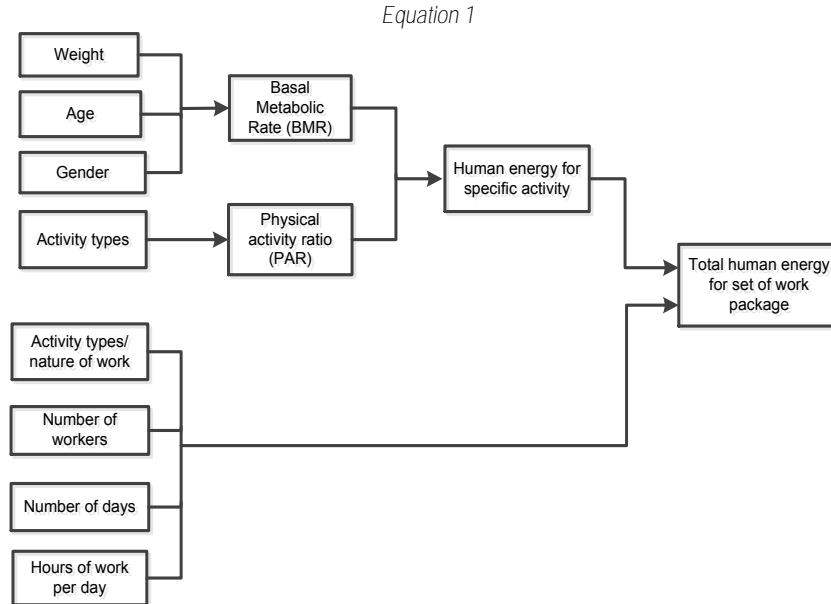

Figure 1: Framework for calculating human energy (adapted from held et al. 2013)

4. RESULTS

The embodied energy of construction materials is calculated based on the Indian data. Table 2 presents the embodied energy for manufacturing materials. It is found that the material flow per unit volume of masonry work is 1.815 tons/cu.m. The embodied energy of materials is found to be 1.408 GJ/cu.m.

Material	Weight		EE (MJ/kg)	Energy	
	kg	(%)		MJ	(%)
Block	5494500	68	0.475	2609887	42
Cement	486351	6	6.85	3331507	53
Sand	2081584	26	0.15	312238	5
Total	8062435				
Total primary energy (MJ)				6253632	

Table 2: Energy for manufacturing of materials

Table 3 presents the energy used for transportation of materials. It is observed that the energy used for material transportation is 67.09 MJ/cu.m. The energy used for on-site construction processes is classified into two components - lifting of materials using material hoist and laying of masonry work using human workforce. Table 4 presents the energy used by material hoist for lifting materials. It is found that the energy used for lifting is 0.92 MJ/cu.m.

The human energy used for laying is calculated using Eq.1. Table 5 presents the calculation of BMR. Table 6 presents the PAR for some construction activities. Table 7 presents the human energy used for laying masonry work. The human energy used for laying is found to be 29 MJ/cu.m. Figure 2 shows the relative proportion of energy used for lifting and laying of block work. On an average, 3% of the energy is used for lifting the materials and 97% of the human energy is used for laying. Figure 3 shows the energy use for lifting and laying of block work

on a monthly basis. The lifting energy is in the range of 2.6% to 3.3%. The human energy spent by male helpers is highest followed by male masons and woman helpers on a monthly basis. It is mainly due to the higher number of male masons deployed per month. However, the human energy measured per unit quantity of the work per person indicates that the male mason energy is the highest (8.7 MJ/cu.m) followed by male helper (6.6 MJ/cu.m) and female helper (5.4 MJ/cu.m). Figure 4 presents the relative proportion of transportation, lifting and laying. It is observed that the transportation energy, lifting of material energy and human energy for laying are 70%, 1% and 29% of the total on-site construction energy. Similar studies have been carried out for quantification of human and embodied energy (Held et al 20). It is found that the human energy account for 1 to 25% of the total embodied energy for different activities involved in the water improvement processes.

Material	Weight (kg)	Capacity of trucks	Unit	One way distance (km)	No. of trips	Fuel use (diesel in litres)
Block	5494500	10	cu.m.	20	306	3497
Cement	486351	200	bags	100	49	2800
Sand	2081584	10	cu.m	10	130	743
Total fuel (litres)						7040
Total primary energy (MJ)						297961

Note: 1) Truck mileage: 3.5 km/l; 2) 1 L diesel = 35.27 MJ;
3) Factors for converting secondary energy into primary energy: 1.2.

Table 3: Energy for transportation of materials

Descriptions	Quantity (cu.m.)	Energy use (kWh/cu.m.)	Energy use (MJ)
Masonry (Block) quantity (75%)	3330.7	0.05	2038
Cement mortar quantity (25%)	1110.3	0.15	2038
Total lifting energy			4076

Note: 1 kWh = 3.6 MJ; multiplication factor to convert electricity use from secondary to primary energy: 3.4.

Table 4: Energy for lifting of materials using material hoist

Gender	Age	BMR (MJ/day)	Average weight (kg)	BMR (MJ/day)
Male	18-30	0.063 W + 2.896	62.5	6.8335
Female	18-30	0.062 W + 2.036	57.5	5.601

W-Weight of person in kg

Table 5: Calculation of BMR

S No.	Construction Activities	PAR
1	Making Bricks	3
2	Sawing And Bending Rebar	3.3
3	Pouring Concrete Foundation	4.81
4	Laying Bricks	4.81
5	Mortaring	3.3
6	Transport (Walking With 25-30 kg load)	3.9

Table 6: PAR for some construction activities

Category	BMR	Number of workers	PAR	Number of working days	Hours per day	Human energy (MJ)
Mason-Male	6.8335	4922	4.81	456	8	42716
Helper-Male	6.8335	7477	3.9	456	8	49391
Helper-Female	5.601	6427	3.9	456	8	34798
Total human energy (MJ)						126904
Total quantity of masonry work (cu.m.)						4441
Human energy per cu.m. of masonry work						29

Table 7: Human energy used for laying masonry work

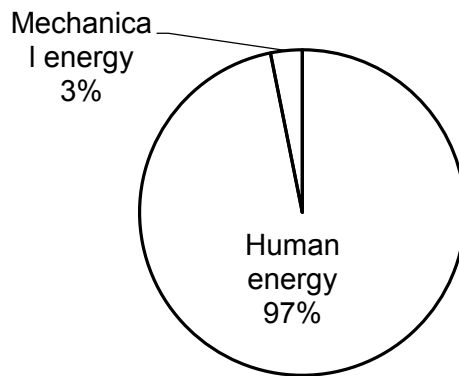

Figure 2: Relative proportion of energy use for lifting and laying of masonry work

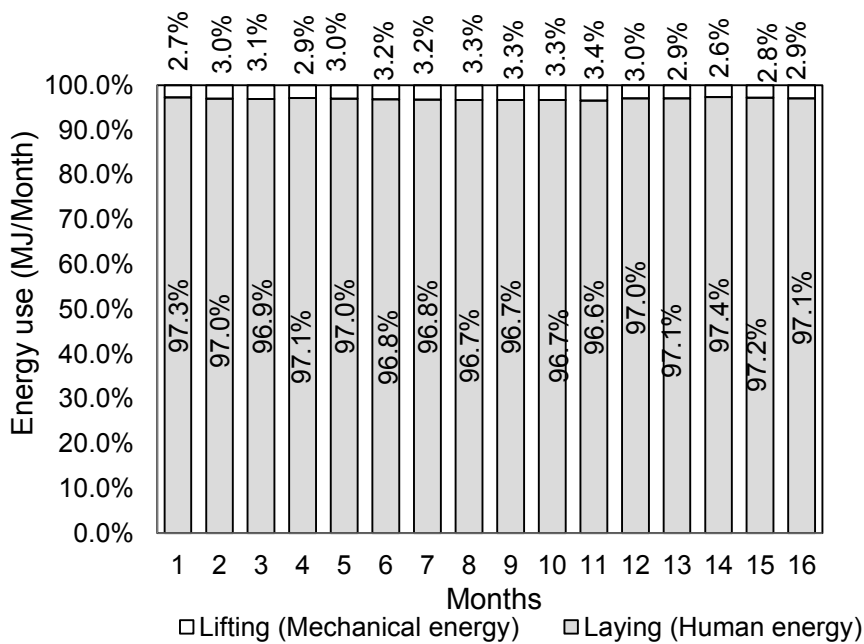

Figure 3: Relative distribution of energy use for lifting and laying masonry work

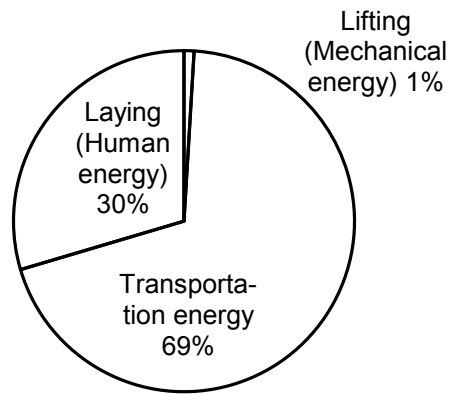

Figure 4: Relative proportion of energy use for transportation, lifting and laying

5. CONCLUSIONS

This study determined the human energy used for masonry work and compared it with the total non-renewable energy used during on-site construction for transportation of materials to site and lifting of materials at site. It is observed that the transportation energy, lifting/material handling related energy and human energy represents 70%, 1% and 29% of the total energy used during on-site construction respectively.

It is concluded that the human energy is close to 1/3 of the total energy used during on-site construction for masonry work. The limitation of this study is that the human energy calculation is based upon the published literature from other countries which may be different with respect to workforce in India. However, this study provides an insight on the significance of human energy in Indian construction projects where substantial amount of human workforce is employed. This work can be further extended for other construction activities.

REFERENCES

- [1] Behm, M., 2008. Construction Sector. *Journal of Safety Research*, 15(2), 175-178.
- [2] Development Alternatives, 1995, *Energy Directory of Building Materials*. Building Materials & Technology Promotion Council, New Delhi, India.
- [3] Dixit, M.K., Culp, C.H. and Fernández-Solís, J.L., 2015. Embodied Energy of Construction Materials: Integrating Human and Capital Energy into an IO-Based Hybrid Model. *Environmental Science & Technology*, 49, 1936-1945.
- [4] Food and Agriculture Organization (FAO) 2001. *Human Energy Requirements*. Report of a Joint FAO/WHO/UNU Expert Consultation in: Food and Nutrition Technical Report Series, vol. 1. FAO, Rome, Italy.
- [5] Held, B.R. 2010. *Human and embodied energy analysis applied to water source protection and household water treatment interventions used in Mali, West Africa*, Thesis (MS). Michigan Technological University.
- [6] Held, R.B., Zhang, Q., and Mihelcic, J.R., 2013. Quantification of human and embodied energy of improved water provided by source and household interventions, *Journal of Cleaner Production*, 60, 83-92.
- [7] Keoleian, G., Blanchard, S. and Reppe, P., 2001. Life-cycle energy, costs, and strategies for improving a single-family house, *Journal of Industrial Ecology*, 4 (2), 135-156.
- [8] Kofoworola, O.F. and Gheewala, S.H., 2009. Life cycle energy assessment of a typical office building in Thailand, *Energy and Buildings*, 41, 1076–1083.
- [9] Ramesh, T., Prakash, R. and Shukla, K.K., 2012. Life cycle energy analysis of a residential building with different envelopes and climates in Indian context, *Applied Energy*, 89, 193–202.
- [10] Ramesh, T., Prakash, R. and Shukla, K.K., 2010, Life cycle energy analysis of buildings: an overview, *Energy and Buildings*, 42,1592–1600.
- [11] Reddy, B.V. and Jagadish, K.S., 2003. Embodied energy of common and alternative building materials and technologies, *Energy and Buildings*, 35, 129–137.
- [12] Shukla, A., Tiwari, G.N. and Sodha, M.S., 2009. Embodied energy analysis of adobe house, *Renewable Energy*, 34 (3), 755–761.
- [13] Swarup, P.R., 2007. *Indian construction industry*, Construction Industry Development Council, New Delhi.

- [14] Varun, Sharma, A., Shree,V. & Nautiyal, H., 2012. Life cycle environmental assessment of an educational building in Northern India: A case study, *Sustainable Cities and Society*, 4, 22-28.

The Life Cycle Cost - Energy Relationship of Buildings

WANG Jie^a, PAN Wei^b

^a The University of Hong Kong, Hong Kong SAR, jwang14@hku.hk

^b The University of Hong Kong, Hong Kong SAR, wpan@hku.hk

ABSTRACT

Buildings account for nearly 45% of the worldwide energy consumption and carbon emissions, and play a vital role in formulating sustainable strategies. Many regions and countries have set targets to achieve low or zero energy in their building energy policies. However, despite the policy drive, the uptake of low energy building (LEB) has been low in practice. Previous research on LEB was largely technical solutions oriented. Some examined the impacts of low energy design solutions on the economic effectiveness and energy efficiency of the building over **the building's lifespan, but there is still a lack of exploration** of the embedded relationship between the cost and energy performance of buildings.

The aim of this paper is to explore the relationship between the costs and energy consumption of buildings from the life cycle perspective. A combination of a critical literature review and case studies of 5 residential buildings selected from UK and Australia was employed for the research. The results of the review suggest that there is second order polynomial regression relationship between the costs and energy consumption of buildings over their lifespans. The optimizations of the cost and energy efficiency of buildings are found to be not mutually exclusive goals, which need to be considered in a synergistic way in order to allow low energy designs and construction practices to be achieved cost-effectively. The findings should inform designers in their decision-making on building design and material selection to make LEB more cost attractive. The identified life cycle cost-energy relationship contributes a novel life cycle perspective to future systemic research into building energy and economics.

Keywords: low energy building, cost-energy relationship, life cycle assessment

1. INTRODUCTION

Buildings take up nearly 45% of the worldwide energy consumption and carbon emissions (Butler, 2008). With the population growth, building services enhancement, comfort level increase and the rise in time spent inside buildings, building energy consumption will experience a predictable growth in the coming future (Pérez-Lombard et al., 2008). It is therefore very important to improve the energy efficiency of buildings in order to alleviate the building energy demand but provide the same or even higher level of the indoor comfort for inhabitants. Low energy building (LEB) has been drawing more and more attention as a result of its superiority on addressing the shortage of energy supply from the building sector through a comprehensive energy systems design.

A number of regions and countries have set regulatory targets to achieve low or zero energy in new buildings within the next decades as part of their building energy policy, like EU and US (Recast, 2010; Sissine, 2011). Despite the policy drive of LEB, the diffusion of LEB in the building market is however slow (Pan, 2014; Pan and Ning, 2015). The prohibitively high costs of low energy design solutions added to buildings are identified as the main barrier (Pellegrini-Masini et al., 2010). A challenging task for architects and other building professionals today is to design and promote LEB in a cost effective and environmentally responsive way (Hui, 2001). Previous research on LEB was largely technical solutions oriented. Some examined the impacts of low energy design **solutions on the economic efficiency and energy use of the general building over the building's lifespan, but scant** research provided an insight into the embedded relationship between the cost and energy consumption of buildings. In addressing this gap in knowledge, the aim of this paper is to explore the relationship between the cost and **energy consumption of buildings from the building's cradle-to-grave** life cycle. Following this introduction, the paper investigates the cost effectiveness and energy efficiency LEBs in a systems manner in order to give a more comprehensive view on different technologies applied to the building. Based on the critical review, case studies of 5 residential buildings selected from UK and Australia is employed to examine the life cycle cost-energy relationship of buildings. The paper then compares and reflects on the results in relation to the findings of previous research, and finally draws conclusions.

2. COST EFFECTIVENESS AND ENERGY EFFICIENCY OF LEBS

In general, energy efficient measures are more indispensable compared with renewable energy and other technologies considering the restrictions come from the cost effectiveness and energy efficiency of the potential technologies as well as building surface area in real ZEB cases (Fong and Lee, 2012). In addition to these common considerations, many regions and countries have their own building energy standards and design guidelines based on the region's typical building designs, local climates, and construction practices (e.g. Zero Carbon Homes and Nearly Zero Energy Buildings in the UK (Regulations, U. B., & Directives, E. U. (2014), ASHRAE Energy-Related standards and guidelines in the US (Holness, 2008) and the Design Standard for Energy Efficiency of Public Buildings in China (Bureau, 2005)).

Author	Country	Building Type	Technologies	Energy Efficiency	Cost Effectiveness
Kneifel (2010)	US	Commercial building	Thermal insulation, low-emissivity windows, window overhangs, and daylighting controls	Conventional energy efficiency technologies can decrease energy use by 20–30% on average and up to over 40% for some building types and locations.	58% buildings have an adjusted internal rate of return above 3.0% with one year study period. Over 56% for all study periods have an AIRR greater than 10%.
Zhu et al. (2009)	US	Residential house	High performance windows, compact fluorescent lights, highly-insulated roofs, air conditioners with water-cooled condensers. PV tiles, thermal mass walls, integrated collector storage	A radiant barrier and a water-cooled air conditioner are major contributors to energy savings; insulated floor slab and thermal mass walls are ineffective. Photovoltaic roof tiles produce enough green power to cover the use, and solar water heater can reach peak efficiency of 80%.	PV tiles show a good financial return when rebates are considered. The Integrated Collector Storage (ICS) unit has a high efficiency but with a little higher thermal price. Thermal mass walls are too costly to have wide market appeal.
Marszal and Heiselberg (2011)	Denmark	Multi-storey residential building	PV and air/solar source heat pump; PV and ground-source heat pump; PV and district heating grid.	The most energy efficient solution is the one in which the PV installation is combined with PV/T and a solar heat pump.	The investment in energy efficiency is more cost-effective than investment in renewable technologies.
Moorea (2014)	Australia	Residential house	6 star building envelope, 8 star building envelop, photovoltaics (PV), a solar hot water (SHW) system).	A single detached 6 star BAU house was calculated to generate 8.3 t/yr of CO ₂ -e for the operational phase of the house.	The ZEH scenario achieves pay-back in around 12 years for a high energy price or 14 years for a low energy price. For low energy price modeling, the 'seven stars' scenario produces optimal NPVs over 5 and 10 years time horizons, 39.23\$AUS/SqM CFA at 5 years and 48.95\$AUS/SqM CFA at 10 Years; for high energy price scenario, 'eight stars' is the optimal across both 25 years and 40 years time-horizons (72.76\$AUS/SqM CFA at 25 years and 99.96\$AUS/SqM CFA at 40 years).
Morrissey and Horne (2011)	Australia	Residential building	Glasswool insulation ceiling, glasswool insulation wall, polystyrene insulation extruded, shading, windows and weatherstrip	'Six stars' scenario brings 24% energy efficiency improvement; 45% for 'Seven stars' scenario; 65% for Eight stars' scenario.	

Table 1: A summary of cost effectiveness and energy efficiency of some recent studies of LEB

3. THE COST-ENERGY RELATIONSHIP OF BUILDINGS

Previous research has realized the importance of identifying the relationship between the cost and energy consumption of buildings. Gustavsson et al. (2010) penetratingly pointed out those connections, trade-offs and synergies between the cost and energy consumption of a building in different phases of the life cycle must be identified in order to ensure that any further energy efficiency improvement of the buildings could be achieved in a cost effective way. Langston and Langston (2008) investigated the relationship between the life cycle energy and capital investment of 30 recently completed residential and commercial buildings, and observed a positive correlation between the predicted life cycle energy and capital cost investment. The same correlation is also found between the embodied energy and cost investment of individual building components as well as of the entire buildings by Jiao et al (2012). Three commercial buildings in China and New Zealand were compared and the results show a stronger correlation of the individual building components compared with that of the entire buildings.

The research was carried out through the examination of the empirical studies of life cycle assessment of buildings. In total 5 buildings with 51 cases from UK and Australia were collected from previous relevant research. Table 2 gives a comprehensive overview of the main characteristics of the cases presented in literature. Where a source is reported to have more than one case, it means that either different design scenarios or research designs, i.e., energy price and studied lifespan, of the same buildings were presented in the source itself. Cases differ for country, climate, type of building, building parameters, type of construction method, assumptions on indoor climate design and occupant behaviour, and source of data (whether measured or calculated). For this reason, it would be inappropriate to directly compare the cases against each other. Rather, the overall variation of the life cycle cost-energy relationship within each individual case has been examined, and then these different variations have been compared amongst the various cases. Cases also differ in the anticipated assumptions for the values of key parameters that are applied in the cost and energy calculations, like discount rate, inflation and studied lifespan, and also floor area. Cost data (life cycle cost and NPV) and energy data were normalized per unit of area (dollar/m²) and per unit of area and time (kWh/m² year) in order to neutralize these differences.

Source	Country	Case numbers	Type of buildings	Area (m ²)	Lifespan (years)	Energy price	Data	Building designs
Cuellar-Franca and Azapagic (2014)	UK	1	Detached house	130	50	NA	T+G	Strip footing, foundations, brick external walls and pitched roofs with, concrete tiles
		2	Semi-detached house	90				
		3	Terraced house	60				
Moorea (2014)	Australia	4-6	Detached house	249.6	60	High	T	Photovoltaic panel, building envelope
		7-9			40			
		10-12			20			
		13-15			10			
		16-18			60	Low		
		19-21			40			
		22-24			20			
		25-27:			10			
Morrissey and Horne (2011)	Australia	28-30,	Detached house	126.52	40	High	T	Glasswool insulation ceiling, Glasswool insulation wall, Polystyrene insulation extruded, Shading, Windows, Weatherstrip glazing and internal wall insulation
		31-33,			25			
		34-36,			10			
		37-39,			5			
		40-42			40	Low		
		43-45			25			
		46-48			10			
		49-51			5			

Note: NA, not applied; G, graph; T, table and/ or text.

Table 2: General information of the selected cases

The relationship between the costs and energy consumption of the studied 51 cases are statistically very significant (Figure 1, 2 and 3). Although linear regression describes the data reasonably well, second order polynomial regressions accounted for more of the variance. In all cases, curvilinear patterns provide the best fit with the data. The r^2 values for the second order polynomial regressions are all equal to 1, which indicates the second order polynomial regressions perfectly fit the data. The limited data size should be taken into consideration for the high r^2 values.

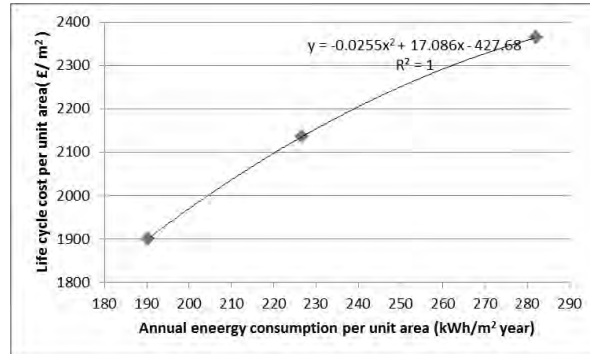

Figure 1: The relationship between the life cycle cost and energy consumption of Cases 1-3

The buildings in Case 1 to 3 are detached house, semi-detached house, and terraced house respectively with the difference in the floor area. The total life cycle cost per square meter increases gradually as the annual energy consumption per square meter grows (Figure 1). In a world, the most energy saving house may have the lowest life cycle cost. This result conforms to the general costs and energy consumption patterns of buildings. The assumptions made in this examined research are also quite reasonable. Owing to relative small proportion that construction cost takes in the overall life cycle cost of buildings, the construction and end-of-life costs are assumed to be similar for the detached house, semi-detached house and terraced house, albeit they are varies in building area. In addition, another assumption is that the household size for all three types of houses is the same, and thereby the energy used for water heating, cooking and appliances is the same. Therefore, it is not surprising that the larger floor area (e.g. detached house), which has a lower energy use per unit area, will have a lower life cycle cost per unit area than a smaller one (e.g. terraced).

In Cases 4-27, three different design scenarios with three different levels of annual energy consumption, i.e., 33.49, 48.08 and 60.9 kWh/m² in respective are applied in a detached house (Figure 2). Each group of data represents three different levels of annual energy consumption and associated NPV under different examined lifespans and energy prices. The figure shows that the NPV per unit area rapidly rise with the energy consumption per unit area goes up.

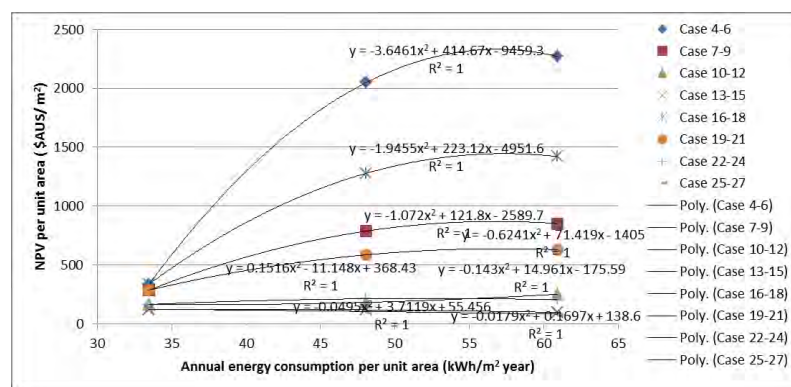

Figure 2: The relationship between NPV and energy consumption of Cases 4-27

In Cases 28-51, three different design scenarios with three different levels of annual energy consumption, i.e., 64, 100 and 138 kWh/m² in respective are applied in a detached house (Figure 3). Each group of data represents three different levels of annual energy consumption and associated NPV under different examined lifespans and energy prices. The figure shows that the NPV per unit area decreases slowly as the energy consumption per unit area increases.

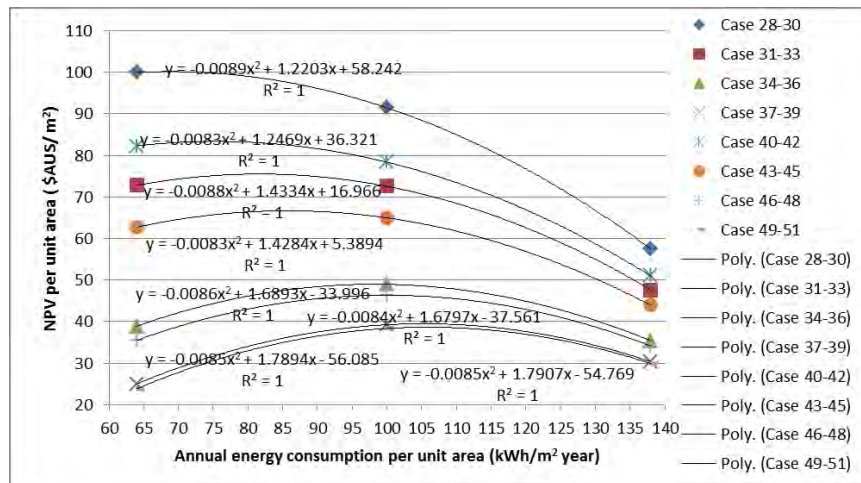

Figure 3: The relationship between NPV and energy consumption of Cases 28-51

Compared Cases 4-27 with Cases 28-51, the key similarity concluded from Figure 2 and 3 is that both energy-efficient and renewable technologies are found to have positive influences on the building's energy consumption and overall cost performance over the study periods. Furthermore, longer study lifespan and high energy price would bring a higher NPV compared with shorter study lifespan and low energy price. However, the major difference comes from the variation direction of the two groups of lines. In Cases 4-27, a positive relationship is found between NPV and annual energy consumption, while a negative relationship is found in Cases 28-51. Such difference may be attributed to the economic efficiency of examined low energy designs applied on buildings. Cases 4-27, both energy-efficient measures and renewable technologies (e.g. photovoltaic panel) are studied in the life cycle cost and energy performance evaluation of zero (net) energy house, while Cases 28 to 51 examined the impacts of energy-efficient measures only on the cost performance and energy consumption of the building. The economic efficiency of photovoltaic panel is relatively lower over economic-efficient technologies. The cost of installing photovoltaic panel is quite high in order to achieve a low level of energy consumption and therefore leads to a low NPV value. However, the high NPV will be abstained to achieve the same energy consumption level through the application of mere energy-efficient technologies.

4. DISCUSSION

The results of this study support the finding of previous research that a correlation is embedded between the costs and energy consumption of buildings over the building's lifespan. Also, this paper contributes to elaborating such relationship by deriving three improvements. Firstly, the results identify the second order polynomial regression relationship exists between the costs and energy consumption of buildings over their lifespans. Secondly, the results suggest the economic efficiencies of the applied low energy design solutions crucially determine such relationship is positive or negative. Finally, the results highlight the importance of the longer study lifespan in improving the significance of such relationship. Langston and Lauge-Kristensen (2013) emphasized that cost should also be accounted over a longer time span when conducting the life cycle costing of an asset since any shorter lifespan that is applied cannot ensure sufficient time for the energy efficient building to maximize its economic efficiency.

5. CONCLUSIONS

This paper has examined the embedded life cycle cost-energy relationship of buildings. The research was carried out through a combination of a critical literature review and case studies of 5 building selected from UK and Australia. The paper concludes that there is second order polynomial regression relationship exists between the costs and energy consumption of buildings over their lifespans. This paper suggests that the optimizations of the costs and energy efficiency of buildings are not mutually exclusive goals, which need to be considered in a synergistic way in order to allow low energy designs and construction practices to be achieved in a cost-effective way. The identified relationship between the costs and energy consumption of buildings can be exploited to enable better design solutions to be identified. The low and zero energy designs usually apply to exist the low-rise buildings from a variety of demonstration projects (Fong and Lee, 2012), especially in residential buildings. Nevertheless, it

has been proven that a certain amount of potential for energy saving can be achieved on office buildings in Hong Kong (Lee and Yik, 2002). The embedded life cycle cost-energy relationship of high-rise buildings in Hong Kong should be investigated in future research to identify the most economical and environmental-friendly design solutions.

REFERENCES

- [1] Bureau, B. C. (2005). Design standard for energy efficiency of public buildings. China Architecture and Building Press (Also available at: <http://bbs.topenergy.org/redirect.php>).
- [2] Butler, D. (2008). Architects of a low-energy future. *Nature*, 452(3), 520-523.
- [3] Cuellar-Franca, R. M., & Azapagic, A. (2014). Life cycle cost analysis of the UK housing stock. *International Journal of Life Cycle Assessment*, 19(1), 174-193. doi:DOI 10.1007/s11367-013-0610-4.
- [4] Fong, K. F., & Lee, C. K. (2012). Towards net zero energy design for low-rise residential buildings in subtropical Hong Kong. *Applied Energy*, 93, 686-694.
- [5] Gustavsson, L., Joelsson, A., & Sathre, R. (2010). Life cycle primary energy use and carbon emission of an eight-storey wood-framed apartment building. *Energy and Buildings*, 42(2), 230-242.
- [6] Holness, G. V. (2008). Improving energy efficiency in existing buildings. *ASHRAE Journal*, 50(1), 12-27.
- [7] Hui, S. C. (2001). Low energy building design in high density urban cities. *Renewable energy*, 24(3), 627-640.
- [8] Jiao, Y., Lloyd, C. R., & Wakes, S. J. (2012). The relationship between total embodied energy and cost of commercial buildings. *Energy and Buildings*, 52, 20-27.
- [9] Kneifel, J. (2010). Life-cycle carbon and cost analysis of energy efficiency measures in new commercial buildings. *Energy and Buildings*, 42(3), 333-340.
- [10] Langston, Y. L., & Langston, C. A. (2008). Reliability of building embodied energy modelling: an analysis of 30 Melbourne case studies. *Construction Management and Economics*, 26(2), 147-160.
- [11] Lee, W. L., & Yik, F. W. H. (2002). Regulatory and voluntary approaches for enhancing energy efficiencies of buildings in Hong Kong. *Applied Energy*, 71(4), 251-274.
- [12] Marszal, A. J., & Heiselberg, P. (2011). Life cycle cost analysis of a multi-storey residential net zero energy building in Denmark. *Energy*, 36(9), 5600-5609.
- [13] Moore, T. (2014). Modelling the through-life costs and benefits of detached zero (net) energy housing in Melbourne, Australia. *Energy and Buildings*, 70, 463-471.
- [14] Morrissey, J., & Horne, R. E. (2011). Life cycle cost implications of energy efficiency measures in new residential buildings. *Energy and buildings*, 43(4), 915-924.
- [15] Pan, W. (2014). System boundaries of zero carbon buildings. *Renewable and Sustainable Energy Reviews*, 37, 424-434.
- [16] Pan, W., & Ning, Y. (2015). A socio-technical framework of zero-carbon building policies. *Building Research & Information*, 43(1), 94-110.
- [17] Pellegrini-Masini, G., Bowles, G., Peacock, A. D., Ahadzi, M., & Banfill, P. F. (2010). Whole life costing of domestic energy demand reduction technologies: householder perspectives. *Construction Management and Economics*, 28(3), 217-229.
- [18] Pérez-Lombard, L., Ortiz, J., & Pout, C. (2008). A review on buildings energy consumption information. *Energy and Buildings*, 40(3), 394-398.
- [19] Recast, E. P. B. D. (2010). Directive 2010/31/EU of the European Parliament and of the Council of 19 May 2010 on the energy performance of buildings (recast). *Official Journal of the European Union*, 18(06), 2010.
- [20] Regulations, U. B., & Directives, E. U. (2014). Zero carbon homes and nearly zero energy buildings. Zero Carbon Hub, London.
- [21] Sissine, F. (2011). CRS Report for Congress. Energy Independence and Security Act of 2007.
- [22] Zhu, L., Hurt, R., Correa, D., & Boehm, R. (2009). Comprehensive energy and economic analyses on a zero energy house versus a conventional house. *Energy*, 34(9), 1043-1053.

Session 5.5: SBE Assessments – Green Building Policies

From Research to a National Standard: SBTool and Protocollo ITACA

Andrea MORO^a

^a iiSBE Italia R&D, Italy, andrea.moro@iisbeitalia.org

ABSTRACT

In the context of the European research project (Environmentally Compatible Job), the Italian national team was established in 2000 to participate in the Green Building Challenge process (GBC). The GBC was launched some years before to create an international generic framework useful to develop locally contextualized building **assessment tools. At that time the name of the framework was “GBTool”, now known as “SBTool”.** A first contextualized version of GBTool to Italy was presented on the occasion of the Sustainable Building 2002 conference in Oslo. The same year the annual meeting of the IFC (International Framework Committee), the managing structure of GBC, was hosted in Torino (Italy). On that occasion a seminar was organized to show the state of art at word level about sustainability assessment systems. On that occasion, ITACA (Federal Association of the Italian Regions) decided to adopt GBTool to develop a new public assessment system: Protocollo ITACA. The need of the Italian region was to improve the impact of incentive based policies for sustainable buildings. The integration of an assessment tool in such policies was considered a good strategy. From 2002 to 2003 the first version of Protocollo ITACA was developed. In January 2004 the conference of the Presidents of the Italian Regions officially adopted it. With the support of iiSBE Italia, progressively 15 Italian regions adopted Protocollo ITACA and started to implement it in policies, building codes, urban plans, public tenders, etc. Actually more than 2000 buildings have been assessed in the context of public initiatives. The next step has been in 2015 the recognition of Protocollo ITACA by the Italian National Standardization body UNI as national standard (UNI PdR13:2015) and the set-up of a certification system under national accreditation (Accredia RT33). This made the assessment system fully suitable for market uses.

Keywords: policy and regulation, green rating tool, green procurement

1. THE PROJECT ECJ AND THE GREEN BUILDING CHALLENGE

In the late 90's, one of the first European projects dealing with the topic of green building, ECJ – Environmentally Compatible Jobs, was exploring the possible drivers to move the Italian building practice towards a better energy-environmental performance. The idea at the base of the project was to create new job opportunities for professionals, workers and construction companies through the widespread of green building principles in the building sector.

Among the possible drivers one was considered of the maximum importance: the availability of a national building **rating system. In Italy at that time, environmental building assessment systems weren't known at all. Only the** energy certification was widespread because mandatory. In general, sustainable building was a new them for the Italian building sector.

The ECJ project considered the development of an Italian rating system a prior driver for two reasons. The first, a building assessment systems gives to green buildings the possibility to emerge in the real estate market. A label is the objective proof of a superior quality. Consequently, the availability of a national rating system was expected to stimulate the investments in green building because potentially more profitable. The second, a building assessment systems allows public authorities to raise the impact of their sustainable building policies. A rating system can be used to fix in a measurable, reliable and verifiable way the performance targets of a policy, program, regulation. The assessment systems can be linked to incentive based policies, building codes, urban plans, public tenders, etc.

The first task accomplished in ECJ was a state of art study about the existing building assessment systems. BREEAM was already consolidated and LEED was emerging. But at that time, both systems were considered not **contextualizable to Italy. The “contextualization” was considered a fundamental principle for a new national** assessment system. Contextualization means the use of local technical standards and the capability to reflect the

national priorities with regards to environmental, social and economic issues. Following this approach, the GBTool was chosen as reference framework.

1.1. The Italian national team in GBC

In 2000 the Italian National Team in the Green Building Challenge (GBC) international process was set up with the participation of many relevant national organizations such as the Italian National Research Council, ENEA, Politecnico of Torino, Politecnico of Milan, Environment Park.

The Green Building Challenge was a world level initiative, initially coordinated by NRC Canada and later by iiSBE (international initiative for a Sustainable Built Environment), for the development of a transnational generic assessment framework (GBTool). Through the contextualization of GBTool it is possible to develop local tools. The contextualization process of GBTool consists in the selection of the criteria of interest, the assignment of a weight to criteria, categories and issues and the definition for each criterion of a performance scale based on regional benchmarks (minimum acceptable performance). In this way all countries involved in GBC had the possibility to share the same harmonized methodological approach, criteria and indicators with the possibility to develop a full contextualized local tool.

In the period from 2000 to 2002 the Italian National Team developed the first version of GBTool for Italy that was tested on residential buildings, offices and a shopping centre. The Italian Team **participated to the IFC's activities** (International Framework Committee) formed by all the national coordinators. The role of the IFC was to improve and update the Generic Framework. The role of national teams to contextualise it.

In 2002 the results of the first GBTool test in Italy were presented in occasion of the Sustainable Building conference organized in Maastricht. The first relevant use of the Italian version of GBTool was in the Guidelines for the Sustainability of the Olympic Villages on the occasion of the XX Olympic Winter Games hosted in Torino **(Italy). The Guideline was intended to drive the design and construction activities of the media and athletes' villages** and addressed to residential buildings. Always in 2002 the annual meeting of the IFC was hosted in Torino. On that occasion the first conference on green building rating systems in Italy was organized. In that period 25 national Team were active in GBC and the conference illustrated the results achieved by all of them in their countries. Among the participants there was a key organization: ITACA

2. FROM GBTOOL TO PROTOCOLLO ITACA

ITACA is a no profit association whose members are the Italian regions. By the Title 5 of the Italian Constitution, energy and environment fall into the competence of regions. In 2001 ITACA activated a working group to define harmonized regional policies for the promotion of green building in Italy. The main objectives of ITACA was to develop a public rating system to support regional policies targeted to green building. After the GBC conference in Torino, above mentioned, ITACA asked the GBC Italian Team to collaborate. For ITACA, GBTool was the perfect tool to develop the new public assessment system with a regional approach. Italy is composed by 20 regions with very different climate conditions and building practices. The intention of ITACA was to develop a national version of the new assessment tool and then to leave the regions to further contextualize it modifying weight and benchmarks to better reflect the local conditions.

In 2003 the new tool based on GBTool was ready and it was named Protocollo ITACA. On January 2004 Protocollo ITACA was officially adopted by the Conference of the Presidents of the Italian Regions. Since that moment, Protocollo ITACA is the official public assessment tool of the Italian regions. Starting from 2004, the Italian regions began to adopt Protocollo ITACA and to use it in public policies. The first one was Regione Piemonte that included the assessment tool in a very important urban retrofit program (Neighbourhood Contracts II) giving incentives based on the level of score produced by the application of Protocollo ITACA. Other regions (Tuscany, Marche, Puglia, Liguria, etc.) followed.

Considering the increasing use of the Protocollo ITACA and the need expressed by the Regions to be supported in its implementation in new policies, iiSBE Board of Directors decided to establish a national chapter in 2005: iiSBE Italia. The national chapter acts on behalf of iiSBE and manages the use and implementation of GBTool in the Italian context. An agreement between iiSBE Italia and ITACA is then signed. iiSBE Italia is recognized as the

technical control body of the Protocollo ITACA assessment system. Since that moment iiSBE Italia is supporting ITACA in the developments and update of Protocollo ITACA.

A major update was done in 2007. Beside the full version of the assessment systems (70 criteria) it was produced a light version (15 criteria). The idea was to facilitate the use of Protocollo ITACA by professionals, considering **that the wide majority of them was not used at all to building rating systems. A “compact” version was intended to be more easily “acquired” in a first phase by professionals and organizations in the building sector. This strategy** showed to be very effective helping a wider use of Protocollo ITACA.

In 2009 and 2011 new versions of the national system was issued following the new Italian energy regulations. A key principle in the development of Protocollo ITACA is its total alignment with the national and regional energy certification standards and with the Italian technical standards (UNI). This alignment allows to reduce the effort, in terms of cost and time, necessary to apply Protocollo ITACA. The energy calculations done for the mandatory national certification are the same one requested in Protocollo ITACA.

3. FROM PROTOCOLLO ITACA TO A NATIONAL STANDARD

In 2011 about 2000 buildings were already assessed in Italy with the 15 different regional versions of Protocollo ITACA. In that period, the private sector started to ask ITACA to implement a national certification system fitting also the market needs. Up to that moment the use of Protocollo ITACA was limited to public policies. Almost the 99% of the 1500 buildings were certified because a public incentive or regulation. The Protocollo ITACA systems **was not organized to act as certification system for the real estate market. In 2011 in many regions it wasn't** possible to receive a voluntary Protocollo ITACA certification if not in the context of a policy or program.

The private sector was asking an assessment system operational and accessible in the whole country based on a unique standard. What was appreciated by the private construction companies of Protocollo ITACA is its affordability, operability and limited cost maintaining in the same time the technical and scientific value of the assessment. All element favourable for a mass diffusion of building certification.

To answer this need, the strategy of ITACA and iiSBE Italia has been developed in two directions. The first move has been to transform the national version of Protocollo ITACA in a national standard (UNI). The second to define a certification process under national accreditation.

3.1 The new national standard: UNI PdR13

In 2012, an agreement was signed between ITACA and UNI (Italian National Standardization Body) and a working group activated with the support of iiSBE Italia. In less than one year, the 2011 version of Protocollo ITACA was updated in the UNI PdR 13 standard, **named “Environmental sustainability of construction works - Operational tools for sustainability assessment”**.

The PdR 13 is articulated in three sections. The PdR 13.0 concerns the “General framework and methodological principles”. The methodology described is the SBTool. This origin of Protocollo ITACA and PdR 13 is declared in the first part of the standard. The other two sections (PdR 13.1 and PdR 13.2) contains the description of criteria, indicators and assessment methods for the residential buildings (PdR 13.1) and non-residential buildings (PdR 13.2). UNI is the only organization allowed to distribute the PdR13. The document is downloadable form the UNI website for free because it is a public assessment tool. With this move two objectives were reached. The first was to make available in the whole country a national assessment tool as UNI standard. The second to strength the **value of Protocollo ITACA. Today it isn't anymore only the public assessment system of the Italian regions but** instead it is the official technical assessment tool for Italy.

3.2 The implementation of the national certification process

Always in 2012 a second agreement was signed between ITACA and Accredia. Accredia is the national Italian accreditation body. It is the national organization that accredits certification bodies to can carry out inspections and audit activities with regards to UNI standards. ITACA and Accredia, with the support of iiSBE Italia, defined the Technical Regulation 33 (RT33) for the accreditation of organizations with respect to UNI PdR 13 – Protocollo ITACA. To be accredited a certification body must comply with the RT 33 requirements. One of them is the availability of an accredited assessor. This one is a professional, usually an architect or engineer, that took a

training course and passed an examination. The accreditation of assessors is done by ITACA. Training courses and exams are organized and managed by iiSBE Italia.

3.3 The implementation of the national certification process

To manage the whole national system ITACA created a new no profit organization, the Comitato Protocollo ITACA. Comitato Protocollo ITACA is the organization that manages the national registry of certifications and that issues the certificate on the base of the audits done by the accredited certification bodies.

iiSBE Italia collaborate with Comitato Protocollo ITACA performing the second level audit, controlling the work done by the certification bodies. To obtain a Protocollo ITACA certificate the owner of the building can choose any **accredited organization consulting the national registry that is a web based portal. He's free to choose its preferred certification body.** The PdR13 is a fully certification system following the ISO requirements in this field.

The establishment of the PdR13 not only made available a fully operational national certification system to the private sector. It is also encouraging the adoption and use of Protocollo ITACA by public administrations, such as municipalities or agencies. One of the main problems in the use of a rating system in local policies is the control of the assessment. For instance, if an incentive, financial of other nature (i.e. increase of volume), depends on the score achieved by the building, the public administration should be able to check the assessment report provided by the owner or the professional. This aspect created in the past many problems. With the RT33 and the new national certification process a public administration just has to ask a certificate issued by the national registry.

This approaches combines the public and private needs in one open and transparent systems that is expected will encourage the mass diffusion of sustainability certification in Italy.

REFERENCES

- [1] Green Building Challenge. Retrived from www.iisbe.org
- [2] Protocollo ITACA. Retrieved from www.itaca.com
- [3] UNI PdR13. Retrived from www.uni.com

The Network for Sustainable Federal Building as an Instrument of Quality Assurance in The Implementation of the Assessment System BNB in The Public Sector

Andreas RIETZ^a, Nicolas KERZ^b, Merten WELSCH^c

^a Federal Institute for Research on Building, Urban Affairs and Spatial, andreas.rietz@bbr.bund.de

^b Federal Institute for Research on Building, Urban Affairs and Spatial, nicolas.kerz@bbr.bund.de

^c Federal Institute for Research on Building, Urban Affairs and Spatial, merten.welsch@bbr.bund.de

ABSTRACT

With the introduction of the Guideline for Sustainable Building the Federal Government has enforced an important component of its sustainability strategy in the public sector. In the first step the Federal Building Authorities are obliged by edict to evaluate their buildings, using the Assessment System for Sustainable Buildings (BNB). BNB has become the most important tool to implement high quality standards. The actual task is, to establish good conditions for a broad implementation of the BNB into practical work of the public sector in total. The leading question is, how the Network for Sustainable Federal Building can be used as a quality assurance tool within the implementation of the BNB in the public sector.

The Office on Sustainable Building within the Federal Institute for Research on Building, Urban Affairs and Spatial Development (BBSR) has the task of advising the Federal Ministry for the Environment, Nature Conservation, Building and Nuclear Safety (BMUB) concerning Sustainable building and supporting and coordinating the Network for Sustainable Federal Building. The BBSR also develops and coordinates research projects in the frame of the **“Research Initiative Future Building” in order of the BMUB. This includes activities related to the development of instruments and tools for the application of the Assessment System BNB and the scientific evaluation of results from the implementation.**

The Network for Sustainable Federal Building brings together around 380 BNB sustainability coordinators from federal and state administrations, thereby creating an internal information and communication platform. One key element of the network is the annual convention for all those who apply the BNB. It gives the chance to regularly exchange experiences on implementing the BNB in the relevant building authorities.

The paper will show first results from the implementation in practice. Further information is carried out with the **Information Portal Sustainable Building** [“http://www.nachhaltigesbauen.de/”](http://www.nachhaltigesbauen.de/).

Keywords: policy and regulation, green rating tool, public sector

1. INTRODUCTION

With the introduction of the Guideline for Sustainable Building in 2001 the Federal Government has enforced an important component of its sustainability strategy in the public sector. It was made obligatory for the Federal Building Authorities and operates as a practical aid in the planning phase, the construction, the utilisation including the structural maintenance and the modernisation.

In March 2011, a reworked version of the Guideline for Sustainable Building was introduced by the German Federal Building Ministry. Thus the Federal Building Authorities were obliged by edict to evaluate Office and Administration Buildings, using the Assessment System for Sustainable Building (BNB). Using the Assessment System is voluntary for other building authorities, such as Federal States, municipalities or the private sector.

The Office on Sustainable Building within the Federal Institute for Research on Building, Urban Affairs and Spatial Development (BBSR) has the task of advising the Federal Ministry for the Environment, Nature Conservation, Building and Nuclear Safety (BMUB) concerning Sustainable building and supporting and coordinating the Network for Sustainable Federal Building. The BBSR also develops and coordinates research projects in the frame of the **“Research Initiative Future Building” in order of the BMUB. This also includes activities related to the development of instruments and tools for the application of the Assessment System BNB and the scientific evaluation of results from the implementation into practice.**

2. EVALUATION OF SUSTAINABILITY IN THE PUBLIC SECTOR IN GERMANY

2.1 The round table for sustainable building

According to the national Sustainability Strategy in Germany the Round Table for Sustainable Building was established in 2001, as an advice board for the Federal Building Ministry, and has since then supervised the development of sustainable building on a federal level. The Round Table is constituted of numerous representatives from the building industry, the building materials industry, the Chamber of Architects, the Chamber of Engineers, federal, state and municipal building authorities as well as scientific institutions.

The continuous involvement of the Round Table ensures the further development of sustainable building, with a high level of acceptance within the German building sector. The different working groups of the Round Table make a key contribution to the systematic and content-based development of a uniform national assessment system in Germany, which also forms the basis of the Assessment System for Sustainable Building (BNB). Furthermore, the federal states and municipalities will receive information and advice, to strengthen the implementation at the same level.

2.2 The guideline for sustainable building

As a result of concrete specifications by the Federal Ministry for the Environment, Nature Conservation, Building and Nuclear Safety (BMUB), the Guideline for Sustainable Building [BMUB, 2014] and the introduced Assessment System for Sustainable Building (BNB) [BMUB, 2016a] have become the most important tools with which to implement high quality standards in federal construction. With the introduction of the Guideline for Sustainable Building the Federal Government has enforced an important component of its sustainability strategy in the public sector.

The Guideline for Sustainable Building explains the generally valid principles and methods for sustainable planning, building, operation and use of buildings and properties. It thus addresses both, the planning, design and construction as well as the use and operating phase of existing buildings. However, this Guideline also serves as a tool when it comes to considering aspects of sustainability during the entire life cycle of buildings and properties. Therefor the Guideline is broken down into the following parts:

- Part A - Principles of sustainable building
- Part B - Sustainable building projects
- Part C - Recommendations for the sustainable use and operation of buildings
- Part D - Refurbishment of buildings

The documents needed to implement the Guideline for Sustainable Building are included in Annexes and can be **downloaded via the "Information Portal Sustainable Building"** (www.nachhaltigesbauen.de). These documents include, for instance, the criteria profiles, input data or minimum fulfilment levels for the BNB Assessment System. This concept enables the ongoing updating of the information, tools and other documents which supplement this Guideline and thereby ensures that these documents are as up to date as possible.

3. NEW QUALITY STANDARD FOR FEDERAL BUILDINGS

3.1 The assessment system for sustainable building

Various research projects, **financed under the Research Initiative "Future Building" of the Federal Ministry for the Environment, Nature Conservation, Building and Nuclear Safety (BMUB)** provided the basis for a research- and planning-based sustainable construction evaluation system for office and administrative buildings, being advanced as **"Assessment System for Sustainable Building - BNB"**.

The System follows an integrated approach of evaluation taking the life cycle of a building into account and carrying out quantification according to transparent and comprehensible rules. For the actual observations of the life cycle, the first 50 years of a building are worked into the calculations. The Evaluation is based in five main groups of criteria of sustainable building: ecological quality, economic quality, sociocultural and functional quality, technical quality and process quality.

The main goal sought in the ecological dimension is primarily the protection of resources by optimally using construction materials and products, minimizing use of space and of media (e.g. heat, electricity and water).

All requisite energy and material flows from the gain through the refinement and transport to the installation or disassembly alongside the global and local effects on the environment made by the energy use of the construction materials or the buildings are considered. Generally, this reduces environmental pollution at a local and global level. Different methods of analysis, e.g. risk analysis, analysis of the material flow, the material analysis and the ecological balance, are to be applied to objectively assess the environmental compatibility of construction products and of the whole building concept.

The costs which go above and beyond the mere costs of purchase and assembly – especially the life cycle costs are considered in the economical dimensions of sustainability. This places the focus on life cycle costs relevant to the building, the economic viability and the value stability. As practice has shown, the life cycle costs can by far exceed the costs of construction. By analysing the life cycle costs, considerable opportunities for saving money during planning can be identified. As Life-Cycle-Costs (LCC), the costs of construction, the construction use costs and the demolition costs are additionally considered.

In addition to the question of functionality, the question of aesthetic design, the health aspects and comfort are relevant points in considering the social and cultural dimensions of sustainability. Winter and summer heat insulation contributes to comfort just as much as the noise protection or a deliberately chosen type of construction material (e.g. the use of emission free products). Construction designs, choice of material, building construction and technology are to be interpreted to that effect and to be optimised, if needed. At the same time the construction design is to be made flexible enough that it can be easily adapted to the changing parameters e.g. change of use/ user.

Alongside the ecological, economical and sociocultural aspects, the functional and technical properties (technical quality), the planning and implementation (process quality) and the local characteristics are decisive for the description and value of a building. This has extended the three columns of sustainability to five quantifiable qualities of sustainability – informatively supplemented by the local characteristics. The various aspects of sustainability interact directly with each other, so that the goal becomes a holistic and simultaneous assessment of every aspect.

The BNB is organized into three different levels. The actual definition of the qualities takes place on the criteria level. These are described in detail in 45 criteria profiles on the basis of a total of around 150 indicators. The criteria profiles are grouped thematically in 11 criteria groups and 6 main criteria groups, thus making it possible to identify special qualities on each level. An overall score is calculated, based on the evaluation results and a specific weighting. The location profile, which is influenced by the planning activities only in a limited degree, is mentioned separately. The modular structure of the system enables a differentiated presentation of the results; particular attention can thus be drawn to exceptional qualities in one or more subordinate areas of the assessed building. Depending on the overall performance, the building can be awarded with a bronze, silver or gold certificate.

The Federal Ministry for the Environment, Nature Conservation, Building and Nuclear Safety (BMUB) therefore provides free available quantitative data for life cycle analysis, which ensure that sustainability criteria can be included in planning and construction processes and comprehensively documented. BNB enables a transparent and objective evaluation of the sustainability of public buildings.

3.2. Development of instruments and tools

Different fundamental tools are available to support the application of the Assessment System BNB in the federal building authority. These tools are designed **within the frame of various research projects of the “Research Initiative Future Building” to enable and ensure the integration of sustainability aspects into planning, design and execution and their documentation.** These include tools like:

- eBNB - Electronic assessment system for sustainable building
- WECOBIS - Ecological building material information system
- eLCA - Electronic life cycle assessment tool
- ÖKOBAUDAT - Online building material database

During the planning and construction phase a wide range of relevant data from various sources would be generated by the project participants. It is necessary to integrate selected data into the Assessment System BNB to get an auditable data base for the assessment and the documentation of the sustainability. The Electronic Assessment System for Sustainable Building (eBNB) [BMUB, 2016b] enables the project-related collecting, recording and controlling of all parameters necessary to effectively implement the requirements of sustainable Building. The data can be used during the planning and building process for controlling, after finishing the building for quality assessment and during the using phase to evaluate its success.

The development of the eBNB was commissioned as a project within the frame of the Research Initiative Future Building of the BMUB. The target was to develop a computer-assisted assessment and documentation tool, ensuring planning and building support through the Assessment System BNB by providing a project management system that was oriented towards sustainability. In addition to this eBNB should also allow the scientific evaluation of building measures and the generation of parameters for future projects. It is applied during all life-cycle phases of a building and also serves to maintain and continuous develop the assessment methods of the BNB. **Initial results already indicate the project's comprehensive success.**

WECOBIS [BMUB, 2016c] is a web based building material information system providing basic knowledge about healthy and ecofriendly construction. This web portal was developed by the Federal Institute for Research on Building, Urban Affairs and Spatial Development (BBSR) and the Bavarian Chamber of Architects, the contents are edited by an international group of specialized editors. WECOBIS categorizes environmental and health aspects of building materials according to the life cycle phases. With the focus on the Assessment System BNB, WECOBIS offers especially prepared knowledge on building materials for certain BNB criteria profiles.

Building activities are characterized by enormous energy and material flows. The effects of a building on resource consumption can be described based on the eco-balance methodology. The Electronic Life Cycle Assessment Tool eLCA [BBSR, 2016] has been developed under guidance of the BBSR to support users calculating the impacts on the global and the local environment. In conjunction with the online database ÖKOBAUDAT, eLCA offers a quantitative assessment across the entire planning process. The application of eLCA by different users in a longer test phase, among others in the building authority as well as universities, attest, that this instrument is well suited to implement the expected goals.

ÖKOBAUDAT [BMUB, 2016d] makes available quality-checked product-related data sets from the construction sector for all relevant building materials on the basis of their life-cycle phases. These generic data from the Environmental Product Declaration (EPD), compliant to the European DIN EN 15804, can be directly exported to the eLCA tool. In this form, the eco-balance enables a significantly higher quality of decision-making during the planning process.

4. IMPLEMENTATION OF THE SUSTAINABILITY ASSESSMENT

4.1. Federal building authorities

In the first step the Federal Building Authorities are obliged by edict to evaluate their buildings, using the Assessment System for Sustainable Buildings (BNB). For instance for newly erected office, administration, **educational and laboratory buildings with investment costs of €2 million and above, the appropriate BNB requirements must be applied so that the building quality fulfils the "Silver Standard". This Standard is going far beyond today's usual standards in terms of energy efficiency, environmental effects and user comfort, among others.** The Federal Government plays a model role, especially with gold standard certified buildings. Ambitious new construction projects such as the Federal Environment Agency in Berlin-Marienfelde and the Federal Ministry of Education and Research (BMBF) in Berlin have **already been awarded the highest "Gold Standard" BNB certification.**

The BMBF is the first federal civil building project that was realised by Public Private Partnership (PPP) and also the first building of that kind and size that received a certificate of BNB in gold. The project distinguishes itself by very high qualities and degrees of fulfilment in all main criteria groups of the assessment system BNB (81 % - 99 %). This outstanding pilot project is now the best federal building according to proven sustainability requirements. The six-storey building of the Federal Ministry of Education and Research (BMBF) was designed for about 1.000

office workplaces and is integrated in the existing development at the Berlin “Spreebogen” vis-a-vis the government district as a recognizable city block.

The energy concept for BMBF combines measures of optimizing the building physics according to the construction and technical systems which are in some places conventional and in other places very innovative. The project could be realized in a high economic efficiency with a high energy quality and a high level of comfort for the user. In order to ensure the flexibility and adaptability of the building for possible changing user demands in the future, the building enables different types of efficient office structures. The requirements according to the user demand for a high level of comfort are met by numerous aspects. An interdisciplinary planning team ensured that the requirements of sustainable building were adhered to using an integral planning and a holistic approach during the whole planning and building process. The procurement and the supply of materials were controlled with an extraordinary effort and the extent and quality of the building and material documentation is exemplary. The degree of fulfilment of the requirements of BNB according to process quality is 99 %.

Beside the BMBF numerous other current federal building projects consider the requirements of the BNB, like for example: the new office building for about 30 employees of the Federal Environment Agency in Berlin is designed **as the first federal “zero energy building” and received the certificate of BNB in gold in 2015.**

The renovation and reconstruction of the listed Federal Constitutional Court in Karlsruhe received the first certificate in silver according to BNB Complete Refurbishment Module, with a view to balancing the existing building structure.

4.2. Network for sustainable federal building

Within the Network for Sustainable Federal Building, the BBSR currently brings together around 380 BNB sustainability coordinators from federal and state administrations, as well as the Institute for Federal Real Estate (BlmA), thereby creating an internal information and communication platform. The Information Portal for Sustainable Building serves as a forum for discussing and sharing experience gathered in practically applying the BNB, thus promoting further development of sustainable building. The experience gathered while applying the BNB system variants in practice is reflected in the FAQs published in the portal.

One key element of the network is the annual convention for all those who apply the BNB, which is organized by the Department of Sustainable Building. It gives sustainability coordinators the chance to regularly exchange experiences on implementing the guideline and the BNB in the relevant building authorities. The two-day event provides a mixture of plenary lectures, discussion groups and workshops on specific themes, such as contractual design, the introduction of new instruments including electronic Life Cycle Assessment (eLCA) and the concrete **study of the building authorities’ practical experiences.**

The Network for Sustainable Federal Building is becoming increasingly important with respect to allocating tasks of compliance testing to federal building authorities. The tasks concerning advice and certification for federal building measures, which were assumed by the BBSR until the end of 2014, will be successively taken over during 2015 by the Federal Office for Building and Regional Planning (BBR) and by the offices responsible for technical supervision in the individual states on their own authority.

On this basis, compliance testing for the overhauled and extended Federal Constitutional Court in Karlsruhe was carried out during its award process by the Baden-Württemberg Control Centre for the Sustainable Building of Federal Buildings. The Control Centre was also assigned with compliance testing of federal building authority measures for the BNB use profile **“Research and Laboratory Buildings”, to ensure a uniform standard of assessment on a federal level.** In coordination with the BBSR, it has already been able to successfully complete compliance testing for four laboratory buildings. The Federal Office for Building and Regional Planning continues to carry out compliance testing for building measures that are implemented on its own account, including for this system variant.

5. CONCLUSION

Sustainable procurement is a fundamental principle of the Federal Government in Germany and the German Assessment System Sustainable Building (BNB) addresses important climate-relevant effects. The Guideline for Sustainable Building was implemented into the practical work of the Federal Building Authorities. All federal projects are a part of the sustainability strategy of the federal government and they demonstrate that higher qualities according to the holistic approach of sustainability can be implemented in daily praxis. The experiences can be used for new recommendations or future requirements for sustainability projects in the public sector. The BNB has been successfully applied for federal buildings.

The intensive specialist exchange between the newly created compliance testing offices and the Office of Sustainable Building achieves quality assurance with respect to the uniform interpretation and application of the BNB and thereby makes a decisive contribution towards implementing sustainable building within federal building authorities. The actual task is, to establish good conditions for a broad implementation of the Assessment System BNB into the practical work of the public sector in total. Now other clients, such as the federal states and the local authorities are invited to make use of the BNB-System. Now the challenge is to introduce the BNB Assessment System in the municipal sector and residential construction.

Further result would be considered by the presentation. More information is carried out in the internet with the **Information Portal Sustainable Building** [“http://www.nachhaltigesbauen.de/”](http://www.nachhaltigesbauen.de/) of the BMUB.

REFERENCES

- [1] [BBSR, 2016] eLCA; Retrieved from: <https://www.bauteileditor.de/> [Retrieved on 30.09.2016]
- [2] [BMUB, 2014] Federal Ministry for the Environment, Nature Conservation, Building and Nuclear Safety (BMUB); 2014. Guideline for Sustainable Building. Vol. 1, Berlin
- [3] [BMUB, 2016a] Assessment System for Sustainable Building (BNB), Retrieved from: <http://www.nachhaltigesbauen.de/> [Retrieved on 29.09.2016]
- [4] [BMUB, 2016b] eBNB - Das Elektronische Bewertungssystem Nachhaltiges Bauen; Retrieved from: <https://www.ebnb.bundesbau.de/ebnb.html> [Retrieved on 30.09.2016]
- [5] [BMUB, 2016c] WECOBIS; Retrieved from: <http://www.wecobis.de/> [Retrieved on 30.09.2016]
- [6] [BMUB, 2016d] ÖKOBAUDAT; Retrieved from: <http://www.oekobaudat.de/> [Retrieved on 30.09.2016]

Competing Visions for Building Materials Assessment in US Green Building Certification Programs

Charles Joseph KIBERT^a, Andriel FENNER^b, Hashem IZADI MOUD^c, Mohamad AHMADZADE RAZKENARI^d, Hamed HAKIM^e

^a University of Florida, United States of America, ckibert@ufl.edu

^b University of Florida, United States of America, fenner@ufl.edu

^c University of Florida, United States of America, izadimoud@ufl.edu

^d University of Florida, United States of America, mahmadzade@ufl.edu

^e University of Florida, United States of America, hamedhakim@ufl.edu

ABSTRACT

The assessment of building materials and products in the US has been rapidly evolving since the onset of the contemporary American green building movement in the early 1990s. Presently three green building organizations, the US Green Building Council (USGBC), the Green Building Initiative (GBI), and the International Living Futures Institute (ILFI), offer competing visions of criteria for sustainable products, among them how to determine the safety of products from a chemical perspective. In assessing the safety of building materials and products in their green building assessment processes, the USGBC Leadership in Energy and Environmental Design (LEED) and the ILFI Living Building Challenge (LBC) rely on hazard-based assessment (HBA) which entails designating specific materials that are not suitable, from a toxicity perspective, for use in a green building. A competing vision, promulgated by the GBI in the forthcoming version of the Green Globes building assessment system, is risk-based assessment (RBA) which contends that simply banning products because they contain certain chemicals is inadequate and unscientific because the dose and the exposure scenario are not considered. Recent changes to **the ANSI/GB01 standard underpinning the GBI's Green Globes certification system** offer an alternative, risk-based approach for assessing materials toxicity.

Hazard-based tools include Cradle to Cradle, DECLARE, and GreenScreen. Some hazard-based tools provide a list of banned materials while others provide a more detailed analysis with various levels of action required depending on the ingredients of the product. Risk-based product assessment tools follow the procedures outlined in NSF/GCI/ANSI 355: Greener Chemicals and Processes Information Standard which provides the rules for this process.

This paper will present trends in building materials/products toxicity assessment and provide an analysis of these approaches regarding their impacts on the stakeholders in the US design and construction industry.

Keywords: hazard-based assessment, risk-based assessment, materials toxicity

1. INTRODUCTION

The sustainability assessment of commercial and institutional buildings in the US dates from 1998 when LEED v1, the pilot version, was completed and issued for testing. Since that time LEED has evolved through several editions: LEED v2 (2000), LEED v2.1 (2002), LEED v2.2 (2005), LEED v3 (2009), and LEED v4 (2013). The early versions of LEED prior to LEED v4 did not address materials toxicity per se but did include consideration of volatile organic compound emissions from interior finishes such as carpeting, paints, ceiling tiles, and other building interior products in the context of indoor air quality. This was also true of the approach used in the first two versions of Green Globes which also addressed VOC emissions from various classes of materials that could affect indoor air quality.

Post-2010 evolutions of LEED and other US green building assessment systems have significantly altered the evaluation of materials and products by including life cycle assessment(LCA), Environmental Product Declarations (EPDs), ingredient reporting, and toxicity evaluations as issues for project teams to consider. This paper will discuss the most recently emerging issue of building materials assessment, materials toxicity assessment, and the two major approaches being used for this purpose risk-based assessment (RBA) and hazard-based assessment (HBA). Building materials toxicity has emerged as an important issue in the green building community and LEED v4, for example, offers three options for addressing so-called chemicals of concern. One of these options is

transparency with the desired outcome being that the disclosure process will motivate manufacturers to more carefully scrutinize their product ingredients and begin a process of eliminating chemicals with documented significant impacts on humans and ecosystems. More recently, ANSI/GB01-2017 (draft), Standard for Green Building Assessment under development by the Green Building Initiative (GBI) that will eventually become an updated version of Green Globes applies a risk-based approach that takes into account the dose and exposure scenario to assess the statistical probability of harm.

2. RISK ASSESSMENT VERSUS HAZARD ASSESSMENT

At present there are two fundamental approaches competing for inclusion in building product toxicity evaluation process: risk-based assessment (RBA) and hazard-based assessment (HBA). HBA relies on so-called red lists of chemicals generated by promulgating organizations that are considered to be problematical for humans or other organisms. According to the International Program for the Good Management of Chemicals (IOMC), hazard is "... the inherent property of an agent or situation capable of having adverse impacts on something, hence the substance, agent, source of energy, or situation having that property." Hazards are based on the toxicity of a chemical, its ability to produce harm and adversely affect living organisms. Chemicals that have such an adverse effect are also referred to as poisons. In the green building context, the impacts of interest are those that affect humans and other living organisms throughout the life cycle of the product or material. In contrast, risk is the "... probability of adverse effects caused under specified circumstances by an agent in an organism, a population, or ecosystem". The relationship between risk and hazard is straightforward and is credited to Paracelsus in 1538:

$$\text{Risk} = f(\text{Hazard} \times \text{Exposure})$$

Equation 1

Risk is a function of both the hazard and the exposure or dose of the chemical based on exposure scenarios. The risk to workers manufacturing a product, to construction workers installing the product in a building, to occupants of the building during the building's use phase, and to demolition workers during the end of life removal phase are likely all different. The science of toxicology, which controls all regulatory decisions regarding chemicals and toxic organisms in food and other products to which humans are exposed, is based on risk. Although common foods often contain small quantities of hazardous substances such as arsenic, nickel, and formaldehyde, government agencies tasked with protecting the general public have determined that if the concentrations of these chemical are below a specified thresholds, then for the likely exposure scenarios the risks are acceptably low. Gasoline and diesel fuels, well-known hazardous chemicals that are toxic and flammable, are used in automobiles and other vehicles because they are engineered to make the risks from chemical exposure, fire, and explosions within an acceptable range.

2.1 HBA for building materials

HBA is predicated on identifying chemicals that can threaten the human and ecosystem health. Chemicals that could be used in green building products and materials and are considered hazards are published as "red lists" generated by green building organizations such as the ILFI use in conjunction with the LBC building assessment system. Perkins + Will, a well-known design firm has developed and publishes a Precautionary List, a variety of a red list for use in its projects (See Table 1). As described by Perkins + Will, "... the Precautionary List includes substances commonly found in the built environment that have been classified by regulatory entities as being harmful to the health of humans and/or the environment." HBA tools such as Green Screen have been developed to provide comprehensive assessment. Referenced in LEED v4, Green Screen reviews 650 internationally recognized lists and sub-lists of high hazard chemicals for its clients for the purpose of highlighting potential problems with their products.

Alkyphenols+	Hexavalent Chromium (VI)
Arsenic*	Hydrofluorocarbons (HFCs)
Asbestos+	Lead
Bisphenol (BPA)	Mercury
Bromochlorodifluoromethane*	Organostannic Compounds
Cadmium	Pentachlorophenol*
Chlorinated Polyethylene (CPE)	Perfluorocarbons (PFCs)
Chlorinated Polyvinyl Chloride (CPVC)	Phthalates
Chlorobenzene+	Polystyrene*
Chlorofluorocarbons (CFCs)	Polyurethane foam*
Chloroprene (2-chloro-1, 3-butadiene)	Polyvinyl Chloride (PVC)
Chlorosulfinated Polystyrene (CSPE)	Short Chain Chlorinated Paraffin+
Copper (for exterior material)*	Urea-Formaldehyde
Creosote	Volatile Organic Compounds (VOCs)
Halogenated Flame Retardants	

Table 1: Chemicals listed in the LBC Red List and the Perkins + Will Precautionary List.

Note: Chemicals that are only on the LBC Red List are designated with a (+) and those that are solely on the Perkins+ Will Precautionary List are followed by a (*). All other chemicals are on both lists.

There is currently no such thing as a standardized red list and there are significant differences in the chemicals listed in the versions published by the ILFI, Perkins+Will, and others. Clearly it is open for question as to why arsenic and asbestos are not on both lists.

Hazard-based assessment does not take into account exposure scenarios and thus there is no associated probability of impacts. Various hazard tools or certifying organizations have different reporting thresholds for determining if a hazardous chemical must be reported. Most require de minimis reporting of chemicals present in a product at a concentration of 1000 ppm (0.1%) or greater, the standard used by the US Environmental Protection Agency. However, some organizations have a requirement to report the presence of all chemicals down to a concentration of 100 ppm (0.01%).

2.2 RBA

The framework and requirements for RBA are described in NSF/GCI/ANSI Standard 355: Greener Chemicals and Processes Information (2011). This standard identifies chemical ecologic, health, and safety characteristics of concern, plus process manufacturing factors for assessing sustainability impacts (i.e., mass efficiency, water usage, energy consumption, bio-based content, and process safety). Risk based assessment requires that the exposure scenario be considered to determine if for a given hazard, a hazardous effect is produced. The route of exposure (oral, dermal, or inhalation) and the amount, duration, and frequency of exposure are all major determinants of toxic manifestation. Product formulation is also important because the other produce constituents such as solvents, binders, surfactants, and viscosity agents greatly affect the exposure and absorption of a hazardous constituent. Additionally, the toxic effects are also a function of the concentration of a hazardous constituent in the product, the total volume used, and the rate of exposure. To be able to fully characterize the hazard of a specific chemical ingredient, the type of effect, the exposure conditions, and circumstances of exposure must be known. The combination of exposure and the spectrum of hazards are expressed as a dose-response relationship. Care must be taken when extrapolating data from, for example, animal tests, where high concentration of chemicals may be used to determine the likely impact on humans for much smaller doses. A number of chemicals on red lists are likely the result of the difficulty in connecting high dose animal test results to human impacts. When the situation has been thoroughly described and the dose-response relationship can be applied, a risk characterization can be performed. This can be carried out using the process described in the national consensus standard, NSF/GCI/ANSI Standard 355. This standard identifies the chemical, ecologic, health, and safety characteristics of concern. It also identifies process manufacturing factors for assessing sustainability impacts such as mass efficiency water usage, energy consumption, bio-based content, and process safety. In the implementation of this process, web-based tools, such as GreenSuite, incorporate algorithms that utilize the ecological, health, and safety hazard characteristics defined in NSF/GCI/ANSI Standard 355 and normalized data to screen and prioritize chemical inventories, determine product risks, or assess comparative product risks for procurement, utilizing objective criteria and standardized hazard characteristic data.

3. MATERIALS HAZARD AND RISK-BASED ASSESSMENT SYSTEMS AND PROGRAMS IN THE U.S.

The following paragraphs describe the most commonly used HBA and RBA systems in the U.S. The HBA systems referred to in LEED v4 include Cradle to Cradle, the Safer Choice Label, the Health Product Declaration (HPD), DECLARE, and GreenScreen. The LBC relies on the DECLARE system, a HBA developed by the LBC promulgating organization, the ILFI. The new version of Green Globes relies on RBA as defined in NSF/GCI/ANSI Standard 355 and implemented in tools such as GreenSuite. REACH is a European system designed as a RBA but the REACH Restricted List is sometimes used to support HBA.

3.1. Registration, Evaluation, Authorization and Restriction of Chemicals (REACH)

REACH is a regulation developed in 2007 by the European Chemicals Agency (ECHA) to improve the human and environmental protection against risks posed by chemicals ranging from industrial processes to day-to-day use. **According to the ECHA, "In principle, REACH applies to all chemical substances; not only those used in industrial processes but also in our day-to-day lives, for example in cleaning products, paints as well as in articles such as clothes, furniture and electrical appliances. Therefore, the regulation has an impact on most companies across the EU. REACH places the burden of proof on companies. To comply with the regulation, companies must identify and manage the risks linked to the substances they manufacture and market in the EU. They have to demonstrate to ECHA how the substance can be safely used, and they must communicate the risk management measures to the users." REACH has four processes to regulate a substance, which include registration, evaluation, authorization, and restriction. Registration is required for all substances manufactured or imported in quantities of over one ton per year, unless no risk is associated with the chemical. The information required for registration varies according to the available information on that chemical, the tonnage to be manufactured/imported, the use, and exposure. In the evaluation phase, manufacturers must electronically submit a Technical Dossier and a Chemical Safety Report (CSR) through the International Uniform Chemical Information Database (IUCLID), a software application used to store and exchange data on chemical's information. The chemical assessment or CSR ensures that the risks from the chemical life-cycle are under control. If risks are not under control and no more iterations are possible to control the negative effects, the chemical use will be restricted and will be included on the REACH restricted list. The REACH regulation is referred to in the LEED v4 rating system under the Material Ingredient Optimization criteria. Although designed for RBA purposes, in the context of LEED v4, the REACH Restricted List functions as a very large red list.**

3.2. Cradle to Cradle

The Cradle to Cradle (C2C) product certification system suggests that products should be designed based on the **nature's model and eco-efficiency**, encouraging the upcycling vision of converting products and materials into biological or technical nutrients at the end of their useful life without compromising the human and environmental health. Therefore, the C2C is a health-based assessment focused mainly on the waste generation of products and the hazard assessment of ingredients. C2C is one of the HBA tools reference in the LEED v4 Materials and Resources category/ The C2C certification is a multi-attribute evaluation on five categories: material health, material reutilization, renewable energy and carbon management, water stewardship, and social fairness. Requirements are completed in chronological order for each category, so the level of accomplishment on each category determines the category achievement rating, which could be Basic, Bronze, Silver, Gold, and Platinum. The product final certification is based on the lowest achievement level from all five categories. The Material Health category has 11 requirements that range from a simple verification on banned chemicals until a hazard-risk **assessment of the product. The very first step for the material assessment is a comparison of the product's chemicals with the two C2C banned lists, a group of chemicals forbidden to be intentionally used over 1000ppm because of their adverse effects on the environmental (Biological Nutrients list) or human health (Technical Nutrients list). The allowable threshold may vary for some chemicals in the Technical Nutrient list if management plans are able to minimize the exposure effects. Manufacturers are required to characterize all homogeneous and generic materials in their products, creating a "Bill of Materials".**

3.3. US EPA: Safer Choice Label

The Safer Choice Label is the most recent update of the program known as "Design for the Environment"(DfE) developed by the U.S. Environmental Protection Agency (EPA) in 1992 to recognize products with reduced impacts for human health and the environment. The program was first developed to help consumers make decisions during purchases. Nowadays, the Safer Choice label is mandated by many jurisdictions and is referred to in the LEED v4 requirements for existing buildings and is preferred for Federal Agencies by virtue of Executive Order 13693 (2015).

Manufacturers are required to disclose all chemicals intentionally added to the product, including those from third-party suppliers, regardless of the percentage on the product. A third-party profiler, normally NSF International or ToxServices, is responsible for developing the hazard profile, and identifies and evaluates the available toxicological and environmental fate data. The report is reviewed by the EPA and evaluated against the EPA's Safer Choice General Standard and the specific requirements according to the ingredient functional-class.

The Safer Choice program uses a Safer Chemical Ingredients List (SCIL) designed to help manufacturers find alternative chemical that satisfies the Safer Choice criteria. The list contains around 750 chemical ingredients divided according to the chemical functional class and labeled with colors according to the level of concern of each chemical. The complete assessment will provide thresholds levels and information about the chemical safer use that can be included on the SCIL.

3.4. Health Product Declaration (HPD)

The Health Product Declaration (HPD) is a customer-led collaboration that aims at improving building industry performance by increasing transparency, openness, and innovation in the product supply chain of the building industry. HPD is an open standard that lists the product contents and health hazards associated with the products. Hazard identification in HPD is based on HPD priority hazard lists, the GreenScreen list translator and, if available, full GreenScreen assessment (HPD Standard Version 2). HPD does not provide any information regarding the risk associated with handling and/or using materials and products. Also the HPD does not provide any information regarding the environmental impact of a products life cycle or the health impacts of substances used/created during the manufacturing of products. The HPD standard focuses on materials and substances. For materials, HPD is concerned with the percentage of the materials in the final products (variation range of material, ranges in similar products, alternate and undisclosed percentage) and the inventory threshold (100 ppm, 1000 ppm) required level for Safety Data Sheets (SDS) as described by the Globally Harmonized Systems of Classification and Labeling of Chemicals (GHS), OSHA MSDS thresholds and/or other types of protocols. HPD can be used as material certification in both LEED v4 and LBC.

3.5. DECLARE

DECLARE is a building material ingredients disclosure system that aims to increase transparency and open communications in the building industry. Manufacturers can enter DECLARE and reveal all ingredients of their products to the public. Designers can also use the DECLARE database to choose non-hazardous substitute materials. DECLARE requires reporting of all intentionally added ingredients by manufacturers plus residuals up to 100 ppm, the name of the chemicals, CAS number, and the percentage range and weight of all ingredients. It is worth noting that there is no need to report natural occurring, unintentionally added ingredients and process chemicals. Manufacturers should evaluate their products to see whether there are any materials on the DECLARE red list (determined Red List Compliance). However, there are some exceptions for some specific red-list materials.

DECLARE has a large red-list database. Although the DECLARE red list database was launched in 2006, it is constantly updated to be in compliance with LBC version 3, the EPA Action Plan Published List, the REACH Substances of Very High Concern (SVHC) List and the Cradle to Cradle Banned List. DECLARE is mainly used in LBC, however, it is recently officially recognized by USGBC as a way of earning points in LEED v4.

3.6. GreenScreen

GreenScreen for Safer Chemicals is a hazard-based assessment method developed by Clean Production Action. GreenScreen is an open source assessment with publicly available criteria for categorizing chemicals based on their hazards. There are two type of analysis in GreenScreen assessment including the GreenScreen List Translator and the GreenScreen full life cycle assessment. A GreenScreen full life cycle assessment evaluates chemical hazards, identifies concerns, and considers safer alternatives. GreenScreen provides a third party verification HPD for green facade products. The List Translator does not include the hazards associated with manufacturing and degradation of the product. The List Translator is an online tool to check 650 internationally recognized lists and sub-lists of high hazard chemicals. The List Translator categorizes chemicals based on their hazard level. There are two types of lists for categorizing chemicals: authoritative lists and screening lists. The full GreenScreen assessment is categories into five benchmarks, and provides all the data based on 18 hazard endpoints. The evaluation includes the chemical hazard after its breakdown in the environment. The GreenScreen **benchmark is built based on 12 Principles of Green Chemistry and the US EPA's Design for the Environment (DfE)** alternatives assessment method. DfE aims to produce information about safer commercial products and has proposed hundreds of alternative chemicals and technologies to ensure safer products. GreenScreen is a hazard-based assessment and as such there is no consideration of dose and exposure scenarios.

3.7. GreenSuite

GreenSuite is a risk assessment tool supported by hazard data from Relational Chemical and Product Database (R-CPD) for 30,000 chemicals and categorized in modules with 44 ecological, health and safety (EH&S) endpoint criteria as defined in NSF/GCI/ANSI 355: Greener Chemical and Processes Information standard. It is one of the tools that meet the requirements of the Green Globes section that addresses risk assessment. The R-CPD database is claimed to be the largest available database that continuously collects data and has been in existence since 1985. GreenSuite has an integrated Environmental Health and Safety (EH&S) system that utilizes a web-based technology to customize via the data for specific industries. The GreenSuite system benefits from an advanced internet technology known as the Sustainability Oriented Architecture (SOA4), which allows users to design, modify, organize, and integrate database applications over the Internet. GreenSuite includes the issues from pre-manufacturing and Material Safety Data Sheet (MSDS), to emissions monitoring and waste disposal.

The GreenSuite analysis includes several modules. The first four modules provide analytical data for any product in any industry. The fifth module develops factors for the sustainability assessment of the manufacturing process including water usage, energy consumption, waste generation, and others. The sixth module requires detailed and confidential process information from suppliers to assist supply chain risk assessments. The final two modules comprise the exposure scenario risk assessment for chemicals and products.

4. SUMMARY AND CONCLUSION

In the U.S., building assessment systems such as LEED, Green Globes, and the LBC began to incorporate consideration of product and materials safety from a toxicity standpoint into the materials category for each system. In the assessment systems developed prior to 2010, hazard or risk assessment of materials was not considered and thus consideration of materials toxicity in building assessment is a relatively new addition to the portfolio of issues addressed by these systems. The initial strategy was the HBA approach, simply generating red lists of chemicals to be used as a basis for banning products and materials. In the case of the LBC, as an example, the appearance of any chemical on their red list was cause for either eliminating the product or being denied certification. More recently RBA, which takes the dose and exposure scenario into account and applies the science of toxicology to the analysis, is gaining traction and is in the process of being incorporated into the next version of Green Globes. Tools such as GreenSuite provide a user friendly, web-based approach for determining the risks of the chemicals in a product as a function of the actual use of the product. These tools afford a high degree of flexibility and allow analysis of not only the use phase scenario but also the manufacturing, installation, and demolition phases as well.

REFERENCES

- [1] ANSI/GB01-2017 (draft). Standard for Green Building Assessment, under development]
- [2] Chemical Compliance Systems, Inc. at www.chemply.com
- [3] Duffus, John H. 2001. "Risk Assessment Terminology," *Chemistry International*, v23(2), March
- [4] **Melton, Paula.** 2016. "Chemical Risk Assessments Come to LEED v4," *Environmental Building News*, <http://www.buildinggreen.com>
- [5] Paracelsus, T. 1538. "Die dritte Defension wegen des Schreibens der neuen Rezepte, Septem Defensiones, **Werke Bd. 2.**"
- [6] reenScreen for Safer Chemicals, January 2014, Cleaner Production Action, online at www.greenscreenchemicals.org

CESBA Alps, From Building to Territory: Together Towards a Harmonized Built Environment Assessment

Markus BERCHTOLD-DOMIG^a, Andrea MORO^b, Etienne VIENOT^c

^a *Heimaten, Austria, markus.berchtold@heimaten.com*

^b *iSBE Italia, Italy, andrea.moro@isbeitalia.org*

^c *Rhonalpénergie-Environnement (RAEE), France, etienne.vienot@raee.org*

ABSTRACT

Assessment tools are widely used in Europe and worldwide, addressing building and urban scale. These various **tools don't allow the comparison of the performance of the built environment and lead to a confuse** situation, for construction stakeholders, buildings owners and building users. The Common European Sustainable Built Environment Assessment (CESBA) initiative promotes the use of assessment tools, contextualized to the regional/local context and harmonized through common principles and key performance indicators in order to ensure the comparison of performance. To go further than the building scale, CESBA uses these principles in the European project CESBA Alps to develop a new and innovative approach: assessing the built environment at territorial scale.

Keywords: assessment, contextualization, harmonization, empowerment, Europe

1. INTRODUCTION

European Union's 28 nations with different legal, cultural, climate and technical background have to work together to meet the Paris Agreement on climate change from 2015. The building sector and built environment has an important role to play. They have become a cornerstone of the EU climate protection program and have a crucial role to play in the achievement of the long term 80-95% greenhouse gas emission reduction objective. In this perspective, the EU released a series of political and legislative initiatives in order to reduce the environmental impact of buildings by improving their overall resource efficiency and, as a consequence, enhancing the competitiveness of construction businesses and the quality of life of European citizen.

As pointed out by the European Commission in its recent Communications "Resource efficiency opportunities in the building sector" (COM (2014) 445 final) and "Strategy for the sustainable competitiveness of the construction sector and its enterprises" (COM/ 2012/ 0433 final) one of the main issues in the building sector remains the lack of comparable and accessible data and assessment methodologies.

Therefore, a harmonization of building assessment systems is needed in order to make the quality of the built environment comparable and enable policy makers to better steer the development of the sector. Furthermore, it will also enhance knowledge diffusion among companies and thus improve the control of the quality of buildings and eliminate export burdens for SMEs.

The European Commission also underlined in its „Communication on Resource efficiency opportunities in the building sector" (COM (2014) 445 final): „There is a risk that the indicators they [Member States] eventually develop will differ, leading to an unnecessarily complex business environment." In order to tackle this issue and ensure the effectiveness of certification labels, CESBA proposes to create a common and integrated approach promoting a harmonization of assessments throughout Europe.

While assessment rating tools at building scale are already well established, while many experiences have been carried out at small urban scale/ district scale, very little experiences were developed to set up and implement assessment and rating tools for territories (see Figure 1).

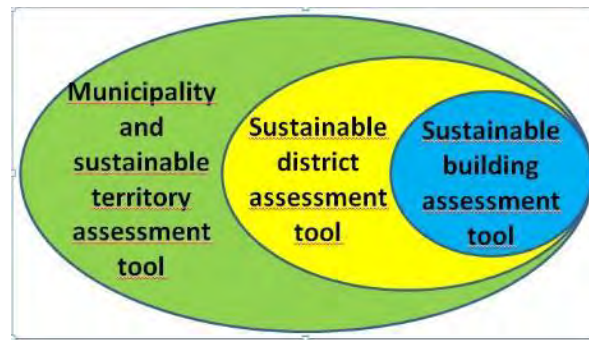

Figure 1: Assessing various scale

In order to be able to compare buildings, neighbourhoods, villages, cities, territories and to share experiences between public and private stakeholders in Europe, CESBA promotes a harmonized and integrated approach, which is flexible enough to consider regional needs and circumstances, and to provide an open source framework with minimum requirements to ensure the quality of certification processes. This applies on a global perspective on all continents as well.

2. COMMON EUROPEAN SUSTAINABLE BUILT ENVIRONMENT ASSESSMENT (CESBA) GOALS

CESBA stands for Common European Sustainable Built environment Assessment and is a common bottom-up initiative towards promoting a harmonization of assessments of the sustainable built environment throughout Europe based on nine principles.

2.1 CESBA history

During the project ENERBUILD, funded by the Alpine Space programme, partners found too many sustainable building assessment systems on their territories, and felt that users and stakeholders were disoriented. This profusion of system was the starting point of an international conference held in Lyon in February 2011: **“From Europe to territories: what possible convergence? “: the question of convergence was on the table.**

To share this vision and to disseminate these results, to start the work with the EU commission, the first CESBA conference in Brussels was organized on 10th October 2012, and the website launched. After the launch of the idea several institution were interested to know more about the initiative. Partner began to present CESBA on various occasions all over Europe, even on the World Sustainable Building conference in Spain 2014.

CESBA developed its own method – the CESBA Sprint Method – to bring people with different technical, cultural and native language together and prepare common results. The 2nd CESBA-Conference was held as the first CESBA Sprint Workshop Hochhäderich/ Austria in 2013. During these 3 days over 100 experts in various fields defined core elements of the CESBA approach.

2015 the CESBA Association was officially launched.

2.2 CESBA principles

CESBA is based on nine principles. These principles are used to develop assessment tools for any scale addressed by the tool: building, neighbourhood, territory.

2.2.1 The user first

CESBA focuses on the people who use buildings. On average people spend 90% of their life inside buildings. The aim is **to design, build and operate the buildings in order to meet the users’ requirements and needs, providing an improved comfort, and an ecological and economical construction and operation.**

The users are the main actors in a building. The awareness for their rights and responsibilities builds the base for **win-win situations. Obtaining the users’ participation and support is crucial to achieve the highest quality of use and energy-efficient building operation.**

The monitoring of building performance indicators **guarantees a sufficient check of the building's function ability** and comfort provided to users. The indicators used to communicate performance to the end users have to be target-oriented and easily understandable.

The revolutionary approach of CESBA is the change of the perspective. By putting the user at the centre of the initiative, the purpose becomes to design, construct, operate and maintain buildings to meet their functional requirements and comfort.

2.2.2 Sustainability

Sustainability regards economic, environmental and social aspects. The term built environment refers to the human-made surroundings that provide the setting for human activity, ranging in scale from buildings and parks or green space to neighborhoods and cities that can often include their supporting infrastructure, such as water supply, or energy networks. The built environment is a material, spatial and cultural product of human labor that combines physical elements and energy in forms for living, working and playing. It has been defined as the human-made space in which people live, work, and recreate on a day-to-day basis.

2.2.3 Regional contextualization

Building assessment systems must be contextualized to the region where they are applied, in order to reflect the local specific priorities, cultures, habits, and construction practices. This means using local units of measure, adopting national/ regional standards and regulations, giving due consideration to the local climate, and accounting for availability of natural resources and cultural aspects of design. At local level it is fundamental to set the relative importance of environmental, social, economic, legal and political issues. Each criterion included in the assessment tool should be assigned a relative weight and a reference benchmark (minimum acceptable performance level) adequate to the local conditions. The value of rating results diminishes when systems are used in contexts outside of their origin.

2.2.4 Comparability

The performance results shall be comparable thanks to points/ targets. Further national tools shall be translated into one language. Further the inputs in the assessment shall be defined and not the outputs.

2.2.5 Mass orientation

Building rating systems can play a key role in moving the built environment towards a better sustainability. To reach this objective they have to be widely adopted by the different stakeholders of the building sector: architects, **designers, public organizations, construction companies, investors, etc.** Only a **"mass oriented"** approach allows reaching this objective. **"Mass oriented"** means that the objective of the certification is to reach 100% of constructions.

2.2.6 Simple to use

A "mass oriented" building assessment system has to find a right balance between the simplicity to use and the scientific/ technical value. The assessment must be precise, not simplified, clear, affordable and visible. A system requiring complicated calculations or the availability of data that are not easy to find would request too much time and effort (costs) to be widely used. Simplicity helps the dissemination of assessment systems among the stakeholders. Effective training courses can be implemented to improve the skills of professionals in building assessment.

2.2.7 Open source

Using an open source approach allows CESBA to be appropriate to its context by paying special consideration to the environmental, ethical, cultural, social, political, and economic aspects of the community it is intended for. Consequently, this approach allows for regional adaptations in the guidance system. In addition, the open source approach allows CESBA to be a low-cost alternative to more expensive and proprietary alternatives of sustainable building assessments. The open source way provides a bottom-up initiative for the standardization and

harmonization of sustainable building assessments. The knowledge and results generated by CESBA can be used to support incentive systems, regulations and laws on a regional, national and European level.

2.2.8 Transparency

The public should have access to the performance results especially for public buildings. Privacy rules have to be considered. The visualization of the results must be understandable. Guidance for further understanding shall be delivered. For the assessment a guideline is laid out before the assessment. All indicators have to be checked step by step along the guideline. An external certification body does the final check. The simplicity and transparency procedures (guideline, external independent control) guarantee the best possible quality of the assessment.

2.2.9 Co-creation

CESBA is developed by several people and organisations from various European regions, with experts providing input on their field by contributing as Wiki editors. The knowledgebase and further areas of content development are discussed and agreed during common and open CESBA Sprint Workshops. All necessary support software, databases and tools will be jointly developed.

3. GENERIC FRAMEWORK AND KEY PERFORMANCE INDICATORS

Based on the comparison of existing assessment tools and regional success stories like KGA (Vorarlberg/ Austria) CESBA develops its own generic framework. This framework is a benchmark to harmonize existing and upcoming assessments schemes in Europe.

The first steps toward the needed harmonization of the systems are:

- To define common principles regarding built environment sustainability certification;
- To define a core of common criteria and indicators that would allow a comparison between the performances of buildings, neighborhood, village, cities, territories certified with different labels.

In this sense an interregional generic framework like CESBA generic framework can play a key role. The CESBA generic framework for buildings has been developed during the project ENERBUILD as a synthesis of the most important building assessment criteria in the Alpine region. The CESBA generic framework need further interaction with other European institutions that have similar objectives in the way to define a consensus based set of core criteria applicable and significant for all Europe.

The CESBA cycle conveys the concept of CESBA that is defined by harmonized indicators; tools and services usable during the whole life cycle and an ongoing dialogue with society (see Figure 2).

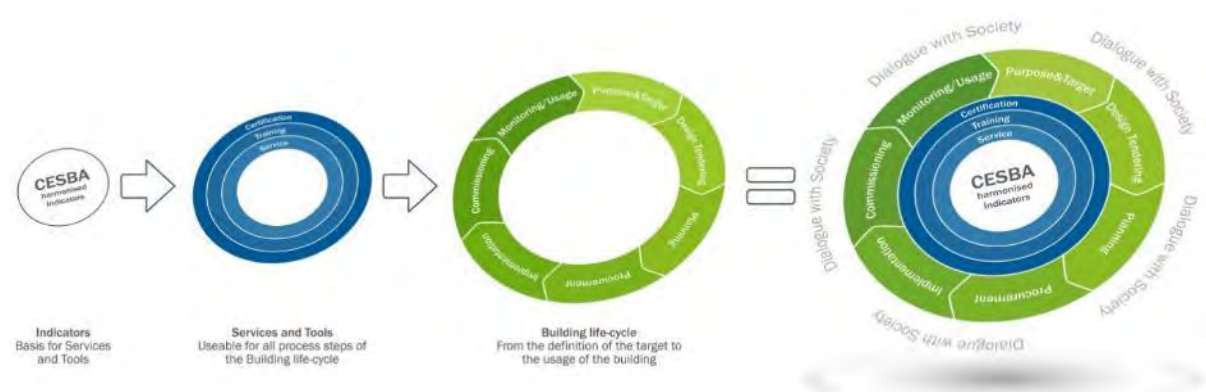

Figure 2: The CESBA cycle

The building scale is addressed by the Enerbuild outputs and will be reinforced in the frame of the EU macro-regional strategy for the Alpine region; the district scale will be addressed with the CESBA Med project in the European macro-region Mediterranean.

In addition to these approaches at building and district level, the project CESBA Alps funded by the Alpine Space program, develops an innovative approach, addressing the territorial scale, following exactly the principles of CESBA:

- Development of regional tools by regional actors to assess built environment at territorial level (contextualization, co-construction, simple to use)
- Definition of a transnational common set of indicators, to be included in all regional tools (harmonization)
- Test and validation in territories
- Guideline for the use of assessment tools in public policies.

First results will be available in 2017.

4. POLICY RECOMMENDATIONS

More than a common European approach to assess the environmental performance of the built environment, CESBA also wants to promote a new culture in Europe – one that will be more likely to take into account the overall impact of construction on the European environment. In this perspective, the CESBA partners propose several concrete recommendations

4.1 Promotion of a common open source approach towards sustainable built environment

- Adoption of affordable and operable key performance indicators at EU level
- Necessity to coordinate diverging/ different national approaches
- Develop comparable assessments
- Share best practices
- Use online tools (social media, platforms) for networking and creating synergies
- Avoid a complex business environment
- Integration of regional and local specificities

4.2 Promotion of the use of assessment in public initiatives for the built assessment

- The EU Ecolabel for buildings currently under development could benefit from the CESBA methodology and key performance indicators
- Introduce mandatory EU Green Public Procurement criteria based on the agreed EU Framework of common indicators
- EU funding for public building projects must become conditional upon applying Green Public Procurement criteria
- And also in incentives based policy, building codes, urban plans

4.3 Consider the build environment in its local and regional context

Reach political and management support at regional and local levels

- Achieve regional sustainable built environment strategies and action plans
- Monitor local needs and specificities
- Favour local practices and resources in the sector
- Using EU Regional Funds to develop a long term sustainable built environment framework
- Creation and stimulation of sustainable building clusters

5. EMPOWERMENT THROUGH COOPERATIVE PROJECTS

The European Union is a mix of cultures and economies that will reach its full potential through mutual understanding and close cooperation. As the top-down approach is limited due to the lack of knowledge on regional circumstances and its difficulty to reach citizens, local craftsmen, local administrations etc. Therefore a bottom-up approach is needed.

A bottom-up approach supports cultural diversity, regional responsibilities, and regional economic cycles, further it is in line with the subsidiarity principle of the European Union. Therefore since 2011 over 30 public and private European organizations from 13 nations from all over Europe have been involved to establish the non-profit bottom-up movement CESBA.

CESBA empowers people, organizations, and regions and offers a productive perspective. The movement works on 4 dimensions: communication, Sprint Method, organization, common projects.

- Communication: All relevant information regarding CESBA is available on the CESBA wiki. Everybody can gain the regular CESBA newsletter. To be accessible the process offers specific regional points of contact, technical interfaces, a online knowledge platform, capacity building and public meetings.
- CESBA Sprint Method: on equal bases people with different technical, cultural background and native language work together to define, elaborate issues for the CESBA movement.
- Organization: CESBA is organized as a non-profit association the membership in the CESBA movement is for free.
- Common projects: Working in common projects across borders helps to explain, test and develop approaches to realize the intended and accepted goals. To overcome the barriers the partners work in common transnational EU-projects.

6. CONCLUSION

The CESBA approach offers a European approach of harmonization of a wide variety of built environment assessment schemes while integrating the building, neighbourhood, city, and territory level.

CESBA's intrinsic force is the empowerment of local and regional initiatives to work together for a common good which yields profit for every participating partner by using European research funds. Therefore CESBA is closely linked to application in the public and semi-public sector on local and regional level.

CESBA offers a global perspective as well. Therefore it invites other bottom-up initiatives for common efforts. Nevertheless CESBA is not finished. CESBA is an ongoing process of integration of new research results, political programs, and continuous lobbying for its 9 principles.

LEED CS in Brazil: Discussing the Validity of the Method for the Improvement of Environmental Quality on Buildings

Monica Santos SALGADO^a

^a Federal University of Rio de Janeiro, Brazil, monicassalgado@ufrj.br

ABSTRACT

The construction industry has a negative impact on the environment, due the exploitation of raw materials, transportation of materials and the construction process itself. In Brazil, discussions around the alternatives towards a more sustainable construction have led to the adoption of some foreign systems for the environmental evaluation of buildings – particularly the North American LEED certification. On August 2016, registers indicated 354 certified buildings in the country. **Despite the dissemination, LEED's validity to orient the production of sustainable buildings should be discussed.** This research has the intent to analyse the contribution of LEED rating system for the improvement of environmental performance in Brazilians' buildings. **The research method includes,** at first, the assessment of certification map, in order to identify LEED type most widely adopted – which revealed the preference for LEED CS (for Core and Shell). Second, the analyses of the scoreboard for each LEED CS certified building. Results indicate that some relevant environmental targets had been often ignored by certain LEED CS certified buildings. So, it is necessary to review the exaggerated importance given to environmental rating systems, and to enlighten some new possibilities that will lead civil construction industry to the next level towards sustainable development.

Keywords: design process, green rating tool, high-performance building

1. INTRODUCTION

During United Nations Conference in Stockholm on 1972 the main goal has been the establishment of strategies for sustainable development. In what refers to civil construction industry, only in 1999 the CIB (International Council for Research and Innovation in Building Industry) **prepared a specific document, entitled “Agenda 21 for sustainable construction”, and, three years later, “Agenda 21 for sustainable construction in developing countries”.** Those documents reveal three aspects to be considered due the accomplishment of environmental targets: the definition of environmental performance levels for buildings; the necessity of changes in design and construction management, and the importance of the investment in actions for the implementation of a new culture on civil construction sector.

The environmental certification has arisen as a consequence of this effort towards the improvement of environmental performance of buildings. In this sense, since 1990's architects and engineers have the opportunity to evaluate the environmental performance of buildings through different rating systems. Among the methods, the **English BREEAM (UK), the French HQE®, and North American LEED™ should be highlighted.** Further analysis confirms that the evolution of rating systems in different countries is largely based on those initial rating systems.

The first Brazilian Building to obtain an environmental certification was a bank, which received a LEED certification on 2007. However, after almost twenty years, it is necessary to continue questioning at what level those methods are truly contributing for sustainable construction. In the words of Cole:

“The prevailing mechanistic, anthropocentric worldview has been some 500 years in the mankind and is now ingrained all aspects of western society and culture. It has (...) dictated the reductive approaches used to understand and evaluate building environmental performance. Almost all current building environmental assessment system, for example, are based on the simple addition of points attained by meeting a series of discrete performance requirements.”

This research has the purpose to discuss LEED rating system contribution to the improvement of environmental performance of buildings in Brazil. The research method includes, at first, the assessment of certification map, in order to identify LEED type most widely adopted and, second, the analyses of the scoreboard for each LEED CS certified building. Although the results cannot be considered conclusive, this contribution can give a glimpse of what should be done in search of a more sustainable construction.

2. LEED CERTIFICATION IN BRAZIL: CASE STUDY

Although since 2003 there is a specific Brazilian method to certify buildings with high energy efficiency – PROCEL Edifica – only on 2014 Brazilian Central Government has established that PROCEL labeling should be compulsory for public buildings (Normative Instruction n ° 2 – Ministry of Planning, Development and Management). For the private market, there is no regulatory requirement in what concerns environmental performance of buildings.

At the same time, LEED™ and HQE methods have made their way to Brazil. The French methodology has been adapted, resulting in the AQUA Brazilian certification. On August 2016, BREEAM has not certified any building, AQUA process has certified 253 buildings, against 354 LEED certifications. Thus, it is correct to say that LEED certification is the most popular in Brazil Real Estate market.

Until LEED version 3, the types of assessments were: LEED-NC – for new construction and major renovations; LEED-OM – for existing buildings; LEED-CI – for commercial interiors; LEED-CS – for Core and Shell; LEED for schools; LEED for retail; LEED for healthcare; LEED for homes; and LEED-ND – for neighborhood development. Version 4 has changed that classification. The environmental analyses consider seven dimensions: Sustainable Sites, Water Efficiency, Energy and Atmosphere, Materials and Resources, Indoor Environmental Quality, Innovation in Design or Innovation in Operations and Regional Priority Credits.

Some difficulties pointed by Udall and Schendler about LEED method, are: the high cost of certification, the “Point mongering” (what happens when the design team becomes obsessively focused on getting credits, regardless of whether they add environmental value); the complexity of Energy Modeling; and the fact that the certification process takes a long time.

Table 1 presents certification numbers of all LEED Buildings in Brazil until August 2016.

	PLATINUM	GOLD	SILVER	CERTIFIED	TOTAL
LEED CI	6	21	8	8	43
LEED CS	5	71	45	28	149
LEED OM	0	9	10	5	24
LEED Home	0	0	1	0	1
LEED School	0	1	1	0	2
LEED NC	3	41	45	30	119
LEED Retail	1	2	3	10	16
TOTAL	15	145	113	81	354

*Table 1: LEED certifications granted in Brazil until August 2016
Source: Green Building Council Brazil, 2016*

LEED CS (for Core and Schell) is the most widely adopted certification. One possible reason is the similarity with PROCEL label requirements, particularly in what concerns to energy consumption.

The interest in LEED certification is concentrated on the southeast region (82% of certified buildings), as highlighted in Table 2.

	NORTH	NORTHEAST	MIDWEST	SOUTHEAST	SOUTH	TOTAL
PLATINUM	0	0	0	3	2	5
GOLD	0	1	5	55	10	71
SILVER	0	1	1	37	6	45
CERTIFIED	0	1	0	27	0	28
TOTAL	0	3	6	122	18	149

*Table 2: Certified LEED CS buildings in Brazil (until August 2016)
Source: Green Building Council Brazil, 2016*

According to Green Building Council, 55% of LEED CS certified buildings in Brazil has adopted the version 3, 16% adopted version 2 , 28% has confidential data (impossible to know which version has been adopted) and version

4 has certified only three buildings until August 2016. So, this research analyzed the 82 scoreboard of buildings that has been certified on LEED CS version 3 (the most popular).

In order to deepen the research on those 82 buildings Graphic 1 presents how each environmental dimension has been accomplished. It is possible to notice that even in different classifications (platinum, gold, etc), some environmental dimensions were frequently being neglected.

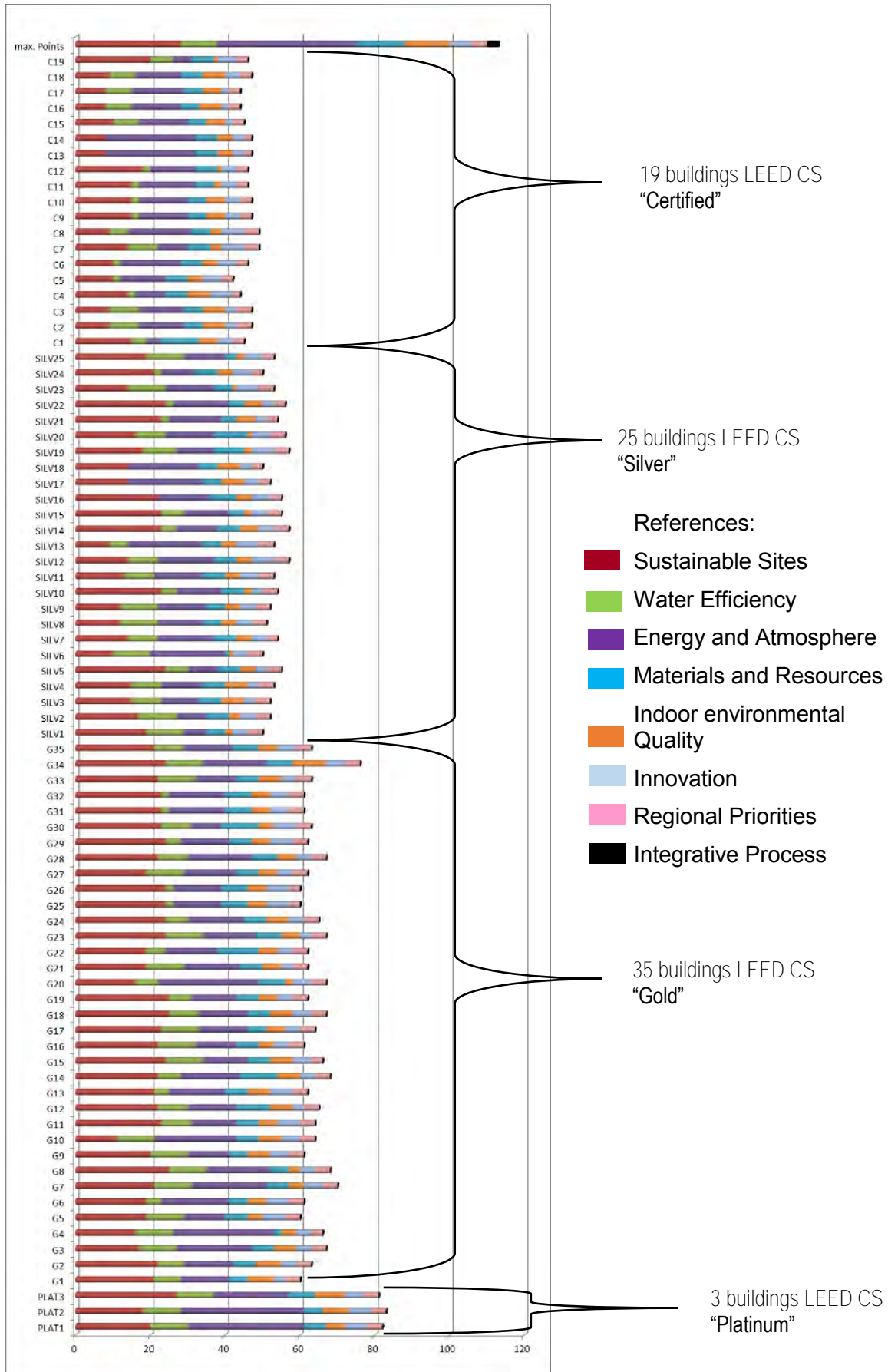

Graphic 1: 82 LEED CS certified buildings in Brazil (until August, 2016) - percentage achieved in each Dimension

3. DATA ANALYSIS – LEED CS IN BRAZIL

Data analyses allow identify the environmental requirements that seem to be more difficult to be achieved (requirements that rarely has been achieved by LEED CS certified buildings). Four dimensions call our attention: "Materials and Resource", "Energy and Atmosphere", and "Indoor Environmental Quality".

In relation to "Materials and Resources" two goals had not been achieved by most LEED CS certified buildings: Building reuse (related to the recycle or reuse of existing walls, floors and roof); and Materials reuse (related to the recycle or reuse of preexisting materials). However, those requisites can normally be achieved in refurbishment projects.

In relation to "Energy and Atmosphere", two goals had not been achieved by most LEED CS certified buildings, as presented on Graphic 2:

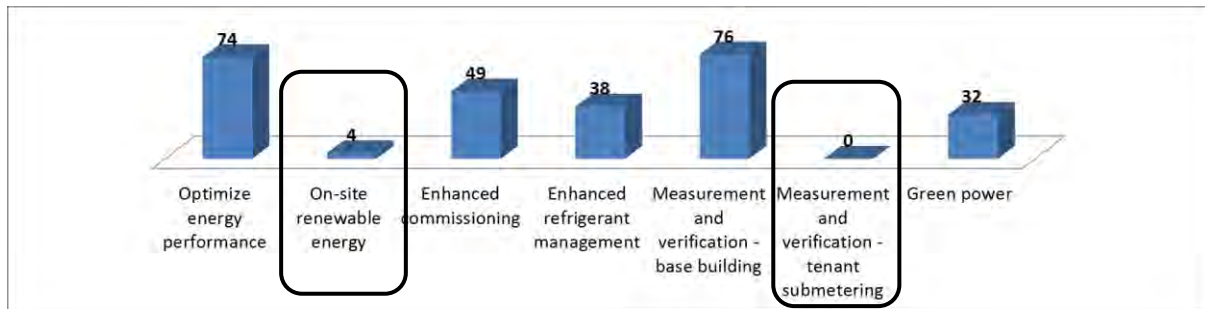

Graphic 2: Energy and atmosphere dimension – number of certified enterprises among 82 LEED CS certified buildings in Brazil (2016) that meet the requirement (total or partially)

Among the 82 Brazilians' buildings certified as LEED CS (2009 vrs3), only 4 meets the requirement related to "On site renewable energy", and none has punctuated on "Measurement and Verification – tenant submetering". The intent of those requisites are described below:

- On-site renewable energy: To encourage and recognize increasing levels of on-site renewable energy self-supply to reduce environmental and economic impacts associated with fossil fuel energy use;
- Measurement and Verification - Tenant Sub metering: To provide for ongoing accountability of building electricity consumption performance over time.

In relation to "Indoor Environmental Quality Dimension", four goals had not been achieved by most LEED CS certified buildings, as presented on Graphic 3:

- Outdoor Air Delivery Monitoring: To provide capacity for ventilation system monitoring to help promote occupant comfort and well-being;
- Low-Emitting Materials - Composite Wood and Agrifiber Products: To reduce the quantity of indoor air contaminants that are odorous, irritating and/ or harmful to the comfort and well-being of installers and occupants;
- Indoor Chemical and Pollutant Source Control: To minimize building occupant exposure to potentially hazardous particulates and chemical pollutants;
- Controllability of Systems - Thermal Comfort: To provide a high level of thermal comfort system control by individual occupants or groups in multi-occupant spaces (e.g., classrooms or conference areas) and promote their productivity, comfort and well-being

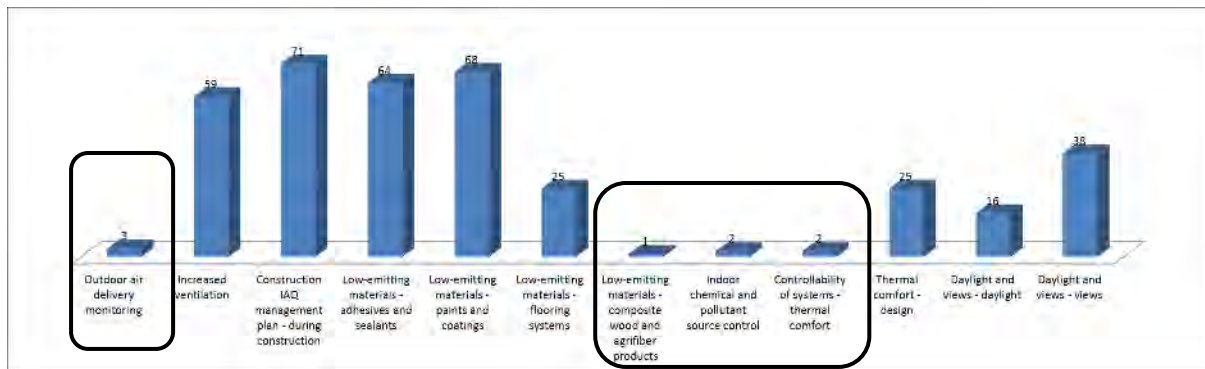

Graphic 3: Indoor environmental quality dimension – number of certified enterprises among 82 LEED CS certified buildings in Brazil (2016) that meet the requirement (total or partially)

It has also been noticed that some certified buildings presents minimum punctuation on “Water Management Dimension”. None of certified buildings (not even the Platinum certified) had punctuated on “Innovation Dimension”, which considers the design solutions with exceptional performance (above the requirements set by the LEED Green Building Rating System).

4. FINAL CONSIDERATIONS

Offer the entrepreneur the easiest way to obtain a green certification (as presented by some environmental rating systems) is revealed as pernicious, because it leads to the search of the fastest way to obtain the green seal, in opposite to the search for high environmental quality solutions for buildings.

In what refers to LEED CS method, it was observed that some environmental requirements are rarely achieved. To understand why it has happened, it would be necessary to know the details of each design and construction process of certified building. Maybe the building had already obtained the required score to be certified and, in this case, the entrepreneur felt little motivated to continue investing in the improvement of environmental performance. This seems to be the most vicious problem on environmental rating systems: professionals do not pursue design solutions for sustainability, but only the solutions that can bring the necessary punctuation to obtain a green certificate.

The analysis also indicates that, in Brazil, there are few certified buildings. Initiatives are grouped on one region (Southeast) – mostly commercial or corporative facilities – which can signalize the intention of entrepreneurs to add green value to their firms through the green label of their headquarters. It is worth mentioning that the number of new LEED registers in Brazil is dropping significantly, as presented on graphic 4, which indicates a reduction of interest in LEED certification that should be analysed in future research.

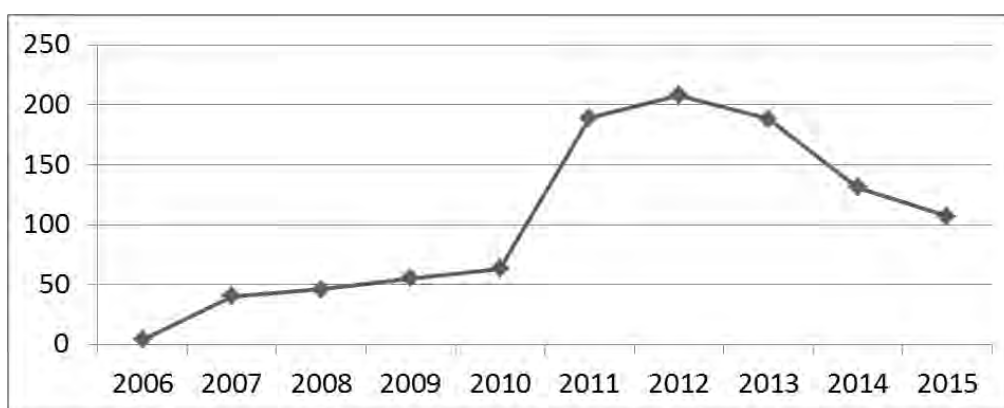

Graphic 4: LEED registers in Brazil: from 2006 to 2015
Source: Green Building Council Brasil, 2016

However, the discussion around sustainable construction is changing, and there are some new concepts emerging, particularly: integrative design and regenerative development. According to Boecker et al the concept of integrative design is different from integrated design because the latter term implies something that is past and completed, while the word “integrative” suggests an evolving process and implies that we’re never really done. Integrative

design intends to guarantee the participation of a multidisciplinary team of architects and engineers discussing environmental targets since the beginning of architecture design (conceptual phase) and over all the design process. This modus operandi offers new possibilities, through continuous exchange of ideas about the ideal solution for the project.

The second concept, related to regenerative design, will gain momentum over the next decade as a necessary approach to green building strategies, as mentioned by Cole. The author emphasizes that the transition from green buildings practices to those more firmly framed by regenerative development, will parallel the shift from a mechanistic to an ecological worldview.

Finally it is worth mentioning the importance of environmental rating systems as the first step towards sustainable construction. The new version of LEED system (Version 4) seems to presents advances in comparison to the last one. However, the age of **environmental rating systems is reaching its end, and it's time to look forward.**

5. ACKNOWLEDGMENT

The author thanks National Council for Research and Development – CNPq – for the financial support of this research.

REFERENCES

- [1] BOECKER, J. HORST, S. KEITER, T. LAU, A. SCHEFFER, M. TOEVS, B. REED, B. (2009) The Integrative Design Guide to Green Building: redefining the practice of sustainability. John Wiley & Sons Ed., 2009
- [2] BRASIL. (2014). Normative Instruction IN 2/2014 from Management, Planning and Public Budget Brazilian Ministry (MPOG/Brazil). June 4 2014. [online] Available in <http://www.comprasgovernamentais.gov.br/paginas/instrucoes-normativas/instrucao-normativa-no-2-de-4-de-junho-de-2014> [Accessed on January, 2017]
- [3] BRASIL. (2003) Manual para etiquetagem de edificações públicas. Gestor público Eletrobras / Procel. [online] Available in: <http://www.pbeedifica.com.br> [Accessed on January 2017]
- [4] COLE, R. (2016) Regenerative development: reframing the role of buildings. Central Europe Towards Sustainable Buildings CESB 2016. In: **Proceedings... Prague, Czech Republic, p.3-8.**
- [5] FUNDAÇÃO VANZOLINI (2016) Indicadores do Processo AQUA-HQE no Brasil (2016) [online] Available in: <http://vanzolini.org.br/aqua/indicadores> [Accessed on January, 2017]
- [6] GREEN BUILDING COUNCIL BRAZIL (2016) [online]. Available in: <http://www.gbcbrazil.org.br/empreendimentos-leed.php> [Accessed on August, 2016]
- [7] INTERNATIONAL COUNCIL FOR RESEARCH AND INNOVATION IN BUILDING AND CONSTRUCTION. (1999) Agenda 21 on Sustainable Construction – Discussion document CSIR Building and Construction Technology, Pretoria: ZA. [online] Available in: <http://cic.vtt.fi/eco/cibw82/A21text.pdf> [Accessed on August, 2016]
- [8] INTERNATIONAL COUNCIL FOR RESEARCH AND INNOVATION IN BUILDING AND CONSTRUCTION. (2002) Agenda 21 for Sustainable Construction in Developing Countries: a discussion document. CSIR Building and Construction Technology, Pretoria, 2002. [online] Available in: <http://www.unep.or.jp/ietc/Focus/Agenda%2021%20BOOK.pdf> [Accessed on August, 2016]
- [9] REED, R., BILOS, A., WILKINSON, S., and SCHULTE, K. (2009) International Comparison of Sustainable Rating Tools, JOSRE, vol I . 1, n°. 1 [online] Available in <http://www.costar.com/josre/JournalPdfs/01-Sustainable-Rating-Tools.pdf> [Accessed on August 2016]
- [10] SALGADO, M. S.; CHATELET, A.; FERNANDEZ, P. (2012) Sustainable buildings production: challenges and alternatives Revista Ambiente Construido, Porto Alegre, v. 12, n. 4, out./dez. 2012. p. 81-99 [online] [Available in <http://www.seer.ufrgs.br/ambienteconstruido/article/view/22603/23734> [Accessed on August, 2016]
- [11] UDALL, R. SCHENDLER, A. (2005) LEED is Broken-Let's Fix It, [online] Available in http://www.igreenbuild.com/cd_1706.aspx [Accessed on August, 2016]

Session 6.5: SBE Assessments – Design Processes

Does BEAM Really Matter to Construction Waste Management? What Big Data Does and Does Not Tell

CHEN Xi^a, LU Weisheng^b, LIU Xingjian^c

^a Department of Real Estate and Construction, The University of Hong Kong, Hong Kong SAR, chenx90@hku.hk

^b Department of Real Estate and Construction, The University of Hong Kong, Hong Kong SAR, wilsonlu@hku.hk

^c Department of Urban Planning and Design, The University of Hong Kong, Hong Kong SAR, xliu6@hku.hk

ABSTRACT

The green building rating systems (GBRSs) are leading to great influences on the ways stakeholders approach design, construction, and operation management of buildings. A plethora of existing studies are on the effects of GBRSs on environment performance or property value. However, there is a dearth of studies relating to its effects on construction waste minimization (CWM), which is one of the important indicators of going green. This study aims to empirically investigate the effects of GBRSs on CWM by making use of a large set of data resulted from the construction waste management practices in Hong Kong and the Hong Kong Building Environmental Assessment Method (HK-BEAM). By analyzing the big data, it is found that the intervention of HK-BEAM resulted in 36.36% waste reduction by weight for demolition works. However, it barely affects the CWM when the whole construction process is considered. The policy implications based on the findings serve as valuable references for policy-makers to improve the CWM-related items in HK-BEAM in order to achieve lower-waste construction in Hong Kong. As big data for enhancing public policy-making is still at initial stage, it is recommended to effectively use historical structured databases scattered in public sectors to create insights for policy-making.

Keywords: waste management, HK-BEAM, construction waste minimization

1. INTRODUCTION

The green building (GB) movement is rapidly sweeping the world as the construction industry responds to contemporary challenges such as natural resource depletion, pollution, curtailing greenhouse gas emissions, and human-induced global warming (Peuportier, 2001; Saiz et al., 2006; Wu et al., 2005; Junnila, 2004; Ortiz et al., 2009; Shen et al., 2016). GBRSs in many countries have been established and widely recognized for sustainability assessment, including the Leadership in Energy and Environmental Design (LEED) in US and Building Research Establishment Environmental Assessment Methodology (BREEAM) in UK. Although these systems differ in terminologies, structures, evaluation methods, weighting, and documentation requirements, they all share common themes of energy efficiency, water conservation, site selection, building materials, and indoor environmental quality (Cole, 2003; Wu and Low, 2010; Zuo and Zhao, 2013). There is a plethora of studies relating to the effects of GBRSs on sustainability performances, such as enrichment of biodiversity and protection of the ecosystem (Bianchini and Hewage, 2012), reduction of greenhouse gas emissions (Jones, 2015), improved health conditions for residents and greater social productivity (Singh et al., 2010), and enhancement of aesthetic appeal and comfort for occupants (Zhang and Altan, 2011).

Construction industry alone generates a large proportion of the total solid waste landfilled globally (European Commission, 2013; HKEPD, 2015; MoE, 2014), the disposal of which brings considerable pollutants to air (Sam-Cwan et al., 2001), water (Mor et al., 2006; Al Sabahi et al., 2009), and soil (Garcia-Gil et al., 2000), and pressure on valuable landfill space (Lu and Tam, 2013). With large amounts of construction activities being conducted, construction waste, also called construction and demolition (C&D) waste reasonably attracts the attentions of stakeholders of environmental protection, such as policy-makers and researchers. Therefore, construction waste minimization (CWM) plays an important role for construction industry to pursue sustainability, thus accounts for certain proportions in GBRSs ranging from 8% to 12% for sustainability assessments (Wu et al., 2016). Existing studies were conducted to investigate the scopes in GBRSs such as LEED, BREEAM and HK-BEAM, and found CWM is one of them (Tam et al., 2004; Cha et al., 2009). However, there are few studies that reversely examine whether these GBRSs indeed have significant impacts on CWM with the use of empirical data. But without the

necessary evidence, CWM-related points may be surrendered to other green scopes such as energy efficiency or water conservation.

This study aims to comprehensively understand the effects of GBRs on CWM in the context of Hong Kong, where both are well developed but not juxtaposed to enable a holistic picture to form. To achieve this aim, a big data approach is adopted by analyzing the full-population historical data recently given rise from waste management practices and HK-BEAM assessments. In order to provide an understanding of the inherent link between CWM and GBRs, this study first reviews the building-related construction waste and GB movements, with the problems at hands identified in Section 2. The next section (i.e. Section 3) provides the methodology of conducting the comparative study. Then, Section 4 provides the readers with the data analysis and results, followed by Section 5, where the research findings are discussed. At last, conclusions of this study are drawn in Section 6.

2. METHODOLOGY

This research adopts big data analytics to investigate the effects of GBRs on CWM. The methodology is divided into two steps described as follows.

2.1 Hypothesis on the effects of GBRs on CWM

All other things being equal, achieving or attempting to achieve GBRs certification contributes positively to waste minimization, i.e. leads to a lower level of waste generation.

2.2 Testing the hypothesis using big data analytics

This research comes at an opportune time with a big dataset having become available only recently, which reveals a full picture. This study secured all the data from 1 Jan 2011 to 30 June 2016: 7,045,539 disposal records generated from all the 26,566 construction works in Hong Kong, which opened billing accounts from 2005 to 2 September 2015 before work commencement. The databases for the construction works and records are displayed on Figure 1. All the data were well structured in various databases, based on which the dependent variable (waste generation rate) WGR can be computed. This study has also sourced the data of all the 808 buildings (as of 20 June 2016) that have been certified or registered for certification by BEAM Plus mapped as shown in Figure 2 (HKGBC, 2016). The information of the 808 buildings is extracted and shown in Figure 1.

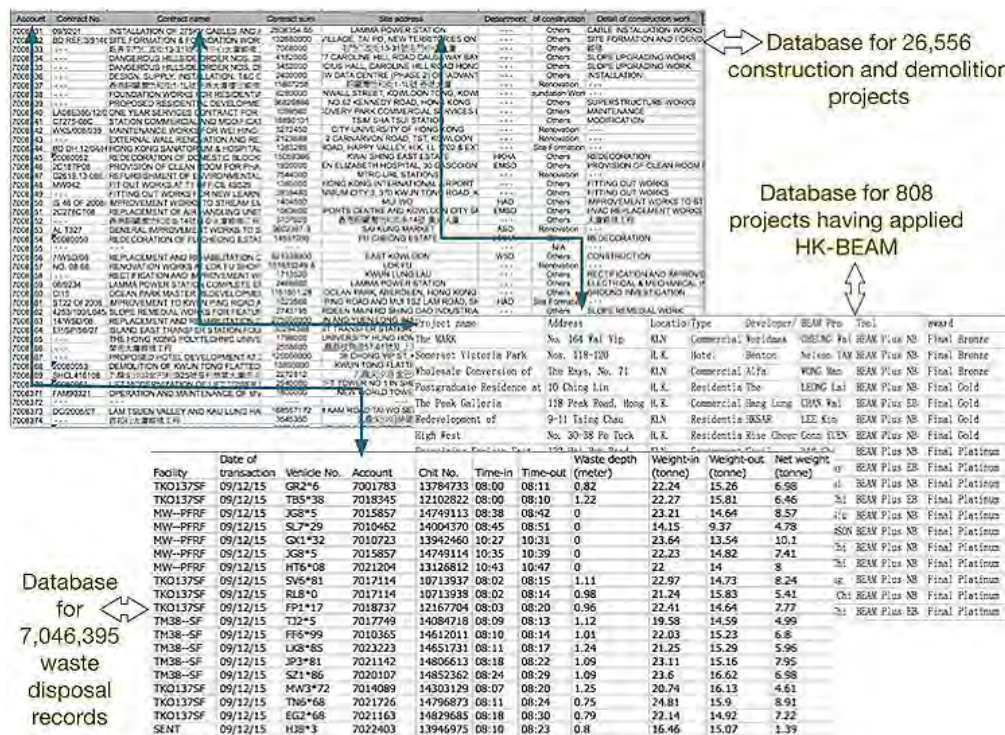

Figure 1: Screenshots of the structures of the big data

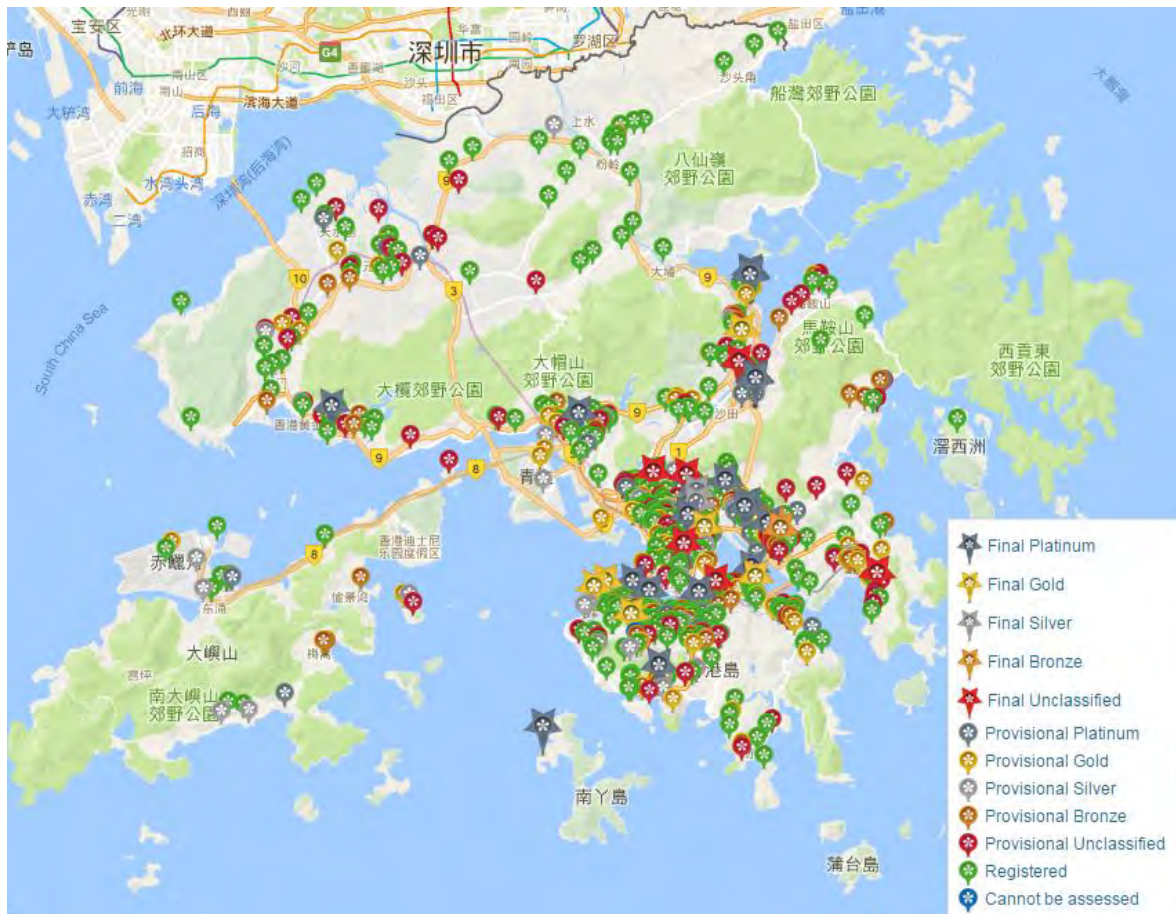

Figure 2: A screenshot of BEAM Plus Directory Map (HKGBC, 2016)

The databases demonstrated in Figure 1 provide the calculation of WGRs with full availability. The links between these databases are further illustrated in Section 4. A random group of WGRs in the pattern, $WGR_i = WG_i / CS_i$, tends to be a positively skewed distribution (Lu et al., 2015; Lu et al., 2016). WG is the waste generation amount, while CS is contract sum in the equation. Hence, this study compares the medians between the two groups of **WGRs, which are expressed in the same pattern with that in Lu et al. (2015) and Lu et al. (2016). Mood's median, as a non-parametric test, adopted to test the equality of medians from or more populations (Conover, 1971). If the p-value of Mood's median test is small, the two populations have a significant distinction in terms of their medians.** Altogether, a big data approach with the use of the sets of secondary data portraying a full, objective picture of all the buildings, rated and unrated, including their profiles and their waste generation, is employed to investigate the effect of GBRs on CWM in this study.

3. DATA ANALYSIS

3.1. Computation of WGRs of BEAM-driven and ordinary construction works

A newly developed construction project in most cases consists of three main stages in order of demolition, foundation and building. As a construction project in Hong Kong is completed by one contractor throughout all these stages or several contractors in charge of separated ones, there might be one or several billing account **opened for a project and recorded in "Database for 26,556 C&D projects"** in Figure 1. According to the data availability, this study not only investigates the whole process of the construction projects, but also the individual **stages. For each work, the amount by weight of every lorry of construction waste are extracted from 'Database for 7,046,395 waste disposal records'** according to the account No.. With the use of contract sum, the WGRs of the BEAM-driven demolition, foundation, building, and whole-process works are calculated using Equation 1. For a construction work i , which sent j lorries of construction waste to the disposal facilities, the WGR for project i can be expressed as:

$$WGR_i = (WG_{i1} + WG_{i2} + WG_{i3} + \dots + WG_{ij}) / CS_i$$

Equation 1

For the comparison between BEAM-driven and ordinary works, the same steps are performed to calculate the **WGRs of these types of construction works recorded in 'Database for 26,556 construction and demolition projects'** excluding BEAM-driven works. Totally, the results consist of eight groups of WGRs. However, outliers exist among the obtained WGRs. In case of the manually recording mistakes and some extreme, the outliers are excluded to ensure the high veracity of each group of WGRs, specifically led by full coverage of waste generation amount, and record validation of contract sum for every construction work. After outliers excluded with a confidence level of 95%, the profiles of the eight groups of WGRs are displayed in Table 1.

Construction type	BEAM-driven	Ordinary
Demolition	158	205
Foundation	238	276
Building	61	200
Whole process	26	120

Table 1: Profiles of the construction works

3.2. Comparing the WGRs between BEAM-driven and ordinary construction works

As discussed in Lu et al. (2015) and Lu et al. (2016), the median of a random group of WGRs, positively-skewed distributed, is representative for the WGR value (i.e. waste management performance) of the largest amount of individual construction works. As WGR is the key performance indicator for C&D waste management (Lu et al., 2015), this study selects WGR to indicate the performance of each group of projects. This study evaluates the CWM by comparing the WGRs between BEAM-driven and ordinary construction works. With other variables controlled, if BEAM-driven projects has lower WGR than ordinary ones, the effect of HK-BEAM on CWM can be regarded positive.

All the groups tend to accord to the positively skewed distribution, the median WGR is tested representative for the waste management performance of each type of BEAM-driven and ordinary construction works. The medians are calculated, and the results are listed in Table 2. In this context, the difference between the BEAM-driven and ordinary medians for each construction type can be regarded as the CWM, which is calculated and listed in Table 2. The significance of the difference (i.e. CWM) is **statistically examined using Mood's median test approach**. The p-values of the tests fill the third column, the interpretations of which (i.e. significances) are in the fifth. When p-value is less than 0.05, the difference between the medians can be regarded significant. The fourth and fifth columns in Table 2 show that only the demolition works are significantly affected by HK-BEAM in terms of the CWM (CWM=220.22 ton/mHKD, and CWM significance=Yes), while other construction types (i.e. foundation, building, and whole process) remain unaffected. Demolition waste actually takes a small proportion of the waste finally sent to facilities as analysed using the full data in Hong Kong, while foundation takes the largest proportion among the three stages.

Construction type	BEAM-driven (ton/mHKD)	Ordinary (ton/mHKD)	p-value	CWM (ton/mHKD)	CWM significance
Demolition	385.43	605.65	0.005	220.22	Yes
Foundation	170.65	127.541	0.066	-43.11	No
Building	13.25	22.99	0.288	9.74	No
Whole process	36.98	40.08	0.296	3.1	No

Table 2: Mood's median test results: BEAM-driven and ordinary construction works compared

4. DISCUSSIONS

The most valuable finding of this study is the HK-BEAM, as an example of GBRs, stimulates the CWM only at the demolition stage, yet barely has influences on a whole construction project. Table 3 shows the weighting of the items aiming for the 3Rs (reuse, recycle and reduce) of waste management in HK-BEAM. At demolition stage, the total amount of materials is large, which implicates the great potential of the reuse of the existing building structures and other elements thus enables practitioners with more operability to satisfy the 1st item of Material Aspect (MA1). Another reason for the success of demolition waste reduction might due to the great potential of reusing the demolition materials in landscaping and planting, which additionally reduces the difficulty of meeting the 7th item of Site Aspect (SA7). Other than MA1 and SA7, MA4 and MA10 are items both for demolition waste reduction. The total weighting of the four items accounts for 4.05% of overall attainable credits, while that aiming for waste reduction at foundation and building stage is only 2.18%. In addition, it is obviously more operative to recycle and reuse demolition waste, which is generated in large amounts in a short period. However, for foundation and building, it is more difficult and costlier to operate the waste reduction. The waste materials from the two stages are more fragmentary than those from a demolished building, which includes reusable structures. Therefore, practitioners attempt to achieve HK-BEAM through demolition waste reduction, thus the CWM at demolition stage is successfully stimulated by HK-BEAM. Considering the severe environmental impacts given rise from construction waste, it is suggested the total weighting of CWM in HK-BEAM be improved by adding attainable credits or bonus on the easiest measurable but most waste-minimizing items, such as the adoptions of prefabrication technology, deconstruction, and sustainable forest products.

Items		Attainable credits	Attainable bonus	Attainable overall grade
Site Aspects (SA)				
SA7	Landscaping and Planters (using previous materials)	1		1.14%
Material Aspects (MA)				
MA P1	Timber Used for Temporary Works	Required		
MA P3	Construction/ Demolition Waste Management Plan	Required		
MA P4	Waste Recycle Facilities	Required		
MA1	Building reuse	2	1	1.09%
MA2	Modular and Standardised design	1		0.36%
MA3	Prefabrication	2		0.73%
MA4	Adaptability and Deconstruction	3		1.09%
MA 6	Sustainable Forest Products	1		0.36%
MA10	Demolition Waste Reduction	2		0.73%
MA11	Construction Waste Reduction	2		0.73%

Table 3: Weighting of the items aiming for CWM in BEAM Plus (HKGBC, 2012)

This study also found HK-BEAM fails to complete the CWM tasks at both foundation and building stages, where a dramatically higher amount of construction waste, particularly generated at foundation stage, has been delivered to the waste disposal facilities. The average amount is 22,808 tons for foundation, 5,294 tons for building, and 2,683 tons for demolition. Lu et al. (2015) found the inert waste generally comprises 99% of the total waste generated at foundation stage. This indicates the great potential of conducting 3Rs of waste generated when a project is at foundation stage. In order to stimulate the waste reduction, the government is strongly suggested to target on the waste minimization at foundation stage. The attainable credits and bonus for MA11 should be gradually turned up until BEAM-driven projects send significantly smaller amounts of waste arising from foundation and demolition to the disposal facilities. In particular, foundation, which serves as the most wasteful stage with largest amounts of inert waste generation, should be attached with more importance supported by encouragement policies. For example, HK-BEAM makers can isolate foundation waste minimization as another item set with more attainable credits and bonus for foundation stage than building and demolition.

5. CONCLUSIONS

This study analyzed the effect of HK-BEAM on minimizing C&D waste by looking into the demolition, foundation, and building stages, and the whole construction process. The analysis takes advantages of the recently available databases generated from practices of the waste management and green building promotion implemented by public sectors in Hong Kong. The results show the intervention of HK-BEAM can lead to 36.36% waste reduction at demolition stage for the reason that the demolition waste reduction items are attributed with more credits, and enabled with more operability to achieve compared with the other CWM-related items. However, little significant CWM is achieved at foundation and building stages owing to the insufficient proportion of attainable credits and bonus allocated to them. Policy implications are considered that public sectors should increase the CWM-related proportion in HK-BEAM, in particular, focus on the foundation stage, which is the most wasteful evidenced by big data of C&D waste management.

REFERENCES

- [1] Al Sabahi, E., Yaacob, W. Z. W., Nozaily, F. A. and Alshaebi, F., 2009. The Characteristics of Leachate and Groundwater Pollution at Municipal Solid Waste Landfill of Ibb City, Yemen. *American Journal of Environmental Sciences*, 5(3), 256-266.
- [2] Bianchini, F. and Hewage, K., 2012. How “Green” Are the Green Roofs? *Lifecycle Analysis of Green Roof Materials*. *Building and Environment*, 48, 57-65.
- [3] Cha, H. S., Kim, J. and Han, J. Y., 2009. Identifying and Assessing Influence Factors on Improving Waste Management Performance for Building Construction Projects. *Journal of Construction Engineering and Management*, 135(7), 647-656.
- [4] Cole, R. J., 2003. Green buildings – Reconciling technological change and occupant expectations. *Buildings, Culture and Environment: Informing Local and Global Practices*, 57-82.
- [5] Conover, W. J., 1971. *Practical nonparametric statistics*. New York: John Wiley & Sons. Pages 234f.
- [6] EC (European Commission), 2013. Construction and demolition waste (CDW). Extracted from: <http://goo.gl/J2okdm>. Accessed on 12 September 2015.
- [7] Garcia-Gil, J. C., Plaza, C., Soler-Rovira, P. and Polo, A., 2000. Long-term effects of municipal solid waste compost application on soil enzyme activities and microbial biomass. *Soil Biology and biochemistry*, 32(13), 1907-1913.
- [8] HKEPD, 2015. Hong Kong waste treatment & disposal statistics. HKEPD. Extracted from: http://www.epd.gov.hk/epd/english/environmentinhk/waste/data/stat_treat.html, accessed on 09/09/2016.
- [9] HKGBC, 2012. BEAM Plus for New Buildings Version 1.2 published on July 2012. Extracted from: www.hkgbc.org.hk/upload/beamdocuments/BEAM-Plus-NB-1-2-Manual.pdf.
- [10] HKGBC, 2016. BEAM Plus Directory Map. Extracted from: <https://www.hkgbc.org.hk/eng/BeamPlusDirectoryMap.aspx>. Accessed on 10/05/2016
- [11] Jones, P. J., Hou, S. and Li, X., 2015. Towards zero carbon design in offices: Integrating smart facades, ventilation, and surface heating and cooling. *Renewable Energy*, 73, 69-76.
- [12] Junnila, S., 2004. Life cycle assessment of environmentally significant aspects of an office building. *Nordic Journal of Surveying and Real Estate Research, Special Series*, 2, 81-97.
- [13] Lu, W. and Tam, V. W., 2013. Construction waste management policies and their effectiveness in Hong Kong: A longitudinal review. *Renewable & Sustainable Energy Reviews*, 23, 214-223.
- [14] Lu, W., Chen, X., Ho, D. C. and Wang, H., 2016. Analysis of the construction waste management performance in Hong Kong: the public and private sectors compared using big data. *Journal of Cleaner Production*, 112, 521-531.
- [15] Lu, W., Chen, X., Peng, Y. and Shen, L., 2015. Benchmarking construction waste management performance using big data. *Resources, Conservation and Recycling*, 105, 49-58.
- [16] Ministry of Environment of Japan (MoE), 2014. History and current state of waste management in Japan. Extracted from : <http://www.env.go.jp/en/recycle/smcs/attach/hcswm.pdf>. Accessed on 21/09/2015.
- [17] Mor, S., Ravindra, K., Dahiya, R. P. and Chandra, A., 2006. Leachate characterization and assessment of groundwater pollution near municipal solid waste landfill site. *Environmental Monitoring and Assessment*, 118(1-3), 435-456.
- [18] Ortiz, O., Castells, F. and Sonnemann, G., 2009. Sustainability in the construction industry: A review of recent developments based on LCA. *Construction and Building Materials*, 23(1), 28-39.

- [19] Peuportier, B. L. P., 2001. Life cycle assessment applied to the comparative evaluation of single family houses in the French context. *Energy and buildings*, 33(5), 443-450.
- [20] Saiz, S., Kennedy, C., Bass, B. and Pressnail, K., 2006. Comparative life cycle assessment of standard and green roofs. *Environmental Science and Technology*, 40(13), 4312-4316.
- [21] Sam-Cwan, K., Hwan, J. S., Il-Rok, J., Ki-Hun, K., Myung-Hee, K., Jae-Hyung, K., ... and Dong-Hee, J., 2001. Removal efficiencies of PCDDs/PCDFs by air pollution control devices in municipal solid waste incinerators. *Chemosphere*, 43(4), 773-776.
- [22] Shen, L., Shuai, C., Jiao, L., Tan, Y. and Song, X., 2016. A Global Perspective on the Sustainable Performance of Urbanization. *Sustainability*, 8(8), 783.
- [23] Singh, A., Syal, M., Grady S.C. and Korkmaz, S., 2010. Effects of green buildings on employee health and productivity. *American Journal of Public Health*, 100 (9), 1665–1668.
- [24] Tam, C. M., Tam, V. W., and Tsui, W. S., 2004. Green construction assessment for environmental management in the construction industry of Hong Kong. *International Journal of Project Management*, 22(7), 563-571.
- [25] Wu, P., and Low, S. P., 2010. Project management and green buildings: Lessons from the rating systems. *Journal of Professional Issues in Engineering Education and Practice*, 136(2), 64-70.
- [26] Wu, X., Zhang, Z. and **Chen, Y., 2005. Study of the environmental impacts based on the “green tax”—** applied to several types of building materials. *Building and Environment*, 40(2), 227-237.
- [27] Wu, Z., Shen, L., Ann, T. W. and Zhang, X., 2016. A comparative analysis of waste management requirements between five green building rating systems for new residential buildings. *Journal of Cleaner Production*, 112, 895-902.
- [28] Zhang, Y. and Altan, H., 2011. A comparison of the occupant comfort in a conventional high-rise office block and a contemporary environmentally-concerned building. *Building and Environment*, 46(2), 535-545.
- [29] Zuo, J. and Zhao, Z. Y., 2013. Green building research—current status and future agenda: A review. *Renewable and Sustainable Energy Reviews*. 30 (3), 271-281.

Contribution of Knowledge in Sustainable Building Design in Emerging Markets: A Case of Vietnam

Hung Duy NGUYEN^a, Long Duy NGUYEN^b, CHIH Ying-yi^c, Long LE-HOAI^d

^a Ho Chi Minh City University of Transport, Vietnam, hung.nguyen@ut.edu.vn

^b Florida Gulf Coast University, United States of America, lnguyen@fgcu.edu

^c The Australian National University, Australia, ying-yi.chih@anu.edu.au

^d Ho Chi Minh City University of Technology, Vietnam, lehoailong@hcmut.edu.vn

ABSTRACT

Unlike it is in the developed world, green buildings (GBs) have been a relatively new concept in emerging markets. In Vietnam for example, local green building rating systems, such as LOTUS was first released in 2010 by Vietnam Green Building Council (VGBC); and Excellence in Design for Greater Efficiencies (EDGE) was introduced in 2015 **by the World Bank's International Finance Corporation (IFC). As a result, the number of certified GBs in Vietnam is still limited.** Given this slow development in GBs, uncertified regular buildings are still dominant in Vietnam, contributing to substantial energy use and pollution. To reduce emissions and improve energy efficiency, it is thus essential to embed sustainable design and construction practices in uncertified regular buildings. **As the first step towards this journey, this study investigated the effect of participants' characteristics on the implementation of sustainable practices in regular building projects.** In particular, a questionnaire survey was conducted to **understand how participants' GB-related knowledge and project roles affect the extent to which various sustainable practices were implemented in building projects in Vietnam.** Statistical analysis showed that the degree of **application of the sustainable practices was positively correlated with participants' GB-related knowledge.** Hierarchical moderated regression analysis further showed that **participants' roles (e.g., owners and designers) moderated the relationships between their GB-related knowledge and the application of sustainable practices.** Specifically, this relationship was most significant for owner representatives, followed by designers and constructors. These findings imply that practitioners, especially those working for owners and designers, should be equipped with adequate GB knowledge to advance sustainable building practices in fast-growing emerging economies.

Keywords: green rating tool, green building, emerging markets

1. INTRODUCTION

Construction and operation of buildings have substantially impacts on a country's economy, society and environment. They are however also one of the major contributors to greenhouse gas emissions and other environmental pollutants in both industrialized and developing countries (Kientzel and Kok, 2011). As such, sustainable construction practices have attracted significant interest in developed countries and more so in some developing countries (Hassan et al., 2016). Indeed, a recent report revealed that emerging economies have experienced a strong green building (GB) growth, expecting to grow two to six times over current levels in the next three years (Dodge Data & Analytics, 2016).

Vietnam is an emerging market where its economic growth is among the fastest in the world since the early 1990s (World Bank, 2016). Unlike it is in the developed world, however, GBs is still a relatively new concept in Vietnam. For example, a local GB rating system (i.e., LOTUS) was first released in 2010 by Vietnam Green Building Council (VGBC); and Excellence in Design for Greater Efficiencies (EDGE) was introduced in 2015 by the World Bank's International Finance Corporation (IFC). As a result, as of 2015, there were only about 70 certified or registered GBs in Vietnam under different GB rating systems, including LOTUS, the U.S. Leadership in Energy and Environmental Design (LEED), EDGE, and Singaporean Green Mark (Millet, 2016). This means that despite of the promising GB growth, newly constructed and existing uncertified conventional buildings (refer to hereafter as **"regular buildings"**) **are still dominant in Vietnam and other emerging economies.** To reduce pollution and energy use associated with regular buildings, it is thus essential to explore the opportunities to embed sustainable practices into their design and construction. As noted by Bartlett and Howard (2000), a good understanding of GBs benefited both business and the environment. As the first step towards this journey, this study empirically

investigated the effect of **participants' characteristics, namely their GB-related knowledge and project roles**, on the implementation sustainable practices in regular building projects in Vietnam.

2. RELATED WORK AND HYPOTHESIS

Previous studies have identified several practitioner-related enablers for the adoption of sustainable practices in buildings design and construction. **The designers' and senior management's supports, project managers' competence and project team members' GB-related experience and knowledge** were critical factors for successful GB project deliveries in Singapore (Ofori and Kien, 2004; Li et al., 2014). Similarly, in Turkey, **project owners' sustainability commitment, top management's support, and the collaboration among project parties** were found to be critical (Aktas and Ozorhon, 2015). **Constructors' early involvement, and architects' early inclusion of green strategies** in their designs are also important enablers (Swarup et al., 2011). A recent study further showed that clients and market conditions play a critical role in catalyzing the diffusion of GB guidelines in countries such as India, Indonesia, and Turkey (Mollaoglu et al., 2016).

On the other side of the same coin, some studies identified project participants' misperceptions about GB (e.g., high cost and technical complexity and challenges) and lack of relevant knowledge as key barriers toward the deliveries of GBs, especially in emerging markets. For example, Zhang et al. (2010) found that GB implementation in China are hindered by the perceived high cost, technical difficulty during construction, and lack of knowledge and awareness of green technologies. Lack of interest and communication amongst team members and low interests from clients and market were some challenges facing Singapore (Hwang and Tan, 2012). Lack of knowledge was identified as a major barrier for sustainable and energy efficient buildings in countries including Venezuela (Pietrosemoli and Monroy, 2013), Korea (Kang et al., 2013), Malaysia (Shari and Soebarto, 2014), and Kuwait (AlSanad, 2015). The literature review indicated that much research has been done with regard to the **potential effect of various participants' characteristics (e.g., levels of supports, interest and commitment) on the sustainable practices in the building sector in emerging economies.** Among the various practitioner-related factors **discussed above, project participants' GB-related knowledge** has been consistently identified by many researchers as critical. This criticality stems from the fact that, in spite of the governmental efforts, the decision to implement sustainable practices majorly depended on project parties, including owners, designers, and contractors (Hassan et al., 2016). Thus, their GB-related knowledge can significantly shape the practices and outcome of GB projects. Indeed, Abidin (2010) found that the effort towards adopting sustainable practices in Malaysia depended largely **on individual project participants' awareness and knowledge about GBs. Similar conclusions were also found in Kuwait (AlSanad, 2015).** In Brazil, Teixeira et al. (2016) indicated that green training was positively associated with the implementation of green supply chain practices.

Even though prior studies have suggested the potential effect of different project participants' GB-related knowledge on the adoption of sustainable practices, there is still a lack of empirical evidence to support this relationship; and investigate how it may be moderated by participants' roles (e.g., project owner, project manager and team members). In addition, **most of the prior studies focused mainly on GBs. Given that regular "non-green" buildings will remain dominant in emerging markets in the near future, it is equally important to embed sustainable practices in such buildings.** Taking altogether, this study aims at filling these gaps by quantitatively investigating **the interactive effect of participants' GB-related knowledge and roles on the adoption of sustainable practices in regular building projects in Vietnam.** In particular, this research aims to quantitatively test the following hypotheses:

- **Hypothesis 1 (H1): Participants' GB-related knowledge (GBKn) is positively related to the application of sustainable practices in a regular building project.**
- **Hypothesis 2 (H2): Participants' roles (i.e., owners, designers, constructors) moderate the relationships between their GB-related knowledge and the application of sustainable practices in a regular building project.**

3. RESEARCH METHOD AND MEASURES

A questionnaire survey was conducted to test the proposed hypotheses. **The unit of analysis is "a building project."** Thus, survey respondents were asked to choose one building project that they were most recently involved and to: (1) rate the degree of application of various sustainable practices in their selected projects; (2) report their demographic information such as their positions, years of experience, and knowledge of GB rating systems. The questionnaire (in either online or paper-based format) was sent (either by emails or hand-delivery) to a total of 850

potential respondents who work in the construction industry in Vietnam. A total of 240 responses (i.e., 225 hard copies and 15 online forms) were received, resulting in an overall response rate of 28%. Among these, 36 surveys were eliminated due to incomplete responses in the questionnaires or the respondents have less than 3 years of experience. At the end, a total of 204 valid responses remain for further data analyses.

Sustainable practices in a country will be influenced by the local GB certification systems. Thus in this study, sustainability in a building project was measured by a total of 39 sustainable practices derived from the GB criteria listed in LOTUS, a widely recognized local GB rating system in Vietnam. These include 6 items in energy (E), 5 in adaptation and mitigation (A), 4 in water (W), 4 in materials (M), 4 in ecology (Eco), 4 in waste and pollution (WP), 4 in health and comfort (H), 4 in community (CY), and 4 in management (Man). Specifically, survey participants were presented with these 39 sustainable practices and were instructed to rate “the degree that each practice was implemented in their selected project” on a 5-point scale (1: “not at all”; 2 = “small degree”; 3 = “moderate degree”; 4 = “high degree”; 5 = “very high degree”).

4. RESULTS

4.1. Characteristics of respondents

Table 1 summarizes the project profile and respondents’ characteristics. Out of the projects selected by respondents, 169 (82.8%) were regular buildings (non-certified) while 35 (17.2%) were certified GBs. Respondents’ roles in their selected projects included owner representatives (25%), designers (36.8%), constructors (36.8%), and others (1.5%). In terms of professional experience, respondents had 3-5 years (47.5%), 6-10 years (34.3%), 11 - 15 years (10.3%), and 16 years or more (7.8%). This distribution somewhat reflected the young Vietnamese labor workforce and population. More than three quarters (77%) of the respondents had no prior experience with GB projects while about a quarter (23%) of them was involved in at least one GB project. Regarding knowledge of at least one GB rating system, 34.8%, 19.1%, and 46.1% of them reported that they were “not familiar,” “somewhat familiar,” and “familiar,” respectively.

Description	Frequency	Percent
<i>Surveyed projects:</i>		
Regular building (non-certified)	169	82.8
Certified green building (LOTUS, LEED, etc.)	35	17.2
<i>Role in the surveyed project:</i>		
Owner representatives (owner and PM consultants)	51	25.0
Designers (architects, engineering designers)	75	36.8
Constructors (contractors, construction managers)	75	36.8
Others	3	1.5
<i>Years of professional experience:</i>		
3-5 years	97	47.5
6-10 years	70	34.3
11-15 years	21	10.3
16 years or more	16	7.8
<i>Prior experience in certified green building project(s):</i>		
No	157	77.0
Yes	47	23.0
<i>Knowledge of at least one green building rating system:</i>		
Not familiar	71	34.8
Somewhat familiar	39	19.1
Familiar	94	46.1

Table 1: Characteristics of respondents

4.2. Applications of sustainable building practices

Table 2 summarizes the overall degree of application of sustainable practice categories in regular and certified GB projects. On average, all sustainable practices demonstrate a much higher level of adoption in certified GBs as compared with regular buildings. The overall degrees of application (AllGB) were 2.73 and 3.46 for regular and GB projects, respectively. Sustainable practices in categories such as waste and pollution, materials, health and comfort, and management tended to be applied to a much higher extent in certified GBs than regular buildings.

As expected, sustainable practices were more common among certified GBs. This means that there is still a long way to go with embedding sustainable practices in regular buildings. As such, an investigation into how the **participants' roles and GB-knowledge** may affect the adoption of sustainable practices in regular buildings is essential. Such an understanding may inform the development of strategies to better equip project owners, designers, and constructors with the necessary knowledge to voluntarily adopt sustainable practices in future regular building projects.

Sustainable building practice	Regular building		Certified GB	
	Mean	SD	Mean	SD
Energy (E)	2.86	0.61	3.40	0.70
Water (W)	2.51	0.79	3.12	0.83
Materials (M)	2.42	0.75	3.30	0.73
Ecology (Eco)	2.59	0.74	3.24	0.71
Waste and Pollution (WP)	2.44	0.71	3.44	0.82
Health and Comfort (H)	2.90	0.75	3.70	0.71
Adaptation and Mitigation (A)	3.00	0.70	3.65	0.61
Community (CY)	2.89	0.72	3.57	0.56
Management (Man)	2.83	0.72	3.63	0.66
Overall (AllGB)	2.73	0.56	3.46	0.52

Table 2: Degree of application of sustainable design practices

4.3. Effect of knowledge in sustainable design of regular buildings

As per research objectives, only the effect of **participants' GB-related knowledge and roles** on sustainable practice among regular building projects was examined. Thus this analysis only included the 169 surveys that focused on regular buildings. Among these, 3 surveys were further removed due to that **respondents reported "others" in their project roles (Table 1). Consequently, a total of 166 responses remained, whose respondents' roles falling into owner representatives, designers, and constructors.**

Analysis of variance (ANOVA) was conducted to test H1 (Table 3). For all roles, the degrees of application of the sustainable practices were statistically significantly different in all categories across GB knowledge groups. H1 was thus supported. Table 3 also displays these tests for separate participant roles (i.e., owner representatives, designers, and constructors). One can observe a variation across different roles in terms of whether the effect is **significant or not. This implies a possible moderating effect of participants' roles on the relationships between their GB-related knowledge and the application of sustainable practices, as stated in H2.**

Category	All roles	Owner representatives	Designers	Constructors
Energy	√	√+		
Water	√	√+		
Materials	√+	√+	√-	√-
Ecology	√+	√+		
Waste and pollution	√+	√+		√
Health and comfort	√+	√+	√-	
Adaptation and mitigation	√+	√+	√-	√
Community	√-	√+		
Management	√+	√+		√
Overall	√+	√+		√-

Significance level of 0.1 (√-); 0.05(√); and 0.01 (√+)

Table 3: Results of ANOVA for testing hypothesis 1

Hierarchical multiple regression analysis was thus conducted to test H2. In particular, this analysis assessed the incremental explanatory power of variables in each block (Cohen et al., 2003). In the first step (Model 1), two variables, namely GB related knowledge (GBKn) and **participants' roles (Role), were included. In the second step (Model 2), the multiplicative interaction terms were computed between GBKn and the moderator variable (Role) and entered to the regression equation. In order to reduce multi-collinearity, all study variables were mean-centered (Aiken and West, 1991). Table 4 summarizes the hierarchical multiple regression analysis for the overall sustainable building practices (AllGB). Model 1 showed that participants' role and GB-related knowledge accounted**

for a significant amount of variance in the application of the overall sustainable building practices ($F(2, 163) = 12.384, p < .001$). Model 2 with the interaction between Role and GBKn accounted for significantly more variance than just Role and GBKn by themselves ($F(3, 162) = 12.500, p < .001$). R square change = .056, $F(1, 162) = 11.183, p = .001$ indicated that there is potentially significant moderation between Role and GBKn on the application of the sustainable practices. Similar findings were also found for individual sustainability categories except “management” category. H2 was thus generally supported.

Study variable	Statistics	Model 1	Model 2
GB-related knowledge (GBKn)	Beta	.349*	.964*
Role in the most recent project (Role)	Beta	.114	.633*
Two-way interaction (Role x GBKn)	Beta		-.825*
	R ²	.132*	.188*
	ΔR^2	.132*	.056*
	F	12.384*	12.500*

*Standardized coefficient; * $p < .001$

Table 4: Results of the hierarchical moderated regression

This interaction effect is further assessed by using PROCESS (i.e. an SPSS add-on) developed by Hayes (2013). As an example, Figure 1 illustrates the interaction plot for the energy category. The interaction plots for other sustainable categories (i.e., water, materials, ecology, etc.) show similar patterns. These interaction plots suggested an enhancing effect that as GB-related knowledge of participants increased: (1) the degree of application of the sustainable practices also increased; and (2) the degree of increase in the adoption of sustainable practices is the most significant for owner representatives, followed by designers and constructors. Additionally, participants work as owner representatives that were familiar with GBs had the highest degree of application of the sustainable ideas in their most recent projects.

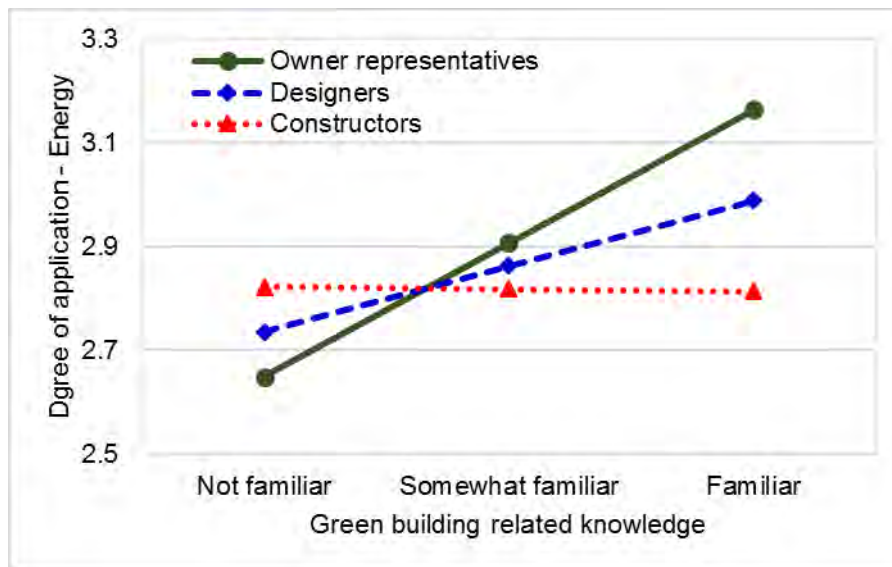

Figure 1: Interaction between practitioners' roles and GB knowledge in sustainable design

5. DISCUSSION AND CONCLUSIONS

Given the dominance of regular buildings in emerging economies, embedding sustainable practices to the design and construction of such buildings is imperative to reduce their negative environmental impacts. This is however a challenging task due to the common lack of knowledge of sustainability in such countries. To overcome this, this study empirically investigated the relationship between participants' knowledge and the adoption of sustainable practices; and the moderating effect of their project roles in Vietnam. As expected, the degree of application of the sustainable practices in certified GBs was found to be much higher than that in regular buildings. For regular building projects, the results confirmed a positive relationship between the participants' GB-related knowledge and the level of sustainable practices. Specifically, the adoption of sustainable practices in regular buildings increases as participants' GB-related knowledge increases. The research findings further suggested that this positive effect

is the strongest for project owner representatives. In other words, if project owners (and/or their representatives) have good levels of GB-related knowledge, they are more likely to make the strategic decisions that can facilitate sustainable practices in the whole project life. These findings highlight the importance to provide appropriate training to project participants to advance sustainable practices in fast-growing emerging economies like Vietnam. In cases where resources for GB training are limited, the priority should be given to the training programs targeting at project owners (and/or their representatives).

Although prior studies have investigated issues related to GB project deliveries, few provided an empirical evidence **on the contribution of project participants' knowledge and roles to the sustainable practices in regular buildings in emerging economies**. As such, this study offers important theoretical contribution and opens the door to more future research on the interface between human factors and sustainable practices. The findings may also inform the development of practical strategies to develop the supporting human capital. Despite of the focus on the Vietnamese building industry, the research methods and implications can be applied to other countries, especially emerging markets.

REFERENCES

- [1] Abidin, N.Z., 2010. Investigating the Awareness and Application of Sustainable Construction Concept by Malaysian Developers. *Habitat International*, 34(4), 421-426.
- [2] Aiken, L.S. and West, S.G., 1991. *Multiple Regression: Testing and Interpreting Interactions*. Sage Publications, Thousand Oaks, CA.
- [3] Aktas, B. and Ozorhon, B., 2015. Green Building Certification Process of Existing Buildings in Developing Countries: Cases from Turkey. *J. of Management in Engineering*, 31(6), 05015002.
- [4] AlSanad, S., 2015. Awareness, Drivers, Actions, and Barriers of Sustainable Construction in Kuwait. *Procedia Engineering*, 118, 969-983.
- [5] Bartlett, E. and Howard, N., 2000. Informing the Decision Makers on the Cost and Value of Green Building. *Building Research & Information*, 28(5-6), 315-324.
- [6] Cohen, J., Cohen, P., West, S.G., and Aiken, L.S., 2003. *Applied Multiple Regression/Correlation Analysis for the Behavioral Sciences*, 3rd ed., Lawrence Erlbaum, Mahwah, NJ.
- [7] Dodge Data and Analytics, 2016. *World Green Building Trends 2016: SmartMarket Report* [online]. Retrieved from: <http://analyticsstore.construction.com/smartmarket-reports/2016WorldGreen.html> [Retrieved on 12 September 2016].
- [8] Hassan, M.E., Kandil, A., Senouci, A., and Al-Derham, H., 2016. Organizational Behavior Attributes and Sustainable Construction Adoption: An Econometric Analysis Using Data from Qatar. *J. of Construction Engineering and Management*, 05016016.
- [9] Hayes, A.F., 2013. *Introduction to Mediation, Moderation, and Conditional Process Analysis: A Regression-Based Approach*. Guilford Press, New York, NY.
- [10] Hwang, B.G. and Tan, J.S., 2012. Green Building Project Management: Obstacles and Solutions for Sustainable Development. *Sustainable Development*, 20(5), 335-349.
- [11] Kang, Y., Kim, C., Son, H., Lee, S., and Limsawasd, C., 2013. Comparison of Preproject Planning for Green and Conventional Buildings. *J. of Construction Engineering and Management*, 139(11), 04013018.
- [12] Kientzel, J., and Kok, G., 2011. Environmental Assessment Methodologies for Commercial Buildings: An **Elicitation Study of US Building Professionals' Beliefs On Leadership in Energy and Environmental Design (LEED)**. *Sustainability*, 3(12), 2392-2412.
- [13] Li, Y.Y., Chen, P.H., Chew, D.A.S., and Teo, C.C., 2014. Exploration of Critical Resources and Capabilities of Design Firms for Delivering Green Building Projects: Empirical Studies in Singapore. *Habitat International*, 41, 229-235.
- [14] Millet, Y., 2016. Green Is Riel – Green Buildings [online]. Retrieved from: <http://www.eurocham-cambodia.org/uploads/4178c-mr.-yannick-millet.pdf> [Retrieved on 12 September 2016].
- [15] Mollaoglu, S., Chergia, C., Ergen, E., and Syal, M., 2016. Diffusion of Green Building Guidelines as Innovation in Developing Countries. *Construction Innovation*, 16(1), 11-29.
- [16] **Ofori, G., and Kien, H.L., 2004. Translating Singapore Architects' Environmental Awareness into Decision Making**. *Building Research & Information*, 32(1), 27-37.
- [17] Pietrosemoli, L. and Monroy, C.R., 2013. The Impact of Sustainable Construction and Knowledge Management on Sustainability Goals: A Review of the Venezuelan Renewable Energy Sector. *Renewable & Sustainable Energy Reviews*, 27, 683–691.

- [18] Shari, Z. and Soebarto, V., 2014. Investigating Sustainable Practices in the Malaysian Office Building Developments. *Construction Innovation*, 14(1), 17-37.
- [19] **Swarup, L., Korkmaz, S. and Riley, D. (2011). "Project delivery metrics for sustainable, high-performance buildings." *J. of Construction Engineering and Management*, 137(12), 1043-1051.**
- [20] Teixeira, A.A., Jabbour, C.J.C., de Sousa Jabbour, A.B.L., Latan, H., and de Oliveira, J.H.C., 2016. Green Training and Green Supply Chain Management: Evidence from Brazilian Firms. *J. of Cleaner Production*, 116, 170-176.
- [21] World Bank, 2016. Vietnam 2035: Toward Prosperity, Creativity, Equity, and Democracy [online]. Retrieved from: <https://openknowledge.worldbank.org/bitstream/handle/10986/23724/VN2035English.pdf> [Retrieved on 12 September, 2016].
- [22] Zhang, X., Shen, L., and Wu, Y., 2010. Green Strategy for Gaining Competitive Advantage in Housing Development: A China Study. *J. of Cleaner Production*, 19(2–3), 157–167.

Integrated Green Building Assessment Approach for the Next Decade

ANG Kian-seng^a, Jeffery NENG^b, May SIU^c

^a Building and Construction Authority, Singapore, ang_kian_seng@bca.gov.sg

^b Building and Construction Authority, Singapore, jeffery_neng@bca.gov.sg

^c Building and Construction Authority, Singapore, may_siu@bca.gov.sg

ABSTRACT

Singapore's Inter-Ministerial Committee on Sustainable Development had set a target for Singapore to green 80% of its buildings by 2030. To meet this target, the Building and Construction Authority's (BCA) Green Mark Scheme was launched in 2005 as a lever to set parameters and establish indicators to guide the design, construction and operation of green buildings within tropical climates. In pace with technological advancements and tapping upon best practices from the industry and worldwide, the BCA Green Mark scheme has undergone regular enhancements since then to continually push for higher sustainability standards in buildings - which must further evolve and incorporate new innovative and integrated solutions to be future ready amidst the challenging scenarios of the next decade. This paper details the fundamental revamp of the Green Mark scheme for new developments to its fifth incarnation - Green Mark 2015/ 2016. A milestone criteria that has been streamlined and aligned with globally recognised key sustainability outcomes, Green Mark 2015/ 2016 aims to transform the next wave of green building design through greater emphasis on climatically contextual design, total building energy performance, life cycle approach towards resource use and the liveability of the indoor environment. The criteria was developed in **extensive partnership with more than 130 industry stakeholders and academic bodies. This collaborative 'co-creation' approach facilitates a practical dimension to the scheme and empowers industry professionals to take ownership in pushing the frontiers for greener buildings.**

Keywords: high-performance building, design process, green rating tool

1. GREEN BUILDING TREND IN THE NEXT DECADE

1.1 Green buildings are becoming the norm

With rapid urbanisation, buildings are being built at an unprecedented rate. Worldwide studies in green buildings have instilled greater awareness and willingness in global sectors to appreciate the rising urgency and benefits in environmental sustainability. In addition to the primary drive towards reduce emissions, pollution and environmental degradation, there is also an increase in consumer demand for green buildings as they simultaneously offer a healthier environment. With the advent of disruptive technology, such as smart technology, the way we design and operate buildings will progressively evolve in positive ways. The building industry is opening their arms to the increasing pool of shareable knowledge and analysed data, lower costs of advancing technology, and rising stature of green branding. There is a widespread call to arms in the form of conferences, discussions and engagements for the sector to be informed, and also to be heard. These essential factors are propelling the demand of green buildings in years to come.

2. GREEN BUILDING TREND IN SINGAPORE

2.1 Singapore green building journey

Over the last decade, the Green Mark (GM) scheme has been instrumental in stimulating the growth of green buildings (GB) in Singapore. It has been an effective tool in setting parameters and establishing indicators to guide the design, construction and operation of buildings towards increased energy efficiency and enhanced environmental performance. With the Green Mark and the GB masterplans, the number of GB has increased from 17 in 2005 to more than 2800 today. This translates to more than 84 million m² of green GFA, equivalent to over **31% of the total building stock in Singapore. This is on track to achieve the target of greening 80% of Singapore's buildings by 2030.** Our efforts in greening the built environment have also gained traction on the international stage, with 305 GM project applications across 14 countries overseas.

The GM scheme has also been extended to include (i) premises within buildings, to help enable tenants implement sustainable practices and minimise operation cost, and (ii) developments beyond buildings, to recognise

sustainable practises at broader levels such as urban planning in district developments. To date, 17 GM schemes have been formulated.

With these achievements, Singapore was ranked second in corporate strategy consultant Solidiance's The Top 10 Global Cities for Green Buildings 2016 white paper, just behind Paris but ahead of London.

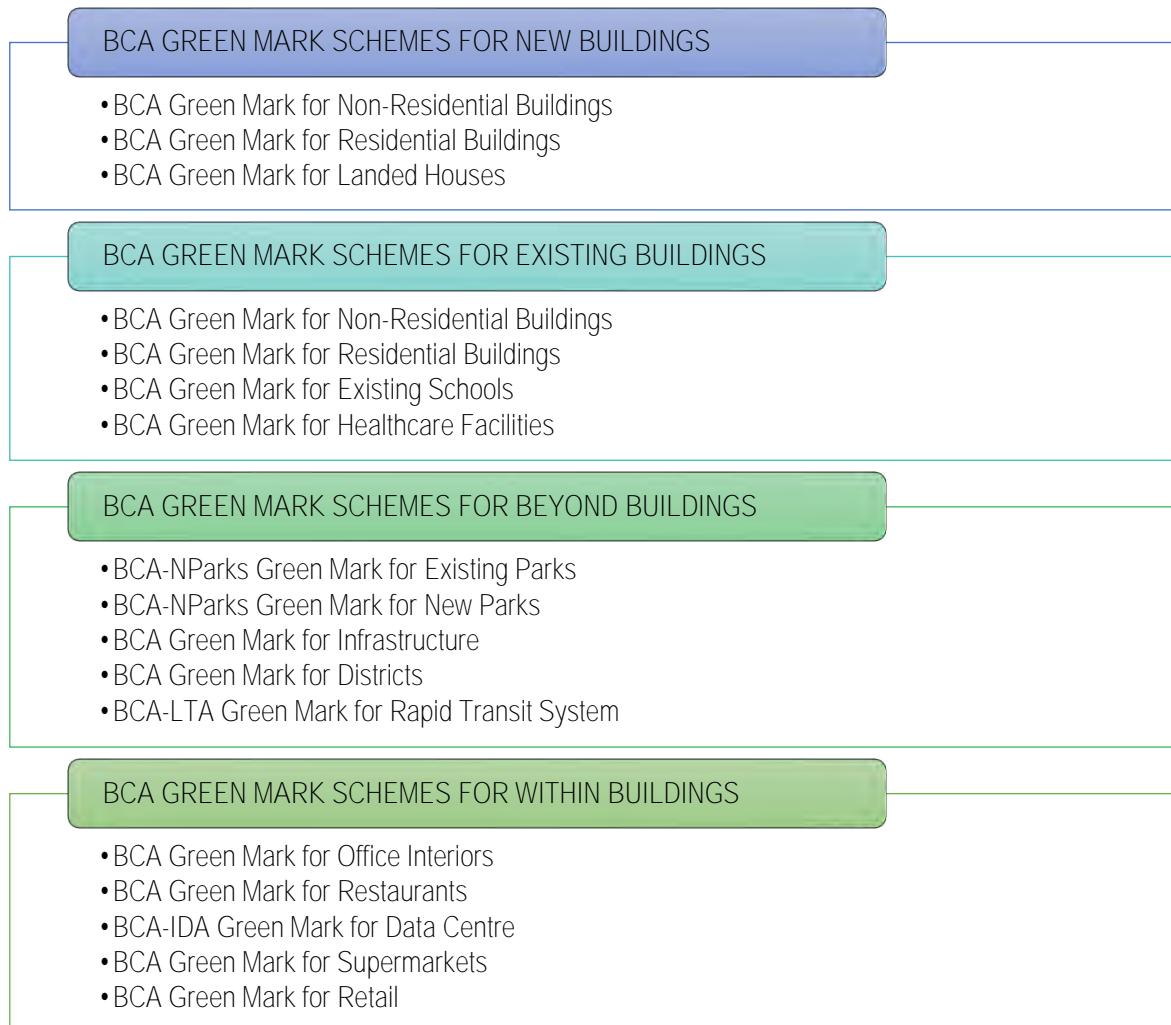

Figure 1: 17 Green Mark scheme

2.2 GM buildings are performing better than non-GM buildings in Singapore

In the BCA Building Energy Benchmarking Report 2016 , it was shown that the average Energy Utilisation Index (EUI) of GM commercial buildings was lower than the average EUI of similar non-GM commercial buildings (see Figure 2)

Chart 19: Average EUI of Green Mark and Non-Green Mark Commercial Buildings

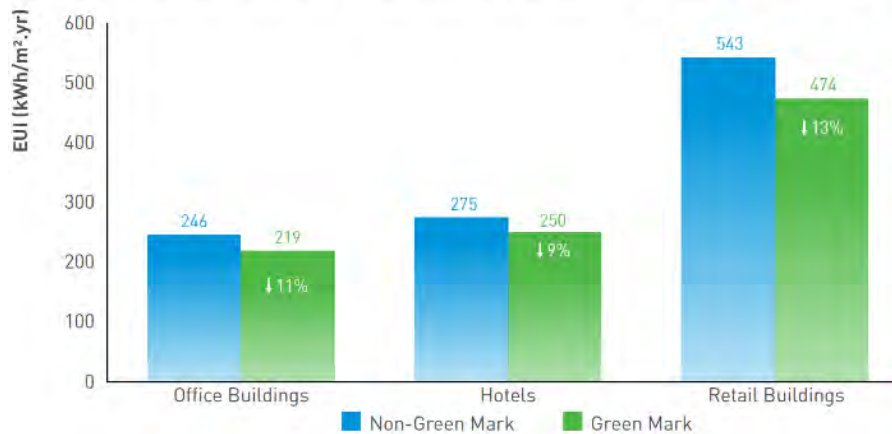

Figure 2: Average EUI of Green Mark & Non-Green Mark buildings

2.3 Some green building strategies have become prevalent

In addition, from a detailed statistical analysis of all projects certified under the previous GM versions, the following GB practices have been found to be prevalent through voluntary best practices:

- Majority of projects adopted the following GB strategies:
 - Water-efficiency: water efficient fittings, water saving strategies for cooling tower and linking water meter to building management system
 - Environmental protection: greenery in projects averaging more than twice its site area, usage of green cement and provision of green building user-guides
 - Indoor environmental quality: Usage of low volatile organic compound (VOC) paints
- Solar photovoltaic installed in Green Mark projects accounted for half of Singapore's grid-connected installed capacity.

2.4 Continuous enhancement of GM to keep pace with technology development and best practices

Since the launch of the first version of the GM scheme, it has undergone continued enhancements to keep pace with technology development in alignment with best practices from the industry here and in advanced countries (see Figure 2). The latest iteration, GM for Non-Residential Building (NRB) 2015 was implemented in 2016. GM for Residential Building 2016 and GM for Existing Buildings 2017 will be implemented over the next few years.

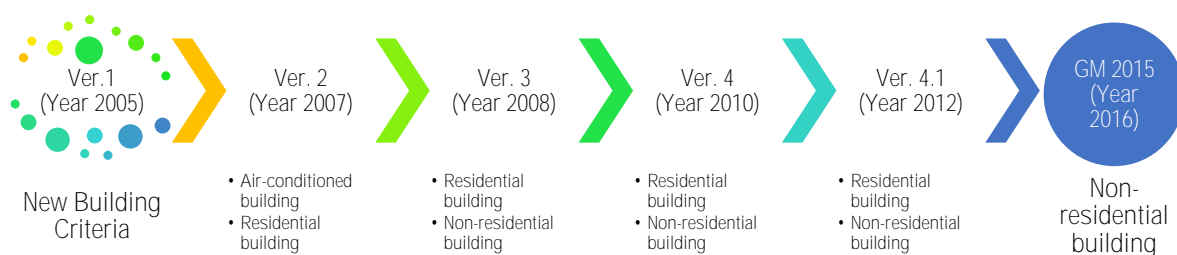

Figure 3: Evolution of Green Mark scheme

3. THE INTEGRATED APPROACH – THE NEW BCA GREEN MARK SCHEME

There is an increasing need for Green Building rating tools to be **'integrative' in multiple aspects, including not just their criteria, but also the development and implementation stage of the rating tools.** Working closely with industry experts in the evaluation will provide a relevant depth in the rating tool and an engaging outreach over the industry. **Additionally, it is necessary to unify the technical aspects with stakeholder's engagement to allow a lifecycle approach in energy management at various levels. Tying in passive design with active response systems, alongside the integration of time as a factor throughout the building's phase, ensures continuity and consistency**

in the building's performance. This overarching sense of integration is crucial in creating buy-in from the industry, value-added solutions, well-rounded projects and a more complete sustainable building, and the new Green Mark schemes were developed with this approach.

During the conceptualization of the new GM schemes, BCA took this opportunity to take stock of our achievements, identify our goals over the next 5-10 years, and streamline our assessment processes. The aim was to create a new set of criteria that will set the direction for the next chapter of Green Mark and our industry.

4. UTILIZING A HOLISTIC ASSESSMENT APPROACH TO WEAVE SIGNIFICANT ELEMENTS TOGETHER

4.1 The new Green Mark - Co-developed and co-owned by the industry

Through a process of creative-collaboration, 'specialist technical taskforces' were set up to map directions, review standards and map practical pathways for the new GM criteria development in the new version, complementing the increasingly robust regulations and building codes. 14 industry taskforces, co-chaired by industry experts, were formed, tapping on the knowledge of 134 industry members. This process facilitated a practical dimension to the scheme but also empowered ownership and drive among industry professionals in striving for better performance.

4.2 The BCA Green Mark - Recalibrated for better comprehensiveness

To make GM more comprehensive and well-rounded in addressing various sustainable parameters, the structure and credit system of GM was re-calibrated (see Table 3) and analysed alongside various international rating tools (see Figure 7).

Section	Total Credits
Climatic Responsive Design	30
Building Energy Performance	30
Resource Stewardship	30
Smart & Healthy Building	30
Advanced Green Efforts	20 (Bonus credits)
Total	120+20

Table 1: Green Mark credits distribution for GM non-residential building: 2015

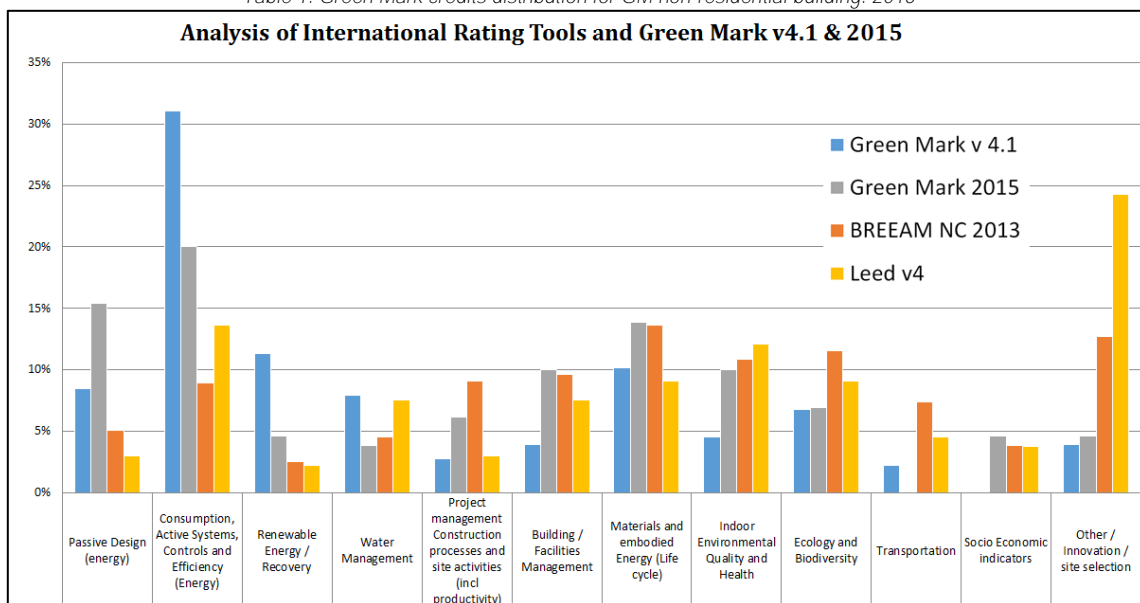

Figure 7: Analysis of various green building rating tools

4.3 The BCA Green Mark section 1 - Climatic responsive design

This section recognises the fundamental design and leadership required to develop a sustainable building for the tropics. The criteria provide a scoring framework that rewards the design approach and decisions at the brief formulation through to the detailed design stages of a project.

- Leadership – Effective leadership and collaborative teamwork to influence and drive improvements to the overall environmental credentials of projects, throughout the various project stages.
- Urban Harmony – **Consideration of the building's human centricity and whether it is in sync with its surrounding context with respect to its immediate locale.**
- Tropicality – Shaping building passive design in consideration of the climatic context to enhance effective thermal comfort for its occupants.

4.4 The BCA Green Mark section 2 - Building energy performance

This section's focus is on the energy effectiveness of the building. This delves into the energy efficient systems, total building energy consumption and the adoption of renewable energy.

- Energy Efficiency – Optimising the efficiency of high consumption mechanical and electrical systems.
- Energy Effectiveness – Holistic consideration of the effectiveness of energy systems' **performance usage** and consumption.
- Renewable Energy – Driving the creation of opportunities for generation and utilisation of renewable energy.

4.5 The BCA Green Mark section 3 - Resource stewardship

This section acknowledges the project team's effort to reduce the environmental impact of a building through sustainable construction approaches, the adoption of sustainable building systems and products by functional groupings and sustainable strategies in water and waste management.

- Water – Encouraging responsible use of water in buildings through water efficient monitoring and potable water replacement strategies.
- Materials – Reducing the carbon footprint emerging from construction activities by promoting sustainable material and practices via a life cycle approach.
- Waste – Responsible management of the building construction and operational waste.

4.6 The BCA Green Mark section 4 - Smart and healthy buildings

The quality of our built environment (indoors and outdoors) is critical for enhanced liveability among **Singapore's** community and end-users. **On the other hand, engaging users 'smartly' can spur the necessary behavioural** practices for more effective energy consumption. This section will be enhanced to look deeper into smart control strategies and indoor environmental quality management.

- Indoor Air Quality – Ensuring good air quality within functional spaces.
- Spatial Quality – Ensuring quality spaces that are acoustically and visually comfortable, inclusive and connect occupants to the natural environment.
- Smart Building Operations – Optimising equipment and related processes for energy reduction and comfort requirements through the use of automation and data and behavioural science.

4.7 The BCA Green Mark section 5 - Advanced green efforts

Finally, this section acknowledges additional efforts done by project team.

- Enhanced Performance – Greater recognition for projects that exceed the performance benchmarks stated in the criteria.
- Demonstrating Cost Effective Design – Recognising projects that demonstrate high levels of environmental performance without much increased cost.
- Complementary Certifications – Recognising the use of rating tools that rate environmental sustainability beyond the built environment.
- Social Benefits – Rewards projects that contributes to social sustainability.

5. FURTHER ENGAGEMENT WITH THE INDUSTRY STAKEHOLDERS

5.1. Pilot phase of GM non-residential building: 2015

Following extensive industry consultation and its development, GM Non-Residential Building: 2015 was launched for piloting at IGBC 2016. During the 1-year pilot phase, BCA has worked closely with industry stakeholders to pilot test the Green Mark criteria with actual projects. The first project has since completed the Green Mark board presentation and was on track to attain Green Mark Platinum under the pilot scheme. The project team found the criteria well aligned with their own sustainability goals. Besides doing the piloting, briefings to various industry associations and government agencies as well as consultation with the Green Mark Advisory Committee helped to finalise the criteria. GM RB: 2016 is currently undergoing its piloting phase.

6. CONCLUSION

The success of the new GM will mainly be attributed to the approach it has taken. It weaves together the different sustainable elements and presents a more refined and comprehensive slew of measures to address the evolution **of green buildings as we strive to work towards the strategic goal of advancing Singapore's continued leadership** in the region. Its integrative approach in its development, criteria and implementation has been well received by the building industry and will aid future projects to be more sustainable. These collective efforts will accelerate Singapore towards meeting the national target of greening 80% buildings by 2030 and underpin our vision of being **a global leader in 'green' buildings with special expertise in the tropics and sub-tropics** spearheading our journey towards a future-ready built environment.

Certification of Sustainability – Case Study Analysis of New German Standard

Merten WELSCH^a

^a Federal Institute for Research on Building, Urban Affairs and Spatial Development (BBSR), Germany, merten.welsch@bbr.bund.de

ABSTRACT

New sustainability requirements for federal buildings were defined by the Federal Building Ministry in the last years. As a result the Assessment System for Sustainable Building (BNB) was established as one of the most important instruments for the implementation of higher quality requirements for federal buildings.

Since 2015 the first results of complete certification processes according to BNB are available. As one of the first federal buildings the new Ministry of Education and Research (BMBF) in Berlin was certified with the BNB Gold Certificate and is now an outstanding example for sustainable building in Germany. This pilot project is the best federal building according to proven sustainability requirements. Special and innovative features of the building include for example a reduced energy demand (optimized heat insulation, PV modules integrated in the façade, gas-powered fuel cell), optimized selection of materials, optimized flexibility and optimized accessibility. Beside these building aspects there were also implemented exemplary quality assurance systems during the whole planning and construction phase.

Beside the BMBF numerous other current federal building projects consider the requirements of the BNB. All these projects are a part of the sustainable strategy of the federal government and they demonstrate that higher standards according to the holistic approach of sustainability can be achieved in day-to-day-business. The experiences can be used for new recommendations or future requirements for sustainability projects in the public sector.

The BNB and additional planning tools are published via the Sustainable Building Information Portal of the Federal Building Ministry (www.nachhaltigesbauen.de). Some selected contents are available in English.

Keywords: certification of sustainable buildings, life-cycle assessment, best practice

1. INTRODUCTION

Building in Germany is being geared towards sustainability. The German criteria checklist for the comprehensive assessment of sustainability aspects of buildings was developed by Federal Building Ministry and German Sustainability Council DGNB and is now used by the public sector and in a similar way by the private development sector.

The Assessment System for Sustainable Building (BNB) focuses on the entire life cycle of the built environment, covering all aspects from planning and construction to building operation with a view to optimizing overall quality.

As part of the German government, its sustainability strategy is assuming an exemplary role in implementing sustainability objectives in construction. Specific requirements for federal building projects are set out in the Sustainable Building Guidelines and the associated Assessment System BNB. The overall requirement is to attain **the “Silver Standard” according to BNB for those federal buildings for which a BNB variant is available. As a result** the BNB was established as one of the most important instruments for the implementation of higher quality requirements for federal buildings.

Since January 2015 the first results of complete certification processes are available. As one of the first federal buildings the new Ministry of Education and Research in Berlin and the new Federal Environment Agency in Berlin were certified with the BNB Gold Certificate.

2. IMPLEMENTING SUSTAINABLE REQUIREMENTS FOR FEDERAL BUILDINGS

2.1 Principles of sustainable building

In general, the classical understanding of sustainability is based on three dimensions: ecology, economy and socioculture, which are to be considered over a long period of time. The goal is to observe and to evaluate the entire useful life of a building – colloquial referred to as the life time of a building. For the actual observations of the life cycle, the first 50 years of a building are worked into the calculations.



Figure 1: Qualities of sustainable building



**Nachhaltiges
Bauen**

Figure 2: Logo of BNB in Gold

The main goal sought in the ecological dimension is primarily the protection of resources by optimally using construction materials and products, minimising use of space and of media (e.g. heat, electricity and water).

All requisite energy and material flows from the gain through the refinement and transport to the installation or disassembly alongside the global and local effects on the environment made by the energy use of the construction materials or the buildings are considered. Generally, this reduces environmental pollution at a local and global level. Different methods of analysis, e.g. risk analysis, analysis of the material flow, the material analysis and the ecological balance, are to be applied to objectively assess the environmental compatibility of construction products and of the whole building concept.

The costs which go above and beyond the mere costs of purchase and assembly – especially the life cycle costs are considered in the economical dimension of sustainability. This places the focus on life cycle costs relevant to the building, the economic viability and the value stability. As practice has shown, the life cycle costs can by far exceed the costs of construction. By analysing the life cycle costs, considerable opportunities for saving money during planning can be identified. As Life-Cycle-Costs (LCC), the costs of construction, the construction use costs and the demolition costs are additionally considered.

In addition to the question of functionality, the question of aesthetic design, the health aspects and comfort are relevant points in considering the social and cultural dimensions of sustainability. Winter and summer heat insulation contribute to comfort just as much as the noise protection or a deliberately chosen type of construction material (e.g. the use of emission free products). Construction designs, choice of material, building construction

and technology are to be interpreted to that effect and to be optimised, if needed. At the same time the construction design is to be made flexible enough that it can be easily adapted to the changing parameters e.g. change of use/user.

Alongside the ecological, economical and sociocultural aspects, the functional and technical properties (technical quality), the planning and implementation (process quality) and the, in part, local characteristics are decisive for the description and value of a building. This has extended the three columns of sustainability to five quantifiable qualities of sustainability – informatively supplemented by the local characteristics. The various aspects of sustainability interact directly with each other, so that the goal becomes a holistic and simultaneous assessment of every aspect.

2.2 How to use the “BNB”

The planning-based Assessment System for Sustainable Building (BNB) is distinguished for its comprehensive consideration of the entire life cycle of buildings. The assessment of building qualities is accomplished in accordance with transparent rules and objective, essentially quantitative methods.

No individual measures are evaluated in the results-oriented system, but rather their documentable effect on the overall concept of the building. Its application takes place throughout the planning stages, which means that it contributes not only to the optimization of the building but also and at the same time to quality assurance.

The BNB is organized into three different levels. The actual definition of the qualities takes place on the criteria level. These are described in detail in 45 criteria profiles on the basis of a total of around 150 indicators. The criteria profiles are grouped thematically in 11 criteria groups and 6 main criteria groups, thus making it possible to identify special qualities on each level.

On the basis of the degree of fulfilment, a score is assigned to the quality levels – Gold, Silver or Bronze. The results are presented in greater detail on a certificate with the Logo of BNB, representing the respective quality level. Additional information regarding the building is contained therein.



Figure 3: BNB gold certificate for BMBF

The modular structure of the system enables a differentiated presentation of the results; particular attention can thus be drawn to exceptional qualities in one or more subordinate areas of the assessed building. The BNB and additional planning tools are published via the Sustainable Building Information Portal of the Federal Building Ministry (www.nachhaltigesbauen.de). Some selected contents are available in English.

3. CERTIFICATION OF THE FEDERAL MINISTRY OF EDUCATION AND RESEARCH IN BERLIN

3.1 General information on the project

The new Federal Ministry of Education and Research (BMBF) in Berlin is the first federal civil building project that was realised by Public Private Partnership (PPP) and also the first building of that kind and size that received a certificate of BNB in gold. The project distinguishes itself by very high qualities and degrees of fulfilment in all main criteria groups of the assessment system BNB (81% - 99%).

This outstanding pilot project is now the best federal building according to proven sustainability requirements. The six-storey building of the BMBF was designed for 1,000 office workplaces and is integrated in the existing **development at the Berlin “Spreebogen”** vis-a-vis the government district as a recognizable city block.

The building is composed of two U-shaped office wings which are connected by a central block. The greened and noise-protected interior courtyards are opened to the railway line and thus enable a visual connection to the northern urban space.



Figure 4: Federal ministry of education and research in Berlin (BMBF)



Figure 5: Interior courtyard

On the ground floor there are the entrance area with a visitors center, a canteen, a library, childcare facilities, five greened interior courtyards and the two-storied foyer that leads to the conference center at the first floor. The offices on the upper floors are mainly designed as single-user workplaces and are supplemented with spacious open communication areas in the centered corridors.

The building is structured in several utilization units. Beside the 350 office workplaces for the employees working in Berlin, other 650 office workplaces, which are rented for third parties, were realized in a second utilization unit. The building features an excellent overall quality that is recognizable by the gold certificate with a degree of fulfilment of 86.2 % and it features a number of over-average – and in parts outstanding – specific qualities according to sustainable building as shown subsequently.

Users	Federal Ministry of Education and Research and others
Owner	Institute for Federal Real Estate (BImA)
Building Category	Administration Building
Type of Project	Public Private Partnership (PPP)
Total Building Costs	115 million Euro
Architect	C. Pelzeter; Heinle, Wischer und Partner, Berlin
Building Company and Contractor	BAM Deutschland AG
Completion	August 2014
Gross Floor Area	58.000 m ²
Workplaces	1.000
BNB Certificate	Gold (86.2%)

Table 1 Characteristics of BMBF

3.2 Specific qualities according to sustainability

3.2.1 Ecological and energetical quality

The energy concept for BMBF combines measures of optimizing the building physics according to the construction and technical systems which are in some places conventional and in other places very innovative. As a result the energy demand of only 36.1 kWh / (m²a) exceeds the strict requirements in Germany for this project by 71.6 %. Special and innovative features of the building for reducing the energy demand are for example:

- optimized heat insulation (heat transfer coefficient walls: 0.19 W/(m²K); heat transfer coefficient windows 0.84 W/(m² K))
- photovoltaic modules on the flat roof and integrated in the façade that produce about 100,000 kWh electric energy per year
- thermal activated ceilings instead of radiators in the offices
- ventilation system with heat recovery in every office, in conference rooms sensitive to CO₂ concentration
- LED lighting sensitive to movement and daylight in all offices
- external jalousie with light-diffusing slats in upper third and internal sun-blind with translucency in upper third for maximizing daylight even in a closed state
- combined heat and power (CHP) with block-type thermal power station (BTTP) and gas-powered fuel cell for generating electricity, heat and cooling instead of district heat (this system minimizes the primary energy demand and the CO₂ emission)
- the different system components are cross-linked with the building management system (BMS) by an intelligent interconnection (smart grid)



Figure 6: PV Modules in the Façade



Figure 7: LED Lighting: Sun Shutter with partly Translucency

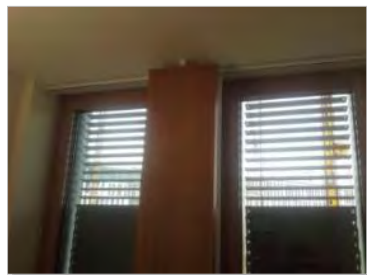

Figure 8: Jalousie with light-diffusing Slats

Type

Molten Carbonate Fuel Cell, MCFC

Producer	Fuel Cell Energy Solutions GmbH
Electrolyte	carbonated
Operating Temperature	600–650 °C
Fuel Gas	natural gas
Output Power	250 kW electric, 160 kW thermic
Efficiency	47 % electric, 79 % total
Savings Compared to Separated Generation	about 30 %

Table 2 Characteristics of Fuel Cell System in BMBF

3.2.2 Economical quality

The project could be realized in a high economic efficiency with a high energetic quality and a high level of comfort for the user. In order to ensure the flexibility and adaptability of the building for possible changing user demands in the future, the building enables different types of efficient office structures.



Figure 9: Communication area



Figure 10: Office facilities, mailboxes and tea kitchen in open areas

3.2.3 Socio-cultural and functional quality

The requirements according to the user demand for a high level of comfort are met by numerous aspects, as for example:

- According to indoor air quality and avoidance of harmful substances the highest quality levels of BNB were met by choosing low-emission building products.
- The accessibility of the foyer and of the office areas is over and above the normal standard (building, interior courtyards and floors are accessible without steps; well-spaced corridors and office rooms for wheelchair users; tactile guidance strips; speech modules in elevators; information in Braille or raised letters; barrier-free toilets on every floor).
- A competition for art in architecture was realized with more than 300 submitted designs of which 4 were chosen, as for example a virtual sculpture of air, light and water vapour with a connotation to a rainbow at the banister in the foyer.
- 282 bicycle stands are available for the employees.

- A high level of noise protection was realized.



Figure 11: Tactile guidance strips

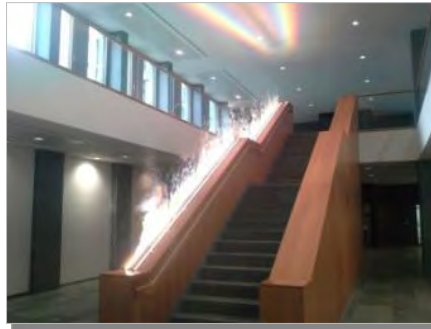

Figure 12: Virtual sculpture (artists B. Burchhardt, A. Lippke, M. Stammen)

After the first months in use the Federal Minister of Education and Research Johanna Wanka said “We feel very comfortable in these sustainable premises.”

3.2.4 Process quality

Beside the BMBF numerous other current federal building projects consider the requirements of the BNB, like for example:

- The new office building for 32 employees of the Federal Environment Agency in Berlin is designed as the **first federal “zero energy building” and received the certificate of BNB in gold in 2015 (more information: www.umweltbundesamt.de/)**.
- The renovation and reconstruction of the listed Federal Constitutional Court in Karlsruhe received the first certificate in silver according to BNB for complete refurbishment (more information: www.bnb-nachhaltigesbauen.de/).
- The aim for the new extension building for 100 employees of the Federal Environment Agency in Dessau is a **“zero energy building” and a certificate of BNB in gold (more information: www.umweltbundesamt.de/)**.

All these projects are a part of the sustainable strategy of the federal government and the experiences can be used for new recommendations or future requirements for sustainability projects in the public sector.

REFERENCES

- [1] Federal Ministry for the Environment, Nature Conservation, Building and Nuclear Safety (BMUB), (2016) Guideline for Sustainable Building, BMUB Berlin
- [2] Federal Ministry for the Environment, Nature Conservation, Building and Nuclear Safety (BMUB), Assessment System for Sustainable Building (BNB), <http://www.nachhaltigesbauen.de/>
- [3] Federal Ministry of Education and Research (BMBF), <http://www.bmbf.de/>

Integration of Energy and Material Performance of Buildings: I=E+M

Erik ALSEMA^a, David ANINK^b, Arjen MEIJER^c, Ad STRAUB^d, Geurt DONZE^e, Saskia VAN HULTEN^f

^a W/E Consultants Sustainable Building, The Netherlands, alsema@w-e.nl

^b W/E Consultants Sustainable Building, The Netherlands, anink@w-e.nl

^c Delft University of Technology, Faculty Architecture and the Built Environment (department OTB), The Netherlands, a.meijer@tudelft.nl

^d Delft University of Technology, Faculty Architecture and the Built Environment (department OTB), The Netherlands, a.straub@tudelft.nl

^e W/E Consultants Sustainable Building, The Netherlands, donze@w-e.nl

^f W/E Consultants Sustainable Building, The Netherlands, hulten@w-e.nl

ABSTRACT

A new methodology is proposed to assess integral performance of building with respect to energy and materials requirement over the building life cycle. Because the method builds on existing methods for Energy Performance and Materials Performance of Buildings, as defined by Dutch National Building Code, it provides an easily applicable method that allows optimized building design with respect to environmental impacts. Two case studies, one for building renovation and one for new Near Zero Energy Building show the advantages of integral assessment. Extending this approach for building assessment to other countries seems a logical step as it gives designers a better insight in total building performance.

Keywords: green rating tool, design process, policy and regulation

1. INTRODUCTION

The introduction of an energy performance requirement in the building regulations in Europe has resulted in major improvements in the energy efficiency of new buildings. Governed by the framework of the Energy Performance of Buildings Directive (EPBD Recast) each EU member state has formulated a methodology for energy performance evaluation for different building types. These calculation methods and performance standards, have been implemented in the national building regulations in each country. This legislation has been very successful in reducing the energy demand of buildings and in stimulating technological development for energy-efficient energy systems, building insulation and renewable energy. As a result the energy demand of new buildings has been reduced by a factor 10-100 since the 1970's. Moreover, from the year 2020 onwards all new buildings in the EU will have to conform to a "near-zero energy" (NZE) standard.

Now that NZE becomes the new standard, the role of building materials and embodied energy or related CO₂-emission is becoming more and more important. It is recognized that a focus on energy efficiency only, entails a clear risk of having buildings not necessarily performing very well with respect to other environmental criteria.

However, a broader assessment of the environmental impact of buildings, including materials, is not done regularly yet. Already for a long time there exists within the building community a great demand for methods to support the selection of environmentally benign materials for buildings. Formerly, lists of "preferred materials" or "materials to be avoided" were used. Although such lists are easy to use, the draw-back is that they do not allow for performance-based building design and optimization of the design with respect to materials choice.

In the research community Life Cycle Assessment (LCA) is a broadly accepted methodology to assess the environmental impacts of products. This LCA method has been applied to buildings as well (see, for example, ref. However, among architects, technical consultants and construction companies the use of Life Cycle Assessment for building design and building maintenance is no common practice yet, mainly due to the relative complexity of LCA tools.

In order to fill this gap a process was started 20 years ago in the Netherlands to develop an LCA-based calculation method which was specifically focused on buildings and relatively easy to use. Moreover, this calculation method was meant to become part of the National Building Code, just like the energy performance method. Next to a calculation method, a national LCA database for building materials was set up, providing the necessary data for the assessments. As a result the so-called "material performance assessment of buildings" became obligatory for new buildings in 2014. Important is that the new method is restricted to only the materials used in the construction

and maintenance of the building. This restriction was applied because the operational energy consumption of buildings is already governed by the existing Energy Performance standard.

So effectively there are now in the Netherlands two different performance indicators: one for the energy consumption during building use and one for the environmental impacts from materials. This raises the problem, that for designers it is difficult to determine the optimal solutions with respect to energy systems and the selection of materials with an impact on energy efficiency. For example the installation of solar panels or the addition of extra insulation to a building will result in a negative effect on the material performance due to additional materials, while on the other hand they improve the energy performance of the building. As the two indicators have an entirely different way of **“impact assessment” and of normalization they cannot be compared or balanced against each other.**

From a scientific point of view it would be quite logical to consider all environmental impacts from the building life cycle in one assessment system, and not divide it in two separate, incomparable assessments. On the other hand the building sector is very much accustomed to the use of energy performance methods and standards and a change towards an entirely new methodology would be problematic. In order to tackle this problem, we have developed a new framework to integrate the existing assessment methods for energy and materials performance, in such a way that their respective results are aggregated into a single indicator. In this method the LCA impacts of operational energy consumption are calculated and combined with the LCA results of the building materials, into a single impact score: $I = E + M$.

Below we will first outline the setup of the two existing assessment methods and describe how they were combined into a single, aggregated indicator. Then we will discuss some practical examples assessed with the new methodology and draw some conclusions.

2. EXISTING METHODS FOR ASSESSMENT OF BUILDING PERFORMANCE

2.1 Energy performance of buildings (EPG)

The method for calculation of the energy performance of buildings has been set up differently in each European country. **In the Netherlands the method called “Energie Prestatie van Gebouwen” (EPG) is based on a quite detailed energy balance for the building, together with a typical meteorological year and a standardized building use.** Local energy conversion systems (e.g. PV systems) are modelled with either standardized or customized conversion efficiencies.

As result from these model calculations the yearly energy consumption is determined in terms of the quantities of final energy carriers entering the building (i.e. electricity, natural gas, heat from district heating, biomass). The final energy consumption values are converted into equivalent primary energy requirements and normalized to a standardized primary consumption for the considered building type, thus resulting in a dimensionless Energy Performance Coefficient (EPC).

According to the present building standards a new residential building must have an EPC of 0.4, which corresponds to a primary energy demand of 60 kWh/m² for a typical row house.

2.2 Material performance of buildings (MPG)

The evaluation method called “MilieuPrestatie van Gebouwen”(MPG) is a relatively new, standardized method to assess the environmental impacts of the materials used during the life cycle of a building. This life cycle includes resource winning and production of building materials as well as the construction, maintenance and decommissioning of the building. Also energy requirements during construction and decommissioning are included. The assessment is based on LCA methodology and all data about the building materials are derived from a national database of environmental impact data (Nationale Milieu Database, NMD) which has producer-specific and more generic data for building materials and products. This database is managed by an independent organization which also safeguards the quality of LCA data submitted by producers.

Note that energy requirements for production of materials (**“embodied energy”**), as well as GHG emissions from **material production (“embodied CO₂”)** are all included in the MPG evaluation. So all effects caused by building construction, maintenance and demolishment, except for operational energy consumption, are in principle covered

by this method. Within the MPG method, standard values are predefined, for example with respect to the expected service life of buildings: 75 years for residential buildings and 50 years for non-residential buildings. More importantly the MPG definition document prescribes the impact assessment method that needs to be used. It was decided to perform the impact assessment in the first step on the basis of the CML method for Life Cycle Impact Assessment which discerns 10 impact categories. Because the assessment method has to be useful for building designers, a second step is applied in which all impacts are aggregated into one single impact score, with weighting factors based on the so-called “shadow price” for each impact category. **The shadow price (in €) was set equal to the virtual cost to avoid or prevent the damage of an environmental impact.** No normalization is performed.

With this method the environmental impact is expressed into one final score, using the functional unit prescribed by the MPG, as “€ per m² per year”.

3. NEW METHOD: INTEGRAL PERFORMANCE OF BUILDINGS

It is not always convenient to have two different assessment systems and performance indicators when actually it is the environmental life cycle performance of the building that one would like to consider. For an integral performance indicator we therefore take the life cycle methodology as starting point. The material performance indicator (MPG) is already evaluated according LCA methodology, so we need to assess the impacts of operational energy consumption (i.e. energy consumption during the utilization of the building) with the same impact assessment method. The amounts of energy consumed may then be derived from the energy performance calculation (EPG).

This sounds fairly simple, but it should be done very carefully in order to avoid double counting or not accounting some material or energy flows. For that we have to take a close look at the system boundaries defined in the two respective assessment methods.

We discern 5 different boundaries which are relevant for our considerations:

- the building boundary, where also energy flows entering the building are being measured (energy metering);
- the project boundary (i.e. a group of buildings with collective energy services);
- the system boundary for Energy Performance of Buildings calculation (EPG);
- the system boundary for energy distribution within the Netherlands;
- the system boundary for assessment of Material Performance of Buildings (MPG).

Whereas the Material Performance evaluation considers in principle a global system boundary, in line with general LCA methodology, the method for Energy performance considers a national or even subnational system boundary. Winning and distribution of natural gas, biomass and waste is not accounted explicitly in the EPG method, and production of electricity is only accounted with a standard conversion factor for primary energy and for CO₂ emission. Also notice that environmental impacts from the energy distribution system are outside the scope of both the EPG and the MPG methods.

For all energy conversion processes it should be considered carefully whether or not their material and energy flows are accounted in one of the methods. For example if we look at the conversion of natural gas in a gas boiler within the building we can notice that the inflow of gas into the building is well accounted for by the EPG method because it carefully models the efficiency of the heating system. But the emissions from the combustion process to the atmosphere (i.e. CO₂, NO_x) and to the water (acids) are not accounted for anywhere.

So, in order to obtain a complete assessment of environmental impacts, on the basis of EPG and MPG, we consider for each energy flow entering the building:

- Are all upstream impacts from the energy winning, conversion and distribution activities taken into account?
- Are all emissions and material inflows for the energy conversion processes within the building taken into account?

In practical terms this means that for each final energy carrier that may be consumed during utilization of the building we have to establish an impact factor (or a set of impact factors) which allows us to assess all

environmental impacts of the energy consumption using this carrier. For energy carrier inflow into the building (E_i) we have defined the corresponding environmental impact EPG_i^* as:

$$EPG_i^* = IF_i \times E_i,$$

Equation 1

where

E_i = final energy consumption for energy carrier "i" (in MJ), as derived from EPG

IF_i = environmental impact factor for energy carrier "i" (impact unit per MJ)

E_i^* = environmental impact for energy carrier "i" (in impact units)

We determined impact factors for a number of major energy carriers, all for the context of the Dutch energy supply system [see ref. [16] for details].

If we add up the EPG^* -results over all relevant energy carriers flowing into the building (e.g. gas and electricity) a total environmental impact score for the operational energy consumption of the building EPG^* is obtained:

$$EPG^* = \sum_i EPG_i^*,$$

Equation 2

Finally the integral environmental impact of the building is defined as:

$$IPG = MPG + EPG^*$$

Equation 3

The IPG score gives the desired score assessing the environmental impacts for operational energy consumption and the impacts related to materials use. As mentioned, impacts of embodied energy for materials are included in the MPG score.

Now for LCA practitioners and scientists in general the described method might sound as a cumbersome way to obtain results that can also be found by way of a standard LCA approach. The important difference, however, is that in our approach we make use of the results that are obtained from standardized calculation methods that are implemented in the Dutch Building Code and which are therefore familiar to the building community. In other words, without setting existing methods aside, we are able to derive integral impact scores for the building performance by applying just a few simple additional calculations. Moreover, the extra calculation step can easily be included in existing software tools for energy and material performance evaluation, like GPR Building and in that case requires almost no extra efforts from building designers.

In the next section we will explain what new insights can be gained from this new assessment tool for a case study on the construction of new houses. Elsewhere we have also discussed a case study for building renovation.

4. CASE STUDY: NEW NET ZERO ENERGY BUILDINGS (NZEB)

The IPG methodology should also be very useful for optimized design of new buildings especially as these have to meet the Net Zero Energy Building (NZEB) standard.

As a reference we start with a row house, which is built to comply with the draft NZEB standard. This house has a usable floor area of 124 m², R-values for the building envelope of 6-7 (m².K/W), triple glass windows (U=1.1 W/m².K) and a high-efficiency gas boiler for heating and DHW supply. In order to make it NZEB it is also equipped with about 20 m² of PV panels (3 kWp) and a Solar Hot Water system (2.5 m²).

First the effects of increased insulation thicknesses in the façade and roof was investigated. A feeling among designers may be that increasing insulation is not good for the environment because of the higher environmental load of the required materials. From our analysis we can observe that the contribution from the insulation material

is never more than 3,5% of the total building's impact, even if we would go to an unrealistically high R-value of 20 m².K/W (see also ref.[16]).

But what is also clear is that the energetic effects of insulation beyond R=5, are very small. Partly this is due to type of house (row house) with only 98 m² of exterior surface area. For a free-standing house the energy saving effects would have been larger. So there is no immediate reason to save on insulation thickness, because of concerns about the materials impact. The optimal thickness can be determined for each building type and climate, by using an analysis as shown above.

More significant effects can be seen in the next set of calculations were we look at solar energy installations. In Figure 1 we depict our NZEB house in 3 variants: 1) without solar energy installations, 2) with only photovoltaic panels (20 m², 3kW_p) and 3) a solar hot water installation of 2,5 m² and a slightly smaller PV panel area (17,5 m², where part of the PV panel area is replaced by solar hot water collectors. Figure 1 is a bit complicated because the PV panels generate more electricity than is used by the building (excluding domestic appliances!), which results in a negative impact from the PV generation. For this reason we show in a separate bar in Figure 1 the IPG-value, which is the sum of all impacts: IPG = MPG-building + MPG-solar + EPG*-gas + EPG*-electricity.

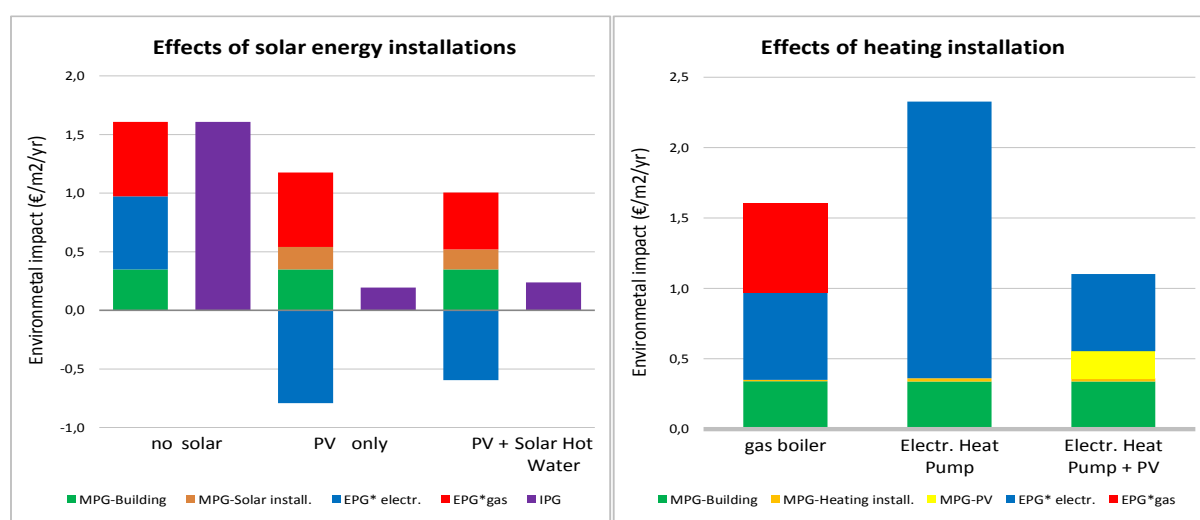

Figure 43 and 2: Effects on total environmental impact of building in relation to choice of solar energy installations and choice of the heating installation

Although the MPG-value from the PV installation is quite significant, about 50% increase in total MPG, the overall effect of the PV is very positive: the IPG-value is reduced from 1,61 to 0,19 €/m²/yr. The replacement of 2,5 m² of PV panels by a solar hot water collector results in a slightly worse overall impact (0.24 €/m²/yr). In this case the choice for a solar hot water system gives no improvement in environmental terms.

Figure 2 shows the effects of choosing a different type of heating installation, either a gas boiler or an electrical heat pump (ground water as source). Because the heat pump uses a substantial amount of electricity (from the grid) this has a significant negative effect. However if we add a PV installation (20 m²) the total impact is about 30% better than with only a gas boiler (and no PV). Nonetheless, the situation with gas boiler and PV (Figure 1) is found to be most environmentally friendly choice for this building. To make the all-electric variant of this building the most environmentally friendly we need to install an additional area of PV panels.

One conclusion is that the choice of installation for heating or for renewable energy generation has more effect on the total environmental impact than the level of insulation, beyond a certain adequate insulation level.

5. DISCUSSION

It is clear that many assumptions affect the precise outcome of our calculations. Therefore the reader should be quite careful to extend the results beyond the scope and background data of our study. On the other hand the more general conclusions with regard to energy-related versus material-related impacts of façade and roof insulation should be fairly robust. Also our conclusion about the large effects of the choice of energy conversion

equipment for heating and the effectiveness of PV systems should be reasonably robust as long as the background energy supply system is not entirely different from the Dutch system (for instance 100% hydro-electricity).

6. CONCLUSIONS

A methodology has been developed that makes it possible for building designers in The Netherlands to make an integral assessment of the environmental impacts of a new building or for building renovation projects. The new aspect is that our method is built on two existing building assessment methods that are already in use in the building community and which are part of the Dutch National Building Code. Because it builds on existing methods it is very easy for the building designer to determine the integrated environmental impact indicator for his plans, without necessity to learn complicated LCA tools.

In a number of typical examples we have shown the added value of the integrated assessment when designing a new construction at NZEB level. All-in-all the impact from materials choice and material amounts increases if we go towards near zero energy levels. For photovoltaic panels the material-related impact is fairly high (in comparison with other building components) but overall PV systems show a very large beneficial effect on the life cycle performance of the building.

Our general conclusion is that the proposed methodology to determine integrated environmental impacts provides valuable new insights for building designers. The new methodology and the related tools, will assist designers in making the right choices for specific buildings in specific circumstances. In our opinion it would be fruitful to develop and apply comparable methodologies in other countries. Our approach has the advantage that it provides a relatively easy assessment system for building designers without the need to learn new LCA tools which are not specific for buildings.

In view of the EU policy objectives to reduce the broader environmental impacts of buildings it would be advisable to develop further convenient methods and tools for life cycle impact assessment *at the building level*, such as described in this paper. Moreover, such tools should be easily applicable, so that they will be used in practice by building designers that wish to optimize their design with respect to integral environmental quality.

ACKNOWLEDGMENTS

The authors wish to acknowledge the support and critical input from partners in the project TKI KIEM and furthermore the financial support from the research programme TKI ENERGO is gratefully acknowledged.

REFERENCES

- [1] European Commission, EPBD Recast, Directive 2010/31/EU of the European Parliament and the Council of 19 May on the energy performance of buildings (EPBD), Brussels, 2010
- [2] Antink, R. et al. Greening The Building Supply Chain, Sustainable Buildings and Climate Initiative, United Nations Environment Programme, UNEP-2014
- [3] European Commission, On Resource Efficiency Opportunities in the Building Sector, Communication from **the Commission (...), COM(2014) 445 final**, Brussels 2014.
- [4] Anink, D., Boonstra, C. and Mak, J. 1996. Handbook of Sustainable Building. London: James & James Science Publishers
- [5] Heijungs R., et al., Environmental Life Cycle Assessment of products: Guide. Leiden: Centre of Environmental Science (CML), Leiden university, 1992
- [6] Kortman J., van Ewijk H., Mak J., Anink D., Knapen M., Eco-quantum the LCA-based computer tool for the quantitative determination of the environmental impact of buildings, Proceedings of Buildings and Environment in Asia Conference, Singapore, 1998
- [7] Häkkinen, T. (Ed.), Sustainability and performance assessment and benchmarking of building – Final report, VTT, Espoo 2012
- [8] Bouwbesluit 2012 (National Building Code 2012), Netherlands Ministry of Internal Affairs, The Hague, 2012
- [9] Anink, D. et al., [Assessment of the Environmental Performance of Constructions and Civil Engineering Works](#), Stichting Bouwkwiteit, 2015
- [10] Nationale Milieu Database, [http: https://www.milieudatabase.nl/](https://www.milieudatabase.nl/)

- [11] LCA Impact Assessment methodology developed by the Center of Environmental Science (CML), Leiden University, The Netherlands, [version 4.1](#) (April 2013)
- [12] [GPR Building](#), software for sustainability assessment of buildings, W/E Consultants, 2016
- [13] P. Staal-Gruit, Resultaten verkennende studie voor eisen aan Bijna Energie Neutrale Gebouwen, DGMR, Arnhem, 2015
- [14] Wild - Scholten, M.J. de; Alsema, E.A.; Environmental Life Cycle Inventory of Crystalline Silicon Photovoltaic System Production, [ECN-E-06-019](#), 2006
- [15] E.A. Alsema, et al., Integration of Energy and Material Performance of Buildings: I=E+M, Energy Procedia, Vol. 96, Sept. 2016, p. 517–528, <http://dx.doi.org/10.1016/j.egypro.2016.09.094>

Session 7.5: SBE Assessments – Practice Review

Transnational Harmonization of Built Environment Assessment Systems: The CESBA Passport Principle

Andrea MORO^a, Markus BERCHTOLD-DOMIG^b, Etienne VIENOT^c

^a *iisBE Italia R&D, Italy, andrea.moro@iisbeitalia.org*

^b *heimaten, Austria, markus.berchtold@heimaten.com*

^c *Rhonalpénergie-Environnement (RAEE), France, etienne.vienot@raee.org*

ABSTRACT

Assessment systems are recognized to be a powerful tool to promote the movement of building sector towards a better sustainability. Actually only in Europe more than 60 building rating systems are in use at local, regional and national level. This fact should be considered positive, but a critical issue emerged: ratings (scores) and labels are not comparable. The assessment systems are different in methods, physical and time boundaries, issues taken into consideration, number of criteria, scoring systems, etc. This lack of conformity created confusion among the building sector stakeholders. A harmonization process is clearly needed at transnational level in the way to create a common approach to building assessment that would enforce the effectiveness of certification labels. To achieve this objective, the CESBA (Common European Sustainable Built Environment Assessment) initiative has been launched with the involvement of numerous public and private European organizations from 15 countries. Since 2011, the principle proposed by CESBA for the harmonization of building assessment systems is to establish a transnational core set of KPIs (Key Performance Indicators) based on common metrics, a common denominator, that each system should adopt to guarantee the comparability of assessment results concerning the most important issues. Besides the usual label/ certificate produced by each assessment system, it will be possible to have a Passport that will show the value of **the common KPIs. The Passport isn't a new assessment systems and it doesn't produce a rating.** The rating will always be given by local systems on the base of regional priorities and context. The objective of the Passport is to allow the transnational comparison in absolute terms of the performance reached by each building to measure the progress toward common objectives (i.e. Global Warming). The CESBA approach has been proposed by the EC in the Communication 445 of 2014.

Keywords: green rating tool, policy and regulation, green ethics

1. THE ISSUE: IT IS NOT POSSIBLE TO COMPARE SUSTAINABILITY LABELS

Only in Europe, more than 60 building rating systems are actually in use at national, regional and local level. This number is increasing because assessment systems and relative labels are recognized to be a powerful tool to promote the movement of building sector towards a better sustainability. Assessment systems are more and more adopted by public authorities to empower the impact of their policies. Private companies use them to promote green buildings in the real estate market. If from one side the diffusion of all these numerous assessment systems is positive on the other hand this is creating confusion among the private and public stakeholders, citizen included.

The reason for this confusion is due to the fact that all the assessment systems produce results and labels that are not comparable. The assessment systems are different in methods, physical and time boundaries, issues taken into consideration, number of criteria, scoring systems, etc. This lack of conformity brings to labels not comparable **and usually the differences are not understood. Building sector's stakeholders perceive the assessment systems** on the same plane, while they address specific targets: public buildings, lighthouse buildings, passive or active energy buildings, etc. The problem is critical for the lack of a complete and clear communication about the different **labels, that often are promoted trough marketing campaigns that don't clarify** the specificities of each system.

1.1. Why the assessments' results are not comparable?

The lack of comparability is due to several aspects. Starting from the physical boundaries, the building assessment systems evaluate different physical objects. Some take into consideration only the building. Others the building and its outdoor area. Some other take also into consideration the quality of the location. For instance, evaluating the proximity to services or public transportation. Time boundaries, that concern the life cycle phases of the building,

are also different. Many assessment systems take into consideration only the design and the as built phases. Other include the pre-design phase that deals with process aspects (i.e. adoption of an integrated design methodology). Few take in account the construction phase evaluating for instance the impact of the construction site on the surrounding area. Very few consider the in use phase and the end of life of the buildings. Different physical and/or time boundaries make not comparable the performance scores achieved by buildings. But there are other important elements that have to be considered. For instance, the assessment themes. Very few assessment systems include all the dimension of sustainability, limiting the evaluation to the environmental and/ or social aspects. The economic aspects are not included. The number of criteria can strongly vary: from 10 to more than 200. This is due to the different methodological approach between the performance based systems (few criteria) and the prescriptive ones (high number of criteria). The assessment of a performance is usually more complicated than evaluating the respect of a specific prescription. But also in the case of performance based criteria, the calculation is usually based on different standards and regulations with the consequence of not comparable **indicators' values**. Finally, the methodologies differ. The characterization, normalization and aggregation of indicators' values could be based on very different methodological principles. A harmonization process is clearly needed at transnational level in the way to create a common approach to building assessment that would enforce the effectiveness of certification labels.

2. A STRATEGY FOR HARMONIZATION

The solution for the harmonization of building assessment systems can't be their convergence in a unique common system. For two reasons. The first is to respect the "contextualization" principle. Building practices, environmental, social and economic priorities are different in each region and assessment system must reflect them. Sustainability issues don't have the same importance in all regional contexts. For instance, "water consumption" is an issue very important in South Europe. In North Europe it isn't relevant. Consequently, the efforts to reduce the water consumptions of a building should be more awarded in a South European context. In the same time benchmarks (minimum acceptable performances) depend on the building local practice. It is not meaningful to fix a minimum performance value or a best practice at transnational level. For instance, if in a country the use materials from renewable sources is a common practice, this practice can't be the minimum performance requirement in other countries where the use of renewable material is unusual.

In general, assessment systems should provide evaluations and scores that indicate how much a building is better with regards to the regional building practice. Contextualization means also the use of the local standards, regulations and units of measure. If this aspect is respected, the assessment systems will be more accessible to all. The contextualization principle is the main issue concerning for the diffusion of the "international" assessment systems that are not sufficiently flexible to be fully adapted to local contexts. The second reason for the impracticability of a unique assessment system isn't technical. As already pointed out, actually dozens of assessment systems are already available. All these systems are owned and managed by different public or private organizations. It would be impossible to have all of them converging in a unique common certification system.

A possible winning strategy for assessment harmonization is the definition of a transnational core of common indicators (Key Performance Indicators - KPIs) that are relevant in all contexts and regions. To allow the transnational comparability, the KPIs should be calculated using a common metric. A core set of transnational indicators shouldn't provide a rating because, as already mentioned, performance scores are based on local priorities. KPIs have to be expressed only in absolute terms (i.e. kWh/m³, Kg CO₂/m²). In this way it is possible to compare the performance of buildings located in different regions assessed through different assessment systems. The adoption of a transnational core set of KPIs by the existing and future assessment systems would guarantee a minimum common base to compare the results concerning the key sustainability issues. The existing systems to be harmonized would just have to integrate the transnational core of KPIs that will act as a common "harmonising" denominator. There is not the necessity to significantly modify assessment methods and tools.

3. INTERNATIONAL INITIATIVES FOR THE HARMONIZATION OF BUILDING ASSESSMENT SYSTEMS

The possible definition of a core set of transnational KPIs for the harmonization of assessment systems has been explored by several research projects and activities promoted by different international organizations.

In the past period, the Sustainable Building Alliance carried out a study to define a framework of common metrics to assess the environmental performance of buildings based on the European standards developed by the CEN TC 350.

The idea of a common document to compare the performances of buildings assessed with different systems has been proposed by the European project Superbuildings. The project developed the idea of a “building signature”. It consists of a radar profile which summarize the value of 12 quantitative indicators (environmental, social and economic) with the intent to compare them with a regional average. The 12 indicators of the building signature are: energy, water, natural resources, waste, GWP, thermal discomfort, amenities, social comfort, human toxicity, operation, flexibility, eco-toxicity.

In 2011 it was launched the CESBA initiative by a network of European projects in the field of the territorial cooperation (Interreg), involving numerous public and private European organizations from 15 countries. CESBA is a collective European bottom-up initiative that provides knowledge on harmonised built environment assessment. CESBA stands for “**Common European Sustainable Built Assessment**” and its principle for the harmonization of building assessment systems is to establish a transnational core set of KPIs (Key Performance Indicators) based on common metrics that form the transnational CESBA **Passport**. **The CESBA Passport isn't a new assessment systems and it doesn't produce a rating. The objective of the Passport is to allow the transnational comparison in absolute terms (i.e. Kg CO₂/sqm year) of the performance reached by each building to measure the progress toward common objectives (i.e. Global Warming).**

The harmonization principle based on the establishment of a common set of indicators has been adopted and **proposed by the European Commission that in 2014 issued the Communication 445 “Communication from the Commission to the European Parliament, the Council, the European Economic and Social Committee and the Committee of the Regions on resource efficiency opportunities in the building sector”**. **In this document it is stated that “the fact that there is no established comparability between the different schemes also adds to the uncertainty and complexity for businesses”**. **The solution indicated by the European Commission is that “a common framework of core indicators, focusing on the most essential aspects of environmental impacts should nonetheless be established. This will allow comparability and provide consumers and policy makers with easier access to reliable and consistent information”**.

Many positive benefit are identified in the COMM 445 (2014) for the establishment of a common core set of indicators:

- Allow easier communication of information to professional and non-experts;
- Provide reliable and comparable data to be used in decision-making covering the entire life-cycle of buildings;
- Enable the setting of clear objectives and targets, including system boundaries, for building performance, complementing already existing European legislation on buildings;
- Increase awareness of the benefits of sustainable buildings among actors engaged in providing buildings, as well as private and public clients, including users of buildings;
- Facilitate the effective transfer of good practices from one country to another;
- Reduce the cost to assess effectively and communicate the environmental performance of buildings;
- Provide public authorities with access to core indicators and to a critical mass of relevant data on which to base their policy initiatives, including Green Public Procurement;
- Widen the market for sustainable buildings to more countries than current trends indicate and to other buildings sectors such as non-residential buildings and, eventually, to the residential market.

4. THE CESBA PASSPORT PRINCIPLE

The harmonization approach of CESBA is in line with the European Commission intents expressed in the COMM (2014) 445. The particularity of CESBA, with regards to other harmonization initiatives at transnational level, is to **address specifically the public assessment systems. With “public” CESBA intends the systems that are owned and managed by a public authority (country, region, city, agency, etc.) and used primarily to improve the effectiveness of policies on sustainable building. Actually many incentive based policies are using building assessment and rating systems because they allow to define objective and verifiable performance targets. Public assessment systems address both public buildings (social houses, schools, hospitals, etc.) and private (residential buildings, tertiary buildings, shopping centres). They are used in building codes, urban plans, public tenders. What has to drive the harmonization of public assessment systems is to keep their affordability and operability. Public assessment systems are intended for a “mass certification” approach with the objective to reach the 100% of buildings. CESBA defined 9 key principles for the harmonized public assessment systems. They are:**

- The User first!: CESBA focuses on the people who use buildings. The aim is to design, build and operate **the buildings in order to meet the users’ requirements** and needs, providing an improved comfort, and an ecological and economical construction and operation;
- Sustainability: The assessment covers all aspects of sustainability: environmental, economic and social ones;
- Regional contextualization: Building assessment systems must be contextualized with the region where they are applied, in order to reflect the local specific priorities, cultures, habits and construction practices. This means using local units of measure, adopting national/ regional standards and regulations, giving due consideration to the local climate, and accounting for availability of natural resources and cultural aspects of design.
- Comparability: The performance results shall be comparable in absolute terms thanks to the adoption of the core set of criteria;
- Mass oriented: Building rating systems can play a key role in moving the built environment towards a better sustainability. To reach this objective they have to be widely adopted by the different stakeholders of the building sector: architects, designers, public organisations, construction companies, investors, etc. Mass oriented means that the objective of the certification is to reach 100% of constructions;
- Simple to use: A mass-oriented building assessment system has to find a right balance between the simplicity to use and the scientific/ technical value. The assessment must be precise, not simplified, clear and visible. A system requiring complicated calculations or the availability of data that are not easy to find would request too much time and effort (costs) to be widely used. Simplicity helps the dissemination of assessment systems among the stakeholders;
- Open source: Using an open source approach allows CESBA to be appropriate as to its context by paying special consideration to the environmental, ethical, cultural, social, political and economic aspects of the community it is intended for. Consequently, this approach allows for regional adaptations in the guidance system;
- Co-creation: CESBA harmonization is developed by several people and organisations from various European regions, with experts providing input by contributing as Wiki editors. The knowledge base and further areas of content development are discussed and agreed during common and open CESBA sprint workshops;
- Transparency: The public should have access to the performance results especially for public buildings, while keeping in mind privacy rules. The visualisation of the results must be clear and offer guidance for further understanding.

CESBA proposes a core set of 11 common indicators: non-renewable primary energy, primary renewable energy use, CO₂ emissions, indoor air quality, thermal comfort, building life cycle cost, reused/ recycled materials, water consumption, solid waste, user involvement, monitoring/ optimization of operation. This core set of indicators has been produced with a co-creative approach through a workshop with more of 100 participants from 11 countries (CESBA Sprint Workshop, Voralberg, September 2013). The bottom – up approach is a characteristic of the CESBA initiatives. Individuals with different backgrounds (engineers, architects, policy makers, SME, etc.) meet and find a shared common position.

The KPIs metrics are actually under test in the context of ongoing European projects (CESBA Alps – Interreg Alpine Space, CESBA MED – Interreg Mediterranean). A first group of 6 assessment systems used by public authorities are collaborating for the implementation of the CESBA Building Passport. In particular the Italian national system Protocollo ITACA, the French BDM, the Austrian KGA, the Czech SBTool CZ, the Portuguese SBTool PT and the Spanish VERDE. The CESBA Building Passport will be operative by 2018. The CESBA Passport system will be managed by the no profit CESBA Network Association, located in Voralberg (Austria).

REFERENCES

- [1] 2010 | A Framework For Common Metrics Of Buildings. Retrieved from: <http://www.sballiance.org/our-work/publications/>
- [2] CESBA GUIDE. Retrieved from: http://www.central2013.eu/fileadmin/user_upload/Downloads/outputlib/CEC5_CESBA-Guide2014_uploaded.pdf
- [3] Sustainability and performance assessment and benchmarking of buildings-Final Report. Retrieved from: <http://www.vtt.fi/inf/pdf/technology/2012/T72.pdf>

Generating and Providing Embodied Energy and Global Warming Potential Related Information: Recommendations for Construction Product Manufacturers

Alexander PASSER^a, Maria BALOUKTSI^b, Thomas LÜTZKENDORF^c, Angelika HINTERBRANDNER^d, Helmut KREINER^e

^a Graz University of Technology, Austria, alexander.passer@tugraz.at

^b Karlsruhe Institute of Technology, Germany, maria.balouksi@kit.edu

^c Karlsruhe Institute of Technology, Germany, thomas.luetzkendorf@kit.edu

^d Graz University of Technology, Austria, angelika@ahinterbrandner.com

^e Graz University of Technology, Austria, helmuth.kreiner@tugraz.at

ABSTRACT

The growing awareness for sustainable construction increases the demand for low environmental impact products among others. This poses new challenges to construction product manufacturers (CPM) not only in terms of developing such products, but also in terms of providing detailed and reliable product information to designers and procurers, as well as manufacturers of more complex products, including information on the use of resources and resulting effects on the global environment, the service life, as well as their behavior when it comes to maintenance, deconstruction and recycling.

Often, meeting the information demands from designers and procurers means to provide information on: the energy consumption and greenhouse gas emissions related to the production process of the product including both upstream and corporate processes; the energy consumption for the installation and dismantling processes; the service life and maintenance possibilities/needs, and take-back and recycling possibilities. The collection and publication of such information becomes a competitive factor for enterprises and enhances their overall image. Additionally, the optimization of the manufacturing processes and the commitment to sustainability becomes an area of interest for CPMs. The saving or substitution of primary energy sources and primary raw materials lead to benefits such as reduced costs and positive sustainability reports.

However, small and medium-sized manufacturing enterprises (SMEs) often shy away from the effort associated with these tasks. They are not always familiar with scientific principles and normative requirements. It is necessary to support them with knowledge and resources and advise them on the compilation of product information. This paper addresses essential results of IEA EBC Annex57 and specific recommendations, accompanied by supporting information. Additionally, within the paper recommendations are given to improve their production and procurement processes as well as related environmental product information, seeking to improve their overall market competitiveness.

Keywords: small and medium-sized enterprise, environmental product declaration, supply chain

1. INTRODUCTION

Nowadays, the growing adoption and implementation of sustainable practices in the construction sector increases the demand for environmentally responsible and healthy construction products on the market. Building clients/developers and procurers are increasingly integrating specific requirements for sustainability already in the **client's brief, and later on in the tender documentation, as an addition to the requirements** for technical, functional or design quality of construction works. This places a certain responsibility on the designers, build contractors and vendors to choose construction products that comply with these requirements. In this regard, products making a significant contribution to the conservation of resources and the reduction of adverse effects on the environment are preferred by building stakeholders wanting to make a statement that they are not concerned solely about how the product performs in their building, but also about its environmental impacts.

Within the framework of a sustainability assessment a Life Cycle Assessment(LCA) of the building is increasingly required. LCA data on construction products provide the basis for this, and thus a need for such information is evident. Considering also the European Construction Products Regulation (CPR) that includes the sustainable use

of natural resources, particularly in relation to recyclability, durability and environmental compatibility as a basic requirement for construction products, further consequences for construction products and the declaration of their performance are already on the way.

This poses new challenges to construction product manufacturers (CPMs) not only in terms of developing such products, but also in terms of providing objective, unbiased and transparent environmental information on their products to other stakeholders along the supply chain. Meeting these information demands often means to cover every stage of a product – from how it is manufactured, to its installation and use in the building, to what happens to the product when its end-of-life is reached. Manufacturers who collect and publish such information demonstrate their own commitment to reporting and continuous improvement, providing a basis for communication with other stakeholders – this leads to an increased credibility, differentiates the enterprise from the competition and enhances its overall image.

There are already existing standards, such as ISO 21930 and EN 15804 providing rules for the generation and presentation of construction product-related environmental data in a harmonized way. These can be used for the purposes of assessing embodied energy and global warming potential as part of the total environmental related information (i.e. embodied impacts) of a construction product. The derived information on construction product can then be used as a source of information for the overall assessment which can only be performed on the building level (EN 15978), taking into account the functional and technical performance respectively.

However, due to their lack of resources and limited access to information, small and medium-sized manufacturing enterprises (SMEs) often shy away from the effort associated with these tasks. It is necessary to support them with knowledge and resources to overcome the lack of know-how and advise them on the compilation of product information. This paper addresses essential results of the international project IEA EBC Annex57 and specific recommendations, accompanied by supporting information, specifically to be used by SMEs of construction product manufacturers. Additionally, within the paper recommendations are given to improve their production and procurement processes as well as related environmental product information, seeking to improve their overall market competitiveness.

2. THE PLACE OF SMEs IN THE SUPPLY CHAIN

SMEs have particular characteristics that can present challenges due to the presence of fewer technical and financial resources for gathering data across different parts of the business operations and the overall adoption of a strategy for the measurement and monitoring of the embodied impacts of their products. Construction product manufacturers, in their attempt to showing good ethics along with taking responsibility for environment and society, can unlock their potential of influencing the embodied energy and global warming potential of their products through, for example:

- The choice of specific primary raw materials, energy sources and technologies for the manufacturing process.
- Advancing the technical characteristics of their products in terms of durability, maintainability and serviceability, as well as ease of dismantling, reuse and recyclability.
- Expanding their operations on the product lifecycle through the provision of life cycle support services (e.g. **maintenance contracts) and take back programs at the end of the product's service/ useful life.**
- Technically advising and supporting clients and architects on how to better install and use their products (Maintenance instructions)

Therefore, the provision of “better” products in combination with the publication and active handover of credible environmental product information supplementing the information on the technical characteristics of the product, and the transition to life cycle support services, can improve the competitive position of SMEs.

The group of construction product manufacturers is diverse – from single parts/material manufacturers (dealing **with the mining and materials manufacturing) to “end-use” product manufacturers. In this regard, operations and structures can vary significantly between manufacturing SMEs. In order for an enterprise to assess the embodied impacts across its operations, it must initially identify the boundaries it will work within and the processes over which it has an influence over.**

The manufacturers' main responsibility is to describe their own/ corporate processes (e.g. fuel and material use, as well as pollution, due to the manufacturing equipment and processes) as clearly, completely, and accurately as possible. Over these processes the manufacturer has a direct influence, thus, calculating the on-site impacts of product manufacturing, the so-called gate to gate impacts (A3 in Figure 1), can be the starting point in the quantification and assessment of the product's embodied impacts. This information can enable the identification of key "hot spots" of embodied impacts in the production process and the potential for product or energy source substitution. Every activity carried out before the manufacturing process in the supply chain belongs to the upstream processes. Although a manufacturing enterprise has no means of direct influence over these processes, it can still place pressure backward in the supply chain by asking lower-impact materials and/ or energy sources inputs to make the product (A1-2 in Figure 1), as well as related credentials for every supplier it cooperates, through its procurement processes.

After looking on site and upstream, it is time for the manufacturer to look downstream (A4-C4 in Figure 1), at the processes occurring once the product leaves the factory. Downstream life cycle stages include the transport and construction process, the use stage and end-of-life management. Manufacturers have no direct influence over the life cycle of their products after their delivery. What they can do is to provide information on what are the impacts of their products under specific conditions of use (based on different scenarios). For example, this includes information on the energy consumption for the installation and dismantling processes, information on the service life and maintenance possibilities/ needs and information on take-back and recycling possibilities. The consideration of the downstream processes depends greatly on the type of the product – for instance, in cases the product is used as an input to another product and is not a ready-to-install product in the building (e.g. cement), describing the post-gate life cycle stages does not make sense.

In case the enterprise has an established a take-back system itself, it might also have a direct influence over the recycling processes. A manufacturing company, by taking increasing responsibility for the end-of-life management of its products and designing them in such a way to be reused or recycled inside the facilities, reduces the need for new materials in production and creates a tight "inner circle" allowing the use of less material, labour, energy, and capital. In this way, a contribution to the shift toward a circular economy can be made.

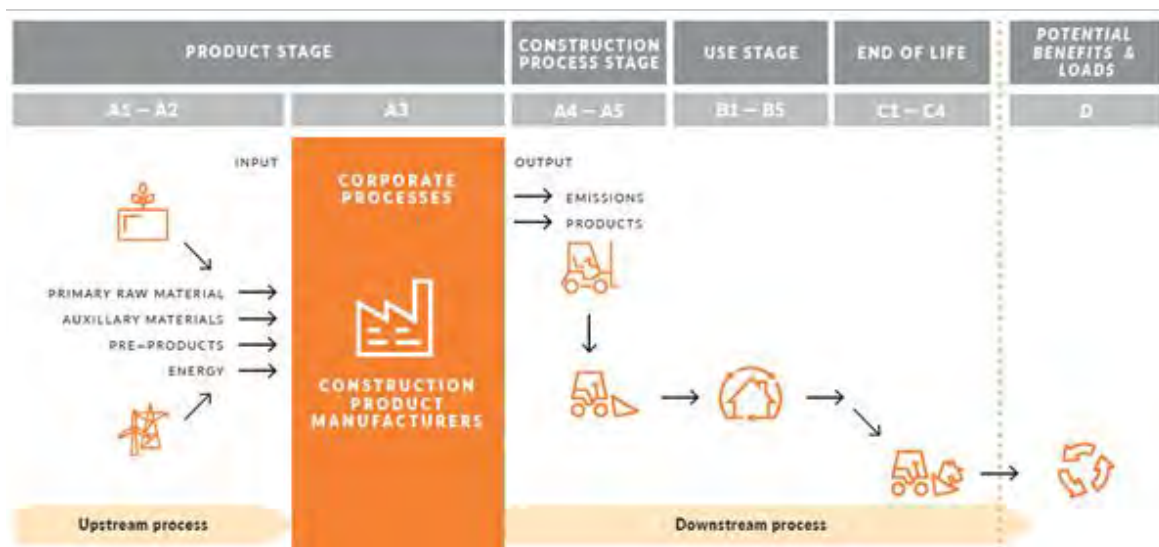

Figure 1: Data collection and provision in the supply chain of a construction product. the description of the product-related life cycle information (A1-C4 & D) is based on EN 15804

3. APPLICATION POSSIBILITIES

To create more benefits for CPMs as well as stakeholder over the life cycle of a building, primary goals must be set and assigned to each life cycle phase. Methods and steps of action regarding embodied impacts must be chosen accordingly. An example for better understanding of this specific course of action: In the life cycle phases A1 – A3, with the main target of reduction of embodied impacts, multi criteria decision making (MCDM) – e.g. pictured as “A” in Figure 2 - can support decision making regarding raw material or transport options, integrated process optimization in manufacturing, etc. Further steps of action for each life cycle phase are illustrated Figure 2.

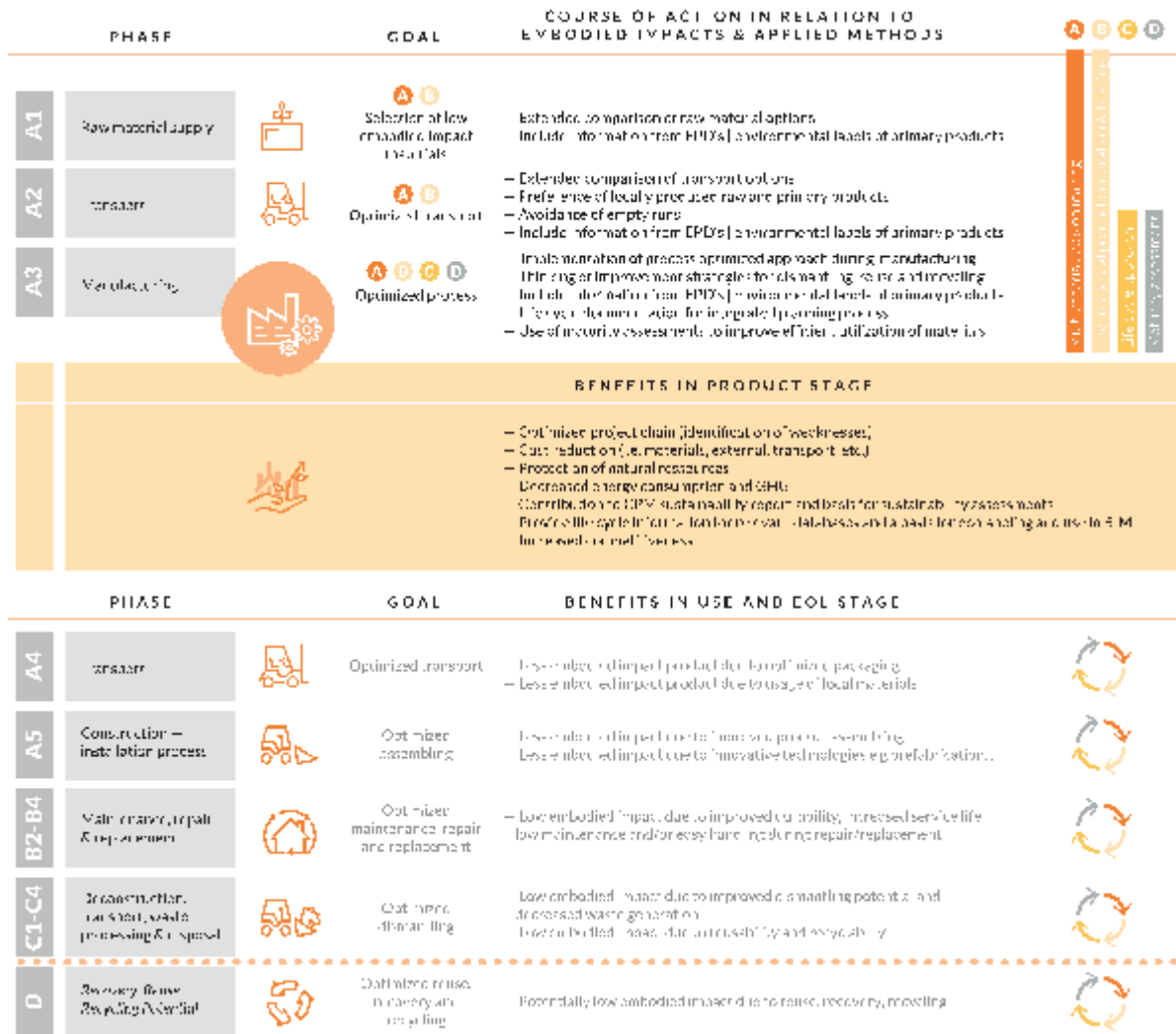

Figure 2: Course of action and benefits in relation to embodied impacts

Optimisation of the processes within the enterprise: Can be especially beneficial in case competing with other enterprises. Conducting a life cycle assessment of its product can help a manufacturing enterprise to identify problematic areas of, and therefore potential improvement strategies for, the production processes and opportunities for product-related optimization for a transition towards a highly competitive product. In this sense, better choices regarding raw materials, energy supply sources and technology sources can be made based on an embodied energy analysis.

Contribution to lower costs through energy conservation and substitution: As the use of fewer energy resources and the generation of less environmental pollution result, for the most part, in an improved financial performance. The enterprise pays less for inputs, as well as for waste and pollution management.

In-house comparison of location/ sites: Is especially important for enterprises operating in more than one location. Comparing the different manufacturing technologies used in the different locations and identifying which locations are associated with the higher embodied impacts make it easier to identify hotspots.

Benchmarking for the energy intensity of production (industry comparison): Is important to identify and recognize less energy intensive production processes and the emerging low impact products. Manufacturers should actively engage in reducing their **product's carbon**-equivalent footprint and work with industry associations to develop EPDs for their product category. In addition, it is recommended to engage with these associations to provide transparent LCA data that can be used as an example and benchmark for their products. Once benchmarks have been established, a link to these benchmarks can be made.

Contribution to the enterprise's sustainability reporting: By indicating reductions in energy consumption and environmental impacts of the manufacturing or corporate processes. Sustainability reporting can therefore be improved and influences further the image and value of the enterprise. Furthermore, product responsibility can be better demonstrated when offering take-back-guarantees and publishing appropriate product-related information.

Compilation of information for Business-to-Business (B2B) or for Business-to-Consumer (B2C) communication: At present, purchasers expect from the product provider to include information on the impacts their products have on the environment and health, including embodied impacts — related information. Only with this given information they are able to calculate the cumulative embodied impacts over the whole life cycle. Additionally, end customers are increasingly interested in access to information on environmental information to make a better purchase decision directly at the hardware store.

Applications for Ecolabels and EPD's: Are useful tools both for communicating product information and marketing purposes. EPDs are also useful in terms of providing leverage during negotiations with primary product suppliers in the course of a process and product optimisation. Some label awarding organisations for environmental labels require the presence of information on embodied impacts in addition to other environment and health related information. The results of an embodied impacts assessment can be an input to the EPDs.

Provision of data for databases: In a simple and understandable way to make it easier for clients and users to compare different products and their specifications. Overall, it is important for manufacturers to effectively communicate embodied impact information associated with the production, installation, use and disposal or recycling of construction products to the interested stakeholders (e.g. clients, designers, purchasers, etc.) along the building supply chain. The resulting data provided by the construction product manufacturer can be made available for example in databases for design professionals and consultants and/or LCA specialists.

The application of the previously described measures additionally contributes to "green" supply chain management. Improvements may occur in term of product, information, cost or service. In this case, the latter is associated with benefits in maintenance and deconstruction services or information offered regarding these processes.

4. RECOMMENDATIONS

Data collection is one of the key challenges (and sometimes a barrier) to completing an assessment of embodied energy and global warming potential, especially when data is needed down the supply chain. Data used for product assessments can be divided into two main categories:

- Internally collected data (data generated/ collected within the enterprise); usually physical data directly attributable to the specific product, and
- **Third party data (obtained either directly from the suppliers'/ service providers or indirectly from other third party sources)** including energy and emission coefficients to be used in calculations to determine embodied energy or GHG emissions per functional unit

However, how to improve the collection processes of external/third party data? SMEs are in a position to determine the amount of energy as well as the type and quantity of primary and auxiliary products used for their own processes. They are also in a position to estimate the cost of internal transport as well as the transport modes and distances for the delivery of primary and auxiliary products. This information must be combined with primary energy

and emission coefficients acquired from external sources. This includes information about processes, over which the manufacturers have no direct influence.

There are different types of data sources, from where such coefficients can be sourced. The most important source of information is the material/ product suppliers and service providers themselves. What they usually offer is either the results of specific LCAs or product/ process-specific environmental product declarations (EPD's). Care must be taken to ensure that this information includes all the related upstream processes and are based on a uniform system. It is recommended for SMEs to contractually regulate the nature and extent of the supply of information from all the material suppliers and energy service providers. **There are cases, however, in which suppliers'/ service providers do not have specific LCAs/ EPD's for their products/ services but instead they offer the average data of their industry association (sector or generic EPD) as an alternative solution.** It is recommended, if such average data are sourced, to be listed separately. In case primary energy and emission coefficients cannot be directly obtained from the suppliers or service providers, these should be sourced from good quality databases. If existent, national LCA databases should be preferred, since they are usually freely accessible and subject to a quality control.

Besides collecting the appropriate data for performing an embodied impacts assessment, it is also important to effectively communicate the results to other stakeholders. Promoting high levels of transparency and interpretation can increase confidence in results. This can help an SME to enhance profits and reputation, and therefore ensure a good return on investment on the assessment itself. For example, for increasing credibility, a manufacturer may choose to comply with certain standards (e.g. EN 15804) and thus comply with certain reporting requirements and **communication templates. EPD's are one possibility (Type III declarations).** Within the EPD context in its current form, the manufacturer is requested to describe one or two typical scenarios for each downstream information module (A4-C4 & D, Figure 1). However, to respond to a possible future development of EPDs and to support in a **better way the designers and other stakeholders, the provision of different "case-based information packages" for each information module will be a necessity.** This will allow the users of the information (e.g. designers) to select which information package is more relevant to their building case/ scenario.

5. CONCLUSION AND OUTLOOK

Nowadays, construction product manufacturers are being increasingly asked to provide information on the environmental and health-related impacts of their products in a transparent and accountable way. This enables consumers to make informed decisions about the products they purchase. This demand has been driven both by an increased presence of green or sustainable public procurement in many countries and the growing reliance of building sustainability assessment and certification systems on comprehensive and detailed information on the construction products installed into the building. Considering also that within the framework of a sustainability assessment it is increasingly required to perform a full LCA for the building under investigation, and that LCA data on construction products provide the basis for this, a need for such information is evident.

For manufacturers who already work their way into these complex issues, the engagement with issues related to embodied impacts is a perfect start. However, due to their lack of resources and limited access to information, small and medium-sized manufacturing enterprises (SMEs) often shy away from the effort associated with these tasks. Therefore, it is necessary to help them overcome the lack of know-how and advise them on the compilation of product information. The paper has provided specific recommendations in this direction, specifically to be used by SMEs of construction product manufacturers seeking to improve the confidence in their dissemination results and their market competitiveness.

The authors recommend that information on the environmental performance of construction products should always be combined with technical information on how to better install and use them (instructions for installation, maintenance, reinstallation, etc.) as an additional support/service to the clients. At the same time, it becomes important for construction product manufacturers to think about expanding their operations on the product lifecycle **through the adoption of take back strategies at the end of the product's service/useful life as a way to contribute to the shift towards circular economy.** Therefore, the provision of "better" products in terms of their environmental performance, in combination with the publication and active handover of credible environmental product information supplemented with "enhanced" technical information on the installation and maintenance of the product, as well as the transition to life cycle support services, can significantly improve the competitive position of SMEs.

REFERENCES

- [1] CEN, 2012. EN 15978 Sustainability of construction works - Assessment of environmental performance of buildings - Calculation method.
- [2] CEN, 2014. ÖNORM EN 15804 Sustainability of construction works. - Environmental product declaration. - Core rules for the product category of construction products, Vienna.
- [3] CPM-Guideline of IEA EBC Annex 57, 2016. Guidance to support construction products manufacturers in their decision-making process; <http://www.annex57.org>
- [4] EC Circular Economy Strategy; http://ec.europa.eu/environment/circular-economy/index_en.htm
- [5] EC, 2011. REGULATION (EU) No 305/2011 OF THE EUROPEAN PARLIAMENT AND OF THE COUNCIL of 9 March 2011 laying down harmonized conditions for the marketing of construction products (CPR).
- [6] ISO, 2007. ISO 21930 - Sustainability in building construction — Environmental declaration of building products.

Discussing Sustainability in Building Construction: The Potential of SBTool for Brazilian Public Bidding in Fiocruz

Marcia Castilho CORREIA^a, Monica Santos SALGADO^b, Luis BRAGANÇA^c

^a Oswaldo Cruz Foundation FIOCRUZ; Federal University of Rio de Janeiro, marcia.correia@fiocruz.br

^b Federal University of Rio de Janeiro, Brazil, monicassalgado@ufrj.br

^c Universidade do Minho, Portugal, braganca@civil.uminho.pt

ABSTRACT

The discussion about the difficulties related to the integration of environmental sustainability requirements in Brazilian public buildings, leads to the analysis of the limits imposed by the laws related to the bidding process. In 1993 Brazil legislation established the 37th article of Brazilian Federal Constitution by means of the signature of federal law number 8666 enforcing general rules on administrative contracts for design projects (design, projects, constructions and engineering services). All institutions of public administration must obey this regulation. In 2010, the law received an amendment obliging all contracts to observe sustainability requirements. In 2014 the certification by PROCEL Edifica, Brazilian energy efficiency method for buildings, became compulsory by means of Normative Instruction number 2 from Management, Planning and Public Budget Brazilian Ministry (MPOG/Brazil). In this sense, some difficulties have been observed, particularly in how to choose which sustainability rating system should be adopted to complement PROCEL Edifica. SBTool (Sustainable Building Tool) assessment (proposed by iSBE - International Initiative for a Sustainable Built Environment) is freely available and, for this reason, could be easily integrated on government biddings. Thus, this research deals with the analysis of the potential in adopting **SBTool tool in Brazil's public biddings in order to lead development assessment of projects with high environmental quality**. Results indicate some challenges that must be dealt with, in order to customize SBTool method to Brazilian urban needs and environmental characteristics all over the country.

Keywords: sustainable public buildings, sustainable rating system, green procurement

1. INTRODUCTION

On 4th August 1987, The United Nation's Report of the World Commission on Environment and Development (WCED), has published an important document known as Our Common Future, bringing the concept of sustainable development, and the necessity to ensure that the needs of the present should not compromise future generations (UN, 1987). Eleven years later, in 1998, The Kyoto Protocol treaty was signed in Kyoto, Japan, committing State Parties to reduce greenhouse gas emissions. It entered into force only on 16th February 2005.

The path to sustainability has not been regular nor straightforward, it forms a complex net. In order to reflect reality, the sustainability assessment must consider the whole building life cycle (pre-use phase, use phase and post-use phase). Kibert states that products, systems, techniques and services needed to create buildings in harmony and synergy with nature are rare. It is important to note that Kibert is a researcher from the United States, country that has access to better data bases for US than the ones that exist for Brazil, where still the needed construction materials database to implement the use of Life-Cycle Assessment methodologies do not exist. In this sense, Kibert wrote:

“Buildings are often assembled from components manufactured by a variety of manufacturers that have paid little attention to the environmental impacts of their activities.”

This reality is true for many other countries and is the great challenge for implementing LCA, an important sustainability item. Even now the sustainability concept has not already been completely understood by all stakeholders in building construction sector. The simple use of sustainable materials or systems is not a guarantee of effective good results during the use phase. But it is undeniable the role of building environmental rating systems as a guide.

It is generally accepted the current era of rating tools commenced on 1990, with BREEAM (UK) rating tool, followed by the French System HQE in 1996 and the US LEEDTM in 2000. Further analysis confirms that the evolution of rating systems into different countries is largely based on those initial methods. Although the discussion about

sustainable construction has started around 30 years ago, only in 2010 Brazilian government determined sustainability to be compulsory. Launched in 2003, the PROCEL Edifica Certification has been attracting the attention to energy efficiency issues applied to buildings, but has reached timid results. Although being compulsory for public buildings since September 2014 by means of Normative Instruction number 2 from Management, Planning and Public Budget Brazilian Ministry [6], public administrators have to face many difficulties because the country still lacks regulations to allow punishment in case both determinations (law 8666/1993 and IN 2/2014) are not complied.

This paper intends to bring the debate to public project management for the production of sustainable buildings. By force of law these contracts require technical evaluation of design, with the use of clear and objective criteria, with no interference of subjectivity or biased assessment. This goes beyond the quality of the design and yet includes environmental sustainability assessment.

Thus, this research presents the results of an initial analysis considering the potential of SBTool (Sustainable Building Tool) in public biddings in order to guarantee the assessment of sustainable buildings design. Developed in an international collaborative process, SBTool is a generic framework for rating sustainable performance of existing buildings and building designs. It may also be thought of as a toolkit that assists local organizations to develop local SBTool rating systems.

The results indicate the complexity of sustainability in construction, which needs the participation of architects, engineers, owners, users, suppliers and all stakeholders involved on civil construction industry.

2. SUSTAINABILITY IN PUBLIC BIDDING

In 1993, Brazil implemented into practice the 37th article of Brazilian Federal Constitution by means of the signature of Federal Law N° 8666, enforcing general rules on administrative contracts for design projects (construction and engineering services). It seeks the best proposal for the Public Administration, usually by choosing the lowest price but also can be by lowest price together with best technique. All government levels must obey this regulation in a very complex procedure. In 2010 this law received an amendment obliging all contracts to observe national sustainable aspects referred to building construction.

From the implementation of this law a complex series of laws that regulates public biddings was put into force. The newest law [9] has focus on bidding procedures and contracts awarded by public enterprises and joint stock companies, designed to ensure the selection of the most advantageous offer, including regards to the life cycle of the building. Bids and contracts ruled by this law, among others, must respect the following:

- Adequate final disposal for solid waste generated by the contracted works;
- Mitigation of environmental damage through constraining measures and environmental compensation (to be defined in the licensing procedure);
- Use of products, equipment and services that are proven to reduce the consumption of energy and natural resources;
- Assessment of neighbourhood impacts, according to the town planning legislation;
- Protection of cultural, historical, archaeological and immaterial heritage, demonstrating an evolution process towards sustainability.

The laws require the exclusive use of objective criteria, previously determined by the public announcement (called "Edital"). **These same criteria will lead the contract management itself.**

3. ENSURING SUSTAINABILITY OF BUILDINGS WITH SBTOOL

SBTool is freely available to the public and, for this reason, can be easily adapted and integrated in public procurement bidding processes.

The SBTool is provided by iiSBE and has a generic structure which needs to be adapted to local conditions, calibrating parameters with proper definition of weights and benchmarks. It is worth emphasizing that this generic tool does not certificate, since the local iiSBE Chapters may determine whether there will be a certification system, or not. According to Larsson, the tool consists of two assessment modules that are connected to the building's life cycle. The first module refers to the building pre-design phase and the second to the building evaluation. The first brings local data and the second module contains building data as the project phases, construction and operation (use). Each module is divided into two Excel files, **respectively named files "A" and "B" which work linked to one another.**

The file "A" refers to an appropriate generic structure for a particular country or region set by the head of the regional organization in order to reflect important local issues. In this file the weight of parameters and benchmarks for the type of occupation are established and also information such as latitude, longitude, annual rainfall volume, population estimates, among others.

The "A" file is also configured for its particular type of occupation. It may have mixed uses, but limited to a maximum of three types, creating "A" files, e.g. for residential, commercial buildings, different urban areas etc.

In turn, the "B" file contains specific information for a particular project filled in by the project designer or by a professional qualified by iiSBE. However, before being released to the designers, the local representative must check whether the "A" and "B" files are linked and leave visible only the relevant information in order to prevent possible confusion during filling the "B" file. There can be several "B" files derived from a single "A" file, since they have the same type of occupation, and "B" file settings are automatically determined by the adjustment made in "A" file.

SBTool provides a list of criteria, divided in the four phases of the life cycle and 8 categories aiming to cover the three dimensions that define sustainability – environmental, social, and economic aspects. The number of criteria of each category varies according to the type of scope to be used: maximum scope, medium or low. The maximum covers all sustainability issues proposed by the tool, the minimum corresponds only to the essential evaluation criteria, while the medium is a balance between the previous two. Thus, a building can be evaluated in only 3 or 107 criteria, depending on the type of scope and phase of the life cycle. iiSBE recommends for starters the use of the minimum scope to reduce complexity of evaluations.

Projects are evaluated according to the four phases of the building lifecycle - pre-design, design, construction and operation - and the weighting system is adjusted according to the local characteristics.

4. CHALLENGES AND OPPORTUNITIES IN THE USE OF SBTOOL

SBTool is a flexible tool and adaptable to the particularities of different locations in different territories, which is one of the great advantages towards commercial certifications. But SBTool itself does not certificate but by partnership certifications can be granted as done in countries as Italy (Protocollo ITACA), Spain (Verde), Portugal (SBTool PT), and Czech Republic (SBTool CZ). In Brazil, a local adaptation was done for commercial buildings in Espírito Santo state (ASUS), but it does not certificate.

Unfortunately, if a certification system is implemented, SBTool will not be free anymore, losing one of its best characteristics. Moreover, from a common methodology (SB Method) it creates multiple versions of a single tool for different regions and different building uses. SBTool can integrate assessment of PROCEL Edifica requirements and fulfil these legal requirements in one single tool.

The biggest challenge is to accomplish economic performance and the need of an accurate local database. Besides, as buildings have a long life cycle, the use period has great importance and impact. The users are important stakeholders in these analyses.

Types of Brazilian public procurement	Characteristic of the mode	Potential for adoption of SBTool
Invitation/“ <i>Carta convite</i> ” Public competition/ “ <i>Concorrência</i> ”	This bidding mode selects the company that will develop the design project.	Can be adopted but must be previously determined in the procurement announcement / “ <i>Edital</i> ”. Creating a local benchmark is a difficulty.
Live reverse auction/ “ <i>Pregão presencial</i> ”		The use of SBTool on this modality must be made during the contract supervising phase, after the bidding itself., that is during design phase.
Virtual reverse auction/ “ <i>Pregão eletrônico</i> ”		
Design competition/ “ <i>Concurso</i> ”	This bidding mode selects the design project.	Can be adopted but must be previously determined in the procurement announcement / “ <i>Edital</i> ” The use of SBTool on this modality must be made during the selection phase, the bidding itself. It could help in the classification of competing projects and could also guide detailing options after the selection has been made.
Differentiated regime of hiring/ <i>Regime Diferenciado de Contratação – RDC</i>	This bidding mode selects the company that will develop the design project or, in the integrated sub-mode design-build, the one that will both develop and build.	Can be adopted but must be previously determined in the procurement announcement/ “ <i>Edital</i> ”. Creating a local benchmark is a difficulty. The use of SBTool on this modality must be made during the contract supervising phase, after the bidding itself., that is during design phase ..
Public companies, Joint stock companies and its Subsidiaries’ law	This bidding mode selects the company that will develop the design project or, in the integrated sub-mode design-build, the one that will both develop and build.	Can be adopted but must be previously determined in the procurement announcement/ “ <i>Edital</i> ”. Creating a local benchmark is a difficulty. The use of SBTool on this modality must be made during the contract supervising phase, after the bidding itself., that is during design phase.

Table 1: Brazilian public bidding modes and the potential adoption of SBTool

As shown in Table 1, except for the mode Design Competition, which selects the design project, all the other bidding modes aim to select the company that will develop the design project. In this sense, the bidding process **must assess the companies’ technical**-operational and technical-professional capacities, besides their economic, financial qualification and insurance guarantee. That means that, in the majority of cases, the assessment of projects with environmental quality will only be needed in the contract phase, after the procurement process is over.

It must be noted that each country has their own specific legal framework and this paper aims to present the Brazilian legal framework and not to compare Brazilian laws to the ones of any other country. In this sense this paper does not intend to present any parallel to any other country legal framework.

The method allows analyzing a building in its four life cycle phases. In addition, it considers all dimensions defining the sustainability and thus allow a more thoroughly check of the building. The generic SBTool is free, which is a relevant aspect to public bodies and use as reference the best regional construction practice (benchmark) and the impact of local materials in the evaluation process. In this way, it provides an opportunity for continuous improvement.

The first attempt to use SBTool in Brazilian buildings has emerged from a research developed on Federal University of Espírito Santo, that has proposed a similar environmental rating system called ASUS. According to Souza the ASUS method is based on the structure, the evaluation criteria and the grading scale of SBTool. However, the proposed adaptation is restricted to the use of use-operation and maintenance phase of buildings, enabling performance measurement in existing constructions, instead of relying only on simulations. This more restricted

version was proposed because, according to the author, the level of coverage and information required by SBTool tool extrapolates the availability of consolidated data in the country, which would make it very sophisticated to be absorbed by the Brazilian civil construction market.

SBTool has a difficult and complex structure that is hampered by the Excel program, since the user needs to fully understand the program in order not to make mistakes that can change the whole assessment system. In addition, file B needs to be synchronized with file A in order to update the information to file B and to allow the system to work properly. Creating a SBTool local benchmark would be difficult. Another barrier to be considered is the flexibility and the continuous evolution and updating of the generic SBTool method, which may cause differences between the local and the generic tools and may confuse users and companies and create problems. The evaluation through SBTool method requires the use of other tools and methods, such as the assessment of the energy performance of the building or the user satisfaction indicators.

When the procurement announcement is not clear and objective the procurement process itself can be contested by the interested companies or the contracted company. Or, at best, the supervision of future contract will have to deal with the gaps during the contract. These situations have been experienced in bidding and contract supervision by the authors. In a certain way, the most used public bidding modes postpone the results of most problems in the procurement announcements to the contract supervision phase. Design competition is the exception.

5. CONCLUSION

This research deals with the preliminary analysis of the potential adoption of SBTool tool in biddings in order to lead development assessment of sustainable building design. Positive results, as shown, already indicate the **potential of SBTool on Brazilian's public procurement process as long as it has been considered** since the beginning of design process (pre-design phase) establishing the assessment parameters from the very beginning of the process.

SBTool is a very objective tool, with clear parameters, meeting the needed requirements to guide the development of design projects by contractors and carry out the evaluation of the design projects by the contractor, within the same parameters. But it is a rather complex tool and a more accessible interface would be beneficial.

The present stage of this research shows that SBTool can be applied in all modes of Brazilian procurement, during the procurement phase (in case of its adoption in the competition mode) and during contract phase in other modes. However, it is necessary to consider that the level of coverage and information required by SBTool extrapolates the availability of consolidated data in the country, which will make it very sophisticated and difficult to be absorbed by the Brazilian public buildings.

Despite the challenges, the positive points outweigh the negatives, which, with effort and preparation, can be overcome.

Nevertheless, early measuring the environmental performance and impact of construction along the buildings life cycle, since the pre-design and design phases is absolutely needed. However, LCA data, economic performance and continuous improvement still need to be implemented in order to improve sustainable construction in Brazil.

Finally, it is important to emphasise that, in order to develop a real sustainability assessment local tool that can really help architects and engineers to integrate PROCEL Edifica and economic aspects of sustainable construction in their decisions and design solutions, it is necessary to promote and improve further the research activity in this field of knowledge.

ACKNOWLEDGEMENT

The authors acknowledge financial support from Fiocruz and CNPq.

REFERENCES

- [1] **Aulicino, P. 2008. "Análise de métodos de avaliação de sustentabilidade do ambiente construído: o caso dos conjuntos habitacionais." (MSc). Escola Politécnica, Universidade de São Paulo. São Paulo.**
- [2] Brasil. 2014. Normative Instruction IN 2/2014 from Management, Planning and Public Budget Brazilian Ministry (MPOG/Brazil). June 4, 2014.
- [3] Brasil. Federal Law N.º 8666 June 21, 1993. :
- [4] Brasil. Federal Law N.º 13.303. June 30, 2016. Legal statute of public companies, joint stock companies and its subsidiaries. <http://www.planalto.gov.br/CCIVIL_03/ Ato2015-2018/2016/Lei/L13303.htm.>
- [5] Brasil. Manual para etiquetagem de edificações públicas. Gestor público Eletrobras / Procel. [online] Retrieved from: <<http://www.pbeedifica.com.br/etiquetagem/publica>>
- [6] Campelo, V & Cavalcante, R.J. 2014. Obras Públicas: Comentários à Jurisprudência do TCU. Editora Fórum, Belo Horizonte.
- [7] **Correia, M and Salgado, M and Bragança, L. 2016 "The use of SBTool on public procurement: challenges and opportunities." Paper presented at SBE 2016, Vitória, Brazil 7-9 September 2016.**
- [8] iiSBE 2016 - INTERNATIONAL INICIATIVE FOR A SUSTAINABLE BUILT ENVIRONMENT. SB Method and SBTool. Available online: <http://www.iisbe.org/sbmethod>, Last accessed: May 2016.
- [9] Kibert, C.J. 2008. Sustainable Construction- Green Building Design and Delivery. 2nd Edition. 411p
- [10] Larsson, N. 2012a. Part A, User Guide to the SBTool 2012 assessment framework. Available online: <http://www.iisbe.org/node/140>.
- [11] Larsson, N. 2012b. Part B, User Guide to the SBTool 2012 assessment framework. Available online: <http://www.iisbe.org/node/140>.
- [12] **Reed, R. et al. 2009. "International Comparison of Sustainable Rating Tools." Journal of Sustainable Real State, v. 1. n. 1, 2009. Available at: <http://www.costar.com/josre/JournalPdfs/01-Sustainable-Rating-Tools.pdf>**
- [13] SOUZA, A. D. S. Ferramenta ASUS: proposta preliminar para avaliação da sustentabilidade de edifícios brasileiros a partir da base conceitual da SBTool (MSc), UFES (Available in <<http://lpp.ufes.br/sites/lpp.ufes.br/files/field/anexo/cp084783.pdf>> Last accessed on August, 2016)
- [14] UN United Nations. 1987. World Commission on Environment and Development Report - WCED Report - Our Common Future.. [online] Retrieved from: < <http://www.un-documents.net/wced-ocf.htm>>
- [15] UN United Nations. 1998. Kyoto Protocol to the United Nations Framework Convention on Climate Change.. [online] Retrieved from:: <<http://www.kyotoprotocol.com/resource/kpeng.pdf>>

Assessment Tools for The Sustainability Performance of Building - Development of A Sustainability Assessment Method for Small Residential Buildings in Germany

Natalie ESSIG^a

^a University of Applied Sciences Munich (MUAS), Germany, natalie.essig@hm.edu

ABSTRACT

Several international and national instruments for the assessment of the sustainable building performance have been developed in the last years, such as BREEAM (Great Britain), LEED (USA) and DGNB or BNB (Germany). These methodologies have the same intent - advancement of the sustainable building performance. The focus of these systems are mostly commercial buildings, but also the sustainability rating of the residential sector is getting more and more important. The numbers of certifications with BREEAM, LEED or the Swiss Label Minergie are increasing constantly. In Germany however available systems to certify the sustainability of this type of buildings have so far not achieved widespread due to a complex list of criteria and the costly implementation. In regard that 2.9 million dwellings will be required by 2025 and that 115,000 owner-occupied detached and semi-detached houses are built up per year in Germany, a new assessment method (BNK system) for small residential houses was developed in the context of a research project on behalf of the Federal Ministry for the Environment, Nature Conservation, Building and Nuclear Safety (BMUB). To ensure the suitability of the assessment system the BNK method was tested in a pilot phase involving 18 real case buildings. From 2016 on the BNK method is now available for general use and the assessment is financially supported by public funds (KfW Banking Group).

This paper will show the development and experience with the sustainability assessment of buildings in Germany in general, as well how the new list of criteria, indicators and benchmarks for assessing sustainability of small residential buildings (up to five dwelling units) putting the emphasis on simple applicability and cost-effectiveness in order to achieve widespread application. The assessment system focuses on the category of socio-cultural and functional quality followed by economic quality, environmental quality and process quality.

Keywords: certification of buildings, assessment of the sustainability building performance, assessment and rating methods

1. INTRODUCTION

Several international and national instruments for the assessment of the sustainable building performance have been developed in the last years. Back in the 1990s first sustainability tools such as the British system BREEAM and the American label LEED were developed and introduced on the market. In 2009 the DGNB certificate of the German Sustainable Building Council (DGNB) and the Sustainable Construction Evaluation System (BNB) of the Federal Ministry of Transport, Building and Urban Development (BMVBS) was established in Germany. These methodologies have the same intent - advancement of the sustainable building performance. In contrast to traditional assessment methods the German systems pursue a holistic approach throughout the whole life cycle of a building instead of focusing primarily on ecology and energy efficiency.

The focus of the German DGNB and BNB systems are mostly commercial buildings, but also the sustainability rating of the residential sector is getting more and more important. However in Germany the focus was so far set on building types such as office buildings, schools, industrial buildings or large residential buildings. Small residential buildings in contrast have not obtained enough attention to date although detached and semi-detached houses make up a considerable part of 45 percent of new construction projects within the housing sector. In 2012 the Sustainable Construction Quality Label (NaWoh) was developed with support by the Ministry for Transport, Building and Urban Development (BMVBS). 12 projects have been assessed so far, but the system is only applicable to residential buildings with more than five dwelling units. Furthermore the German Association for **Sustainable Building (DGNB) established the system variant "Small Residential Buildings" for houses with less than six dwellings**, but only four certifications have been carried out to date. Due to a complex list of criteria and the costly implementation the assessment system is not widespread so far.

The numbers of certifications with BREEAM, LEED or the Swiss Label Minergie are increasing constantly. In Germany however available systems to certify the sustainability of this type of buildings have so far not achieved widespread due to a complex list of criteria and the costly implementation.

In regard that 2.9 million dwellings will be required by 2025 and that 115,000 owner-occupied detached and semi-detached houses are built up per year in Germany, a new assessment method (BNK system) for small residential houses was developed in the context of a research project on behalf of the Federal Ministry for the Environment, Nature Conservation, Building and Nuclear Safety (BMUB).

To ensure the suitability of the assessment system the BNK method was tested in a pilot phase involving 18 real case buildings. From 2016 on the BNK method is now available for general use and the assessment is financially supported by public funds (KfW Banking Group). The objective of the paper is to give an insight into the assessment method and point out the suitability for small residential buildings.

2. SUSTAINABILITY ASSESSMENT METHODS FOR RESIDENTIAL BUILDINGS IN GERMANY

The German Quality Labels (DGNB and BNB) were originally developed for new office and administrative buildings. Today, both the DGNB and BNB systems cater to a huge range of different typologies, from various building types through to entire city districts. For example, there are now lists of criteria covering new, refurbished and existing office and administrative buildings, industrial, commercial and educational buildings, and even sports buildings.

Up until now, it has been almost exclusively buildings such as office buildings, schools, industrial buildings, and large residential buildings (i.e. those containing six or more dwelling units) that have been assessed for sustainability in Germany. Insufficient attention has been given to smaller residential buildings ranging from detached houses to apartment blocks with up to five flats, even though these buildings represent a large (45 %) share of total residential new build. The BMUB is tackling this problem and, together with the Munich University of Applied Sciences has developed a list of criteria specifically for these smaller residential buildings. A wide range of industry players were subsequently called upon to fine-tune this list, which was then subjected to a run to test its suitability for the market. These included housing construction industry associations, architects, engineers, and the prefabricated house industry.

2.1 Why detached and semi-detached houses?

Outside Germany, residential buildings have long since been assessed against sustainability criteria. Some **462,500 dwellings have so far been assessed under the BREEAM “Code for Sustainable Homes” system**, for example. This is thanks to the **UK government’s decision in 2008 to enshrine in law the sustainability assessment** of buildings. More buildings are being assessed all the time, including under the LEED quality label (14,900 dwellings certified) and the Swiss Minergie label (17,850 detached and semi-detached houses certified). In Germany, the Sustainable Housing Construction Quality Label (NaWoh) and individual system variants of the DGNB certificate are available for assessing residential buildings, although the former is only available for structures containing six or more dwellings. 12 projects have been awarded a NaWoh certificate since 2011. To **date a total of four buildings have been certified under the “Small Residential Buildings” method for buildings with less than six dwellings**. The list of criteria for this method is however currently very complicated and costly to implement, and is primarily only suitable for prefabricated houses. With an average of 410,000 new detached and semi-detached houses being built each year in Germany, a cost-effective, lean, simple assessment system for residential buildings that all clients can apply, and that is designed to encourage sustainability in small residential buildings, is essential. This is confirmed by a survey conducted in 2014 on **the topic of “Clients and Sustainability”**:

- 96 % of future owners of a detached house would greatly value high energy efficiency, and hence long-term reductions in energy costs.
- For environmental reasons, 85 % would prefer environmentally-friendly building materials.
- 73 % see the value in a certificate that confirms that the house is built in a sustainable, environmentally-friendly, energy-efficient way.

2.2 Housing construction facts and figures

The latest figures also confirm the need to encourage sustainability in residential construction, particularly in relation to small residential buildings:

- There are currently 18.3 million residential buildings in Germany containing a total of 39.3 million dwellings and 3.6 billion m² of living space. Of these buildings, around 75 %, i.e. 13.7 million are detached or semi-detached (as per 2011 data).
- In 2013, permits were awarded for the construction of 270,400 dwellings in Germany, 12.9 % more than in 2012.

The number of construction permits granted for dwellings in apartment buildings grew by 22.3 % between 2012 and 2013, which is a considerably higher rate of increase than for dwellings in detached and semi-detached houses. The number of construction permits awarded for detached houses (89,500) represented only a small increase of 1.1 %, whereas the number awarded for semi-detached houses (20,330 new buildings) rose by 13.3 % . According to forecasts by the German Federal Institute for Research on Building, Urban Affairs and Spatial Development, a total of 2.9 million further dwellings will be needed by 2025. This corresponds to an average of 183,000 new dwellings each year. The vast majority of this predicted new build is expected to be owner-occupied detached and semi-detached houses, averaging 115,000 new dwellings per year. However, it is important to note that average living space per capita has doubled in Germany over the last 60 years, and currently stands at 43 m². This is due to a large extent to detached houses – **in which 28 % of Germany's approximately 40 million private households live** – because on average these homes contain substantially more living space per person than do apartment buildings that have been built to rent out. And this is the great contradiction surrounding the issue of sustainability in Germany: although the legal thresholds for space heating demand and energy consumption per unit living space are being lowered all the time, and all new buildings need to be ultra-low energy by 2020, the actual amount of energy consumed per person – because of the rise in living space per capita – has remained the same. Making a building sustainable is about more than just improving its energy efficiency: aspects such as emissions of harmful substances, land use, life cycle analyses, and design all have a role to play. It is precisely these topics that form the focus of the list of criteria for small residential buildings.

3. CRITERIA FOR SUSTAINABLE SMALL RESIDENTIAL BUILDINGS

The list of criteria for sustainable small residential buildings is divided up into four overarching categories broken down into a total of 18 criteria (Figure 1,2):

- Sociocultural and functional quality
- Economic quality
- Environmental quality
- Process quality



Figure 1: Sustainability qualities

3.1. Social-cultural and functional quality

Social aspects are particularly important in determining the sustainability of small residential buildings, so the **category of “sociocultural and functional quality” comes first in this list of criteria, rather than environmental quality**, which comes first in the lists of criteria for the other building types. The quality of life, comfort, safety, security and adaptability that the building offers are all assessed. The level of comfort is determined by measuring building physics characteristics, making calculations regarding thermal, acoustic and visual comfort, and by assessing the inherent level of hygiene inside the building. Because the system takes into account the aspects of safety and security, accessibility, and the user-friendliness of the building services, **it helps to enhance residents’ quality of life.**

3.2. Economic quality

The goal of the “economic quality” category is to determine selected costs incurred during the building’s life cycle, and to assess its long-term viability. The calculation of life cycle costs is based on the standard DIN 276 (Building costs – Building construction). Long-term viability is based on the assessment results for various criteria such as **accessibility and thermal insulation in summer, and the extent to which the building’s energy efficiency figures exceed those demanded by the German Energy Saving Regulation, the extent to which the rooms are designed in a neutral way to allow for alternative uses, and the extent to which the client has been briefed to enable them to maintain the building’s value over time.**

Category	Criterion	No.	Indicator
1. Sociocultural and functional Quality	1.1 Healthy housing		
		1.1.1	Indoor air quality
		1.1.2	Drinking water hygiene
	1.2 Thermal comfort		
		1.2.1	Summer heat protection
	1.3 Visual comfort		
		1.3.1	Availability of daylight
	1.4 Sound insulation		
		1.4.1	Airborne sound insulation against noise from outside
		1.4.2	Airborne sound and subsonic noise insulation inside the building
		1.4.3	Structure-borne sound insulation
	1.5 Control comfort of building technology		
		1.5.1	Userfriendliness of building control
	1.6 Safety and security		
	1.6.1	Preventive measures against burglary	
	1.6.2	Fire protection	
1.7 Design for All			
	1.7.1	Design for All	
2. Economic Quality	2.1 Lebenszykluskosten		
		2.1.1	Selected life cycle costs
	2.2 Value retention		
	2.2.1	Future viability of the building	
3. Environmental Quality	3.1 Wirkungen auf die Umwelt		
		3.1.1	Life cycle impact assessment - Global Warming Potential
		3.1.2	Life cycle impact assessment - Ozone Depleting Potential
		3.1.3	Life cycle impact assessment - Photochemical Ozone Creation Potential
		3.1.4	Life cycle impact assessment - Acidification Potential
		3.1.5	Life cycle impact assessment - Eutrophication Potential
		3.1.6	Harmful emissions into the environment
	3.2 Energy consumption		
		3.2.1	Life cycle impact assessment - Primary Energy demand renewable
		3.2.2	Life cycle impact assessment - Total Primary Energy Demand
		3.2.3	Decentralised energy generation
	3.3 Raw material input and waste generation		
		3.3.1	Recyclability and ease of dismantling
	3.4 Biodiversity		
	3.4.1	Use of local or certified wood	
3.5 Drinking water consumption			
	3.5.1	Use of water-saving valves	
3.6 Land use			
	3.6.1	Land use	
4. Process Quality	4.1 Project preparation		
		4.1.1	Consultation and goal-setting
	4.2 Object documentation		
	4.2.1	Building record and user manual	
4.3 Quality of construction work			
	4.3.1	Quality assurance	

Figure 2: List of criteria and indicators (version V0.0)

3.3. Environmental quality

The environmental quality of a detached or semi-detached house is assessed by carrying out a life cycle assessment (LCA). The LCA is prepared using **the online tool “eLCA” provided by the BMUB and the BBSR** (German Federal Institute for Research on Building, Urban Affairs and Spatial Development). The LCA looks at **the building’s entire life cycle, now including not just the building fabric itself, but** also the building services. The most important indicators are Primary Energy Consumption and Global Warming Potential, but it also considers aspects such as recyclability, the use of local or certified wood, measures taken to reduce drinking water consumption, and the efficient use of space in order to minimise soil sealing.

3.4. Process quality

The main aim of the “process quality” category in relation to residential buildings with up to five dwellings is to ensure the quality of planning, construction and documentation, and to provide a building dossier including a user manual. The building dossier includes the latest plans, energy performance certificates, measurement records, safety certificates, data sheets, care instructions, and all documents relevant to the operation and maintenance of the building. Process quality also includes having the quality of construction verified by an external assessor.

4. PILOT PROJECTS

A pilot study involving building owners, developers, project managers, architects and engineers was carried out in order to check the suitability of the list of criteria, and to test the system out on real detached and semi-detached houses. Following this pilot phase, the list was extended to cover buildings with between three and five dwellings as well. During the test phase a total of 22 projects were assessed, including 15 detached houses, one detached house with a secondary suite, one semi-detached house, four terraced houses, and a building consisting of two flats above a shop unit. The first 12 projects were certified at the BAU 2015 trade fair in Munich. The results of the certification process are expressed as a percentage and a score, and ranged from 61.73 % (score: 2.2) to 85.1 % (score: 1.3). The remaining 10 projects are still being assessed. During the pilot phase, it emerged that **the biggest differences between research and reality are in people’s response to the statutory requirements regarding safety, security, accessibility and harmful emissions into the environment.** It became clear that, in the real-life construction industry, the applicable standards are not always adhered to as a matter of course. In some areas where the relevant building products and verifications were not yet available on the market, or the costs of implementation **would be excessive, the criteria were modified or, in the case of the criterion “harmful emissions into the environment”, were postponed during the pilot phase.**

5. OUTLOOK

The list of criteria was being revised on the basis of the results from the pilot phase, and from April 2015 it is available for general use as a simple and cost-effective assessment system. Assessment will in future be carried **out by “Sustainability Coordinators” who hold a specialist qualification in sustainable building, and who monitor the project during construction.** As a next step, an online platform will be set up to make it easier to generate the necessary building documentation. So far the system has been extended to cover residential buildings with up to five dwellings; in future it is conceivable that it will also allow the assessment of refurbishment work on existing residential buildings.

To ensure that all certificates are of a suitably high quality, assessments should be checked, and the coordinators trained, by an independent body. Therefore the BMUB has announced the Building Institute for Resourceefficiency and Sustainability (BiRN GmbH). From 2016 the KfW Banking Group is providing financial support to help projects achieve the sustainability certificate for houses with 1-5 dwellings, similar to the support it offers for those seeking to achieve the Efficiency House standard.

REFERENCES

- [1] BBSR: Neubaunachfrage in Deutschland bis 2025; Internetartikel;2011 vgl. http://www.bbsr.bund.de/nn_820044/BBSR/DE/WohnenImmobilien/Wohnungsmarktprognosen/Fachbeitraege/Neubaunachfrage/neubaunachfrage.html ; 03.08.2016
- [2] BREEAM: Code for Sustainable Homes; Internetseite; 2015 vgl. <http://www.breeam.org/about.jsp?id=66>; 02.03.2015
- [3] Buildings Institute for Ressource Efficiency and Sustainability (BiRN); Internet Page; 2016; www.bau-irn.de ; 29.09.2016
- [4] DFH Deutsche Fertighaus Holding AG: DFH Trendbarometer Nachhaltigkeit 2014; Umfrage durchgeführt von forsa; Gesellschaft für Sozialforschung und statistische Analysen mbH; 2014 vgl. <http://zukunfft-fertighaus.de/wp-content/uploads/2014/02/DFH-Trendbarometer-Nachhaltigkeit-2014.pdf> ; 20.12.2014
- [5] DGNB: DGNB angemeldete und zertifizierte Projekte; Internetseite; 2015 vgl. <http://www.dgnb-system.de/de/projekte/>; 02.03.2015
- [6] Ebert, T., Essig, N., Hauser, G.: Zertifizierungssysteme für Gebäude. Nachhaltigkeit bewerten – Internationaler Systemvergleich – Zertifizierung und Ökonomie. München: Detail-Verlag; 2010
- [7] Minergie: Gebäudeliste; Internetseite; 2015 vgl. www.minergie.ch/gebaeudeliste.html ; 02.01.2015
- [8] Statistisches Bundesamt: Bautätigkeit und Wohnungen, Bestandan Wohnungen, Stand 31. Dezember 2001; Fachserie 5, Reihe 3; Wiesbaden; 2014a vgl. https://www.destatis.de/DE/Publikationen/Thematisch/Bauen/Wohnsituation/BestandWohnungen2050300117004.pdf?__blob=publicationFile ; 02.01.2015
- [9] Statistisches Bundesamt: Für 28 % der Haushalte Realität: Der Traum vom eigenen Einfamilienhaus; Internetartikel von 2013 vgl. https://www.destatis.de/DE/PresseService/Presse/Pressemitteilungen/zdw/2013/PD13_050_p002.html ; 03.09.2016
- [10] Statistisches Bundesamt: Januar – September 2014: 5,2 Prozentmehr genehmigte Wohnungen; Pressemitteilung vom 18. November 2014 – 406/14; Wiesbaden; 2014 vgl. https://www.destatis.de/DE/PresseService/Presse/Pressemitteilungen/2014/11/PD14_406_31111pdf.pdf?__blob=publicationFile ; 03.01.2015
- [11] USGBC: Projects; Internetseite; 2015 vgl. <http://www.usgbc.org/projects>; 04.03.2015
- [12] Verein zur Förderung der Nachhaltigkeit im Wohnungsbau: Qualitätssiegel Nachhaltiger Wohnungsbau; Internetseite; 2016 vgl. <http://www.nawoh.de/siegelvergabe> ; 03.01.2015

Poster Session

Renovation of Sheung Shui Staff Quarters – Green Building Actions Echoed by the Contractor

LI Siu-lung^a

^a Water Supplies Department, Government of the HKSAR, Hong Kong SAR, sl_li@wsd.gov.hk

ABSTRACT

The Sheung Shui Staff Quarters of Water Supplies Department (WSD), which comprise three low-rise buildings (up to 3-storey high with total construction floor area of 1,027m²), were built in 1985. They were situated along the eastern edge of the Sheung Shui Water Treatment Works (WTW). The Quarters were allocated to the operational staff. However, the demand of the Quarters were no longer required for operational need in recent years with the improved transport to the WTW. WSD decided in 2015 to convert the Quarters into the office of a maintenance depot for use by the waterworks maintenance term contract for more gainful use of the buildings.

The conversion project involved renovation of the buildings to restore their serviceability and to provide new lighting, **ventilation and power system for use of the office**. In line with the Government's drive for promoting green building, the project adopted sustainable design by using integrated green building disposition and technologies with due consideration for the operational need and cost-effectiveness.

Having preliminarily assessed by the consultant on the design of the office of the maintenance depot against various aspects of environmental performance (including site aspects, materials aspects, energy use, water use, indoor environmental quality and innovations), this project could readily attain a Silver rating under the BEAM plus building environmental assessment system. In addition, the maintenance term contractor who would use the office decided to install a photovoltaic system at the roofs of the buildings at its own cost for energy saving. With this additional feature, the project was eligible to apply for a higher (i.e. Gold) rating.

The project commenced in December 2015 for substantial completion by October 2016.

Keywords: green building, BEAM Plus, building performance

1. PROJECT BACKGROUND

The Sheung Shui Staff Quarters of Water Supplies Department (WSD), which comprise three low-rise buildings (up to 3-storey high with total construction floor area of 1,027m²), were built in 1985. They were situated along the eastern edge of the Sheung Shui Water Treatment Works (WTW). The Quarters were allocated to operational staff. However, the Quarters were no longer required for operational need in recent years with improved transport to the WTW. WSD decided in 2015 to convert the Quarters into the office of a maintenance depot for the waterworks maintenance term contract for more gainful use of the buildings.



Figure 1: The exterior of the adjoining Block A and Block B of Sheung Shui Staff Quarters before renovation. (Photos taken in October 2015).

Having been used for more than 30 years, the buildings had deteriorated considerably in particular the interior of individual units. Problems such as leaking roof, damaged flooring and defective building fixtures were identified.



Figure 2: The condition of Sheung Shui Staff Quarters before renovation.

To restore the serviceability of the buildings, extensive renovation and improvement work including waterproofing at the roofs, demolition of aged building fixtures, plastering, painting as well as replacement of windows, doors and flooring were required. Re-provision of lighting facilities, ventilation system and power system was also required for converting the buildings for office use.



Figure 3: Scope of renovation works of Sheung Shui Staff Quarters.

After about 10 months for design to construction, the conversion of the three buildings into an office which can accommodate about 45 staff with 1,027 m² floor area will be substantially completed in October 2016. Block A and Block B will provide the required office facilities like meeting rooms, printing rooms and a refuse storage and material recovery chamber, and Block C will provide changing rooms with shower facilities.

Project Owner:	Water Supplies Department
Main Contractor:	Chun Wo Construction & Engineering Co Ltd
BEAM Consultant:	Parsons Brinckerhoff (Asia) Ltd
M&E Engineer:	Parsons Brinckerhoff (Asia) Ltd
Project Cost:	HK\$10 million

Table 1: Key project team members.

2. COMMITMENT TO PROMOTE GREEN BUILDING

In line with the Government's drive for promoting green building, the project adopted sustainable design by using integrated green building disposition and technologies with due consideration for the operational need and cost-effectiveness. Following the green building policy formulated by the Development Bureau (DEVB) of the HKSAR Government, the project adopted the framework for refurbishment of existing government buildings as set out in the DEVB Technical Circular No.2/2015 throughout its planning, design and construction stages.

3. BUILDING DESIGN

The buildings spread across generously landscaped space (at least 40% of the site area) in harmony with the nature. Operable windows and perforated grille walls enhanced the buildings' performance in passive energy efficiency aspects such as the use of daylight and natural cross ventilation. Moreover, high emissivity roof painting (i.e. painting material with Solar Reflective Index exceeding 78) was applied to those roof areas where they would not be shaded by the photovoltaic panel systems to be installed at the roofs to minimize the solar heat gain of the buildings. Besides, the occupants could benefit from the natural breeze in the balconies, especially during cool months.



Figure 4: An artistic image of the proposed office of the maintenance depot.



Figure 5: The latest view of the renovated buildings.

To minimize construction waste and the embodied energy of construction materials required for the renovation as well as the associated environmental impact, more than 90% of the existing building substructure and above-ground structural frames were reused (which would also shorten the construction period). Besides, a room of about 4m² at ground floor was designated as the Refuge Storage & Material Recovery Chamber (RS&MRC) equipped with de-odorizing system to improve hygiene.

In consideration of topography and harmony with the surroundings, the buildings' form and their orientation were checked through simulation to ensure the access to daylight of neighboring sensitive buildings was maintained to the prescribed level (see relevant figures below).

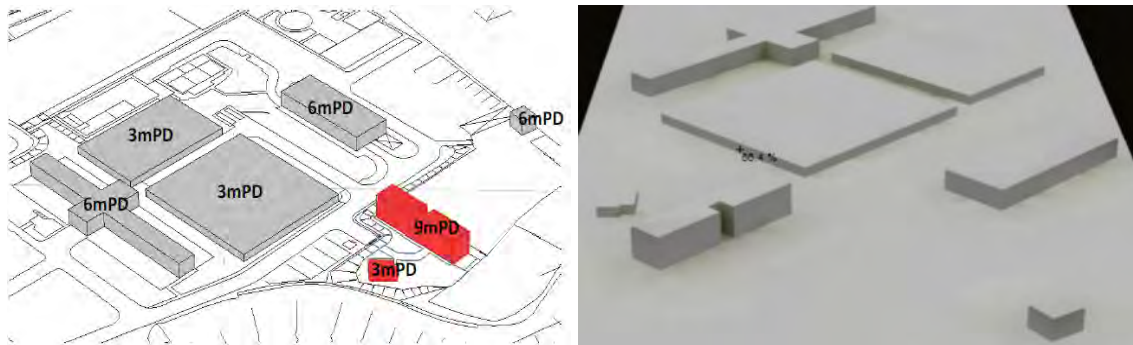

Figure 6: Simulation of neighborhood daylight access.

An Environmental Management Plan was implemented on site to control, monitor and mitigate the air pollution, noise pollution, water pollution, light pollution and solid waste production associated with the project.

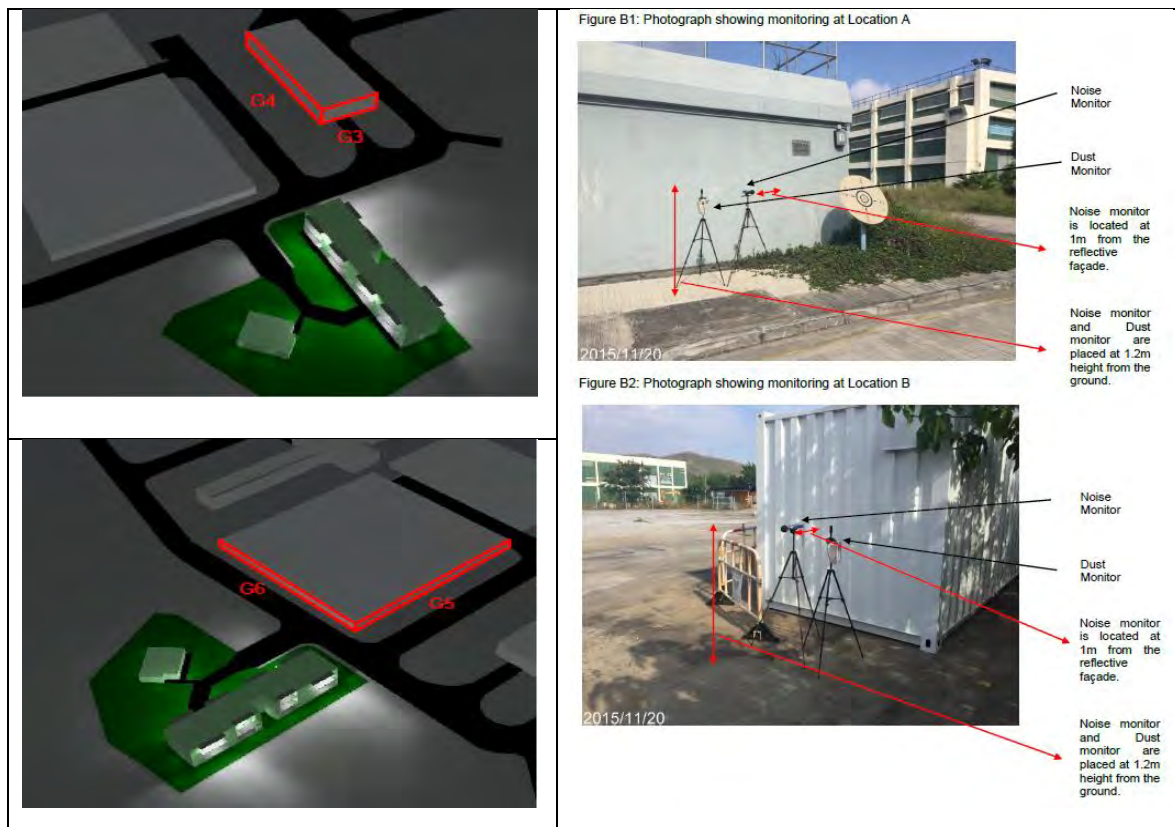

Figure 7: (Left) Simulation of light impact on neighborhood sensitive receivers.

Figure 8: (Right) Baseline monitoring of noise and air quality.

4. MATERIALS ASPECTS

More than 50% of timber and composite timber products used in the project such as those of wooden doors and their frames were from environmentally sustainable source certified by the Forest Stewardship Council (FSC).

The non-structural partition walls were made of chemical gypsum which were recycled materials. They could be easily dismantled and reused elsewhere at the end of the building's life. They, together with most of the other building materials used in the project, were manufactured locally within 800km from the site. That implied the carbon emission associated with the transportation of these building materials was reduced.



Figure 9: Construction of partition walls with recycled chemical gypsum

5. ENERGY EFFICIENCY

The proposed office was designed to achieve an energy performance which outperformed BEC by about 38%. BEC refers to the Code of Practice for Energy Efficiency of Building Services Installation issued by EMSD under the Building Energy Efficiency Ordinance (Cap 610). Simulation of the energy consumption of the office was conducted and some key information is extracted as follows:

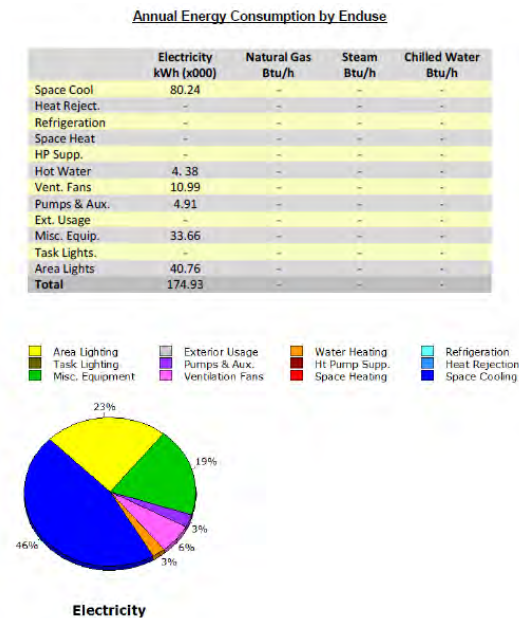

Figure 10: Design annual energy consumption and the resulting energy saving.

The energy performance of the office as reflected in the simulation was encouraging and it was achieved through various energy efficient features such as split-type air conditioners and water heaters of Grade 1 energy efficiency under Mandatory Energy Efficiency Labelling Scheme (MEELS), glazing with glass panes of low U-value and shading coefficient of about 5 and 0.68 respectively which offered more heat insulation in the building envelope, and the use of renewable energy by means of the photovoltaic panel system installed on the roofs of the buildings. In addition, LED light tubes were used for lighting to effectively reduce the lighting power density (LPD). Daylight and motion sensors were also installed to switch off the lighting when not required to further lower the lighting energy consumption.

With the total energy saving of 67,000 kWh per annum, the payback period of the additional cost for the aforementioned energy efficient features is just about 9 years.

Table 5.1 Comparison of Annual Energy Consumption Reduction

	Energy Source	Energy Consumption
Baseline Case	Electricity	174.93 MWh
Design Case	Electricity	107.96 MWh
% Reduction		38.3%

Table 5.2 Comparison of Annual Peak Demand Reduction

	Energy Source	Energy Consumption
Baseline Case	Electricity	64.58 kW
Design Case	Electricity	43.84 kW
% Reduction		32.1%

6. RENEWABLE ENERGY

The photovoltaic (PV) system installed on the roof of Block A and Block B was the renewable energy (solar power) source for the proposed office. The roof area covered by the PV panels is approximately 200 m² (which is more than 40% of the total building footprint). The solar radiation on the designed PV panel area was analyzed and the total annual output from the panels was estimated to be 19,710 kWh which was equivalent to about 11% of electricity consumption for general power and lighting in the proposed office.



Figure 11: Photovoltaic system installed on the roof of Block A and Block B.

7. WATER MANAGEMENT

For water conservation, the design of the office incorporated the use of water saving devices (including low-flow taps, shower heads and other fixture/fittings) at toilets, pantry and changing rooms to reduce potable water consumption beyond the typical BEAM Plus standards, achieving about 40% reduction compared to the baseline.

	Fresh water consumption
Baseline case	466 Litre/Day
Design case	180 Litre/Day
% Reduction	39%

Table 2: Computed reduction in fresh water consumption.

In addition, rainwater was also harvested for non-potable purpose.

8. INDOOR ENVIRONMENTAL QUALITY

The design of the office also aimed at quality indoor environment which would benefit the health, wellbeing and productivity of the occupants. For providing a hygienic refuse collection system, the RS&MRC was equipped with air purifier. Indoor sources of air pollution from toilets and photocopying rooms would be controlled at source with the localized ventilation system. Design considerations were also given to other indoor environmental aspects such as thermal comfort, lighting quality, room acoustics and the provision of building amenities.

9. GREEN BUILDING ACTIONS ECHOED BY CONTRACTOR

The Government encourages the participation in green building assessment scheme. This project has participated in the BEAM Plus building environmental assessment scheme. It provided opportunities for the WSD staff, and project officers, professionals and site personnel of the contractor to learn about the detailed requirements and submission standard for such green building performance assessment. In involving in the exercise, they were motivated with enhanced environmental awareness and job satisfaction brought about by acquainting themselves with the latest trend, technology and best practices relating to green building and sustainability.

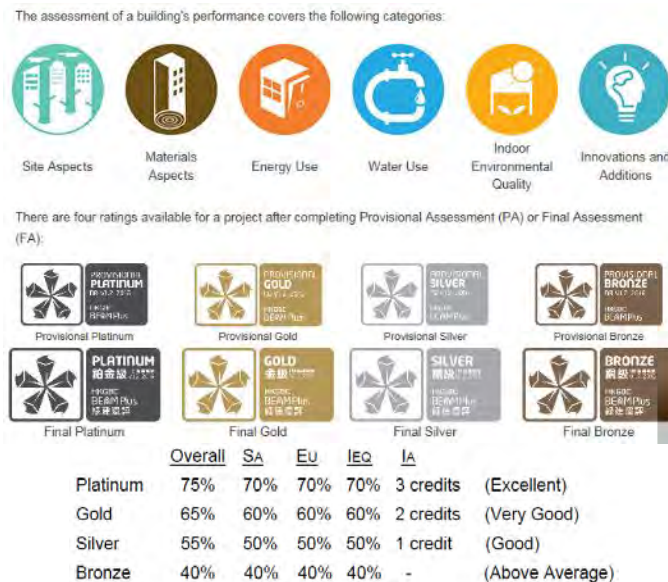

Figure 12: BEAM Plus grading requirements for the 6 categories of building performance.

More encouraging was when we stepped forward to participate in the BEAM Plus assessment, the action became a positive influence to others. Having preliminarily assessed by the consultant on the design of the office against various aspects of environmental performance (including site aspects, materials aspects, energy use, water use, indoor environmental quality and innovations), this project could readily attain a Silver rating. The maintenance term contractor who would use the office decided to install photovoltaic system at the roofs of the buildings at their own cost energy saving. With this additional feature, the project was eligible to apply for a higher (i.e. Gold) rating.

10. CONCLUSION

The renovation of Sheung Shui Staff Quarters into an office of the maintenance depot is one of the recent green building projects of WSD illustrating the Department's devotion in enhancing a green, harmonious and sustainable built environment. When the office comes into operation, they will consume less energy (with energy saving of about 67,000 kWh per annum) and less fresh water (with water saving of about 286 litre per day), representing a reduced carbon emission of 47 tonnes CO₂-equivalent per year.

The Department's participation in the BEAM Plus building environmental assessment not only allowed the green performance of the proposed buildings to be evaluated, verified and accredited, the action also reaffirmed the notion "The Best Way of Leading is By Example" in view of the positive echo by the maintenance term contractor who voluntarily introduced additional green feature to this project to make it eligible to apply for a higher (i.e. Gold) BEAM Plus rating.

The joint effort with the industry in supporting green building will surely create a sense of well-being to us and nurture the sustainable livable environment for all.

REFERENCES

- [13] "DEVB Technical Circular No.2/2015". Development Bureau of the HKSAR Government.
- [14] "BEAM Plus Manuals". 2012. Hong Kong Green Building Council.
- [15] "WSB14 Hong Kong Report-BEAM Plus Milestone". 2014. Hong Kong Green Building Council.
- [16] "Hong Kong Report on the state of Sustainable Built Environment 2014". Construction Industry Council and Hong Kong Green Building Council.
- [17] "Guidelines to Account for and Report on Greenhouse Gas Emissions and Removals for Buildings (Commercial, Residential and Institutional Purpose) in Hong Kong". 2010. Environment Protection Department of the HKSAR Government.

Environmental Impact Assessment of the Central Kowloon Route Project

LAM Man-san^a, Franki C K CHIU^b

^a Highways Department, Government of the HKSAR, Hong Kong SAR, se3ckr.mw@hyd.gov.hk

^b Arup, Hong Kong SAR, Franki.Chiu@arup.com

ABSTRACT

The Government of the Hong Kong Special Administrative Region of the People's Republic of China (The Government of the Hong Kong SAR) is committed to sustainable development. The Central Kowloon Route (CKR) is a 4.7 km long dual 3-lane trunk road linking the Yau Ma Tei Interchange in West Kowloon with the road network in the Kai Tak Development and Kowloon Bay in East Kowloon. The CKR will relieve traffic congestion on existing major east-west corridors, enhance linkage amongst districts and support various developments in Kowloon. The CKR will reduce the number of vehicles using the existing major east-west corridors and alleviate the noise and air pollution arising from the existing traffic thus bringing significant overall environmental benefits. In this paper, the authors will present the environmental impact assessment (EIA) process of the CKR Project and focus on the approaches to protect the environment through early considerations of environmentally friendly designs, advanced air purification systems, and prevention of adverse environmental consequences in order to achieve key decision makings throughout the entire life cycle of a designated project. This paper also highlights the further sustainable development of the Project after the EIA approval including re-use of land-based marine sediments and green building design.

Keywords: design process, green rating tool, high-performance building

1. INTRODUCTION

1.1. The need of the CKR

The traffic on existing major east-west corridors in Kowloon, including Lung Cheung Road, Boundary Street, Prince Edward Road West, Argyle Street, Waterloo Road, Gascoigne Road Flyover and Chatham Road North of central Kowloon is nearing saturation and traffic congestion frequently occurs. The Government of the Hong Kong SAR has implemented local traffic management and improvement measures. However, since the areas on both sides of the existing east-west corridors are highly developed, the options for such measures are limited and therefore can only alleviate localised traffic problems in the short term. A large scale scheme to comprehensively improve the situation and cater for the long term need is thus essential.

CKR is a proposed dual 3-lane trunk road across central Kowloon linking the West Kowloon in the west and the proposed Kai Tak Development (KTD) in the east. Its western end at West Kowloon would connect to the Yau Ma Tei Interchange, via which to connect to strategic road links of the Western Harbour Crossing, West Kowloon Highway, Route 8, and Route 3 and key urban areas of Tsim Sha Tsui and the future West Kowloon Cultural District. Its eastern end at KTD would connect to trunk roads of Kwun Tong Bypass, Tseung Kwan O Tunnel, the future Road T2 and Tseung Kwan O-Lam Tin Tunnel, and urban development areas of Kowloon Bay, Kowloon East and Kai Tak Development. CKR together with Trunk Road T2 and Tseung Kwan O-Lam Tin Tunnel would form the strategic Route 6 highway link connecting West Kowloon and Tseung Kwan O. Figure 1 shows the layout plan and longitudinal section of CKR.



Figure 1: Layout plan and longitudinal section of CKR

CKR will provide an alternative route for the traffic to bypass the congested existing road network thus significantly reducing the journey time. For example, it is estimated that during the peak hours after completion of CKR, the journey time between west and east Kowloon via CKR will take around 5 minutes, compared to 30-35 minutes without CKR. CKR will also substantially reduce the traffic volumes around major east-west corridors in central Kowloon thus relieving their traffic congestion. The improved traffic conditions will also benefit the adjacent areas including Wong Tai Sin, Ho Man Tin and Kowloon City.

1.2. Benefits of the project

- Economic returns

Savings resulted in travel distance and travel time are the primary source of economic benefits from CKR. It is estimated that by 2030, the daily travel time savings will reach 120 thousands passenger hours bringing an economic value of \$2.6 billion per annum.

Benefits will also arise from fewer accidents as travellers are diverted to use tunnel from local roads. According to the accident statistics provided by the Transport Department, the accident rate per veh-km for tunnels is 85% lower than local road during 2006 – 2010.

- Environmental benefits

As the traffic on the existing east-west corridors in Kowloon could be diverted by CKR, the traffic volume on these at-grade corridors could be reduced. Pollution resulted from traffic congestion could therefore be reduced to improve the environment in the surrounding areas.

With CKR in place, the traffic conditions (in terms of average travelling speed) along these east-west corridors would be improved and this would lead to a reduction in the substances such as CO₂, NO_x and Respirable Suspended Particulates (RSP) released from vehicles.

Through the adoption of advanced technology like Air Purification System (APS), vehicle exhaust discharged from the 3 ventilation buildings along CKR are largely decreased by the Electro-Static Precipitator and NO₂ removal system.

The following Table 1 summarises the estimated environmental benefits for east-west corridors of Kowloon:

Substances from Vehicular Emission	Reduction by CKR at 2026, Ton / year
CO ₂	Approx 20,000
NO _x	Approx 18
RSP	Approx 2

Note: Considering key East-West Corridors of Kowloon ONLY

Table 1: Reduction of annual emission for key East-West corridors

- Social benefits

In the future when CKR is completed, there will be a reduction in journey time, which will enhance the connection amongst districts thus supporting social developments.

2. EIA PROCESS OF THE CKR PROJECT

2.1. General approaches

The principle of avoidance and minimization of environmental impacts is the key driving force from the outset of the project planning and development.

Avoidance is the most effective way of preventing environmental impacts and this is primarily achieved through the careful selection of the best options among alternative routes and designs. Environmental considerations are an integral part of the route selection process at the early planning stage of a project, through which adverse impacts on important environmental sensitive receivers could be avoided as far as practicable.

Where adverse impacts on the environment are unavoidable, extensive efforts would be deployed in the planning and design of the project with an aim to achieving minimization of the impacts.

Once the preferred route has been chosen, control of the environmental impacts is mainly achieved by mitigation measures. Mitigation measures involve putting in place measures to reduce the effect of the impacts on the surrounding environment.

2.2. Selection of preferred alignment options

The proposed alignment of CKR evolved through various stages of studies, aimed at minimizing the land resumption/clearance, disruption to the public and impact on the environment. More than 40 alignment options had been considered and screened at each stage of studies, including tunnel and flyover options covering most of the Kowloon Peninsula from the northern Boundary Street to Tsim Sha Tsui. All these studies had concluded that a tunnel (as opposed to flyover) option across central Kowloon would be preferable.

A summary of the configuration of the key road sections of CKR is given in Table 2 below:

Location	Design	Approximate Length (m)
West Portion	Elevated/At-Grade Road	200
	Depress Road	200
	Cut-and-Cover Tunnel	400
Central Portion	Drill-and-Blast Tunnel	2760
East Portion	Cut-and-Cover Tunnel	210
	Underwater Tunnel	370
	Underpass/Depressed Road	320
	Elevated/At-Grade Road	320

Note: Along the mainline of CKR.

Table 2: Overview of key elements of the proposed alignment of CKR

CKR will mainly pass underneath an urban environment. As such, it is important to select an alignment, which can both follow the most favourable geological conditions for adopting mainly the drill-and-blast/break tunnelling method and maximise the rock cover above the tunnel. The selected alignment passes underneath the hills of Kings Park and Ho Man Tin. These areas not only have the advantage of greater rock cover but also have a relatively lower building density than the surrounding low-lying areas. The preferred alignment of the drill-and-

blast/break tunnel section also maximises the actual length of drill-and-blast/break and minimises the length of cut-and-cover tunnel. In that way, the adopted alignment will have the least adverse environmental impacts.

2.3. Approach adopted to minimize environmental impacts

Whilst the alignment selection process had avoided many environmental constraints from the outset, extensive efforts were also made to examine every opportunity to minimize environmental impacts.

Minimizing the Size of Reclamation at Kowloon Bay

In order to preserve the precious Victoria Harbour, the method of constructing the underwater tunnel by temporary reclamation using the cut-and-cover method was adopted. The alignment of the underwater tunnel was chosen for it would not involve resumption and/or demolition of private buildings and the extent of temporary reclamation was the minimum for practical construction. Figure 2 shows the layout plan and longitudinal section of the underwater tunnel.

The width of the temporary reclamation is dictated by the highway alignment design of the dual 3-lane trunk road and the minimum working space of 20 m working platform on both sides of the cut-and-cover tunnel. According to the experience of construction of underwater tunnel by similar method in the Central-Wan Chai Bypass project, this 20 m width is just adequate for construction activities. As such, the width of the proposed temporary reclamation is the minimum which requires less filling materials and hence fewer vehicles/barge trips during construction.

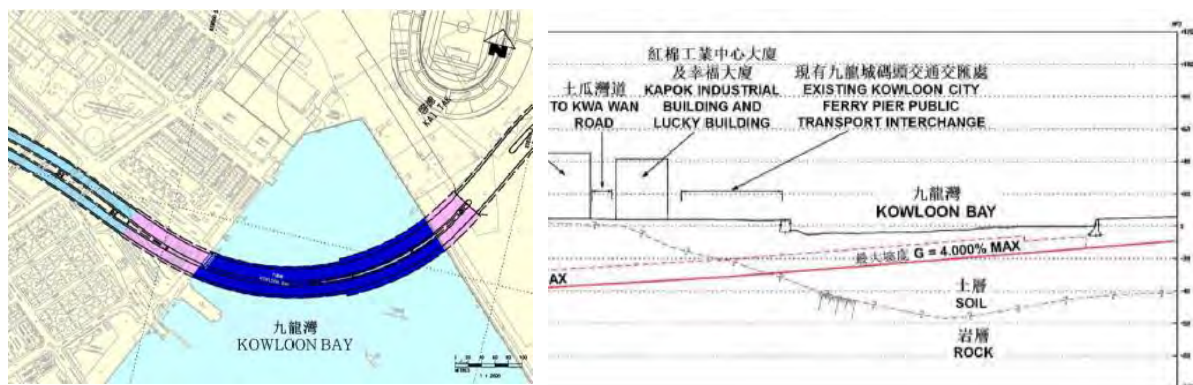

Figure 2: Layout plan and longitudinal section of underwater tunnel minimizing the extent of seawall

Conventionally, seawalls are constructed on firm foundations by replacing the soft marine mud in the seabed by sand fill. This process requires dredging and dumping of a large amount of soft marine mud. In order to minimize the extent of seawall for temporary reclamation, the current design is to use pipepile seawall as shown on Figure 3. The adoption of the pipepile seawall approach would significantly reduce the amount of marine-based dredged / excavated sediment from about 357,500 m³ to 176,600 m³.

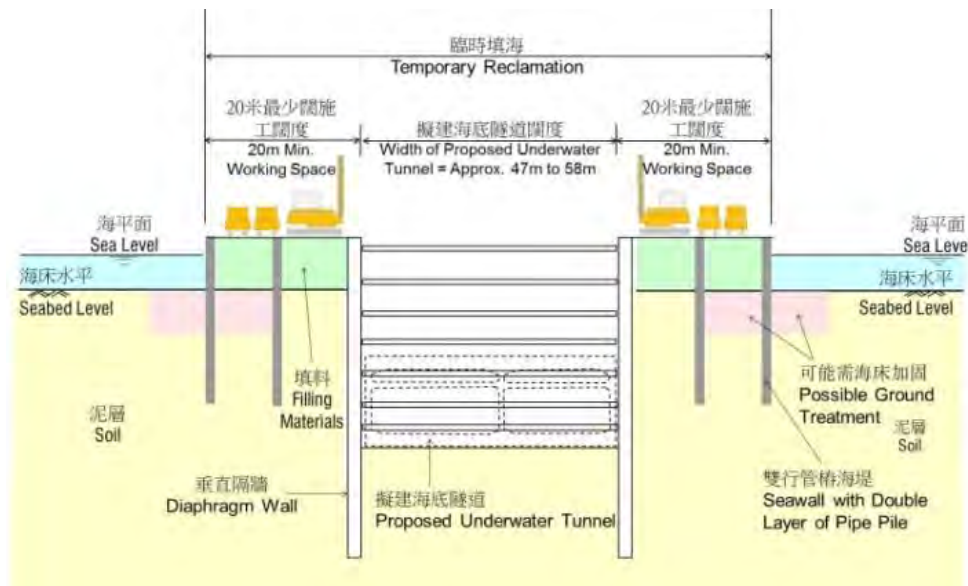

Figure 3: Typical cross section of temporary reclamation

2.4. Approaches adopted to mitigate environmental impacts

- Noise impact mitigation measures

To mitigate operational noise impact, noise mitigation measures including noise barrier / semi-enclosure / full noise enclosure and low noise surfacing are proposed for the project roads. With the provision of the noise enclosures / barriers recommended in the EIA report, there will be significant benefit on reduction in noise level at the noise sensitive receivers at Yau Ma Tei of up to 10dB(A) with an average 3dB(A) reduction. Approximately 1,600 existing dwellings and 85 existing classrooms could be benefited from the Project.

- Air quality impact mitigation measures

Vehicular emission inside the CKR tunnel will be discharged to atmosphere via the three proposed ventilation buildings, i.e. West Ventilation Building located in Yau Ma Tei, Central Ventilation Building in Ho Man Tin and East Ventilation Building in Kai Tak, which are sited away from residential buildings as far as possible. Limited emission from the CKR tunnel portals would be achieved in order to reduce potential air quality impact in these areas. To further reduce the air quality impact, an APS will be adopted to remove the pollutant concentrations before releasing the exhaust to the atmosphere. The APS design aims to achieve a removal efficiency of 80% for both RSP and NO₂. Figure 4 shows the schematic layout of the APS.

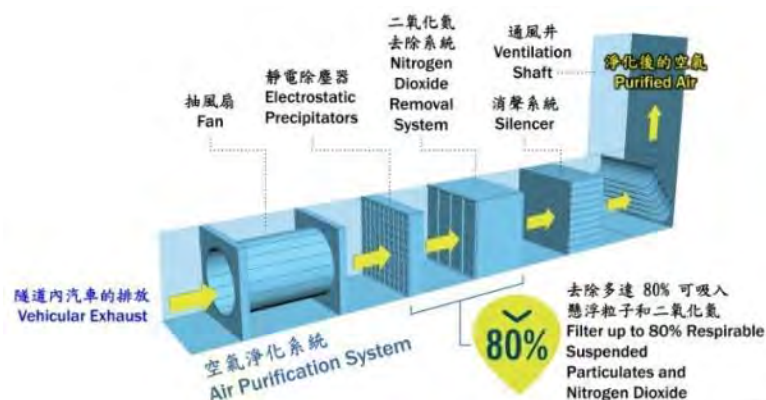

Figure 4: Schematic layout of air purification system enhancement of greening and landscaping

Highways Department (HyD) will make use of the opportunity of constructing CKR to improve the environment through greening and landscaping. A landscape deck with an area of about 20,000 m² will be constructed at the western tunnel portal of CKR tunnel. A 160 m long and 40m wide waterfront promenade will also be constructed along the waterfront area fronting the Kowloon City Ferry Pier Public Transport Interchange (PTI). The

reprovisioned PTI will be covered by a landscape deck with an area of about 9,000 m². CKR Project will also include the planting of about 1,800 heavy standard trees and 685,000 shrubs, covering a planting area of about 54,600 m². Figures 5.1 to 5.2 show the proposed landscape decks and waterfront promenade, which will be provided with multi-function recreational facilities such as jogging trails and pavilions, to be constructed under CKR Project.



Figure 5.1: Landscape deck above yau ma tei interchange



Figure 5.2: ma tau kok waterfront promenade

- Preservation of built heritage

The Yau Ma Tei Police Station at West Portion of CKR is a Grade 2 Historic Building. The proposed side-by-side cut-and-cover tunnel avoids the old wing of the Police Station and the residential buildings at the south side of Kansu Street. For the affected New Wing of the Yau Ma Tei Police Station, we will carry out underpinning to preserve the structure.

- Mitigation measures to be adopted during construction phase

For the construction phase, good site practices would be adopted to reduce various environmental impacts. For example, the implementation of watering in all works areas would substantially suppress the generation of fugitive dust. The use of quiet plant and site hoarding, use of movable noise barriers, etc. will reduce the construction noise. The use of silt curtains and cage curtains will control the release of suspended solids during the reclamation phase.

2.5. Environmental Monitoring and Audit (EM&A) programme

A comprehensive EM&A programme will be implemented to oversee the environmental performance of the Project on various aspects including air quality, noise, water quality, and waste management, etc. on the neighbouring sensitive receivers. It provides a framework to identify and contain potential impacts, and apply appropriate measures to ameliorate them.

In accordance with the requirements of the Environmental Permit (EP) of CKR, an Environmental Team (ET) shall be established and an Independent Environmental Checker (IEC) shall be employed by HyD no later than one month before commencement of construction of the Project. The ET, ET Leader and IEC will ensure full compliance of environmental requirements during construction and operation of the CKR Project according to the EP.

HyD will also set up community liaison groups comprising representatives of affected parties, including local committees, residents and schools in the affected areas along the route alignment, to facilitate communications, enquiries and complaint handlings on environmental issues related to the Project. Respective community liaison teams and designated complaint hotlines shall be set up for the Project to address related concerns and enquiries in an efficient manner. HyD shall also follow up with the respective community liaison groups on the implementation of mitigation measures as necessary.

3. CONTINUING DEVELOPMENT IN SUSTAINABILITY

The Government of the Hong Kong SAR has always been an advocate of sustainable development and has capitalised on the opportunity to steer forward with various green approaches on public works projects. After the approval of the EIA of the CKR Project, HyD continue to incorporate environmental protection and sustainable elements into the Project.

A tree compensation proposal was developed to justify the need for any tree felling required to facilitate the CKR construction works.

To reduce the volume of disposal of marine sediment generated from the construction of cut-and-cover tunnels, it is proposed to reuse about 30,000 m³ land-based uncontaminated marine sediment with treatment by cement solidification such that the treated sediment is suitable for backfilling of excavated trenches.

The administration building of CKR will be designed as a sustainable building capable of meeting the relevant **requirements under the latest “Building Environmental Assessment Method for New Building” (BEAM Plus) of the Hong Kong Green Building Council.**

It is confident that through continuing efforts, the CKR Project could be further enhanced in a sustainable way.

4. CONCLUSION

The EIA process is a proactive planning tool to avoid and mitigate adverse environmental impacts that might be caused or experienced by the proposed development. This article highlights the importance of alignment selection of the CKR Project at the beginning of the project planning stage with an aim to avoiding adverse environmental consequences of the proposed Project. Approaches to minimize environmental impacts have also been integrated into the design as much as practicable. For those adverse environmental impacts that could not be fully avoided, measures have been proposed to reduce and control the possible adverse environmental impacts to within established limits or criteria. The environmental performance of the Project during its implementation will then be overseen in accordance with the EM&A programme. Through the EIA process, the Project was planned and designed by striking a balance between development and environmental conservation.

REFERENCES

- [1] Highways Department, January 2013, Agreement No. CE43/2010(HY) Central Kowloon Route – Design and Construction: Final Environmental Impact Assessment Report
- [2] Highways Department, February 2013, Agreement No. CE43/2010(HY) Central Kowloon Route – Design and Construction: Cogent and Convincing Materials for Temporary Reclamation at Kowloon Bay

A Comparison on Two Certification Systems: Leadership in Energy and Environmental Design (LEED) And Building Environmental Assessment Method (BEAM) On Green Building in Hong Kong

Ophelia CHU Ka-wai^a, Richard CHEUNG Yun-hing^b

^a City University of Hong Kong, Hong Kong SAR, kwochu2-c@my.cityu.edu.hk

^b City University of Hong Kong, Hong Kong SAR, bhricche@cityu.edu.hk

ABSTRACT

There are totally 53,432 buildings in Hong Kong, while 25% are public sector and 75% are private sectors, 1.5% of buildings have accredited or registered to BEAM plus certification system and 0.34% have accredited or registered to LEED certification system. And sharp increase of BEAM plus and LEED newly registered projects were record in 2010 and 2013 respectively pointed out the increased concern on green building in the recent years. Variety of research paper were focusing on the credits category and usefulness of LEED building, however there was a research gap showing the usefulness of the BEAM plus system. Therefore, in order to investigate the usefulness of two system, the differences between BEAM plus and LEED systems in the aspect of Water Management, Materials and Indoor Environmental Quality in this dissertation. The research findings based on the difference between two systems indicated the BEAM plus system was more suitable to Hong Kong which because of the BEAM plus has always subjected to adjustment immediately upon to any changes of the regulation of Hong Kong such as Water Quality Objectives due to the LEAD water incident. And the major problem of the government policy was the extra granting of GFA is going to further tightening the land supply in Hong Kong in the future. Therefore, recommendation on reduction of GFA and alternative incentives were presented for the government is also discussed in this paper.

Keywords: green building, BEAM Plus, LEED

1. INTRODUCTION

There was a close relationship between Green Building and sustainability building which has become the talk of the town in recent years, the public awareness was dramatically increased due to promotion in the public media (Zuo & Zhao., 2014). So in other words, green building was no longer a technical term used in the building industry but also well-known in the public (Eichholtz, Kok & Quigley., 2013) The concept of green building was more and more accepted in the public in such a few year, one of the reason should be came from the effort paid by the accreditation organization, the BEAM society and also the Hong Kong Government. Firstly, green building was promoted and encouraged in the building industry by the Hong Kong government in terms of granting gross floor area (GFA) concession ordinance from the building department (BD, 2014). Based on the commercial consideration, there was no argument that why more and more new buildings are adopting green building accreditation scheme in the building process.

Green building is not only the business of engineer but also planner, architecture, interior designer and construction management team yet certification systems are emphasizing the term of integrated process depended on the specialist in different area and considering the operation and maintenance issue in the design stage of the project (Mak, Janet & Dong, 2014). According to the Hong Kong Government, Green buildings different from the others due to efforts are paid on design, operation ecological management, resources management and renovation and building process to minimize the use of energy, water, and other possible resources and so that the overall impacts throughout the life cycle to the environment are therefore reduced (HKSAR Gov., 2015). Green building is also called sustainable building which rely on the simple and low-tech method and strategy such as adopting passive building design, application of highly efficient Mechanical Ventilation and Air Conditioning (MVAC), Electrical (EL), Pump and Drainage (P&D) which aimed in enhancing the energy saving and minimize greenhouse gases emission to protect the health of occupant and enhance productivity also reduce the waste generation at the same time so as to enhance the quality of building, minimize the environmental impacts and cost paid in life cycle and hence achieve sustainable construction (USGBC, 2014, Lockwood, 2006, Fowler & Rauch, 2006). Variety of accreditation schemes were established in all over the world since the late twentieth Century, like Leadership in Energy and Environmental Design (LEED) from United States, BRE Environmental Assessment Method (BREEAM) from

United Kingdom, Green Building Council of Australia Green Star (GBCA) from Australia, Green Mark Scheme from Singapore, Deutsche Gesellschaft für Nachhaltiges Bauen e.V. (DGNB) from Germany, Comprehensive Assessment System for Built Environment Efficiency (CASBEE) from Japan, Pearl Rating System for Estidama from Abu Dhabi, Building Environmental Assessment Method (BEAM) from Hong Kong, Green Building Index from Malaysia, 3-star from Mainland China. Among several of green building assessment, LEED and BEAM for new construction or building are going to be focused here.

Basically, various credit focus in different certification system include energy, water, indoor air quality, accessibility, transportation, materials, etc, also there is numerous of researches focus on the energy aspect which because it usually contribute to the largest portion of points in various scheme of certification system. However, relative lesser focus is found on water aspect where it should also play an important role in the sustainability of building as it contribute to the second largest portion of various scheme. Also, due to the scarcity of potable water is increasing in all over the world (Arup, 2014) and based on the Hong Kong situation, the reasonable price of potable water fee made water saving as one of the major public education issue of the government (WSD, 2009), therefore the water aspect should also play equal importance to contribute to the sustainability of building so will be discussed here. In addition, other aspects such as indoor air quality is also important due to the basic purpose of building project is for human beings to live or work and there is no argument that operation phase should be longer than other stage and cost up to 65% of the whole life cycle cost of the building (Dewar, 2004) therefore such aspect will also be mentioned here. Moreover, materials is the one of the most important elements for building project so how selection and management of construction materials made the project into environment friendly way is also trying to be discussed here. So, water aspect, materials aspect and indoor air quality aspect in LEED and BEAM system will be investigated here.

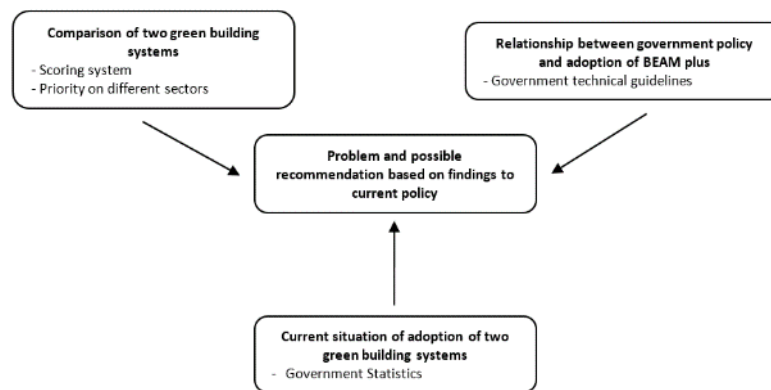

Figure 1.1 Research framework of this paper

1.1. Leadership in Energy & Environmental Design (LEED)

LEED was established in the March of 2000 by the U.S. Green Building council, which was the founded by Rick Fedrizzi, David Gottfried and Mike Italiano aimed in promotion of the concept of sustainability in the construction and building industry for the US department of Energy with strategy of market-driven. In the USGBC Membership Summit held in August 1998, the first version of manual called LEED 1.0 designed for new building was launched (USGBC, 2014) The latest version now is LEED version 4 (LEED v4) and available for the area of Building design and construction (BD+C), Interior design and construction (ID+C), Operation and Management (O+M), Neighborhood development (ND) and Homes (H) based on the function of the buildings. The decision on rating system based on the proportion of gross floor area by using 40/60 rules. contains base points of 100 which distribute in to five main categories that include Sustainable sites (SS), Location and Transportation (LT), Water efficiency (WE), Energy and Atmosphere (EA) and Indoor Air Quality (IAQ), plus 6 points from Innovation design (IN) and 4 points from regional priority, and 1 to 2 points from integrative process so come to 110 points in each rating system (USGBC, 2009, USGBC, 2016).

1.2. Difference of LEED and BEAM Plus in water management

Based on the credit criteria, both LEED and BEAM plus system on indoor water reduction are based on the specific calculation tool for water by establishing a case of baseline of water consumption and the prerequisites on reduction on water reduction but varied in the threshold. Also the parameter of indoor water reduction in LEED is only 1 credit

containing 2 points to be awarded while that is one of the prerequisite requirement. (Arup, 2014). And for the outdoor water reduction part LEED require 30% outdoor potable water reduction from base line, 50% for 1 points and 100% for 2 points, and for BEAM plus require not using portable water as irrigation sources and ideally reduce 50% water use on irrigation. And for the outdoor water reduction part. Also there is no credits on the fixture specification in LEED system but 1 point if using apparatus with Water Efficiency Labelling Scheme Grade 2 or above.

And the major difference of LEED and BEAM plus certification system is the approach of water management aspects and summarized below. In which LEED is always focusing on the minimizing the amount of the portable water use and also maintain the minimal use of water while the BEAM is comparatively multi-targets that put higher priority on the portable water quality and effluent treatment if available in the projects. Also the category focus of the LEED rating system itself is always stick on the project type while the further divided into residential and non-residential. Extra credits can be gained in the both of the two certification system while in LEED system shall award project with maximum two points for no cooling system as Pilot credits and for the BEAM plus system extra credits shall give to projects with treatment system for waste water as Innovation credits. Also the leakage monitoring is not concerned in the LEED system while BEAM plus pays attention on it.

The apparatus focused in both two system are similar however the LEED system only focus on the flow rate or volume per flush while the BEAM plus system considered the difference needs on water use in female and male so the sex ratio, the frequency is mentioned. Also the majority of estimated baseline value is lower except kitchen water tap data in LEED system compared to the BEAM plus system.

1.3. Difference of LEED and BEAM Plus in materials aspect

Based on the criteria of credits on the materials of LEED and BEAM plus described in the previous paragraph, both LEED and BEAM plus made focus on impacts generated by the raw materials along the life cycle in construction phase and also the management of waste in order to minimize the stress of waste treatment facilitates like landfills and incinerators. The LEED certification system takes focus on the waste management as the basic requirement on materials approach while BEAM certification beside waste management but also the use of Refrigerants that are CFCs based and also the timber not for permanent work. Also the maximum points achieve in LEED certification system is thirteen while twenty-two plus one bonus point in BEAM plus system. Moreover, the BEAM system takes more paragraph on the efficiency on the usage of materials while LEED system focus on the upstream declaration of the products that comprise to the majority of the points in such aspects through encouragement of purchasing products with recognized green labeling. Also both system require the place of product source extraction, manufactured within certain distance from the project site in which LEED system require 160km and where BEAM plus system require 800km from the site location.

1.4. Difference of LEED and BEAM Plus in indoor environmental quality aspect

The achievable point in the IEQ aspect of LEED and BEAM plus are 16 and 32+3B respectively. The major difference of IEQ aspect in LEED and BEAM plus is the credit focus area, both of them pay efforts on the health and comfortability of the occupants in the building but with slightly different focus. Besides LEED and BEAM plus both take the IAQ, lighting, acoustic and ventilation as serious issues, LEED also pay effort to the visual comfort of the environment around the building and BEAM plus decided to take care of the security and amenities facilities as part of IEQ aspect. And the LEED system are not ignoring the issues on amenities facilities and security but those issues are discussed in the Site Aspect (SA) credit category which will not be discussed here. Also the ventilation is one of major concern that directly related to the air quality and therefore pay an important role on transmitting pathogen of respiratory disease, it is found that the major standard for ventilation adopted by LEED and BEAM plus are same, ASHRAE 62.1 but with different version, the LEED system is adopting the 2010 version while the BEAM plus is adopting the 2007 version. Also besides the parameters in IAQ that the special health issues concern are different, while the LEED system straightly control the tobacco smoke in the building and the **BEAM plus took the control of Legionnaires' disease as important issue**. Moreover, final flush out process is critical for the IAQ of the building and therefore LEED and BEAM plus are both encourage the replacement of filter system/media followed by flush out process after completion of the construction and prior to the occupancy stage to ensure the indoor air quality is not affect by the residue particles in the construction stage.

2. CRITICAL EVALUATION ON LEED AND BEAM PLUS

USGBC (2015) pointed out that there was extra effort need to be paid by the developer on additional work procedure and alternative materials purchasing were required so as to build in a green way at the same time there is long term potential saving on the aspect of energy, water and maintenance. It is known that the developers may not concern on the environmental effects from building development so they are not willing to invest large portion into the green building part so according to survey done in the US stated that the maximum investment willing to pay for green building around 15% of total investment while for developer with incent of green building shall took up 0-5% more portion on this sector and their major concern is warranted cost premium through adopting green building measures and certification system (Burnett, et al, 2008). Also, Kats (2003) stated that the higher the level of project gained, the higher the cost of green building paid by the development so if Green building worth its value or just part of the corporate social responsibility (CSR).

In the economic aspect, the cost of green building based on the cost spent on certification system, measures done during design and construction phase and maintenance cost during operation phase while the benefits mainly came from energy reduction, water reduction, rent rate and occupied rate. Burnett et al (2008) concluded the average total building costs of standard was HK\$10,600/m², cost of services is HK\$2,550/m² in average and the estimated cost of fit-out is around HK\$5,170/m² based on the information at 2005. Burnett et al also pointed out that there 10% extra design cost was paid for the indoor environmental quality while Kats (2003) suggested 3-7% extra cost was paid for LEED projects achieving Silver to Platinum level and the average of extra cost on LEED buildings was around HK\$248.64 – 414.4/m² (\$3-5/ft²) (Unit transformation based on US\$1 = HK\$7.7 and 1sq2 = 0.09290304m²) For the performance on energy consumption is similar where LEED buildings conserve 10.5% to 42% energy while BEAM plus buildings conserve 10% to 45% (Lee, 2012). Estimated energy saving for LEED buildings was HK\$481.1/m² (5.8 US\$/sq2) and annual cost saving for BEAM plus building for offices and residential were HK\$1.6/m² and HK\$0.4/m². And for the water aspect, additional cost on monitoring was up to HK\$2 – 10/m² however upon appropriate equipment like closets that are valveless cistern and dual flush or Infra-red sensors, the estimate water saving could be 16-50%. The annual saving of water consumption per construction floor area (CFA) for offices and residential are HK\$1.8/CFA and HK\$20/CFA respectively (Burnett et al, 2008) and HK\$3.85 (US\$0.5) for LEED buildings (Kats, 2003). Moreover, Miller, Spivey & Florance (2008) pointed out LEED certified building with higher in direct rental rate, higher in occupied rate and lower in maintenance expense therefore resulted 10% positive impact on the sales price per square feet however no such information could be found in BEAM plus buildings.

And based on the situation of Hong Kong, a series of regulation set by the government which include Practice Note for Authorized Persons, Registered Structural Engineers and Registered Geotechnical Engineers APP-151 (BD, 2014) stated the regulation for GFA concession that including the following parts, i) Sustainable building design guidelines (SBD Guidelines), ii) Gross floor area (GFA) concessions, iii) Energy efficiency of buildings. APP-151 work closely with APP 122, APP-152 and Green Features under Joint Practice Notes (JPN 1&2) (BD, 2014). The package of regulation document clearly stated the requirement of earning extra 10% of GFA concession by fully adopting BEAM plus in any new building projects, and therefore developer are able to earn more through selling the addition GFA granted by the government (Fan, 2015). Therefore, the risk of the energy, water efficiency saving not as expected, and the cost is still partially or fully compensated on the GFA concession. Li & Liu (2013) reported the number registered BEAM plus projects from 2010, the year of introduction of GFA concession announced by the government, was 210, then become 225 in 2011 and 300 in 2012, which indicated the successfulness of the GFA concession and related regulation. Also the human working or living in the green building is also benefited through the better control of indoor air quality, and resulted in better health condition of the occupants by reducing respiratory illness, allergies and asthma, symptoms on sick building syndrome and improved performance from the thermal and light regulation done before occupancy stage (Ries et al, 2006) and billions of US dollars was estimated to save by maintain the health of occupants (Fisk, 2002) but lacking of information focusing on BEAM plus buildings on such area in Hong Kong therefore more studies shall be done in the future to investigate the usefulness of BEAM plus certification system.

The retailers companies started to promote green marketing to enhance the socially responsible manner not only for fulfilling the obligations of ethnical and also for enhancement on marketing performance resulted from the response of consumer to corporate social responsibility (CSR) (Ko, Hwang & Kim, 2013). Environmental concerns and the demand for green products of customers in Korea is the pulling force behind the blooming of green marketing (Ko, Hwang & Kim, 2013). In facts, there should be quarter of customers in Hong Kong do concern on the environmental issues, therefore the adoption of green building certification system should definitely increase

the attraction of the product such as residential building. Based on the information found, it was found that less statistic information related to BEAM plus building could be found compared to LEED buildings therefore there was room of improvement on information transparency of BEAM plus buildings in the future. Also, large amount of researches were focusing on effectiveness, cost and benefits analysis on LEED system in different aspects than BEAM plus which made difficulty on comparing on the effectiveness of LEED and BEAM plus system. Stronger evidence found on LEED system benefit on both commercial and social way that might be due to the longer history on LEED than BEAM plus system. However, the BEAM plus is also chosen by the Hong Kong Government because of the standard adopted is closely stick to the regulations of Hong Kong, table 3.4 stated the changes of the minimum requirement on portable water in recent year was stick to the WQO of WSD based on the current situation of Hong Kong. No matter which green building certification system was adopted by the building, the sustainability was also fully achieve because both environmental, social and economic were benefited from the effort pay on green building. The major reason on well adoption of BEAM plus was due to the promotion of Hong Kong Government, but it really served as good starting point of green building development in Hong Kong and showed the incentives of the industry but further development will be rely on the professionals in the field to push it forward in the coming future.

3. DISCUSSION

There must be no argument that, the development of green building system is more competitive than other Asia country as we are the only city having our own certification system, BEAM plus which originated in Hong Kong. The HKGBC has played the most important effort on initiate, modify and promoting the BEAM plus certification system with the green building policy aided by the Government. The initiation of incentives of green building stage is fully done and the next step of the green building policy should be restricted, fine tune and become more aggressive so that more green buildings in Hong Kong to help contributing to positive impacts to the environmental problems in Hong Kong.

In my opinion, the APP-151 is a good measures to introduce, encourage and facilitate the green building development in Hong Kong, and based on the fact that 435 ongoing BEAM plus projects out of 790 total registered projects which meant the ongoing green building projects were almost half of the total projects has proven that the BEAM plus system is well-known and absorbed by the industry. However, Development Bureau (2011) stated that there is extra 40% GFA areas with high density, 67% in area with medium-density, and 57% in area with low-density zone, which further worsen the density situation of Hong Kong. To avoid the worsen situation occurred in the coming future, the APP-151 could considered to be enhanced by step by step to achieve further development of green building in Hong Kong. Taking the example in Singapore, the GFA concession was also based on the level of BCA Green Mark achieved, only project with level higher than gold achieve up to 1% GFA concession (Chong, 2007). Therefore, the gradual GFA concession according to the BEAM plus certification level gained can be adopted, for example 3% for bronze projects, 5% for silver project, 8% for gold projects and 10% for Platinum projects or even totally cut off and compensate by others incentives.

In addition, common adoption of BEAM plus system in the industry should only be one of the milestone of green building development in Hong Kong as it was not yet mandatory. Besides, Fan (2015) pointed out that the Joint Practice Notes (JNP) was also set up by the government to facilitate green building design by encouraging the maximize use of resources on renewable energy and materials for green building so as to minimize the use of energy not renewable and therefore the waste generated by construction can be reduced. The following table 4.1 shows the mandatory regulations on Green building in Hong Kong, in which only part of the BEAM plus system, energy use was restricted by the government. And taking Singapore, the most similar country to Hong Kong in Asia, has already pushed their green building certification system. Green Mark into registration with financial penalty and therefore no longer voluntary adoption since 2008 (Chong, 2007). For every new building projects in Singapore, there was requirement on Minimum Green Mark score and relevant Green Mark Certification and minimum Green Mark standard for existing building stated in the Building Control (Environmental Sustainability) Regulations since April 15 in 2008 so as to achieve 80% of Singapore Buildings with Green Mark by 2030 (BCA Singapore, 2016, Chong, 2007). Therefore that should further encourage the numbers of green buildings in Hong Kong in the future if the adoption of BEAM plus system became mandatory.

Moreover, tax return is also stagey shall be adopted by the government, taking the example in Cincinnati, up to 500,000 US dollars of property tax rebate for 15 years was provided building adopting LEED certification system

(Miller, Spivey & Florance, 2008), however, the 2015/2016 property tax rate of Hong Kong in was 15% (HKgov, 2016) while in US was 0.55% to 2.38% different in states and that pointed out was the property tax contribute to great income to the Hong Kong government therefore it might not be feasible for all green buildings but for those projects achieving a higher level for example Platinum to increase the incentives of encouragement on achieving higher level in BEAM plus system.

The enhancement mentioned above possibly motivate developer to paid larger investment portion on the green building portion. Therefore, the government is recommend to adjust the percentage on GFA concession and can be changed to property tax rebate instead to maintain the incentive to developer.

In addition, based on the increasing trend of the LEED projects in Hong Kong, and researches stated that 25-30% of energy saving, 10 times of productivity enhancement (Kats, 2003., Miller, Spivey & Florance, 2008) in those buildings, the government shall also consider to adopt the LEED certification system into the GFA concession policy, to serve as another option of certification system can be provided to the construction industry. Also, the BEAM plus certification should be continuously promoted.

4. CONCLUSION

In conclusion, the adoption of green building certification system was now the global trend in the world, the difference between LEED and BEAM plus system are found in scoring system, approaches and priority of different sectors and the target parties. The higher adoption rate of BEAM plus system than LEED system is mostly related to the policy of GFA concession which also tighten the land supply in the future. Alternative concession based on findings and example of Singapore has been suggested to adjust the current policy so as to balance the adoption of green building system and limited land supply in Hong Kong.

REFERENCES

- [1] BEAM Society Limited. (2014). BEAM Plus Framework and Innovation. [URL] <http://www.beamsociety.org.hk/files/download/download-20140702154450.pdf> [Retrieved on January 17, 2016]
- [2] Bloom, B., Nobe, M., & Nobe, M. (2011). Valuing Green Home Designs: A Study of ENERGY STAR® Homes. *Journal of Sustainable Real Estate*, 3(1), 109-126.
- [3] Buildings Department, Hong Kong Government, (2009), Practice Note for Authorized Persons, Registered Structural Engineers and Registered Geotechnical Engineers, PNAP No. APP-35 Refuse Storage and Collection Building (Refuse Storage and Material Recovery Chambers and Refuse Chutes) Regulations. [URL] <http://www.bd.gov.hk/english/documents/pnap/APP/APP035.pdf>
- [4] Buildings Department, Hong Kong Special Administrative Region, (2014) Practice Note for Authorized Persons, Registered Structural Engineers and Registered Geotechnical Engineers APP-151, Building Design to Foster a Quality and Sustainable Built Environment
- [5] Burnett, J., Chau, C. K., Lee, W. L., & Edmunds, K. (2008). Costs and financial benefits of undertaking green building assessments: final report.
- [6] Burnett, J., Chau, C. K., Lee, W. L., & Edmunds, K. (2008). Costs and financial benefits of undertaking green building assessments: summary report of the CII-HK research project.
- [7] Chow, W. T., & Brazel, A. J. (2012). Assessing xeriscaping as a sustainable heat island mitigation approach for a desert city. *Building and Environment*, 47, 170-181.
- [8] EIA (U.S. Energy Information Administration) online data base. Total Energy. (2016). [URL] <http://www.eia.gov/totalenergy/data/annual/index.cfm#consumption> [Retrieved on 15 January, 2016]
- [9] EIA (U.S. Energy Information Administration). Energy in Today., (2013). [URL] [http://www.eia.gov/todayinenergy/detail.cfm?id=10271&src=%E2%80%B9%20Consumption%20%20%20%20Residential%20Energy%20Consumption%20Survey%20\(RECS\)-b1](http://www.eia.gov/todayinenergy/detail.cfm?id=10271&src=%E2%80%B9%20Consumption%20%20%20%20Residential%20Energy%20Consumption%20Survey%20(RECS)-b1) [Retrieved on 15 January, 2016]
- [10] Eichholtz, P., Kok, N., & Quigley, J. M. (2013). The economics of green building. *Review of Economics and Statistics*, 95(1), 50-63.
- [11] Environmental Protection Department. Hong Kong Government., (1996), Practice Notes for Professional Persons. ProPECC PN 2/96. Control of Air Pollution in Car Parks.
- [12] Fenner, R. A., & Ryce, T. (2008). A comparative analysis of two building rating systems Part 1: Evaluation. *Proceedings of the ICE-Engineering Sustainability*, 161(1), 55-63.

- [13] Fowler, K. M., & Rauch, E. M. (2006). Sustainable building rating systems summary (No. PNNL-15858). Pacific Northwest National Laboratory (PNNL), Richland, WA (US).
- [14] Gowri, K. (2004). Green building rating systems: An overview. *ASHRAE journal*, 46(11), 56
- [15] Guo, H., Lee, S., Chan, L. Y., & Li, W. M. (2004). Risk assessment of exposure to volatile organic compounds in different indoor environments. *Environmental Research*, 94(1), 57-66.
- [16] Hong Kong Green Building Council, (2012), BEAM Plus Project Assessment Process. URL: [http://www.beamsociety.org.hk/files/BEAMPlus_AssessmentProcess\(12032012\)_v3.4.pdf](http://www.beamsociety.org.hk/files/BEAMPlus_AssessmentProcess(12032012)_v3.4.pdf) [Retrieved from January 18, 2016]
- [17] Hong Kong Green Building Council, (2012). BEAM Plus Project Assessment Process - BEAM Society. URL: [http://www.beamsociety.org.hk/files/BEAMPlus_AssessmentProcess\(12032012\)_v3.4.pdf](http://www.beamsociety.org.hk/files/BEAMPlus_AssessmentProcess(12032012)_v3.4.pdf) [Retrieved on January 25, 2016]
- [18] Huang, L., Zhu, Y., Ouyang, Q., & Cao, B. (2012). A study on the effects of thermal, luminous, and acoustic environments on indoor environmental comfort in offices. *Building and Environment*, 49, 304-309.
- [19] Johns, R. A., Smucker, T. A., Mustafa, D., Dorsey, J., Connelly, S. M., & Krest, J. M. (2007). Xeriscaping as coastal amelioration: using 'Florida Friendly landscaping' to reduce pollutant runoff and water consumption in Pinellas County, Florida. *Interdisciplinary Environmental Review*, 9(2), 113-140.
- [20] Kats, G. (2003). *Green building costs and financial benefits*. Boston, MA: Massachusetts Technology Collaborative.
- [21] Lee, Y. S., & Guerin, D. A. (2009). Indoor environmental quality related to occupant satisfaction and performance in LEED-certified buildings. *Indoor and Built Environment*, 18(4), 293-300.
- [22] Lockwood, C. (2006). Building the green way. *Harvard business review*, 84(6), 129-137.
- [23] Mahbob, N. S., Kamaruzzaman, S. N., Salleh, N., & Sulaiman, R. (2011). A correlation studies of indoor environmental quality (IEQ) towards productive workplace. In 2nd International conference on environmental science and technology IPCBEE (Vol. 6).
- [24] Montgomery, D. D., & Kalman, D. A. (1989). Indoor/outdoor air quality: reference pollutant concentrations in complaint-free residences. *Applied industrial hygiene*, 4(1), 17-20.
- [25] Poon, C. S., Ann, T. W., & Ng, L. H. (2001). On-site sorting of construction and demolition waste in Hong Kong. *Resources, conservation and recycling*, 32(2), 157-172.
- [26] **Prevention of Legionnaires' Disease Committee. Electrical and Mechanical Services Department, Hong Kong Government., (2007), Code of Practice for the Prevention of Legionnaires' Disease in Hong Kong.** URL: http://www.emsd.gov.hk/emsd/e_download/pps/code.doc [Retrieved on 10th April, 2016]
- [27] Reeder, L. (2010). Leed for Homes. *Guide to Green Building Rating Systems: Understanding LEED, Green Globes, Energy Star, the National Green Building Standard, and More*, 49-72.
- [28] Sundell, J. (2004). On the history of indoor air quality and health. *Indoor air*, 14(s7), 51-58.
- [29] U.S Green Building Council, (2011). LEED 2009 Rating System Selection Guidance version 4. URL: <http://www.usgbc.org/sites/default/files/LEED-2009-Rating-System-Selection-Guidance.pdf> [Retrieved on January 6, 2016]
- [30] U.S Green Building Council, (2013). Infographic: LEED in the World. URL: <http://www.usgbc.org/articles/infographic-leed-world> [Retrieved on January 6, 2016]
- [31] U.S Green Building Council, (2014). LEED v4 Rating System Selection Guidance. URL: <http://www.usgbc.org/articles/rating-system-selection-guidance> [Retrieved on January 6, 2016]
- [32] U.S Green Building Council, (2016). BD+C | U.S. Green Building Council. URL: <http://www.usgbc.org/guide/bdc> [Retrieved on January 12, 2016]
- [33] U.S. Green Building Council, (2014). LEED v4 Rating System Selection Guidance. URL: <http://www.usgbc.org/articles/rating-system-selection-guidance> [Retrieved on January 5, 2015]
- [34] U.S. Green Building Council. (2009). *Green building and LEED core concepts guide LEED® Core Concepts Guide: An Introduction to LEED and Green Building (3rd Edition)*. (2014). Washington, DC: U.S. Green Building Council.
- [35] **U.S. Green Building Council., (2013) GSA's Green Building Advisory Committee Recommends LEED for all GSA Buildings.** URL: <http://www.usgbc.org/articles/gsa's-green-building-advisory-committee-recommends-leed-all-gsa-buildings> [Retrieved on January 6, 2016]
- [36] UNECE/FAO. (2009). *Forest products annual market review 2014–2015*.
- [37] Welch, A., Benfield, K., & Raimi, M. (2010). *A Citizen's Guide to LEED for Neighborhood Development: How to Tell If Development is Smart and Green*. US Green Building Council.
- [38] Zhang, Y. (2005). *Indoor air quality engineering*. Boca Raton, FL: CRC Press.

- [39] Zuo, J., & Zhao, Z. Y. (2014). Green building research—current status and future agenda: A review. *Renewable and Sustainable Energy Reviews*, 30, 271-281.
- [40] American Society of Heating, Refrigerating and Air Conditioning Engineers (ASHRAE). (2001). *ASHRAE Fundamentals Handbook Chapter 26*. Atlanta
- [41] American Society for Testing Materials. Pasadena USA. (2000). ASTM E 741-00. Standard Test Method for Determining Air Change in a Single Zone by means of a Tracer Gas Dilution
- [42] DW 143. A practical guide to Ductwork Leakage Testing. Heating and Ventilating Contractors Association. 1994
- [43] International Standard Organization. (2003). ISO2631-2. Evaluation of human exposure to whole-body vibration – Part 2: Continuous and shock-induced vibration in buildings (1 to 80Hz)
- [44] Buildings Department. Hong Kong Government. (2009) Practice Note for Authorized Persons, Registered Structural Engineers and Registered Geotechnical Engineers, PNAP No. ADV-25 Extractor Fans in Bathrooms and Lavatories in Domestic Buildings. URL: <http://www.bd.gov.hk/english/documents/pnap/ADV/ADV025.pdf> [Retrieved on 21st March, 2016]
- [45] Buildings Department. Hong Kong Government. (2009) Practice Note for Authorized Persons, Registered Structural Engineers and Registered Geotechnical Engineers, PNAP No. APP-8. Chimneys and Flues. URL: <http://www.bd.gov.hk/english/documents/pnap/APP/APP008.pdf> [Retrieved on 1st April, 2016]
- [46] American Society of Heating, Refrigeration and Air-conditioning Engineers (ASHRAE). (2004). ASHRAE 55-2004: Thermal Environmental Conditions for Human Occupancy.
- [47] The Chartered Institution of Building Services Engineers (CIBSE). (2014). Lighting Guide LG10. Daylighting and window design.
- [48] Commission Internationale de l'Eclairage (CIE). (2001). Lighting of Indoor Work Places. CIE Standard S 008/E.
- [49] Commission Internationale de l'Eclairage (CIE). (1995). Discomfort Glare in Interior Lighting. CIE 117-1995.
- [50] The Chartered Institution of Building Services Engineers (CIBSE). (2004). Code for interior lighting. London. CIBSE.
- [51] Illuminating Engineering Society of North America (IESNA). (2000). Lighting Handbook, Reference & Applications. 9th edition. New York
- [52] International Standard Organization. (1998). ISO 140-4: 1998. Acoustics - Measurement of sound Insulation in buildings and of building elements. Part 4: Field measurements of airborne sound insulation between rooms.
- [53] ASTM International. (1997). Designation E 336 – 97. Standard Test Method for Measurement of Airborne Sound Insulation in Buildings.
- [54] International Standard Organization. (1996). ISO 717-1. (1996). Acoustics – Rating of sound Insulation in buildings and of building elements. Part 1 – Airborne sound insulation.
- [55] ASTM International. (2004). Designation: E413 – 04. Classification for Rating Sound Insulation.
- [56] International Standard Organization. (2004). ISO 140-7. Acoustics - Measurement of sound Insulation in buildings and of building elements. Part 7: Field measurements of impact sound insulation of floors.
- [57] ASTM International. (1997). Designation: E 1007 – 97. Standard test method for field measurement of tapping machine impact sound transmission through floor-ceiling assemblies and associated support structures.
- [58] International Standard Organization. (2013). ISO 717-2. Acoustics – Rating of sound Insulation in buildings and of building elements. Part 2 – Impact sound insulation.
- [59] ASTM International. (1999). Designation: E 989 -89. Standard Classification for determination of impact Insulation Class (IIC)
- [60] British Standard Institution. (2014). BS 8233 Code of Practice for sound insulation and noise reduction for buildings.
- [61] Building Department, Hong Kong Government. (2005). Code of Practice for Barrier Free Access. URL: http://www.info.gov.hk/bd/english/documents/code/e_bfa.htm [Retrieved on 11th April 11, 2016]
- [62] International Organization for Standardization. (2003). ISO 2631-2. Mechanical vibration and shock: Evaluation of human exposure to whole-body vibration—Part 2: Vibration in buildings (1 Hz to 80 Hz).
- [63] International Organization for Standardization. (1997). ISO 2631-1. Mechanical vibration and shock: Evaluation of human exposure to whole-body vibration-Part 1: General requirements
- [64] Mak, M. Y., Janet, X. G., & Dong, W. (2014). Sustainability Rating Tools and Measurement: A Pilot Study. 20th Pacific Rim Real Estate Society Conference

- [65] Ding, G. K. (2008). Sustainable construction - The role of environmental assessment tools. *Journal of environmental management*, 86(3), 451-464.
- [66] Ove Arup & Partners Ltd. for CoreNet Global. (2014). International Sustainability SYSTEMS Comparison - Key International Sustainability Systems: Energy and Water Conservation Requirements. URL:
- [67] http://publications.arup.com/~media/Publications/Files/Publications/I/International_Sustainability_Systems_Report.ashx [Retrieved April 15, 2016]
- [68] Water Conservation. (2009). In: Official Website of Water Supply Department, Hong Kong Government, URL: http://www.wsd.gov.hk/en/education/water_conservation/index.html [Retrieved on April 3, 2016]
- [69] Lee, W. L. (2013). A comprehensive review of metrics of building environmental assessment schemes. *Energy and Buildings*, 62, 403-413.
- [70] Building Department of Hong Kong, (2014). Practice Note for Authorized Persons, Registered Structural Engineers and Registered Geotechnical Engineers, APP-151, Building Design to Foster a Quality and Sustainable Built Environment. URL: <http://www.bd.gov.hk/english/documents/pnap/APP/APP151.pdf> [Retrieved on April 12 2016]
- [71] FAN, K. (2015). Floor area concession incentives as planning instruments to promote green building: a critical review of international practices.
- [72] Miller, N., Spivey, J., & Florance, A. (2008). Does green pay off?. *Journal of Real Estate Portfolio Management*, 14(4), 385-400.
- [73] Ries, R., Bilec, M. M., Gokhan, N. M., & Needy, K. L. (2006). The economic benefits of green buildings: a comprehensive case study. *The Engineering Economist*, 51(3), 259-295.
- [74] **Fisk, W.J. (2002) "How IEQ affects health, productivity." ASHRAE Journal, Vol. 44, No. 5, pp. 56–60**
- [75] Ko, E., Hwang, Y. K., & Kim, E. Y. (2013). Green marketing' functions in building corporate image in the retail setting. *Journal of Business Research*, 66(10), 1709-1715
- [76] Geng, Y., Dong, H., Xue, B., & Fu, J. (2012). An overview of Chinese green building standards. *Sustainable Development*, 20(3), 211-221.
- [77] Building and Construction Authority (BCA). (2008). BCA Green Mark Scheme. URL: http://www.bca.gov.sg/GreenMark/green_mark_buildings.html [Retrieved on 24 April 2016]
- [78] Green Building Labelling Q & A, (2016), History of Green Building Labeling., URL: http://twgbqanda.com/english/e_history.php?Type=1 [Retrieved on 24 April 2016]
- [79] Murakami, S., Kawakubo, S., Asami, Y., Ikaga, T., Yamaguchi, N., & Kaburagi, S. (2011). Development of a comprehensive city assessment tool: CASBEE-City. *Building Research & Information*, 39(3), 195-210.
- [80] Lee, W. L. (2012). Benchmarking energy use of building environmental assessment schemes. *Energy and Buildings*, 4bnhjb5, 326-334.

Research on Emission Evaluation Classification of Healthy Green Building Materials Label in Taiwan

CHEN Cheng-chen^a, LEE Ching-chang^b, CHEN Jui-ling^c

^a Department of Interior Design, Tung Fang Design Institute, Taiwan, coolhas2000@yahoo.com.tw

^b Department of Environmental Occupational Health, National Cheng Kung University, Taiwan, clee@mail.ncku.edu.tw

^c Architecture and Building Research Institute, Ministry of Interior, Taiwan, crr@abri.gov.tw

ABSTRACT

Under the subtropical climate of Taiwan, indoor building materials have a significant impact on the in-door air quality, which leads to health problems and increased risks of cancer. Currently, the “Green building materials labels” and the Indoor Air Quality Act have been promoted to control the source of pollution, namely the fugitive pollutants of building materials and the air concentration in the indoor space. This study adopted the fugitive emission database of 645 pieces of building materials with a green label, test and verification of fugitive emission of 7 small pieces of building materials, numerical statistics and analysis, and literature analysis to research the emission evaluation classification of fugitive TVOC from green building materials label in Taiwan. The result shows **newly emission evaluation classification of Healthy Green Building Materials Label is “E1 (less than 0.005 mg/m²* hr), E2(0.005-0.06 mg/m²* hr), and E3(0.06-0.19mg/m²* hr)”**.

Keywords: green construction technology, green building management, indoor environmental quality

1. INTRODUCTION

According to the survey (P.C. Wu, et al., 2003), indoor formaldehyde and VOCs concentrations are relatively high in Taiwan due to the hot and humid climate, emission of chemical substances in interior building materials, and lack ventilation, thus causing high health risk hazards. Formaldehyde and volatile organic compounds (VOCs) are **Specifically the main pollutants in indoor, which negatively influence people’s health, comfort and productivity (Kim et al., 2001; Godish, 2001)**. It has been found that various building materials are sources of indoor formaldehyde and VOCs (Cox et al., 2002). Moreover, there is also evidence that building materials can act as a sink of formaldehyde and VOCs by sorption, and the re-emission of sorbed formaldehyde and VOCs can dramatically elevate indoor concentrations for months or even years (Tichenor et al., 1988; Sparks et al., 1994). Under the subtropical climate of Taiwan, indoor building materials have a significant impact on the poor indoor air quality, which leads to health problems and increased risks of cancer. Currently, the “Green building materials labels(GBMLs)” and the Indoor Air Quality Act have been promoted to control the source of pollution, namely the fugitive pollutants of building materials and the air concentration in the indoor space. Emphasis is placed on advanced administrative control of total volatile organic compound (TVOC) to reduce the harm of fugitive pollutants of indoor building materials to health.

4.1 The green building materials label in Taiwan

The Green building material (GBM) labelling system of Taiwan proposed by the Architecture and Building Research Institute was officially launched in 2004 to systematically and effectively evaluate the performance of green building materials. The connotation of the GBM Label is mainly to enhance the built environment and to provide the actual benefit toward the concept of human health and earth sustainability. The system carries out quantitative assessments and laboratory tests based on a variety of measures in different stages of the life cycle of a building. Its criteria and standards are established accommodating with the subtropical climatic condition. In addition, the **regulation of at least 45% mandatory green building material utilization has also been involved into Taiwan’s Building Code and become effective since 2011**. The GBM system covers four major aspects, including Health, Ecology, Recycling, and High-performance. The Healthy GBM for improving the indoor environmental quality requires low emission, odor free, and no asbestos. The Ecological GBM typically includes low toxicity processing and natural materials without shortage crisis. The Recycling GBM aims to reduce wastes and to reuse abandoned materials and recycling aggregates. As for High-performance, it basically refers to the materials with high permeability and high noise insulation. By the end of July 2016, 1,589 Labels have been conferred covering 11,016 green products. Among these products, the healthy material occupies 74%, and followed by the high-performance category 16%, recycling 9.2%, and ecological 0.8%.

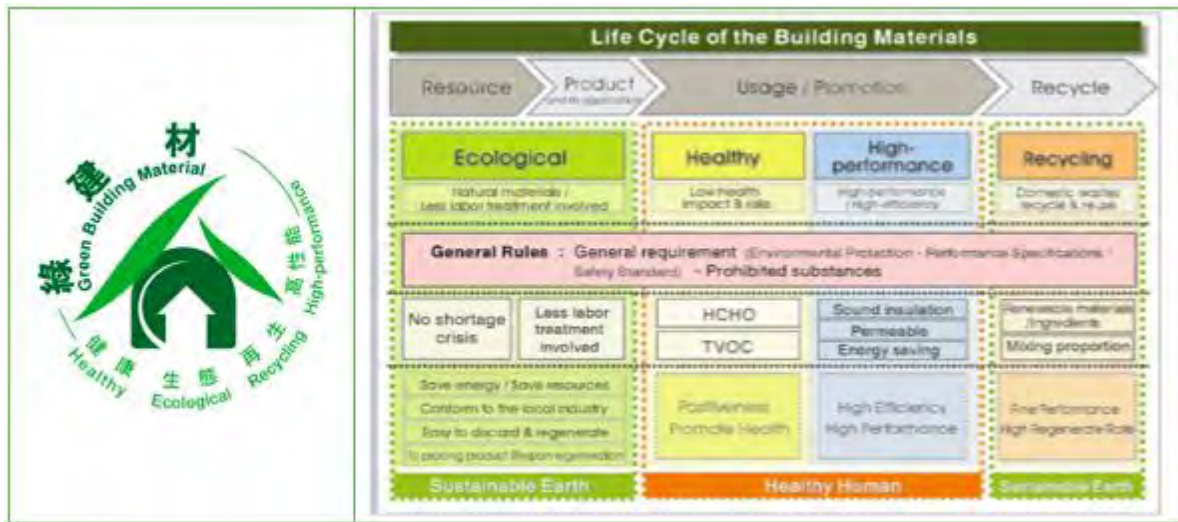

Table 1: The green building materials label in Taiwan

4.2 The emission evaluation classification of healthy green building materials label

Since formaldehyde contained in building materials, and VOCs added during the production of indoor construction materials, application and glue preparation, under the climate condition of high temperature and humidity, harmful chemical substances may be emitted in the air and directly affect human health and indoor environmental quality. Thus, the system focuses on the management and control of the relevant hazards. The test is based on ISO16000, and the standard is HCHO is less than 0.08 mg/m²·hr and TVOC less than 0.19 mg/m²·hr. The Emission Evaluation Classification of Healthy Green Building Materials Label has 3 emission levels (E1, E2, E3).

Health-GBML levels	Emission evaluation Classification TVOC (BTEX substance.)
E1	TVOC ≤ 0.005 mg/m ² ·hr
E2	0.005 < TVOC ≤ 0.1 mg/m ² ·hr
E3	0.1 < TVOC ≤ 0.19 mg/m ² ·hr

Table 2: The health GBMs TVOC emission evaluation classification

2. RESEARCH METHOD AND EXPERIMENTAL

Based on the data from the “fugitive emission database of green building materials” (645 products), this study conducted statistical analysis on normal distribution to learn the distribution of the emission levels (E1, E2, E3) in the green materials and discuss emission evaluation factor control standard and grading method. Test was conducted on fugitive VOCs of 7 small pieces of building materials using the small-scale building materials emissions test method (ASTM D5116-03, ISO 16000) and indoor air quality test methods (NIEA-A715.14B, NIEA-A714.11C, NIEA-A705.11C), in order to verify the “evaluation Classification standard and grading method of TVOC emissions from green building materials”.

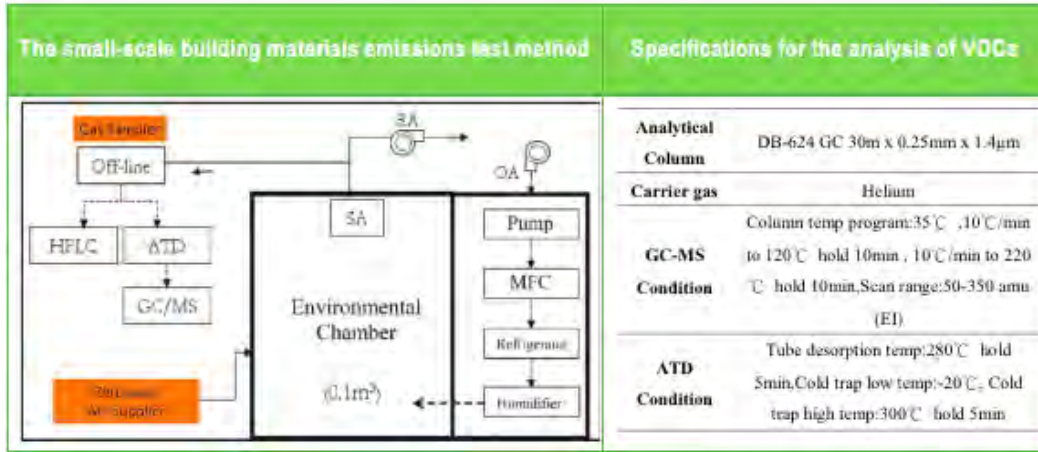

Table 3: The small-scale building materials emissions test method

2.1 The statistical analysis method

This study adopted the fugitive emission database of 645 pieces of green building materials label. The statistical analysis result shows as Table 4.

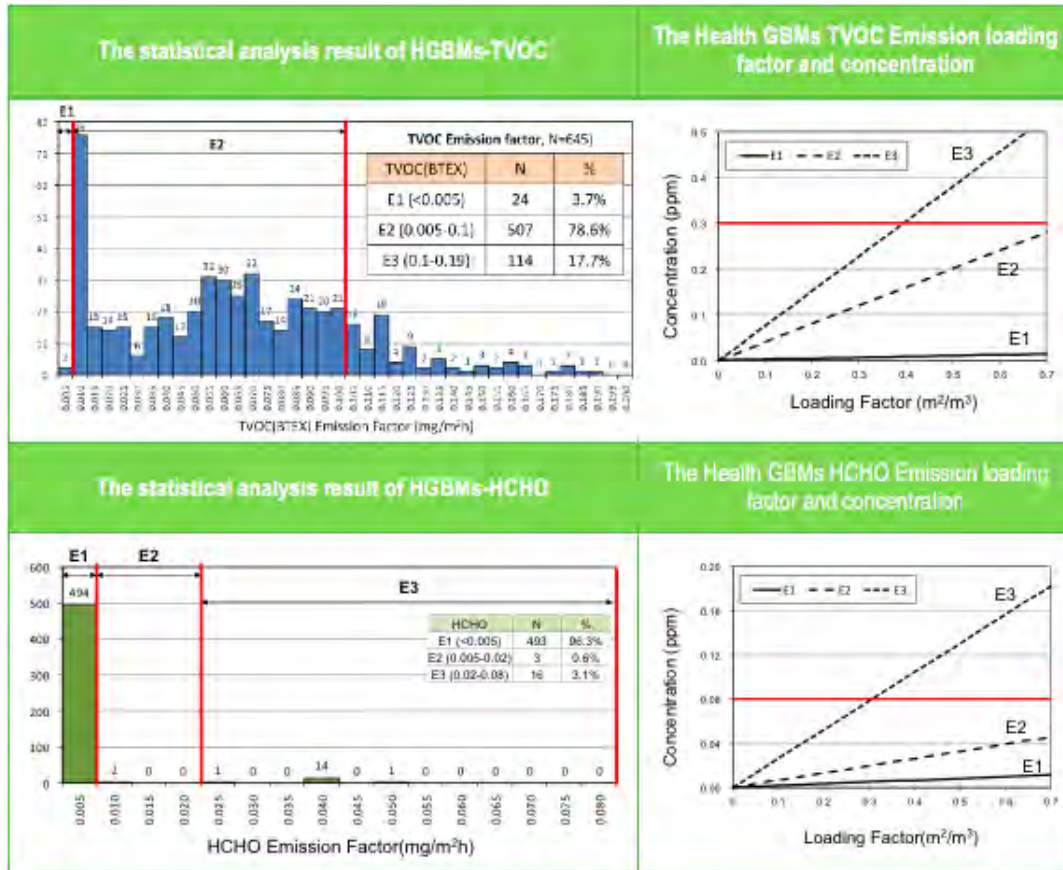

Table 4: The statistical analysis result of HGBMs-TVOC

2.2 Experiments and materials

This study selected paint with a building materials label for analysis, sampled 7 small pieces of paint for an emission test, and conducted a 48-hour qualitative and quantitative analysis. Based on ISO 16000 (part-9,3,6) and ASTM-D5116 standards, this study used the chamber experiment to conduct the building material effusion test. In the 48-hour test under the conditions of temperature of 25°C, relative humidity of 50%, air exchange of 0.5 ACH and loading factor is 0.4 (m²/m³)

Specimen NO.	Building Materials	Experiment
S1	water-soluble cement paint	HGBMs Under 25 °C、50%RH、0.5 ACH、L.F. 0.4 (m ² /m ³) for 48hr
S2	latex paint	
S3	Flameproof paint	
S4	Wood paint	
S5	Epoxy paint	
S6	latex paint	Non-HGBMs
S7	Wood paint	

Table 5: The experiment of building materials emission test

The mass concentration of the compound in the reference room air is calculated by means of the following equation:

$$C_R = \frac{SER_A L_{AR}}{AC_R}$$

Equation 1

Where, CR is the mass concentration of compound a in the air of the reference room, in micrograms per cubic meter, SER_A is the area specific emission rate in m, in micrograms per square meter and hour(emission factor),L_{AR} is the loading factor in the reference room, in square meter sample per cubic meter reference room, AC_R is the hourly air change rate in the reference room, in air changes per hour.

3. RESEARCH RESULTS

Five coating materials obtaining Green Building Materials Mark and 2 general paint materials (with-out Green Building Materials Mark) are sampled in this research for TVOC emission experiment. There 7 coating materials are tested for 48h under standard test conditions (25°C, 50% RH, 0.5 ACH, Loading Factor 0.4 m²/m³). Emission test of indoor paint materials shows that evaluation factor BTEX of green paint materials is extremely low and consistent with evaluation reference, however, the other VOCs matters emit largely.

Under the test of S1 building material (water-soluble cement paint) for 48h, the emission matter is used for qualitative and quantitative analysis through GC/MS. Emission concentration and rate of TVOC (BTEX) conform to the standard of Green Building Materials Mark. However, other VOCs matters emit continuously or the posterior concentration of emission increases.

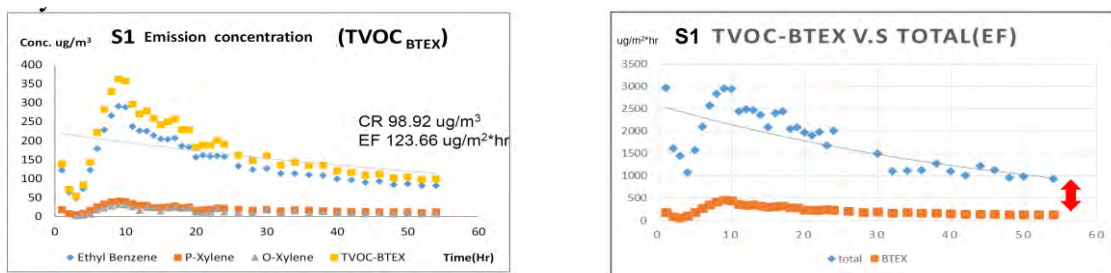

a) S1 BTEX concentration, b) S1 TVOC and BTEX emission factor

Indicated by the evaluation results based on R=CR/LCI of CEN/TS 16516, estimated emission concentration of TXIB is 4.4 times than R value. Estimation factor BTEX of Green Building Mark is extremely low and consistent with the assessment basis, the emission concentration of which is 98.9 (ug/m²·hr), i.e. 123.6(ug/m³). However, the other TOTAL VOCs matters emit largely and continuously. The two has 10 times difference.

VOCs	48Hr ug/m ³	LCI ug/m ³	R<1
Nonanal	2.9	1300	0.0022
Benzaldehyde	69	90	0.7667
Acetic acid, butyl ester	24.1	4800	0.0050
Ethylbenzene	83.7	4400	0.0190
2-Propenoic acid, butylester	2.4	110	0.0218
Benzene, (1- methylethyl)	33.7	1000	0.0337
p-Xylene	11.6	2200	0.0053
o-Xylene	6.4	2200	0.0029
TXIB	1982.1	450	4.4047
1-Butanol	13.3	3100	0.0043
2-Ethanol, 2-(2- butoxyethoxy)	102.38	670	0.1528

Table 6: The S1-GBMs emission conc. with R value

Test on long-term emission from S1 to S7 building materials showed that the building materials are consistent with emission standard of evaluation factor BTEX for Green Building Materials Mark, the average emission concentration of which is 49.4(ug/m²hr), i.e. 39.5(ug/m³). However, TOTAL VOCs matters emit largely and continuously. The two has 5 times difference, indicating that regarding to the control on evaluation factor of TOTAL VOCs in green building materials, the pollutants shall be controlled.

Specimen NO.	BTEX-CONC. mg/m ³	BTEX-E.F. mg/m ² ·hr	TVOC-CONC. mg/m ³	TVOC-E.F. mg/m ² ·hr
S1	0.187	0.234	1.46	1.83
S2	0.095	0.119	0.82	1.03
S3	0.019	0.025	0.34	0.43
S4	0.018	0.022	0.56	0.71
S5	0.687	0.854	2.55	3.19
S6	0.031	0.039	0.28	0.35
S7	0.028	0.035	0.77	0.96

Table 7: S1-S5 GBMs emission BTEX and TVOC

The evaluation classification of health green building materials mark in this research is in the view of EU and other developed countries' control on indoor air quality and building materials emission. Regarding to TVOC, the quality standard for indoor air by Environment Protection Administration, Executive Yuan can be referred and 12 VOCs in TVOC (i.e. benzene, carbon tetrachloride, chloroform, 1, 2 - dichlorobenzene, 1, 4 - dichlorobenzene, methylene dichloride, ethyl benzene, styrene, tetrachloroethylene, trichloroethylene, methylbenzene and xylene) are

evaluated. With regard to simple VOCs, EU-LCI emission control value formulated by EU can be referred to be synonymous with international trade and technical standards and guarantee the health of Taiwanese.

It is suggested to control the evaluation factors of TVOC emissions from green building materials in Taiwan. The TVOC emission standard is: E1 (less than 0.005 mg/m²* hr), E2(0.005-0.06 mg/m²* hr), and E3(0.06-0.19mg/m²* hr).

Health-GBML levels	Newly Emission Evaluation Classification TVOC(with BTEX substance and Carbon tetrachloride、 Chloroform、 1,2-Dichlorobenzene、 1,4-Dichlorobenzene 、 Dichloromethane、 Styrene、 Tetrachloroethylene、 Trichloroethylene)
E1	TVOC ≤ 0.005 mg/m ² *hr
E2	0.005 < TVOC ≤ 0.06 mg/m ² *hr
E3	0.06 < TVOC ≤ 0.19 mg/m ² *hr

Table 8: The newly health GBMs TVOC emission evaluation classification

4. DISSCUATION AND CONCLUATION

In the evaluation of emission factor for a GBMs in Taiwan, the main emission control items are dominated by TVOC (BTEX) and formaldehyde, while the TVOC control in the indoor air quality standard includes 12 VOCs. Green building materials label should be used to control TVOC (C6-C16) and cancerogens. The EU's LCI (lowest concentrations of interest) and CREL (chronic respiratory exposure limit) should be adopted as the standard of emissions control from building materials and the grading system of emissions from building materials.

This study selected paint with a building materials label for analysis, sampled 7 small pieces of paint for an emission test, and conducted a 48-hour qualitative and quantitative analysis. The results showed that the VOCs (BTEX) of the tested green building materials was extremely low, meeting the evaluation standard (0.19 mg/m²* hr). However, the emission of other VOCs continues and the TVOC content ranged from 0.073 to 9.071 (mg/m²* hr), indicating that there was still emission of a large amount of unregulated pollutants.

REFERENCES

- [1] Cox, S.S., Little, J.C., Hodgson, A.T., (2002). Predicting the emission rate of volatile organic compounds from vinyl flooring. *Environmental Science & Technology* 36, 709-714.
- [2] Godish, T., (2001). *Indoor Environmental Quality*. Lewis Publishers.
- [3] ISO-16000-1 (2004) *Indoor air - Part 1: General aspects of sampling strategy*,
- [4] ISO-16000-2 (2004) *Indoor air - Part 2: Sampling strategy for formaldehyde*.
- [5] ISO-16000-3 (2001) *Indoor air - Part 3: Determination of formaldehyde and other carbonyl compounds - Active sampling method*.
- [6] ISO-16000-4 (2004) *Indoor air - Part 4: Determination of formaldehyde - Diffusive sampling method*.
- [7] ISO-16000-6 (2011) *Indoor air - Part 6: Determination of volatile organic compounds in indoor and test chamber air by active sampling on Tenax TA sorbent, thermal desorption and gas chromatography using MS/FID*.
- [8] Kim, Y.M., Harrad, S., Harrison, R.M., (2001). Concentrations and sources of VOCs in urban domestic and public microenvironments. *Environmental Science & Technology* 35, 997-1004.
- [9] Sparks, L.E., Tichenor, B.A., White, J.W., Jackson, M.D., (1994). Comparison of data from the IAQ test house with predictions of an IAQ computer model. *Indoor Air*, vol. 13, pp. 577-592.
- [10] Tichenor, B.A., Sparks, L.E., White, J.W., Jackson, M.D., (1988). Evaluating sources of indoor air pollution. In: *The 81st Annual Meeting of the Air Pollution Control Association*, Dallas, TX.
- [11] Wu PC, Li YY, Lee CC, Chiang CM, Su HJ. (2003) Risk assessment of formaldehyde in typical office buildings in Taiwan. *Indoor Air*, vol. 13, pp. 359-363.

Sustainability Assessment: An Adaptive Neuro-Fuzzy Inference System Approach

TAN Yongtao^a, SHUAI Chenyang^b, JIAO Liudan^c, SHEN Liyin^d

^a The Hong Kong Polytechnic University, Hong Kong SAR, bstan@polyu.edu.hk

^b The Hong Kong Polytechnic University, Hong Kong SAR, chenyang.shuai@polyu.edu.hk

^c Chongqing University, Mainland China, chenyang.shuai@polyu.edu.hk

^c Chongqing Jiao Tong University, Mainland China, 396732441@qq.com

^d Chongqing University, Mainland China, shenliyin@cqu.edu.cn

ABSTRACT

Urbanization especially in developing countries is a major driver for economic and social development. However, it has induced major concerns from past urbanization experiences, such as air pollution, traffic congestion, and habitat destruction. Such adverse effects caused by urbanization have generated greater pressures on governments to re-think their urban development policies to be sustainable ones. Within this context, various sustainability assessment methods have been developed by existing studies. Due to the dynamic features of sustainable development, fuzzy logic has been widely used for measuring sustainability performance. However, it is argued that most studies are using pre-defined simple linear membership functions and fuzzy rules which are **mostly based on experts' knowledge. The assessment results may not reflect the real sustainability performance.** Therefore, there is a need to develop a new approach for induction of membership functions and fuzzy rules. This paper aims to introduce an adaptive neuro-fuzzy inference systems (ANFIS) approach for city level sustainability assessment. The membership functions and fuzzy rules are generated from 185 training samples. The results show that the new ranking of the selected 185 cities in China is close to the original with minor differences. It indicates that the new approach is valid and effective.

Keywords: urban sustainability, ANFIS, fuzzy logic, artificial neural network

1. INTRODUCTION

The urbanization process involves the people migrating from rural to urban areas, which has been recognized as a major driver for economic and social development. However, the rapid urbanization has also posed various problems such as traffic congestion, air pollution and rising crime rates (Shen et al., 2015b; Zhang, 2015). **Sustainable urbanization can be defined as "...urbanization practice, which complies with sustainable development principles (Roy, 2009)". Sustainable urbanization is a dynamic process that** combines environmental, social, economic and political-institutional sustainability, which complies with sustainable development principles (Zhou et al., 2015b). It has been projected by UNDESA (2014) that, in China, 76% of the population will live in cities by 2050. The figure is already 54% in 2014. This rapid urbanization growth has led to the need to understand urbanization as a major contributor to resource consumption and environmental and social damage (Isendahl and Smith, 2013; Zhou et al., 2015a). For example, the research by Shen et al. (2015b) revealed that during the urbanization process in China, approximately 2.5 to 3.0 million farmers per year lost their farm lands in recent years because of land expropriation, which also adds to the problem of social instability because the majority of these farmers could not find new jobs in cities. It becomes necessary for local governments to re-think related policies for sustainable development of cities.

In line with the promotion of sustainable urbanization, both international institutions and governments at different levels are seeking solutions that integrate, in harmony, environmental, community and economic requirements. With the aim of understanding and monitoring urban sustainability performance, different assessment tools have been developed (Phillis et al., 2011; Singh et al., 2012b; Shen et al., 2011; Shen et al., 2015a; Tan et al., 2015; Tan et al., 2014; Tan et al., 2011; Yao et al., 2011; Zhang, 2015; Zhou et al., 2015b; Zijp et al., 2015). Among them, fuzzy logic is a widely used method to assess sustainability performance. For example, Phillis et al. (2011) introduced the Sustainability Assessment by Fuzzy Evaluation (SAFE) model for assessing the overall sustainability performance at global level. Giordano et al. (2014) applied Takagi–Sugeno fuzzy model to measure the urban ecological efficiency. However, pre-defined membership functions (triangular or trapezoidal) and fuzzy rules are commonly used in existing studies. It is commonly appreciated that the use of pre-defined membership

functions and fuzzy rules highly depends on experts' knowledge, which may not reflect a real-world situation (Buragohain and Mahanta, 2008; Naderloo et al., 2012).

Therefore, there is a need to explore new methods for induction of fuzzy membership function and fuzzy rules. This paper aims to apply the ANFIS approach to assess urban sustainability based on work by the Urban China Initiative (UCI) (2011).

2. ADAPTIVE NEURO-FUZZY INFERENCE SYSTEM (ANFIS)

An Adaptive Neuro-Fuzzy Inference System (ANFIS) was firstly introduced by Jang (1993), which incorporates the fuzzy logic concept into the neural networks. Integration of fuzzy logic and neural network is a preeminent idea to overcome the disadvantages of fuzzy-set theory. As mentioned before, the pre-defined linear membership functions and fuzzy rules are commonly used in existing studies. ANFIS constructs a fuzzy inference system (FIS) whose membership function parameters are derived from training examples. Therefore, ANFIS integrates the advantages of fuzzy systems for dealing with explicit knowledge, which can be explained and understood (such as a fuzzy inference system), and neural networks for dealing with implicit knowledge, which can be acquired by learning (such as membership function) (Singh et al., 2012a).

The architecture of a typical ANFIS consists of five layers, which perform different functions in the ANFIS and are described below (Jang, 1993). For example, if an FIS has two inputs (x, y), two if-then fuzzy rules, one output, and each input has two associated membership functions (MFs). The ANFIS structure is shown in Figure 1 (Singh et al., 2012a).

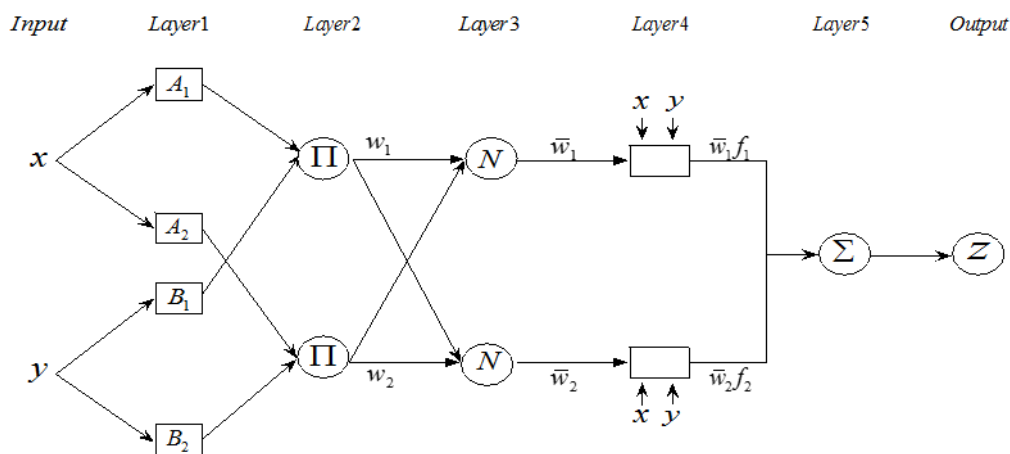

Figure 1: ANFIS structure for a Takagi-Sugeno model with two inputs and two rules

3. URBAN SUSTAINABILITY ASSESSEMENT BY USING ANFIS APPROACH

3.1. Hierarchical structure of ANFIS model

This study is based on the research by the Urban China Initiative (UCI) (2011). UCI is a joint initiative and is led by three major founding institutions: Columbia University, Tsinghua University, and McKinsey & Company. With the ANFIS approach, a bell-shaped membership function will be used because this distribution fits many real-world problems (Ekici and Aksoy, 2011). In their study, a three levels hierarchical structure was established to evaluate urban sustainability in China. Overall urban sustainability performance is the first level. There are four categories in the second level, including social, environment, economy and resource groups. Each category comprises sub-categories. A total of 23 basic indicators are used to describe the sub-category (Urban China Initiative (UCI), 2011). Based on the principle of the ANFIS and the work by the Urban China Initiative (UCI) (2011), the hierarchical structure of ANFIS model is developed, as shown in Figure 2. There are seven ANFIS models for evaluating urban sustainability performance.

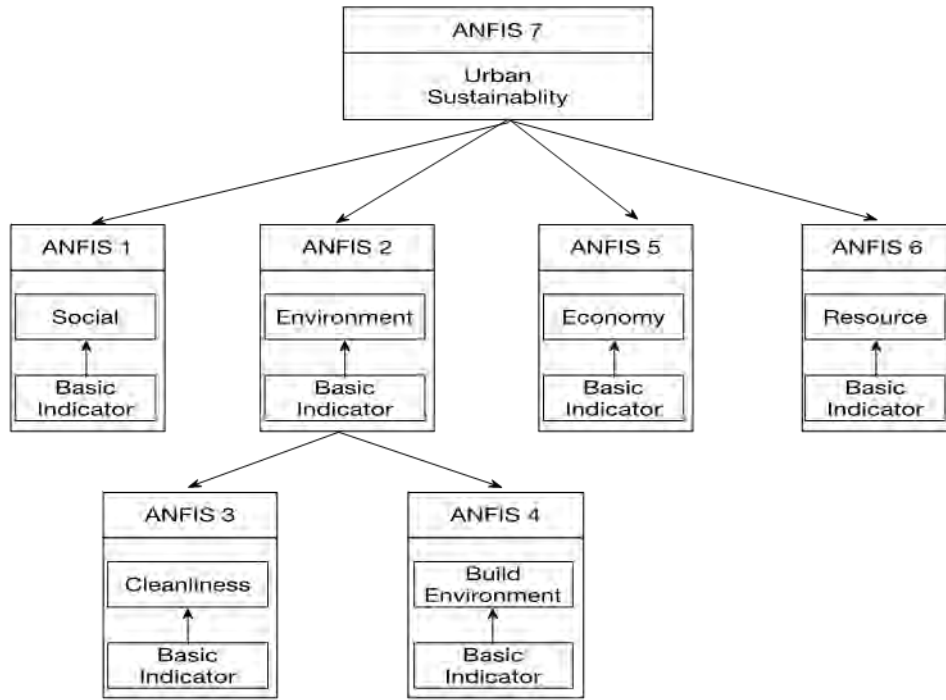

Figure 2: Assessment framework of urban sustainability performance

3.2. Data collection and modelling

The Urban China Initiative (UCI) (2011) has applied the same indicator system to assess the urban sustainability performance of 185 cities in China over the period of 2005-2011. Wang and Elhag (2008) suggested that the reasonable ratio to assume between the training and checking samples is 4:1. In this study, the data from 2005-2008, with the $185 \times 4 = 740$ groups, are used as the training samples, and the data of 2009, with the 185 groups, as the checking sample. The data of 2010 and 2011 are used as validating samples.

After collecting the data, the ANFIS model is developed by using the fuzzy logic toolbox of the MATLAB software package. There are five input variables and each variable has three linguistic values with overall 243 if-then fuzzy rules.

3.3. Training and checking

In this part, the developed ANFIS model will be trained and checked using training and checking data. The details of training method including the gradient method and the least-squares estimate method can be found in the study of Jang (1993). Taking ANFIS 1 as an example, there are 740 groups of training samples. The initial epochs are set as 100 in this study, and the training error is 0.033, which is acceptable for the trained ANFIS (Sun et al., 2015). After training, the new membership Functions (MFs) and fuzzy rules are obtained, are shown in Figure 4 and 5.

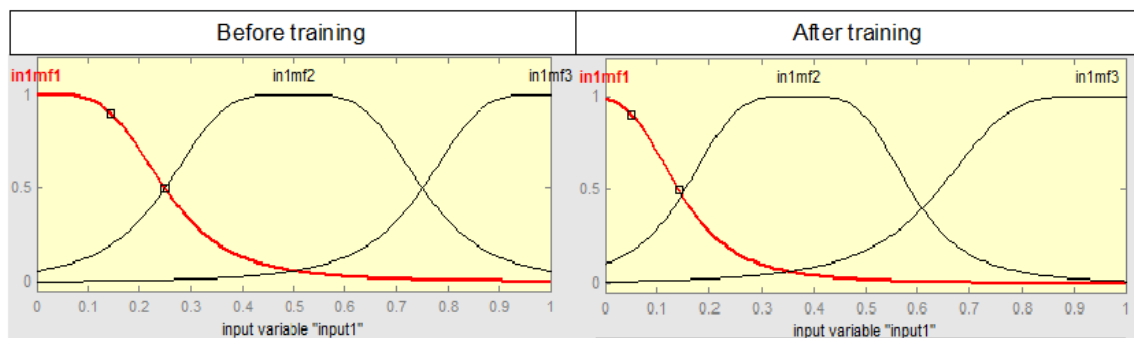

Figure 4: An example of membership function before and after training



Figure 5: If-then rules after training

After training the ANFIS model, the next step is to check the accuracy of the trained ANFIS model. The checking results show that the outputs from the ANFIS model fit the checking data very well.

4. DISCUSSION

After training and checking, the overall sustainability performance of 185 cities were re-assessed by ANFIS method using the data of years 2010 and 2011. The new ranking is very close to the original. The largest difference is the city "Lanzhou" in 2010, ranking 116 in UCI and ranking 106 in ANFIS. The difference is mainly because the membership functions and if-then rules are from training. The final ranking may be different with different training samples. Therefore, it is important to select appropriate training samples so that the trained membership functions and if-then rules can fit the situation of the real-world. The selection of appropriate training samples will be examined in future research.

5. CONCLUSION

Sustainability is a complex and dynamic issue. Many assessment methods have been developed. Yet the main challenges are still vagueness, subjectivity and dynamics involved in the assessment. To overcome these problems, an adaptive neuro-fuzzy inference system (ANFIS) was introduced in this study for urban sustainability assessment. The membership functions and fuzzy rules can be obtained from training samples rather than from **experts' knowledge**. The **robust validation process** reveals that the ANFIS method is appropriate for urban sustainability evaluation.

One limitation of this study is that there is only one data source, the UCI. The assessment results are very close to those from UCI sources. It indicates that the ANFIS method is effective, but needs to be further improved by using training data from other sources. The Membership Functions (MFs) and if-then rules can be improved in a further study by using training data collected from different sources, such as UN-Habitat, or World Bank. Furthermore, sustainability assessment is a dynamic process. The indicators, benchmarks, or rules may change. However, the ANFIS method can meet the dynamic requirements through new training, with new data and new rules.

ACKNOWLEDGEMENT

This research was fully supported by a grant from the Research Grants Council of Hong Kong Special Administrative Region, China (Project No. F-PP2F). We also would like to thank UCI for providing the training data. The authors would also like to acknowledge the editing by Dr. Paul W. Fox of an earlier draft of this paper.

REFERENCES

- [1] Buragohain, M., Mahanta, C., 2008. A novel approach for ANFIS modelling based on full factorial design. *Applied Soft Computing* 8, 609-625.
- [2] Ekici, B.B., Aksoy, U.T., 2011. Prediction of building energy needs in early stage of design by using ANFIS. *Expert Systems with Applications* 38, 5352-5358.
- [3] Giordano, P., Caputo, P., Vancheri, A., 2014. Fuzzy evaluation of heterogeneous quantities: Measuring urban ecological efficiency. *Ecological Modelling* 288, 112-126.
- [4] Isendahl, C., Smith, M.E., 2013. Sustainable agrarian urbanism: The low-density cities of the Mayas and Aztecs. *Cities* 31, 132-143.
- [5] Jang, J.-S.R., 1993. ANFIS: adaptive-network-based fuzzy inference system. *Systems, Man and Cybernetics, IEEE Transactions on* 23, 665-685.
- [6] Naderloo, L., Alimardani, R., Omid, M., Sarmadian, F., Javadikia, P., Torabi, M.Y., Alimardani, F., 2012. Application of ANFIS to predict crop yield based on different energy inputs. *Measurement* 45, 1406-1413.
- [7] Phillis, Y.A., Grigoroudis, E., Kouikoglou, V.S., 2011. Sustainability ranking and improvement of countries. *Ecological Economics* 70, 542-553.
- [8] Roy, M., 2009. Planning for sustainable urbanisation in fast growing cities: Mitigation and adaptation issues addressed in Dhaka, Bangladesh. *Habitat International* 33, 276-286.
- [9] Shen, L., Jiao, L., He, B., Li, L., 2015a. Evaluation on the utility efficiency of metro infrastructure projects in China from sustainable development perspective. *International Journal of Project Management* 33, 528-536.
- [10] Shen, L., Ochoa, J.J., Shah, M.N., Zhang, X., 2011. The application of urban sustainability indicators—A comparison between various practices. *Habitat International* 35, 17-29.
- [11] Shen, L., Zhou, J., Skitmore, M., Xia, B., 2015b. Application of a hybrid Entropy–McKinsey Matrix method in evaluating sustainable urbanization: A China case study. *Cities* 42, 186-194.
- [12] Singh, R., Kainthola, A., Singh, T.N., 2012a. Estimation of elastic constant of rocks using an ANFIS approach. *Applied Soft Computing* 12, 40-45.
- [13] Singh, R.K., Murty, H.R., Gupta, S.K., Dikshit, A.K., 2012b. An overview of sustainability assessment methodologies. *Ecological Indicators* 15, 281-299.
- [14] Sun, W., Hu, P., Lei, F., Zhu, N., Jiang, Z., 2015. Case study of performance evaluation of ground source heat pump system based on ANN and ANFIS models. *Applied Thermal Engineering* 87, 586-594.
- [15] Tan, Y., Ochoa, J.J., Langston, C., Shen, L., 2015. An empirical study on the relationship between sustainability performance and business competitiveness of international construction contractors. *Journal of Cleaner Production* 93, 273-278.
- [16] Tan, Y., Shen, L., Langston, C., 2014. A fuzzy approach for adaptive reuse selection of industrial buildings in Hong Kong. *International Journal of Strategic Property Management* 18, 66-76.
- [17] **Tan, Y., Shen, L., Yao, H., 2011. Sustainable construction practice and contractors' competitiveness: A preliminary study. *Habitat International* 35, 225-230.**
- [18] UNDESA, 2014. World Urbanization Prospects, the 2014 Revision , Retrieved Sep 2014.
- [19] Urban China Initiative (UCI), 2011. Urban China Database, retrieved from <http://www.urbanchinainitiative.org/en/resources/database.html%3E>
- [20] Wang, Y.-M., Elhag, T.M.S., 2008. An adaptive neuro-fuzzy inference system for bridge risk assessment. *Expert Systems with Applications* 34, 3099-3106.
- [21] Yao, H., Shen, L., Tan, Y., Hao, J., 2011. Simulating the impacts of policy scenarios on the sustainability performance of infrastructure projects. *Automation in Construction* 20, 1060-1069.
- [22] Zhang, X., 2015. Sustainable urbanization: a bi-dimensional matrix model. *Journal of Cleaner Production*.
- [23] Zhou, J., Shen, L., Song, X., Zhang, X., 2015a. Selection and modeling sustainable urbanization indicators: A responsibility-based method. *Ecological Indicators* 56, 87-95.
- [24] Zhou, J., Zhang, X., Shen, L., 2015b. Urbanization bubble: Four quadrants measurement model. *Cities* 46, 8-15.
- [25] Zijp, M.C., Heijungs, R., van der Voet, E., van de Meent, D., Huijbregts, M.A.J., Hollander, A., Posthuma, L., 2015. An identification key for selecting methods for sustainability assessments. *Sustainability* 7, 2490-2512.

Quantifying Greenhouse Gas Emissions: A Review of Models and Tools at the Precinct Scale

Angela Maria ROJAS-AREVALO^a, Lu AYE^b, Seona CANDY^c

^a The University of Melbourne, Australia, angelara@student.unimelb.edu.au

^b The University of Melbourne, Australia, lua@unimelb.edu.au

^c The University of Melbourne, Australia, candys@unimelb.edu.au

ABSTRACT

Although urban areas cover only 3% of the earth's land surface, they are responsible for over 70% of greenhouse gas emissions (GHGE) from energy use. Cities are versatile, dynamic and complex. Therefore, implementations of low carbon initiatives at city scale are challenging and at times impractical. From the local administration perspective, the precinct scale represents a manageable operational scale for governance, urban planning and socio-technical innovations. There are various methods for quantification of GHGE at building, precinct, city and national scales, but few target the complexity and dynamics of the urban area, especially at the precinct scale. The aim of this paper is to identify a suitable quantification method for the precinct scale. The method should be able to determine the changes in GHGE due to implementations of low carbon policies and other strategies. This paper reviews the available methods for quantification of GHGE and highlights their challenges and limitations. Since urban areas need a system thinking approach, this review outlines how the methods analyse complex systems, such as System Dynamics (SD).

Keywords: quantification of GHG emissions, low carbon, precinct

1. INTRODUCTION

Urban areas, such as cities, are responsible for a significant portion of greenhouse gas emissions (GHGE) and at the same time, are vulnerable to climate change impacts. Urban energy systems are resource intensive and fossil fuel dependent, contributing to the high concentrations of GHGE released from urban areas. This situation could be exacerbated if the proportion of the global population living in urban areas increases from 50% to 66% as predicted for 2050 (UN 2015). **To sustain this urban population growth while reducing GHGE and city's vulnerability,** urban areas need to transition from carbon intensive to low carbon practices.

Therefore, measurement and quantification of GHGE in urban areas are vital to develop mitigation, adaptation strategies and to achieve GHGE reduction targets. Quantification methods should be able to capture the changes of GHGE from different low carbon policies and other strategies. These methods have been developed for different purposes such as monitoring, reporting, planning, decision-making, and analysis of land-atmosphere carbon exchange. These methods distinctly define spatial and temporal system boundaries, making their comparison a challenging task. Furthermore, most of the methods, such as rating tools and accounting methods, fail to capture the dynamics and complexities inherently present in urban areas.

There is a need for methods to capture these complexities and dynamics. Therefore, the aim of this review is to identify the most appropriate method to quantify the changes of GHGE from low carbon initiatives in urban precincts. To do so both academic and grey literature in quantification of GHGE were reviewed to identify 1) the techniques for quantification of GHGE in urban areas 2) explain challenges and limitations, and 3) propose a suitable approach to quantify changes of GHGE in a precinct scale when testing low carbon strategies. Since energy systems are an essential part of an urban area and significant generators of direct and indirect GHGE, contribution from review articles on energy methods, tools and models are taken into account in this paper.

Section 2 presents a general overview of the techniques used for quantification of GHGE in urban areas. Section 3 discusses challenges and limitations of current techniques and explains why those in the complex system realm are the most appropriate for the purpose of quantifying GHGE when analysing low carbon strategies at the precinct scale.

2. QUANTIFICATION OF GHGE IN URBAN AREAS

2.1 Complexity, dynamics and scale considerations

Cities have extensive mixed land use areas with distinct characteristics and infrastructures of provision, governed by different authorities and accommodate diverse occupant profiles. Cities and, in general, urban areas should be regarded as complex systems. They are also dynamic. Their dynamics link to different rates of changes of their subsystems, for instance slow land use change compared to fast transport of goods (Simmonds et al. 2013).

These intertwined relationships and different rates of change clearly intensify the implementation challenges for low carbon strategies at a country or city scale. A precinct or neighbourhood, however, represents a more manageable scale (Rauland 2013). In precincts, likeminded communities might easily engage and collaborate with initiatives. Also, a precinct represents an operational unit where low carbon strategies can be developed accordingly to the site characteristics and requirements, taking into account the physical and socio-economic relationships even outside its immediate boundaries. This review investigates different types of quantification of GHGE but focus the analysis at the precinct scale since the idea of targeting an intermediate scale, between the city and the individual building, to implement low carbon initiatives.

2.2 Methods

Quantification methods are developed for reporting, rating, decision-making, design and urban planning, and policy making purposes. In general, urban GHGE quantification methods can be classified as top down, bottom-up or hybrid (Ou 2012; van Vuuren et al. 2009). The characteristics and limitations of these three main approaches have been reviewed before by other authors. This review investigates at more specific models and tools (e.g. bottom-up building stocks).

Different international protocols and standards, developed for the quantification of GHGE since the late 1980's, follow a top-down approach, using econometric models and accounting methods at macro scales. The top-down quantification of GHGE using econometric models emphasizes the analysis on market processes by studying the economy of a country as a whole. This type of approach overlooks sociotechnical detail, it is static and uses highly aggregated historical data.

On the other hand, bottom-up methods look at individual technologies or energy consumption in houses and extrapolate them to the regional or national scale. They use statistical or engineering methods. While these methods capture sociotechnical and other details (e.g. building physics), they overlook their relationship with the economy. Although both methods, top-down and bottom-up, have different applicability, they can be combined to take a hybrid approach.

There are more comprehensive models that take the sustainability triple bottom line perspective, assessing not only GHGE but also other environmental and socio-economic impacts. They use geographical information systems (GIS), optimization algorithms and scenario analysis. These types of models are mostly used by the design and urban planning sectors for decision-making at early stages of a project.

The typical spatial scales used for quantification are building (micro), neighbourhood (local) or city/country (macro) scales. At micro scale (building), the most common and accepted approach for environmental impacts is Life Cycle Assessment (LCA). LCAs can include energy and/or greenhouse gas (GHG) analysis, life cycle eco-footprint, and integrated criteria weighting as part of their methodology (Iwaro et al. 2014). This method has contributed significantly to the analysis of impacts in the built environment.

LCA has also been developed in recent years for local scales. There is sound research on residential configurations and related GHGE (Crawford and Fuller 2011), as well as preliminary work on urban-building life cycle analysis and interactions (Stephan 2013). LCA can incorporate scenario analysis and complement the assessment with GIS techniques. Lotteau et al. (2015) presented a comprehensive review of LCA for local scale. The authors proposed a common definition of a Functional Unit (FU) to improve comparability and analysis. They also claim for a clear contextualization of the neighbourhood and a clear definition of temporal scales to improve decision making.

Another key approach for local scales is the bottom-up building stock models reviewed by Kavgic et al. (2010), where building physics and empirical data can be combined to estimate the energy consumption and related GHGE.

The issues including lack of data transparency, data availability and uncertainty related to how society consumes energy and reacts to changes from energy policies were identified.

Local and macro (City) scales can be also analysed with the urban metabolism (UM) methodology (Codoban and Kennedy 2008; Kellett et al. 2013; Kennedy 2011). UM is applied as an accounting method mainly looking at mass **balance and “energy” of a system**. Pincetl et al. (2012) presented how UM can be expanded to allow a more comprehensive and integrative assessment by evaluating electricity, water and solid waste flows plus a LCA of the related infrastructure.

Other accounting methods at local and macro scales are: carbon accounting with input-output models (Wiedmann 2009), GHG footprint, GHG inventory analysis (Chester et al. 2014) and protocols, i.e. The Global Protocol for Community Scale (WRI 2014). These accounting methods of material and energy flows are useful to identify mismatches between demand and supply but they take a static approach.

Allegrini et al. (2015) present a review for the design and planning of district-scale energy systems, highlighting the need for simpler decision making tools, holistic approaches and the opportunity to integrate different models. For decision making and urban planning at this scale, the use of urban simulation models (Rager et al. 2013; Waddell 2002), survey data analysis (Newman and Kenworthy 1989), and material flow (Goldstein et al. 2013), are the most common methods.

All methods described so far are still considering urban areas as static systems. System thinking (ST) is potentially the most convenient perspective that addresses urban areas as complex systems as it is focused on the entire system as a whole, while also accounting for its components and subsystems and how they interact with each other (Waltner-Toews et al. 2008).

However, ST ignores the main relationships with the outside boundary of the system under study. Methods for modelling complex systems following the ST perspective such as System Dynamics (SD) (Feng 2013; Wang et al. 2012), Cellular Automata (CA), and Agent Based Modelling (ABM) (Aschwanden et al. 2012; Natarajan et al. 2011) have the potential to better capture the characteristic features of urban areas.

2.3 Models and tools

A selection of few representative tools is described in this subsection. In general, models and tools for quantification of GHGE build upon one or more methods described before. Rauland (2013) presented a review of typical tools used at precinct scale, including the designing tools eTool and CCap. These tools include quantification of GHGE among other performance metrics for decision making at design stages, but they do not take into account all the subsystems present within an urban ecosystem. The review highlighted the need for a precinct scale GHGE framework using LCA to calculate embodied and operational emissions.

Alternatively, the Australian Stocks and Flows Framework (ASFF) was developed by CSIRO to deal with the processes that support economic and social activities and describe them in dynamic and in physical terms (Turner 2011). ASFF describes the biophysical Australian environment combining different methods such as LCA, and metabolism-based such as mass-flow analysis. All methods are linked as calculators using nationwide databases and simulation processes that complement the analysis tool using what-if scenarios. It is a powerful and comprehensive framework for national and regional scales, but it lacks the finer data resolution needed at the precinct scale.

The urban planning tool, Integrated Resource Management (IRM), is a complex excel spreadsheet (Birch et al. 2013) used as a guidance tool for sustainable urban design and planning. It offers a common framework where urban designers and technical teams can design processes to capture key performance indicators (Page et al. 2008), but they do not capture the urban ecosystem dynamics.

MUtopia is a simulation tool for engineering sustainable systems in local scale. This platform integrates areas such as energy, water supply, waste and transport through spatial data infrastructure. The platform allows testing different scenarios including impacts in GHGE from distributed infrastructure of water or energy supply (Bishop et al. 2008). However, the results are limited due to the assumptions made to simplify the models (Ngo et al. 2014).

UrbanSim is a simulation software tool for urban planning. It assesses the impacts of infrastructure within a metropolitan area by integrating the interactions and approximating the dynamics between land use, transportation, the economy and the environment. UrbanSim is the only tool within this selection that uses ABM, a method from the complex systems realm. It is a powerful open source simulation tool for local scale, but it lacks the integration of other infrastructures of service such as water, waste, and electricity.

3. DISCUSSION

This section describes the limitations and challenges of the methods and tools reviewed, describing a suitable GHGE quantification approach at the precinct scale.

3.1. Limitations and challenges

All the methods reviewed define different system boundaries, functional units, spatial and temporal scales for analysis, making their comparison challenging. Methods, such as carbon accounting, usually follow a top-down approach, and long temporal and broad spatial scales hindering the identification of potential opportunities to reduce GHGE at the precinct scale. Moreover, reporting and accounting methods are static and do not have the capacity to test future scenarios, diminishing their ability to analyse different policies or interventions.

Most of the methods limit their quantification to operational impacts, while there is a need for tools able to assess operational and embodied impacts simultaneously (Newton 2013). Linked to the need for embodied impact data, is the need for finer data resolution in order to capture the complexity of urban ecosystems. However, balancing complexity and computing costs with accuracy represents a challenging task. Nevertheless, the most important limitation for any method is the availability of representative, complete and consistent data of the urban ecosystem under study.

Also, methods should include the dynamics related to different rates of change of subsystems, which increase the system complexity and uncertainty. Uncertainty analysis should be performed and used to visualise the evolution of different parameters of an urban area, especially when analysing transitions to low carbon futures.

3.2. Appropriate method

Embedded systems and processes in precincts, such as the energy system and related GHGE, have all the main characteristics of complex systems, including agents, networks, path-dependency, emergence and co-evolution (Bale et al. 2015). Therefore, complex systems approaches may better represent transitions to low carbon futures than carbon accounting methods. The sustainability transition modelling community uses ABM or SD to simulate and explore socio-technical transitions in the built environment (Li et al. 2015), mostly assessing the energy area and related GHGE.

ABM is well suited to represent a high degree of heterogeneity across entities assuming there is perfect information about the interaction network. However, this level of detail comes at a high computational cost that limits the use of the model for sensitivity analysis for policy making, increases the complexity of understanding the causes of the results (Rahmandad 2008) and relies heavily on data accessibility which in most real world scenarios is unavailable.

In contrast, SD relaxes the level of detail of the entities through aggregation and lends itself to fast scenario analysis, at the cost of losing track of possible metrics. The design choices when modelling with SD should be made to capture the main metrics accurately, ignoring only the ones that are less important for policy making. Also, Discrete Event (DE) modelling can be easily integrated along with SD to model micro level details that do not involve continuous processes, such as traffic flow, and commuting patterns (Borshchev 2004; Zeigler 2000).

The ST perspective, which analyses the whole system, its subsystems and their interactions, is a valid approach to describe complex systems. However, ST ignores the relationships with the outside boundary of the main urban system under study. Therefore, models driven by the ST approach should be expanded to approximate the main relationships of the system with its outside boundary, especially the ones linked to changes of GHGE.

In terms of tools, ASFF and UrbanSim show the potential for coupling modelling methods, a valid option for assessing possible futures in urban ecosystems (Sheridan et al. 2016). Any successful method for quantification of GHGE changes should include features such as coupled modelling and different time delays (e.g. Urbansim),

to better represent the complexity and dynamics of urban ecosystems. Furthermore, suitable methods should be flexible to include data from low carbon initiatives already applied in other contexts as demonstration projects. This data can be used as inputs of the model to examine GHGE reductions from distributed infrastructures, or other technological scenario adoptions (Mohareb and Kennedy 2014).

Moreover, future transitions to low carbon precincts are uncertain in nature, therefore the use of exploratory modelling and analysis represent an opportunity to discover what could happen (Maier et al. 2016), even if the scenarios are generated externally or strategically for decision making (Börjeson et al. 2006).

4. CONCLUSION

The methods for quantification of GHGE in urban ecosystems were reviewed. It highlighted the importance of targeting urban areas at the precinct scale when implementing low carbon initiatives; therefore the review includes quantification models and tools at this specific scale. It summarises the limitations and challenges of different methods and suggests that future work on quantification of urban GHGE should use models with the underlying methodologies from complex systems. The analysis of urban areas, regarded as urban ecosystems, could benefit from the systems thinking approach with a multidisciplinary perspective when quantifying GHGE changes. It is also recommended the use of exploratory modelling and analysis. This would assist representing different future pathways of low carbon transitions and accounting with the inherent system uncertainties.

REFERENCES

- [1] Allegrini, J, Orehounig, K, Mavromatidis, G, Ruesch, F, Dorer, V & Evins, R 2015, 'A review of modelling approaches and tools for the simulation of district-scale energy systems', *Renewable and Sustainable Energy Reviews*, vol. 52, pp. 1391-404.
- [2] Aschwanden, GD, Wullschleger, T, Müller, H & Schmitt, G 2012, 'Agent based evaluation of dynamic city models: a combination of human decision processes and an emission model for transportation based on acceleration and instantaneous speed', *Automation in Construction*, vol. 22, pp. 81-9.
- [3] Bale, CS, Varga, L & Foxon, TJ 2015, 'Energy and complexity: New ways forward', *Applied Energy*, vol. 138, pp. 150-9.
- [4] Baynes, TM & Wiedmann, T 2012, 'General approaches for assessing urban environmental sustainability', *Current Opinion in Environmental Sustainability*, vol. 4, no. 4, pp. 458-64.
- [5] Börjeson, L, Höjer, M, Dreborg, K-H, Ekvall, T & Finnveden, G 2006, 'Scenario types and techniques: towards a user's guide', *Futures*, vol. 38, no. 7, pp. 723-39.
- [6] Borshchev, AF, Alexei 2004, 'From system dynamics and discrete event to practical agent based modeling: reasons, techniques, tools', paper presented to Proceedings of the 22nd international conference of the system dynamics society.
- [7] Chester, MV, Sperling, J, Stokes, E, Allenby, B, Kockelman, K, Kennedy, C, Baker, LA, Keirstead, J & Hendrickson, CT 2014, 'Positioning infrastructure and technologies for low-carbon urbanization', *Earth's Future*, vol. 2, no. 10, pp. 533-47.
- [8] Codoban, N & Kennedy, CA 2008, 'Metabolism of neighborhoods', *Journal of urban planning and development*, vol. 134, no. 1, pp. 21-31.
- [9] Feng, YC, SQ Zhang, LX 2013, 'System dynamics modeling for urban energy consumption and CO₂ emissions: a case study of Beijing, China', *Ecological Modelling*, vol. 252, pp. 44-52.
- [10] Goldstein, B, Birkved, M, Quitzau, M-B & Hauschild, M 2013, 'Quantification of urban metabolism through coupling with the life cycle assessment framework: concept development and case study', *Environmental Research Letters*, vol. 8, no. 3, p. 035024.
- [11] Iwano, J, Mwashia, A, Williams, RG & Zico, R 2014, 'An Integrated Criteria Weighting Framework for the sustainable performance assessment and design of building envelope', *Renewable and Sustainable Energy Reviews*, vol. 29, pp. 417-34.
- [12] Kavajic, M, Mavrogiani, A, Mumovic, D, Summerfield, A, Stevanovic, Z & Djurovic-Petrovic, M 2010, 'A review of bottom-up building stock models for energy consumption in the residential sector', *Building and Environment*, vol. 45, no. 7, pp. 1683-97.
- [13] Kellett, R, Christen, A, Coops, NC, van der Laan, M, Crawford, B, Tooke, TR & Olchovski, I 2013, 'A systems approach to carbon cycling and emissions modeling at an urban neighborhood scale', *Landscape and Urban Planning*, vol. 110, no. 1, pp. 48-58.

- [14] Kennedy, CP, S Bunje, P. 2011, 'The study of urban metabolism and its applications to urban planning and design', *Environmental Pollution*, vol. 159, no. 8–9, pp. 1965-73.
- [15] Li, F, Trutnevyte, E & Strachan, N 2015, 'A review of socio-technical energy transition (STET) models', *Technological Forecasting and Social Change*, vol. 100, pp. 290-305.
- [16] Lotteau, M, Loubet, P, Pousse, M, Dufresnes, E & Sonnemann, G 2015, 'Critical review of life cycle assessment (LCA) for the built environment at the neighborhood scale', *Building and Environment*, vol. 93, pp. 165-78.
- [17] Maier, H, Guillaume, J, van Delden, H, Riddell, G, Haasnoot, M & Kwakkel, J 2016, 'An uncertain future, deep uncertainty, scenarios, robustness and adaptation: How do they fit together?', *Environmental modelling & software*, vol. 81, pp. 154-64.
- [18] Mohareb & Kennedy 2012, 'Greenhouse Gas Emission Scenario Modeling for Cities Using the PURGE Model', *Journal of Industrial Ecology*, vol. 16, no. 6, pp. 875-88.
- [19] Mohareb & Kennedy, C 2014, 'Scenarios of technology adoption towards low-carbon cities', *Energy Policy*, vol. 66, pp. 685-93.
- [20] Natarajan, S, Padget, J & Elliott, L 2011, 'Modelling UK domestic energy and carbon emissions: an agent-based approach', *Energy and Buildings*, vol. 43, no. 10, pp. 2602-12.
- [21] Newman, PW & Kenworthy, JR 1989, 'Gasoline consumption and cities: a comparison of US cities with a global survey', *Journal of the American Planning Association*, vol. 55, no. 1, pp. 24-37.
- [22] Newton, PM, David; Mitchell, John; Plume, Jim; Seo, Seongwon; Roggema, Rob 2013, 'Performance Assessment of Urban Precinct Design'.
- [23] Ngo, T, Aye, L, Arora, M, Mendis, P & Malano, H 2014, 'MUtopia: Platform for envisioning future and transition scenarios of sustainable urban developments'.
- [24] Ou, Y 2012, 'Proposing a Bottom-up End-use Energy Model for Chinese Residential Sector at City-Level', paper presented to PLEA2012-28th Conference, Opportunities, Limits & Needs Towards an environmentally responsible architecture Lima, Perú.
- [25] Page, J, Grange, N & Kirkpatrick, N 2008, '506: The Integrated Resource Management (IRM) model—a guidance tool for sustainable urban design'.
- [26] Pincell, S, Bunje, P & Holmes, T 2012, 'An expanded urban metabolism method: Toward a systems approach for assessing urban energy processes and causes', *Landscape and Urban Planning*, vol. 107, no. 3, pp. 193-202.
- [27] Rager, J, Dorsaz, C & Maréchal, F 2013, 'ECOS: Integrated and practical energy planning for new districts', paper presented to 26th International Conference on Efficiency, Cost, Optimization, Simulation and Environmental Impact of Energy.
- [28] Rahmandad, HS, John 2008, 'Heterogeneity and network structure in the dynamics of diffusion: Comparing agent-based and differential equation models', *Management Science*, vol. 54, no. 5, pp. 998-1014.
- [29] Rauland, V 2013, 'Decarbonising cities: Certifying carbon reduction in urban development'.
- [30] **Sheridan, J, Carey, R & Candy, S 2016, What does it take to feed a city? MELBOURNE ' S FOODPRINT**, Victorian Eco-innovation Lab, The University of Melbourne.
- [31] Simmonds, D, Waddell, P & Wegener, M 2013, 'Equilibrium versus dynamics in urban modelling', *Environment and Planning B: Planning and Design*, vol. 40, no. 6, pp. 1051-70.
- [32] Tsolakis, N & Anthopoulos, L 2015, 'Eco-cities: An integrated system dynamics framework and a concise research taxonomy', *Sustainable Cities and Society*, vol. 17, pp. 1-14.
- [33] Turner, GMH, Robert McInnis, Bertram C. Poldy, Franzi Foran, Barney 2011, 'A tool for strategic biophysical assessment of a national economy – The Australian stocks and flows framework', *Environmental modelling & software*, vol. 26, no. 9, pp. 1134-49.
- [34] UN 2015, United Nations, Department of Economic and Social Affairs, Population Division.
- [35] van Vuuren, DP, Hoogwijk, M, Barker, T, Riahi, K, Boeters, S, Chateau, J, Scricciu, S, van Vliet, J, Masui, T & Blok, K 2009, 'Comparison of top-down and bottom-up estimates of sectoral and regional greenhouse gas emission reduction potentials', *Energy Policy*, vol. 37, no. 12, pp. 5125-39.
- [36] Waddell, PE, D 2002, 'UrbanSim: Modelling Urban Land Development for Land Use', *Transportation and Environmental Planning*, University of Washington, Seattle.
- [37] Waltner-Toews, D, Kay, JJ & Lister, N-ME 2008, *The ecosystem approach: complexity, uncertainty, and managing for sustainability*, Columbia University Press.
- [38] Wang, J, Lin, T, Feng, L & Huang, J 2012, 'A System Dynamics Approach for Local Settlement Morphology Planning Based on Household Consumption Carbon Footprint', paper presented to Advanced Materials Research.

- [39] Wiedmann, T 2009, 'A review of recent multi-region input–output models used for consumption-based emission and resource accounting', *Ecological Economics*, vol. 69, no. 2, pp. 211-22.
- [40] World Urbanization Prospects: The 2014 Revision, (ST/ESA/SER.A/366). Department of Economic and Social Affairs, Population Division, New York City.
- [41] Zeigler, BPP, Herbert Kim, Tag Gon 2000, *Theory of modeling and simulation: integrating discrete event and continuous complex dynamic systems*, Academic press.

Track 4: Innovations Driving for Greener Policies & Standards

Session 1.6 Innovations Driving for Greener Policies and Standards – Microclimate

The Potential of Applying Local Climate Zone for the Sustainable Planning in Urban Built Environment

LIN Tzu-ping^a, CHEN Yu-cheng^b, REN Chao^c, Kevin LAU Ka-lun^d

^a Department of Architecture, National Cheng Kung University, Taiwan, lin678@gmail.com

^b Department of Architecture, National Cheng Kung University, Taiwan, leo2208808@yahoo.com.tw

^c The Chinese University of Hong Kong, Hong Kong SAR, renchao@cuhk.edu.hk

^d The Chinese University of Hong Kong, Hong Kong SAR, kevinlau@cuhk.edu.hk

ABSTRACT

Inspired by the increasing urbanization and urban heat island effect (UHI) issues, an innovative concept called Local Climate Zone (LCZ) was developed to standardize and classify various built environment. The LCZ system was used to evaluate the relationship between UHI and urban characteristics which included land cover, sky view factor (SVF), building height, surface albedo and roughness. Due to the previous research had revealed the LCZ system were highly related with the micro-climate condition, this work attempt to apply the LCZ into consideration of adapt the sustainable planning in urban built environment by comprehend the relevance between the thermal load and the LCZ distribution. The Tainan city was selected to be the study area because of the growing thermal stress and the reduction of ventilation path in the rapid urban development. In term of the LCZ classify method, the World Urban Database and Portal Tool (WUDAPT) was applied through the Landsat satellite image to make a wide range LCZ distribution map in an efficient way. In this study, there are two main issues discussed in the study. Firstly, to identify the LCZ by several methods and confirm if it is correct in reality. Secondly, to propose a method to quantify the thermal conditions in different LCZs in the urban area. The analytical results indicated that the WUDAPT may overestimate the building height compared to the actual height by the building digital map. It may due to the resolution in the satellite image is insufficient and the areas with small amounts of tall buildings will be still regards as compact high-rise areas. Concerning the thermal conditions in various LCZ, it is obvious that the highly developed urban areas, such as LCZ2 (Compact mid-rise) and LCZ3 (Compact low-rise) have a higher thermal stress distribution, while the natural areas such as LCZ 6 (Open low-rise), LCZ 9 (Sparsely built), got lower PET value based on the measured data. The result will contribute to the urban climate study and benefit to the sustainable development in the urban areas.

Keywords: local climate zone, WUDAPT, thermal conditions

1. INTRODUCTION

In the urbanization process, the thermal environment of cities has greatly changed due to the reduce of green area and the increase of buildings (Kent, 2011). Urban areas are generally warmer than their rural counterparts. This urban-rural temperature difference is known as urban heat island effect (UHI). Recently, global warming has exacerbated the phenomenon of UHI and threatening the health of urban dwellers. As urbanization is a long-term global trend, understanding how land development is associated with thermal environments becomes an important task for governments to adapt cities to hotter and longer summer.

Previously studies regarding thermal environment distribution in urban areas is highly related to the land use and land cover of the areas, and connected to urban morphology and building typology. However, there are many information required and should be prepared before the analysis. Therefore, this research uses an innovative method called Local Climate Zone (LCZ) (Stewart and Oke 2012) to substitute the traditional land zoning system which was developed for managing land resources by dividing land into various types, such as commercial, residential, and agricultural zones. Furthermore, LCZs can be classified into 17 basic categories, based on ten parameters, including sky view factor, aspect ratio, building surface fraction, pervious surface fraction, and

impervious surface fraction, height of roughness element, class of terrain roughness, surface admittance, surface albedo, and anthropogenic heat output.

In this study, there are two main issues discussed in the study. Firstly, to identify the LCZ by several methods and confirm if it is correct in reality. Secondly, to propose a method to quantify the thermal conditions in different LCZs in the urban area. The result will contribute to the urban climate study and benefit to the sustainable development in the urban areas.

2. Method

2.1 Study area

As a high development city (22°59'N, 120°11'E) in the south of Taiwan, Tainan is selected to be the study area (Figure 1). The total area of Tainan is 175.6465 km², including 6 administrative districts. In 2010, Tainan city had been upgraded to a special municipality. However, this transformation results the increase of population and land operations, make it urgently and necessary to consider of microclimate research in order to give local government assistance by making urban development policies. The Tainan city is in tropical areas, the annual mean temperature in this area is 24.6°C. July is the hottest month; the mean temperature is 30.4°C, January is the coldest month; the mean temperature is 17.6°C, and the annual mean relative humidity is 74.4%.

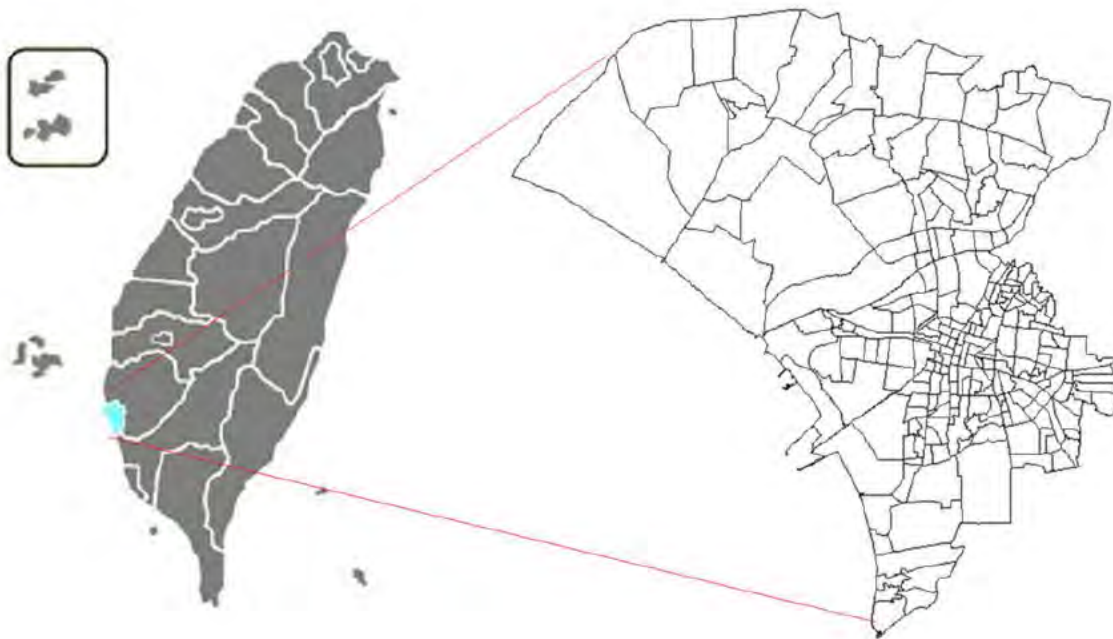

Figure 1: Study areas of Tainan city, Taiwan

2.2 The classification of LCZ

This study applied LCZ, a systematic classification scheme developed by Stewart and Oke (2012), to map land development patterns into climatological related zones. The scheme defines land development patterns according to the structural properties of buildings and vegetation, such as types, height, and density, as well as the types of land cover. Following the instruction on the World Urban Database and Access Portal Tools (WUDAPT), this study prepared the training areas of LCZs in Taipei Metropolis by Google Earth Pro (7.1.5.1557) and utilized SAGA GIS software (2.2.0) to perform classification. Given that LCZ8 and LCZ10 has similar characteristics in Tainan, this two LCZs were combined as LCZ10 for discussion. In total, sixteen LCZs were identified based on the Landsat 8 satellite image acquired on 16 November 2015.

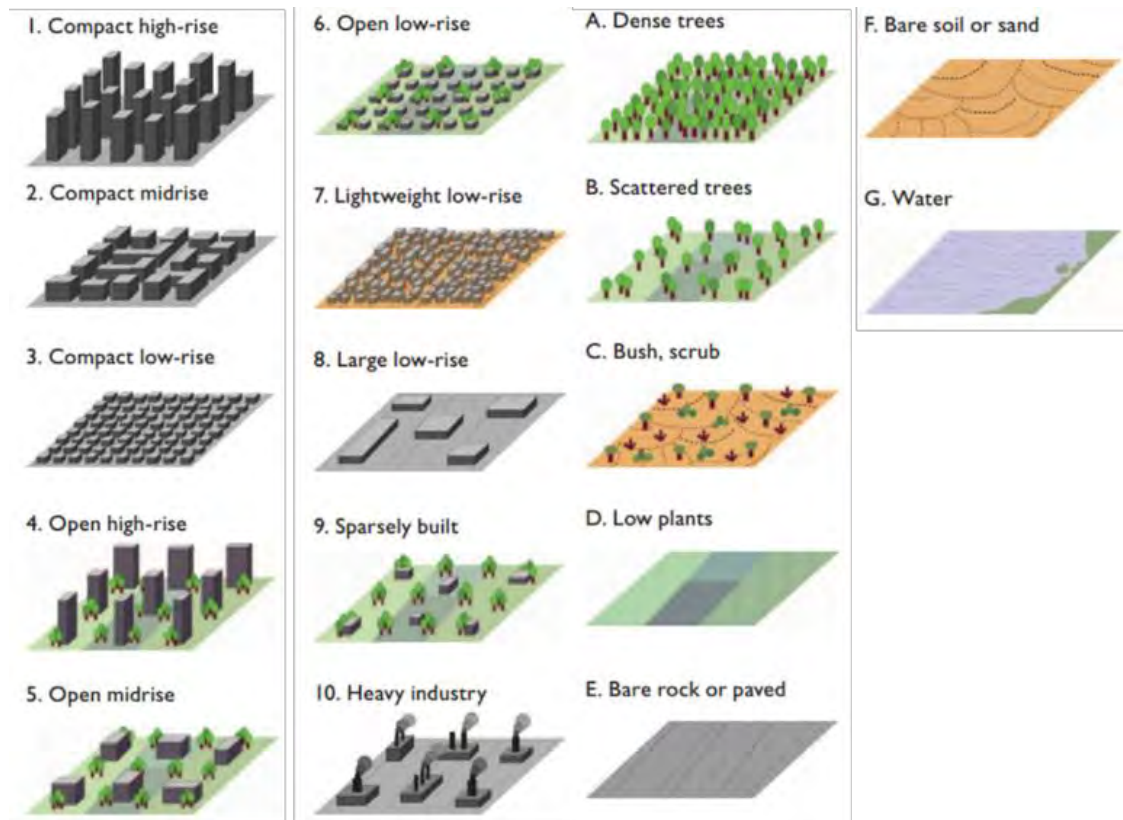

Figure 2: Local climate zone classification

2.3 Thermal conditions data

The thermal conditions data applied in the study is obtained from car traverse measurement on several thermal parameters in the previous project of Tainan cities, named “The development of urban thermal environment climatic map and hotspot analysis.” The physiologically equivalent temperature (PET), which has been widely used to evaluate thermal comfort in outdoor spaces, based on the heat balance model of the human body (Höppe 1999; Matzarakis et al. 1999; Mayer and Höppe 1987; VDI 1998), are applied in this study for the evaluation of thermal condition in urban outdoors spaces at pedestrian level.

3. RESULT

3.1 The accuracy of LCZ classification by WUDAPT

Figure 3 shows the level 0 LCZ information in Tainan, it is obvious that the core area of Tainan is consisted of LCZ2 (Compact mid-rise) and LCZ3 (Compact low-rise), and the surrounding suburban areas are consisted of c represented as green area and water areas. In order to examine the accuracy of the LCZ generated by the WUDAPT approach and the land-use/ land-cover and building height in reality, the focus area has been selected and comparted, as show in Figure 4

In the focus area we choose the LCZ1 (Compact high-rise) area which is identified by the WUDAPT method and examine whether the height is correct compared the actual height by the building digital map. Finally, 33 grids (comprising 100m*100m for each grid) is selected for the analysis. Figure 5 shows the frequencies of actual building floors in the LCZ1 group classified by the WUDAPT in focus area in Tainan city. There are totally 2080 buildings in these LCZ1 areas.

In the definition of WUDAPT, it should be higher than 10 floor height. However, Figure 5 shows that more than 1445 building (approximate 70% of the total buildings) are lower than 7 floors, and the average height is 4.2 floors. It indicated that the WUDAPT may overestimate the building height compared to the actual height by the building digital map.

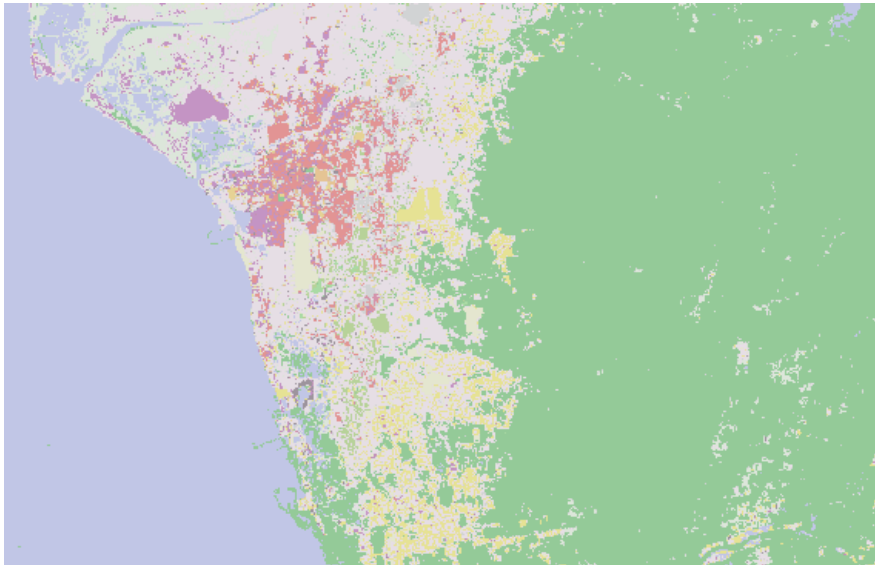

Figure 3: The LCZ map in Level 0 in Tainan city



Figure 4: Focus area in Tainan city

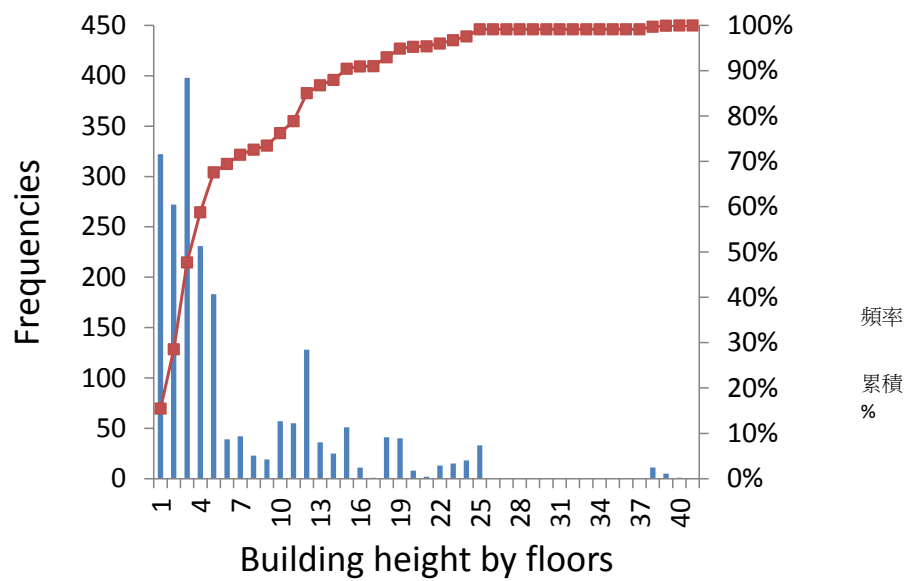

Figure 5: Frequencies of actual building floors in the LCZ1 group classified by the WUDAPT in focus area in Tainan city

3.2 The thermal conditions in various LCZ

Concerning the previous mentioned project on car traverse measurement, the PET of value of each LCZ is analyzed to examine whether the thermal conditions distributions will variate in different LCZs. Figure 6 shows the PET frequency distributions of four types of LCZ that are associated to different distinguishing feature, areas belong to LCZ2 (Compact mid-rise) and LCZ3 (Compact low-rise) have a higher thermal stress distribution, and areas belong to LCZ 6 (Open low-rise), LCZ 9 (Sparsely built) were contrary in low thermal stress. The kurtosis curves for LCZ6 and LCZ9 were higher than those for LCZ2 and LCZ3, revealing that the grids that were associated with LCZ6 and LCZ9 were more likely to have a low thermal load (34 – 35.5°C PET). The grids that were related to LCZ2 and LCZ3 were more likely to suffer from a high thermal load (> 35.5°C PET). Influenced by boundary effects, some grids, such as those associated with LCZ2 and LCZ3, had relatively low kurtosis curves, affecting the performance of nearby grids. The PET values of the LCZ2 and LCZ3 areas have higher variance, indicating that the grids that are associated with LCZ2 and LCZ3 will have a higher thermal load.

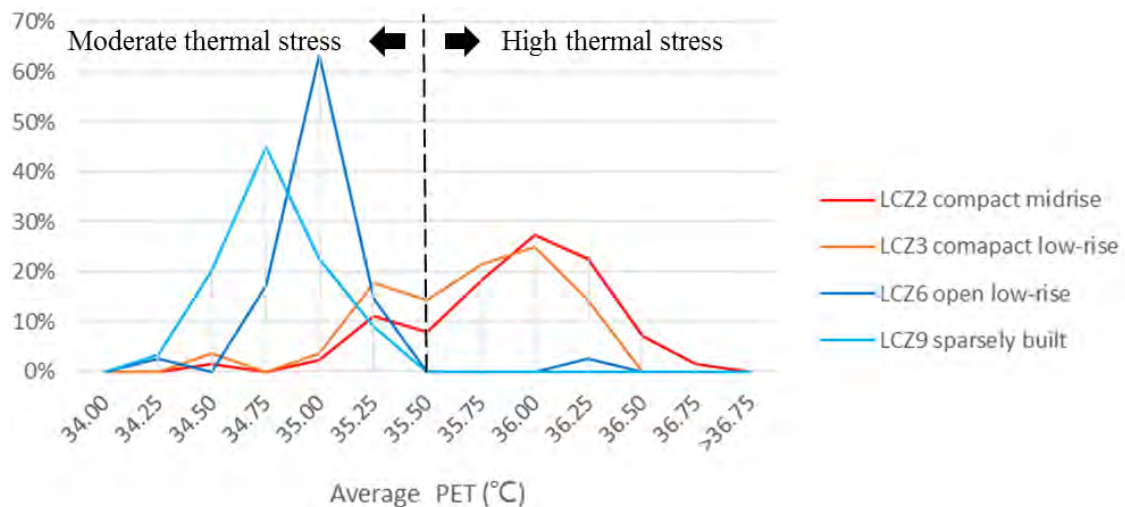

Figure 6: PET frequency distributions of four types of LCZ

4. CONCLUSIONS

Concerning the previous mentioned project on car traverse measurement, the PET of value of each LCZ is analyzed to examine whether the thermal conditions distributions will variate in different LCZs. Figure 6 shows the PET frequency distributions of four types of LCZ that are associated to different distinguishing feature, areas belong to LCZ2 (Compact mid-rise) and LCZ3 (Compact low-rise) have a higher thermal stress distribution, and areas belong to LCZ 6 (Open low-rise), LCZ 9 (Sparsely built) were contrary in low thermal stress. The kurtosis curves for LCZ6 and LCZ9 were higher than those for LCZ2 and LCZ3, revealing that the grids that were associated with LCZ6 and LCZ9 were more likely to have a low thermal load (34 – 35.5°C PET). The grids that were related to LCZ2 and LCZ3 were more likely to suffer from a high thermal load (> 35.5°C PET). Influenced by boundary effects, some grids, such as those associated with LCZ2 and LCZ3, had relatively low kurtosis curves, affecting the performance of nearby grids. The PET values of the LCZ2 and LCZ3 areas have higher variance, indicating that the grids that are associated with LCZ2 and LCZ3 will have a higher thermal load.

REFERENCES

- [1] Kent E (2011) Wind Patterns and the Heat Island in Phoenix, Arizona: 1993-2008. J Arizona Nevada Acad Sci 42(2): 92-103.
- [2] Stewart ID, Oke TR. Local climate zones for urban temperature studies. Bulletin of the American Meteorological Society 2012; 93(12): 1879-1900.
- [3] Stewart I.D., Oke T.R., Krayerhoff E.S. Evaluation of the 'local climate zone' scheme using temperature observations and model simulations Int. J. Climatol., 34 (2013), pp. 1062

Building Envelopes and their Impact on our Urban Thermal Environment

MAING Minjung^a

^a University of Hong Kong, Hong Kong SAR, maing@hku.hk

ABSTRACT

The way we design our buildings and place them in urban areas, affects our outdoor urban thermal environment through large thermal fluctuations, also described as urban heat island effect. The building envelope is the outer layer of the building that interacts most closely with the outdoor climate conditions and impacts the outdoor through diffuse and reflected radiation off its surface onto pedestrian spaces and streets. How the envelope is designed and positioned can have significant impact and should be considered during the building design process. This paper will discuss the methodology adopted to collect field test data and data analysis findings to describe the effects of different design configurations of building envelopes on pedestrian environment.

Field testing was done in various sites in Hong Kong to measure radiant heat flux of sites of varying amounts of 5 main materials: exterior concrete walls, exterior windows, greenery, adjacent open space areas and visible sky. These materials were then extracted through the dissection of fish-eye photographs to isolate and determine ratio of each of the materials, referred to as view factor analysis. The four main view factors used or developed were: sky view factor, sunlit view factor, green view factor, glass view factor. These view factors were studied against the radiant fluxes to find key discoveries of the relationship between short-wave and long-wave radiation and mean radiant temperature (MRT) which is a thermal index used to understand the thermal comfort of a person from net radiant heat loss and gain. Some of the findings are summarized as the more spread apart building or lower height building envelopes may increase short wave radiation however reduce long-wave radiant heat flux meaning less trapped heat within the buildings. Glass buildings performed badly under direct sun, however under indirect sunlight conditions, performed better than opaque concrete building envelopes.

Keywords: micro-climate, building envelope, view factor analysis

1. INTRODUCTION

The building envelope is the outer-most interface of the building between the outdoor and indoor environment and in contemporary building design, this separation forms clear demarcation between outdoor as public space and indoor as private space. The impact of the building envelope during the design process is typically considered for indoor thermal comfort. More recently, with increased attention to the effects of buildings on urban environment and climate change, the effect of the building envelope on outdoor urban thermal environment is an emerging research topic and this paper describes research conducted on buildings envelopes in a high density city of Hong Kong.

Buildings affect our outdoor environment through large fluctuations of temperature from stored and trapped heat as observed as urban heat island effect. Research has been conducted on studying the impact of building masses and of urban parks in cities using field measurement and computer simulation methods analysing outdoor thermal environment. It is generally agreed that urban configurations play an important role in the urban thermal balance. This paper describes the field measurement methodology used and a new approach of data analysis through a close examination of view factors and radiant flux to investigate the relationship between building envelope and outdoor thermal environment.

2. METHODOLOGY

2.1 Outdoor thermal environment

The outdoor thermal environment is measured by the parameter of mean radiant temperature (MRT) which can be deduced from simulation or through field measurements of temperature and radiation. There are two types of radiation – **shortwave (denoted as 'K')** and **longwave radiation (denoted as 'L')** - that are considered relevant and for reasons diagrammed in Figure 1(a) and (b). Shortwave and longwave radiation is within the thermal radiation spectrum and are important parameters to understand how heat travels in our built environment. Shortwave

radiation is a measure of how much thermal energy is radiated from the sun to the earth and longwave radiation is a measure of how much thermal energy is emitted from the absorbed shortwave energy from the earth to the atmosphere. In our field measurements the shortwave radiation measured is mainly the diffused solar energy in the atmosphere, and diffused and reflected solar radiation from the buildings and objects such as trees. Longwave radiation measured is mainly the emitted (re-radiated) radiation from buildings and objects.

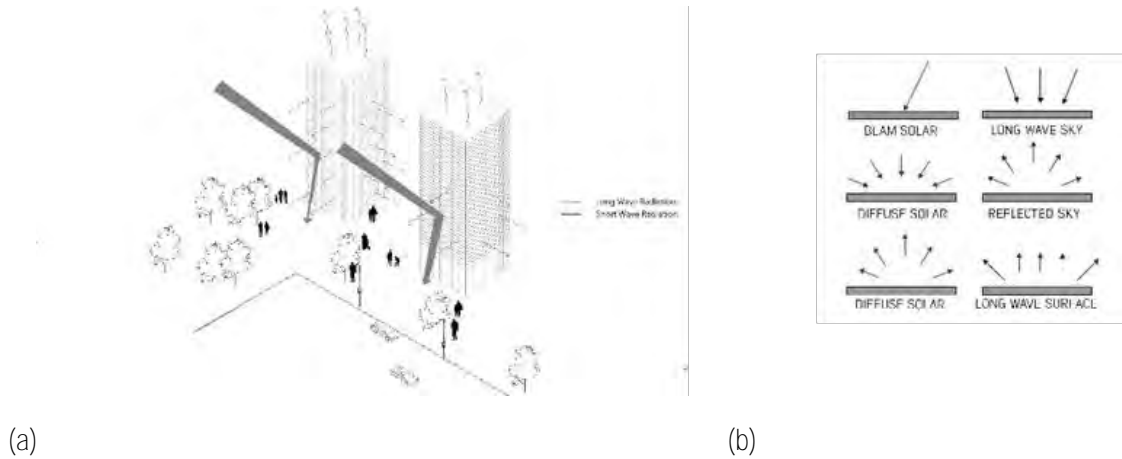

Figure 1: (a) Longwave and shortwave radiation diagram of towers in relation with pedestrian and urban space; (b) Shortwave radiation types (in red) and longwave radiation types (in blue).

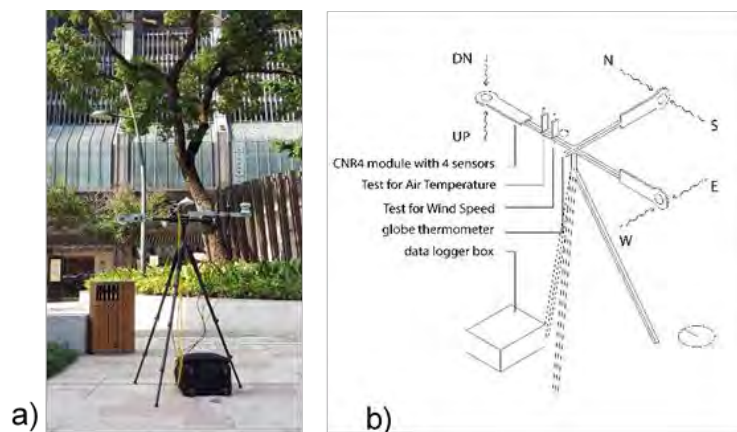

Figure 2: Testing equipment setup for measuring shortwave and longwave radiant flux, temperature, wind speed and humidity.

Thermal comfort parameter – MRT – was calculated based on shortwave and longwave angular factors for a sphere. An integral radiation measurement equipment setup which is one of three common methods of studying the outdoor thermal comfort by researchers was used for this research. A net radiometer (Kipp & Zonen, CNR4) with three integrated pyranometer and pyrgeometer arms was set up at 1.5m above the ground, on a tripod to measure incoming and outgoing shortwave and longwave radiant fluxes within the three-dimension radiation field. The six cardinal points are marked as (N)orth, (S)outh, (E)ast, (W)est, UP and Down where each represents the radiation coming from the noted direction, also shown in the equipment diagram Figure 2b. The Stefan-Boltzmann equation is used to calculate MRT using the measured radiation from six cardinal direction. The CNR4 equipment was used at selected test sites throughout Hong Kong, further described in Section 2.3, and place in shaded conditions to avoid direct sunlight exposure which may cause higher temperature readings due to this exposure.

2.2 View factor analysis

The geometry of the built surfaces and related obstruction of the sky within the city is studied through canyon geometry or sky view factor (SVF), calculated through fish-eye photos, and represents the ratio between radiation

received by a planar surface and from the hemisphere radiating environment. Relationships between the air temperature difference and SVF have been studied by means of regression analysis and found to be closely correlated in diverse climates including Hong Kong. For this study, as the focus was identifying how the different vertical building surfaces and materials affected the urban environment, the research began to further dissect the areas related to these factors. The four main view factors identified fundamental were the widely-used SVF, sunlit view factor (SLVF), green view factor (GnVF) and glass view factor (GsVF). SLVF represents the ratio of vertical building surface area receiving direct solar radiation (i.e., cast with direct sun) which then also, inversely counts for the wall areas that are shaded either due to the sun angle or the configuration of surrounding buildings. GnVF, alternately represents the ratio of greenery within the fish-eye lens photo, in order to capture the effect of greenery within the studied hemispheric radiated environment of the urban canyon. GsVF represents the ratio of glass walls receiving radiation within the hemispheric radiated environment. Table 1 shows the visual categorization of these four view factors.

2.3 Site and testing

There were 12 sites selected within Hong Kong for field testing, each site having characteristics of typical and comparable building envelope types and material, and urban configuration (i.e., building layout). To further quantify this range, a design of experiment matrix was developed (Table 2) that represents the range in each view factor for all the sites selected. This method allowed the research team to ensure that the pool of tested sites had conditions to study the effect of the four view factors on the urban thermal environment. From the 12 sites, about 85 data point were collected and multiple regression analysis was conducted to study the relationship between the various view factors and longwave, shortwave radiation and MRT. Most of the testing was conducted in the months of April to September 2015 and during clear to overcast days.

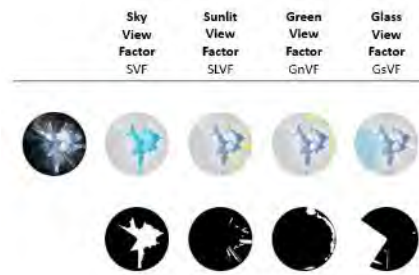

Table 1: Segmentation of the fish-eye lens photo into sky view factor, sunlit view factor, green view factor and glass view factor.

Factors	Levels		
	-	0	+
A. Sky View Factor			
B. Sunlit View Factor			
C. Green View Factor			
D. Glass View Factor			
E. (Solar Radiation, Cloud cover)			

Table 2: Five factors and levels, urban fabric experiment (based on fish-eye photos toward sky)

3. RESULTS AND DISCUSSION

The multiple regression analysis of shortwave (K) and longwave (L) against the four view factors: SVF, SLVF, GnVF and GsVF are shown in the following Tables 3, 4, 5, and 6 respectively. Five minutes mean values were used to determine the data points from 4 to 6 sites per view factor regression analysis.

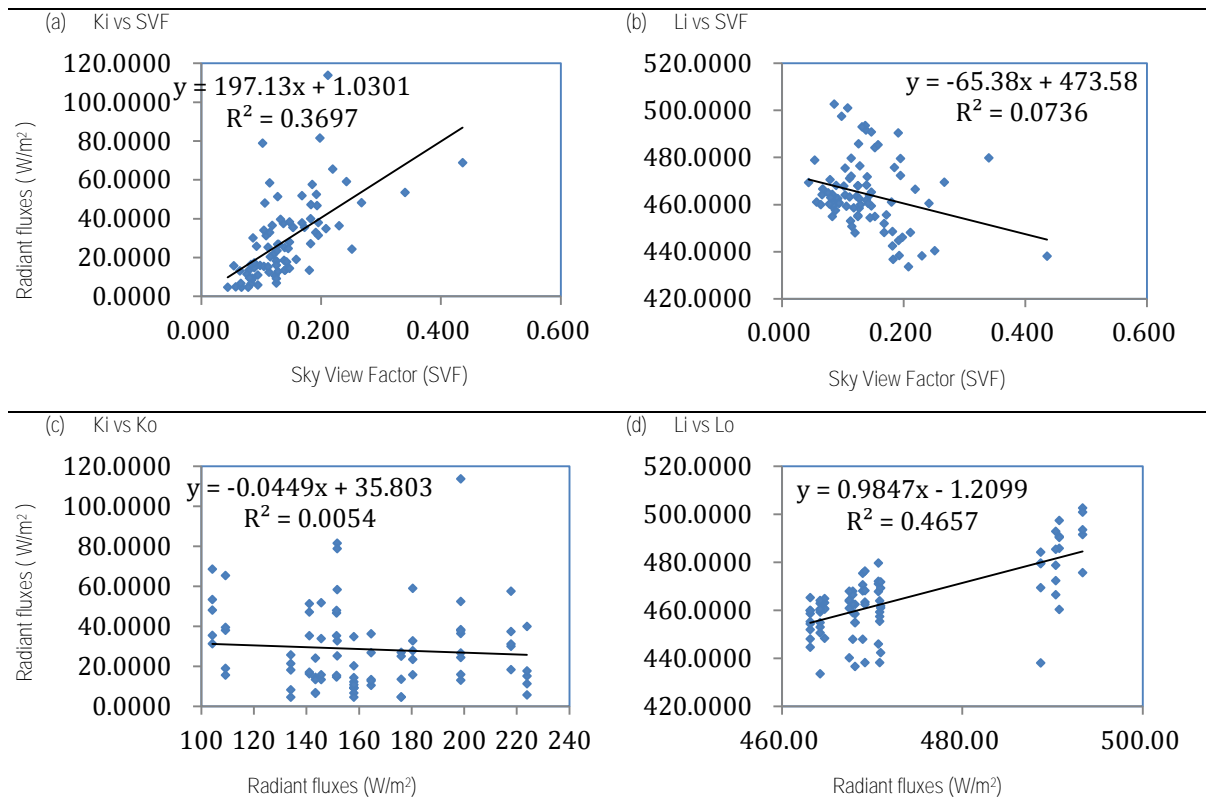

Table 3: Scatter plots for radiant fluxes using 5-min mean values against SVF.

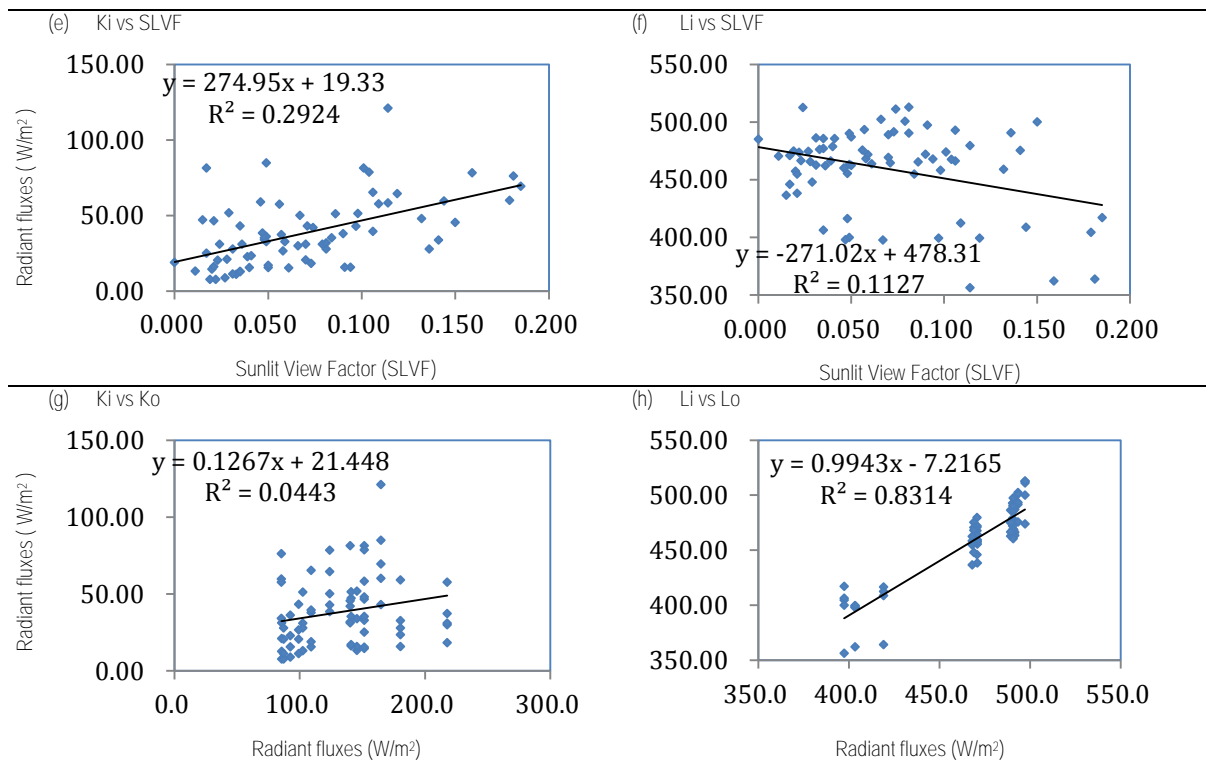

Table 4: Scatter plots for radiant fluxes using 5-min mean values against SLVF

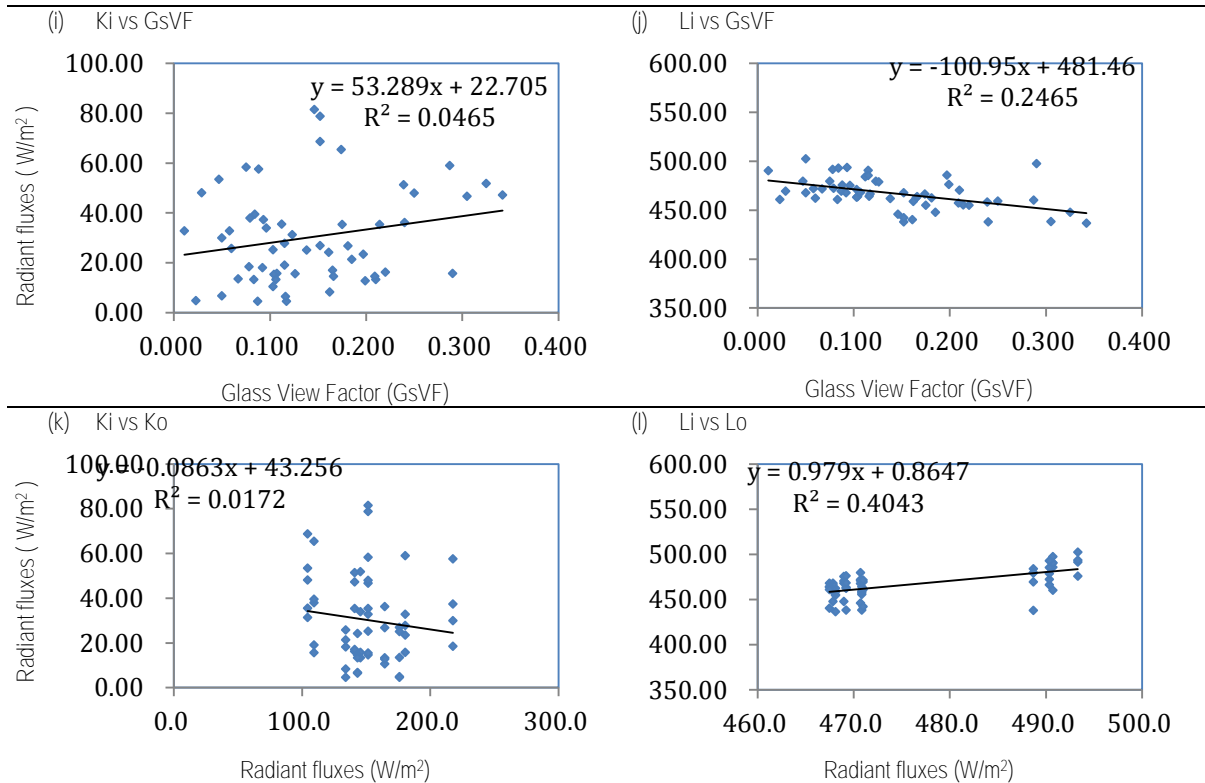

Table 5: Scatter plots for radiant fluxes using 5-min mean values against GsVF

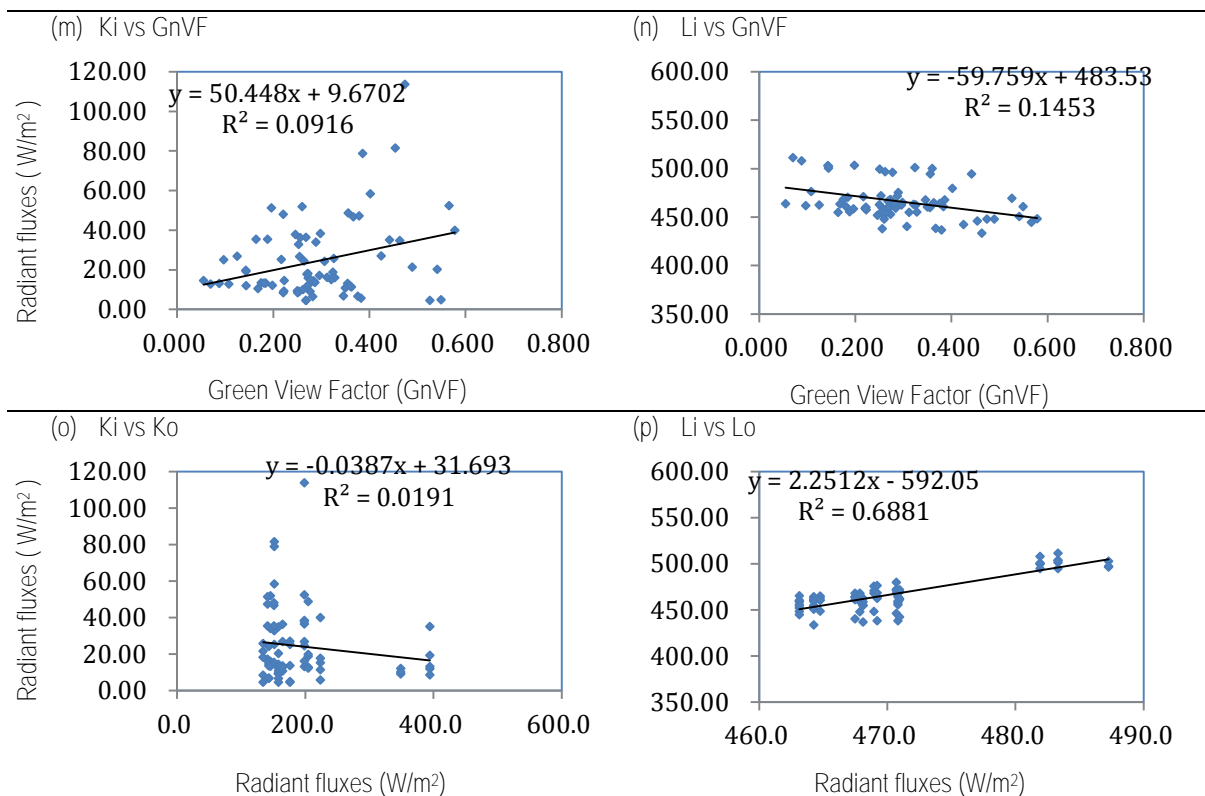

Table 6: Scatter plots for radiant fluxes using 5-min mean values against GnVF

To summarize the regression analysis above in terms of shortwave and longwave radiation, the relative strength table (Table 7) was produced to get a better comparison insight of how sunlit area (SLVF), greenery density (GnVF) and glass wall surfaces (GsVF) can affect shortwave radiation effects (K) and longwave radiation effects (L) for every increase or decrease in visible sky (SVF).

Shortwave radiation increases by all four elements of sky, sunlit wall area, greenery and glass independently by a ratio factor of 1, 0.7, 0.1 and 0.3 respectively. However, the effect of greenery seems to be quite minimal and can be considered negligible in respect to shortwave radiation reflected and diffused from building envelope wall areas receiving direct sun exposure. Shortwave radiation is more significantly affect and increased by:

- More visible sky
- More concrete wall area receiving direct sunlight
- More glass wall area

Although shortwave radiation is considered a significant factor, longwave radiation results provide a better conclusion of how building envelope impacts the thermal environment.

Longwave radiation is affected differently from shortwave radiation in that increases in sunlit wall area causes increase in longwave radiation by ratio of 1:0.5. For elements of sky, greenery and glass decreases in these ratio factors by -1, -0.2 and -0.5 respectively causes increase in longwave radiation. This means that more densely packed built environments where sky visibility is reduced will increase longwave radiation. Reducing the amount of greenery will increase longwave radiation. Reducing glass within the building envelope surface (therefore increasing the amount of concrete building envelope material) in shaded conditions, will increase longwave radiation. To reduce longwave radiation the following could be deduced:

- More visible sky
- Reduce amount of concrete wall area receiving direct sunlight
- Increase greenery
- Increase glass wall area in shaded orientations (i.e., such as north, northeast and northwest facing walls).

Increasing the amount of sky visible in an urban open space between buildings is a positive attribute for psychological human comfort and reducing longwave radiation, therefore although it increases the amount of shortwave radiation due to the direct sunlight entering the open space, the key is to reduce the allow space to let the shortwave radiation reflect and diffuse away beyond the open space.





				
	SVF (+1 unit)	SLVF (+1 unit)	GnVF (+1 unit)	GsVF (+1 unit)
Shortwave radiation, K	1 1 1	0.7	0.1	0.3
Longwave radiation, L	-1 -1 -1	0.5	-0.2	-0.5

Table 7: Relative strength of view factors and their effect on increases in shortwave and longwave radiation.

The final relative strength matrix summarizes the effects of thermal radiation on pedestrians due to orientation and layout of building envelope, cast sunlight on building envelope, greenery and glass envelopes.

4. CONCLUSION

The results indicate that the thermal environment is mostly affected by the positioning of the building envelope in respect to the canyon geometry and amount of direct solar radiation received by the building envelope. This can be translated to mean that having more sky visible between buildings where building envelopes are smaller masses (lower building) or more spaced apart will allow for relief of shortwave and longwave radiation trapping, which in turns means the MRT will experience less rise. Allowing more sky to be experienced by the pedestrian, also alleviates the urban heat island effect. The wall area receiving direct solar has significant impact on affecting both shortwave and longwave radiation. Greenery affects longwave radiation and should be considered a material to

combat the effects of large thermal mass (concrete) receiving direct solar and re-radiating out to the environment increasing MRT.

REFERENCES

- [1] Arnfield, AJ (1982) An approach to the estimation of the surface radiative properties and radiation budgets of cities. *Physical Geography* 3:97-122.
- [2] Giridharan, R, Lau, SSY, Ganesan, S, Givoni, B (2007) Urban design factors influencing heat island intensity in high-rise high-density environments of Hong Kong. *Building and Environment*. 42: 3669-3684.
- [3] Svensson, M (2004) Sky view factor analysis – implications for urban air temperature differences. *Meteorological Application* 11 201-211.
- [4] Thorsson, S, Lindberg, F, Eliasson, I, Holmer, B (2007) Different methods for estimating the mean radiant temperature in an outdoor urban setting. *International Journal of Climatology*. 27:1983-1993.

Urban Geometry and Wind Simulation Studies for Comfort in Bangkok Street Canyon

Pattaranan TAKKANON^a

^a Kasetsart University, Thailand, pattaranan.t@ku.th

ABSTRACT

The increase of densely built-up areas in Bangkok aggravates Urban Heat Island phenomenon. Urban geometry as formed by the relationship of building height and street width or height-to-width ratio is a contributing factor to UHI. While the street canyon can provide self-shading during the day which is good for hot-humid regions, the deep street canyon influences heat absorption and airflow in the city, resulting in trapping air pollutants especially at the pedestrian level. Therefore, it is important to find optimum urban geometry for thermal comfort and enhancing airflow for public health. Wind studies were conducted using CFD simulation for uniform urban block arrays. Height-to-width ratios were varied for 95 cases. Results show that height-to-width ratios ranging from 1 to 2 can generate turbulence for heat mitigation and air pollution dispersion. The minimum height-to-width ratio recommended is 0.5 while the minimum building height is 9 meters. The minimum road width recommended is 12 m. However, the width of 34 m is preferable for heat mitigation and promoting air circulation.

Keywords: urban geometry, wind simulation, street canyon

1. INTRODUCTION

Urbanization has a significant impact on shaping the city. The densely built-up areas trap the heat within urban canopy causing urban environments to be warmer than their surroundings especially during the night time. This phenomenon is known as Urban Heat Island (UHI). There are many factors contributing to UHI including canyon geometry, thermal properties of materials, anthropogenic heat released from combustion and metabolism, and lack of green spaces. Among these factors, the canyon geometry has an impact on the type and magnitude of urban airflow as well as the short and long wave radiation balance in the canyon. It is also suggested that the urban geometry is much more important at the microscale than the thermal behaviour of materials and the albedo effect.

The urban canyon is considered very critical for UHI investigation since the canyon is formed with buildings along roadsides. The geometrical characteristics of the urban canyon are defined by height-to-width ratio, (H/W ratio) or aspect ratio which has been found to correlate significantly and directly with the UHI effect. It influences urban shading and ventilation for passive cooling and air pollution dispersion, thus affecting people's thermal comfort and health.

The temperature distribution in the canyon is influenced by the canyon surface temperatures and energy transfer depends on convective process. A study in Athens concluded that air temperature in the canyon is not greatly influenced by street orientation either during the day or during the night but is mainly controlled by the airflow process.

Whilst UHI has been studied extensively in many countries especially in temperate climates, there is still a need for more research in the tropics. It is also the case of Bangkok where only a few studies were found. At macro-scale level, urban heat island intensity of Bangkok was studied based on meteorological data. Nonetheless, at micro-scale level, there is still a big gap of knowledge on urban geometry in relation to UHI effect. Even though airflow is crucial for heat mitigation, the overheating conditions in urban areas of Bangkok are affected by the lack of airflow to enhance outdoor thermal comfort and air pollution dispersion. Therefore, the study is an attempt to investigate effect of height-to-width (H/W) ratio on airflow at pedestrian level in the street canyon. The research is supported by the National Research Council of Thailand and results from the study will be taken into consideration for establishing urban geometry design guidelines to promote wind for heat and air pollution mitigation in urban area of Bangkok.

2. LITERATURE REVIEW

2.1 Air movement and thermal comfort in hot-humid climate

Environmental factors of thermal comfort include air temperature, humidity, mean radiant temperature, and air velocity. The air movement produces physiological cooling effect by increasing evaporation from the skin. For hot-humid climate, the desirable wind speed at body's skin is 1-1.5 m/s or within the limit of 2 m/s. This is in accordance with results from field studies in the sub-tropical climate of Hong Kong as under summer condition, air velocity of 1.0-1.5 m/s would likely satisfy 80% of building occupants thermally. The studies in India and Iran show a reduction in thermal discomfort at 32-40°C with air velocity greater than 0.25 m/s. Field studies in the warm and humid climate of Bangladesh also present an increase in comfort temperature with air velocities greater than 0.3 m/s.

Providing channels for airflow distribution is a way to promote thermal comfort in the city. Urban design requires Air Ventilation Assessment (AVA). The assessment height for pedestrian level is 1.5-2 meter above ground. To evaluate the effect of wind speed on outdoor thermal comfort, wind speed classification is derived based on Physiological Equivalent Temperature (PET).

2.2 H/W Ratio and urban airflow

Densely built-up areas tend to have street canyons with high aspect ratios. In general, the canyon has ratio approximately equal to 1 without major openings on the walls. An aspect ratio below 0.5 defines shallow canyon while a value of 2 represents the deep one.

Urban wind flow conditions can be improved by providing ventilation paths, mixing building heights, and increasing building height while decreasing land coverage. The latter strategy was found most efficient as it can increase wind velocities by up to 2.4 times of the real case.

An investigation in Singapore shows that placing a few high-rise towers will enhance the airflow inside the canyon thereby reducing the air temperature. An optimum H/W ratio for the canyons can increase the velocity by up to 35% and reduce the corresponding PET by up to 0.7oC.

2.3 CFD numerical simulation

Wind flow in the city is commonly studied using field measurement and numerical simulation methods known as Computational Fluid Dynamics (CFD). Even though the measurement method gives quantitative information about ambient air temperatures and velocities at specified locations and times, it cannot identify causes of the problem. Air modeling is, on the other hand, widely used for parametric studies in order to determine cause and effect from individual and combined parameters influencing airflow conditions.

In order to verify results from field measurement and CFD simulation, most models created are non-uniform to simulate real situation. Nevertheless, uniform modeling is generally used to study effect of individual parameter as it is more controllable. Two-dimensional and three-dimensional models are commonly produced for the studies.

3. BANGKOK'S CHARACTERISTICS

Bangkok is situated at 13.44oN latitude. It is in the central region of Thailand covering total area of 1,568.74 sq.km. The city has approximately registered population of 5.7 million and a hidden population of 2.6 million (in 2010). It has a diurnal temperature range of minimum 22.5oC to 26.9 oC and maximum 32.1 oC to 36.3 oC. A mean annual temperature is 27.8 oC and a mean annual RH is 79.9%. The minimum RH is 74% in January and the maximum RH is 85% in September. Bangkok experiences only moderate wind speed. The average wind velocity at 10 meters above ground is 1.7 m/s. The street canyons in densely built areas of Bangkok are blocked by tall buildings, therefore calm periods and stagnant conditions possibly occur.

4. STUDY METHODS

The research adopts CFD method to study urban airflow conditions influenced by H/W ratios or aspect ratios ranging from 0.1 to 2 as the maximum permitted by Thai regulation. Road widths are 12, 18, 24, 34, 64, and 94 meters, respectively. These widths include the actual road width and possible 6-meter setback distance. Building heights are then calculated according to the relationship between H/W ratios and road widths. There are 95 simulation cases possible for the specified range of H/W ratios as shown in Table 1. The simple geometry with aspect ratios above 1 are expected to produce a skimming flow regime in the street canyon.

The commercial CFD simulation program, DesignBuilder is employed for calculation. The numerical models are **uniform regardless of the effect of building's length and width. Domain size is 1000 m × 1000 m. All buildings are square shape and areas considered are at intersection providing identical street canyons on the direction parallel and perpendicular to prevailing wind.** In the studies, the wind direction is set to come from the south. The reference wind velocity is 1.7 m/s as it is the average wind velocity at 10 meters above ground in Bangkok. Wind profile is specified for urban area. The computational domain is **k-ε which is for turbulence modeling. Area for consideration on horizontal plane is 1.5 meters above ground to investigate airflow at pedestrian level while sectional area across the canyon is made vertically to investigate air velocities on leeward and windward sides.**

H/W	Road width					
	12	18	24	34	64	94
	Building height					
0.1	-	-	-	-	6.4	9.4
0.2	-	-	-	6.8	12.8	18.8
0.3	-	-	7.2	10.2	19.2	28.2
0.4	-	7.2	9.6	13.6	25.6	37.6
0.5	6	9	12	17	32	47
0.6	7.2	10.8	14.4	20.4	38.4	56.4
0.7	8.4	12.6	16.8	23.8	44.8	65.8
0.8	9.6	14.4	19.2	27.2	51.2	75.2
0.9	10.8	16.2	21.6	30.6	57.6	84.6
1	12	18	24	34	64	94
1.1	13.2	19.8	26.4	37.4	70.4	-
1.2	14.4	21.6	28.8	40.8	76.8	-
1.3	15.6	23.4	31.2	44.2	83.2	-
1.4	16.8	25.2	33.6	47.6	89.6	-
1.5	18	27	36	51	96	-
1.6	19.2	28.8	38.4	54.4	-	-
1.7	20.4	30.6	40.8	57.8	-	-
1.8	21.6	32.4	43.2	61.2	-	-
1.9	22.8	34.2	45.6	64.6	-	-
2	24	36	48	68	-	-

Table 1: Simulation cases

5. RESULT ANALYSIS

Since urban canyon has an impact on airflow characteristics, whether to generate vortex and turbulence, the areas considered in the studies are on leeward and windward sides in the canyon as specified in Figure 1.

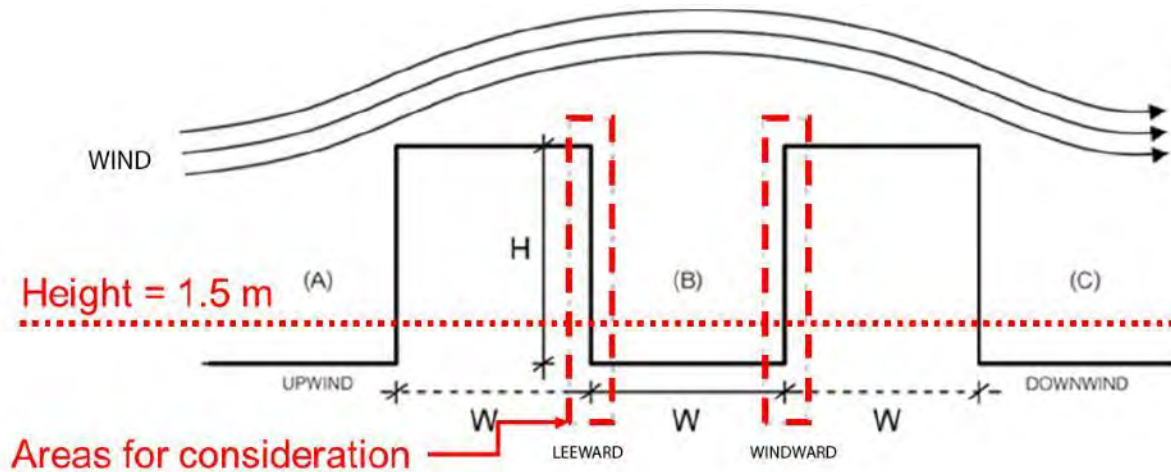

Figure 1: Areas for investigation

Results from the simulation show that wind velocities at pedestrian level in the street canyon perpendicular to the prevailing wind range from 0-0.18 m/s which cause still air. In the canyon parallel to the prevailing wind, the velocities range from 0.73-0.91 m/s which can enable thermal comfort and enhance air pollution dispersion. However, laminar flow occurs when building heights do not exceed 9-9.4 m (3 storeys).

Turbulence and vortex are profound on building's edges and downwind area when H/W Ratios are not less than 0.2 and building heights are above 9-9.4 m (3 storeys). Turbulences is likely to occur with increasing building height in association with increasing road width. The increase in pressure difference between the upwind and the downwind areas is noticeable for the cases with $H/W = 0.4$ and $W = 64$ meters. Turbulent flows are distinct. Wind velocities on windward side are generally higher and more distributed in the area than those on leeward side as the radar chart in Figure 2 shows percentages of areas on leeward and windward sides with the frequencies of low, medium and high velocity occurrence.

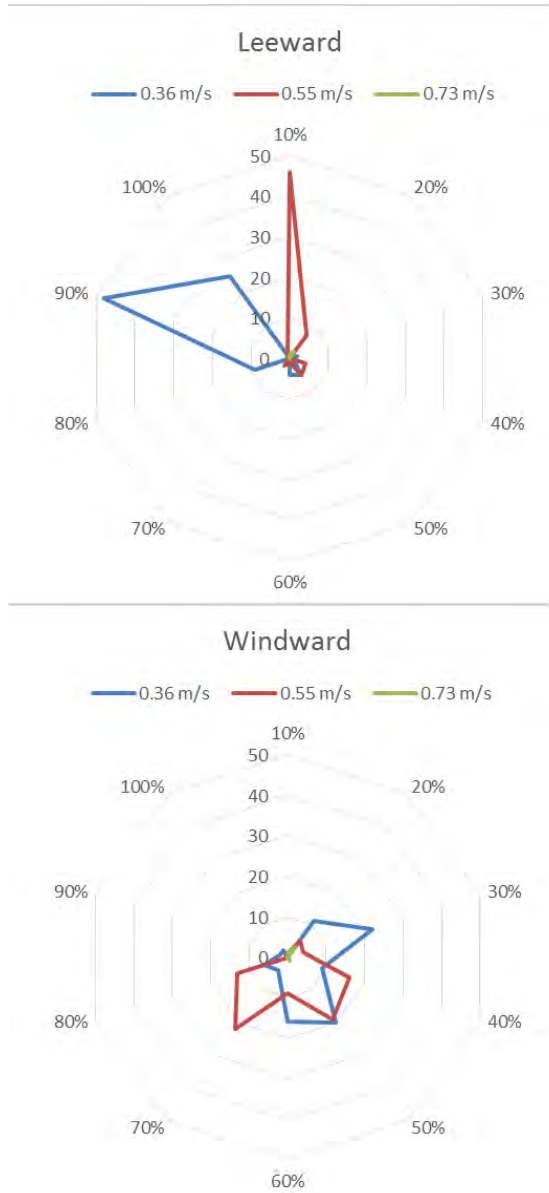

Figure 2: Percentage of area covered with 3-level wind velocities on leeward and windward sides

	Plan	Section
H/W Ratio = 0.1; H = 6.4 m.; W = 64 m.		

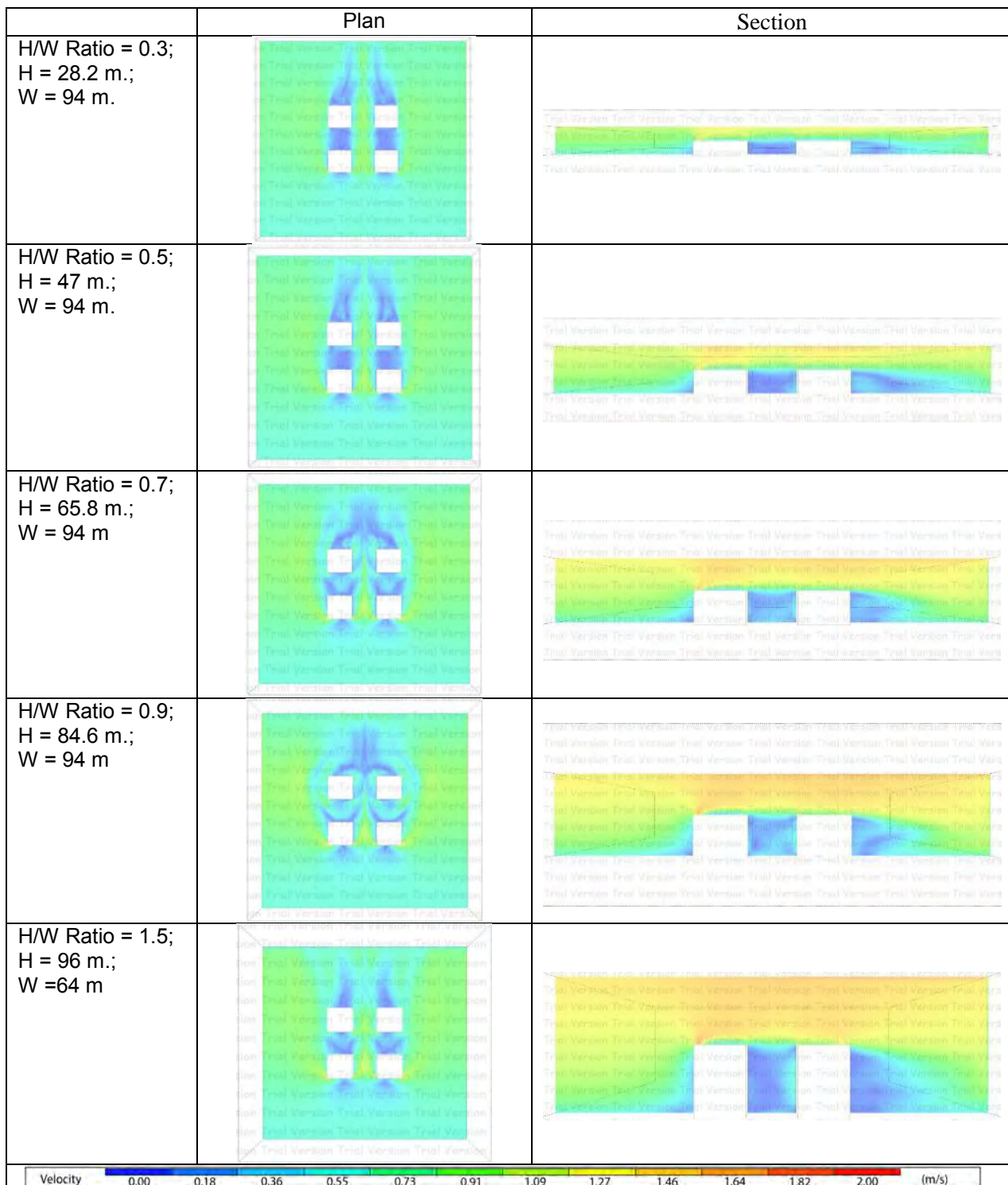

Table 2: Examples of simulation cases

Table 2 show examples of simulation results of low (less than 0.5), medium and high values of H/W ratios (above 0.5). Wide roads greatly influence turbulence as shown in models with H/W ratios higher than 0.5.

H/W Ratios range from 1-2 can generate turbulence for heat mitigation and air pollution dispersion. The turbulent flow can occur even when the road width is only 12 meters. However, the influences of high H/W ratio are profound when width = 34 meters. For the road of 12, 18, 24 and 34 meter wide, airflow patterns remain the same with increasing potential of turbulence. However, in cases of road width greater than 64 meters, the pattern is different.

On downwind side, vortices occur in the middle of street canyon as shown in the example case of 1.5 H/W ratio with 64-m road width. H/W ratios ranging from 0.5-1.1 potentially promote wind distribution in wider area especially when associated with wide roads: 34, 64, and 94 meters. Based on the overall simulation cases, it is found that the minimum H/W ratio should be 0.5 while the minimum building height should be 9 meters. The optimum road width is 34 meters.

6. CONCLUSION

Results from the study show that medium to high H/W ratios tend to increase air velocities and create turbulence in the canyon, thus promoting cooling effect for pedestrians. Therefore, it is possible to promote high density development for Bangkok. Nonetheless, it is required to balance between high H/W ratio and road width to avoid too deep canyon that traps heat during the night. It is recommended that stagnant conditions in the canyon can be improved by providing wind channel on ground level of buildings especially those that are situated along narrow roads. The recommended H/W ratios range from 0.5-2 while road width should not be less than 12 meters and not less than 34 meters is preferable.

REFERENCES

- [1] K NIACHOU, I. L., M SANTAMOURIS. 2008. Experimental study of temperature and airflow distribution inside an urban street canyon during hot summer weather conditions. Part II: airflow analysis. *Building and Environment*, 43, 1393-1403.
- [2] TODHUNDER, P. E. 1990. Microclimatic variation attributable to urban canyon asymmetry and orientation. *Physical Geography*, 11, 131-141.
- [3] BAKARMAN, M. A., AND CHANG, JAE D. 2015. The influence of height/width ratio on urban heat island in hot-arid climates. *Procedia Engineering*, 118, 101 – 108.
- [4] SANTAMOURIS, M. 2001. *Energy and climate in the urban built environment*, London, James & James Science Publishers.
- [5] ARIFWIDODO, S. D. 2015. Factors Contributing to Urban Heat Island in Bangkok, Thailand. *ARPN Journal of Engineering and Applied Sciences*, 10, 6435-6439.
- [6] SZOKOLAY, S. 2004. *Introduction to architectural science: the basis of sustainable design*, Oxford, Architectural Press.
- [7] NG, E. 2009. Policies and technical guidelines for urban planning of high-density cities – air ventilation assessment (AVA) of Hong Kong. *Building and Environment*, 44, 1478-1488.
- [8] NICOL, J. F. 1974. An analysis of some observations of thermal comfort in Roorkee, India and Baghdad, Iraq. *Annals of Human Biology*, 1, 411-426.
- [9] MALLICK, F. H. 1996. Thermal comfort and building design in the tropical climates. *Energy and Buildings*, 23, 161-167.
- [10] YUAN, C., NG, EDWARD. 2012. Building porosity for better urban ventilation in high-density cities- A computational parametric study. *Building and Environment*, 50, 176-189.
- [11] SOTIRIS VARDOULAKIS, B. E. A. F., KOULIS PERICLEOUS, NORBERT GONZALEZ-FLESCA. 2003. Modelling air quality in street canyons: a review. *Atmospheric Environment*, 37, 155-182.
- [12] GUO, F., FAN, YUE, ZHANG, HEZI. Natural Ventilation Performance in a High Density Urban Area Based on CFD Numerical Simulations in Dalian. ICUC9 - 9th International Conference on Urban Climate jointly with 12th Symposium on the Urban Environment, 2015 Météo, France.
- [13] PRIYADARSINI, R., WONG, N H., CHEONG, K W D. 2008. Microclimatic modeling of the urban thermal environment of Singapore to mitigate urban heat island. *Solar Energy*, 82, 727-745.
- [14] BUILTJES, P. 2003. The Problem - Air Pollution. In: P. ZANNETTI (ed.) *AIR QUALITY MODELING - Theories, Methodologies, Computational Techniques, and Available Databases and Software*. EnviroComp Institute and Air & Waste Management Association.
- [15] THE CITY PLANNING DEPARTMENT, B. M. A. 2013.

Research of Urban Heat Island (UHI) in Shenzhen Based on Climatic Design and Urban Planning Strategies

YU Wenjuan^a

^a Ronald Lu and Partners (Hong Kong) Ltd., Hong Kong SAR, yuwenjuan26@gmail.com

ABSTRACT

Urbanization with growing population and economic development in China has resulted in fast expansion of urban areas with rapidly land use change. The newly constructed high density city pattern is to meet the development of cities and at the cost of urban environment. Shenzhen, which regarded as the most rapidly urbanizing city in China in the last three decades is taken as an example to study the urban heat island (UHI) effect. As the urban heat island effect is the most common environmental issue associated with the urbanization and influence the sustainable development of Shenzhen, understanding the urban heat island in Shenzhen is highly important. In this paper, the climate condition of Shenzhen will be presented. Moreover, the performance of urban heat island in relation to urban planning and land use change will be analysed and discussed. Besides, several urban planning strategies are put forward. The conclusion presented in this paper can made available to the designer and used as a reference guideline for achieving sustainable urban planning for Shenzhen.

Keywords: urban regeneration, urban heat island, urban planning strategies

1. INTRODUCTION

1.1 Geography and climate condition of Shenzhen

Shenzhen, which regarded as the fastest developed city in China, is a coastal city belongs to the Pearl River Delta and located at the southeast of Guangdong Province (Huasheng, 1991). It is a liner city surrounded by hills and seas with a total area of 1992 km² hilly terrain (Chen, et al., 2014). The topography condition of Shenzhen is undulating, the southeast part is hilly with mountains which may block the typhoon in summer while the northwest part of Shenzhen is relatively low along the west coast (Ng, 2003). In this case, the land use pattern in Shenzhen is various including cropland, woodland, built up area, water body and unused land and there are four major rivers run through the city (Tianhong, et al., 2010).

Shenzhen enjoy a humid subtropical marine monsoon climate and belongs to the hot summer and warm winter climate zone (Song & Somasundaram, 2009). Influence by the East Asian monsoon, the summer in Shenzhen is wet and hot while the winter is comparatively dry and mild. The climate data for Shenzhen shows that the annual mean temperature is 22.55°C with monthly averages temperature ranging from 11.7°C in January to 32.2°C in July, the city enjoy 1933 hours sunshine per year and the annual rainfall in Shenzhen city is about 1966mm (China Meteorological Administration). In this case, the temperature in summer is high and cause the heat generate in the city which may lead to urban heat island effect.

1.2 Urbanization development of Shenzhen

Within 30 years, Shenzhen has experienced a tremendous change from a small fishing village to a modern city (Che, et al., 2011). Study shows that the population for Shenzhen is only 0.31 million in 1979 (Ng, 2003). With the Open Door Policy in China and the setting up of Special Economic Zone (SEZ) in 1980, the total population of Shenzhen was 4.69 million until 2001. And the urban population was increased to 10.37 million in 2010 (Shi & Yu, 2014). In this case, in order to balance the population grow, the expansion of urban areas with built up zones is needed. As a liner city, the rapid urban sprawl in Shenzhen was developed along several cores to the surrounding areas and there are four main axes for urban develop along west, middle, east and south (Xie, et al., 2013).

The urbanization of Shenzhen shows that the built up areas has extended to the middle of Shenzhen city and the western part along the coast from 1990 to 1994. From 1994 to 2005, the built up areas growing ever faster which occupied west of Shenzhen and expand to north part of Longgang district. The built up space increased from

0.63% to 33.42% while forest decreased from 38.71% to 29.96%; water bodies decreased from 7.41% to 5.64% and wetland decreased 0.21% (Che, et al., 2011).

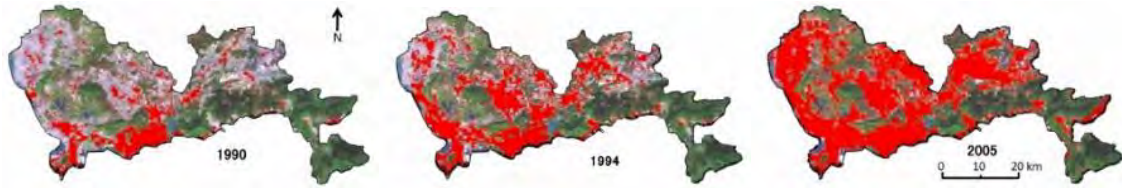

Figure 1: Urbanization pattern in Shenzhen (Che, et al., 2011).

As a result of fast urbanization, Shenzhen is toward a shortage of land and resources, facing high density urban pattern and several environmental problems (Shi & Yu, 2014). For example, stress between industrial, residential and natural land, traffic jam, air pollution, reducing of green open space and urban heat island effect. Among them, urban heat island (UHI) issue is highly relevant to the urbanization process and has huge impact on the sustainable development of Shenzhen.

2. UHI ISSUE OF SHENZHEN

2.1 The special distribution of UHI in Shenzhen

Urban heat island effect is performed that the urban area temperature will be higher than the surrounding countryside (ZHANG, et al., 2011). Study shows that the temperature in Shenzhen is keeping increasing during the past 50 years reaching 28°C in 2005 and the extremely hot day in summer is also increase which gradually heat up the city, the temperature in the city center is approximately 3°C higher than the suburban area (Lin, 2011).

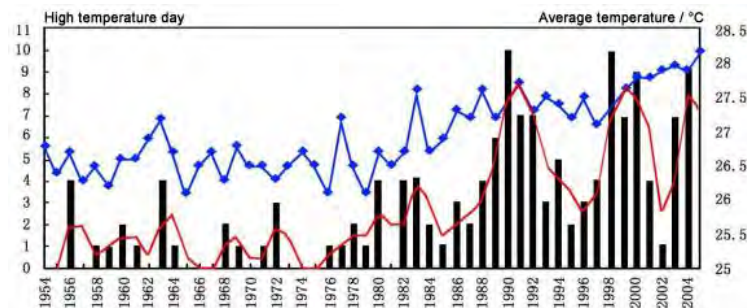

Figure 2: Temperature in Shenzhen (1954 – 2005) (Lin, 2011).

By using regional boundary layer model (RBLM), the studies illustrated that during the daytime, the UHI intensity can reach around 4°C at the western part of Shenzhen (ZHANG, et al., 2011). And the strong UHI effect is happened in **Nanshan, Futian and western Bao'an district with temperature higher than 33°C while other part of Shenzhen are also facing obvious urban heat island effect with the temperature between 31°C to 33°C** (ZHANG, et al., 2011). However, during the nighttime, the high value of UHI happened in the city center with high density in **western Nanshan, western Luohu and western Bao'an district with temperature more than 27°C** (ZHANG, et al., 2011). When it compared with the urbanization pattern of Shenzhen, it can be seen that the high value of UHI intensity happen in the construction areas which means that the urban planning with high density buildings areas will generate urban heat island effect.

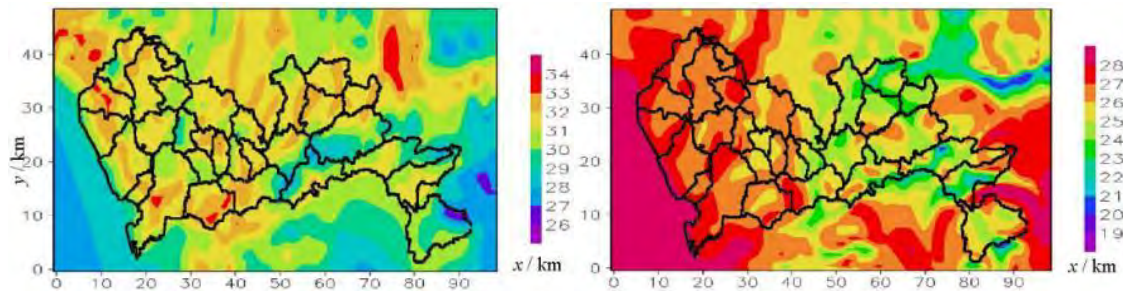

Figure 3: Air temperature during daytime and nighttime (ZHANG, et al., 2011).

2.2 The formation of UHI in Shenzhen

2.1.1. Land use change

Land use change is one of the key factors that generate UHI in Shenzhen. A study indicates that the land use pattern in Shenzhen has toward significant change during 1990 to 2008. The urban land is growing faster along the western coast and main road while the natural land with greenery is decreasing (Chen, et al., 2014). The UHI spatial distribution is highly match the urban land expansion pattern. For land use type of Shenzhen, the developed land dominate most part of the city land while the green land is limited to the mountain areas (Xie, et al., 2013). In this case, the constructed land will increase the surface roughness and have relatively high surface temperature thus generate the urban heat island effect in this areas.

As UHI is characterized by land surface temperature (LST) and land cover and landscape patterns are the two main factors that influence the LST, the vegetation fraction and impervious surface areas of Shenzhen are illustrated below to show the relation between land use and UHI issue (Xie, et al., 2013). It can be concluded that the higher vegetation fraction areas the lower surface temperature and the higher value of impervious surface areas the higher the surface temperature due to the cooling effect of the vegetation. In this case, the reduction of greenery space was one of the reasons that cause UHI effect in Shenzhen.

2.1.2. High density built up areas

From the above analysis, it can be seen that Shenzhen has experienced a rapid urbanization and urban expansion period. The develop pattern of Shenzhen is toward a high rise and high density city like Hong Kong. A study of the greening space in Shenzhen shows that the forest land is quite large (Che, et al., 2011). However, within the urban built up areas are lack of greenery and open space. The zoning for street network of the most densely populated area of Shenzhen indicated that the street network is closely linked to each other without space for urban greenery (Wang, et al., 2013). And the planting of greenery cannot catch up with the construction of buildings and highways in the city. The existing trees planted along the streets may be too small to effectively reflect the solar radiation and cooling down the local temperature.

Besides, another study shows that among the high density areas of the city, wind cannot easily ventilated the region because the wind speed will reduce when passing the high density building areas. The wind speed will decrease from 2.7m/s to 1.2m/s when entering the urban districts (Lin, 2011). In most areas, the wind speed is only 1m/s or even create the stagnate zones. In this case, the heat will generate and stay in the urban areas due to the poor urban scale ventilation which will greatly increase the potential for UHI effect in Shenzhen.

2.1.3. Reduction of water bodies

The reduction of water bodies in Shenzhen is regarded as another factor that forming the UHI. Study shows that the river network of Shenzhen has toward a decrease from 1980 to 2005 (Zhou, et al., 2010). It can be seen that the river network complexity is decreased from 36.1 to 31.6 and the number and length of the river are also decrease during the urbanization with the total length of the rivers in Shenzhen shortened 355.4km (Zhou, et al., 2010). It can be concluded that with the fast development of urban areas, the water bodies have been influenced and the cooling effect of the rivers are also reduced. In this case, the surface temperature of Shenzhen is keep increasing with the decrease of water bodies therefore generate the UHI effect.

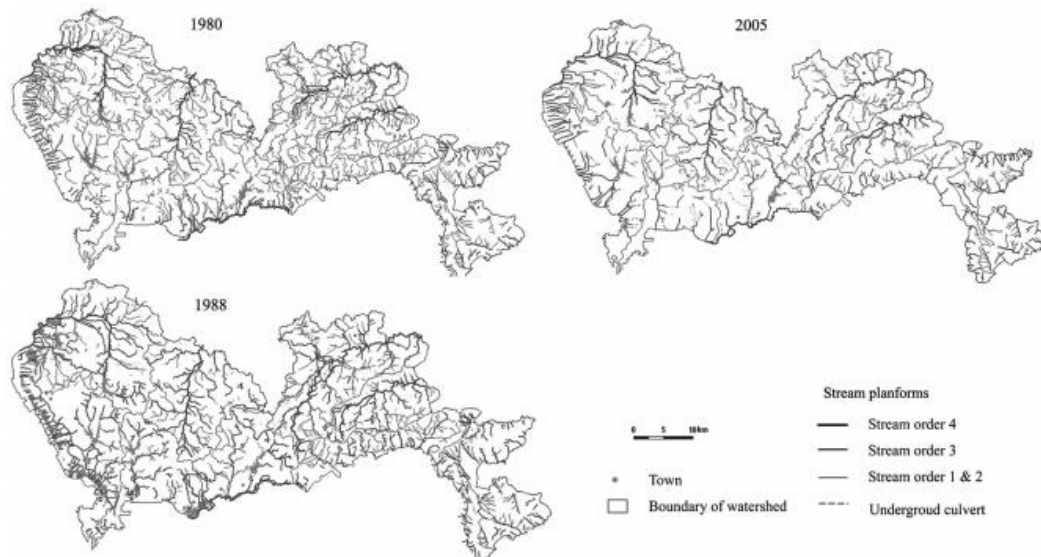

Figure 6: River network change in Shenzhen (Zhou, et al., 2010).

2.1.4. Anthropogenic heat

Anthropogenic heat is another reason that forming UHI in Shenzhen. From the UHI distribution pattern, it can be concluded that the strongest UHI areas appear with high population density (Zhang, et al., 2011). Human's activities will significantly increase the energy consumption thus generate unwanted heat of those regions. Besides, study shows that the total number of motor vehicles and private car in Shenzhen are increasing. Reaching 2.72 million in 2014 with the annual growth rate of 16.2% and the vehicle density in Shenzhen is 440 per km which is much higher than the international standard (Zhang, et al., 2011).

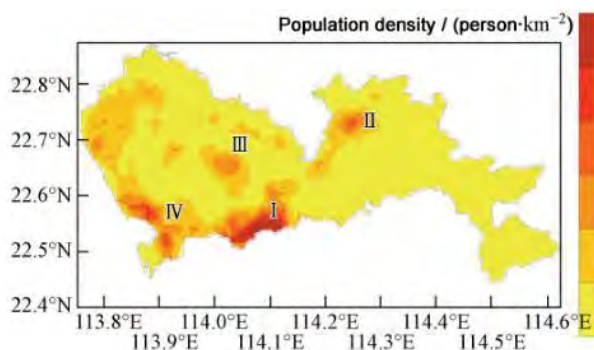

Figure 7: Population density of Shenzhen (Zhang, et al., 2011)

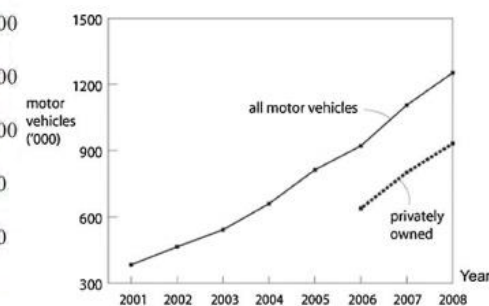

Figure 8: Motor vehicle and private car tendency in Shenzhen (Zacharias & Tang, 2010).

Besides, according to the studies of industrial and commercial zone location and the road network of Shenzhen indicates that the UHI effect is highly related to the anthropogenic heat generated by industrial and commercial activities and transportation. The western part with distribution of industrial and commercial districts and the central part with main road network are found to have higher UHI value in Shenzhen. Therefore the built up of buildings and the emission of the private cars are one of the key reason that forming the urban heat island.

3. URBAN PLANNING STRATEGIES TO CONTROL UHI

3.1 Ventilation corridors

In order to reduce the urban heat island effect in Shenzhen, ventilation corridors should be created both on city scale and district scale. On the city scale, as the dominate wind direction of Shenzhen is northeast, east and southeast, the wind path should be arranged northeast to southwest and northwest to southeast. And the wind corridors may follow the major roads and green lands and link to each other. Besides, the air path should prevailing

to the dominate wind direction and should be long and width enough to effectively ventilate the whole community. On the district scale, a new district known as the Low Carbon City locates in Pingdi district which can represent the future urban planning model of Shenzhen is designing the wind corridors according to the dominate wind direction to reduce the urban heat island effect. In this case, the wind can penetrate into the urban built up areas and bring away the urban heat.

3.2 Linkage of open space and increase greenery

Increase open space with greenery is another useful strategies to reduce urban heat island effect in the city due to the cooling effect of vegetation. A greenway has been built up which went through the whole Shenzhen city to increase greenery in the city and bring wind into the urban construction areas. In this case, the surrounding urban areas can be benefit from the greenway and the land surface temperature will to some extent decrease. The greenway can not only provide a space for people to enjoy nature and do exercise but also is a process toward sustainable urban planning for the future of Shenzhen.

Besides, several strategies are needed on the district scale to improve the local environment as microclimate play an important role in the whole urban climate condition. In order to build up the Low Carbon City, several strategies are put forward. Buildings are setback to widen the streets; open spaces are design within the high density built up areas for better ventilation and provide outdoor thermal comfort; trees are planting at the sidewalks at the initial **stage of urban planning to improve the environment at the pedestrian level. What's more, the green belts are** closely linked with the surrounding nature land to make sure the cooling effect. In some really high dense areas where building setback and open spaces are hard to design, vertical planting and roof gardens are needed to increase the greenery in this areas.

3.3 Building design toward sustainable urban planning

Buildings which take up the biggest parts of urban built up areas should be design properly to reduce the urban heat island effect in Shenzhen. As Shenzhen is locates at the hot summer and warm winter climate zone the same as Hong Kong, the urban planning guideline published by the Hong Kong Planning Department can also applied in Shenzhen. For building orientation and disposition, in order to catch wind, the building orientation and disposition is very important. Building should be oriented to face the prevailing wind with large openings, the main street should parallel or up to 30° with the dominate wind and the length of building façade along with the prevailing wind should be longer to reduce stagnant zone behind the building (HK Planning Department, 2014). For building height, a mix of low-rise and high-rise building will benefit the wind movement. Increase the building height of the behind building along with the prevailing wind direction can enhance the ventilation and allow the wind to reach the building behind (HK Planning Department, 2014). Besides, for building permeability, better ventilation pattern can be achieved by creating gaps and openings on the buildings.

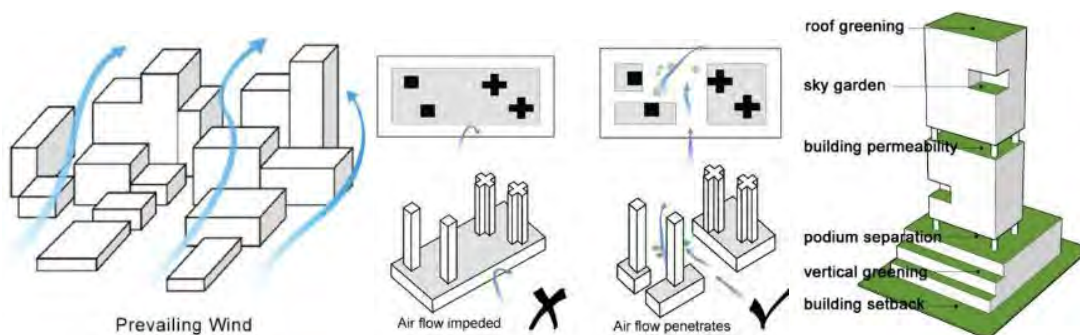

Figure 11: Building height and podium separation
(HK Planning Department, 2014).

Figure 12: Building permeability
(By author).

3.4 Green transportation system

Green transportation system is highly recommended in Shenzhen in the form of green subway system and electric vehicles. By encouraging people to use public transportation, the number of private cars can be greatly reduced therefore the anthropogenic heat generated by cars can also decrease. Besides, the electric vehicles are green because they use electricity instead of burning gasoline. In this case, the heat release by the transportation can be reduced and thus make a great contribution to the control of urban heat island effect in Shenzhen.

4. CONCLUSION

Urban heat island is considered as one of the most important environmental issues as it influences sustainable urban development and living environment directly. The urban heat island effect in Shenzhen is becoming much more obvious since 1980 with the rapid urbanization process. From the analysis of spatial distribution of UHI and land surface temperature, the strong UHI appeared at the urban construction areas with high density building patterns. Land use change during the urbanization process, high density built-up areas, reduction of water bodies and anthropogenic heat generated by human activities are the main factors that form UHI in Shenzhen. Shenzhen, which is located in the hot summer and warm winter climate zone in China, has huge potential to reduce UHI effect and achieve sustainable urban planning in the future. Several climatic-based design and urban planning strategies such as ventilation corridors, linkage of open space and increase in greenery, building design toward sustainable urban planning and green transportation system are put forward to control the UHI in Shenzhen. Therefore, the urban planning strategies presented in this paper can be made available to the designer and used as a reference guideline for achieving sustainable urban planning for Shenzhen and any other cities with similar urban climate conditions.

REFERENCES

- [1] Chen, J., Chang, K. T., Karacsonyi, D., & Zhang, X. (2014). Comparing Urban Land Expansion and its Driving Factors in Shenzhen and Dongguan, China. *Habitat International*, 43, 61-71.
- [2] Che, X., English, A., Lu, J., & Chen, Y. D. (2011). Improving the Effectiveness of Planning EIA (PEIA) in China: Integrating Planning and Assessment During the Preparation of Shenzhen's Master Urban Plan. *Environmental Impact Assessment Review*, 31(6), 561-571.
- [3] Huasheng, S. (1991). Urban Development in Shenzhen SEZ. *Habitat International*, 15(3), 25-31.
- [4] Lin, Mengdie. (2011). Research on Thermal Environment Improve Strategy in Heat Island District of Shenzhen Futian Based on Computational Fluid Dynamics. Shenzhen Graduate School.
- [5] Ng, M. K. (2003). Shenzhen. *Cities*, 20(6), 429-441.
- [6] Song, B., & Somasundaram, S. (2009). Country Report on Building Energy Codes in China. Springfield, VA: Pacific Northwest National Laboratory.
- [7] Shi, P., & Yu, D. (2014). Assessing Urban Environmental Resources and Services of Shenzhen, China: A Landscape-based Approach for Urban Planning and Sustainability. *Landscape and Urban Planning*, 125, 290-297.
- [8] Tianhong, L., Wenkai, L., & Zhenghan, Q. (2010). Variations in Ecosystem Service Value in Response to Land Use Changes in Shenzhen. *Ecological Economics*, 69(7), 1427-1435.
- [9] Wang, H., Shi, S., & Rao, X. (2013). A Study of Urban Density in Shenzhen.
- [10] Xie, M., Wang, Y., Chang, Q., Fu, M., & Ye, M. (2013). Assessment of Landscape Patterns Affecting Land Surface Temperature in Different Biophysical Gradients in Shenzhen, China. *Urban Ecosystems*, 16(4), 871-886.
- [11] Xie, M., Wang, Y., Fu, M., & Zhang, D. (2013). Pattern Dynamics of Thermal-environment Effect During Urbanization: A Case Study in Shenzhen City, China. *Chinese Geographical Science*, 23(1), 101-112.
- [12] ZHANG, X. L., Lei, L., Yan, D., JIANG, Y., Xiaoyi, F., Mei, L., Yuan zhao & Yujie, B. (2011). A Numerical Study on the Influences of Urban Planning and Construction on the Summer Urban Heat Island in the Metropolis of Shenzhen. *Journal of Tropical Meteorology*, 17(4).
- [13] Zhou, H., Shi, P., Wang, J. A., Yu, D., & Gao, L. (2010). Rapid Urbanization and Implications for River Ecological Services Restoration: Case Study in Shenzhen, China. *Journal of Urban Planning and Development*, 137(2), 121-132.

- [14] Zhang Lijie, Li Lei, Jiang Yin, Tan Ming Yan & Li Hui. (2011). A Study of the Urban Heat Island in Shenzhen Based on Data from Automatic Weather Stations [J]. *Climatic and Environmental Research* (in Chinese), 16(4): 497-486.
- [15] Zacharias, J., & Tang, Y. (2010). Restructuring and Repositioning Shenzhen, China's New Mega City. *Progress in Planning*, 73(4), 209-249.

Influence of Moving Vehicles on Pollutant Dispersion in Street Canyon: A Numerical Study

ZHANG Wenjing^a, CHOW Tin-tai^b

^a Division of Building Science and Technology, City University of Hong Kong, Hong Kong SAR, jingwzhan3-c@my.cityu.edu.hk

^b Division of Building Science and Technology, City University of Hong Kong, Hong Kong SAR, bsttchow@cityu.edu.hk

ABSTRACT

The occurrence of “crazy bad” air pollution in many cities of China often hits the international headlines. In Hong Kong, the outdoor air quality faces great challenges as well. According to the report released from the Environmental Protection Department of the Hong Kong Government, vehicular emissions and street canyon effects are the two main contributing factors to roadside air pollution. This paper outlines the findings from our numerical investigation of the dynamic pollutant dispersion as induced by moving vehicles within the street canyon environment of Hong Kong. The integrative computational fluid dynamics (CFD) models, including the standard k- ϵ model for airflow turbulence, the species transport model for gaseous pollutants, and the dynamic mesh model for moving vehicles, were validated by wind tunnel measurements as well as reported data from published literatures. Our findings confirm that moving vehicles could generate secondary airflow, and hence introduces additional ventilation effects. This leads to continuous interaction between the wind flow and the wake of vehicles, and in addition, promotes the mixing and transportation of the vehicle exhausted pollutants. Dynamic impacts of the moving vehicles on the airflow field (such as the flow velocity) and the pollutant dispersion (such as the concentrations of CO from a stationary line source and NO₂ from the moving point source) were found highly dependent on: (i) The geometrical configuration of the street canyon; (ii) The mode of vehicular movements, such as in single- or multi-lanes and their travelling directions, and (iii) The position of the monitoring site, i.e. near the leeward/windward wall, at the middle of the street canyon, or near the two street end openings.

Keywords: micro-climate, sustainable neighbourhood, roadside air quality

1. INTRODUCTION

The occurrence of “crazy bad” air pollution in many cities of China often hits the international headlines. In Hong Kong, the outdoor air quality faces great challenges as well. According to the report released from the Environmental Protection Department of the Hong Kong Government, vehicular emissions and street canyon effects are the two main contributing factors to roadside air pollution, which is often associated with high pollutant concentrations exceeding current air quality standards. Therefore, air quality in urban street canyon has garnered great interest and numerous studies have been conducted to enrich our understanding of the airflow field and the mechanisms of pollutant transport, dilution and removal in street canyon. Several parameters that dominate the pollutant dispersion process can be classified as geometrical, meteorological related, and traffic related.

It is undeniable that traffic is one most dominating risk for the urban atmospheric environment. However, the influence of on-road vehicles on the air quality of urban canyon is far more complicated than just simply considers it as the source of diverse atmospheric pollutants. Previously, theoretical studies, field measurements, wind tunnel experiments, as well as computational fluid dynamics (CFD) techniques were used to interpret the detailed processes of airflow and pollutant distribution under the influence of moving vehicles. In general, the rapid running vehicles on-road can themselves introduce secondary airflow and additional ventilation effect due to the continuous interactions between the natural wind and vehicle wakes. Consequently, in the presence of moving vehicles, the normal airflow pattern and pollutant distribution profile within a street canyon will be broken up, and both micro- and large-scale mixing and dispersion processes will take place. The complexity in predicting the pollution distribution and in the assessment of air quality will considerably increase.

In this present work, dynamic impact of the moving vehicles on the airflow and pollutant dispersion within the idealized deep and uniform canyons were investigated by innovatively adopting the dynamic mesh model based on the FLUENT software platform. As to the model validation, the wind tunnel test section was modified to incorporate the Moving Model Rig for the vehicle movement. Research outcomes are expected to help narrowing

the knowledge gap in understanding the influence of traffic on the transport characteristics of pollutants, and to help identifying spots vulnerable to be polluted.

2. NUMERICAL METHODOLOGY

2.1 Studied cases

The size of the computational domain in all studied cases is $X = 600\text{m}$, $Y = 290\text{m}$, and $Z = 150\text{m}$ (Figure 1). The idealized urban street canyon is formed by two parallel aligned blocks—the upstream and downstream building blocks. Each has the dimensions of $LB = 90\text{m}$, $WB = 30\text{m}$, and $HB = 30\text{m}$. Both the deep (aspect ratio=3) and the uniform (aspect ratio = 1) street canyons were investigated. The approaching wind was set perpendicular to the long axis of the street canyon. The double-decker-bus model ($L_v = 12.5\text{m}$, $W_v = 2.5\text{m}$, and $H_v = 4.5\text{m}$) run through the street canyon at a moderate speed of 36 km/h . Each bus model has a 0.1m diameter exhaust tail-pipe at its rear end. Traffic pollutants from the constant traffic fleet and from the moving vehicles were investigated separately. The vehicular emissions from the steady traffic fleet are simplified as: (i) a ground-level continuous pollutant area source of Carbon Monoxide (CO) in the deep street canyon, and (ii) the line source(s) of CO in the uniform street canyon. The emission from the exhaust tail-pipe of a moving vehicle is taken as a moving point source of Nitrogen Dioxides (NO_2). The dynamic impact of the moving vehicles are studied in four different scenarios: (i) Scenario#1: Single vehicle runs on the one-lane street of the deep canyon (Figure 2a); (ii) Scenario#2: Two vehicles run in the same direction of the two-lane street of the deep canyon (Figure 2b); (iii) Scenario#3: Two vehicles run in the opposite directions of the two-lane street of the deep canyon (Figure 2c); and (iv) Scenario#4: Four vehicles run on the four-lane street (two-way traffic) of the uniform canyon (Figure 2d).

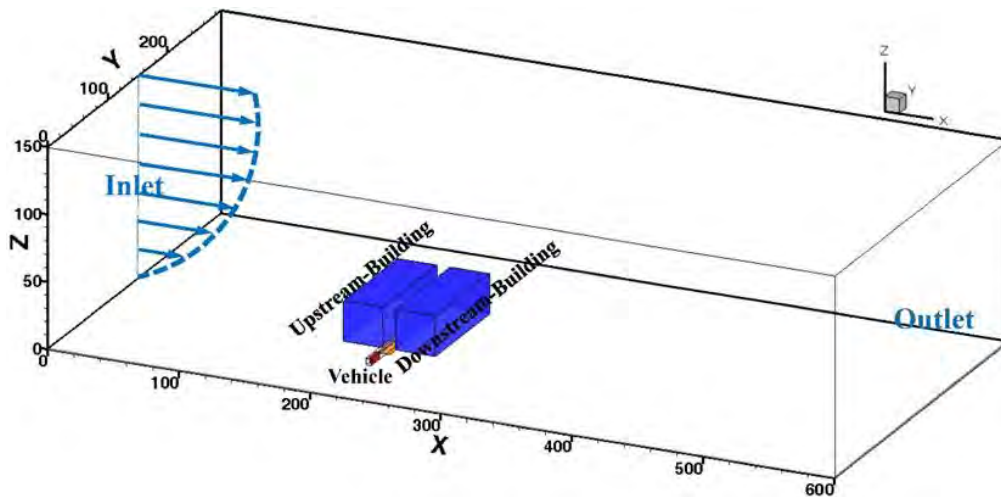

Figure1: Geometrical layout of the computational domain (Scenario#1)

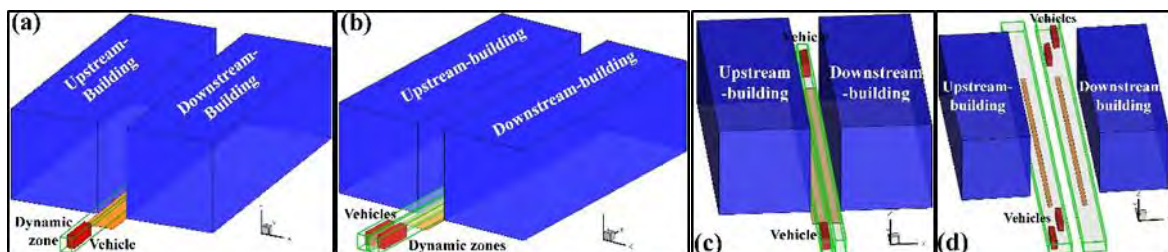

Figure 2: Core region of the computational domain in four different scenarios

2.2 Numerical models

The standard k- ϵ model was used in this airflow study due to its simplicity, low computational cost, robustness and relatively good accuracy. The species transport model was employed to simulate the dispersion and distribution of the tracer gases. The dynamic mesh model was adopted to deal with the influence from a moving object on the airflow field and the pollutant concentration field. The integral form of the conservation equation for a general scalar Φ , on an arbitrary control volume V with moving boundary can be written as:

$$\frac{d}{dt} \int_V \rho \Phi dV + \int_{\partial V} \rho \Phi (\vec{u} - \vec{u}_m) \cdot d\vec{A} = \int_{\partial V} \Gamma \nabla \Phi \cdot d\vec{A} + \int_V S_\Phi dV$$

Equation 1

where ρ is the fluid density, \vec{u} is the flow velocity vector, \vec{u}_m is the grid velocity of the moving mesh, ∂V represents the boundary of the control volume, Γ is the diffusion coefficient, S_Φ is the source term of Φ . The computational domain should be divided into two separate sections: (i) the dynamic mesh zone for the moving vehicle model, and (ii) the static mesh zone for the rest domain. The interface data exchange between the two sections was implemented by the grid interface principles of sliding mesh theory. The dynamic layering method was employed to update mesh only in the dynamic mesh zone. User-Defined Functions (UDFs) served to define and track the motion of vehicle model. In our previous studies, the dynamic influence of human walking movement on the airflow and particle concentration in ventilated room have been successfully modelled and investigated. On this technical basis, the linear movement of on-road vehicles can be appropriately modelled.

Accordingly, the inlet of the computational domain was set as velocity inlet with a power-law wind profile. The mean velocity u_H at the top of the building was set 2.5m/s and with the exponent α at 0.4 for urban terrain. The temperature of the approaching wind was 303.15K. The outlet, the top and two side surfaces of the computational domain were defined as the Outflow Boundary Condition and Symmetric Condition. The bottom of the computational domain, and all surfaces of the two buildings as well as the vehicle models were defined as No-slip Wall. After the time step independent tests, the time step of 0.02s for Scenario#1 and 0.01s for Scenario#2-#4 are selected for dynamic simulation. The SIMPLE algorithm was used to solve the Pressure-Velocity coupling equations. The Pressure was discretised using the second order scheme. For the discretization of the governing equations, the second-order upwind scheme was used for the convection terms, and the central differences scheme with second order accuracy was for the diffusion terms. The scaled residual criteria for all the flow properties were set at 10⁻⁵.

Extensive tests on the independence of the meshes were carried out with increasing mesh numbers until further refinement was shown to be insignificant. Finally, the Moderate Mesh for each scenario (about 2 million cells) was adopted for the following simulation.

2.3 Model validation

Good performance of the standard k- ϵ model coupled with the species transport model in modelling the airflow pattern and the tracer gas concentrations within street canyons was demonstrated by comparing the computer outputs with the wind tunnel database of CODASC. The competence and performance of the adopted models for capturing the initial pollutant dispersion from a diesel vehicle were also validated by comparing with the measured data from Chan et al., 2001.

To validate the dynamic mesh model for vehicular movement, a series of tests was carried out in the wind tunnel laboratory of the City University of Hong Kong. The wind tunnel was modified to accommodate a moving model rig, which allowed the scaled vehicle model to be fired across the test-section of the wind tunnel. A gas supply system was specially designed for the continuous releasing of tracer gas (Propane) during the forward movement of the vehicle model. SWEMA03 Anemometers and HRF 400 fast FID systems were appropriately installed and tuned preceding to the measurement of the transient and time average features of wind flow and tracer gas concentrations. Close agreements were found between the measured and modelled data (results are not shown here), which strongly indicates that the integrative model adopted in this study can provide a reasonable description of the transient flow physics under the dynamic influence of vehicular movement.

3. RESULTS AND DISCUSSION

For the convenience of making comparisons amongst the different scenarios, airflow velocity, concentrations of CO and NO₂, and time series were normalized to become Vel*, CO*, NO₂*, and Time* respectively. Time* = 0 stands for the start of the vehicle movement; Time* = 0.5 represents the arrival of vehicles at the middle of the street canyon, and Time* = 1.0 indicates that the vehicle reaches the terminal end of the moving path and stops moving forward. Moreover, the sampling time is much longer than the whole moving duration of the vehicle in order to include the recovery process after the pass of moving vehicle. In this study, the contours of Vel* and CO* are first presented to help capturing the general features and rules of the dynamic influence. Then, detail effects of the potential influencing factors are discussed by analysing the temporal variation of NO₂*.

3.1 General characteristics of dynamic impact

Dynamic impacts on the Vel* and CO* distributions at the adult breathing height ($z/H_v = 1/3$) within the deep street canyons (Scenario#1 - #3) when the vehicles are at the mid-point of the street canyon (Time* = 0.5) are illustrated in Figure 3 and Figure 4 respectively.

Take Scenario#1 in Figure 3 as an example: the most striking features of the dynamic influence on the airflow pattern are the generation of the “Propelling effect” in the form of a relatively high Vel* in front of the head of the moving vehicle, and the “wake effect” characterized by a stripe of high Vel* following its rear end. Within the semi-confined space (i.e. the train tunnel), the train movement would generate the “piston effect”. For the street canyon environment, the combined effect of “propelling effect” and “wake effect” of each individual vehicle can be taken as the equivalent “piston effect”. Similar dynamic impacts on pollutant (CO*) distribution within the deep street canyon can be found in Figure 4, where the polluted air in front of the vehicles is pushing forward due to the “Propelling effect” and the relatively clean air is entrained into the vehicle wake due to the “Wake effect”. Moreover, we expected that vehicles running in the same direction (Scenario#2) would enhance the combined influence of “piston effect”. Such influence would be attenuated when the vehicles running in the opposite directions (Scenario#3).

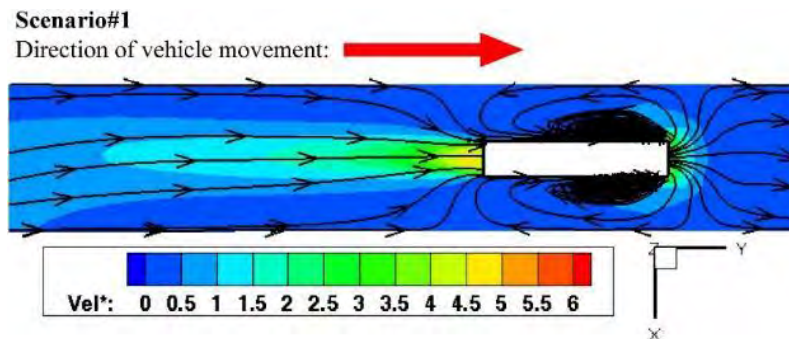

Figure 3: Contour of Vel* and airflow streamlines at the height of adults' breathing zone ($z/H_v = 1/3$) for Scenario#1 within deep street canyon

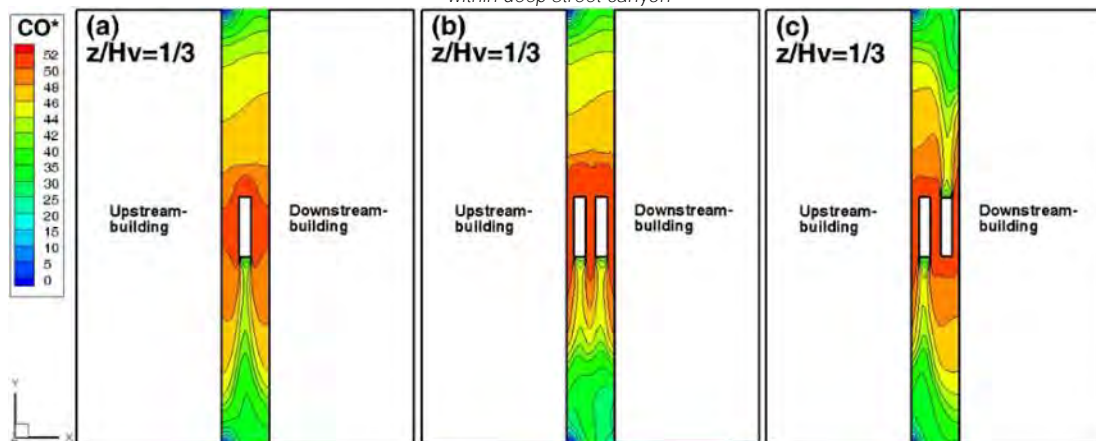

Figure 4: Contours of CO* at the adult breathing height ($z/H_v = 1/3$) within deep street canyon

3.2 Effects of influencing factors

In this section, the temporal variation of NO_2^* is analysed to help figuring out the detailed effects of potential influencing factors.

Figure 5(A) presents the time series of NO_2^* at the adult breathing height near the leeward and windward walls for the above four scenarios. The dynamic variation pattern and magnitude of NO_2^* in the deep canyon (Scenario#1 - #3) are found quite different from that in the uniform street canyon (Scenario#4), even though Scenario#3 shares similar mode of vehicle movement with Scenario#4. This indirectly demonstrates that geometrical configuration of the street canyon has an important role on the influencing range and the extent of the dynamic impact induced by the moving vehicles. Compared with the uniform street canyon, air ventilation is less effective in the deep street canyon, leading to a relatively stronger transient influence of vehicle movement. Secondly, the dynamic impact is found in close association with the mode of the moving vehicles — the number and the travelling direction. Take the deep canyon (Scenario#1 - #3 in Figure 5A) as an illustrating example. NO_2^* in Scenario#1 is much lower than those in Scenario#2 and #3, which strongly indicates that single moving vehicle would release less amount of pollutant, while multiple moving vehicles would generate stronger dynamic influence on the transportation and dispersion of vehicular pollutants. Moreover, vehicles running in the same direction (Scenario#2) would reinforce the combined “piston effect”, enhance the disturbance on the airflow, and promote the transport of pollutant. However, individual “piston effect” would offset by one another when the vehicles run in the opposite directions (Scenario#3). This results in a reduction of dynamic disturbance at the far field, but at the same time, generates a “mixing effect” which would promote the dilution and mixing of local pollutant around the moving vehicles. Therefore, NO_2^* in Scenario#2 is relatively higher than that in Scenario#3. Thirdly, the difference in transient distribution of pollutant can be observed between the leeward and windward sides due to the joint effect of vehicle induced airflow and the ambient wind field. Generally speaking, in the deep street canyons (Scenario#1 - #3), the variation trends of NO_2^* near both sides share the similar pattern but carry remarkable different peak values. For the uniform street canyon (Scenario#4), NO_2^* peak value on the windward side is much higher than that on the leeward side. However, long-lasting influence is actually found near the leeward wall.

Dynamic variations of NO_2^* at the adult breathing height at different horizontal positions near the windward wall in Scenario#2 is shown in Figure 5(B), where 0 LB, 1/4 LB and 1/2 LB are at the opening, the quarter, and the centre of the street canyon, respectively. It can be seen that NO_2^* at the street openings (0 LB) is lower than that in the internal space of the street canyon (1/4 LB and 1/2 LB), due to the outside clean air fills in through these two openings. Also, the occurrence time of the NO_2^* transient variation is found in tight relationship with the time instance when the moving vehicle passes by the adjacent monitoring site.

Figure 5(C) gives the temporal variations of NO_2^* at different vertical heights of the street canyon ($z = 1/6 \text{ HB}$, $1/3 \text{ HB}$, $2/3 \text{ HB}$ and 1 HB) for Scenario#2. NO_2^* at the lower level of the street canyon is found much higher than that at the upper level, and the occurrence time of concentration peak at the lower level is prior to the upper level. However, certain amount of pollutants can still reach the upper height of the street canyon. Such enhanced vertical dispersion of vehicular pollutant induced by the moving vehicles might call for extensive research efforts on dynamic simulation, because there might be unexpected exposing risks at some places (i.e. higher level of the street canyon), which may not be predictable by the conventional steady state simulation.

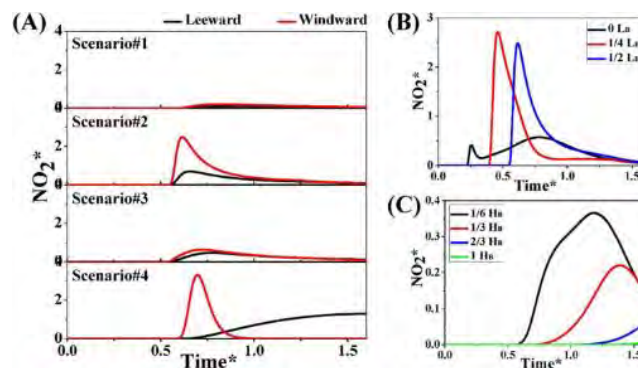

Figure 5: Time series of NO_2^* (A) Near the leeward and windward wall for the four different scenarios; (B) At different horizontal positions for Scenario#2; and (C) At different vertical heights for Scenario#2

4. CONCLUSION

Dynamic impacts of the moving vehicles on the airflow and pollutant dispersion within both the deep and uniform street canyons were numerically investigated under four different scenarios. This was by employing the standard $k-\epsilon$ model for the airflow turbulence, the species transport model for the dispersion of tracer gas, as well as the dynamic mesh model for the vehicle movement. These adopted numerical models were validated by wind tunnel measurements and reported data from the published literatures. Dynamic simulation results clearly confirm that moving vehicles could generate secondary airflow and hence introduce additional ventilation effects, in the form of **the combined effect of "Propelling effect" and "Wake effect"**. This leads to a continuous interaction between the wind flow and the wake of vehicles, and also promotes the mixing and transport of vehicle exhaust pollutant. Dynamic impact of the moving vehicles on the airflow field and the pollutant dispersion are found highly dependent on: (i) The geometrical configuration of the street canyon; (ii) The mode of vehicular movements, such as in single- or multi-lanes and their travelling directions, and (iii) The position of the monitoring site, i.e. near the leeward/windward wall, at the middle of the street canyon, or near the two street end openings. Finally, a deductive conclusion can be made based on this dynamic simulation study. There might be unexpected exposing risks at some places (i.e. at higher level of the street canyon), which may not be predicted by the conventional steady flow simulation. Hence, more research efforts are needed for investigating the urban air quality under dynamic impact of moving vehicles.

REFERENCES

- [1] Air Quality in Hong Kong. <http://www.gov.hk/en/residents/environment/air/airquality.htm>
- [2] Baker, C. J. and Hargreaves, D. M., 2001. Wind tunnel evaluation of a vehicle pollution dispersion model. *Journal of Wind Engineering and Industrial Aerodynamics*, 89(2), 187-200.
- [3] Chan, T. L., Dong, G., Cheung, C. S., Leung, C. W., Wong, C. P. and Hung, W. T., 2001. Monte Carlo simulation of nitrogen oxides dispersion from a vehicular exhaust plume and its sensitivity studies. *Atmospheric environment*, 35(35), 6117-6127.
- [4] Concentration Data of Street Canyons. <http://www.ifh.uni-karlsruhe.de/science/aerodyn/CODASC.htm>
- [5] Di Sabatino, S., Kastner-Klein, P., Berkowicz, R., Britter, R. E. and Fedorovich, E., 2003. The modelling of turbulence from traffic in urban dispersion models—Part I: theoretical considerations. *Environmental Fluid Mechanics*, 3(2), 129-143.
- [6] Fluent User's Guide 6.3. https://www.sharcnet.ca/Software/Fluent6/html/ug/main_pre.htm
- [7] Li, X. X., Liu, C. H., Leung, D. Y. C. and Lam, K. M., 2006. Recent progress in CFD modelling of wind field and pollutant transport in street canyons. *Atmospheric Environment*, 40(29), 5640-5658.
- [8] Solazzo, E., Cai, X. and Vardoulakis, S., 2008. Modelling wind flow and vehicle-induced turbulence in urban streets. *Atmospheric Environment*, 42(20), 4918-4931.
- [9] Vachon, G., Louka, P., Rosant, J. M., Mestayer, P. G. and Sini, J. F., 2000. 'Measurements of traffic-induced turbulence within a street canyon during the Nantes' 99 experiment', 3rd Urban Air Quality conference, Loutraki, Greece, 19-23 March.
- [10] Vardoulakis, S., Fisher, B. E. A., Pericleous, K. and Gonzalez-Flesca, N., 2003. Modelling air quality in street canyons: a review. *Atmospheric environment*, 37(2), 155-182.
- [11] Wang, J. L. and Chow, T. T., 2011. Numerical investigation of influence of human walking on dispersion and deposition of expiratory droplets in airborne infection isolation room. *Building and Environment*, 46(10), 1993-2002.

Session 2.6: Innovations Driving for Greener Policies and Standards – Carbon Assessment

Building Carbon Footprint (BCF) Method for Nearly Zero-Energy Building Design Assessment

CHAO Yu-chan^a, HO Ming-chin^b, CHENG Ming-jen^c

^a Feng Chia University, Taiwan, chaodan2@gmail.com

^b Architecture and Building Research Institute, Ministry of the Interior, Taiwan, service@abri.gov.tw

^c Feng Chia University, Taiwan, mjcheng@fcu.edu.tw

ABSTRACT

In recent years, with the global trend of greenhouse gas reduction and sustainability, the development of nearly zero energy building (nZEB) and zero carbon building (ZCB) becomes international consensus. However, some ZEB design technologies in Europe and America may not be entirely applicable to Taiwan where air condition costs a lot of energy in summer for the hot-humid climate. To face these challenges, this study provided appropriate architectural design technologies and conduct feasibility assessment of nZEB in Taiwan.

Firstly, three-oriented energy-saving technologies, including passive design, active design and renewable energy were analyzed. Then **“Building Carbon footprint Method (BCF)” was used for nZEB quantify and feasibility of Taiwan’s residential building.** The main research results are as follows:

- In "Residential standard situations," through operating the optimizing design of building envelope and other ventilation and equipment efficiency factors, the EUI could be by 50 (kWh/ m².yr) down to 33 (kWh/ m².yr) . The total energy efficiency could rise up to 34%.
- If photovoltaics were chosen as the main renewable energy source, a single-family house with 150m² floor areas would have the potential of reaching nZEB. However, if the house had larger scale, it needed more BIPV design and improve the conversion efficiency of solar cells to increase it s nZEB potential.
- The key point to aim at nZEB is to set specific near-zero energy targets, it not only to encourage innovative building energy efficiency design techniques, but also to promote the construction and upgrading of industrial technology.

Keywords: green building management, energy saving, ZEB

1. INTRODUCTION

The Nearly Zero-Energy Buildings (nZEB) refers to a low energy-consuming green building, using the renewable energy system for the building to attain the goal for energy neutralization zero energy consumption. The European Union (EU) has declared that the energy conservation standard of all of new buildings must conform to the standard of "nZEB" in 2020 . The United States Department of Energy (DOE) specified that the new commercial buildings should reach zero energy consumption by 2030, and attain the goal for zero energy consumption thoroughly by 2050. Taiwan has a mature green building evaluation system at present, but Taiwan is located in subtropical zone with wet hot climate, it depends on air conditioning energy a lot in summer, this is a big challenge to the development of zero-energy buildings in Taiwan. This study aims to appraise the feasibility of zero-energy design for green buildings under the precondition of developing nZEB in Taiwan.

2. RESEARCH PURPOSES

The main purpose of this study is to use appropriate building energy saving design technique to appraise the feasibility of nZEB, and the house building with relatively low "Energy Use Intensity (EUI)" is taken as research subject. In order to simplify the complex building energy consumption pattern, this study uses the " Standard Scenario " set by the "Building Carbon Footprint Evaluation Method (BCF)" of the Low Carbon Building Alliance (LCBA) to "standardize" the complex user, time interval and equipment by dynamic simulation of energy, and then calculates the reduction of building energy consumption with different building energy saving techniques.

3. RESEARCH METHOD

3.1 BCF method and application

The Building Carbon Footprint Evaluation Method deduced by LCBA uses a series of building materials, the statistics of building energy use and theoretical prediction equation of carbon emission to simulate the carbon footprint of buildings in 60-year life cycle, including the evaluation of five stages of life cycle, (1) building materials production and transportation; (2) construction; (3) daily use; (4) repair and renovation; (5) demolishment and discarding. The BCF uses a series of "Standard Scenario" to simulate the building carbon footprint. As the BCF method is completely established on the carbon investigation data of Taiwan's building industry, the building energy consumption analysis is developed according to Taiwan's meteorological data, the standard scenario of building use and architectural space classification are derived from precise local industry survey and academic research findings, which are indigenous, reproducible, effective and reliable.

General nZEB uses primary energy as baseline value, and only considers the energy consumption of lighting equipments, air-conditioning equipments and hot water supply equipments in "daily use" stage, the energy consumption of household appliances depends on the boundary of calculation, not always brought into calculation. At present, the studies of Taiwan's residential building energy consumption mostly use EUI (kWh/ m²) as calculation unit. As the electricity, carbon emission and primary energy can be converted, and the routine energy consumption of BCF method is estimated by using the unit EUI of electricity (kWh/ m²), without converting the electricity into carbon emission equivalent, this study uses the "routine energy consumption" evaluation method of BCF method to calculate the energy consumption of ZEB, which is a rapid and accurate method. Therefore, this study uses electricity (kWh) and EUI (kWh/ m²) as the quantization units of ZEB.

3.2 "Standard Scenario" setting for residential routine energy consumption

The "Standard Scenario" means the complex users, time intervals and equipments are "standardized" by dynamic simulation of energy. The standard population of each household is set as two adults and two children, who have standardized work and rest. There is a standard situation for the service hours of household equipments (Table 1). The standard situation of residential energy consumption is: air conditioning energy consumption accounts for 20%, lighting energy consumption accounts for 30%, the energy consumption of the other household appliances accounts for 50%, the average EUI is 50 (kWh/m².yr) (Table 2).

Hours of operation (hr)	Annual service hours (hr/yr)		
	Air conditioning	Lighting	Business equipment
8760	1132	2920	2555

Table 1: Standard scenario of household equipments

Residential Type	Subitem EUI reference (kWh/m ² .yr)			EUI (kWh/m ² .yr)
	Air conditioning	Lighting	Electrical appliance	
Single house, townhouse, housing	10	18	22	50

Table 2: Standard residential EUI

4. BCF METHOD FOR QUANTITATIVE EVALUATION OF TAIWAN'S NEARLY ZERO-ENERGY HOUSES

4.1 Air conditioning energy conservation potential of house envelope energy conservation design

The first step of ZEB design is to use the passive energy conservation design of building envelop to reduce the indoor air conditioning heat load and the overall energy consumption of building. In the BCF method, if the energy consumption is not converted into carbon footprint equivalent (kgCO₂e), and the energy consumption (kWh/ m².yr) is calculated only, the estimation of the air conditioning energy consumption of specific air-conditioning system space is expressed as Equation 1:

$$\text{Annual energy consumption of specific AC system} = (\sum \text{EUI}_{\text{ai}} \times \text{AFli}) \times \text{Vac} \times \text{Bac} \times \text{SEL}$$

Equation 1

$$\text{Bac} = 1.0 - (2/d) \times (1.0 - \text{EEV})$$

Equation 2

where, EUI_{ai} = Air conditioning EUI of residential space ($\text{kWh/m}^2 \cdot \text{yr}$)

AFli = Indoor floor area (m^2)

Vac = Air conditioning energy consumption reduction ratio by natural ventilation

Bac = Air conditioning energy consumption reduction ratio by building envelop energy conservation

EEV = Building envelop energy-saving efficiency

SEL = Air conditioning energy label correction coefficient

$2/d$ = Depth factor, where d is the mean depth in short direction of building (m)

The "natural ventilation air conditioning energy consumption reduction ratio Vac " means the building uses natural ventilation condition, so that the air conditioning is stopped in winter, spring and autumn to reduce the ratio of annual air conditioning energy consumption. If $\text{Vac}=0.7$, the natural ventilation can save 30% of air conditioning energy. The "natural ventilation air conditioning energy consumption reduction ratio Vac " is related to the "natural ventilation potential VP (Ventilation Potential)". The VP is the ratio of "naturally ventilated floor space" to "total floor space". According to the study of Building Research Institute, Cheng Kung University, Taiwan's "natural ventilation potential VP " is 0.9-0.3. The residential spaces mostly use air conditioning at night, the maximum air conditioning energy-saving benefit is set as 70%, so the maximum Vac of residential type is 1, the VP is 0.9-0.7. The residential air conditioning energy conservation potential is discussed below by "passive energy saving technique" and "active energy saving technique".

- Discussion about passive energy conservation design benefit

According to Equation 1 and Equation 2, the "passive design" factors related to the air conditioning energy consumption estimation of specific air-conditioning system space include "building envelop energy-saving efficiency EEV ", "mean depth d in short direction of building" and "natural ventilation air conditioning energy consumption reduction ratio Vac ". As the BCF method encourages using natural ventilation to reduce the air conditioning energy consumption, if the EUI and total floor area are identical, this study assumes the energy-saving scenario baseline values to be $\text{VP}=0.7$, $\text{Vac}=1$, $\text{EEV}=1$, $\text{SEL}=1$ without using any shell energy conservation design technique.

The natural ventilation potential is the best when $\text{VP} = 0.9$, the Vac is 0.85. If $\text{EEV} = 0.8$, approaching the daily energy saving design value of most Taiwan's green buildings, the air conditioning energy-saving benefit increases to 22%. If $\text{EEV} = 0.6$, it is approximately the optimum performance value of shell energy saving of current green building design, the air conditioning energy-saving benefit is 29%, about 30% of air conditioning energy consumption can be reduced. (Figure 1).

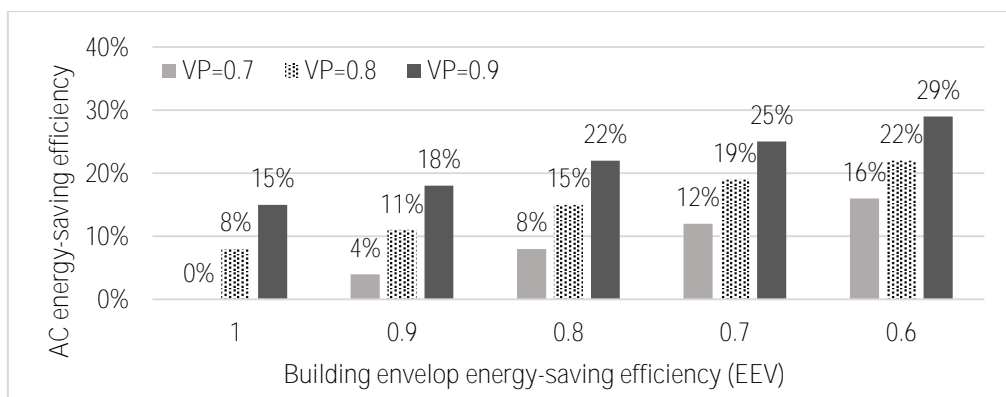

Figure 1: AC energy-saving efficiency and building envelop energy-saving efficiency EEV

- Discussion about active energy conservation design benefit

In Equation 1, the "active design" factor related to the annual energy consumption of specific air-conditioning system is the "air conditioning energy label correction coefficient SEL", the coefficient uses five "air conditioning energy label efficiency grades" of Bureau of Energy, Ministry of Economic Affairs for air conditioning energy consumption reduction. According to Figure 2, under the precondition of excellent passive energy conservation design (VP=0.9, EEV=0.6, d=5), the maximum air conditioning energy-saving benefit of different "air conditioning energy label efficiency grades" is 43%.

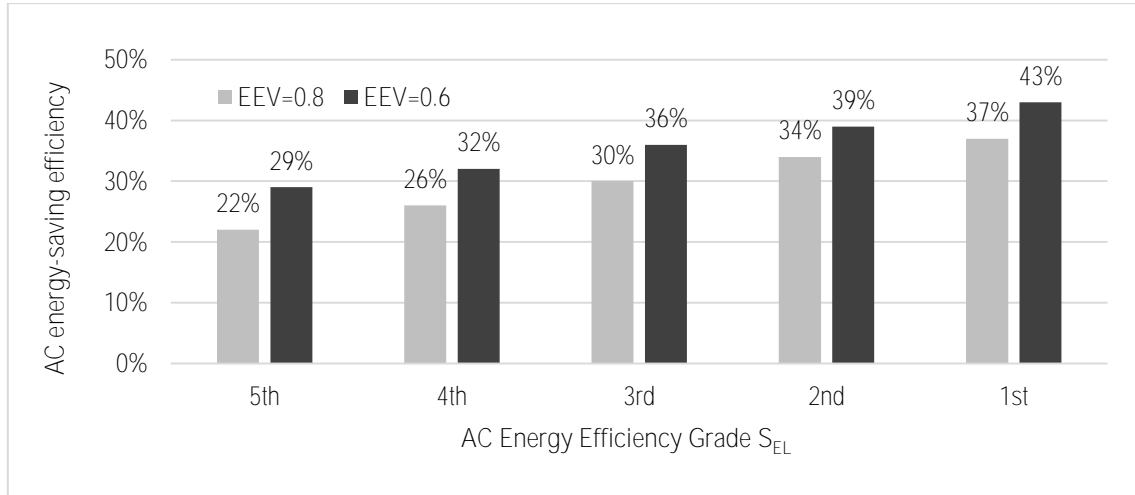

Figure 2: AC energy-saving efficiency and AC energy efficiency grade SEL

- Discussion about overall energy conservation design benefit

According to the pilot calculation of the aforesaid design influencing factors, the excellent passive design and excellent air-conditioning equipment (VP=0.9, EEV=0.6, d=5m, SEL=0.85), under the existing house design conditions of Taiwan, can reduce the routine energy consumption of residential air conditioning by 43%. Therefore, if the annual EUI of residential air conditioning is 10 (kWh/ m².yr), the minimum annual energy consumption is 10*0.6=6 (kWh/ m².yr).

4.1 Energy conservation potential of residential lighting design

The second factor influencing the residential energy consumption is the "lighting energy consumption". The BCF method estimates the lighting energy consumption as Equation 3. The EL index is the combined lighting energy-saving index about energy-saving lamps, lighting system and on-off control in Taiwan green building label EEWH.

$$\text{Annual energy consumption of lighting} = (\sum EU_{li} \times AF_{li}) \times EL$$

Equation 3

where, EU_{li} =Lighting EUI (kWh/ m².yr)

AF_{li} = Indoor floor area (m²)

EL=The lighting system energy-saving efficiency follows the green building assessment manual EEWH - BC daily energy saving index specification

Referring to EEWH system, this study uses minimum 0.4 of EL for evaluation, namely, the minimum annual energy consumption of lighting can be 40% of standard lighting energy consumption. Therefore, if the annual EUI of residential lighting is 18 (kWh/ m².yr), the minimum annual energy consumption is 18*0.4=7.2 (kWh/ m².yr).

4.2 Energy conservation potential of household electrical equipments

The electrical equipments refer to household electric equipments with plugs, such as computer, washing machine and so on. The BCF method regards the water heater, hot drinks machine and household sauna as household appliances. The energy consumption of electrical equipments is estimated as Equation 4:

$$\text{Annual energy consumption of electrical equipment} = (\sum EU_{li} \times AF_{li}) \times U_{ei}$$

Equation 4

where, EU_{li} =Lighting EUI (kWh/ m².yr)

AF_{li} = Indoor floor area (m²)

U_{ei} = Electrical equipment service management efficiency, using effective night standby power off management technique is 0.9

As the standby power consumption of household appliances accounts for about 10% of total power consumption of home, the BCF method privileges 10% of total energy consumption of electrical equipments for night standby power off management technique. Therefore, estimated by Equation 5-8, minimum value of U_{ei} is 0.9, if the annual EUI of household electrical equipments is 22 (kWh/ m².yr), the minimum annual energy consumption is $22 \times 0.9 = 19.8$ (kWh/ m².yr).

4.3 Total residential energy conservation potential

According to the aforesaid subitem evaluation, under current condition of general techniques, if the residential planning and design use the optimum energy conservation design technique, the residential air conditioning EUI can be reduced from 10 (kWh/ m².yr) to 6 (kWh/ m².yr), the lighting EUI can be reduced from 18 (kWh/ m².yr) to 7.2 (kWh/ m².yr), the electrical equipment EUI can be reduced from 22 (kWh/ m².yr) to 19.8 (kWh/ m².yr), the total EUI can be reduced from 50 (kWh/ m².yr) to 33 (kWh/ m².yr), the maximum energy-saving benefit is 34%.

Title	Subitem EUI (kWh/ m ² .yr)			Total EUI (kWh/ m ² .yr)
	Air conditioning	Lighting	Electrical equipments	
Original standard value	10	18	22	50
Optimum energy-saving technique applied	6	7.2	19.8	33
Maximum energy conservation potential	40%	60%	10%	34%

Table 3: Energy-saving technique, residential EUI and maximum energy conservation potential

4.4 Substitution potential of residential renewable energy technology

The renewable energy is estimated by using photovoltaic in this study. First, local daily average solar radiation quantity (kWh/ m².day) is obtained from meteorological data, multiplied by photovoltaic installed capacity (kW), number of days, service life and correction coefficient 0.8 (m²/ kWh), the annual electricity generation design value can be obtained (Equation 5).

$$\text{Photovoltaic panel electricity generation (kWh/year)} = \text{daily average solar radiation quantity (kWh/ m}^2\text{.day)} \times \text{Correction coefficient 0.8 (m}^2\text{/ kWh)} \times \text{Photovoltaic installed capacity (kW)} \times 365 \text{ (days)}$$

Equation 5

This study refers to the statistical data of Directorate General of Budget, Accounting and Statistics, Executive Yuan in 2015, the nationwide average area per household is about 150 m², the EUI is 33 (kWh/ m².yr), the annual total power consumption is 4950 kWh. Mounting 1kW crystalline silicon photovoltaic panel needs about 10 m², the annual electricity generation of 1kW photovoltaic panel in the north is about 803 kWh, that in the midland is about 949 kWh, that in the south is about 1095 kWh. Therefore, one household in the north needs at least 62 m² photovoltaic panel, that in the midland needs at least 52m² photovoltaic panel, and that in the south needs at least 45 m² photovoltaic panel. The specific payback period of investment is 14~19 years (Table 4).

If the individual house is a two-story building, 60%~80% of rooftop area shall be reserved for mounting photovoltaic panels. If it is a three-story building, as the rooftop area decreases, all the rooftop area shall be used, the shortage will be made up by ground area or upright space, so as to meet the goal for nZEB.

Besides the excellent energy conservation design of buildings, the application of renewable energy is the key to the success of nZEB. According to the aforesaid pilot calculation result, if a general-scale household (floor area 150 m²) is used for nZEB design in Taiwan, under the precondition of disregarding the equipment investment cost, using the rooftop and partial area within the site to mount photovoltaic panels is potential to implement nZEB. However, the actual residential pattern is much complex, especially in large metropolitan areas, the residential pattern is mostly high density amalgamated dwelling, only using rooftop to set up photovoltaic panels to reach the balance of nZEB is hardly feasible. Therefore, only if the solar cell efficiency is further increased in the future, the concept of "Building Integrated Photovoltaic (BIPV) system" is used actively, and the photovoltaic panels are set up thoroughly on at least 70% of rooftop area, 20% of open area and the building elevation, the nZEB may be implemented.

Site	Daily average solar radiation quantity (kWh/m ² .day)	Annual power generation per unit capacity (kWh/kW)	Total installed capacity (kW)	Mounting area (m ²)	Cost recovered years (yr)
North	2.75	803	6.2	62	19
Midland	3.25	949	5.2	52	16
South	3.75	1095	4.5	45	14

Table 4: Photovoltaic substitution potential calculation (area per household 150 m²)

5. CONCLUSION AND SUGGESTIONS

This study uses the BCF method of the "Low Carbon Building Alliance", controls the building envelop design, ventilation, lighting and household appliance factors in "residential standard situation", and calculates the "building EUI" under various energy-saving techniques, to evaluate the feasibility of nZEB. The results show that under the present general energy-saving techniques, the total residential EUI can be reduced from 50 (kWh/ m².yr) to 33 (kWh/ m².yr), the maximum energy-saving benefit is 34%.

This study uses "photovoltaic" as main renewable energy to evaluate the nZEB feasibility. The dwelling level is about 150 m² per household in Taiwan, under the precondition of EUI 33 (kWh/ m².yr), the small-scale "individual house" is potential to implement ZEB at present. However, in the case of amalgamated dwelling, the full elevation BIPV design and high conversion efficiency solar cell shall be developed, then it is potential to be ZEB.

In the promotion of related policies in the future, it is suggested to enhance the existing building energy saving reference, establish building energy label system, promote the improvement of the existing building efficiency, reward excellent green building design, and encourage the application of BIPV, so as to attain the goal for nearly ZEB.

REFERENCES

- [1] BPIE,2015.Nearly Zero Energy Building Definitions Across Europe [online] Retrieved from: http://bpie.eu/uploads/lib/document/attachment/132/BPIE_factsheet_nZEB_definitions_across_Europe.pdf [Retrieved on 15 Feb 2015]
- [2] Low Carbon Building Alliance (LCBA), About BCF method [online]. Retrieved from: <http://www.lcba.org.tw/> [Retrieved on 20 Aug 2016]
- [3] Lin,H.T.,2015.Building carbon footprint 2nd Edition. Taiwan, Taipei.
- [4] Lin, S.C. & Lee, H. C., 2013. The Study on Energy Consumption and Application of Residential Sector in Taiwan. JOURNAL OF ARCHITECTURE, 86, 1-9
- [5] Architecture & Building Research Institute, MOI (Ministry of the Interior),2015. Green Building Evaluation Manual. Taiwan, Taipei.

Directorate-General of Budget, Accounting and Statistics, Executive Yuan, Report on the Survey of Family Income and Expenditure 2014 [online]. Retrieved from:
<http://win.dgbas.gov.tw/fies/doc/result/103.pdf> [Retrieved on 10 Oct 2015]

Integrated Residential Household Energy Consumption and GHG Emissions Modelling at Metropolitan Scale

Raul MARINO^a, Greg FOLIENTE^b, Chris PETTIT^c

^a Melbourne School of Design, University of Melbourne, Australia, ramarino@unimelb.edu.au

^b Melbourne School of Engineering, University of Melbourne, Australia, gfoliente@nbluesystems.com

^c Faculty of Built Environment, University of New South Wales, Australia, c.pettit@unsw.edu.au

ABSTRACT

Urban-scale policy, planning and development decisions can have significant resource use and environmental impacts. The energy consumption and related greenhouse gas (GHG) emissions of residential households, in particular, are mostly due to their housing and transport energy consumption. At the metropolitan scale, the type **and location (or distribution) of housing can have a significant impact on the region's total energy and emissions profile.** This paper presents a bottom-up methodology for assessing the impacts of alternative urban forms on the urban energy and GHG emissions footprint, combining housing and transport energy consumption across all households in the study area. The integrated assessment is built around a common household typology, and then extends separately towards housing energy consumption (based on sub-typologies of housing type and age, end-use demand categories and supply) and transport energy consumption profiles. The impact of the spatial distribution of households can be assessed from small geographical levels (comprising of about 200 - 250 households) to the whole municipality or Local Government Area (LGA), and to the whole metropolitan scale (i.e. all of the 31 LGAs in Metropolitan Melbourne). We present herein the calculation and validation of the total baseline energy consumption, and related GHG emissions of all households in Metropolitan Melbourne in the census year 2011. This approach can be used in the next stage to assess the impacts of alternative urban forms into the future.

Keywords: urban form, building energy simulation, transport energy

1. INTRODUCTION

More than 75% of the world population are expected to live in cities in the next 10 years (UN Habitat, 2013). These **agglomerations exacerbate existing urban challenges and bring new ones. The nature and diversity of stakeholders'** decisions to address the increasing population and housing density and the changing demand and patterns of human mobility have a significant impact on resource consumption, particularly energy, and on the environment, particularly through the greenhouse gas (GHG) emissions caused by human activities (Jenks & Burgess, 2000). This has become even more important and urgent in the light of the global agreement (during the recent Conference of Parties, COP21, in Paris) to scale up the implementation of ambitious actions towards the "below 1.5 or 2°C" pathways. Different levels of government and stakeholders in urban governance and the building and construction sector need to map-out the most cost-effective options to contribute to this goal.

The assessment of urban energy includes the energy used in buildings, transport, industry, water management and wastes (Kennedy, 2012). Since the building and transport sectors have the largest contribution to energy consumption (SoE, 2014), the present study focuses in these two areas, but excluding their embodied impacts. Previous studies have traditionally looked at transport (e.g. Alford and Whiteman, 2009) and building stock (Foliente and Seo, 2012) separately.

Broadly, there are two general methods for modeling building stock energy use and associated GHG emissions: the bottom-up and the top-down approaches. Previous work by Crawford & Fuller (2010) and Rickwood (2010) integrated building and transport energy assessment based on a hybrid Input-Output (I-O) and Life Cycle **Assessment (LCA) methodology considering urban form, housing types and residents' travel behaviour.** These studies, like others that use aggregated data (i.e. the top-down approach), are useful to understand the impacts of broad policy, econometric or technological options, but are not practically useful to guide and assess the impact of specific decisions and/or actions of stakeholders. They could provide macro understanding of the entire housing sector, but are not concerned with individual end-users.

The bottom up approach is built from disaggregated data and analysis then combined according to the needs of the specific sector (Kavgic, 2010). Bottom-up studies that combine energy consumption in buildings (stationary energy) and transport (non-stationary energy) are very rare. In the Energy Efficiency Cities Initiative in the City Model (CiMo, 2014) Project, bottom-up engineering models of energy demand, supply, and emissions from buildings and surface transport at the city scale were applied to the City of Westminster. This UK approach is similar to separate studies that have been undertaken separately for these sectors in Australia (Foliente and Seo 2012; Ren et al. 2013).

Considering household travel needs and activities from their place of residence, there is a need for a similar intermediate approach in this area that builds on disaggregated travel data and/or detailed transport modelling and simulation results but simplified for application to practical planning scenarios impact assessments based on **selected household typologies**. This paper integrates the residential households' location and mobility patterns with their housing stock characteristics to establish the combined energy consumption from the bottom up to metropolitan scale.

2. METHODOLOGY

The cross-typology bottom-up building stock energy assessment framework proposed by Foliente and Seo (2012) to assess the impacts of different technology, investment, policy instruments and actions by different stakeholders into the future provides a starting platform for this type of intermediate approach. This provides a systematic and detailed classification (or sub-typologies) of variables that impact the total energy consumption and GHG emission of building stock in a given area (e.g. building characteristics, space conditioning system, lighting, hot water system, plug-in appliances, occupancy type and pattern, and local energy supply system); different options at these sub-typologies can be assessed at different scales and level of details. The cross-typology capability refers to a separate classification of intervention schemes.

The overall research has two main phases: (a) Calculation of a baseline building and transport energy profile, its validation at micro and macro scale (from Statistical Area 1 or SA1 level to SA3 and then metropolitan level); and (b) Application into future scenarios for the growth of Metropolitan Melbourne (business as usual vs alternative urban form scenarios) (Figure 1). This paper deals with the first phase only.

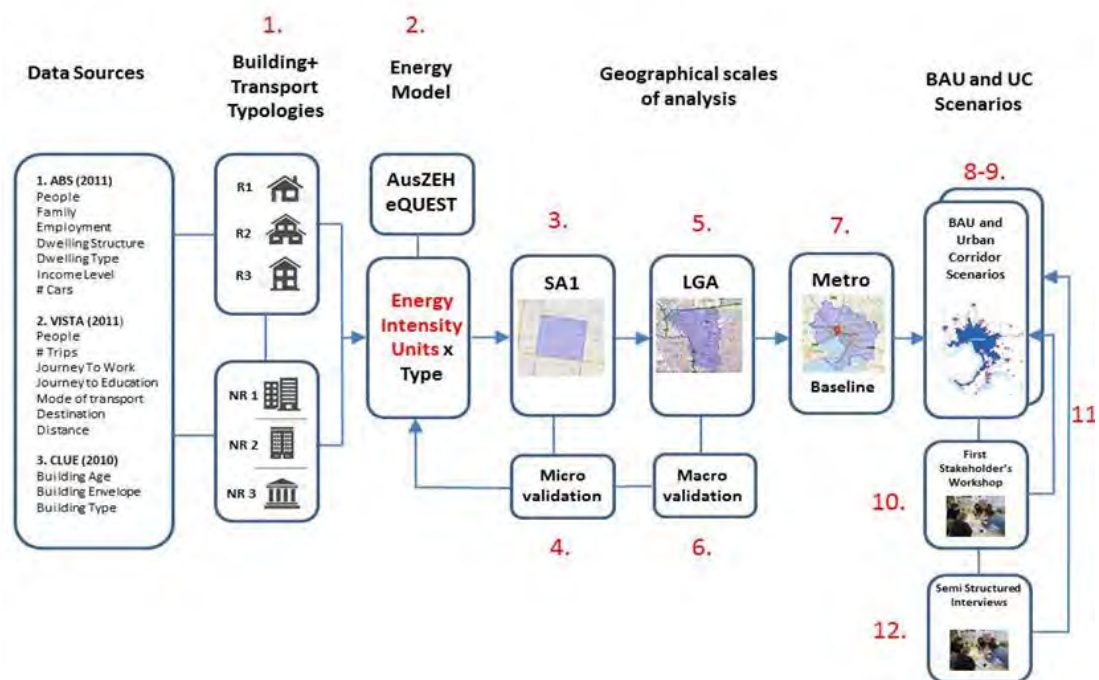

Figure 1: The research methodology's overall scheme; the present paper covers only the first phase of the planned work program (i.e. up to item/ step 7 only)

The residential building energy is modelled following the bottom-up building typology approach by Foliente and Seo (2012) and using the AusZEH software developed by CSIRO (Ren et al. 2012). The results were processed for distribution in the geographical scale using Microsoft Access and SQL queries to obtain the values per meshblock and per SA1. The Energy Intensity Units (EIU) and associated GHG emissions will take into consideration: a) Demand (Building, Load and Household type) b) Supply (Energy system: gas, electricity, solar, wind) and c) Consumption (Gross Energy and Energy Intensity Units x annum) with the Household type as integrating element (see Figure 2):



Figure 2: Integration between residential building and transport energy consumption

The smallest unit of building stock energy aggregation is at SA1 level (comprising of about 200 - 250 households) and the results are displayed within these boundaries. This is the smallest geographical unit that have available census data for modeling from the Australian Bureau of Statistics (ABS), mainly for dwelling type, household type and labour force. In addition, it is also compatible with the other datasets on dwellings, such as those from the Geoscience National Exposure Information System (Geoscience Australia, 2014)) database and property data from the **Valuer's General for the State of Victoria**. The SA1 scale also allows a finer grain visualization of the whole Metropolitan Melbourne, than other geographical scales that have been used previously by others.

For household travel related energy consumption, the smallest unit of analysis used is the meshblock level, as it was possible to request the Victorian Integrated Survey for Travel and Activity (VISTA, 2009) at this small geographical level. The survey sampled meshblocks covering all 31 LGAs in Metropolitan Melbourne and geographically distributed in an even form to cover equally all territory. The transport consumption was modelled from the household level, then summated up to meshblock level, and finally aggregated at SA1 level to match the unit of analysis used for the residential dwelling's operational energy consumption.

The processing of input data from various sources (left most part of Figure 1) and the modelling results/output data was facilitated by a script coded in Python which extracted and processed the information from the databases used in the research **ABS, NEXIS, Valuer's General and IMAP**) and distributed the **IMAP building typologies and their associated Energy Intensity Units (EIU)** at SA1 level using the information from the requested datasets (**ABS, NEXIS, Valuer's General and IMAP**) and automated the aggregation and mapping in ArcGIS. The goal is to analyze patterns of energy consumption at the report neighborhood level scale (SA1), and their main difference according to distribution of dwellings types, household types and location at LGA scale and the metropolitan scale. GHG emissions were calculated using the emission conversion factors for different fuel types for housing and transport from Australian Energy Market Operator (AEMO, 2012) and Australia Energy and the Australian Energy Institute (AEI, 2012).

3. MODELING RESULTS AND DISCUSSION

Figure 3 shows the results of the residential building stock energy consumption calculations mapped at SA1 level for the whole Metropolitan Melbourne area. As expected, the most intense consumption areas are those associated with larger population density. However, many SA1 areas with lower population density showed larger residential energy consumption than the average, mainly related to dwelling type and household type variables including occupancy type (hours of use) and household size.

These results were verified and validated through different data obtained in surveys, government reports, energy providers and residential energy bills. Verification of the model results was undertaken by comparing the results obtained by the model with the results obtained using the same bottom-up building typology approach proposed in the Inner Melbourne Energy Consumption Report 2011 - 2016 (Seo et al., 2014). In this report, they modeled the energy consumption of residential and commercial operational energy for the four inner city councils: the City of Melbourne, City of Port Phillip, City of Yarra, and City of Stonnington. The unit of analysis in this report was the meshblock geographical unit, as the information needed for the modelling was available at this fine grain unit, and the city officials wanted to see small variances between meshblocks in the different councils (IMAP, 2014).

The results of the IMAP work aggregated to a comparable SA1 level of geography were compared with the results of the model developed in the present research using the same energy modeling engine (AusZEH developed by CSIRO) but the latter energy mapping effort using a code developed in Python to automate the typologies distribution process. Figure 3 shows the comparisons of the percentage of difference between the IMAP results and the results obtained with the script developed in Python:

Model validation was undertaken using government reports, surveys and reports from energy providers and residential energy bills. The average consumption for the different sources was compared with the average operational energy results from the energy model. A micro validation (at building level) and a macro validation (SA1 level) were undertaken. The sources for the validation were selected depending on the availability of information for Victoria, as results can vary greatly between different states in different geographical zones. It is important to mention that some of the sources used for validation are surveys, and as such, they do not cover the whole population, instead only samples of the selected areas.

The main sources for the validation were:

- Victorian household energy survey report, May 2014
- Residential energy bill average (Lumo Energy, Brunswick) 2014
- Ausgrid report energy bill prices 2012 (medium size dual fuel household Melbourne)
- Energy Consumption Survey, ABS, 2012 (results for state of Victoria)

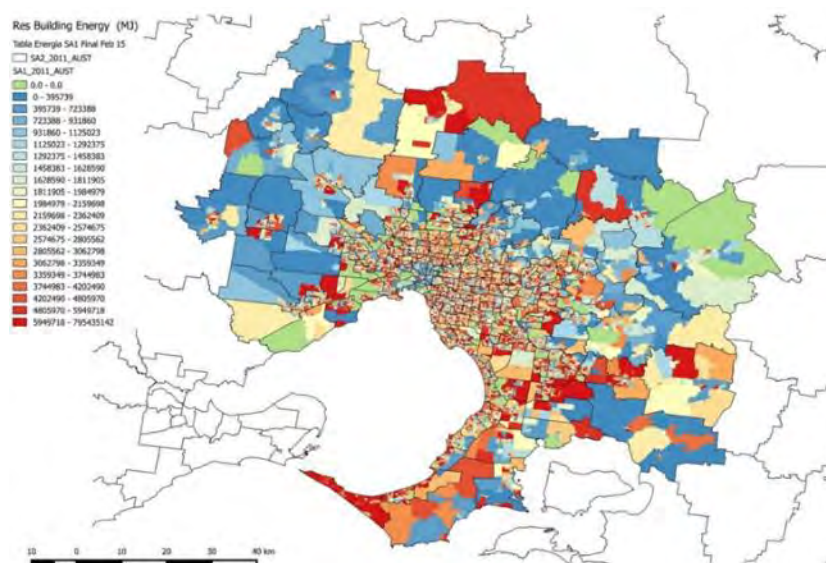

Figure 3: Metro-wide distribution of the residential building stock energy consumption (by SA1)

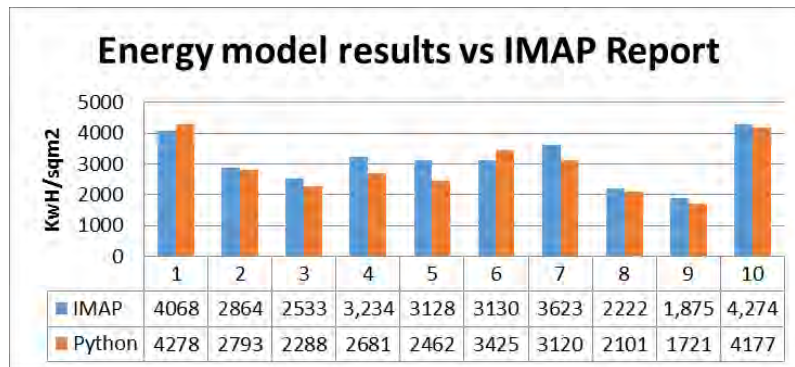

Figure 4: Comparison of IMAP vs. script model results for residential energy (by SA1)

Results show that the average consumption for a medium size dwelling type in this report was 19.671Kwh per annum for the micro validation level (residential building). For comparison, a random set of 10 SA1 from the simulated energy consumption were selected and its overall result per annum was divided in the number of dwellings reported in the ABS 2011 Census (see Figure 4). The results of the residential building average per dwelling of the selected SA1s was 20.003 KhW per annum, showing a difference of 3.5%, and generally a deviation of less than 10% is considered good for studies of this kind (IMAP, 2014).

Another type of macro-validation was undertaken using information from the Water and Energy Supply and Consumption (WESC) protocol or data standard developed by AURIN and CSIRO (combined monthly Meter Readings for aggregated electricity consumption by postcode for 2004 - 2012 in Jemena provider areas). The dataset is broken down into commercial, industrial, residential or unmetered uses, from postcode regions in the northwestern parts of Melbourne. Using this WESC information on residential energy, we compare the total residential operational energy consumption at a larger geographical scale (postcode), by aggregating the consumption of each SA1 conforming the Post Code area in the areas where Jemena Energy supplies energy. With the dataset in postcode 3058 (Coburg), our residential energy calculation under-predicted the actual aggregated data by 18.8% (estimated to be 2,692,638Kwh vs Jemena's reported figure of 3,198,113kwh).

Overall, the Inner Melbourne area variations in residential energy consumption are related with the Household Type and Dwelling and Occupancy type variables. Building age also has an impact on the efficiency of the building envelope to reduce heating and cooling energy consumption; a large part of the residential building stock in Metropolitan Melbourne is more than 35 years old (Sustainability Victoria, 2013).

Regarding the residential transport energy consumption, analysis of the 2011 VISTA survey data shows that large households (Hh_structure) tend to use more private transport for everyday activities, although households located near the transport corridors (train and tram lines) showed a smaller proportion of private car use in the modal split. **A Pearson's correlation analysis with the variable Distance (Sum_Dist) as dependent variable and other variables** selected (Distance from CBD, Main transport mode, dwelling type, Household Structure, Income, and Number of cars). The relationship between dwelling type and household type and private car VKT (Vehicle Kilometer Travel), shows only a small impact of these variables on the overall residential transport energy consumption.

	Correlation with Sum_Dist	Significance (R squared)
Hh_structure	0.0408	0.0017
Dwell type	-0.0952	0.0091
Income	0.0965	0.0093
Distance to CBD	0.2114	0.0224
Nr of cars	0.1628	0.0265

Figure 5: Pearson's correlation analysis residential transport energy model

Correlation analysis of the residential transport energy model shows a correlation between the dependent variable Sum_Dist (household Total VKT per mode) and the Nr of cars (# cars) and Distance to CBD (distance to CBD in Km) (Figure 5). Income and other socio economic variables were also considered, but in the case of the transport behaviour in Metropolitan Melbourne the correlation between income levels and use of private cars is not as strong as shown in other residential transport studies (Grose et al, 2015).

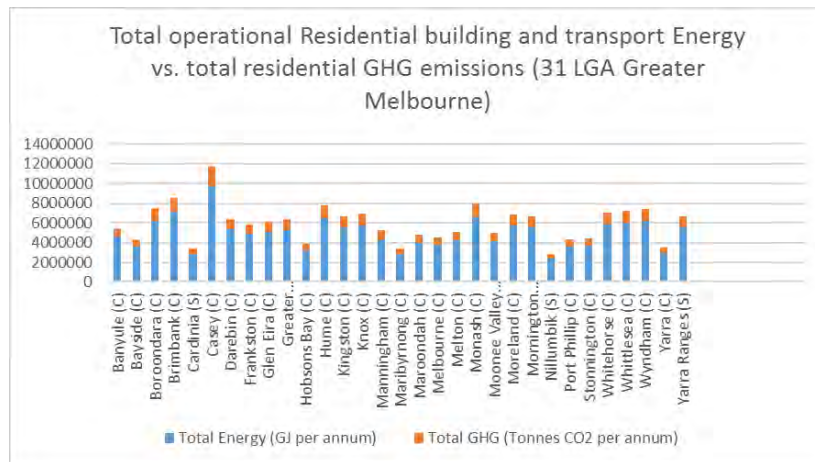

Figure 6: Combined residential building and transport energy and associated GHG emissions for 31 LGA Greater Melbourne

Once the residential buildings and transport energy was modelled, we calculated the GHG emissions based on the energy supply ratio established in the IMAF typologies (70% households with electricity+gas, 30% households with electricity only and 5% households with all sources installed); this also corresponds with the building stock report for residential energy supply from ABS (Households Energy Use and Cost, 2012). The Greenhouse Emission factors applied were the coefficient values reported by the Australian Institute of Energy (AEI, 2012) and the Australian Energy Market Operator (AEMO, 2016) for electricity and natural gas for the State of Victoria.

The residential transportation fuels emissions factors were provided by the Environmental Protection Authority (EPA, 2006) Assuming that 60% of private cars use petrol and 40% diesel (ABS, 2014) and the public transport (trams, trains) use electricity providing from coal energy plants, except for buses (100% Diesel).

Figure 6 shows the results of the combined residential building energy (in GJ x annum) and combined total GHG emissions (in Tonnes CO₂ x annum) at LGA level (31 LGA) for Greater Melbourne. the areas with higher dwelling density and car ownership have the largest impact on the operational energy (GJ per annum) and CO₂-equiv emissions, and the distance to the CBD and car ownership density are clearly showing a larger CO₂-equiv emission impact that the areas of Melbourne's Inner City.

4. CONCLUSIONS AND FUTURE WORK

We developed a new energy modeling methodology for calculating the total residential household energy, combining housing and transport energy consumption across all households in Metropolitan Melbourne. The integrated assessment is built around a common household typology, one branch was focused on housing energy consumption (based on sub-typologies of housing type and age, end-use demand categories and supply) and the other was on transport energy profiles (based on household and dwelling type information from VISTA 2011). The GHG emissions for residential buildings and residential transport have been modelled and distributed geographically at SA1 level, facilitating a spatial comprehension of consumption patterns in Metropolitan Melbourne. The distribution of household energy intensities was mapped from small geographical SA1 level to the whole municipality or Local Government Area (LGA), and to the whole metropolitan scale (i.e. all of 31 LGAs or 9650 SA1s across all of Metropolitan Melbourne). The total baseline energy consumption was spot-validated using various sources for the census year 2011. These capability and results bring us to the next stage of analyses considering the environmental impacts of alternative urban forms to accommodate the expected population growth in Melbourne.

REFERENCES

- [1] AEMO (2016) Australian Energy Market Operator, Emissions Factor Report, May 2016.
- [2] Alford, G., & Whiteman J. (2009). Macro-Urban Form, Transport Energy Use and Greenhouse Emissions: An investigation for Melbourne, Transport Policy and Research Unit, Department of Transport, Victoria
- [3] Ausgrid (2012) Ausgrid report energy bill 2012 Report (medium size dual fuel household Melbourne). Retrieve from:

<https://www.ausgrid.com.au/~media/Files/About%20Us/Newsroom/Discussions/2012%20Household%20Energy%20Bills%20%20Sydney%20vs%20Melbourne.pdf>

- [4] Australian Bureau of Statistics (2011) Census of Population and Housing, ABS, Canberra.
- [5] Australian Bureau of Statistics (2012) 4670.0 - Household Energy Consumption Survey, Australia: Summary of Results, 2012, ABS. Canberra, Australia.
- [6] Australian Bureau of Statistics (2014) 9208.0 - Survey of Motor Vehicle Use, Australia, 12 months ended 31 October 2014
- [7] CIMO, Energy Efficient Cities Initiative, University of Cambridge, 2012
- [8] Commonwealth of Australia (2014) Geoscience Australia, National Exposure Information System (NEXIS) Building Exposure - Statistical Area Level 1 (SA1)
- [9] Council of Australian Governments (COAG) National Strategy on Energy Efficiency (2012). Baseline Energy Consumption and Greenhouse Gas Emissions In Commercial Buildings in Australia
- [10] Crawford, R. & Fuller, R. (2012) Energy and Greenhouse Gas Emissions Implications of alternative housing types for Australia.
- [11] CSIRO (2014), Water and Energy Supply and Consumption (WESC) protocol or data standard. Retrieve from AURIN
- [12] Department of the Environment (2014) National Greenhouse Accounts Factors Report, Department of the Environment, Australian Government, Canberra.
- [13] Foliente, G., Seo, S. (2012). Smart and Sustainable Built Environment: Modeling building stock energy use and carbon emission scenarios. Smart and Sustainable Built Environment, Vol 1ss: 2pp 118-138
- [14] Grosse, J., Fertner, C., Groth, N. (2015) Urban structure, energy and planning: Findings from three cities in Sweden, Finland and Estonia, Urban Planning Journal, Cogitatio.
- [15] **Grosvenor, M., O'Neill, P. (2011) Exploring the Relationship between urban form and sustainable household behavior.** UWS, Australia
- [16] Jenks, M., E. Burton and K. Williams. (eds.) (1996). The Compact City. A Sustainable Urban Form? Spon Press, Chapman and Hall, London.
- [17] Kavgić et al (2010) A review of bottom-up building stock models for energy consumption. Elsevier Building and Environment 45 (2010) 1683–1697
- [18] Kennedy C., S. Pinceti S., & Bunje, P. (2011). The Study of urban metabolism and its application to urban planning and design. Environmental Pollution Journal, 159, 1965-1973
- [19] Kenworthy, J. (2003) Transport Energy Use and Greenhouse Gases in Urban Passenger Transport Systems: A Study of 84 Global Cities. Presented to the international Third Conference of the Regional Government Network for Sustainable Development, Notre Dame University, Fremantle, Western Australia, September 17-19, 2003
- [20] Lumo Energy (2015) Price and product information statement: Retrieve from: https://lumoenergy.com.au/~media/lumoenergy/pdfs/20160901_ppis_elec_vic_lumo_advantage_premium_flex.ashx
- [21] Rickwood, P. (2009) The impact of Physical Planning on Household Energy Use and GHG Emissions. (PhD Thesis) University of Technology, Sydney.
- [22] **Sustainability Victoria (2013) Retrofitting Victoria's Buildings – Summary Report.** Sustainability Victoria by Davis Langdon Australia Pty Ltd
- [23] Sustainability Victoria (2014) Victorian Household Energy Report, Ministry for Energy, Environment and Climate Change, Australia
- [24] Ren, Z. et al (2011) AUSZEH DESIGN: SOFTWARE FOR LOW-EMISSION AND ZERO-EMISSION HOUSE DESIGN IN AUSTRALIA. Proceedings of Building Simulation 2011: 12th Conference of International Building Performance Simulation Association, Sydney, 14-16 November.
- [25] Seo S., Foliente G., Lipkin F., Yum K-K., Anticev J., Egan S. and Reedman L. (2014). IMAP Report, Inner Melbourne Energy Consumption 2011-2026: Baseline and future scenarios forecasts for the residential and commercial sectors. Report No. EP13X, CSIRO, Australia.
- [26] Shimoda, Y. et al (2004) Residential end-use energy simulation at city scale. Building and Environment 39 (2004) 959–967
- [27] Valuer-General Victoria (2014) Parcel Property dataset aggregated at Post Code level, requested for this research project.
- [28] VISTA (2011) Victorian Integrated Survey of Transport and Activities, Department of Economic Development, Jobs, Transport and Resources, Victoria, Australia.

Building Life Cycle Carbon Emissions: A Review

TENG Yue^a, PAN Wei^b

^a The University of Hong Kong, Hong Kong SAR, tengyue@hku.hk

^b The University of Hong Kong, Hong Kong SAR, wpan@hku.hk

ABSTRACT

Buildings are responsible for a substantial percentage of energy use related carbon emissions that contribute to global warming. Examination of buildings' carbon emission has been one of the key issues for the sustainability. As a high-density city, Hong Kong has increasingly advocated the use of prefabrication for high-rise residential buildings. However, although life cycle carbon emission assessment has been widely applied to buildings, its implications on high-rise prefabricated buildings remain unclear. Therefore, this paper aims to contribute to a better understanding of the life cycle carbon emission assessment of high-rise prefabricated buildings in Hong Kong.

The review was carried out through a meta-analysis of relevant previous studies and a more focused examination of research in the context of Hong Kong. The meta-analysis was conducted from the temporal, spatial, functional and methodological dimensions using seven variables, namely, life span, life cycle phase, research area, research scope, building type, building height, and life cycle assessment method. The focused examination reveals a severe gap in knowledge of the life cycle carbon emissions of high-rise prefabricated buildings in Hong Kong. A lack of understanding was also identified of the operational stage and indirect implications of prefabricated buildings. Furthermore, there is absence of consistent life cycle carbon assessment method in addressing the gaps. A systemic model of examining the carbon emissions of high-rise buildings is suggested to address the full building life cycle.

Keywords: life cycle assessment, carbon emission, high-rise prefabricated building, Hong Kong

1. INTRODUCTION

The excessive releasing of greenhouse gases (GHGs) is the largest cause of global warming, which has created risks worldwide (Soetanto et al., 2014). Carbon dioxide (CO₂), produced by consumed energy, has been the primary component of the GHG (Li et al., 2016). According to Sadineni et al. (2011), buildings are responsible for almost one third of the energy-related CO₂ emissions. In Hong Kong, this figure can be as high as 60% (EPD, 2010). Research into the environmental impact of buildings is thus important to Hong Kong.

Being a high-density city, Hong Kong has increasingly advocated prefabrication for high-rise buildings. Although relevant studies have widely applied life cycle carbon assessment (LCCO₂A) method for evaluating carbon emissions from the construction industry, the use of this method for high-rise prefabricated buildings remains unclear. Therefore, it is vital to explore consistent method of LCCO₂A for prefabricated high-rise buildings. This paper aims at contributing to a systematic understanding of LCCO₂A of buildings in Hong Kong. There are three research objectives: (1) to reveal the profiles of previous studies on LCCO₂A of buildings; (2) to investigate the implications of LCCO₂A for high-rise prefabricated buildings in Hong Kong; and (3) to explore the research gaps and recommendations.

2. THE CONCEPT OF LCA AND LCCO₂A

According to International Organization for Standardization (ISO, 2006), life cycle assessment (LCA) was defined as “**compilation and evaluation of the inputs, outputs and the potential environmental impacts of a product system through its life cycle**”. As a simplified version of LCA, LCCO₂A only focuses on CO₂ relevant emissions (Chau et al., 2015). The building's life cycle can be divided into four main phases: production, construction, operation and end-of-life (Kamali and Hewage, 2016). However, previous studies examined the building's life cycle carbon emissions in different interpretations of the building life cycle: e.g. from “cradle to gate” (Din and Brotas, 2016), from “cradle to site” (Gardezi et al., 2016), from “cradle to grave” (Blengini, 2009), and from “cradle to cradle” (Sinha et al., 2016). Subsequently, the various concepts of LCCO₂A, coupled with inconsistent data collection methods, boundaries, and calculation methodologies, call for a critical review of previous research.

3. REVIEW METHODS

The research was carried out through a meta-analysis of previous relevant studies and a focused examination of research within the Hong Kong context.

In the meta-analysis, a commonly applied search engine, Scopus, was firstly selected to identify relevant articles published in peer-reviewed journals during the period from 1996 to 2016. The keywords were identified as: “Life Cycle” and “Carbon Emission” and “Building” in undertaking the analyses. Papers with these specific terms included in the Title/Abstract/Keyword were considered to have fulfilled the requirement of this review. The search was further limited to subject areas such as “engineering”, “environmental science”, “energy”, “social and management” with the document types of articles. Through the process, the search limited the data sources to a list of representative 13 journals. Subsequently, a total of 173 articles were identified (Table 1).

	Journal	Number of articles
1	Applied Energy (AE)	14
2	Building and Environment(BE)	31
3	Building Research and Information (BRI)	8
4	Energy (EN)	7
5	Energy and Buildings(EB)	44
6	Energy Policy (EP)	6
7	Environmental Impact Assessment Review(EIAR)	4
8	Habitat International (HI)	2
9	International Journal of Life Cycle Assessment(IJLCA)	21
10	Journal of Cleaner Production(JCP)	21
11	Journal of Environmental Management (JEM)	3
12	Renewable Energy (RE)	4
13	Renewable and Sustainable Energy Reviews(RSER)	8
	Total	173

Table 1: Selected journal and articles for analysis

The meta-analysis method, prompted by Pan and Ning (2015), was then applied to the 173 articles identified to investigate the LCCO_{2A} of buildings. Seven variables were selected drawing on literature, from temporal, spatial, functional and methodological dimensions (Table 2).

Dimensions	Variables	Description of variables
Temporal	Life span	The service life of the buildings
	Life cycle phase	Full life cycle or not
Spatial	Research area	Location of the buildings
	Research scope	Building as a whole; components; materials; system; others
Functional	Building type	Residential buildings; non-residential buildings
	Building height	High-rise; medium-rise; low-rise buildings
Methodological	LCA Methods focus	Input-output; process based; hybrid method

Table 2: Dimensions and variables for review

In the focused examination, six papers focusing on LCCO_{2A} of buildings in Hong Kong were identified. The analysis was carried out from the dimensions of case study, building type, life cycle phase, LCA method, research method and key data input.

4. REVIEW RESULTS AND ANALYSIS

4.1 Results of meta-analysis

4.1.1 Profile of research in the temporal dimension

- Buildings' life cycle phase examined

Among the 173 articles, 134 indicated the life cycle phase of the cases studied, of which 43.3% (58) focused on the examination of LCCO₂A from the full life cycle. The other LCCO₂A studies of the partial life cycle (76; 56.7%) **mainly included those articles examining the “cradle to end of construction” (23.7%; 18), “cradle-to-gate” (19.7%; 15), and the “operation” (18.4%; 14). There were also some articles addressing “cradle to site” or “cradle to grave” (both of 13.2%; 10), and some others studying “cradle to operation” (10.5%; 8).**

- **Buildings’ life span studied**

Among the 173 articles examined, 69.9% (121) addressed particular building cases and clearly specified the service life span of the cases. However, the life spans addressed in these 121 articles were inconsistent: falling in three groups (1) between 25 (exclusive) and 50 years (inclusive) (50.4%), (2) 25 years or less (22.3%), and (3) greater than 50 years (27.3%). In particular, 27.3% and 19.0% of the 121 articles adopted 50-year and 100-year life span, respectively.

4.1.2 Profiles of research in the spatial dimension

- **Research area studied**

The majority (89%; 154) of the identified articles specified **the cases’ locations in text, whereas the rest did not** explicitly describe them. Among these 154 articles, the largest category (26.6%; 41) addressed the examination of LCCO₂A in Europe, followed by the categories addressing U.S. (13.6%; 21), Mainland China (12.3%; 19) and Korea (10.4%; 16). However, only a few (3.9%; 6) examined the cases in Hong Kong. For the 41 articles focused on the Europe, Sweden was the most researched (31.7%; 13). These results reveal a lack of studies into the life cycle carbon emissions of buildings in Hong Kong.

- **Research scope examined**

The research scope in relation to the LCCO₂A of buildings exists at four layers: materials, components, systems, and buildings as a whole. Nearly three quarters (130; 75.1%) of the 173 identified articles clearly pointed out their research scopes. For the 130 articles, the largest category (57; 43.8%) studied LCCO₂A of buildings from the **perspective of “Materials”, followed by 28 articles (21.5%) studying “Components of buildings” (Table 3). The number of articles examined from the perspective of “Systems” (23; 17.7%) and “Buildings as a whole” (22; 16.9%)** nearly remains the same.

Group	Description	Number
Materials	Focusing on the materials (concrete, cement, wood, steel, etc.) in the buildings	57
Components	Focusing on components (envelope, floor, foundation, interior, etc.) in buildings	28
Systems	Focusing on the system (fuel and heating system; household biogas system; rainwater systems, thermal system, etc.) in the buildings	23
Buildings as a whole	Focusing on the whole buildings	22
Others	Macro analysis; No case studies; Not concentrating on specific buildings, etc.	43

Table 3: Articles of buildings’ LCCO₂A by research scope

4.1.3 Profiles of previous research in the functional dimension

- **Building type studied**

Buildings are divided into residential and non-residential buildings (e.g. industrial, commercial, educational and health buildings) (Wong et al., 2000). Among the identified 173 articles, only 61.3% (106) definitely showed the **buildings’ types of the cases. The results illustrate that the majority of the articles (73; 68.9%) studied the LCCO₂A** of residential buildings, whereas merely 33 articles (31.3%) addressed that of no-residential buildings. Under the category of non-residential buildings, nearly half (16; 48.5%) studied office buildings, followed by those studying educational buildings (8; 24.2%) and commercial buildings (7; 21.2%); very few examined the cases of health

buildings (1; 3.0%) and historic buildings (1; 3.0%). The salience of research on residential buildings illustrates the clear focus of previous research on examining the life cycle carbon emissions of domestic buildings.

- Building height examined

According to Jan et al. (2004), buildings are divided into four types based on the stories: low-rise (less than 3 stories), medium-rise (4 to 6 stories), medium-to-high-rise (7 to 9 stories), and high-rise (greater than 10 stories). Among the identified 173 articles, only 97 articles specified the height of the cases. The majority of the LCCO₂A articles (43; 44.3%) studied low-rise buildings, followed by the group addressing medium-rise (22; 22.7%) and high-rise buildings (25; 25.8%), with a marginal amount of studies addressing medium-to-high-rise buildings (7; 7.2%).

4.1.4 The Profile of previous research in the methodological dimension

Three LCA methods, i.e. process-based analysis, input-output analysis and hybrid analysis, have been advocated by previous studies to calculate the carbon emissions of buildings (Ries and Mahdavi, 2001). Only 41.6% (72) of the identified 173 articles implemented the calculation process and adopted one of the three methods. The results show the majority of the studies adopted input-output and process-based methods in their LCCO₂A examination, namely 34 (47.2%) and 31 (43.1%) of the articles. Only about one in ten (7; 9.7%) used hybrid analysis method.

4.2 Results of focused examination within the Hong Kong context

Despite several studies have examined LCCO₂A of buildings, little research has been undertaken into high-rise prefabricated buildings in Hong Kong. To address this gap, six identified papers which are relevant to Hong Kong were investigated thoroughly (Table 4).

	Authors	Case study	Building type	Life cycle phase	LCA method	Research method	Key data input
1	Chau et al. (2012)	CB ^a	HR office	cradle-to-end of construction	process-based	Monte Carlo method	First hand data; Reference; Published information.
2	Zhang et al. (2013)	CB	a thirty-story commercial	Full life cycle	process-based	inventory analysis; case study	Report by the Electrical Mechanical Service Department of Hong Kong; Literatures.
3	Chiang et al. (2014)	CB	residential	cradle to site	NA	NA	ICE database
4	Jaillon and Poon (2014)	review	HR residential	deconstruction phases	NA	Questionnaire survey	Questionnaire survey; Face-to-face interviews; Site observations.
5	Dong et al. (2015)	CB and PB	HR residential	cradle-to-end of construction	process-based	SimaPro	Questionnaire survey; Semi-structured interview; Ecoinvent.
6	Pan et al. (2016)	NA	PRH	NA	Simulation	BEA software	Literature review; Technical analysis; Case study;

^aCB means the conventional buildings and PB means the prefabricated buildings.

Table 4: Previous studies of buildings' LCCO₂A in Hong Kong

Chau et al. (2012) conducted Monte Carlo method to predict CO₂ emissions of the superstructure of thirteen high-rise office buildings in Hong Kong. It provided a method to evaluate the emissions reduction impacts by using different materials. However, operational stage was not considered in this research. Zhang et al. (2013) analysed a thirty-story high commercial building to examine eight types of air emissions in Hong Kong, using an inventory analysis method. It contributed to identify the optimal solution of minimizing the air emissions in early stage. However, this paper used a second data that needed to be improved in further studies. Chiang et al. (2014) proposed an optimization model from environmental, economic, and social criterions. A residential building, with a **75 years' life span in Hong Kong, was used as the case study. It helped decision makers choose a reduction method both from economic and social aspects.** However, the operational stage was not included in this analysis. Jaillon and Poon (2014) proposed a review on design for deconstruction and a case study on industrialized building.

Findings from the case studies shows there are several advantages when adopting prefabrication in Hong Kong. However, this article just focused on the deconstruction phases. Dong et al. (2015) compared the carbon emissions **of precast and traditional construction methods from the “cradle-to-end of construction” life cycle phase, based on** a high-rise private residential building in Hong Kong. Results showed reduction of carbon emission could be 10% due to precast concrete. Pan et al. (2016) developed strategies for modelling carbon emissions in 40-story public residential buildings in Hong Kong. It helped to achieve efficient and accurate building energy simulation and carbon emission estimation of high-rise buildings in Hong Kong. These studies show LCCO₂A of traditional high-rise buildings have been carries on by some scholars, whereas very few studies worked on LCCO₂A of prefabricated buildings in Hong Kong.

5. DISCUSSION

The results of the meta-analysis reveal some general trends of previous studies. First, it reflects the inconsistent **of cases' service life span. In the identified articles, 50-year and 100-year life span** are the relatively most widely accepted life span. Second, despite some studies have emphasised the analysis from the full life cycle aspect, the **non-full life cycle was carried on by more scholars, especially the phase of “cradle to end of construction”, “cradle-to-gate”, and the “operation”.** The reason may lay in the statements by some researchers that carbon emissions in the use and end-of-life phases were insignificant and could be neglected (Flower and Sanjayan, 2007). Third, although there are abundant LCCO₂A articles in Europe, U.S., Mainland China and Korea, very few studies have been conducted in Hong Kong, which reveals the demand for further research. Fourth, the majority of articles addressed the **LCCO₂A studies from the materials' aspect, which manifested the importance of changing materials** for reducing the carbon emission (Wu et al., 2014, Ingrao et al., 2015). Fifth, residential buildings were demonstrated as the main research objectives of previous LCCO₂A cases. This finding supports the statement of Li et al. (2013) that residential buildings' carbon emissions are rather prodigious. Among the no-residential buildings, nearly half of them studied office buildings. However, the majority of LCCO₂A analysis just focused on low-rise buildings. Therefore, the lack of understanding on the mid high-rise and high-rise buildings needs to be optimised in further research. Sixth, the input-output and the process-based methods have been widely advocated in previous research. Nevertheless, the articles adopting hybrid method are inadequate, albeit the demonstrated efficiency of it (Zhang and Wang, 2016).

The in-depth examination of the identified six articles reveals research problems. First, although studies on the carbon emissions from the upstream phase of buildings are abundant, the operation phase has been overlooked in Hong Kong. This finding is in line with the observation of Kamali and Hewage (2016) that the evaluation of CO₂ emissions from the upstream phase was increasingly common in recent years. However, the operational phase can occupy 80% of all life cycle carbon emissions (Mao et al., 2013), which should not be ignored. Second, studies on high-rise prefabricated buildings in Hong Kong are inadequate. One reason might be that prefabrication has not yet been a recognised phase in the building life cycle. Another reason appeared to be the insufficient adoption of precast concrete components within the precast yard (Dong and Ng, 2015), which leads to the limited applications and analyses using real projects. Third, the direct implications were considered while the indirect ones were ignored. For example, the improved quality of buildings can reduce the carbon emission from full life cycle aspect, which should be taken into consideration in the calculation of carbon emissions.

6. CONCLUSIONS

Drawing the results and discussion, this paper concludes that uncertainties and inconsistency in the adoption of LCCO₂A methods contribute to a fragmented understanding of the LCCO₂A of high-rise prefabricated buildings. These uncertainties and inconsistency are caused by the differences in system boundaries, assumptions, chosen life span, building types and locations in LCCO₂A. The paper also concludes that there is a lack of understanding of **LCCO₂A relevant to the building's operational stage and prefabricated buildings' indirect implications.** There is a severe gap in the knowledge of the LCCO₂A of high-rise prefabricated buildings in Hong Kong. To bridge this gap, a systemic model of examining the carbon emissions of high-rise buildings is suggested, which addresses the inconsistency of LCCO₂A method. By this systemic model, the carbon emissions generated from the full life cycle will be accounted. The life cycle will cover eight phases: cradle-to-gate (P1), transportation (P2), prefabrication (P3), construction (P4), operation (P5), maintenance and refurbishment (P6), deconstruction (P7) and recycling/landfill (P8). First, data in the phase of cradle-to-gate (P1) will be primarily collected from Carbon Labelling of Construction Products in Hong Kong and Life Cycle Inventory worldwide, being calculated using

process-based method. Second, carbon emissions in prefabrication (P2- P3) and construction (P4) phases will be examined using data from resource and energy consumption during transportation and installation in the construction yards and site. Third, operational carbon emissions (P6-P8) will be determined using EnergyPlus software, based on the simulated energy consumption. Last, data in the after-use phase (P9-P10) will be obtained through LCA inventories and literature review subject to their compatibility with available LCA inventories. The adoption of this systemic model will help to achieve a better understanding of the life cycle carbon emissions of buildings within high-rise contexts.

ACKNOWLEDGMENT

The work described in this paper was supported by a grant from the General Research Fund of the Hong Kong Research Grants Council (RGC GRF Project No.: 17207115).

REFERENCES

- [1] BLENGINI, G. A. 2009. Life cycle of buildings, demolition and recycling potential: a case study in Turin, Italy. *Building and Environment*, 44, 319-330.
- [2] CHAU, C., HUI, W., NG, W. & POWELL, G. 2012. Assessment of CO₂ emissions reduction in high-rise concrete office buildings using different material use options. *Resources, Conservation and Recycling*, 61, 22-34.
- [3] CHAU, C., LEUNG, T. & NG, W. 2015. A review on life cycle assessment, life cycle energy assessment and life cycle carbon emissions assessment on buildings. *Applied Energy*, 143, 395-413.
- [4] CHIANG, Y., ZHOU, L., LI, J., LAM, P. & WONG, K. 2014. Achieving sustainable building maintenance through optimizing life-cycle carbon, cost, and labor: Case in Hong Kong. *Journal of Construction Engineering and Management*, 140, 05014001.
- [5] DIN, A. & BROTAS, L. 2016. Exploration of life cycle data calculation: Lessons from a Passivhaus case study. *Energy and Buildings*, 118, 82-92.
- [6] DONG, Y. H., JAILLON, L., CHU, P. & POON, C. 2015. Comparing carbon emissions of precast and cast-in-situ construction methods—A case study of high-rise private building. *Construction and Building Materials*, 99, 39-53.
- [7] DONG, Y. H. & NG, S. T. 2015. A life cycle assessment model for evaluating the environmental impacts of building construction in Hong Kong. *Building and Environment*, 89, 183-191.
- [8] EPD, E. A. 2010. Guidelines to Account for and Report on Greenhouse Gas Emissions and Removals for Buildings in Hong Kong. The HKSAR Government, Hong Kong.
- [9] ERBERIK, M. A. 2008. Fragility-based assessment of typical mid-rise and low-rise RC buildings in Turkey. *Engineering Structures*, 30, 1360-1374.
- [10] FLOWER, D. J. & SANJAYAN, J. G. 2007. Green house gas emissions due to concrete manufacture. *The international Journal of life cycle assessment*, 12, 282-288.
- [11] GARDEZI, S. S. S., SHAFIQ, N., ZAWAWI, N. A. W. A., KHAMIDI, M. F. & FARHAN, S. A. 2016. A multivariable regression tool for embodied carbon footprint prediction in housing habitat. *Habitat International*, 53, 292-300.
- [12] INGRAO, C., GIUDICE, A. L., BACENETTI, J., TRICASE, C., DOTELLI, G., FIALA, M., SIRACUSA, V. & MBOHWA, C. 2015. Energy and environmental assessment of industrial hemp for building applications: A review. *Renewable and Sustainable Energy Reviews*, 51, 29-42.
- [13] ISO, I. 2006. 14040: Environmental management—life cycle assessment—principles and framework. London: British Standards Institution.
- [14] JAILLON, L. & POON, C. 2014. Life cycle design and prefabrication in buildings: A review and case studies in Hong Kong. *Automation in Construction*, 39, 195-202.
- [15] JAN, T. S., LIU, M. W. & KAO, Y. C. 2004. An upper-bound pushover analysis procedure for estimating the seismic demands of high-rise buildings. *Engineering Structures*, 26, 117-128.
- [16] KAMALI, M. & HEWAGE, K. 2016. Life cycle performance of modular buildings: A critical review. *Renewable and Sustainable Energy Reviews*, 62, 1171-1183.
- [17] LI, D., CHEN, H., HUI, E. C., ZHANG, J. & LI, Q. 2013. A methodology for estimating the life-cycle carbon efficiency of a residential building. *Building and environment*, 59, 448-455.

- [18] LI, D., CUI, P. & LU, Y. 2016. Development of an automated estimator of life-cycle carbon emissions for residential buildings: A case study in Nanjing, China. *Habitat International*, 57, 154-163.
- [19] LUO, Z., YANG, L. & LIU, J. 2016. Embodied carbon emissions of office building: A case study of China's 78 office buildings. *Building and Environment*, 95, 365-371.
- [20] MAO, C., SHEN, Q., SHEN, L. & TANG, L. 2013. Comparative study of greenhouse gas emissions between off-site prefabrication and conventional construction methods: two case studies of residential projects. *Energy and Buildings*, 66, 165-176.
- [21] PAN, W. & NING, Y. 2015. The dialectics of sustainable building. *Habitat International*, 48, 55-64.
- [22] PAN, W., QIN, H. & ZHAO, Y. (2016) Challenges for energy and carbon modeling of high-rise buildings: The case of public housing in Hong Kong. *Resources, Conservation & Recycling*, doi:10.1016/j.resconrec.2016.02.013.
- [23] RIES, R. & MAHDAVI, A. 2001. Integrated computational life-cycle assessment of buildings. *Journal of Computing in Civil Engineering*, 15, 59-66.
- [24] SADINENI, S. B., MADALA, S. & BOEHM, R. F. 2011. Passive building energy savings: A review of building envelope components. *Renewable and Sustainable Energy Reviews*, 15, 3617-3631.
- [25] SINHA, R., LENNARTSSON, M. & FROSTELL, B. 2016. Environmental footprint assessment of building structures: A comparative study. *Building and Environment*, 104, 162-171.
- [26] SOETANTO, R., ZHANG, S., PAN, W. & KUMARASWAMY, M. 2014. A multi-criteria decision framework for the selection of low carbon building measures for office buildings in Hong Kong. *International Journal of Energy Sector Management*, 8, 456-476.
- [27] WONG, L., CHOW, W. & KWAN, E. C. 2000. A brief review on fire regulations for old highrise commercial buildings in Hong Kong. *International Journal on Engineering Performance-Based Fire Codes*, 2, 153-160.
- [28] WU, P., XIA, B. & ZHAO, X. 2014. The importance of use and end-of-life phases to the life cycle greenhouse gas (GHG) emissions of concrete—a review. *Renewable and Sustainable Energy Reviews*, 37, 360-369.
- [29] ZHANG, X., SHEN, L. & ZHANG, L. 2013. Life cycle assessment of the air emissions during building construction process: a case study in Hong Kong. *Renewable and Sustainable Energy Reviews*, 17, 160-169.
- [30] ZHANG, X. & WANG, F. 2016. Hybrid input-output analysis for life-cycle energy consumption and carbon emissions of China's building sector. *Building and Environment*, 104, 188-197.

How Carbon Metric Standard Could Facilitate Innovation for Reduction of GHG Emission from Buildings?

Tomonari YASHIRO^a, Thomas LÜTZKENDORF^b, David CROWHURST^c, Rodney MCPHEE^d, Guido HOFF^e, Gérard SENIOR^f, Ning HUANG^g

^a The University of Tokyo, Japan, yashiro@iis.u-tokyo.ac.jp

^b Karlsruhe Institute of Technology (KIT), Germany, thomas.luetzkendorf@kit.edu

^c Building Research Establishment, United Kingdom, crowhurstd@bre.co.uk

^d Canadian Wood Council, Canada, rmcphee@cwcc.ca

^e DIN, Germany, guido.hoff@din.de

^f Architecte A.E.T.I.C., France, gseigneur@club-internet.fr

^g GWS, Mainland China, henryh71@hotmail.com

ABSTRACT

The authors have collaborated to develop the new international standard on carbon metric (CM) of a building during the use stage (ISO 16745-2015). Carbon metric (CM) is a partial carbon footprint. It implies the sum of annual greenhouse gas emissions and removals, based on the real energy consumption and expressed as CO₂ equivalents. CM is relevant for snapshot measurement in the operational stage of building. It does not require professional knowledge about methods such as overall environmental performance assessment and life cycle assessment (LCA). **Carbon metric is usable also in those countries where experts' services are limited.**

The paper presents how the standard sets out a globally applicable common method of the calculating, reporting and verification of CM, including an explanation of the different system boundaries and preconditions. It focuses on how the standard simplifies and clarifies the method to make it globally applicable.

The paper discusses on how the standard could facilitate innovation for reduction of GHG emission from buildings. It is applicable in actions and policies for reduction of greenhouse gas (GHG) emission that includes the benchmarking for property management strategy, energy management service contract, post-occupancy evaluation, and education. The standard also provides the basis for cap and trade program. It also enables monetizing for international carbon trading (CDM in building related sectors)

Keywords: carbon metric, energy measurement and verification, carbon finance

1. INTRODUCTION

Measurement and reporting of greenhouse gas (GHG) emissions from existing buildings are critical for enabling significant and cost-effective GHG mitigation. Currently, there has not been a globally agreed method established to measure, report, and verify potential reductions of GHG emissions from existing buildings in a consistent and comparable way. If such a method existed, it could be used as a universal tool for measurement and reporting of GHG emissions, providing the foundation for accurate performance baselines of buildings to be drawn, national targets to be set, and carbon trading to occur on a level playing field.

In view of the context above, UNEP-SBC has proposed the idea of Common Carbon Metric of Building as a globally agreed method to measure, report, and verify potential reductions of GHG emissions from existing buildings (UNEP 2009). Following up the initiative by UNEP-SBCI, the authors have collaborated to develop the new international standard on the metric of GHG emission of a building during the use stage (ISO 16745-2015: Environmental performance of buildings — Carbon metric of a building during the use stage). It aims to set out a globally applicable common method of measuring and reporting of associated GHG emissions (and removals) attributable to existing buildings, by providing requirements for the determining and reporting of a carbon metric(s) of a building.

This paper presents how the standard sets out a globally applicable common method of the calculating, reporting of CM, including an explanation of the different system boundaries and preconditions.

2. WHAT IS CARBON METRIC OF BUILDING?

2.1 A measure that focuses on use stage of a building

In principle, accurate and precise reporting can only be achieved if GHG emissions from all life cycle stages of buildings are measured and quantified. However, not all countries in the world have sufficient capacity or resources to use and apply life cycle assessment (LCA) methodologies. Besides, we need to bear in mind that operational energy use in buildings typically accounts for 70 %–80 % of energy use over the building life cycle. Therefore, the **operating stage of the building's life cycle could be the focus of measurement** and reporting of direct and indirect GHG emissions.

Respecting the need for collaboration on a global scale, the need exists for a metric that is usable not only in countries with a sufficient number of experts and a precise database but also in those countries where experts' services are limited and databases have considerable gaps. The idea of carbon metric has emerged in consideration of 70 %–80 % share of energy use over the building life cycle as well as the need of simple metric that is usable by non-LCA-expert. Carbon metric is a measure that is based on energy use data and related building information for an existing building in operation.

ISO 16745 defines carbon metric (CM) as “sum of annual greenhouse gas (GHG) emissions and removals, expressed as CO₂ equivalents, associated with the use stage of a building”. CM is measured by kg CO₂e/ year. CM is, in a sense, a partial carbon footprint. While a product carbon footprint includes all possible GHG emission over the all life stages of a product, CM is based on energy use data and related building information for an existing building in operation.

Associated with carbon metric, the standard defines carbon intensity as “carbon metric expressed in relation to a specific reference unit related to the function of the building.” Here reference units include per unit area, per person, per kilobyte, per unit output, and per GDP. Thus, carbon intensity is measured by kg CO₂e/ year/ m², or kg CO₂e/ year/ occupants etc.

2.2 Principles in determining the carbon metric

To ensure that GHG-related information represents a true and fair measure, ISO16745 indicates the following principles in the determination of carbon metric.

- **Completeness:** Include all relevant GHG emissions that provide a significant contribution to the carbon metric.
- **Consistency:** Apply assumptions, methods, and data in the same way throughout the carbon metric determination to arrive at conclusions by the needs of the intended user and intended use.
- **Relevance:** Select the GHG sources, GHG sinks, GHG reservoirs, data, and methodologies appropriate to the needs of the intended user and the intended use.
- **Coherence:** Select the methodologies, standards, and guidance documents already recognized and adopted for energy measurement and consumption to enhance comparability between carbon metrics calculated by different system boundary definition (See 2.3).
- **Accuracy:** Ensure that the carbon metric quantification and communication are accurate, verifiable, relevant, and not misleading and that bias is avoided and uncertainties are minimized.
- **Transparency:** Address and document all relevant issues in an open, comprehensive, and understandable presentation of information.
- **Avoidance of Double Counting:** Avoid counting of greenhouse gas emissions that have already been allocated within other carbon metrics.

2.3 System boundaries of a carbon metric

A consistent definition of system boundary is essential to satisfy the principles shown in 2.2. ISO 16745 indicates the following three types of carbon metrics of a building:

- Carbon metric 1 (CM1) is the sum of annual GHG emissions, expressed as CO₂ equivalents, from building-related energy use;

- Carbon metric 2 (CM2) is the sum of annual GHG emissions, expressed as CO₂ equivalents, from building- and user-related energy use;
- Carbon metric 3 (CM3) is the sum of annual GHG emissions and removals, expressed as CO₂ equivalents, from building- and user-related energy use, plus other building-related sources of GHG emissions and removals.

The system boundary for the CM1 and CM2 of a building is shown in Figure 1. It consists of the equipment to operate the building fulfilling the demand as energy end use and the technical building system(s) to deliver, convert, and generate energy for the energy end use. All building-related energy end use (as indicated by the pale gray boxes in Figure 1) shall be taken into account for the carbon metric (CM1).

User-related energy use (as indicated by the dotted box in Figure 1) shall be included in the CM2, including energy for supplementary lighting installed by building users. It is NOT necessary to separately measure the amount of energy generated, converted, or consumed within the system boundary by each system, piece of equipment, or machine. Exported energy is outside the system boundary but may be reported as additional information where appropriate.

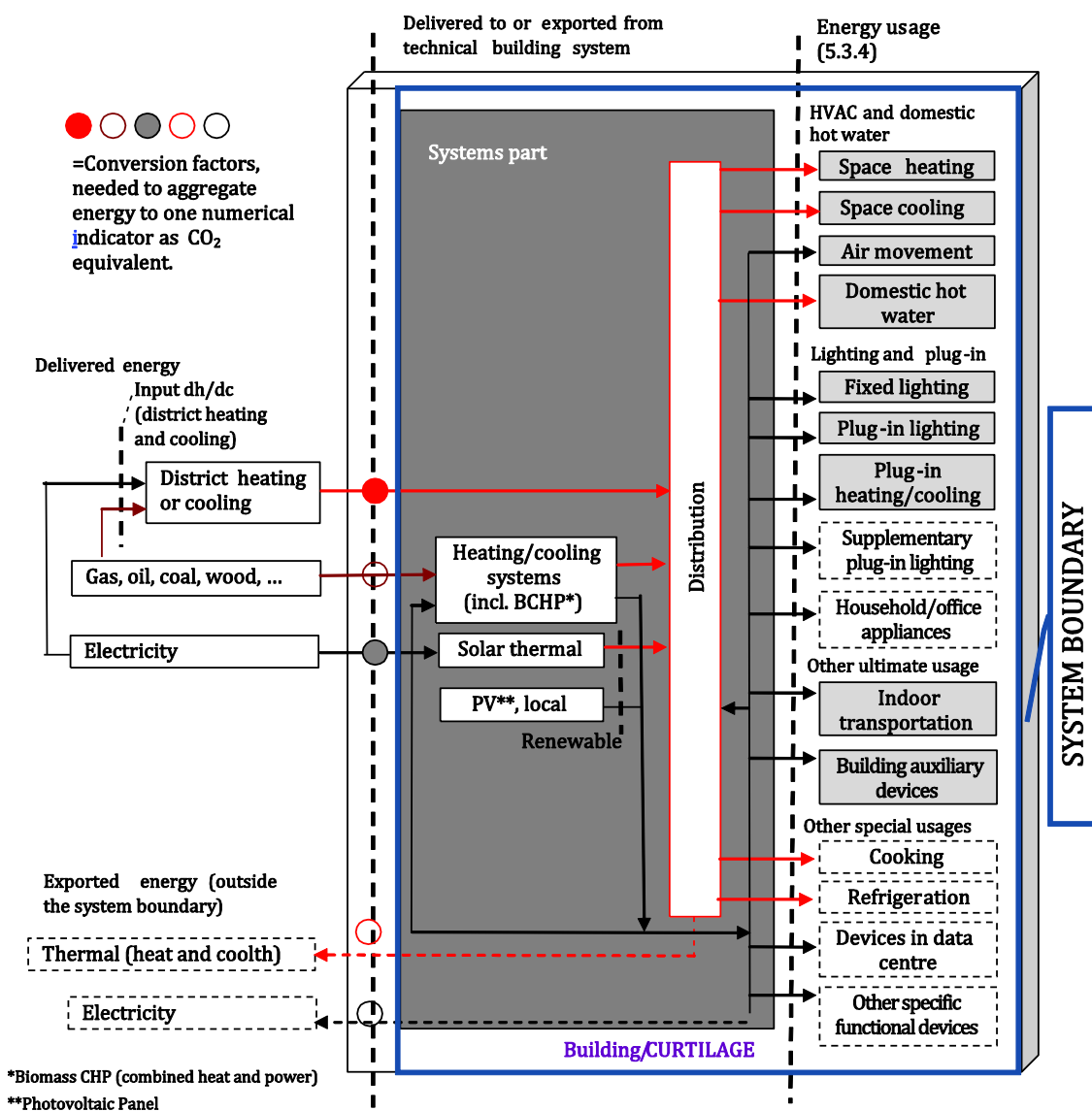

Figure 1: Boundary and energy flows - Main energy flows within and crossing the boundaries for energy use of a building (Source ISO16745)

Figure 2 show examples of the system boundary for CM1. Here only the energy carrier for the delivered energy and energy generated by the PV panels and used within the system boundary are required to be measured for CM1.

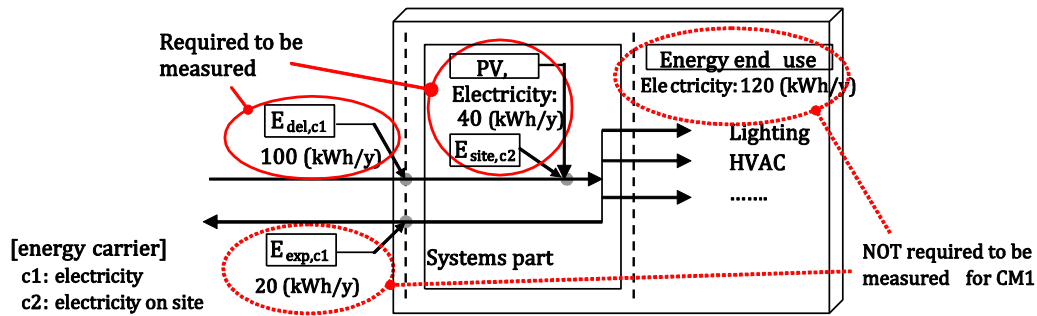

Figure 2: Examples of energy flow measuring by energy carriers

3. CALCULATION OF THE CARBON METRIC

3.1 Equation to calculate the carbon metric

ISO16745 indicates that carbon metric of a building is given by the following equation.

$$m \cdot CO_{2eqv} = \sum \{ (E_{del,ci} \times K_{del,ci}) + (E_{site,ci} \times K_{site,ci}) \}$$

Equation 1

Where $m \cdot CO_{2eqv}$ is the carbon metric of a building, i.e. the emitted mass of GHG, expressed as kg CO₂ equivalent per kg emission,

$E_{del,ci}$ is the delivered energy for energy carrier del,ci;

$E_{site,ci}$ is the energy produced onsite for the energy carrier site,ci;

$K_{del,ci}$ is the GHG emission coefficient for delivered energy carrier del,ci

$K_{site,ci}$ is the GHG emission coefficient for on-site energy carrier site,ci.

Equation 1 implies that carbon metric of a building shall be calculated from the delivered energy for each energy carrier plus the on-site energy, if any, produced without using delivered energy and used in the building and/ or for **other energy use within the building's site, multiplied by the respective** GHG emission coefficient. In view of ISO 16745 suggests that where the sum of energy produced on-site is estimated to be is less than 2 % of the total energy, $E_{site,ci}$ should be ignored.

3.2 Measurement of energy carrier

ISO16745 requires that measurement of the energy carrier shall take account of all the sources delivered to and generated within the system boundary including electricity, fuels (e.g. gas, oil, wood, and other biomass waste), and imported coolth/ steam/ heat. Data for nominal delivered energy is available from utility provider reports and contracts, electricity bills, invoices for fuel deliveries, gas bills, meter readings, pipeline measurements, energy management software.

3.3 GHG emission coefficients

ISO16745 requires that the choice of the source of the GHG emission coefficient used for calculating a carbon metric shall be appropriate for the intended use of the carbon metric. The standard demands that GHG emission coefficients shall be obtained from, in the following order of priority:

- Nationally agreed data;
- Independently provided information;
- Internationally agreed data.

4. REPORTING OF THE CARBON METRIC

The carbon metric study report is essential to assure fairness, universality, and traceability of measurement of GHG emissions from existing buildings. For that purpose, the report shall include the information on: a) building identification, b) type of the carbon metric (e.g. CM1, CM2, or CM3), c) value of the carbon metric(s), d) value(s) of the carbon intensity(ies) determined, e) purpose of the reporting, f) reporting period, g) whether the CM has been normalized to average annualized conditions such as local climate, h) date of the evaluation, i) name of the organization or individual doing evaluation, j) client of the evaluation, k) description/ illustration of the system boundary, l) list of energy end use included in the CM in relation to the type of CM, m) whether delivered energy end uses are measured or estimated, n) inventory of energy carriers, o) source of GHG emission coefficient (publication, organization, year of the coefficient measured), p) year of construction of building, q) year of latest major renovation affecting energy use, r) year of any (latest) change in use, s) total site area of the building, and t) location.

Table 1 illustrates an example of a table in carbon metric study report to present whether delivered energy end uses are measured or estimated.

	Energy consumption related service	Present in the building (a)	Included in the CM(b)	Separately metered(c)	Measured or Estimated (d)	Energy carrier(e)
1	Building-related energy use	Space heating				
2		Space cooling				
3		Air movement				
4		Domestic hot water				
5		Lighting for basic building function (fixed lighting etc.)				
6		Auxiliary energy (e.g. for heat pumps)				
7		Indoor transportation				
8		Building auxiliary devices				
<p>a Use "P" to indicate if services are present in the building. b Use "I" to indicate if the energy end use for the service is included in the carbon metric. c Use "X" to indicate if energy end use for the service is separately metered. d Use "M" or "E" to indicate if delivered energy end use is based on either measurement or estimation. e Report may indicate the energy carrier for each energy end use, if known</p>						

Table 1: List of energy end use included in the carbon metric for CM1

5. COMMUNICATION OF THE CARBON METRIC

ISO16745 provides two types of communication that may be used to make the carbon metric publicly available.

- A carbon metric declaration
- A carbon metric claim

5.1 Carbon metric declaration

A carbon metric declaration is the communication of a carbon metric that has been verified by an independent third party. Assumptions made to create the declaration shall be included in the documentation of the organization or individual determining the carbon metric, which shall be referenced in the declaration and made available upon request.

5.2 Carbon metric claim

A carbon metric claim is the communication of a carbon metric that has not been verified by an independent third party. When an organization decides to make a carbon metric claim publicly available, the communication of the evaluation of the carbon metric shall be supported by a carbon metric disclosure report. Assumptions made to create the claim shall be included in the documentation of the organization or individual determining the carbon metric, which shall be referenced in the claim and made available upon request. ISO 16745 describes the requirement to verify the calculation of carbon metric.

6. THEN HOW CM FACILITATE INNOVATION FOR REDUCTION OF GHG EMISSION FROM BUILDINGS?

ISO16745 provides globally agreed method to measure, report, and verify reductions of GHG emissions from existing buildings in a consistent and comparable way. Due to its simplicity, the method is usable not only for building profession and LCA expert but also for a wide range of stakeholders who commit in economic transactions, business activities, and governmental policy making. Thus, the metric and its protocol defined by the standard is usable both in the developed world and in developing countries as a reference and as a baseline for benchmarking.

It implies that CM defined by the standard provide the foundation for national targets to be set, a contractual agreement to be prescribed, and carbon financing to occur on a level of varieties of playing fields. Therefore CM could provide the basis to initiate and facilitate social innovation that considerably reduces GHG emission from existing buildings. The following are the possible examples of initiative for such innovation.

6.1 CDM in building sectors

In general, Clean Development Mechanism (CDM) is an effective instrument to globally rationalize investment for GHG reduction by transferring technologies from knowledgeable groups and countries to less capable or less experienced. However, so far, there are very few examples of CDM in building sectors because Certified-Emission Reductions (CER) had not been available due to a lack of globally agreed method of measurement, reporting and verification of GHG reduction from existing building. In principle, burden shifting via CDM should be assessed and verified by LCA basis. However, operational energy use in buildings typically accounts for 70 % to 80 % of energy use over the building life cycle. Therefore, CM and its protocol defined by the standard sufficiently enable to introduce CDM in buildings sectors by providing the basis of CER to the investment for the improvement of energy efficiency of buildings. Therefore CM and its protocol are expected to trigger off the innovation by creating new services and technologies associated with CDM in building including global scale cap-and-trade in buildings.

6.2 Green investment fund for building sector

By the dissemination of socially responsible investment (SRI), green investment fund has been grown globally in the last decade. The current target of the funds is large-scale green infrastructures such as renewable energy generation plant regarding which green performance is measurable, reportable and verifiable. CM and its protocol by the standard open up the possibility that groups of buildings could be the target of a green investment fund. It is notable that building sector has the highest GHG reduction per investment efficiency. It is probable that

investment on energy performance improvement of groups of buildings could have considerable better performance than investment on green infrastructures. CM could be the basis such comparative study in investment strategies. If the energy performance of buildings is included in the target list of a green investment fund, it facilitates technology innovation that reduces GHG emission from operations of buildings.

6.3 Green lease

Green leases are contracts between the landlord and the tenant to share the financial benefit of energy savings of a rented building. The practice of green lease requires measurable, reportable and verifiable energy performance which is the basis of mutual contractual obligation. Thus, CM and its protocol defined by ISO16745 could be the essential elements to make the green lease contract feasible. So far most of the precedents of the green lease in Japan aims to replace existing artificial lighting to LED, simply because energy use and GHG reduction are predictable and measurable. In case CM and its protocol are applied, replacing of HVAC and building services could be included in green lease practice because such actions would become measurable, reportable and verifiable. It implies CM and its protocol could broaden the scope of the green lease, thus facilitate social innovation including behavioral changes of stakeholders that have significant impact on GHG reduction.

6.4 Innovative intervention by governments

Any government policies (legal control, intervention to activities in market place and provision of information) for GHG reduction require a fair and comparable reference for benchmarking and baselining. CM and its protocol by ISO16745 satisfy such requirement. Thus CM and its protocol could make the contribution to the innovation that is triggered by benchmarking and baselining policy by the governments.

7. CONCLUDING COMMENTS

The paper summarizes the idea of CM and its protocol that are prescribed in ISO16745 documented by the authors. The protocol assures internationally agreed method of calculation of GHG emission from buildings in operation. CM and its protocol provide the measurable, reportable and verifiable reference for GHG emission based trading, contracts, financing and policies that could be the sources of social and technological innovation in building sectors.

CM and its protocol are, in a sense, a simplistic approach among a set of possible holistic approaches against the complex crisis of global climate we are facing. The authors wish that the appropriate and effective usage of **CM and its protocol would be identified and enhanced through “learning by using of CM and its protocol” in trading, contracts, financing and policy-making.**

REFERENCES

- [1] SBCI, UNEP. (2009) Common carbon metric for measuring energy use and reporting greenhouse gas emissions from building operations. Paris:United Nations Environment Programme, Sustainable Buildings and Climate Initiative, Available at: <http://www.unep.org/sbci/pdfs/UNEPSBCICarbonMetric.pdf>
- [2] Wiedmann, T., & Minx, J. (2008). A definition of ‘carbon footprint’. *Ecological economics research trends*, 1, 1-11.

Climate Action Planning Strategies for Achieving Carbon Neutrality and Net Zero Campus Operation

Vuk VUJOVIC^a

^a Legat Architects, United States of America, vvujovic@legat.com

ABSTRACT

Scientists, business leaders and heads of government around the world are in agreement: climate change is one of the most serious issues facing our global society today. Colleges and universities have an opportunity to exercise leadership in their communities by providing the knowledge, research, practice, and informed graduates that can create a positive and more sustainable future.

The process of Climate Action Planning, used by over 680 colleges and universities in the U.S., provides a useful template for sustainable campus operation, incorporating deep energy efficiency and reduced carbon emissions. The planning includes on-site renewable energy and retro-commissioning aimed at achieving carbon neutrality and net-zero campus operation within the conceivable future.

This paper will explore Climate Action Planning implemented on several higher education campuses in the Midwest, including two recent case studies completed between 2011 and 2015. The tools and processes for carbon footprint inventory will be discussed to inform other institutions and professionals pursuing similar goals.

The planning process starts by conducting a carbon emissions inventory, compiled using scope-based methodology: Scope 1 (equipment on campus), Scope 2 (off-site energy production) and Scope 3 (transportation). The carbon emissions data is then translated into a set of actionable goals and strategies, while the planning **process continues through a series of workshops including representatives of the institution's administration, operations, students and faculty.**

The proposed goals and strategies are envisioned as complementary tools for achieving carbon neutrality and net zero campus operation. The final plan consists of four complimentary strategy areas: Mitigation, Renewable Energy, Adaptation and Resilience, Engagement. These strategies are broken down into actionable, quantifiable and measurable goals that will be implemented through standard campus operation.

The Climate Action Planning process reduces the likelihood of unmanageable change, helps manage the risks, and takes the advantage of new opportunities created by our changing climate.

Keywords: climate change, sustainable neighbourhood, energy measurement and verification

1. INTRODUCTION

Since 1993, over 4,000 faculty and administrators at hundreds of U.S. colleges and universities collaborated with Second Nature¹ to coordinate their joint response to global warming and climate change, and make the principles of sustainability essential to every aspect of higher education. In late 2006, twelve visionary college and university **presidents initiated the American College and University Presidents' Climate Commitment (ACUPCC)², a reporting system which was later expanded into Second Nature's Climate Leadership Commitments, consisting of the Climate Commitment, the Carbon Commitment and the Resiliency Commitment.**

Today, over 680 higher education institutions in the U.S. have signed the Second Nature's Climate Leadership Commitments. The Commitments are requiring them to implement annual tracking and planned reduction of their overall CO₂ emissions and related carbon footprint. As the current number of signatories reached hundreds of institutions nationally, many participating colleges and universities are faced with a significant dilemma: if unchecked, needed campus expansion and building modernization would increase their existing building area and in turn, simultaneously increase overall energy use, long-term utilities and maintenance costs and resulting carbon emissions. This realization opened the path to tighter integration on previously not closely related areas of academic programming, building design, energy use and campus planning and operation, which often had competing or mutually conflicting goals.

1.1 Opportunities for climate action on higher education campuses

This paper will briefly review Climate Commitment requirements, the process of initiating and implementing Climate Action Plans. Additionally, two case studies will be explored to illustrate how similar issues could be addressed by integrating climate action into campus operation and sustainable master planning process. The case studies also showcase the new sustainable master plan model which incorporated the Climate Action planning into traditional master planning process.

Resulting hybrid approach evaluated and proposed climate action strategies and technologies designed to improve campus-wide energy efficiency, reduce greenhouse gas emissions and firmly integrate sustainability into campus operations and the academic curriculum.

2. CLIMATE ACTION PLANNING PROCESS

The Carbon Commitment defines climate neutrality as having no net greenhouse gas (carbon) emissions by a certain date selected by each reporting higher education institution. The process of climate action planning starts by conducting an institutional carbon emissions inventory, compiled using three-scope-based methodology based on Scope 1, Scope 2 and Scope 3. While the energy use, size and campus operation model of each institution varies, the Scope based-carbon emissions inventory allows for easier comparison and benchmarking between campuses. Scope 1 emissions are a result of equipment located and used on campus and operated by the institution. Scope 2 emissions represent carbon generated during the energy production derived from non-renewable sources, typically energy purchased from the utility grid. Scope 3 emissions are generated by transportation of students and faculty to and from the campus.

The collected carbon emissions data is translated into a set of actionable goals and strategies, while the planning **process continues through a series of workshops including representatives of the institution's administration, operations, students and faculty.**

2.1 Carbon footprint data collection

Participation in **Second Nature's Climate Commitment requires detailed greenhouse gas (carbon emissions) accounting**, which describes the ways to inventory and audit greenhouse gas emissions produced by the reporting entity. The accounting of greenhouse gas generates data used to create annual carbon emissions inventories.

Educational institutions can use carbon emissions inventories for a variety of reasons: to better understand the sources and trends in emissions on their campuses, as well as to plan how to mitigate and reduce them through proper building design and construction. Carbon emissions are calculated and reported over a 12-month period, as is standard practice, while climate action plans are devised to eliminate greenhouse emissions by a given date, selected by each participating institution.

A greenhouse gas inventory is a process of accounting for all carbon emissions resulting from a university or **community college's operation. To simplify the data collection process, institutions may choose to calculate their emissions according to their fiscal year rather than by calendar year.** All emissions data is reported in metric tons of carbon dioxide equivalent (CO₂e). The emissions data is further categorized based on scope.

3. CLIMATE ACTION STRATEGIES

The proposed goals and strategies are envisioned as complementary tools for achieving carbon neutrality and net zero campus operation. The final plan consists of four complimentary strategy areas: Mitigation, Renewable Energy, Adaptation and Resilience, Engagement.

These strategies are broken down into actionable, quantifiable and measurable goals that will be implemented through standard campus operation. Each of the proposed strategies was reviewed by several of the committees instituted to guide, advise and inform strategy formulation and the climate action planning process. Administration, Operations and Maintenance, Faculty and Students are some of the typical committees recommended as the best representation of all interested parties on a given campus.

3.1 Mitigation strategies

Mitigation strategies include various energy-efficiency measures, reduction of transportation related to student and faculty commute, improvements in operation and maintenance and overall reduction of waste generated on campus (Figure 1).



Figure 1: Mitigation strategies – Waste reduction and handling

3.2 Renewable energy strategies

Renewable energy strategies relate to on-site clean energy generation. Systems to be considered include wind-generated energy, solar, geothermal, renewable energy purchases and offsets. (Figure 2).

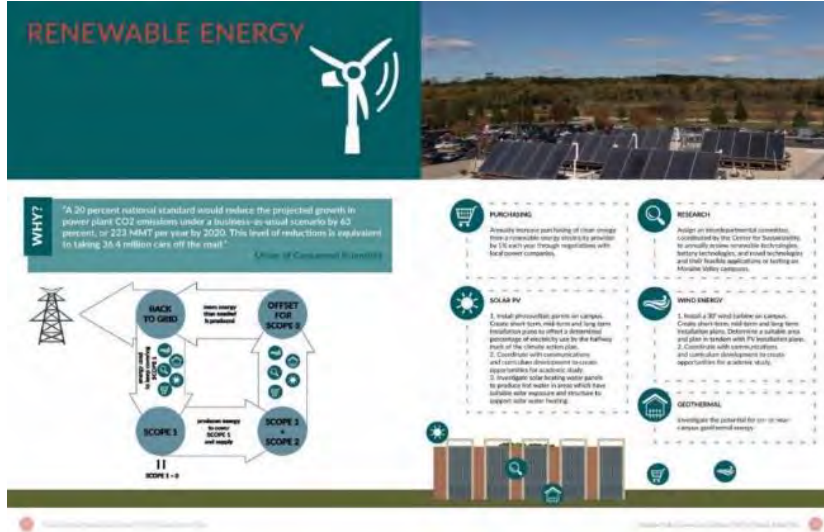

Figure 2: Renewable energy strategies – Wind, solar and geothermal

3.3 Adaptation and resiliency strategies

Resiliency strategies aim at increasing ability of the institutional systems to respond and resist impact of man-made and natural disasters. (Figure 3).



Figure 3: Adaptation and resiliency strategies

3.4 Engagement strategies

Community engagement and internal culture change are critical to communicate goals of Climate Action Plan and its strategies to students and faculty (Figure 4).



Figure 4: Community engagement strategies

4. CASE STUDIES

This section explores Climate Action Planning process implemented on two higher education campuses located in the U.S. Midwest region and completed in 2011 and 2016, respectively.

4.1 Case study 1: Joliet Junior College - 2011 Climate Action Plan

In 2009, Joliet Junior College (JJC) took a significant step in setting sustainability goals by committing to the former ACUPCC compact. This created an opportunity for the higher education institution to take the lead in reducing greenhouse gas emissions, achieving climate neutrality, applying sustainable practices and integrating sustainability into college curricula to ensure that future generations are equipped with the knowledge necessary to be environmentally responsible.

Historically, sustainable practices have been an integral part of JJC's culture. **Between 2008 and 2010, various sustainability initiatives and practices culminated in the implementation of JJC's Sustainable Master Plan, later integrated with the Climate Action Plan, completed in 2011.**

The JJC's Climate Action Plan sets goals for future action and develops a timeline for goal achievement. In order to determine the initial level of impact, an inventory of carbon emissions was conducted for fiscal years 2009-2010 and 2010-2011. Through this, strategies were developed to address the most significant sources of carbon emissions. Incorporated with these strategies are educational efforts intended to promote awareness about climate change and carbon emission throughout the College. These strategies will be open to constant updates and revisions, as greenhouse research and sustainable technology further develop.

It should be noted that JJC GHG calculations for FY 2010-2011 include projected emissions resulting from six new buildings that were going to be added by the end of 2013. In absence of historic data, design energy and GHG emissions data were used to project total GHG emissions. All new buildings on campus have been designed to achieve LEED-NC certification. Significant CO₂ footprint reduction came from JJC's vast, well-preserved natural areas. Some estimates indicate that as much as 600 metric tons of CO₂ emissions could potentially be mitigated by maintaining, improving or expanding existing natural areas.

Additionally, as a result of new building construction, the overall building area was increased by 43.95% between August 2010 and August 2011, while net GHG emissions have risen by only 30.77% during the same period. This data clearly demonstrates the benefits of energy efficient building design and construction. The data also suggest that implementation of the energy-efficient building systems can result in significant decreases in both overall campus energy use and GHG emissions per square foot of area.

JJC continues with the carbon emissions tracking and inventory data collection after initial Climate Action Plan was compiled in 2011. Their goal is to integrate sustainable campus master plan, climate action plan with the institutional sustainability plan,

4.2 Case study 2: Moraine Valley Community College - 2015 Climate Action Plan

In 2013, Moraine Valley Community College (MVCC) made a significant commitment by signing the Second Nature Carbon Commitment³. The goal of the commitment was to begin the process toward achieving campus carbon neutrality, support greater community resilience and provide structured climate change education and global citizenship opportunities for their students. MVCC further integrated their climate action with the goals of the current sustainable campus master planning process, making building energy efficiency, renewable energy integration, resiliency and adaptation integral part of their five-year campus master planning process.

The college implemented several key steps aimed at facilitating the climate action planning process: set up the institutional structure (committees, task force, office of sustainability); completed an initial inventory of greenhouse gas emissions; created and implemented the Climate Action Plan (completed during 2015-2016); defined target date and interim milestones for achieving campus carbon and climate neutrality. MVCC carbon emission inventory data was benchmarked with several other higher education institutions pursuing similar goals (Figure 5).



Figure 5: Carbon emissions inventory benchmarking between higher education institutions

5. CARBON NEUTRALITY AND NET ZERO CAMPUS OPERATION

The institutional progress toward carbon neutrality is measured through annual greenhouse inventories, climate action plan updates and implementation of selected strategies. To simplify the planning process and implementation of strategies over time, the individual strategies are identified as short-term (0-5 years), mid-term (5-15 years) and long-term (15-25 years), depending on projected time horizon.

It is recommended that climate action planning should be fully integrated with the sustainable campus master planning process, which typically following the five-year planning and implementation cycle. In order to achieve carbon neutrality and achieve eventual net-zero campus operation, the Climate Action Plan envisions gradual replacement of grid-based fossil fuel electrical energy supply with on-site generated renewable energy. The remainder of carbon emissions that, cannot be displaced by clean (renewable) energy sources will be mitigated by carbon offsets (Figure 6).

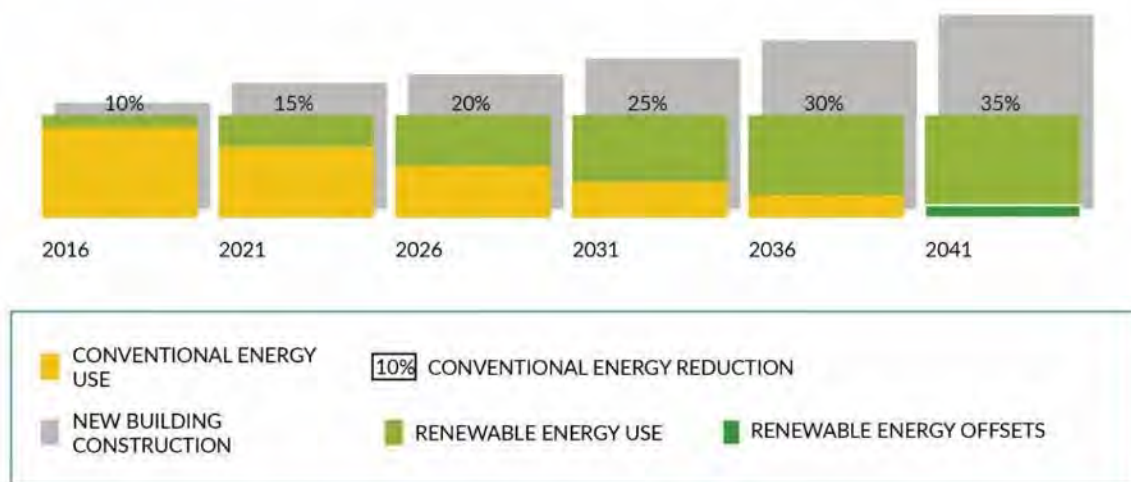

Figure 6: Climate Action Plan implementation process – Gradual energy source replacement

6. CONCLUSION

Achieving carbon-neutral or net-zero operation in a college campus education environment requires appropriate funding, continuous implementation of identified carbon emission mitigation strategies, planning flexibility to address future technological developments, and time to create meaningful culture change, implement necessary building upgrades, install renewable energy systems, and plan for and secure the necessary funding.

The short-term strategies on individual projects are easier to identify and implement, mid-term and long-term strategies that involve entire campuses or communities will be need to remain flexible and allow sufficient room for adaptation for future changes in the political, social, economic and natural environment. The critical element for securing success will be proper integration of carbon action plan goals and strategies into all subsequent sustainable campus planning, operations, and maintenance activities on college campuses. While some of the GHG emission will be difficult to completely eliminate, such as those related to commuting or air travel, sufficient funding should be allocated for carbon offsets, parallel to budgets developed for the implementation of the entire Carbon Action Plan.

REFERENCES

- [1] ACUPCC. (2014) Available from: www.presidentsclimatecommitment.org [Accessed 2nd June, 2014]
- [2] Moraine Valley Community College. (2016) 2016 Climate Action Plan. Available from: www.mvcc.edu [Accessed 23rd April, 2016]
- [3] Second Nature. (2016) Available from: <http://secondnature.org> [Accessed 21st June, 2016]

Session 3.6: Innovations Driving for Greener Policies and Standards – Practices Review

Leap Forward or Snail Speed? Examining Radical Sustainable Innovation

Christian KOCH^a

^a Chalmers University of Technology, Sweden, kochch@chalmers.se

ABSTRACT

Sustainable building appear to progress rapidly these years. The new technological possibilities could be interpreted as radical, but the objective of this paper is to critically examine, whether some parts of sustainable building technology can be understood as radical or whether we rather witness a continued slow and emergent development. The framework of understanding includes concepts of radical innovation, inventions and sustainability. Radical sustainable innovation (RSI) should break away from the customary and be characterized by high degrees of newness in the entire life cycle. RSI should offer significant enhancements of known benefits, entirely new benefits, or substantial cost reductions, leading to the transformation of existing markets, the creation of entirely new possibilities for sustainable balanced growth and RSI should contribute to a sustainable globe. Serious limitations are addressed. For example buildings are large complex products realised through complex processes and with a considerable lifecycle. It appears impossible that an entire building should/could be radically new. the certification standards represent a possible low denominator for measuring radicality, as criteria for newness related to inventions are found not to be instrumental. Methodologically a selection of international cases **of office buildings with very high scores of BREEAM, LEED and DGNB are examined. “Protected economy” cases** are sorted away in line with the developed criteria for radical innovation. The result shows that a portfolio of office buildings have reached substantially higher level of sustainability than contemporary building regulations (such as those in EU). There is indeed a gap between a few, substantially more sustainable buildings and the majority of buildings, indicating some radicality, yet not identified as radical innovation here.

Keywords: radical innovation, sustainability, office buildings

1. INTRODUCTION

The current global development of, not only new products, components and renewable technologies for sustainable buildings, but also methods, approaches and tools to support design, production and operation of sustainable buildings are quite breathtaking for anyone trying to establish an overview and take sensible choices. The opportunities are accelerating and are multifaceted. Yet clients and their suppliers largely continue to do business as usual, building and renovating mostly to comply with merely legal requirements. The unrealized potential creates a possibility to take a quantum leap in of sustainability by transcending existing norms beyond legal requirements such as Building Research Establishment Environmental Assessment Method (BREEAM 2016), Leadership in Energy and Environmental Design (LEED 2016), Cradle to Cradle, Deutsche Gesellschaft für Nachhaltiges Bauen, (DGNB 2016) and other present day certifications. And to do this on a business basis. There is in other word room for something else than the usual stepwise incremental innovation often seen in buildings. This opportunity coincide **with an increasing renewed interest in radical innovation in other industries (Hartman 2005, O’Connor et al. 2008).** Radical innovation scholars have developed quite extensive and explicit models for managing such innovations within large companies. These scholars would define radical Innovation as innovation that break away from the customary and are characterized by high degrees of newness (Christensen 1997 Hartmann 2015, Leifer et al 2000). Radical innovations offer significant enhancements of known or entirely new benefits, or substantial cost reductions, leading to the transformation of existing markets or the creation of entirely new possibilities for growth. It is worth noting that radical innovation, as innovation in more general, is firmly embedded in a market and business economy thinking.

On this background this paper ask whether some parts of sustainable building technology can be understood as radical? It conceptualize what radical sustainable innovation is and develop an explorative method for measuring it. And as counterquestion it problematized whether we rather witness a continued slow and emergent development.

Also the bodies developing and operating certifications has sensed the development and has speeded up their continual renewal of the measures of sustainable performance. Here we focus on Building Research Establishment Environmental Assessment Method (BREEAM, BREEAM 2016). BREEAM is a sustainability assessment method for masterplanning projects, infrastructure and buildings. It addresses a number of lifecycle stages such as “new construction”, “refurbishment” and “in-use” (BREEAM 2016). Globally there are more than 550,000 BREEAM certified buildings, and more than 2,250,000 buildings registered for assessment since 1990 (BREEAM 2016). Why selecting office buildings? When interested in innovation and radical innovation the focus is not on what is technically possible per se, as in buildings realized on university campuses or other experimental contexts to test future techniques. Rather innovation is embedded also in markets and economical feasibility. Our original position was that office buildings are tested by the market, paid by private companies. Moreover many radical ideas in buildings have over the years been realized by fiery souls using their private houses as testbed. Through loads of entrepreneurial effort by the designer, owner and constructor in one realize radically new villa concepts. However such projects often never got beyond that. What surface when looking at office buildings is the marketing and publicity effect of certain enterprises operating in and from a sustainable building. The category include utility company, building component manufacturer, building service suppliers etc. One might cynically observe, that they merely want to show off. We have chosen to include those here as after all even these companies operate in our present markets.

The paper is structured in a traditional manner. It commence by developing the theoretical understanding and continue to posit the methods that can answer to the objectives of the research. The follows case descriptions of our found candidates for radical innovations. The paper analyse these and finalise the argument through a discussion and a conclusion.

2. FRAMEWORK OF UNDERSTANDING

The framework commence by the concept of innovation, moving on to radical innovation. Sustainability is then introduced and inserted into our tentative definition of radical sustainable innovation. The Oslo Manual (OECD 2005) defines innovation as follows: “An innovation is the implementation of a new or significantly improved product (good or service), or process, a new marketing method, or a new organizational method in business practices, workplace organization or external relations”. This definition distinguishes in a linear manner between invention and innovation, believing that invention are globally new and not necessarily implemented in a practice, whereas innovation is only counted as such if the change is implemented. This implies that radical innovation at a time needs to be almost as new as inventions yet is required to have experienced implementation. Also innovation is normally measured up against its context, i.e. innovation is new in relation to a specific contextual and not necessarily globally new. We suggest to depart from this contextual criteria for innovation below. Radical Innovations break away from the customary and are characterized by high degrees of newness. Radical innovations offer significant enhancements of known benefits, entirely new benefits, or substantial cost reductions, leading to the transformation of existing markets or the creation of entirely new possibilities for growth. These innovations are also referred to as “breakthrough”, “discontinuous”, or “paradigm-shifting” (Christensen 1997 Hartmann 2015, Leifer et al 2000). It is important to note that disruptive innovation is different from radical. Disruptiveness may occur from wellknown elements of innovation reshuffled. Disruptive innovation can be defines as “a process were a smaller company with fewer resources is able to successfully challenge established incumbent businesses” (Christensen et al 2015). Disruptive innovation originate in the low-end of new-market footholds and only compete with mainstream when quality catch up to their standard (Christensen et al 2015). We adopt the position that innovations within sustainability should comply with certain special rules. Where innovation concepts are embedded in market economy concepts, sustainable innovation needs to depart from this unambiguous embeddedness and rather refer to a sustainable economy. Sustainability was originally defined as “development that meet the needs of the present without compromising the ability of the future generations to meet their own needs” (Brundtland 1987). The notion of sustainability has undergone signification development even if still ambiguous. As many other societal goals it is a moving target, and should be. This goes for the content and weight of the original Brundtland dimension of environmental, social and economic sustainability (Chathara et al 2015). On this background a tentative definition of radical sustainable innovation:

- RSI Break away from the customary and are characterized by high degrees of newness. In the entire life cycle and in all elements, financial, process, product, client relations, organisation management

- RSI offer significant enhancements of known benefits, entirely new benefits, or substantial cost reductions, leading to the transformation of existing markets or domains or the creation of entirely new possibilities for growth and sustainable balances encompassing at least an environmental, social and economic aspect
- RSI contributes to a sustainable globe

We suggest that within radical sustainable innovation in office buildings a global convergence has meant that it makes sense to move from a contextual definition to a worldwide covering definition, which resembles the demands of patented inventions, whose novelty is tested in a broader region like Europe or US. In fact we suggest that radical sustainable innovation should be measured by a global novelty criteria.

3. METHOD

We draw on innovation and radical innovation literature to conceptualise these parts and combine these with sustainability. This approach is chosen because of a paucity of contributions conceptualizing radical sustainable innovation. In an initial phase radical examples were sought for outside the certified portfolio. This approach however quickly was abandoned because we did not have resources to follow up on promising, yet poorly documented cases. Compared to these potential radical cases, the certified were far better documents. On this basis we then use sustainable building certification schemes. The literature comparing certification schemes within sustainable building, show large similarities between tools (Chathana et al 2016). The emphasis are on environmental sustainability (roughly 70% of the criteria points), and less on social sustainability (roughly 25 % of the criteria points), and very little emphasis is assigned to economic sustainability (Chathana et al 2016). Several consecutive searches have been made in BREEAM, LEED, DGNB and Cradle to Cradle certification databases from 2012-2016. Case studies of remarkably sustainable building has been collected over this time period. Cradle to Cradle certification is however only covering building components as is therefore a supplement. LEED platinum buildings were examined on an exemplary basis. According to LEED there are 852 certified platinum buildings (LEED 2016), however based on the exemplary evaluation they appeared less performative than the BREEAM **“outstanding” certification which was therefore selected.**

BREEAM is an entire suite of certifications **targeted different phases of a building's life and different sectors of buildings** (domestic, offices, public institutions etc, BREEAM 2016). There are certifications for four different phase/stages: Master planning, new construction (incl. design), refurbishment, in-use. They include up to ten aspects related to energy and water use, the internal environment (health and well-being), pollution, transport (access to public transport and bicycle facilities), materials, waste, ecology (including biodiversity), management processes and innovation. In total there are typically 80 evaluation points. The criteria dimension are typically the following: Management, health and wellbeing, energy, transport, water, material and waste, landuse and ecology, pollution and innovation. The scores at these evaluation points are summed up in a score card, with a score from **1 to 100%. The scores are translated into stepwise categories: “Passed”, “Good”, “Very Good”, “Excellent”, “Outstanding”.** Outstanding means scoring more than 85 points out of 100 and around 1% of all ratings do that (BREEAM 2016). For example in the BREEAM 2014, the energy dimension Excellent is 37-52,5% reduction of energy consumption compared to national building regulation and Outstanding is 60-82,5% reduction (BREEAM 2014b). Although BREEAM is increasingly international, it is 96.4% of its certifications of non domestic buildings (including offices), that are placed in the United Kingdom. The figure for 2012 was 92.5% showing the gradual grow in internationalization (BREEAM 2014). Using our latest searches in the greenbook data base we were in **april 2016 able to identify 256 cases of BREEAM certified buildings in class “outstanding”. This figure had grown to 281 in october 2016.** Out of these 76 were categorized as office building, but our search also covered mix-use buildings. The certification were according to BREAAM 2009 or 2011. None referred to BREEAM 2014 which is presently a draft (BREEAM 2014). In the further selection the more recent and highest scores (meaning more than **90%) were selected, and thus deselecting even relative high scores. Also some examples of “protected economy”** cases, such as experimental buildings on university campuses were sorted away in line with the developed criteria for radical innovation. We ended up with a sample of five building which are described below.

There are several limitations to our approach. Our analysis here rely on preliminary comparisons between the certifications and exploratory searches. As for patented sustainable products and processes, although preliminary searches were made into patented sustainable building components, it has not been established whether the patented products constitute a more radical innovation than cradle to cradle certified products. Our preliminary

position is that the patent approval process do not evaluate the products as systematics as a cradle to cradle certification would. It is merely newness that are the central criteria.

4. CASES

Below the five cases found with the highest score is presented.

The Air Street building is placed in central London UK and part of a larger project carried out by Crown Estate. The building was certified after BREEAM 2011 New Construction, Office and scored 94,16 % after finalizing in autumn 2015. An earlier interim certification was rated slightly lower. The project is a combination of preservation of an existing listed building, and demolishing and new built of the two upper floors aiming at delivering office facilities. The stronger part of the evaluation were energy, waste, materials and management. The weaker health, transport, water and innovation. On energy for example the building scored 25 credits out of 27 due to the low carbon energy strategy adopted, provision of monitoring facilities, use of district heating, LED lightning and solar panels. Also the wall insulation used reduces heat loss by 65%.

The Bentley Works, Doncaster UK building was rated outstanding with a score of 92,5 % in BREEAM interim in 2015. The owner, SKANSKA UK, a contractor, **also used the company's internal "Color Palette" certification tool.** The Colour Palette tools is organized in economic, green and social dimensions. Skanska describe the economic scores like this; a total green payback period of 11 years and creation of 70 new full-time positions. The green scores points are the following: Net zero primary energy site, office building uses 67% less energy than UK building regulations, 11% reduction in embodied carbon, zero construction waste materials to landfill, zero hazardous materials, net zero potable water & 70% less water than BREEAM benchmark. In the social dimension SKANSKA highlights a healthy indoor and outdoor environments for building occupants and workers. In other words it derives that the building substantially surpass BREEAM outstanding criteria in one dimension, water use, yet operate a very limited social sustainability perspective.

Le Hive, Ile de France, Paris, is Schneider Electric's headquarters in France. Schneider is a large global electricity installations supplier. The building scored 93,8% in the BREEAM In-Use certification in 2013. The building complex is at 35.000 m2 and energy consumption level at 78 kwh/m2 per year was achieved from the double level of 150 kwh/m2 per year. **The BREEAM In-Use rating included Asset performance 'Excellent', 75%; Building management performance 'Outstanding', 88%; Occupier management performance 'Outstanding,' 92%. The energy use for Heating Ventilation and Air Conditioning (HVAC) and lighting have been halved over three years through active energy efficiency, without changing the structure of the building and without energy production, according to Schneider.** Other dimensions of sustainability include recycling and sorting of 12 kinds of waste (0% to landfill), efficient management of water – rain sensors, real time leak detection, health and well-being services on site, consultation with occupiers, acoustic comfort improvement, innovative comfort measurement. Greenhouse gas emissions study, use of 100% eco-labelled products for cleaning. Closely managed energy consumption and centralised control and monitoring using innovative tools. Conservation of green outdoor areas, improvement of bio-diversity, establishment of beehives on site. Thus the Hive stays within the BREEAM outstanding category.

The Angel Square building in Manchester, is the headquarters of the Co-operative Group. The building provides office facilities for 3,000 employees. The Co-operative Group is owned by 8 million members. The building scored 95,16%, outstanding, in the BREEAM (2008) offices certification in 2013. Some of the dimension highlighted were: The building is powered by a pure plant oil fed Combined Heat and Power (CHP) system and utilizes rapeseed oil which is grown on the Co-operative's own farm land. Surplis energy is sent back to the grid. Other features include LED lighting and a system to recycle waste and rain water. Apart from its unusual architectural qualities, **the building's sustainable solution do appear to go beyond BREEAM** certification at the CHP system and the recycling of water.

The 50 person large new office building for the Dutch company Geelen Counterflow, that manufacture industrial coolers and driers, obtained two BREEAM certifications at the level Outstanding in autumn 2015. **"Design" at 94.19% and "Post construction" at 99.94% (Greenbook 2016). The building's structure is prefabricated walls and floors of 100% unglued and non-chemically treated wood, grown in sustainably managed forests in Germany.** Where possible "Cradle To Cradle" certified building materials will be applied. The garden includes a variety of local plants, flowers and nesting sites for birds, bugs, bats and amphibians. By building according to the "Passive

House" guidelines and powered with 330 solar panels on the roof, the office will produce 50% more renewable energy than the total energy consumption for heating/cooling, ventilation, lighting and accessories. The extra energy will power machinery in the company's factory. Adjustable daylight infiltration, air quality, and indoor lighting, imply that the office contribute to a healthy work environment and employee productivity according to the owner **Geelen Counterflow. Some materials used: The basement made by "ecocrete" concrete and also (partly) prefabricated via a hollow-wall system made of 100% recycled granules. Building structure (beams, pillars) supplied by NurHolz. Facade Accoya wooden battens (cradle to cradle certified). Window frames Accoya. Glass AGC (cradle to cradle goal and transport minimizing). Paint Drywood woodstain semi-transparent water based lack. Roof Derbipure vegetal (cradle to cradle certified). Insulation Roof Kingspan Unidek EPS. Insulation cellar DOW XPS (cradle to cradle certified). More sustainable than mentioned here is included. Through producing more 50% energy that it consumes and adopting the policy of adopting "as many as possible" cradle to cradle certified building material, the building clearly transcend the BREEAM outstanding certification, apart from scoring almost 100%. Nevertheless some elements in the building appear to be of more traditional kind, such as the electricity cabling and the cloak system. There is no mention of any social sustainability dimensions apart from what is incorporated in the BREEAM certification.**

5. DISCUSSION

The intention is scrutinize the concept of RSI through these cases of outstanding performance. It is therefore important to discuss where the cases surpasses the scale of BREEAM or not. As we have suggested that RSI should surpass the certification standards of sustainable buildings. In general the cases scored high, yet they did not surpass the scale. There are few exceptions: Bentley works surpassed the BREEAM outstanding certification in one dimension, water use. The Angel square building features a CHP system feed by rapeseed oil and recycling of water. The Geelen Counter flow case has a number of cradle to cradle certified building components inbuilt, yet still misses others. The cases mention little about social sustainability. The actual measures in the outstanding **cases rarely relate to "outside" building stakeholders and focus one's own employees. In this dimension we thus find no elements addressing a broader understanding of what social sustainability is defined as (Colantino and Dixon 2010). It does appear that the certified companies go "hunting points" inside the certification rather than pursuing a comprehensive sustainability agenda (Chathera et al 2016).** As mentioned we found 852 LEED certified platinum buildings (LEED 2016) and 281 BREEAM outstanding in 2016. Out of the BREEAM 76 were categorized as office building, but our search also covered mix-use buildings. These numbers does raise an issue whether sustainable buildings that perform just above these many certified building can be understood as radical sustainable innovations? As our concepts requires a substantially improved product or process, the distance to this portfolio of very well performing sustainable building does appear marginal and thereby in contradiction to being radically different. Yet the distance to the majority of building regulation compliant buildings at snail speed are still substantial. The outstanding certified building is thereby a rare exception.

6. CONCLUSION

This paper set out to critically examine, whether some parts of sustainable building technology can be understood as radical or whether we rather witness a continued slow and emergent development. We conceptualise radical sustainable innovation, RSI, as innovation that break away from the customary and characterize RSI by high degrees of newness. In the entire life cycle and in all elements, financial, process, product, client relations, organisation and management. We posited that RSI offer significant enhancements of known benefits, entirely new benefits, or substantial cost reductions, leading to the transformation of existing markets or domains or the creation of entirely new possibilities for growth and sustainable balances encompassing at least an environmental, social and economic aspect and that RSI contributes to a sustainable globe. Methodologically a selection of international cases of office buildings with very high scores of BREEAM, LEED and DGNB were examined. Even if certified **"outstanding", "platinum", some buildings with lower performance (including some slightly older), and "protected economy" cases were sorted away in line with the developed criteria for radical innovation. The result shows that a portfolio of office buildings have reached substantially higher level of sustainability than contemporary building regulations. There is indeed a gap between a few, substantially more sustainable buildings and the majority of buildings, indicating some radicality, yet it is not identified as radical innovation. Buildings are complex products and the certification schemes are useful as measurement of this complexity and the certifications given also demonstrate that the buildings studied do arrive at some radical elements, yet still possess a number of more**

traditional elements. Future research will include a more systematic comparison of certification systems and highest rated buildings.

REFERENCES

- [1] BREEAM 2014a. The Digest of BREEAM Assessment Statistics. Volume 01. BREEAM
- [2] BREEAM 2014b. BREEAM UK New Construction 2014 Technical Manual. BREEAM.
- [3] BREEAM 2016. Building Research Establishment Environmental Assessment Method. Referenced from www.breeam.com.
- [4] Bruntland G. H. 1987. Report of the World Commission on Environment and Development: Our common future. Oxford University Press, Oxford, U.K.
- [5] Chethana I. M., Illankoon, I., Tam, V., and Le, K. 2016. Environmental, Economic, and Social Parameters in International Green Building Rating Tools. Journal of Professional Issues in Engineering Education and Practice. ASCE.
- [6] Christensen, C.M., 1997. **The innovator's dilemma: When new technologies cause great firms to fail**, Harvard Business Press. Harvard.
- [7] Christensen C., Raynor M. and McDonald R. (2015) What is Disruptive Innovation. Harvard Business Review 2015-12.
- [8] Colantonio A. and Dixon T. (2011). Urban regeneration & social sustainability: best practice from European cities. Wiley-Blackwell. Chichester.
- [9] DGNB (2013) Deutsche Gesellschaft für Nachhaltiges Bauen, accessed at www.dgnb.de/ 28 January 2013. (DGNB, German Sustainable Building Council)
- [10] Hartmann P. (2015): New Business Creation Systems for Institutionalized Radical Innovation Management. Springer Gabler. Wiesbaden.
- [11] Leifer R., Mcdermott C.M., O'Connor G.O., Peters L.S., Price M. Robert W. Veryzer R.W. 2000. Radical Innovation: How Mature Companies Can Outsmart Upstarts. Harvard Business Review. Boston.
- [12] LEED (2016): Leadership in Environmental Energy Design. downloads from www.leed.com.
- [13] O'Connor G. C., Leifer R., Paulson A.S. and Peters L. S. 2008. Grabbing Lightning: Building a Capability for Breakthrough Innovation. Jossey-Bass. San Fransisco.
- [14] OECD, 2005. Oslo Manual, guidelines for collecting and interpreting innovation data. OECD Publishing, Paris.

The Progress of Energy Renovations of Housing in the Netherlands

Henk VISSCHER^a

^a Delft University of Technology-Faculty of Architecture and the Built Environment, The Netherlands, h.j.visscher@tudelft.nl

ABSTRACT

The European Union formulated high ambitions of energy reductions to be realised in the built environment. The existing housing stock covers a major share of energy use and is seen as high potential to contribute to the savings. This should be realised in the first place by reducing the energy demand for heating by renovation of the existing stock and bring the dwellings to a higher energy performance standard. The targets, policies and programmes are already applied for several years now and the question arises of what progress can be seen in renovation activities and energy saving results. This paper is based on data on improvement rates of the Dutch non-profit housing sector and insight in the relation with actual energy reduction. It shows that the renovation progress is limited and that the actual energy reduction is less than is expected according to theoretical models. Furthermore, the paper presents some promising innovative approaches to realise nearly zero energy renovated residential buildings, the so called Net-Zero-Energy-Renovation programme (Stroomversnelling). Will it be possible to reach the energy saving goals with the current approach?

Keywords: energy efficiency, housing stock, renovation, energy labels, actual energy use

1. INTRODUCTION

Climate change mitigation is maybe the most important driver for the ambitions to reduce the use of fossil fuels. There are also other reasons for implementing energy efficiency policies in the EU and its Member States. These include the wish to decrease the dependency on fuel imports, the increasing costs and the fact that fuel resources are limited. The European building sector is responsible for about 40% of the total primary energy consumption. To reduce this share, the European Commission (EC) has introduced the Energy Performance of Buildings Directive, the EPBD (2010/31/EC) and the Energy Efficiency Directive (EED – 2012/27/EU). These frameworks require Member States to develop energy performance regulations for new buildings, a system of energy performance certificates for all existing buildings and policy programmes that support actions to reach the goals like **building only 'Nearly Zero Energy Buildings (NZEB)' by 2020 and realizing an almost carbon neutral building stock by 2050**. Formulating ambitions and sharpening regulations are relatively easy to do. These goals and programmes were already formulated back in 2008 for the Netherlands. Since then the renovation of the stock started and data was collected to monitor the progress as well as data about the (theoretical) energy performance of houses and actual energy use figures.

This paper presents some insights in the implementation of energy renovations in the Netherlands and the effects on actual reduction of CO₂. Section 2 presents the data on progress of energy renovations in the Dutch social housing stock. In section 3 the relation between modelled energy use according to the labels for existing housing and the actual energy use are described. Section 4 describes an innovative programme for Net Zero Renovations of housing in the Netherlands and the pros and cons of this approach. This all leads to some conclusions about the challenges and required innovations for the housing stock to meet the formulated energy reduction ambitions in section 5.

2. THE PROGRESS OF ENERGY RENOVATIONS IN THE SOCIAL HOUSING STOCK

The largest energy saving potential is in the existing building stock. New dwellings add about one per cent per year to the housing stock in Europe. The most important policy tool required by the EPBD in the European Member States is the issuing of Energy Performance Certificates (or EPCs). These EPCs give a hypothecated indication of the required energy to provide a certain average temperature in the building and depend on physical characteristics of the building. The certificate has no mandatory implications in the sense that owners could be forced to improve their buildings to certain levels. Nonetheless it is a crucial instrument for benchmarking and formulating policy goals. Building owners in all EU Member States have to obtain an EPC for a building at the moment it is sold or rented out. This is not yet current practice everywhere, mostly due to lack of enforcement. This especially applies to the private housing stock.

The social housing sector in the Netherlands agreed with the government and the national tenants' union to a covenant about energy renovation goals. This was initiated in 2008 and updated in 2012. Most important goal is to initiate renovations that lead to average energy label B in 2020 for the whole sector, which comprises 2.3 million dwellings (35% of the total stock). Energy labels are the Dutch Energy Performance Certificates that express the energy performance of existing houses as required by the European EPBD.

The whole social housing stock is already labelled for many years. Since 2010 most of the stock has a label. Every year Aedes, the national umbrella organisation of the housing associations, wants to collect the energy label data of all housing associations. Every year more associates really do so. In 2015 the data of more than 60 % of the whole social housing stock was collected in this way. This database is called SHAERE. Research with the SHAERE data base enables to show the progress in renovation. Figure 1 demonstrates the label steps over the years 2010 to 2014. It can be noted that most of the renovations lead to small improvements. If the current figures are extrapolated to 2020, we can see that the goals of an average label B will not be reached (see Figure 2). The label indexes relate the calculation of the Energy Index, which is for label B 1,25.

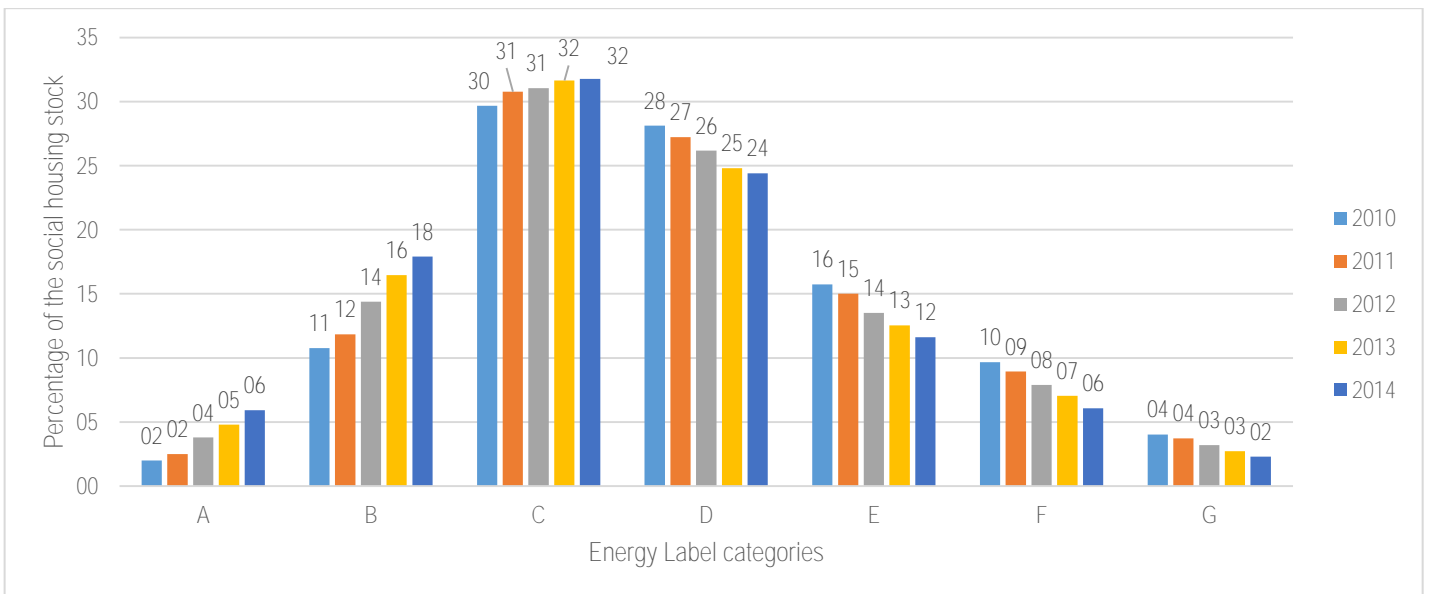

Figure 1: Distribution of the energy labels of the non-profit rented housing sector in SHAERE database (Filippidou, F, et al., 2014)

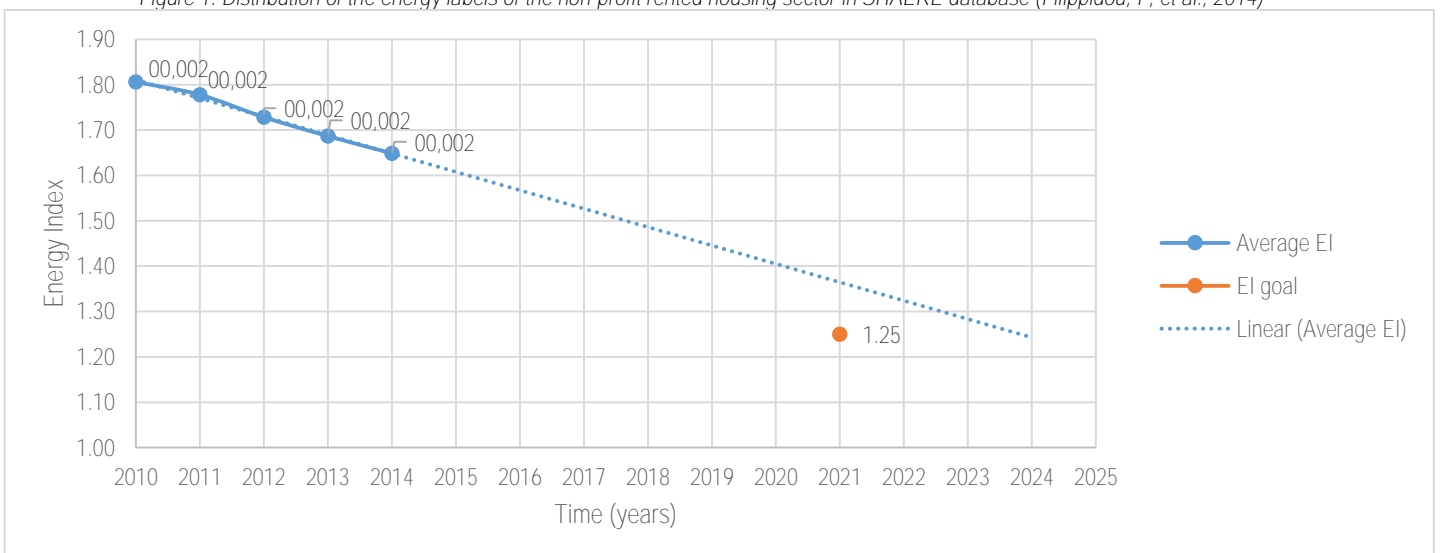

Figure 2: Development of the EI in the Dutch non-profit housing sector since 2010, (Filippidou, F, et al., 2015)

3. THE ENERGY PERFORMANCE CERTIFICATES FOR EXISTING DWELLINGS AND THE RELATION WITH ACTUAL ENERGY USE

The actual domestic energy use is besides the physical characteristics of a dwelling, largely influenced by the use and behaviour of the tenants. Some preliminary figures demonstrate the difficulty in 'forcing' reduced energy use by improvements of dwellings. The dwellings with the worst EPC (G) in practise use far less energy as expected, while the most advanced dwellings (A) use much more. This is probably due to a combination of the rebound effect and an increase in comfort level of the dwellings (Majcen et al 2013a, 2013b, 2015) and underperformance of the buildings and installations. The large difference between theory and practice is called the performance gap and is recognised in more and more international studies.

In a research project by Majcen (2013a, 2013b) the actual energy consumption was compared with the theoretical use according to the EPC's (see Figure 3).

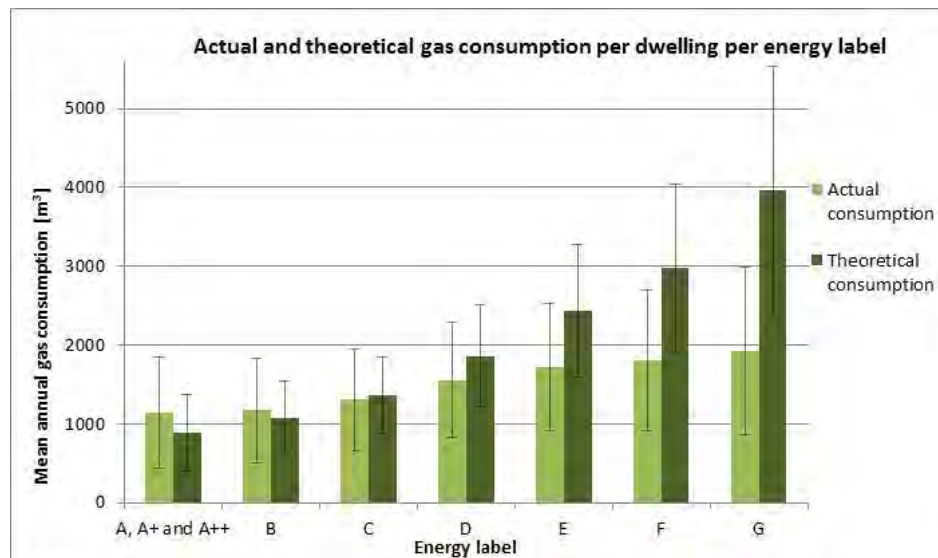

Figure 3: Actual and theoretical gas consumption in Dutch dwellings - per m2 dwelling area
Source: Majcen et al., 2013a

This research was based on the Dutch energy labels issued in 2010 - a total of over 340,000 cases with 43 variables (regarding building location and technical characteristics, the properties of the label itself etc.). This data set was derived from the publicly available database of the EPCs. This data was, on the basis of the addresses of the households, linked to actual energy use data. The energy data was provided by the CBS (Statistics Netherlands), which collected this data from the energy companies. The combined data file was then cleaned by deleting incomplete or obvious incorrect EPCs. This resulted in 193,856 usable cases. This still large sample proved to be representative for all housing types and energy label classes.

To understand how the energy label relates to the discrepancies, the gas and electricity consumption in various label categories were examined and analysed. The actual and theoretical gas use per dwelling was compared and then analysed per m2 of dwelling (Figure 5). Little difference exists between the actual and theoretical energy use calculated per dwellings and per m², except the difference in actual gas use between label A and label B. At the level of individual dwellings, the actual consumption was identical, but at the level of m² the dwellings in category A use less gas than dwellings in category B. This may relate directly to the fact that dwellings in label category A were found to be considerably larger than all other dwellings. From these figures it is clear that although better labels lead to higher actual gas consumption, there is a clear difference between the mean theoretical and mean actual gas consumption for each label. For the most energy-efficient categories (A, A+ and A++) and for category B, Figure 5 shows that the theoretical calculation underestimated the actual annual gas consumption. This is in contrast to the rest of the categories for which the theoretical calculation largely overestimated the actual annual gas consumption. This research indicates that the energy label has some predictive power for the actual gas consumption. However, according to the labels, dwellings in a better label category should use on average significantly less gas than dwellings with poorer labels, which is not the case.

4. NET ZERO ENERGY RENOVATION PROGRAMME

Stimulated by government policies in 2013 an agreement was made by a group of 27 housing associations and buildings and the Dutch government to work on a programme for 111,000 houses to Net Zero Energy (E=0) levels (Munckhof et al, 2015). This was called Energiesprong (Energy leap). E=0 means, annually a house does not consume more energy for heating, hot water, lights and appliances than it produces. The concept is based on refurbishments financed by the energy cost savings; a refurbishment executed within 10 days and a 40-year energy performance warranty from the builder. The approach is further based on organizing a massive demand for a Net Zero Energy (E=0) refurbishments, making financiers and governments tune their financing offerings and regulations towards this product and challenging the construction sector to start an ambitious innovation process. Since the take off of the programme several projects have started and some houses are yet already taken into use and even some monitoring results are yet available (Energiesprong 2016). Recently Energiesprong is working also in the UK and France to get an independent market development team set up to drive a similar approach as in the Netherlands.

The costs for Net Zero Energy refurbishment are substantially more than the net present value of today's energy bill. Therefore, an intensive innovation process in the construction sector is needed focused on reduction of costs and process time and energy performance guarantees. This will require moving from doing one-off projects towards developing mass-produced refurbishment packages with a performance standard. And then the idea is that these packages will be sold in shops, which are cosy and have helpful staff. To catalyse that innovation process, a large demand volume this new product is needed.

The financing of the refurbishment is done by giving the tenants an "energy plan" including a guarantee for a hot house (220), warm water (certain amount of shower time per day) and an electricity bundle for electric appliances for which they together pay a fixed monthly fee. If they exceed that agreed amount of energy performance, they pay the additional electricity consumption to the utility. The bundle fee is paid to the housing association (HLM). This pays of the investment. In the private sector it works similarly, with an increase in mortgage installments to finance the investment covered by the reduction in energy costs. In the Dutch case, the cost of living stays therefore the same for tenants or private homeowners. Investing in factories are required to pre-fabricate these refurbishment solutions with a view to scale. It helped the government to change regulation (i.e. ability for associations to collect the energy plan money) and it made the financier revalue the properties that would be refurbished in order to free extra room to borrow money. The first 200 prototypes and test houses have been built. By the end of 2016, there should be 10000 Net Zero Energy refurbishments completed. Following that deal, Energiesprong is now working to bring these refurbishment packages to the private homeowner sector.

A common question is whether this only works for certain houses that all look the same. In fact, it is mass customization. Houses are all 3D scanned and refurbishment packages are individually produced because even a set of row houses are not all exactly the same, even if it looks like they are. The focus until now has been on the most prevalent typologies of houses in the Dutch market of which 2.3 million houses in the Netherlands exist, but flexibility will increase over time with the number of possible solutions. The first designs will establish whole new supply chains based on prefabricated industrially production methods providing new platforms for further, interactive innovation process (very much like the car industry).

5. CONCLUSION

Without any doubt there is a necessity to drastically reduce the use of fossil-fuel energy sources by reducing the **demand for energy and switching from fossil to renewable sources. Buildings account for 40% of Europe's energy** consumption and three-quarters of the floor area of the building stock is residential. The targets are clear and the technical solutions are available. Good insulation and product innovations can reduce the energy demand for heating and cooling for a large part. The remaining energy demand can be delivered by renewables like sunlight and heat, district heating, heat pumps, etc. The remaining electricity demand for appliances can in the first place be reduced by further product innovation and then be provided by photovoltaic panels. There are no reasons not to apply these solutions in new buildings at a large scale on the short term. Evaluations of the current practice show however that there is a lot to be gained here. To improve this situation, it has to be assured that constructions and installations are installed properly and in such way that they are not vulnerable for unpredictable or misuse by

the occupants. This will set demands on both the construction industry as on the control and enforcement process (and the parties responsible).

The improvement of the existing building stock forms a big challenge. The potential energy savings are large, but the barriers to overcome are also high. As stated before, almost three quarters of the future housing stock (2050) has already been built. Studies show however that it is hard to increase the rate and depth of energy renovations of the existing stock. Actual energy (and financial) savings in renovated dwellings stay behind expectations because of rebound effects. There are important barriers. Many owners believe that the benefits of the measures do not outweigh the costs. Besides that, the cost of improving the energy performance of a dwelling does not (proportionally) increase the value of the dwelling.

We are faced with the difficult task to increase the energy renovation pace. The question is how this process can be accelerated. Maybe there is still room for further smart product development. Innovative products that contribute significantly to the reduction of energy demand, that are cheap, easy to apply and to handle by occupants and users. The fast decrease of the price of PV cells is promising.

REFERENCES

- [1] Energiesprong (2016). Eerste ervaringen met prestatiegarantie voor nul op de meter woningen (First experiences with performance guarantees for zero on the meter dwellings). <http://energielng.nl/resources/monitoringprestatiegarantie>
- [2] Filippidou, F, Nieboer, N, Visscher, H, 2014, The Pace of Energy improvement in the Dutch non-profit housing stock, in Proceedings of SB 14, World Sustainable Building Conference, Barcelona.
- [3] Filippidou, F, Nieboer, N, Visscher, H, 2015, Energy efficiency measures implemented in the Dutch non-profit housing sector, ECEEE conference, France
- [4] Guerra Santin O., Itard L. and Visscher H.J. 2009, The Effect of Occupancy and Building Characteristics on Energy Use for Space and Water Heating in Dutch Residential Stock, *Energy and Buildings*, 41, 1223-1232.
- [5] Guerra Santin O. and Itard L. 2010, Occupant behaviour in residential buildings in the Netherlands: Determinants and effects on energy consumption for heating, *Building Research & Information*, 38:3, 318-338
- [6] Meijer, F.M., Visscher, H.J. and Sheridan, L., 2002, Building Regulations in Europe, part I: A Comparison of systems of building control in eight European countries, *Housing and Urban Policy Studies* 23, Delft, Delft University Press.
- [7] **Meijer, F.M. and Visscher, H.J., 2006, 'Deregulation and privatisation of European building-control systems', *Environment and Planning B: Planning and Design*, Volume 33 (4), pp. 491-501.**
- [8] **Meijer F.M. and Visscher H.J., 2008, 'Building regulations from an European perspective', in *Proceedings of COBRA 2008 - The construction and building research conference of the Royal Institution of Chartered Surveyors, RICS, London.***
- [9] Majcen, D., Itard, I. and Visscher, H.J. 2013a, Theoretical vs. actual energy consumption of labelled dwellings in the Netherlands: Discrepancies and policy implications, *Energy Policy* 54, 125 – 136.
- [10] Majcen, D., Itard, L., Visscher, H.J. 2013b, Actual and theoretical gas consumption in Dutch dwellings: What causes the differences? *Energy Policy*, 61, 460-471.
- [11] Majcen, D., Itard, L., Visscher, H.J. 2015, Statistical model of the heating prediction gap in Dutch dwellings: Relative importance of building, household and behavioural characteristics, *Energy and Buildings*, 105, 43-59.
- [12] Munckhof, J., Erck, R. van, 2015, A house makeover paid for by your energy bill, *Annales des Mines*
- [13] Nieman 2007, Final report Housing quality indoor environment in new built dwellings, Vrom inspectie Regio Oost, Arnhem.
- [14] **Rovers, R., (2014), New energy retrofit concept: 'renovation trains' for mass housing, *Building Research and Information*, 42 (6) 757-767.**
- [15] Visscher H., Meijer F., Majcen D., Itard L. (2016) Improved governance for energy efficiency in housing, *Building Research & Information*, 44:5-6, 552-561, DOI: 10.1080/09613218.2016.1180808
- [16] WoON Energie, 2009, Woononderzoek Nederland, module energie, VROM.

Evaluation of Using BEAM-PLUS to Facilitate Waste Reduction in Building Construction

Lara Celine JAILLON^a, Ming Wai LEE^b, Chi Sun POON^c

^a City University of Hong Kong, Hong Kong SAR, ljaillon@cityu.edu.hk

^b City University of Hong Kong, Hong Kong SAR, minglee4@cityu.edu.hk

^c The Hong Kong Polytechnic University, Hong Kong SAR, cecspoon@inet.polyu.edu.hk

ABSTRACT

As with many other countries, Hong Kong has experienced severe social and environmental problems because of construction waste. Therefore, promoting resource conservation and implementing waste reduction measures are **a priority in the building industry's attempt to achieve sustainable construction goals. Green building construction** must be underlain by the consideration of net positive contributions to urban environments, the avoidance of waste generation and the promotion of the material life cycle concept. Sustainability in the industry is also strongly driven by the use of environmental assessment tools for buildings. Accordingly, there is a need to evaluate the effectiveness of such tools in promoting waste reduction.

Since 2011, certification under the Building Environmental Assessment Method (BEAM-PLUS) has been amongst **the prerequisites for the granting of gross floor area concessions for Hong Kong's development projects**. This research was aimed at evaluating the effectiveness of BEAM-PLUS in facilitating waste reduction in the building construction sector. It assessed the appropriateness of the waste reduction criteria in BEAM-PLUS and the waste reduction level achieved when such criteria are adopted. A questionnaire survey, a case study of recently completed buildings and face-to-face interviews were conducted to collect data. The findings reveal that although waste control awareness has increased in recent years, it remains neglected by the stakeholders of building construction. Incentives provided in the Material Aspect (MA) criteria of BEAM-PLUS can serve as an effective motivation for reducing waste, although some credits may be difficult to achieve. MA credits should be divided into sub-credits to encourage the wider adoption of MA in the building industry. BEAM-PLUS should incorporate additional waste reduction measures to increase the awareness and adoption of life cycle thinking in the construction industry.

Keywords: BEAM PLUS, green building assessment, waste reduction

1. INTRODUCTION

Hong Kong is an extremely dense region with a population of about 7.3 million (Censtatd, 2016). It is currently confronted with a shortage of reclamation sites and landfill spaces because of limited available land. The construction industry of Hong Kong **accounted for 4.4% of the country's GDP in 2014. It exerts a major effect on economic and environmental issues** given that it consumes substantial energy and other resources and generates a significant amount of construction waste. Construction waste accounted for 25% of the total intake at landfills. In 2015, nearly 66,000 tonnes of construction waste were generated each day. With the current waste generation trend, the three existing landfills in Hong Kong will be full by the late-2010s, and public fill capacity will be depleted in the near future (EPD, 2014).

To address the critical issue of construction waste, the Hong Kong government has enacted various regulations, codes and initiatives that promote waste reduction. Amongst these measures, the Construction Waste Disposal Charging Scheme is recognised and proven to be effective at reducing waste that is discharged to landfill sites (Tam, 2008; Lu and Tam, 2013; Yu et al., 2013). Similarly effective regulations are the 3R principles (reduce, reuse and recycle) and the 'polluter pays' principle. **Adherence to the 3R principles have become common practice amongst policy makers and practitioners of sustainable solid waste management** (Memon, 2010; Napier, 2012).

Amid these achievements, however, an important consideration is that effective construction waste management (CWM) does not depend solely on government efforts but also on collaboration amongst industry players. Poon et al. (2004) reported that on-site waste sorting and recycling are regarded as a low priority by contractors mainly because of low environmental awareness within the industry and because of the constraints represented by

limitations in site areas. In an investigation of stakeholders' willingness to apply waste minimisation strategies, only the government showed a positive attitude, whereas clients, contractors and designers remained neutral (Tam, 2008). In recent years, contractors' attitudes and behaviours towards on-site sorting and recycling have improved: such improvement has led to more effective reuse and recycling of resources given that waste sorting is implemented on-site at the source (Yuan et al., 2013). Interestingly, public projects exhibit better on-site sorting performance than do private projects (Lu et al., 2016). Yuan et al. (2013) pointed out that stakeholders' attitudes towards waste sorting in construction sites are still regarded as the most critical factors for enhancing Hong Kong's CWM. As Hong Kong's green building tool, BEAM-PLUS incorporates waste reduction and recycling criteria in the assessment of sustainability in building construction. However, Ng's (2014) examination of 23 platinum projects revealed that Material Aspects (MA) only achieved 50% among all four categories. This percentage was the lowest amongst all the four categories of the evaluation method.

Given this backdrop, the current research was conducted to assess the use and achievability of waste-related MA credits and their effectiveness in reducing waste generation in Hong Kong projects. Data were collected through a questionnaire survey and interviews. An in-depth case study was also carried out. On the basis of the results, recommendations for the construction industry were formulated.

2. METHODS

As previously stated, data were collected through a survey and individual face-to-face interviews that were targeted towards various professionals in the construction industry. The survey was designed to assess the appropriateness of the waste reduction criteria in BEAM-PLUS. The face-to-face interviews served as supplementary avenues from which to investigate the issues addressed in the survey. These issues included challenges and opportunities and recommendations for strengthening waste reduction through BEAM-PLUS. A total of 32 respondents participated in the survey, and 20 professionals participated in the interviews.

The survey respondents and interviewees were asked to assign Likert scale rating that reflects the perceived importance or effectiveness of each item studied. The rating ranged from -2 (e.g. lowest importance) to 2 (e.g. highest importance). The data collected were then analysed using statistical methods, and presented in tables with rankings.

The in-depth case study involved a project-oriented survey and a face-to-face interview. The project-oriented survey consisted of questions regarding the BEAM-PLUS criteria that practitioners have attempted to satisfy, and detailed information related to the perceived relevance and achievability of the criteria within the MA category. The examined project was completed in 2015 (Table 1). The survey data were collected from a Hong Kong building industry contractor who was involved in the project. Additional data were derived via a face-to-face interview with the contractor to substantiate the survey data.

Project description	3 towers with around 27 floors 2-level podium
Year of construction	2013-2015
Site area (m ²)	8,250
CFA (m ²)	66,000
BEAM Plus version	BEAM Plus New Buildings version 1.1
BEAM Plus rating	Provisional Gold
Podium construction	Cast-in-situ (Timber formwork)
Tower construction	Prefabricated non-structural elements and cast-in-situ (95% Steel formwork and 5% Timber formwork)
Precast % (by volume per typical floor)	15%
Type of prefabricated elements	Precast external facade walls and curtain wall
Design characteristics	Repetition on every typical floor Variations of layout on each towers

Table 1: Details of Hong Kong BEAM-PLUS case study

The total amount of construction waste generated and the total amount of construction waste recycled in the project were recorded by the contractor in tonnes per month, as reflected in the landfilling documentation (by truck) and receipt from the recycling company. The waste quantity was calculated with the same method adopted by Jaillon et al. (2009) and expressed in Equation 1. The data were then compared with those on the projects constructed under Hong Kong's Joint Practice Notes (JPN) policies of 2001 and 2002 (see Jaillon et al., 2009). The average waste quantity generated by the JPN-regulated residential building projects of the private sector was 0.23 tonnes/m². The calculation method for comparing our case project with the projects investigated in previous research is shown in Equation 2. The calculation method for comparing the recycled construction waste is indicated in Equation 3.

$$\text{Ratio of Waste Quantity: } C_w \text{ (ton)/ CFA (m}^2\text{)}$$

Equation 1

Where C_w = Construction waste generated; CFA = Construction floor area

$$\text{Level of reduction: } (P_n - P_o) / P_o \times 100\%$$

Equation 2

Where P_o = Waste quantity from the average of projects using prefabricated technology from the private sector (Jaillon et al., 2009); P_n = Waste quantity from the project in this research.

$$\text{Rate of recycled construction waste: } W_r / C_w$$

Where W_r = Recycled construction waste; C_w = construction waste generated

Equation 3

3. RESULTS

The survey findings reveal that factors 4, 9 and 15 were the most frequently attempted MA credits (Table 2). The results also reflect that, overall, MA credits are satisfied to a lesser extent than are other credits. Ng's (2014) study confirms these results.

Factor No.	Factors	Rank
1	MA 1,1 credit for the reuse of 30% or more of existing sub-structure or shell	10
2	MA 1,2 credits for the reuse of 60% or more of existing sub-structure or shell	13
3	MA 1,1 additional BONUS credit for use of 90% or more of existing substructure or shell	16
4	MA2, 1 credit for demonstrating the application of modular and standardized design	2
5	MA3, 1 credit when the manufacture of 20% of listed prefabricated building elements has been off-site	4
6	MA3,2 credits where the manufacture of 40% of listed prefabricated building elements has been off-site	14
7	MA 4, feasible and at least 50% of the listed items in the relevant BEAM checklists could be achieved in residential development	10
8	MA 4, feasible and at least 70% of the listed items in the relevant BEAM checklists could be achieved in other building types	9
9	MA 6, 1 credit for demonstrating at least 50% of all timber and composite timber products used in the project are from sustainable sources/ recycled timber	3
10	MA 7, 1 credit for the use of recycled materials contributing to at least 10% of all materials used in site exterior surfacing work, structures and features	6
11	MA 7, 1 credit where at least 10% of all building materials used for facade and structural components are recycled materials	8

12	MA 7, 1 credit where at least 10% of all building materials used for interior non-structural components are recycled materials	6
13	MA 10, 1 credit for demonstrating that at least 30% of demolition waste is recycled	5
14	MA 10, 2 credits for demonstrating that at least 60% of demolition waste is recycled	15
15	MA 11, 1 credit for demonstration that at least 30% of construction waste is recycled	1
16	MA 11, 2 credits for demonstration that at least 60% of construction waste is recycled	12

Table 2: Frequency of MA credit attempted in respondents' company's BEAM-PLUS NB projects

3.1 Appropriateness of MA credits

The MA category of BEAM-PLUS can be regarded as a guideline for measuring waste reduction in the construction industry. Appropriate requirements for acquiring MA credits should be practical and efficient to promote construction waste reduction. These credits are key to encouraging the increased adoption of waste reduction measures and advancing the implementation of BEAM-PLUS measures.

As shown in Table 3, the survey respondents identified factors 1 and 2 and factors 6 to 8 as having appropriate percentage levels. However, for factors 1 and 3 to 5 and 9 and 10, the respondents suggested reducing the required percentage levels. Most of the interviewees opined that some of the credits are difficult to achieve because of high requirements and limitations with respect to building types, land area restrictions and material specifications. In factors 9 and 10, (MA 10 - Demolition Waste Reduction and MA 11 - Construction Waste Reduction), which directly affect the waste diverted to landfills, 1 and 2 credits are awarded for at least 30% and 60%, respectively, of demolition/ construction waste recycled. Most of the respondents expressed a preference for lowering the percentage levels to 10% to 20% given that the original levels are ambitious. That is, they are difficult to achieve because of time limitations (demolition and sorting of waste/ materials require additional time) and lack of on-site storage and sorting spaces (small sites in dense urban areas). With regard to the second credit for the recycling of demolition/ construction waste, the majority of the respondents prefer lowering the percentages to 10% to 40% because satisfying a 60% recycling rate is laborious. The interviewees also mentioned that most existing buildings are demolished prior to the awarding of construction projects. Some architects pointed out that waste recycling may be difficult for them to control/ monitor given that contractors take the lead in handling both demolition and construction waste. Additionally, most of the contractors stated that recycling companies accept only some recycled materials and may be the primary handlers of waste at construction sites located near recycling points. Furthermore, the labour cost associated with sorting waste into recyclable material is high. To conclude, the recycling rate at construction sites can be increased if sufficient time and space are provided and if the market for

Factor No.	Factor	Decrease the level	Remain the level	Increase the level
1	MA2, 1 credit for demonstrating the application of modular and standardized design (over 50%)	✓	✓	✗
2	MA3, 1 credit when the manufacture of 20% of listed prefabricated building elements has been off-site	✗	✓	✗
3	MA3,2 credits where the manufacture of 40% of listed prefabricated building elements has been off-site	✓	✗	✗
4	MA 4, feasible and at least 50%of the listed items in the relevant BEAM checklists could be achieved in residential development	✓	✗	✗
5	MA 4, feasible and at least 70% of the listed items in the relevant BEAM checklists could be achieved in other building types	✓	✗	✗
6	MA 7, 1 credit for the use of recycled materials contributing to at least 10% of all materials used in site exterior surfacing work, structures and features	✗	✓	✗
7	MA 7, 1 credit where at least 10% of all building materials used for facade and structural components are recycled materials	✗	✓	✗

8	MA 7, 1 credit where at least 10% of all building materials used for interior non-structural components are recycled materials	✗	✓	✗
9	MA 10 and 11, 1 credit for demonstrating that at least 30% of demolition and construction waste is recycled	✓	✗	✗
10	MA 10 and 11, 2 credits for demonstrating that at least 60% of demolition and construction waste is recycled	✓	✗	✗

Table 3: Appropriateness of percentage level in MA credits to promote construction waste reduction

3.2 Effectiveness of MA credits in reducing waste

The examined project attempted to achieve the following MA waste-related credits:

- MA2 modular and standardised design: Over 50% of building elements are designed as modular and standardised components to minimise construction cut-off waste.
- MA4c adaptability and deconstruction: A total of 50% or more of the structural design is created for flexibility in future use to reduce demolition waste from future changes.
- MA6 sustainable forest products: A total of 50% or more of timber and composite timber products are obtained from sustainable sources or recycled timber to help reduce resource extraction and protect forest ecology.
- MA7b recycled materials: A total of 10% or more of the building materials used in façade and structural components are recycled materials to encourage waste to be recycled and indirectly reduce waste disposal.
- MA11 Construction Waste Reduction: Approximately 35% of construction waste is recycled to help reduce the disposal of construction waste.

According to the data, the waste generated from the case project was 0.21 tonnes/m² (all construction waste generated per CFA). Data from Jaillon et al. (2009) show that the quantity of waste generated per CFA for high-rise residential buildings in the private sector was 0.23 tonnes/m² when prefabrication techniques were used and 0.30 tonnes/m² when conventional methods were adopted. The construction waste generated in the project examined in the present study was 30% lower than those produced with conventional techniques (Jaillon et al., 2009). As indicated in the interview data, the recycled waste in our case project were mainly steel (95.5%) and paper/ cardboard packaging (4.4%). Steel formwork was reused on typical floors, whereas timber formwork was reused only two to three times.

As shown in the survey, 45% of participating professionals believe that BEAM-PLUS cannot promote waste reduction, whereas 34% expressed neutral attitudes. These findings may be attributed to the achievability and appropriateness of the BEAM-PLUS credits. They also reflect that the BEAM-PLUS credits still have room for improvement in terms of promoting waste reduction. A necessary requirement is to compel contractors to quantify generated waste for practitioners to effectively reduce waste.

4. CONCLUSION

The effectiveness of waste reduction via BEAM-PLUS was assessed on the basis of a survey, face-to-face interviews and a case study. The waste reduction criteria in BEAM-PLUS were evaluated as insufficient given that waste reduction is not regarded as a priority in the Hong Kong building industry and that practitioners rarely satisfy MA criteria owing to low overall weighting, lack of required minimum thresholds and difficulty in achieving credits. Furthermore, the MA category provides no criteria for enhancing cooperation between builders and designers in waste reduction, and no accurate figure reflects the amount of waste reduced after attempts to acquire MA credits. On the basis of the interview findings, the following recommendations were developed:

- Break down credits into sub-credits and provide detailed explanations and more specific environmental measures for easier attainment of MA credits.
- Provide a criterion that enables requests to reduce waste generation (tonnes/m²), on the basis of total waste generation data collected over the last few years through BEAM-PLUS (MA 11) and EPD (trip ticket system).
- Providing a ratio of MA aspects according to the scope of BEAM-PLUS as a minimum threshold may be un-suitable.

REFERENCES

- [1] Censtatd 2016, Home | Census and Statistics Department. [online] Retrieved from: <http://www.censtatd.gov.hk/home/index.jsp> [Retrieved on 14 July 2016].
- [2] EPD 2014, Monitoring of Solid Waste in Hong Kong 2014. [online] Retrieved from: <https://www.wastereduction.gov.hk/sites/default/files/msw2014.pdf> [Retrieved on 4 Dec. 2015].
- [3] Hao, J., Hills, M. and Tam, V., 2008. The effectiveness of Hong Kong's Construction Waste Disposal Charging Scheme. *Waste Management & Research*, 26(6), 553-558.
- [4] Jaillon, L., Poon, C. and Chiang, Y., 2009. Quantifying the waste reduction potential of using prefabrication in building construction in Hong Kong. *Waste Management*, 29(1), 309-320.
- [5] Lu, W. and Tam, V., 2013. Construction waste management policies and their effectiveness in Hong Kong: A longitudinal review. *Renewable and Sustainable Energy Reviews*, 23, 214-223.
- [6] Lu, W., Chen, X., Ho, D. and Wang, H., 2016. Analysis of the construction waste management performance in Hong Kong: the public and private sectors compared using big data. *Journal of Cleaner Production*, 112, 521-531.
- [7] Memon, M., 2010. Integrated solid waste management based on the 3R approach. *J Mater Cycles Waste Manag*, 12(1), 30-40.
- [8] Napier, T., 2012. Construction Waste Management | Whole Building Design Guide. [online] Retrieved from: <https://www.wbdg.org/resources/cwmgmt.php> [Retrieved on 15 Nov. 2015].
- [9] Ng, J., 2014. The Cream of BEAM Plus - A general case review of platinum green buildings, CPD seminar, 19 Dec 2014.
- [10] Poon, C., Yu, A. and Jaillon, L., 2004. Reducing building waste at construction sites in Hong Kong. *Construction Management and Economics*, 22(5), 461-470.
- [11] Tam, V., 2008. On the effectiveness in implementing a waste-management-plan method in construction. *Waste Management*, 28(6), 1072-1080.
- [12] Yu, A., Poon, C., Wong, A., Yip, R. and Jaillon, L., 2013. Impact of Construction Waste Disposal Charging Scheme on work practices at construction sites in Hong Kong. *Waste Management*, 33(1), 138-146.
- [13] Yuan, H.P., Lu, W.S., Hao, J.L., 2013. The evolution of construction waste sorting on site. *Renew. Sustain. Energy Rev.*, 20, 483- 490.

Energy, Comfort and Cost Optimization of a Net-Zero Energy Building in Berlin

Olaf BOETTCHER^a, Fabrizio ASCIONE^b, Nicola BIANCO^c, Nicolas KERZ^d, Giuseppe Peter VANOLI^e

^a Federal Institute for Research on Building, Urban Affairs and Spatial Development, Germany, olaf.boettcher@bbr.bund.de

^b University of Napoli Federico II, Italy, fabrizio.ascione@unina.it

^c University of Napoli Federico II, Italy, nicola.bianco@unina.it

^d Federal Institute for Research on Building, Urban Affairs and Spatial Development, Germany, nicolas.kerz@bbr.bund.de

^e University of Sannio, Italy, vanoli@unisannio.it

ABSTRACT

The planning and construction of highly energy-efficient buildings is one of the most ambitious challenges of the building industry worldwide. Especially in Europe the topic of Nearly Zero-Energy-Buildings is very present because of the legal requirements of the European Parliament on buildings. All relevant stakeholders, scientists as well as practitioners, are looking for successful strategies to achieve that goal.

In 2010 the planning phase for the first Net-Zero-Energy-Building of the German Federal Government started. The building should cover its total final-energy demand by the use of renewable energies solely. At the same time the building should have the highest standard of sustainability regarding to the assessment system used for buildings of the Federal Government (BNB). The building went in operation in 2013 and since then the building operation has been monitored.

First experiences and results of the monitoring of the energy performance, the thermal comfort and assorted aspects of the sustainability will be presented and general recommendations for improvements of details and processes are given. Furthermore a strategy for the optimization of the performance, energy and comfort as well as costs, will be introduced. Therefore a building model was created and calibrated on basis of the measured data. By varying different parameters like energetic quality and changes in the sizes of different building parts or the inclusion of new devices in the energy supply concept the influences on the total building costs but also on the energy and comfort balance were investigated in dynamic simulations.

Keywords: high-performance building, building energy simulation, energy measurement and verification

1. INTRODUCTION

In the framework of the last European Directives concerning the energy performance of buildings, all EU Member States enacted legislations in matter of a low-carbon future of the building sector with increasingly stringent prescriptions for the next years. Following the 2010/31/EC Directive, public administrations and Institutions have to play a leading role in the field of energy efficiency in the building sector. The Directive concern both new and **existing buildings. One of the most relevant aspects is the target of “nearly zero-energy buildings”. Member States** in particular are requested to guarantee high quality buildings with a minimized energy demand and mainly using renewable energies according to the following time schedule (Article 9 of the 2010/31/EC Directive):

- For new buildings owned and or occupied by public administration and authorities, the nearly zero-energy standard is requested from January 2019;
- Starting from January 2021, all new buildings shall fulfill the nearly zero-energy standard.

In 2010 the planning phase for the first Net-Zero-Energy-Building of the German Federal Government started. The building is located in Berlin and used as office building for approximately 30 persons. Destined for the German Federal Environment Agency (UBA) and aspiring the fulfillment of the EU-requirements of 2019 the building is called UBA 2019. The building concept was oriented toward the Gold-standard of the Assessment System for Sustainable Building (BNB; www.nachhaltigesbauen.de), the rating tool for sustainable buildings of the German Federal Government (Federal Buildings).

The difference between “nearly” and “net” zero energy buildings (nearly ZEB and net ZEB) is the share of renewable energies which is used to cover the energy demand of the building. While in a nearly ZEB the energy

demand is covered predominantly by renewable energies that share is 100 % in a net ZEB during a certain time period (mostly one year).

2. PRESENTING THE BUILDING CASE STUDY

The building UBA 2019 has a compact square shape (Figure 1). The gross dimensions - width and length - are 25 m, even if the east-west façade has a longer aspect, due to the anterior porch on the south and north exposure. Most offices are for single persons. The building has three meeting rooms; two of them can be connected. Other spaces are used for services (as kitchen and toilettes), technical rooms and common areas. In Figure 2 ground and first floor are shown.



Figure 1: UBA 2019; view from south (left), view from west (right)



Figure 2: Schemes of ground floor (left) and first floor (right)

In order to reduce the energy need for heating (e.g., cooling demand can be covered almost without energy costs by using groundwater and natural ventilation), the envelope structures were strongly thermally insulated by thick layers of cellulose fiber. The structure of the thermal envelope is the following:

- External wall: The overall thickness is 0.46 m (inclusive of 36 cm of cellulose insulation). On the inner side, there is an OSB plane with a coating of drywall. Externally an air permeable wooden fiberboard is installed. The thermal transmittance (U-value) is 0.12 W/m²K.
- Flat roof: The overall thickness is 0.96 m, with 53 cm of cellulose fiber insulation. The structural elements are wooden box beams, with a thickness of 28 cm. On the outer side, there are 10 cm of mixed sand, gravel, chippings, covered with extensive sedum vegetation. Other intermediate layers are two OSB boards, a vapor barrier on the inner side, a waterproofing layer on the external side. The thermal transmittance is around 0.05 W/m²K.
- Floor on the ground: Wooden box beams are insulated with 16 cm of poly-urethane and 12 cm of foam glass. On the inner side, a light concrete layer of 6 cm is covered with the parquet floor. The thermal transmittance is 0.09 W/m²K, with a total thickness of 0.71 m.
- Windows and skylights: Are triple-glazed systems, with certified overall U-values respectively equal to 0.70 and 0.86 W/m²K. The windows are equipped with shading systems (horizontal slats). The shadings are

located externally to the third glass. A fourth pane is installed in the frame as protection of the shading device. This pane can be opened separately.

Already after finishing the air-tight sealing a first blower door test was performed in order to guarantee a certain quality of the construction. After completion the building air-tightness was measured by a second test. The testing involved a series of under-pressure and over-pressure measurements. The measured rates of air change per hour (ACH), at a differential pressure of 50 Pa (i.e., n50), ranged between 0.30 h⁻¹ and 0.35 h⁻¹. The calculated average value is 0.33 h⁻¹.

For heating and cooling the offices built in capillary tube systems and handled ventilation air are installed. For heating, the capillary tubes are embedded in the inside of the external walls. The water for the wall integrated heating system as well as for the heating coil of the ventilation system is heated by a water-to-water geothermal heat pump. Conversely, the capillary tubes for cooling are embedded in the partition walls. No chiller is required. Only for pumping the ground water electric energy is needed. The temperature of the ground water is directly used for cooling the building by passing a water-to-water heat exchanger. In each office a dew point sensor prevents condensation by stopping the cooling system. The cool ground water also is used for cooling in the air supply system.

The mechanical ventilation system - designed for achieving the comfort Category II according to the Standard EN 15251 in each room - is equipped with a sensible flat plate heat recovery system.

Beyond the use of ground water for cooling and heating the building is equipped with a solar thermal energy system, with an overall solar collector area of 11 m² and two 970 l thermal heat storage tanks. The inclination angle of the solar thermal collectors is 37°, with a slight deviation, around 8°, from the south exposure. Furthermore a large photovoltaic system is installed on the building roof. In order to reduce the system visibility a tilt angle lower than 10° was chosen. The total installed capacity is approx. 66 kWp. The designed specific yield is 790 kWh_{ELECTRIC}/(kWp*a). Compared to the calculated annual demand of electricity for all processes in the building in the amount of approx. 46,000 kWh/a it means a surplus in generation of electricity of approx. 10 %.

The building cost around 4.2 million Euro (net), including all building categories identified by the German standards DIN 276 and DIN 277 . **The specific price per gross floor area is about 3,325 €/m².**

Looking solely on the costs of architectural works and indoor technical equipment, the specific price is about 2,350 €/m². An average value for Germany, with reference to highly equipped office buildings, is around 1,730 €/m². Compared to that, the costs of UBA 2019 are 36 % higher. Regarding that point it should be noted that the building meets extraordinary requirements in matter of energy, accessibility, and sustainability.

3. RESULTS OF THE MONITORING

UBA 2019 is equipped with a full monitoring apparatus, thus continuous metering of all energy flows is possible. In detail, there are 83 electric meters, 26 heat counters, 4 meters for cold and hot water installed. Moreover, an outdoor weather station measures the outside air temperature and relative humidity, wind direction, wind speed, global solar radiation, CO₂ concentration, illuminance. To get information about the indoor climate a fixed and a mobile measurement system are used. In particular, the indoor air temperature is measured in each room and, for four representative spaces, further 18-27 sensors are installed for measurements concerning the thermal comfort, the indoor air quality (CO₂ concentration), peoples presence, illuminance and lighting level, status of use (e.g., window contacts, use of shading devices). The mobile system - that can be installed for some days in any place in the building - measures the thermal comfort by means of 8 sensors as well as the presence of persons.

Figure 3 is showing a comparison between expected data from the planning phase and the monitored data in the first 3 years of operation of UBA 2019. In all years of operation the electricity generation by PV-system is higher than the consumption of electricity. That means that the aim of a net ZEB is achieved. The installed PV-system is more efficient than planned and the solar irradiation was higher compared to a standard year. In detail one can see that the energy demand for each single process is different from the expected one. The reasons for that are mainly the reduced occupancy of the building and the existing potential for optimizations. The decrease in generation in the 2nd year of operation was caused by an accidental shutdown of the PV-system.

The monitoring of the indoor microclimate showed that the building achieved the highest categories in terms of operative temperature and air velocity regarding Standard DIN EN ISO 7730:2006 . For relative humidity the results differ. In summertime the highest category is met but in wintertime the air is too dry. Interviews with users confirm these results. Furthermore the answers gave indications for further optimization. As example malfunctions of the heating and cooling devices in some offices could be detected.

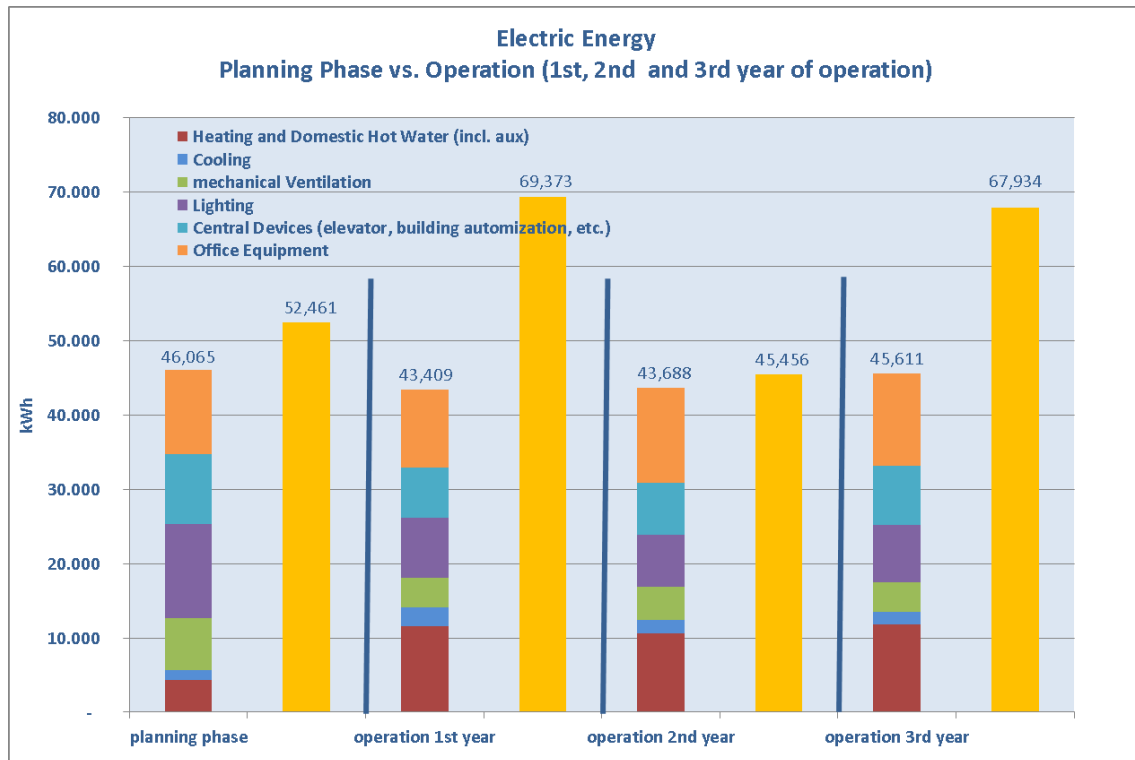

Figure 3: Results of the monitoring UBA 2019 – Planning phase vs. operation

4. EVALUATION OF THE BUILDING MODEL

Transient energy simulation, when validated based on proper calibration with monitored data is a powerful tool to understand gaps between design and operation, inefficiencies of building systems as well as to test potential energy efficiency measures aimed at improving building performance. Methods and protocols for calibrating energy models were developed by FEMP and ASHRAE [6,7 and 8] and these are applied in the investigations.

The building geometry and the general boundary conditions of the several functions of the building were implemented with DesignBuilder 3.2.0 [9]. EnergyPlus 7.2.0 [10] was used for numerical calculation and here also the materials and constructions for reproducing the real thermal-physical properties of the building envelope, such as provided by the design documentation (i.e., layers orders, materials' thermal conductivity, density, specific heat, etc.) have been defined. In the Appendix some key parameters affecting the energy simulation as the climate boundary conditions and other relevant data are reported there (Tables 1 and 2).

The relative differences between designed and simulated annual energy performance for each process based on hourly energy balances show a span between -1.2 % and 1.9 % (see Table 3).

Nevertheless, the differences between monitored energy usage and expected values from the planning phase suggested the definition of a new building model, calibrated on the present building operating conditions and patterns of use, in order to verify reasons and causes of differences in energy performance.

In order to verify a suitable calibration of the model, statistical indexes, as proposed by the M&V Guidelines "Measurement and Verification for Federal Energy Projects" [7] of the U.S. Department of Energy have been calculated. In our study the option D, suitable for the comparison of measurements of energy meters and output of numerical simulations, has been used. To understand deeply the reliability of our investigation, the indexes have

been calculated not merely for the whole facility, but also with reference to every system (heating, cooling, ventilation, auxiliaries, lighting).

In particular, the followings indexes have been calculated:

- Mean bias error (MBE): It allows to estimate the fit between the simulation and the measured data. Positive values testify an overestimation of the numerical model. Conversely, negative values reveal an underestimation.
- Coefficient of variation of the root mean square error (CV(RMSE)): The overall uncertainty of the prediction, and this refers to the whole energy usage of a building. The value of CV(RMSE) is always positive.

According to [6] and [7] the following values for MBE and CV(RMSE) are acceptable, when a month is the reference calculation period over the whole time horizon investigated:

- $MBE_{\text{month}} (\%) \leq \pm 5\%$,
- $CV(RMSE_{\text{month}}) (\%) \leq + 15\%$.

The MBE_{month} for the single processes in the building is in a span between -1.16 % and 1.95 %. The $CV(RMSE_{\text{month}})$ for the overall energy use is equal to 7.96 %. Thereby the calibration of the building model is completely satisfactory.

5. BATTERY STUDY

The building has an overproduction and at the same time a mismatch between electrical energy demand and generation. The economically most appropriate use of on-site produced electricity is on-site consumption. Therefore, a further investigation looked at the optimization of an electric storage system under both technical and economic points of view. Presently, the on-site energy yield is about 69,000 kWh_{ELECTRIC} a year, and thus the target of net zero energy building (i.e., the energy balances consider the energy flux on the basis of one year of observation period) is achieved. At the moment the grid on the property is used for supplying into the grid the surplus electricity and for getting electricity if demand is higher than production. Presently, the building uses only 27 % of the on-site generated electricity while the bigger part of the total electricity need is covered by the grid.

The energy demand for the microclimatic control in summer - the peak time of energy generation - is very low (only auxiliary devices are needed no use of chillers, low use of lighting because of the diurnal high radiation). Based on these considerations, an Electrical Energy Storage (EES) has been designed by optimizing energy capacity, discharge rate, and the costs (taking into account the feed-in tariff, the price of purchased energy, investment - **1.000 €/kW and 1.500 €/kWh** - and maintenance of the battery system). The aim was to find the lowest costs of the stored kWh of electric energy while maximizing the on-site use of the PV-generated electricity.

With costs of the stored kWh similar to the price of the one bought from the supplier a battery system with a capacity of 10 kWh and a discharge power of 39 kW can rise the on-site-use up to 42 %. The costs per stored kWh can be **decreased to 0.21 €/kWh if the maximum discharge power is limited to 16 kW. In this case** the on-site-use is slightly reduced to 38 %. This system is characterized by the optimal performance in terms of technical and economic constraints.

6. COST STUDY

The present surplus of electricity and the very high insulation of the building indicates that there are alternative configurations with reduced investment costs and/ or reduced lifecycle costs. Therefore a further study was carried out on alternative solutions for the building energy concept. The aim of that study was to find ways for a reduction of the building costs (investment cost as well as lifecycle costs) while the existing qualities in terms of energy performance, sustainability (BNB Gold level) and indoor comfort are maintained. Only the level of natural lighting could be increased because the windows of the building only take approx. 16% of the surface of the external walls. Also in this case, the calibrated building energy model has been used.

Several assorted measures and packages of these measures have been taken into account. They consist of widening of window areas from 16 % to 24 % of the external wall surface, reducing the thickness of insulation of

external walls, roof and bottom slab. Moreover, two different types of thermal glazing for windows (double and triple glazed) and a change in the control of the shading system have been investigated. The feasibility study has been performed according to the cost optimal methodology. For each package the global costs of the re-designed building were calculated and compared with the base case to find the package that represents the optimal level between costs, consumption and generation.

From all of the investigated measures and packages in the study the optimal one consists of changes in the size of the windows, change of insulation (i.e. 20 cm of mineral wool for both roof and external wall insulation, double glazed windows and reduced thickness of polyurethane for the bottom slab) and a different shading control system. In the simulation the measures are leading to a negligible lower annual primary energy consumption of 1.4 %. **At the same time the global costs in the lifecycle for the certain measures decreased by approx. 46,000 €.** In relation to the base case it means a reduction of the global costs of approx. 11 %. Regarding the total costs of the project (investment costs), the investigated improvements would lead to a reduction of less than 2 %.

7. CONCLUSIONS

After a 4-year-phase of planning and construction the first Net-Zero-Energy-Building of the German Federal Government went in operation in 2013. The sustainability of the building was certified regarding to the Assessment System for Sustainable Building for Federal Buildings (BNB). It achieved the highest degree of performance and therefore it obtained a certificate in gold.

The monitoring of energy usage, sustainability, indoor air quality and thermal comfort shows that the ambitious aims of the project were achieved almost totally. In order to access the left potential of optimization, a building model was developed and evaluated besides onsite measurements and user surveys. The model is used for investigations of different operation strategies or the installation of additional equipment. Furthermore it is an instrument for investigations regarding the cost-optimality of the building and thereby a tool for the development of general conclusions to that topic. First investigations in possible improvements of the building envelope were already carried out. A second study identified optimal design values for electric battery storage to improve the share of self-used electricity generated by the PV-system. The next step will be the implementation and monitoring of this device.

REFERENCES

- [1] EU Commission and Parliament, Directive 2010/31/EU of the European Parliament and of the Council of 19 May 2010 on the energy performance of buildings (EPBD Recast).
- [2] CEN – European Committee for Standardization, Standard EN 15251: Energy Performance of Buildings - Indoor environmental input parameters for design and assessment of energy performance of buildings- addressing indoor air quality, thermal environment, lighting and acoustics. CEN, Brussels, 2007.
- [3] German Institute for Standardization (DIN e.V.), Standard DIN 276: Building costs. Beuth-Verlag, Berlin, 2008
- [4] German Institute for Standardization (DIN e.V.), Standard DIN 277: Areas and volumes of buildings. Beuth-Verlag, Berlin, 2005
- [5] International Organisation for Standardization (ISO), Standard DIN EN ISO 7730: Ergonomics of the thermal environment – Analytical determination and interpretation of thermal comfort using calculation of the PMV and PPD indices and local thermal comfort criteria (ISO 7730:2005). Beuth-Verlag, Berlin 2006
- [6] U.S. Department of Energy, Federal Energy Management Program (FEMP). M&V Guidelines: Measurement and Verification for Federal Energy Projects Version 2.2, 2000.
- [7] U.S. Department of Energy, Federal Energy Management Program (FEMP). M&V Guidelines: Measurement and Verification for Federal Energy Projects Version 4.0, 2015.
- [8] ASHRAE - American Society of Heating, Refrigerating and Air-Conditioning Engineers, Guideline 14-2002, Guideline 14: Measurement of Energy and Demand and Savings, ISSN 1049-894X, 2002.
- [9] DesignBuilder Software, V 3.2.0.067, DesignBuilder Software Ltd (www.designbuilder.co.uk), Gloucestershire, UK, 2013.
- [10] U.S. Department of Energy, EnergyPlus simulation software, Version 7.2.0, 2012. Web: apps1.eere.energy.gov/buildings/energyplus.

APPENDIX

MAIN BUILDINGS DIMENSIONS				
Gross Length (N-S direction)	25.12 m	Gross Floor Area		1178 m ²
Gross Length (N-S direction)	25.12 m	Gross Volume		3862 m ³
Gross Length + Porch + Stairs	30.40 m	Roof Area		599 m ²
Gross Height	7.2 m (2 floors)	Surface to Volume Ratio		0.48 m ⁻¹
BUILDING GEOMETRY				
	TOTAL	North (315 to 45 deg)	East (45 to 135 deg)	South (135 to 225 deg)
	L			West (225 to 315 deg)
Gross Wall Area [m ²]	656.1	162.0	164.9	164.2
Window Area [m ²]	106.4	18.8	31.8	29.1
Window Wall Ratio [%]	16.2	11.5	19.3	17.8
INFORMATION ABOUT SITES, CLIMATES, INDOOR USES AND ENDOGENOUS GAINS				
Weather data	ASHRAE Berlin IWEC → EPW		Number of zones	58 Thermal zones
Set point during the heating time:			The set point of temperature for cooling is variable according to the trend of ambient temperature, ranging from 22 °C during the cold season, to 26 °C during the full summer. In the hottest summer days, it is 6 K lower than the outdoor temperature.	
Offices	22 °C (Off between 19.00 - 08.00)			
Common spaces	22 °C (Off between 19.00 - 08.00)			
Technical rooms	15 °C (Off between 19.00 - 08.00)			
BUILDING ENVELOPE				
U _{WALL} (weighted average method)	0.12 W m ⁻² K ⁻¹		U _{WINDOWS}	0.70 W m ⁻² K ⁻¹
U _{ROOF} and U _{FLOOR ON THE GROUND}	0.05 W m ⁻² K ⁻¹ 0.09 W m ⁻² K ⁻¹		U _{SKYLIGHTS}	0.86 W m ⁻² K ⁻¹
U _{PARTION (OFFICE-OFFICE)}	0.66 W m ⁻² K ⁻¹		U _{PARTION (OFFICE-WET ROOMS)}	0.26 W m ⁻² K ⁻¹
Shading systems	External venetian Blinds		Infiltration plus natural ventilation (Design)	0.3 ACH
HVAC SYSTEM				
In room heating and cooling terminals	Separated capillary radiant systems embedded in the external envelope (heating) and in the partitions (cooling).		Ventilation	Mechanical ventilation with heating/cooling control and heat recovery from the exhaust air. Demand controlled ventilation for the meeting rooms.
Ventilation air flow	Design Value: 3600 m ³ /h.		Heat Exchanger	Flat Plate, Air-to-Air, Sensible Heat
Fans Head	1002 Pa (supply), 523 Pa (Return)		η _{sensible} = 75%	
Geothermal Heat Pump	Water-to-water Heat Pump		Cooling Generation	Passive, by means of heat exchange with the ground water (i.e., no active cooling by means of electric chillers)
- Nominal Capacity	27 kW _{THERMAL}			
- COP and SCOP	5.0 W _{TH} /W _E and 3.9 W _{TH} /W _E			
PHOTOVOLTAIC SYSTEM (AS DESIGNED)				
PV Panels (66.3 kWp)	Crystalline Silicon,		Generator Efficiency	14.5%
PV Panels efficiency	≈ 17.5%		Design specific generation	790 kWh _{ELEC} /kWp
12 Arrays Gross Area	391 m ²		Total Designed electric generation	52,461 kWh _{ELEC}
Azimuth and Tilt angles	8° and 10°		System Global Efficiency	13.4%
THERMAL SOLAR SYSTEM				
Gross area of Solar Collectors (Glazed, Flat Plate)	11 m ²		Thermal Storages	Sequential storage, each one with a volume of 970 liters
Azimuth and Tilt angles	8° and 37°			
ENERGY COST, CONVERSION FACTORS AND EMISSIONS				
Electricity cost	0.292 €/kWh		Electricity GHG emission factor [45]	0.706 t CO ₂ / MWh

Table 1: Building characteristics, HVAC system descriptions, renewable systems, boundary conditions and energy related parameters

Weather Data (i.e., Reference Year)	
Weather Data	ASHRAE Berlin IWEC {GMT +1.0 Hours}
Heating Degrees-Day	3284 Kd annual (standard) (18.3°C baseline) (Official German Value for Berlin Tempelhof, G20/15: 3134)
Cooling Degrees-Day	147 Kd annual (standard) (18.3°C baseline)
Latitude and Longitude	{52° 28' North} { 13° 23' East}
Simulation Parameter	
Surface Convection Algorithm Inside	TARP – Variable Natural Convection Based on Temperature Difference
Surface Convection Algorithm Outside	DOE-2 – Correlation from measurements for rough surfaces
Heat Balance Algorithm	Conduction Transfer Function, 4 time-steps/hour
Minimum System Timestep: 1	Maximum HVAC iterations: 20
Winter Design Day	Outdoor Maximum Dry Bulb Temperature = -13.9 °C (Wet Bulb = - 13.9 °C), No solar radiation, Sky Clearness = 0, Barometric Pressure 100776.7 Pa, Wind Speed 14.1 m/s, Daily Dry-bulb Temp Range = 0°C
Summer Day in Winter	Outdoor Dry Bulb Temperature = 34.0 °C (Wet Bulb = 29.1 °C), Solar radiation from weather file, Sky Clearness = 0.98, Barometric Pressure 100776.7 Pa, Wind Speed 0 m/s, Daily Dry-bulb Temp Range = 13.4°C

Table 2: Climate boundary conditions

	Designed Building	Simulated Building	% GAP
Electric Energy for the space Heating (kWh/m ² a)	2.31	2.28	- 1.2
Electric Energy for Fans (kWh/m ² a)	5.93	6.04	1.9
Electric Energy for Pumps (kWh/m ² a)	9.14	9.03	- 1.2
Electric Energy for Artificial Lighting (kWh/m ² a)	10.75	10.83	0.7
Electric Energy for Office equipment (kWh/m ² a)	9.57	9.47	-1.0
Specific Electric Energy for the building use (no DHW) (kWh/m ² a)	37.7	37.65	- 0.1
Total Electric Energy for the building use (no DHW) (kWh)	44'411	44'352	- 0.1

Table 3: Comparison between the energy demands of the designed building and simulated performance by means of EnergyPlus 7.2.0

Modeling the Built Environment Element by Element: Uncovering Greenhouse Gas Intensive Policies and Structures with a New Visualization Tool

Verena GÖSWEIN^a, Jonathan KRONES^b, John FERNÁNDEZ^c, Guillaume HABERT^d

^a Instituto Superior Técnico, University of Lisbon, Portugal, verenag@ethz.ch

^b Center for Industrial Ecology, Yale School of Forestry and Environmental Studies, United States of America, jschrones@mit.edu

^c Department of Architecture, Massachusetts Institute of Technology, United States of America, fernande@mit.edu

^d Department of Civil, Environmental and Geomatic Engineering, ETH Zurich, Switzerland, habertg@ethz.ch

ABSTRACT

Future population growth is estimated to be concentrated in urban areas of the developing world. This growth and demographic shift will require a large amount of construction materials and generate Greenhouse Gas emissions. The present study is motivated by the lack of a holistic approach to understand how urbanization affects resources and the environment. A framework is established, which links population increase and the associated material flows devoted to construction of additional housing units as well as densification of the existing building stock. Different political scenarios as well as alternative construction techniques and building materials are used to explore the potential for reducing material requirements and embodied GHG related to urban growth in Johannesburg, South Africa. Stock dynamics modeling techniques are applied with the use of building typologies and uncertainty quantification. The bottom-up approach allows identifying appropriate solutions for decarbonization by localizing embodied GHG with a revisited Sankey diagram. The results of the dynamic model over time indicates that only a combination of densification of the building stock with multi-story buildings and the use of alternative construction materials and techniques shows a real potential to decelerate embodied GHG while aiming to provide adequate and sustainable housing.

Keywords: urban metabolism, scenario analysis, embodied energy

1. INTRODUCTION

Countries of the developing world are facing an increase in population and accelerated urbanization. **60% of the built environment required to accommodate the earth's urban population by 2050 remains to be built (UNEP, 2013).** While construction materials are already the single biggest form of material flows (Schandl and West, 2010), the coming urbanization wave will increase even more the pressure on resource extraction and its deleterious environmental impact. The objective of this paper is therefore to explore potentials to reduce material requirements and Greenhouse Gas (GHG) emissions caused by urban growth.

To do so, Urban Metabolism (UM) is used as it is a common method to understand how human and economic development affects the natural environment (Pauliuk et al., 2015). Studies on UM are subject to quality and amount of accessible data. This issue is raised in standard literature reviews (Broto et al., 2012; Zhang et al., 2015). Furthermore, studies at the urban scale in developed countries are data intense and go into great detail. In cities of developing and emerging countries, where this type of information does not exist, data mining remains a big challenge and data on the national level is used. Recent urbanization in most African cities has been largely informal (Cobbinah et al., 2015). In consequence, national or city data are of little help to grasp the material flows of these new settlements. There is a need for a finer granularity analysis whilst keeping a large-scale approach in order to extract sound and relevant data in a time-effective way.

The present paper wants to combine bottom-up accounting and demand-driven modelling of the building stock. By applying a combined approach, the advantages of the different modeling techniques can be employed for the specific situation in an emerging country: data scarcity can be overcome, information on the city scale can be modeled dynamically over time and the influences of socioeconomic indicators are taken into account. **Different scenarios for the identified determinants of the building stock's embodied GHG emissions are proposed. The scenario compares and combines these potentials to minimize future impacts.**

2. DATA AND METHODS

2.1 Typologically driven stock dynamics model

The framework for the model was adapted from a current stock dynamic approach developed by Hu and colleagues (2010). The method makes use of building typologies to model a whole urban residential building stock by simply using averages. The relevant service unit of the present study is floor area in use. This process is determined by the population size and per capita floor area (PCFA). PCFA is dependent on the dwelling type, it is one parameter considered to define building typologies. Actually, for each building typology, the household size is modeled. This includes people per household and habitable space per household. These characteristics are then translated to **the PCFA as an expression of the population's lifestyle**.

The floor area in use of the residential building stock is described with a state variable (in m^2) and a derivative, which represents the net stock accumulation. A density of materials is defined (in kg/m^2), which depends on building type, the volume of its elements and the density of used construction material. The material density controls the input of materials by linking it to the floor area. Equivalent to floor area, materials in use have a state variable (in tons of material) and derivative. The output of floor area and materials is determined by lifetime of dwellings and material respectively. Inflows are controlled by simple balance relations as a sum of in stock and outflow of mass and floor area.

The environmental impact of the production of each building material is defined as an embodied GHG intensity. The combination of this embodied GHG intensity with the input of materials in use allows to calculate the additional embodied GHG required for the additional floor area. Equivalent to the processes floor area and materials, embodied GHG in use is also modeled with a state variable (in tons of CO_2 equivalents), and a derivative.

2.2 New visualization tool

To visualize the allocation of the resources in the building stock, a diagram resembling a Sankey flow diagram is developed. The diagram helps to easily track the embodied GHG when modelling in a data scarce environment. It is a vital way of disentangling the building stock since the incorporation of typologies in the model makes it more complex to grasp and interpret. Furthermore, it allows comparing different technological and political options to decarbonize urban areas.

Often a huge number of line and bar charts are used to show the contribution of different types of infrastructure elements and their characteristics regarding material and energy intensity. These ways of presenting material stocks and flows make it difficult to grasp the entire information because results are shown in various tables and charts. The proposed revisited Sankey diagram makes it easier to see the link between different composites and processes and to visually identify the main drivers of material and energy consumption. The diagram highlights optimization potential, mainly from a structural engineering point of view. The proposed visualization does not show continuous flows like a classic Sankey diagram does. It is revisited so that the width of links indicates the proportion from one node to the next, but the illustrated flows change in terms of units from one step to the next.

2.3 The city of Johannesburg

The City of Johannesburg Metropolitan Municipality (referred to as Johannesburg in this article) is chosen as a case study. Johannesburg is a sprawling city composed of dispersed residential, industrial and office developments (Economist Intelligence Unit, 2011). As a result, it is less dense compared to other major African cities, leading to a particular interest of examining the challenges that arise from urbanization. The present study used national censuses for 1996, 2001 and 2011 (Statistics South Africa, 2011).

Building typologies

The building typologies are based on definitions of dwelling types from the South African census in 2011 and were gathered in 5 dwelling typologies: (1) house on a separate stand, (2) flat in a block of flats, (3) house/ flat/ room in backyard, (4) informal dwelling in backyard, and (5) informal dwelling in settlement. These 5 dwelling types represent around 87.5% of the residential building stock in Johannesburg (Statistics South Africa, 2011). The

model is run for a period from 1975 to 2040. Starting in 1975 allows creating reasonable initial conditions as the service life of buildings is relatively low and a large part of the urbanization linked with population growth happened at that period.

Material sets of building typologies

For each building typology a specific material set in kg per floor area and kg per building element is defined. Building elements considered are load bearing walls, roof, slabs and the foundation. The inventory is based on floor plans and images of representative buildings that can be allocated to each typology.

As it can be seen from Table 1, the two informal dwelling types (4 and 5) are identical in terms of material requirement but they were modeled separately in order to implement changes in the share of dwellings from political decision.

Element	Type (1)	Type (2)	Type (3)	Type (4)	Type (5)	Other
Walls	12,505	21,780	7,441	218	218	15,597
Foundation	16,432	18,751	2,548	-	-	17,205
Ceiling	-	17,120	-	-	-	5,707
Roof Trusses	310	1,117	268	-	-	579
Roof Tiles	1,905	6,222	1,163	71	71	3,344
Amount	31,152	64,990	11,419	289	289	42,431

Table 8: Amount of material in kg per building element for building typologies

GHG intensity of building materials

The current study focuses on GHG emissions related to the production of the different building materials. The maintenance can be neglected as we focused on structural elements (Hoxha et al., 2014) and the demolition and landfill phase of the life cycle are not the main responsible of the climate change related impact compared to the production phase of building materials (Lasvaux, 2012).

Future scenarios

Finally, future scenarios for the evolution of the building stock are considered. Engineering and policy measures were considered. For the engineering side, changes in the structural design as well as changes in the type of materials are considered. For the policy aspects, the focus lies on a change in building typologies.

Two structural design options are considered: a conventional structure of reinforced concrete slabs for multi-story buildings and an optimized one where a vaulting system is used allowing to drastically reduce the amount of materials for slabs (Block et al., 2010; Hebel, 2015). This innovative system was implemented by Hebel (2015) in **Ethiopia in the “SUDU - Sustainable Urban Dwelling Unit” project.**

For the alternative construction materials, the building materials low carbon concrete and earth are considered. Low carbon concrete is a concrete made with a cement containing a low proportion of clinker and therefore associated with smaller GHG emissions. This is the current trend in the cement industry where at the global level the clinker substitution is currently around 20% and the extreme scenario considered in the present study assumes that the substitution could reach 50%, which is a technical limit from the cement chemistry (Habert and Roussel, 2009). Concerning earth materials, earth based construction has been used for more than 10,000 years and a revival of this material can be observed in recent years (Landrou et al., 2016; Scrivener et al., 2016). The environmental impact associated with this material is extremely low and, if not stabilized, can be reduced to the impact associated with extraction and transport of the raw material. However, a stabilization of the material would lead to higher emissions per m³ and per MPa compared to traditional concrete.

Three different policy scenarios are considered. One scenario represents an elimination of informal settlements, **which is in line with UNEP’s recommendation to eliminate existing housing backlog in South Africa.** The second scenario considers a densification of the city through an increased share of apartment buildings in the building typologies. This is strongly encouraged by UNEP who considers that the existing urban density of 15-20 dwelling units/ hectare should be increased to a minimum of 35-45 dwelling units/ hectare via smaller plot sizes and multi-story buildings (UNEP, 2011).

3. RESULTS

3.1 Total embodied GHG emissions for political and technological scenarios

The different scenarios considering alternative structures and materials are combined with the policy scenarios to examine the potential impact of each respective scenario and are compared to the current situation (2011 data) and the Business as Usual (BAU) trend scenario in 2040.

The bar chart in Figure 1 shows how a change in policy, indicated by pattern, and different combinations of material and technology, as shown as groups on the x-axis, affect the embodied GHG intensity of Johannesburg in 2040. The diagram indicates that the different political scenarios alone do not have a primary importance in the future of GHG emission reductions. The same goes for singular improvements in technology. When considering low-carbon-concrete and optimized ceiling structure, the difference between the technical scenarios is small for the single policy scenarios (BAU or no informal settlements). However, the promotion of flats allows to increase the leverage effect of the optimized ceiling structure compared to the technical solutions where only low carbon concrete is used. Finally, it is also clear that the use of radical alternative materials and smart structure shows the potential for significantly reducing embodied GHG of the residential building stock by 2040. If these radical technical shifts are additionally combined with policy making which promotes a denser building stock by moving people from freestanding houses into apartment buildings, then the GWP linked with construction materials could stay within range of the 2011 value in 2040.

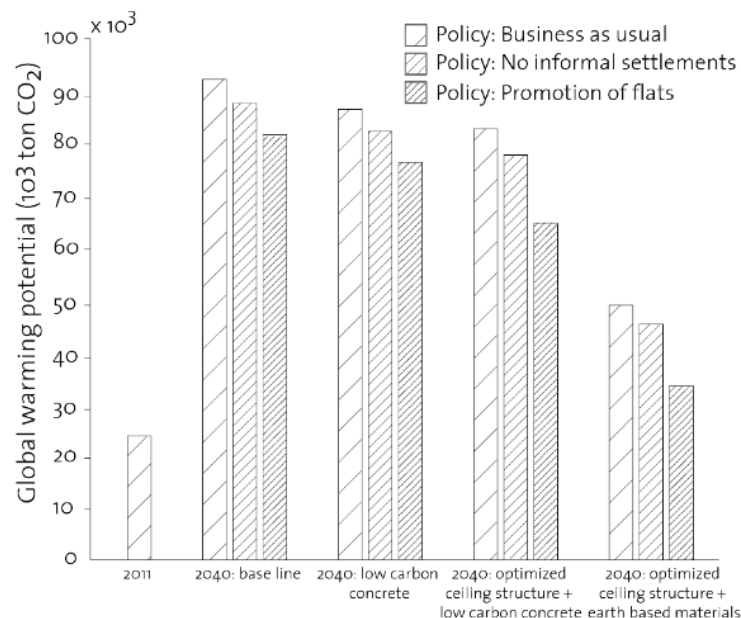

Figure 1: Total embodied GHG released in 2040

3.2 Visualization of building stock in 2040: comparison best and worst case

The proposed representation method helps to localize and track embodied GHG by breaking down the building stock into its components and small scale elements. It is important to note that the modified Sankey diagram developed in Figure 2 does not show one consistent unit but that from the first node to the second number of people per building typology are shown. From the second to the third node the links indicate mass of material per building element. This unit remains the same for the next step, a translation to type of construction material. The last links show amount of embodied GHG.

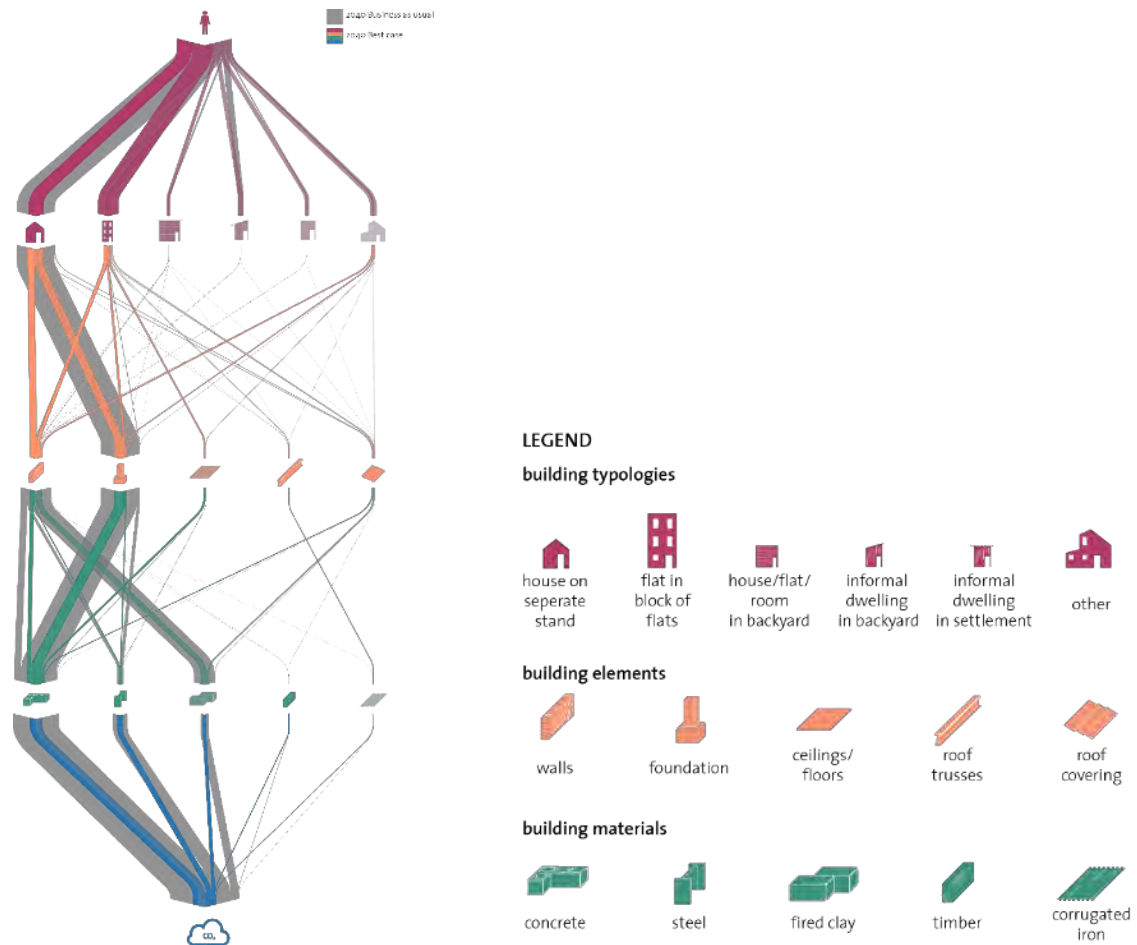

Figure 2: Revisited Sankey for the best (combination of promotion of flats with optimized floor structures and alternative building materials) and worst (BAU) case in 2040

Figure 2 shows the structure of the building stock for two extreme scenarios: the BAU and the one where optimized radical change in structure and materials are used as well as a shift towards multi-story buildings. The enormous amount of saving potential is clearly visible in the final GHG quantification. At the same time it can also be clearly explained that this is mainly due to the drastic reduction of the concrete for the foundation due to the shift from single houses to apartment. This is linked with two components. The first one is that there is less requirement of foundation per m² built in an apartment than in a freestanding single family house, and the second is that much less multi-story buildings need to be built to accommodate the growth of the population compared to when accommodated in single houses. This double effect induces that embodied GHG of the residential building stock could be reduced to one third compared with the BAU trend of current building techniques and housing habits.

4. DISCUSSION

The revisited Sankey diagram visually tracks construction material and associated embodied GHG of the built environment. There could be other types of visualization if we want to improve and understand, for example waste management or the potential for refurbishment. In that case, the focus would probably lie on the quality of construction and the age of buildings. However, these issues seem to be more relevant in developed countries where the current policy often wants to enable closed-loop material systems in the construction sector due to the fact that their cities are already built. Wiedenhofer and colleagues (2015) state that large share of material inputs are required for maintenance of existing stocks in the European Union and recommends that proper management of already built infrastructure will be crucial for future resource use. The Sankey-like diagram proposed in this study could help to understand the potential for refurbishments in such a context by linking age of the building, quality of construction and need for renovation with required amount of materials and energy.

5. CONCLUSION

The main purpose of this study was to propose a simple representation of the building stock and its drivers (population, building types, and materials) to be able to clearly understand the consequences of different potential actions. These actions being at the technical levels (type of materials, type of structure) as well as at the policy or urban planning level (building typologies). It is possible to use this representation and the results for transdisciplinary discussions and co-construction of pathways for decarbonization with all stakeholders involved in the production of the built environment.

Furthermore, the initial results show that urban planning actions will not have a significant impact if they are not combined with technical changes (materials and structure). Also, focusing on technological changes alone can only result in little action. It is the combination of both that can potentially stabilize greenhouse gas emissions related with the construction of the built environment in a context of a dramatically fast increase of the floor area demand in cities.

REFERENCES

- [1] Block, P., DeJong, M., Davis, L., Ochsendorf, J., 2010. Tile Vaulted Systems for Low-cost Construction in Africa. *ATDF journal* 7, 4–13.
- [2] Broto, V.C., Allen, A., Rapoport, E., 2012. Interdisciplinary Perspectives on Urban Metabolism. *Journal of Industrial Ecology* 16, 851–861.
- [3] Cobbinah, P.B., Erdiaw-Kwasie, M.O., Amoateng, P., 2015. **Africa's urbanisation: Implications for sustainable development.** *Cities* 47, 62–72.
- [4] Economist Intelligence Unit, 2011. **African Green City Index: Assessing the Environmental Performance of Africa's Major Cities. Munich, Germany.**
- [5] Habert, G., Roussel, N., 2009. Study of two concrete mix-design strategies to reach carbon mitigation objectives. *Cement and Concrete Composites* 31, 397–402.
- [6] Hebel, D., 2015. *SUDU—the Sustainable Urban Dwelling Unit: Research and Manual.* Ruby Press.
- [7] Hoxha, E., Habert, G., Chevalier, J., Bazzana, M., Le Roy, R., 2014. Method to analyse the contribution of **material's sensitivity in buildings' environmental impact.** *Journal of Cleaner Production* 66, 54–64.
- [8] Hu, M., Van Der Voet, E., Huppes, G., 2010. Dynamic Material Flow Analysis for Strategic Construction and Demolition Waste Management in Beijing. *Journal of Industrial Ecology* 14, 440–456.
- [9] Landrou, G., Brumaud, C., Winnefeld, F., Flatt, R., Habert, G., 2016. Lime as an Anti-Plasticizer for Self-Compacting Clay Concrete. *Materials* 9, 330.
- [10] **Lasvaux, S., 2010. Étude d'un modèle simplifié pour l'analyse de cycle de vie des bâtiments [Study of a simplified model for LCA of buildings] (PhD thesis). L'école Nationale Supérieure des Mines de Paris, Paris, France.**
- [11] Pauliuk, S., Majeau-Bettez, G., Müller, D.B., 2015. A General System Structure and Accounting Framework for Socioeconomic Metabolism. *Journal of Industrial Ecology* 19, 728–741.
- [12] Schandl, H., West, J., 2010. Resource use and resource efficiency in the Asia–Pacific region. *Global Environmental Change* 20, 636–647.
- [13] Scrivener, K.L., Vanderley, M.J., Gartner, E.M., 2016. Eco-efficient cements: Potential, economically viable solutions for a low-CO₂, cement-based materials industry. United Nations Environment Programme, Economy Division.
- [14] Statistics South Africa, 2011. Nesstar Virtual Data Library. URL <http://interactive.statssa.gov.za:8282/webview/> (accessed 12.10.15).
- [15] UNEP, 2013. *City-Level Decoupling: Urban Resource Flows and the Governance of Infrastructure Transitions.* United Nations Environment Programme, International Resource Panel.
- [16] UNEP, 2011. *Decoupling natural resource use and environmental impacts from economic growth.* United Nations Environment Programme, International Resource Panel.
- [17] [Wiedenhofer, D., Steinberger, J.K., Eisenmenger, N., Haas, W., 2015. Maintenance and Expansion: Modeling Material Stocks and Flows for Residential Buildings and Transportation Networks in the EU25. *Journal of Industrial Ecology* 19, 538–551.
- [18] Zhang, Y., Yang, Z., Yu, X., 2015. Urban Metabolism: A Review of Current Knowledge and Directions for Future Study. *Environmental Science and Technology* 49, 11247–11263.

Session 5.7: Innovations Driving for Greener Policies and Standards – Assessment, Analysis and Modelling (1)

European Horizontal Standardized Methods for the Assessment of the Sustainability Aspects of Construction Works

Ari ILOMAKI^a, Thomas LÜTZKENDORF^b

^a Confederation of Finnish Construction Industries, Finland, ari.ilomaki@rakennusteollisuus.fi

^b Karlsruher Institut für Technologie (KIT), Germany, thomas.luetzkendorf@kit.edu

ABSTRACT

The significance of the construction and real estate sector for sustainable development is broadly recognized in Europe. Reflecting this recognition, systems for the description, quantification, assessment and certification of sustainable buildings have already been developed in many countries. The European horizontal standardized methods for the assessment of the sustainability aspects of construction works have been developed in CEN/TC 350 "Sustainability of construction works", a committee that has been working already since 2005.

CEN/TC 350 standards provide the basis for carrying out life cycle based environmental, social and economic performance assessments for buildings in a transparent and performance based way. Therefore, e.g. the environment related indicators included in these standards demonstrate the level of environmental performance against the desired functional and technical requirements for a building over its life cycle. Considering sustainability aspects in the design and construction of buildings will motivate manufacturers, contractors and service providers to seek out ways to provide better quality products and services.

The assessment according to the CEN/TC 350 standards at the building level can be used for comparing solutions or choices of a construction project involving different materials and products and creating the most sustainable overall solution.

The paper presents and discusses available standards and outlines current developments.

Keywords: standards, sustainability assessment, life cycle approach

1. INTRODUCTION

For those not already familiar with the European standardisation work in the field of construction works, the Committee for European Standardization (CEN) is the body responsible for developing and overseeing harmonized European construction standards. A little more than a decade ago, CEN/TC 350 group was given a mandate by the European Commission to develop voluntary horizontal standardized methods for the assessment of the sustainability aspects of new and existing construction works (buildings and civil engineering works), as well as standards providing guidance for the development of environmental product declarations of construction products. Part of the progress achieved has already been reported. Figure 1 shows the current work program of CEN/TC 350.

Framework level	EN 15643-1 Sustainability Assessment of Buildings - General Framework [1]			Technical Characteristics	Functionality
	EN 15643-2 Framework for Environmental Performance of Buildings [2]	EN 15643-3 Framework for Social Performance of Buildings [3]	EN 15643-4 Framework for Economic Performance of Buildings [4]		
	prEN 15643-5 Framework for Sustainability Assessment of Civil Engineering Works [5]				
Works level	EN 15978 Environmental Performance of Buildings [6]	EN 16309 Social Performance of Buildings [7]	EN 16627 Economic Performance of Buildings [8]	Service Life Planning – General Principles (ISO 15686-1) [15]	
	prWI028 Sustainability Assessment of Civil Engineering Works [9]				
Product level	EN 15804 Environmental Product Declarations [10]	(see Note below)	(see Note below)	EN ISO 52000 Standard Series on Energy Performance of Buildings [16]	
	CEN/TR 16790 Guid. to EN 15804 [11]	<p>Note: At present, technical information related to some aspects of social and economic performance are included under the provisions of EN 15804 to form part of EPD</p>			
	EN 15942 Comm. Form. B-to-B [12]				
	CEN/TR 15941 [13]				
	CEN/TR 17005 [14]				
			Service Life Prediction (ISO 15686-2) [17], Feedback from Practice (ISO 15686-7) [18], Reference Service Life (ISO 15686-8) [19]		

Figure 1: Work programme of CEN/TC350. (Source Ari Ilomäki, chairman, CEN/TC350)

The standards developed under the framework of CEN/TC350 provide a harmonized European system for the assessment of environmental, social and economic performance of construction works based on a life cycle approach. The standardised application of a life cycle approach means that the assessment of environmental performance presented in EN 15978 is based on the Life Cycle Assessment methodology defined in ISO 14044 and the assessment of economic performance presented in EN 16627 is based on the Life Cycle Costing approach according to ISO 15686-5 methodology. At the same time, the rules for the handling of service life issues are based on the guidance of Service Life Planning described in ISO 15686 standard series]. Further information on the Performance-Based Building concept can be found in [23].

The final goal is to develop and implement a system of an integrated building performance assessment allowing the assessment of the environmental, social and economic performance of a building or constructed asset to be made concurrently and on the same equal footing, in view of its technical quality and functionality / serviceability.

The results of such an assessment help designers, investors or other actors understand the impact a building has on the environment on the one hand, and on the occupants and other users on the other. Social performance assessment as described in EN 16309 includes amongst others the building related aspects that can influence users' health, comfort and safety, as well as aspects related to the resilience of buildings to climate change.

2. A LIFE CYCLE APPROACH TO SUSTAINABILITY ASSESSMENT

2.1 Object of assessment and system boundaries

In this European standardised system of CEN/TC 350, when it comes to the sustainability assessment at the building level, the object of assessment (and therefore the source of life cycle impacts) is the building, including its foundations and external works within the area of the building site. This clarification means that in order to assess the environmental, social and economic performance of a building, the physical system boundary for the assessment excludes impacts of non-building related appliances, since the object of assessment is only the building and not the processes carried out in the building. Non-building related appliances are domestic, commercial and industrial appliances and other non-building related equipment e.g. entertainment electronics, washing machines, refrigerators, cooking appliances and office electronics. The impacts of building related appliances or integrated technical systems are included in the assessment, since they are part of the building

system. This covers e.g. systems for heating, cooling, domestic hot water supply, ventilation and lighting, as well as integrated building automation and controls, including systems for transport of building users, such as elevators and escalators. It is recommended to present and check the completeness of the description of the building and its life cycle.

Figure 2 shows that the fulfillment of the technical and functional requirements is a prerequisite. What is new for the building owners/clients is that they should be able to provide requirements for the environmental, economic and social performance already in the task formulation (client's brief).

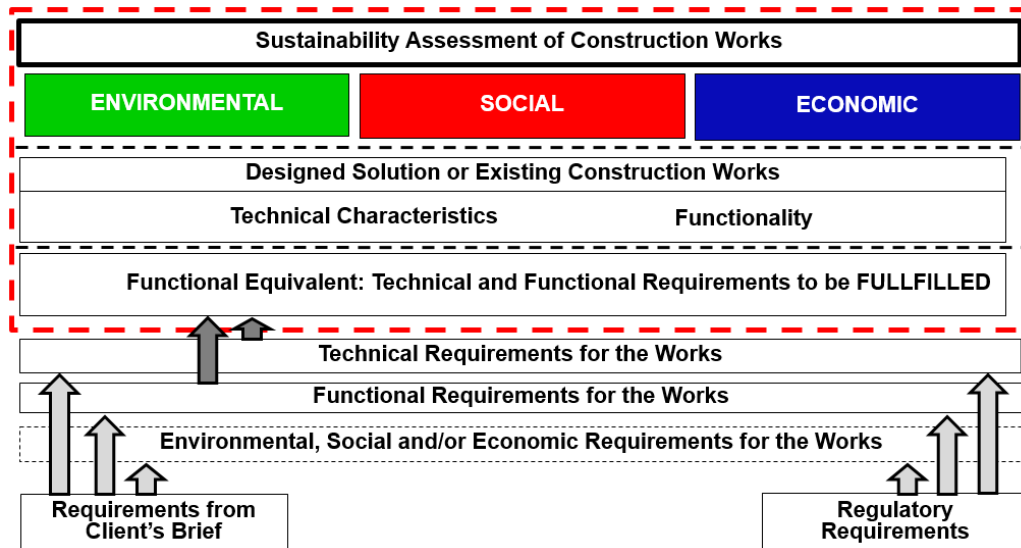

Figure 2: Concept of sustainability assessment. (Source Ari Ilomäki, chairman, CEN/TC350)

The suite of standards within CEN/TC 350 is only dealing with the analytical part of the building assessment system, and not with the valuation part. For this reason, these standards do not provide valuation methods and do not set levels, classes or benchmarks for any measure of performance. It is clear that appropriate valuation methods for interpreting the results are also needed. However, due to their nature being always subjective to value choices and "political" decisions, the development of valuation methods has been left to the developers of rating tools or national assessment systems. In recognition of the need for global guidance on this matter, a new standardization initiative within the scope of ISO TC 59 SC 17 WG2 deals with the principles guiding the development and application of benchmarks.

2.2 Performance based approach with the basket of indicators

In order to have a transparent and truly performance based European system for assessing sustainability, CEN/TC350 standards have only taken into account performance aspects and impacts that can be expressed with quantifiable indicators. The environmental and economic indicators used in EN 15978 and EN 16627 are purely quantitative, while the indicators used in EN 16309 for the assessment of social performance of buildings can be considered semi-quantitative. These quantifiable indicators are defined in the framework level standards (as indicated in Figure 1).

The determination of characteristic values for the indicators at the building level requires that this information is first made available at the level of construction products. The use of identical indicators for buildings and construction products is therefore required.

The indicators are derived from protected goods (areas of concern). In the case of environmental performance, the protection goals are the "protection of the ecosystem" and the "protection of resources". Indicators measuring the impacts on the global environment (e.g., global warming potential) are used among others.

Figure 3 shows environmental indicators used in the standards

<p>1) Indicators for environmental impacts:</p> <ol style="list-style-type: none"> 1. Global warming potential 2. Destruction of the stratospheric ozone layer 3. Acidification of land and water resources 4. Eutrophication 5. Formation of ground level ozone 6. Abiotic depletion potential (fossil fuels) 7. Abiotic depletion potential (elements)
<p>2) Indicators for use of resources:</p> <ol style="list-style-type: none"> 8. Use of non-renewable primary energy 9. Use of renewable primary energy 10. Use of non-renewable primary energy resources used as raw materials 11. Use of renewable primary energy resources used as raw materials 12. Use of secondary materials 13. Use of non-renewable secondary fuels 14. Use of renewable secondary fuels 15. Net use of freshwater resources
<p>3) Indicators for other environmental information:</p> <ol style="list-style-type: none"> 16. Components for re-use 17. Materials for recycling 18. Materials for energy recovery 19. Non-hazardous waste to disposal 20. Hazardous waste to disposal 21. Radioactive waste to disposal 22. Exported energy

Figure 3: Basket of environmental indicators in EN 15978. (Source Ari Ilomäki, chairman, CEN/TC350)

2.3 Consistency, modularity and transparency at different levels

Figure 4 shows the interactions between the building and the product level and explains the subdivision of the life cycle into modules A-C, including an additional special module D. The same rules, modules and set of appropriate indicators are employed for products and construction works in CEN/TC350 standards, e.g. EN 15978 for the building level and EN 15804 for the product level. This allows the product-related environmental performance information declared in an EPD (Environmental Product Declaration) according to EN 15804 to be applied for the assessment of the environmental performance of construction works.

Furthermore, Module D is used to demonstrate on building level the net benefits (avoided impacts, avoided primary material use, avoided energy use and avoided waste generation) beyond the building life cycle, resulting from recyclability, recoverability and reusability of construction materials and products. Module D, in the sense of a recycling potential, must be separately reported as additional information.

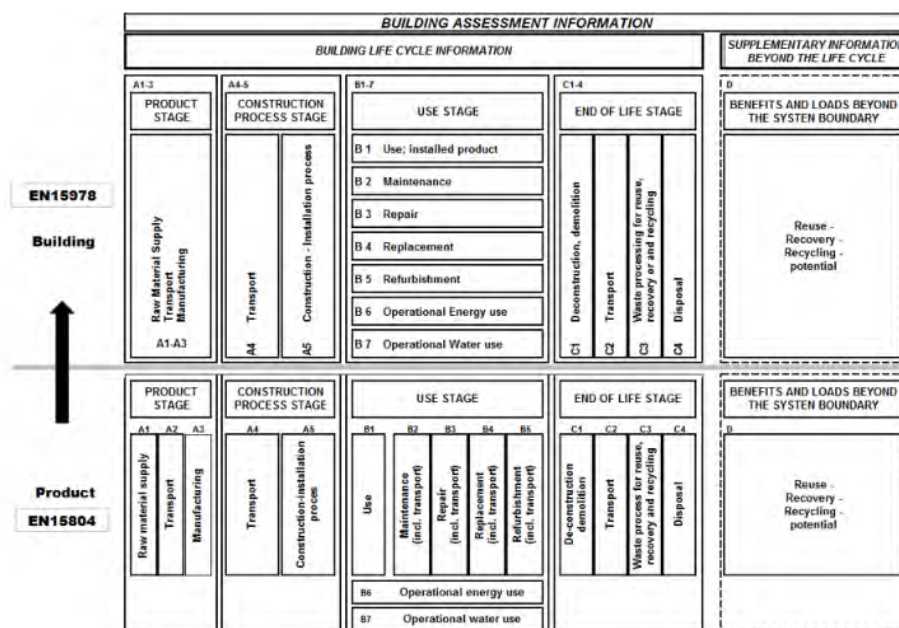

Figure 4: Building life cycle and modular information. (Source Ari Ilomäki, chairman, CEN/TC350)

The assessment according to EN 15978 can be used for comparing solutions or choices involving different materials and products at the building level.

2.4 Technical and functional requirements as a prerequisite

To effectively communicate the assessment results and comparisons of those results between alternative design options in the design stage or between finished buildings, a "fair basis" must be always secured. For this purpose, the concept of "functional equivalent" was established in the CEN/TC 350 standards. In addition to the reference area, also the type and intensity of use must be specified among others. The functional equivalent allows the assessment results to be provided in a systematic and comparable way. Communication of the assessment results for the environmental performance, social performance and economic performance of a building follows the same requirements.

The functional equivalent should be derived from the requirements for technical performance and functional performance of buildings to form the basis for comparison. The technical and functional performance requirements can include, for example, requirements for the structural safety, fire safety, health and comfort, security, adaptability, de-constructability, durability and required service life of a building. These requirements become fixed when they are prescribed in the client's brief or in the project specification. This means that each design option must fulfil these technical and functional performance requirements set for the building.

3. SUMMARY AND OUTLOOK

The series of standards developed under CEN TC 350 provide the basis for assessing the environmental, social and economic performance of construction works – or, in a broader sense, they form the basis for a uniform sustainability understanding in the construction and real estate sector, as well as for assessing the contribution of buildings to sustainable development. The standards correspond to the European context. They are interacting with the results of ISO TC 59 SC17, but are in part more detailed. In addition to technical and functional quality requirements, clients and investors are advised to integrate their objectives to be achieved with regard to an environmental, **economic and social performance from the beginning into the description of the project (client's brief)**. When it comes to the developers of the next generation building sustainability assessment and certification systems, it is now possible for them to orient their work more strongly towards the state of standardization. This is a way of promoting the process of streamlining the content of such systems, while maintaining their independence.

CEN/TC 350 standards encourage freedom to design for better environmental, economic and social performance and support innovation. They can also be used to tackle related macro-level political targets.

The experts working within the framework of CEN TC 350 are currently discussing possibilities for further refinement and development. This concerns the development of B2C communication formats, the specification of scenarios for deconstruction and recycling, the handling of generic data in early design phases as well as issues related to the consideration of impacts on the economic value.

The authors would like to thank all those who have actively participated so far, and will participate in the future, in the standardization process.

REFERENCES

- [1] EN 15643-1:2010 Sustainability of construction works – Sustainability assessment of buildings – Part 1: General Framework.
- [2] EN 15643-2:2011 Sustainability of construction works — Assessment of buildings — Part 2: Framework for the assessment of environmental performance.
- [3] EN 15643-3:2012 Sustainability of construction works — Assessment of buildings — Part 3: Framework for the assessment of social performance.
- [4] EN 15643-4:2012 Sustainability of construction works — Assessment of buildings — Part 4: Framework for the assessment of economic performance.
- [5] [prEN 15643-5:2016 Sustainability of construction works – Sustainability assessment of buildings and civil engineering works - Part 5: Framework on specific principles and requirements for civil engineering works.
- [6] EN 15978:2011 Sustainability of construction works – Assessment of environmental performance of buildings – Calculation method.
- [7] EN 16309:2014 Sustainability of construction works – Assessment of social performance of buildings – Calculation methodology.
- [8] EN 16627:2015 Sustainability of construction works – Assessment of economic performance of buildings – Calculation methods.
- [9] prWI028 Sustainability of construction works – Sustainability assessment of civil engineering works – Calculation methods.
- [10] EN 15804+A1:2013 Sustainability of construction works – Environmental product declarations – Core rules for the product category of construction products.
- [11] CEN/TR 16790:2016 Sustainability of construction works – Guidance for the implementation of EN 15804.
- [12] EN 15942:2011 Sustainability of construction works - Environmental product declarations - Communication format business-to-business.
- [13] CEN/TR 15941:2011 Sustainability of construction works – Environmental product declarations - Methodology for selection and use of generic data.
- [14] CEN/TR 17005:2016 Sustainability of construction works - Additional environmental impact categories and indicators - Background information and possibilities - Evaluation of the possibility of adding environmental impact categories and related indicators and calculation methods for the assessment of the environmental performance of buildings.
- [15] ISO 15686-1:2011 Buildings and constructed assets – Service life planning – Part 1: General principles and framework.
- [16] EN ISO 52000 standard series: Energy performance of buildings.
- [17] ISO 15686-2:2012 Buildings and constructed assets – Service life planning – Service life prediction procedures.
- [18] ISO 15686-7:2016 Buildings and constructed assets – Service life planning – Performance evaluation for feedback of service life data from practice.
- [19] ISO 15686-8:2008 Buildings and constructed assets – Service life planning – Reference service life and service life estimation.
- [20] ISO 14044:2006 Environmental management – Life cycle assessment – Requirements and guidelines.
- [21] ISO 15686-5:2008 Buildings and constructed assets – Service life planning – Life cycle costing.
- [22] ISO 15686 standard series: Buildings and constructed assets – Service life planning – Parts 1 – 10.
- [23] Lützkendorf, T., Speer, T., Szigeti, F., Davis, G., Le Roux, P., Kato, A., & Tsunekawa, K. (2005). A comparison of international classifications for performance requirements and building performance categories used in evaluation methods. *Performance based building*, 61-80.
- [24] Ilomäki, A., Lützkendorf, T., & Trinius, W. (2008). Sustainability Assessment of Buildings in CEN/TC350 Sustainability of Construction Works. In *Proceedings of the World Conference SB08*.

Life Cycle Energy and GHG Emissions Reduction of Retrofit Options for Existing Dwelling Stock

Seongwon SEO^a, Greg FOLIENTE^b, Zhenggen REN^c

^a Urban Panaceas, Australia, seongwon.seo@csiro.au

^b University of Melbourne, Australia

^b nBLue Pty Ltd, Australia, gfoliente@nbluesystems.com

^c CSIRO, Australia, zhengen.ren@csiro.au

ABSTRACT

Serious carbon mitigation in the building sector requires full consideration of life cycle energy consumption (both embodied and operating energy), and their related greenhouse gas (GHG) emissions, over the life span of the dwelling stock. We analyse herein the life cycle energy and related GHG emissions of the pre-2005 residential housing stock in the Greater Melbourne Area (GMA), comprising of 31 municipalities or Local Government Areas (LGAs), considering various retrofit options that range from relatively cheap and easy (e.g., draught sealing) to relatively expensive (e.g., double glazing of windows). Operational energy savings are calculated based on representative performance of energy-rated detached and semi-detached dwellings using the Australian residential rating scheme (i.e., a bottom-up approach), while the embodied energy and GHG emissions are calculated using a multi-regional input-output analysis (i.e., a top-down approach). If all the buildings are improved to the level of a 6-energy rated dwelling across GMA, we can save about 25.5 TWh/year in heating and cooling energy, which translates to 6.25 million tons of GHG reduction every year. However, the retrofit program will consume 4.75 TWh of embodied energy or 1.89 million tons of embodied GHG emissions, which is equivalent to 50% of the annual heating and cooling energy or 81% of the operational GHG emissions due to heating and cooling of dwellings. The energy reduction in building operations will remain to be the dominant driver for retrofit, but the contribution of the embodied impacts cannot, and should not, be ignored.

Keywords: urban regeneration, climate mitigation, residential buildings.

1. INTRODUCTION

The minimum energy efficiency requirement in Australian housing has only been in place since 2005 (minimum of 5-star rating then, and now 6-star rating from 2011 in the State of Victoria). The Building Code of Australia (BCA) administers compliance through modelling (using an approved house energy rating software such as AccuRate) and energy efficiency rating under the National House Energy Rating Scheme (NatHERS)]. Existing residential buildings that have been built before 2005 do not comply with the current building energy efficiency standards, and thus have significant potential to cut energy use and enable the government to achieve its energy and GHG reduction goals. This has become even more important now with the recent global agreement to scale up the implementation of ambitious actions towards the "below 1.5 or 2°C" pathways (known as the COP21 Paris Agreement).

Various retrofit strategies have been recommended to reduce demand and increase energy efficiency (e.g. improving the thermal energy performance of building envelope [Horne and Hayles, 2008]). But many studies on energy efficiency measures to improve existing dwellings have only focused on a specific retrofit measure, or on a single or several building types rather than the whole stock at urban or regional scale aggregated from individual dwelling types (i.e. bottom up approach). Also, most have exclusively focused on operational energy use in buildings. While it is recognised that many retrofit packages can effectively reduce energy and GHG emissions during their service life, the embodied energy and GHG emissions of different retrofit options are usually ignored. The production of building products and technologies for retrofit requires energy and generates corresponding GHG emissions in their manufacture, transportation and installation. These may contribute a significant portion in the total life cycle energy and GHG emissions in buildings, and thus, should be included in the analysis and decision-making. Without the whole life cycle considerations of environmental impacts, building designers, developers or policy makers can make sub-optimal or potentially even detrimental decisions.

This paper examines the environmental impacts (energy and GHG) and the economic aspects of different retrofit options for pre-2005 dwellings in the Greater Melbourne Area (GMA), comprising of 31 municipalities or Local Government Areas (LGAs), considering both building operations and embodied impacts.

2. METHODOLOGY

Two different methodological approaches are integrated in this study: a top-down Input-Output (IO) analysis, and a bottom-up approach of energy performance assessment based on results of a building energy modelling software.

Leontief's IO method is employed to quantify the embodied environmental impacts (energy and GHG emissions) due to the building works and new/replacement products to upgrade or retrofit existing dwelling stocks. With combined national energy and GHG emission accounts by industry sectors, unit energy consumption and GHG emissions are quantified based on unit monetary based economic activities (per million \$). Then, the benefits due to improved energy performance of residential buildings are quantified using the energy performance data for different energy-rated houses. In this analysis, the energy and GHG reductions are considered only for heating and cooling of buildings (as covered in the NATHERS rating scheme), and other end-use categories (such as plug-in appliances) are not taken into account.

2.1 Embodied impacts (energy and GHG emissions) for retrofit

Embodied impacts, which include raw material extraction, material manufacture, processing and transport to the site, were quantified using the comprehensive analysis based on IO datasets. In the IO data table, the total economic output of industry sector i is the sum of intermediate input of each industry sector to satisfy the intermediate demand and final product to satisfy the final demand of industry i . In the IO table, if import m is excluded in the endogenous set by deducting it from the column direction as a lump sum, then the domestic output can be expressed as:

$$X = \{I - (I - M)A\}^{-1} \{(I - M)F_D + F_E\}$$

Equation 1

where, X is the domestic total output of product (\$/year); $\{I - (I - M)A\}^{-1}$ is the Leontief competitive import type inverse matrix, which captures the supply chain inputs to satisfy one unit of final demand in monetary value; I is the identity matrix; A is the intermediate input coefficient (a_{ij}) (input coefficient from industry i to j); M is the import coefficient diagonal matrix (import coefficient, $m_i = M_i/C_i$); C_i is the domestic demand for product i (\$/year); F_D is the domestic final demand value (\$/year); F_E is the export value (\$/year).

Total energy intensities are then calculated by multiplying the direct energy intensity matrix with the Leontief inverse matrix (Equation. 1) of the corresponding IO table. Embodied energy (or GHG) in a region can be calculated by multiplying total energy (or GHG) intensity with a final demand including export of a region.

With this energy intensity of industry i and Equation. (1), we can obtain the direct and total energy consumption of industry i . Embodied energy and GHG, which is the total energy requirement (or GHG emissions) of the economy directly and indirectly in supporting one unit of monetary value final demand, can be quantified by the following:

$$EE_k = E_i \cdot \{I - (I - M_k)A\}^{-1} \quad \text{or} \quad EGHG_k = (E_i \cdot C_j) \cdot \{I - (I - M_k)A\}^{-1}$$

Equation 2

where, EE_k is the embodied energy intensity of industry k (MJ/\$); E_i is the direct energy requirement per dollar worth of final demand for industry k (MJ/\$). Similarly, embodied GHG intensity of each industry k ($tonCO_2eq/\$$), $EGHG_k$, is obtained by multiplying the GHG intensity of energy j ; $EGHG_k$ is the embodied GHG intensity of industry k ($ton CO_2eq/\$$); C_j is the GHG conversion coefficient of energy j .

2.2 Recurrent embodied energy and GHG emissions

The energy consumption and GHG emission associated with repetitive product replacement or related action(s) **during the building's service life is called the** recurring embodied energy or carbon. This is estimated using the following equation:

$$EI_{REC} = \sum_{Mat=1}^M \left(\frac{SL_{Bldg}}{SL_{Mat}} - 1 \right) \times (Q_{Mat} \times EI_{Mat})$$

Equation 3

where, EI_{REC} is the recurrent impact (embodied energy in GJ or embodied carbon in ton CO_{2eq}); SL_{Bldg} is the service life of building (year); SL_{Mat} is the service life of material/product (year); Q_{Mat} is the quantity of material/product to achieve an improved energy rating (A\$m); EI_{Mat} is the embodied intensity of material (embodied energy in GJ/\$m) and embodied carbon in ton CO_{2eq}/\$m which can be obtained by Equation. (2)).

2.3 Operational energy and GHG emissions

2.3.1 Building stock in the greater melbourne area

Melbourne is the capital of Victoria, which has a population of about 4.1 million. The Australian Bureau of Statistics (ABS) shows that Greater Melbourne is one of the largest and fastest growing capital cities in Australia. From 1973 to 2013, Melbourne has increased its population by 62%. More than 70% of Victorians live in GMA, which consists of 31 LGAs out of a total of 79 in the whole state.

Five-star minimum energy requirement was introduced in 2005; the minimum requirement was raised to 6-star from 2011 in Victoria. In GMA, there are 1.43 million dwellings. More than 96% of the dwelling stock were built before the introduction of the minimum 5-star rating requirements. The average energy efficiency rating for existing dwellings is 1.57 stars for buildings built prior to 1990 and 3.14 stars for those built between 1991 and 2005. We used these survey data as the base case for quantifying the heating/cooling energy for existing dwelling stocks in GMA.

In GMA's existing dwelling stock, detached houses represent the most dominant building type, with more than 90% share, and semi-detached houses with 8.8% share of the total stock. Compared to these two, others such as flats or apartments show a relatively small part (1.6% of the total stock, although we note that this is currently a growing category). Thus, this study is focused on the upgrade or retrofit of detached and semi-detached houses which were built prior to 2005.

2.3.2 Prototype of existing buildings and energy retrofit options

The national average floor sizes of 114 m² and 57 m² are applied for detached and semi-detached, respectively. The average floor areas of detached and semi-detached that were built between 1991 and 2005 are larger than those of pre-1990 dwellings: 182 m² for detached and 132 m² for semi-detached. The annual energy consumption and GHG emissions due to heating and cooling for existing dwelling stocks in the GMA are quantified as follows:

$$ERG_{OPR} = \sum_{i=1}^4 \left(\left(\frac{ERG_{i,h}}{COP_{i,h}} + \frac{ERG_{i,c}}{COP_{i,c}} \right) \times HH_i \right) \text{ or } GHG_{OPR} = \sum_{i=1}^4 \left(\left(\frac{ERG_{i,h}}{COP_{i,h}} \times cf_k + \frac{ERG_{i,c}}{COP_{i,c}} \times cf_j \right) \times HH_i \right)$$

Equation 4

where i is the index of the dwelling prototype; $ERG_{i,h}$ (MJ/m²/year) and $ERG_{i,c}$ (MJ/m²/year) are the space heating and cooling energy requirement for building type i calculated by the AccuRate software; HH_i is the floor area of dwelling type i in m², which sum up over the 31 LGAs in GMA. GHG_{OPR} is the total GHG emissions due to heating and cooling energy requirements in GMA in ton CO_{2eq}; COP_h and COP_c are the coefficient performance of the heating and cooling systems, which are chosen from the AccuRate database for this study; cf_k is the GHG emission factor of energy type k .

The retrofit scenarios considered ranged from relatively cheap to expensive measures. By grouping different measures based on costs and difficulties of installation, a total 16 retrofit cases (4 cases for energy improvements x 2 types of dwelling x 2 different age group) are set up to improve energy efficiency of existing dwellings from 3 to 6 Stars (Table 1).

3. RESULTS AND DISCUSSION

3.1 Operational energy and GHG reduction

The heating and cooling energy demand for existing (pre-2005) dwelling stock in GMA is shown in Figure. 1(a); the total heating and cooling energy consumption is 34.9 TWh per year. Most of this energy demand is for detached houses, which accounts for more than 95% of the total. Semi-detached houses account for less than 5% of the total demand.

As intended by the energy efficiency rating scheme, the heating/cooling energy demand decreases as the energy rating increases from 3 to 6 stars. If the existing dwelling stock is upgraded from the current business-as-usual (BAU) average energy performance level into 3 stars (as shown in the 2nd bar in Figure.1(a)), 12.6 TWh of heating/cooling energy can be saved. If the existing BAU dwelling stock is upgraded to 4 stars, 16.4 TWh of heating and cooling energy load can be saved. This represents a 52% energy reduction from the BAU case (before retrofit). Deeper energy retrofits (i.e. up to 5- and 6-star levels) bring further reductions, Figure 1(a).

The associated GHG emissions due to heating and cooling for dwelling stock in GMA is estimated at 8.57 million tons of CO₂eq per year (Figure.1(b)). As in the total energy demand, detached houses contribute more than 95% of the total GHG emissions. Semi-detached house account for only 4.7% of the total (0.4 million tons of CO₂eq). With all residential buildings built after 2005 in GMA rated at 6 stars (minimum), if we assume that all existing dwelling stock is upgraded from 3 to 6 stars, then the total GHG reduction can be up to 6.25 million tons of CO₂eq (i.e., a 73% reduction).

For each of the local governments in GMA, Figure. 2 shows the energy and GHG emissions reduction due to the upgrade of existing dwellings to 6 stars.

	Stocks built Pre 1990								Stocks between 91~2005							
	Detached				Semi-detached				Detached				Semi-detached			
Average energy star for BAU	1.5								3.1							
Floor Area (m ²)	114				57				182				132			
External wall (m ²)	139				55				135				126			
Scenario	3	4	5	6	3	4	5	6	3	4	5	6	3	4	5	6
Draught sealing (window, door, fan etc.)	√	√	√	√	√	√	√	√	-	√	√	√	-	√	√	√
Drapes/pelmets/external blind	√	√	√	√	√	√	√	√	-	√	√	√	-	√	√	√
Ceiling insulation	√	√	√	√	√	√	√	√	-	√	√	√	-	√	√	√
Wall insulation R	5.0	6.0	6.0	6.0	0.5	4.0	4.0	6.0	6.0	4.0	6.0	6.0	2.5	6.0	6.0	
Double glazed	0.5	3.0	3.0	4.0	-	-	0.5	1.5	1.0	3.0	3.0	3.0	1.5	3.0		
	-	-	√+	√*	-	-	-	-	-	-	√+	√*	-	-	-	√*

+ timber/uPVC double glazed (clear 6mm air gap)
* timber/uPVC double glazed (clear 11mm argon gap)

Table 1: Prototype of residential buildings and retrofit options into higher energy ratings.

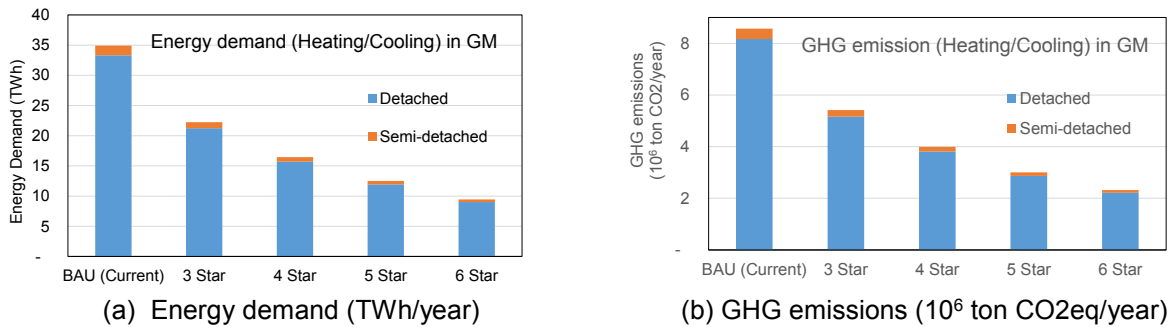

Figure 1: Heating/cooling energy & GHG emissions of existing dwellings for energy improvement

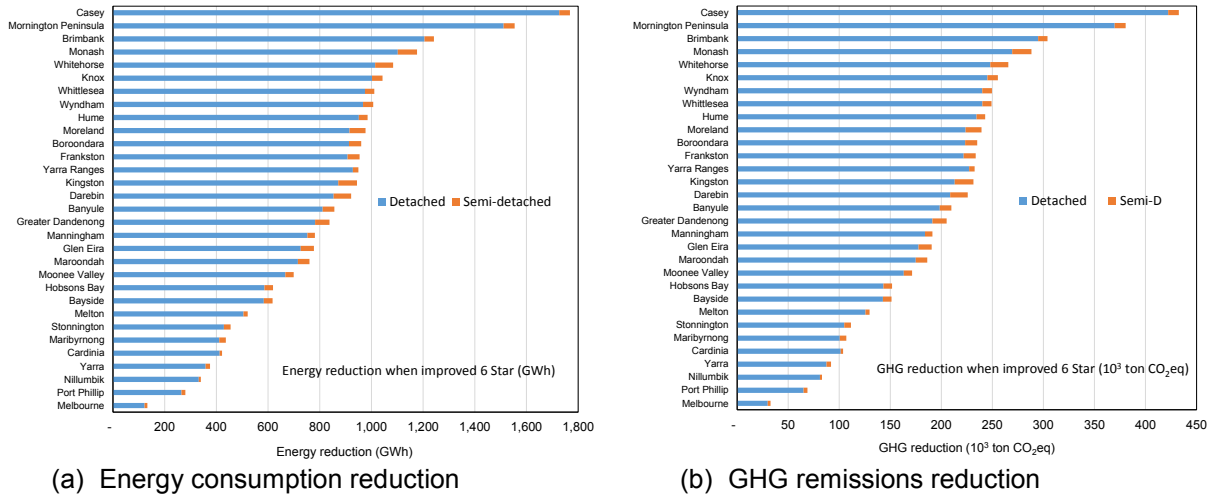

Figure 2: Energy and GHG emissions reduction by LGA due to the increase of energy efficiency of existing dwellings to an equivalent 6-star rated dwelling in GMA

3.2 Embodied energy and GHG emission impacts

Figure 3 shows the embodied energy and GHG emissions due to the upgrade of existing dwelling stocks to 3, 4, 5 or 6 stars. To retrofit existing dwellings in GMA into an equivalent 3-star house, a total of 1,523 GWh embodied energy is required. This is the combined initial and recurrent embodied energy over its assumed 25-year life span. The initial embodied energy, which accounts for 68% of the total, is the upfront embodied energy required to upgrade the existing dwellings into 3-star buildings, and the rest (471 GWh or 32% of the total) is the embodied energy required to maintain that performance level over the next 25 years (i.e. the recurrent embodied energy). Similar to operational heating/cooling energy demand, most of the embodied energy come from retrofitting of detached houses (in this case, 98% of the total).

Similar patterns are observed when retrofitting to meet 4, 5 or 6-star efficiency levels. In the 6-star retrofit case, the total embodied energy required is 4,748 GWh, which is 212% more than the energy required for the 3-star retrofit case. But in the 6-star retrofit case, the initial embodied energy is 75% while the recurrent is 25% of the total.

As shown Figure.3(b), the embodied carbon reductions follow a similar trend to those for embodied energy.

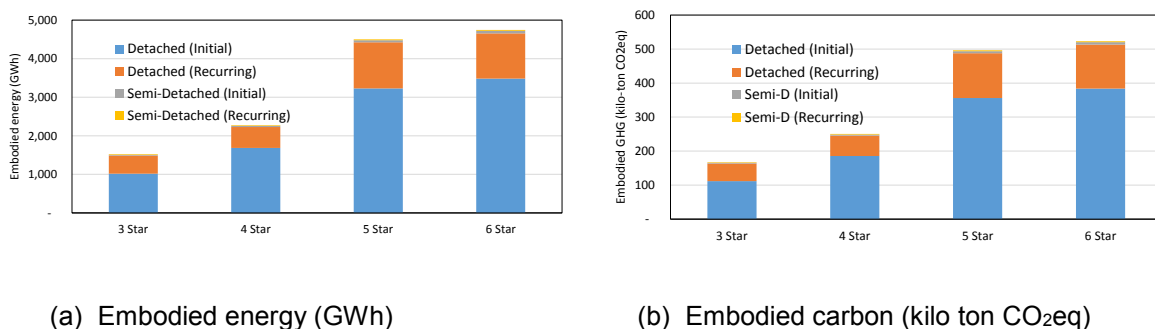

Figure 3: Embodied energy and GHG emissions due to retrofit of existing dwellings to meet 3, 4, 5 or 6-star efficiency levels

3.3 Life cycle impacts of energy retrofits in existing dwellings

Life cycle energy combines the operational heating/cooling energy with the embodied energy for the assumed life span of the retrofitted buildings. Figure. 4 shows the decrease in operating energy with increasing star-rating compared to the BAU, but accordingly also the increase in embodied energy. For example, retrofitting of existing dwellings to 3-star level results in a 36% heating/cooling energy reduction (12.6 TWh); at 6-star level, the reduction is to 73% less than the BAU case. Correspondingly, the embodied energy increases by 1.53 TWh for the 3-star retrofit and up to 4.7 TWh for the 6-star retrofit. These embodied values are equivalent to 12 to 20% of the annual operational heating/cooling energy of the whole dwelling stock in GMA.

Embodied carbon follows a similar pattern to that for embodied energy. The existing dwellings in GMA that were built before 2005 release 8,571 kilo tons of CO₂eq for heating/cooling. By improving the energy efficiency of the existing stock (up to 6-star level), GHG emissions can be reduced up to 73% (6,252 kilo tons of CO₂eq). However, the embodied carbon to install and maintain the retrofit packages for existing dwellings increases – e.g. to 5-star level, the embodied carbon goes up to 32% of annual operational heating/cooling carbon emissions.

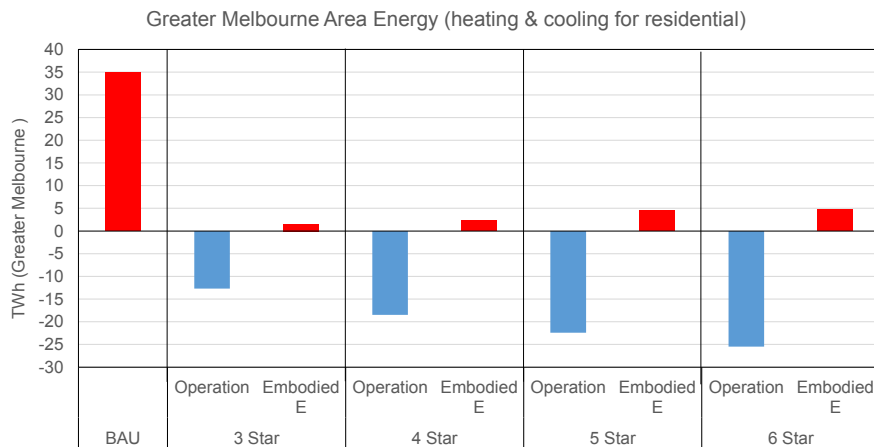

Figure 4: Life cycle energy to increase energy efficiency of existing dwellings in GMA

3.4 Cost analysis of energy retrofits of existing dwellings

The results of retrofit cost analysis and energy saving for 3-star to 6-star retrofit levels, at each LGA, are shown in Figure.5. Each bell shape represents energy savings (left, in \$million) vs retrofit cost (right, also in \$million) from a dwelling stock with 3-star performance level to a stock equivalent with a 6-star level. The City of Melbourne (top), with a predominance of flats and apartments, has the least cost for energy saving and upfront and maintenance cost of the 31 local governments in GMA.

At the bottom, the City of Casey shows the largest amount of heating and cooling energy savings and upfront/maintenance costs. Interestingly, the Cities of Hume, Melton, Whittlesea and Wyndham show high upfront costs but not much energy saving for heating and cooling. These are all the fastest growing local governments in Victoria (7.8% for Wyndham, 5.6% for Melton and Whittlesea, and 2.6% for Hume). Dwelling stock built between 1990 and 2005 take a relatively high proportion of the total stock: 62% in Melton, 52% in Wyndham, 33% in Hume and 30% in Whittlesea.

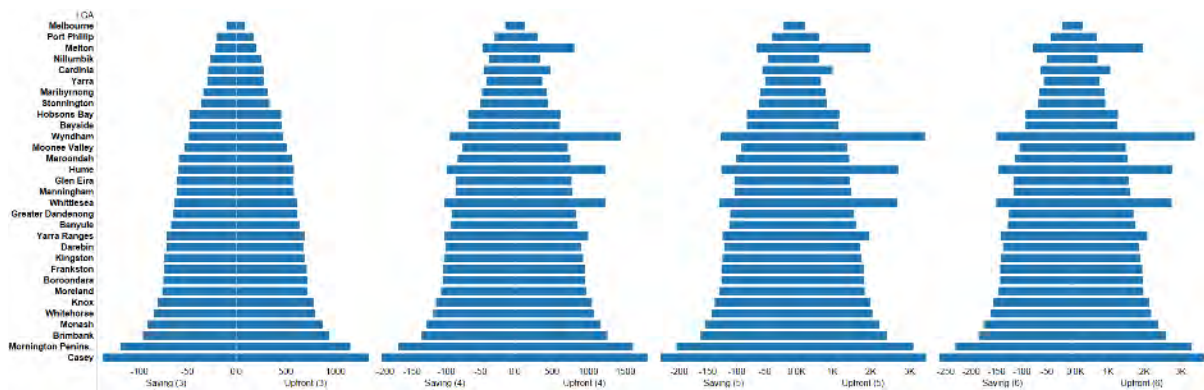

Figure 5: Cost balance between upfront cost (\$million) and benefits (\$million) due to energy upgrading of existing dwellings in each local government in GMA

4. CONCLUSIONS

We presented a combined bottom-up and top-down methodology that investigated the life cycle energy and GHG emissions of the residential housing stock for each of the 31 LGAs in GMA, considering various retrofit options that range from relatively cheap and easy (e.g., draught sealing) to relatively expensive (e.g., double glazing of windows). The operational energy savings were based on representative energy ratings for detached and semi-detached dwellings, while the embodied energy and GHG emissions were calculated using input-output analysis.

The total heating/cooling energy for the pre-2005 dwelling stock can be reduced by 12.6 TWh to 25.4 TWh by wholesale retrofit of the stock to 3-star and 6-star efficiency levels, respectively. These are equivalent to 36% to 73% of energy reduction compared to the BAU case, and come mostly from detached houses, which account for more than 95% of the total reduction.

The embodied energy associated with the retrofit package to improve the stock to a 5-star level is more than 36% of the annual heating and cooling energy for existing dwellings in GMA. If all the buildings are improved to the level of a 6-energy rated dwelling across GMA, savings are 25.5 TWh/year in heating and cooling energy, which translates to 6.25 million tons of GHG reduction every year. However, the retrofit program will consume 4.75 TWh of embodied energy or 1.89 million tons of embodied GHG emissions, which is equivalent to 50% of the annual heating and cooling energy or 81% of the operational GHG emissions due to heating and cooling of dwellings.

Although energy savings during building operations will likely remain to be the main driver for retrofit, the contribution of the embodied impacts cannot, and should not, be ignored. This will only likely grow in importance in the coming years as the implementation of net-zero (operating) energy and emissions concepts become more commonplace. Urban decision makers, at individual LGAs or across the metropolitan area, where to focus and select their most cost-effective options to contribute to the global efforts towards the "below 1.5 or 2°C" future climate pathways.

REFERENCES

- [1] COAG (2009), National Strategy on Energy Efficiency, Council of Australian Governments, Canberra.
- [2] Cohen, S., C. Goldman, J. Harris (1991) Energy savings and economics of retrofitting single-family buildings, *Energy and Buildings*, 17, pp. 297–311.
- [3] Horne, R. and C. Hayles (2008) Towards global benchmarking for sustainable homes: an international comparison of the energy performance of housing, *Journal of Housing and the Built Environment*, 23 (2), pp. 119–130
- [4] Al-Ragom F (2003). Retrofitting residential buildings in hot and arid climates. *Energy Conversion and Management*, 44 (14), 2309-2319.
- [5] Verbeeck, G. and H. Hens (2005) Energy savings in retrofitted dwellings: economically viable *Energy and Buildings*, 37, pp. 747–754
- [6] ABS (2006) Australian and New Zealand Standard Industrial Classification (ANASIC) (revision 2.0) (1292), Australian Bureau of Statistics, Canberra.
- [7] SoV (2015) Metropolitan Melbourne, State of Victoria, (retrieved from <http://www.liveinvictoria.vic.gov.au/living-in-victoria/melbourne-and-regional-victoria/melbourne#.VVBJBPmq90> on 11 May, 2015).
- [8] Dunford, M.A., Power, L. & Cook, B. (2014) National Exposure Information System (NEXIS) Building Exposure - Local Government Area (LGA). Geoscience Australia, Canberra. <http://dx.doi.org/10.4225/25/5420C777D595B>.
- [9] Sustainability Victoria (2010) On-Ground assessment of the energy efficiency potential of Victorian Homes, Sustainability Victoria (276p.).
- [10] ABS (2011) Census of Population and Housing: Characteristics of Aboriginal and Torres Strait Islander Australians, Australian Bureau of Statistics, Australia, Cat. No. 2076.0, Canberra.
- [11] Ren, Z. Paevere, P. and McNamara, C. (2012) A local-community-level, physically-based model of end-use energy consumption by Australian housing stock, *Energy Policy*, 49, 586-596.

Renewable Energy Technologies: Economic Analysis Tool (RET-EAT) for Turkey

Oguz Kursat KABAKCI^a, Burak HOZATLI^b, Korkmaz GÜL^c, Nilay ÖZELER KANAN^d, Aslı KARABACAK^e, Uygur KINAY^f

^a Ministry of Energy And Natural Resources, Turkey, okabakci@yegm.gov.tr

^b Ministry of Environment and Urbanization, Turkey, burak.hozatli@csgb.gov.tr

^c Ministry of Energy And Natural Resources, Turkey, kgul@yegm.gov.tr

^d Yüzüncüyıl University, Turkey, nilayozelerkanan@yyu.edu.tr

^e UNDP Turkey, Turkey, asli.karabacak@undp.org

^f Ministry of Environment and Urbanization, Turkey, asli.karabacak@undp.org

ABSTRACT

Turkey has developed legislation to improve energy efficiency in buildings and promote the uptake of renewable energy sources (RES). The Renewable Energy Technologies Economic Analysis Tool is developed to assist building designers and developers. This tool aims promoting and enhancing the effective and rational utilization of renewable energy resources in buildings and thereby to reduce the final external energy consumption and associated greenhouse gas (GHG) emissions in the buildings sector of Turkey. For this purpose, the tool aims to demonstrate the feasibility and benefits of renewable energy technologies (RET) in a more quantitative and comparable manner by:

- Calculating the energy savings potential, economic and environmental benefits from RET for buildings,
- Calculating associated investment costs of the renewable energy technologies for economic analysis and also to check if it complies with the minimum investment costs of the current regulations and bylaws of Turkey,
- Comparing possible RET implementation scenarios and base building scenarios.

Keywords: renewable energy technologies, buildings

1. INTRODUCTION

As populations expand, living standards improve and consumption rises, total global demand for energy is expected to increase by 21% by 2030. At the same time, growing concerns over climate change are prompting governments worldwide to seek ways to supply energy while minimizing greenhouse gas emissions and other environmental impacts. Renewable energy benefits therefore play a critical role in informing policy decisions and tipping the balance in favor of low-carbon investments. Renewable energy resources are inexhaustible and offer many environmental benefits compared to conventional energy sources. Each type of renewable energy also has its own special advantages that make it uniquely suited to certain applications. Turkey has developed legislation to improve energy efficiency in buildings and promote the uptake of renewable energy sources (RES). According to current regulation in Turkey, renewable energy technologies and cogeneration system use should be analysed for new buildings which are larger than 20.000 m² and it should be implemented equal at least % 10 of total **construction cost. To assist building designers and developers meet their obligations, developing of “Renewable Energy Technologies Economic Analysis Tool (RET-EAT)”, which will identify the feasibility of technology options, and evaluate the economic, environmental and efficiency benefits of technologies and their combinations.**

The RET-EAT is developed to promote and enhance the effective and rational utilization of renewable energy resources in buildings and thereby to reduce the final external energy consumption and associated greenhouse gas (GHG) emissions in the buildings sector of Turkey. For this purpose, the tool aims to demonstrate the feasibility and benefits of renewable energy technologies (RET) in a more quantitative and comparable manner by:

- Calculating the energy savings potential, economic and environmental benefits from RET for buildings,
- Calculating associated investment costs of the renewable energy technologies for economic analysis and also to check if it complies with the minimum investment costs of the current regulations and bylaws of Turkey,

- Analyzing possible RET implementation scenarios and base building scenarios.

Two different calculation approaches with different data requirements are used in the tool:

- The Detailed Approach requires hourly inputs of different forms of energy demand (space heating, space cooling, domestic hot water, and electricity), which are exogenous user-inputs obtained through the use of a third party software.
- The Simplified Approach calculates different forms of hourly energy demand of the building using limited user inputs (compared to the Detailed Approach) and is likely to be more suitable for preliminary design work and other situations in which hourly energy demand data is lacking and a detailed assessment of renewable energy options is not desired.

2. MODELLING METHODOLOGY AND SCOPE

The establishment of the baseline energy demand can be done in two modes: a simpler 'Simplified Approach' and a more complex 'Detailed Approach'. The detailed flow-charts are presented in Figure 1 and 2 respectively. The modelling analysis is based on the energy demands of a single building, including electricity, space heating, space cooling and domestic hot-water demands. Industrial processes (e.g. energy/ steam demand for industrial processes, power plants, etc.) are not in scope. The user defines a mixed set of renewable and conventional **technologies each of which will partially satisfy the building's energy demands.** The model calculates the fuel, CO₂ and financial breakdown of meeting the user energy requirements for a suite of user specified technology installation options, which can then be compared to determine return on investment and levelised costs of energy. It is as such concerned only with the energy supply and end uses, and is not a point-to-point, or building spatial simulation model.

For the Simplified Approach where hourly energy demand is modelled within the tool, heating and cooling gains/ losses are assumed to be only through the building envelope exposed to outside air and for meeting ventilation requirements. This means that walls shared with neighbouring buildings are assumed to be in thermodynamic equilibrium and therefore no heat transfer is assumed through them. Furthermore, only space heating/ cooling and hot water energy demands are calculated in this approach, with annual lighting and equipment electricity demands being provided as a user input. Annual electricity demands for lighting and equipment are broken down into approximate hourly values based on a simplified algorithm.

For the Detailed Approach, hourly inputs of energy demand (heating, cooling, hot water and electricity), are an exogenous user-input, calculated through the use of a third party software, such as EnergyPlus etc. For the heating, **if the building has steam demand for space heating purposes, steam demand should be included as "heating demand" and an appropriate technology (e.g. boiler) should be selected to meet the required heating demand.** The conventional and renewable energy technologies included in the model are as follows:

- Combined Heat and Power (CHP), including micro CHP and Combined cooling, Heating, and Power (Tri-generation) based on, turbine or engine
- Heat pump (air source, ground source, water source)
- Heat driven chillers (absorption and adsorption),
- Solar PV,
- Solar thermal,
- Combined: Solar PV-thermal or thermo-electric systems,
- Wind Turbine
- Hot water storage,
- Cold water storage,
- Ice storage
- Space heating storage
- Electricity storage (battery),
- Gas and biogas Boilers,
- Direct heat and hot water sources (e.g. geothermal, district heat or waste heat)

The detailed method or the simplified method is used to calculate the utilisation of user-selected technology mixes **for each scenario and for the counterfactual “base” scenario. Based on these, the following metrics can be calculated.** Mathematical functions used to calculate these outputs are presented in the next chapter.

- Annual energy demand met by the selected technology mix scenario
- Annual fuel savings (kWh) by the selected scenario including exergy analysis (optional)
- Annual CO₂ savings (tCO₂) by the selected scenario
- Energy efficiency of the system
- Rational Exergy Management Efficiency (optional)
- Increase in initial investment compared to baseline (% fraction of total building cost)
- Annual fuel/ bill savings (TRY) by technology
- Payback duration by technology (years)
- Net annualised cost over lifetime by technology (TRY/ y)
- Levelised cost of CO₂ reduction over lifetime by technology (TRY/ tCO₂)
- Levelised cost of CO₂ reduction over project lifetime for building (TRY/ tCO₂)
- Net present value of scenario

2.9 Simplified approach

This approach calculates hourly energy demand using limited user inputs. The hourly heating and cooling demands are calculated using a simplified analysis of heat losses through fabric for exposed walls and resulting from ventilation. The degree hours are calculated based on occupancy (The use of only degree hours and U values results in overestimation of the heating loads as it does not include some of the heating gains such as appliance, metabolic and solar gains. Furthermore, it will not be able to distinguish different occupancy patterns for different buildings - e.g. commercial buildings might not be heated or cooled over the weekend, schools might be unoccupied for more than 2 months), internal design temperature and hourly outside air temperature data. In proposed methodology, using hourly temperature data and default occupancy timing (based on the type of buildings) will enable a more accurate calculation of heating and cooling loads.

The internal gains are estimated based on occupancy, lighting and appliance use, while solar gains are calculated using the glazing ratio and the dimensions of the exposed walls. The hot water demand is also based on the occupancy and typical requirements per person based on building type. The annual electricity consumption, split by lighting and other appliance use, is a user defined input. Electricity consumption will be broken down into hourly demand in the tool using a simplified algorithm. Similar to the detailed approach, dispatching algorithms determine the order in which the technologies are deployed to meet the electrical, heating and cooling demands. This ranking defines the merit order of preference in which technologies are used and therefore share of the energy demands **that are met by renewables. The proposed simplified approach is “simplified” compared to detailed engineering simulation tools; however, it still provides relatively accurate and robust energy demand data.** Although the algorithm performs an internal hourly calculation, it will be straight-forward for the user to use the model. Some of **the required inputs will be included in the “Default building parameters database”, and the user will only need to choose the simplified building type.** Target heating and cooling temperatures will also be included in the database. Simplified approach (i.e. performing an internal hourly calculation) also results in better estimates of utilization of renewable technologies. Even in the preliminary design work, the user will be able to apply a dispatching algorithm for the bundling scenarios. The flowchart for the simplified approach is given in Figure 1.

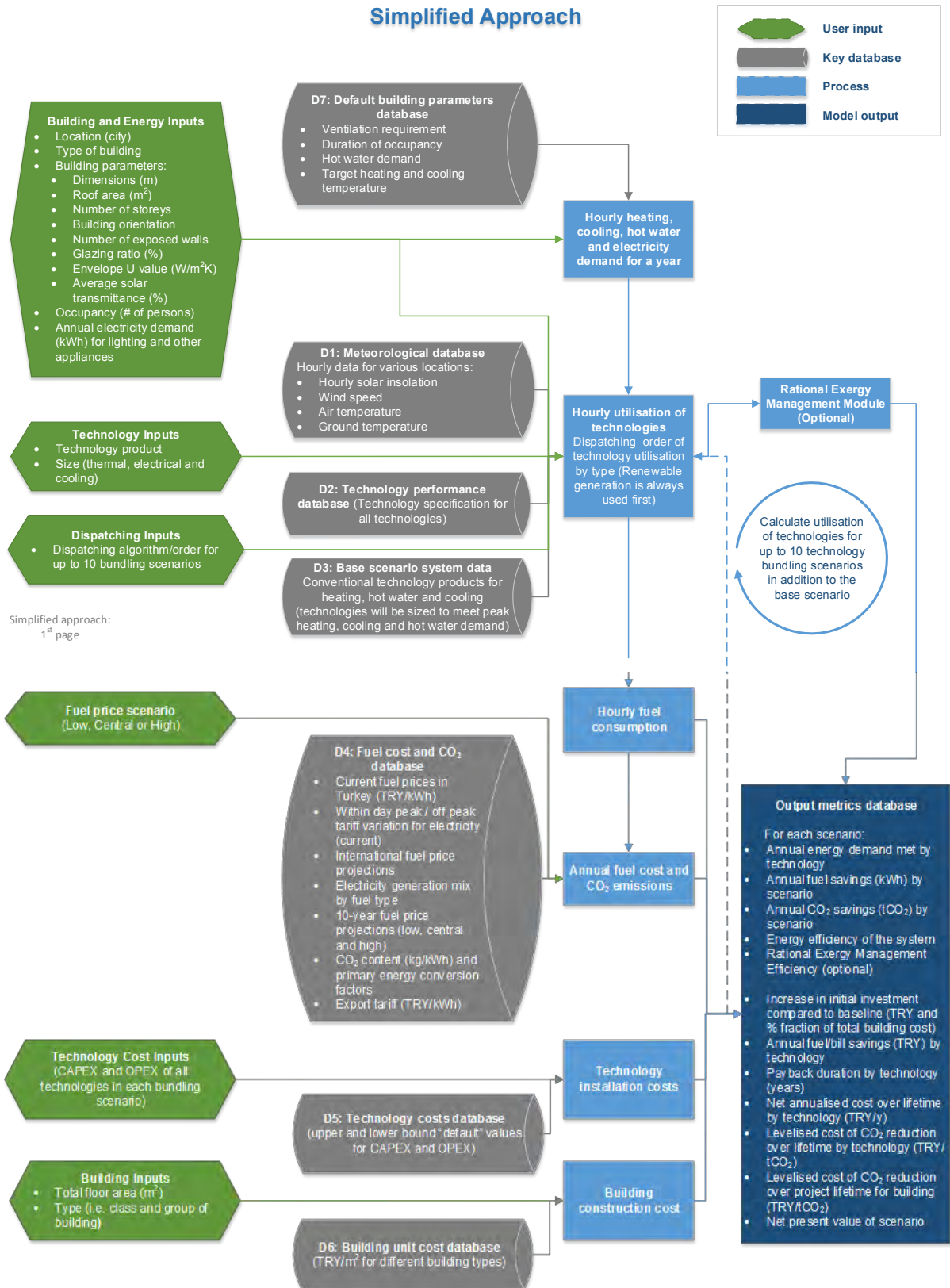
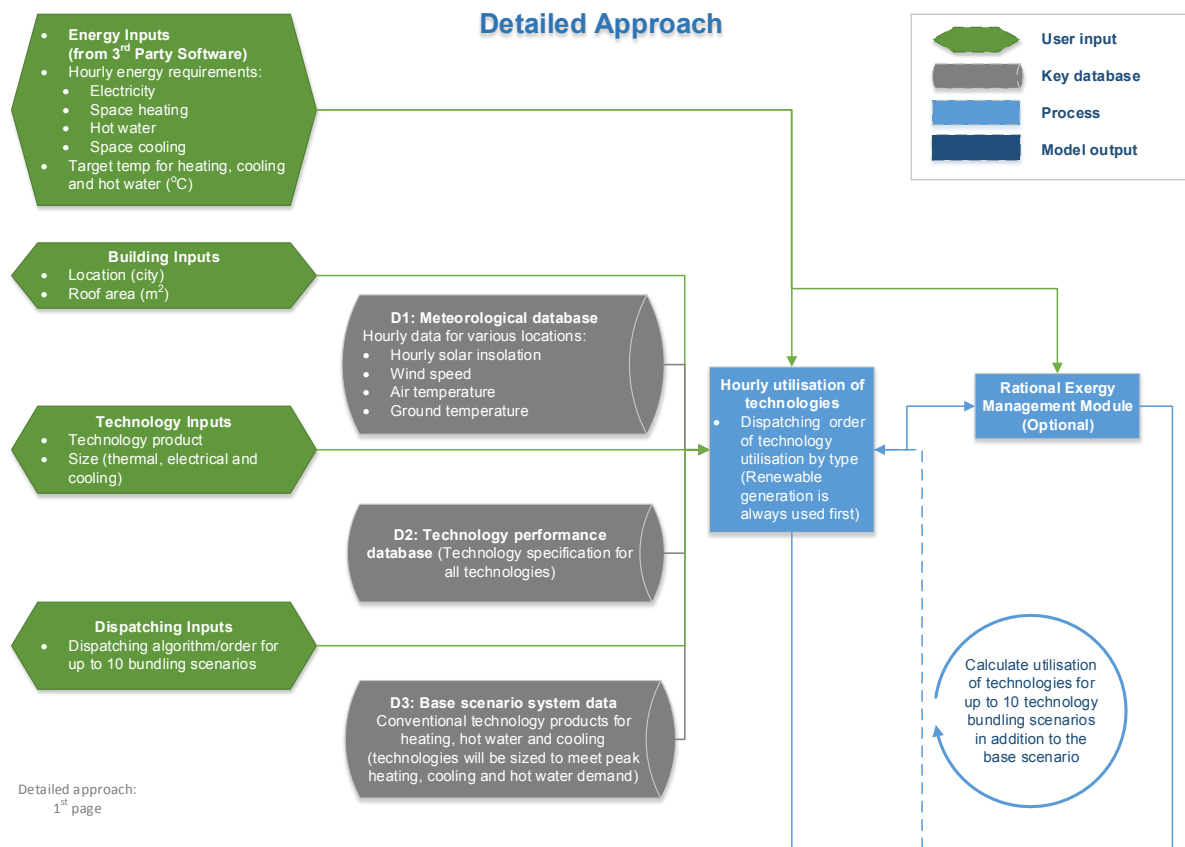
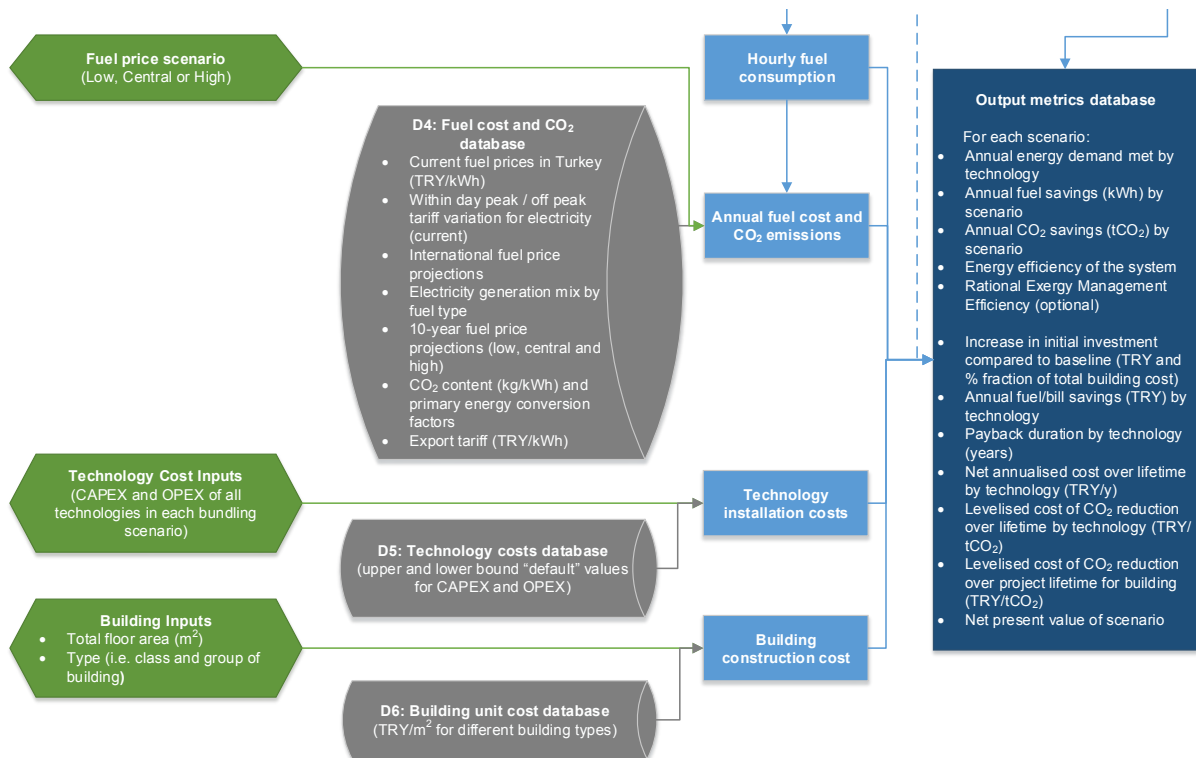

Figure 1: Flowchart for the Simplified Approach

2.10 Detailed approach

The detailed hourly approach uses pre-calculated energy demand profiles from third-party software, output and converted as needed to produce hourly electricity, heating, cooling, and hot water use figures. This approach requires fewer user inputs regarding the building performance as hourly energy demand does not need to be calculated by the tool. It should be noted that, the user will need detailed data on the building to generate the input file using a third-party software such as EnergyPlus. Dispatching algorithms determine the order in which the technologies are deployed to meet the electrical and thermal (heating, cooling and hot water) demands based on **a technology 'ranking'**. This ranking defines the preference order in which technologies are used and therefore the share of the energy demands met by renewables. As a general principle, renewable generation in the form of heat, hot water and/ or electricity from solar and wind is always used first. Any residual demand is reduced by storage, heat pump, CHP and if still required the conventional technologies such as boilers. The main objective constraint is the minimum required RET investment cost as a fraction of the total building cost. RET mix scenarios may be included in the tool but can be created or amended by the user. Compared with the Simplified Approach, the Detailed Approach produces a more accurate assessment of the dispatch of the available technologies and therefore provides a more accurate feasibility assessment. Where an accurate assessment is desired, and data is available, this will be the preferred approach. The flowchart for the detailed approach is given in Figure 2.





Detailed approach:

Figure 2: Flowchart for the Detailed Approach

© elementenergy

3. CONCLUSION

RET-EAT methodology developed as a subpart of "Promoting Energy Efficiency in Buildings in Turkey" Project. National software will be obtained by using this methodology. This web-based software can be used as a decision support tool for designers and investors about the cost optimality of the renewable energy technologies.

Renewable energy technologies diversify the nation's generation portfolio away from fossil fuels. The magnitude of the renewable energy can play depends role on how much cost reduction projections materialize. Investments in renewable energy systems should result in comparable reductions of investments in traditional energy technologies. Although incorporating costly renewable resources into the generation portfolio mix might increase the expected costs, fuel price risk is lower and will offset by increased export of petroleum and less consumption of natural gas. Also, exergy analysis is a very useful tool which can be successfully used in the performance evaluation of renewable energy resources as well as all energy-related systems.

REFERENCES

- [1] IEA, World Energy Outlook Special Report 2015: Energy and Climate Change
- [2] A key review on exergetic analysis and assessment of renewable energy resources for a sustainable future Arif Hepbasli Renewable and Sustainable Energy Reviews 12 (2008) 593–661
- [3] **Binalarda Enerji Performansı Yönetmeliği**
- [4] UNDP Turkey Renewable Energy Technologies - Economic Analysis Tool (RET-EAT)model guide, 2016
- [5] **Binalarda Enerji Performansı Ulusal Hesaplama Yöntemine Dair Tebliğ (Tebliğ No: YİG/2010-02)**

Geo-dependent Heat Demand Model of the Swiss Building Stock

Stefan SCHNEIDER^a, Jad KHOURY^b, Bernard LACHAL^c, Pierre HOLLMULLER^d

^a University of Geneva, Switzerland, stefan.schneider@unige.ch

^b University of Geneva, Switzerland, jad.khoury@unige.ch

^c University of Geneva, Switzerland, bernard.lachal@unige.ch

^d University of Geneva, Switzerland, pierre.hollmuller@unige.ch

ABSTRACT

One of the strategies for decarbonizing of the energy mix is to increase the use of district heat networks, for distribution of waste heat or heat produced by renewable energy sources. However, planning of such networks needs a geo-dependent energy database concerning demand and supply, incorporating their dependency on space and time.

The present paper concerns the development of a bottom up statistical extrapolation model for estimation of the heat demand of the Swiss building stock. The database is constructed on top of the Swiss building register, which contains basic data on building category, age, ground area and number of floors, as well as area devoted to dwellings. The model itself concerns: (i) estimation of the heated area of each building; (ii) estimation of the heat demand of each building, with disaggregation in terms of space heating (SH) and domestic hot water (DHW).

The model is calibrated by way of recorded data concerning actual yearly energy **consumption of around 27'000** buildings, with a classification by buildings category and age. The disaggregation in terms of SH and DHW allows for climatic correction of the observed data within a common climate basis. In a second step this calibration data is used for extrapolation of the demand on the entire Swiss building stock, for which the SH component is corrected by taking into account local climate characteristics.

Finally, statistical methods tend to quantify the uncertainty inherent to the use of average demand values by age and category, in relation with the level of spatial aggregation.

Keywords: energy use, energy measurement and verification, building energy simulation

1. INTRODUCTION

During the year 2013, the Swiss final energy consumption for space heating of buildings and domestic hot water production is estimated to 330 (PJ/Year) by [1]. According to the national energy statistics this represents approximately 40% of the total final energy demand. Within the Swiss Energy Strategy 2050, it is foreseen to reduce this demand by 63%, while increasing the share of renewable energy. Local renewable resources are numerous, however characterized by specific spatial availability, as well as temporal dynamics and quality (e.g. temperature), which limit their compatibility with demand. Hence, for assessing the potential of these resources and designing of adequate infrastructure like district heating systems, geo-dependent energy databases concerning demand and supply are needed. We focus here on the development of a geo-dependent heat demand model of the Swiss building stock.

Previous work in this direction was done by [2], where hectare raster statistics on dwelling surface and number of working places serves to estimate the heat demand of the Swiss building stock. However, latter model supposes that all building categories have the same specific heat demand of 120 (kWh/m² year). At European level, [3] uses population density for estimation of the heat demand on a 1x1 km raster. As an alternative to such statistical extrapolation methods, other authors try to simulate the energy demand of buildings in urban area by way of models based on building physics. However, such an approach requires detailed information on the building geometries as well as on the envelope components and associated U and g values. This turns out prohibitive at national level, as well in terms of access to such data as in terms of computational time.

As a response to preceding questions and state of the art, this paper outlines the development of a statistical bottom-up extrapolation model, which is based on measured heat demand and heated surfaces values of a **representative set of about 27'000 individual buildings. As a result, and as an improvement to previous work such**

as [2, 6], we estimate the heat demand of each building of the Swiss national building register (GWR) as a function of its category, age and location, and its heated surface as a function of its category, gross surface and/or dwelling surface. Furthermore, a bootstrap resampling algorithm allows to quantify the uncertainty inherent to the use of average demand values by age and category, in relation with the level of spatial aggregation. This kind of approach could be applied to other countries or communities having a GIS database containing basic information of their building stock as for example the Austrian address and building register (AGWR).

2. GEO-DEPENDENT HEAT ESTIMATION MODEL

The general structure of the model is shown in Figure 1. The combination of basic information for each building from the GWR with average statistic indicators from the calibration sets allows estimating the heated surface A_E (m²) and the specific heat demand E (MJ/m² year), from which we derive the final energy demand E_B (MJ/year).

For each pixel of territory, the estimated heat demand is summed over all buildings, and a bootstrap algorithm allows to estimate the confidence interval around the average value given by the model.

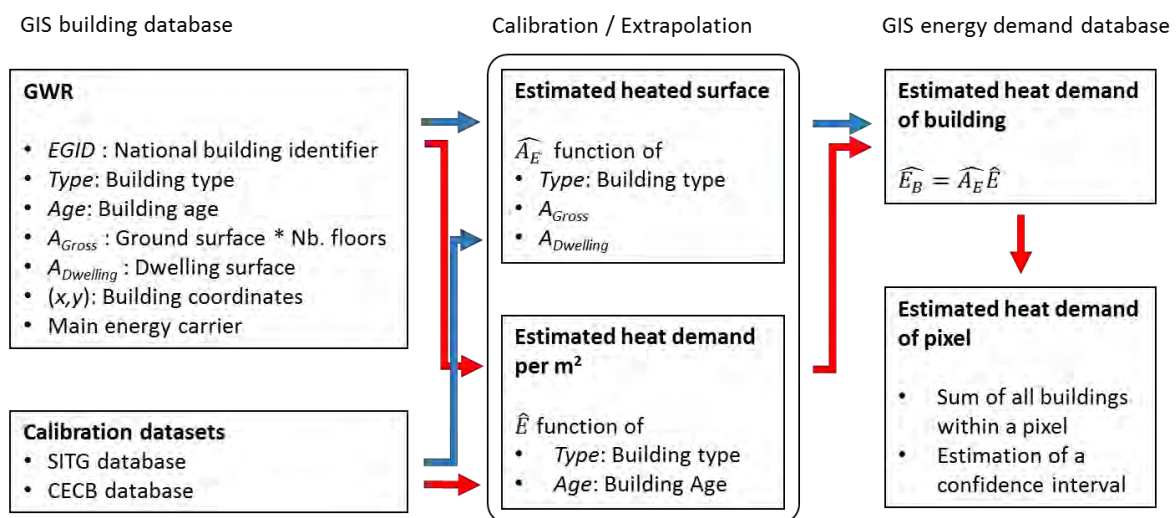

Figure 44: Model overview

2.1 Datasets

The model uses the following datasets:

- The Swiss national building register (GWR) maintained by the Swiss Federal Statistical Office contains basic building information such as: geographical coordinates, category, age, ground and dwelling surface as well as the main energy carrier for around two millions of buildings. This database is not exhaustive for buildings without residential purpose. A comparison with the Swiss building footprint data layer [9] shows **that around 400'000 buildings are missing. A unique federal building identification number (EGID) identifies each building**, allowing to link this data with other databases.
- The Geneva SITG database contains measured energy consumption as well as heated surface A_E defined according to norm SIA 416/1, for residential buildings and buildings used for non-residential purpose. This declaration is mandatory and is updated each year by a network of trained agents.
- The CECB database contains energy consumption averaged over three years. This is a certification covering buildings spread over the whole Swiss territory.

2.2 Estimation of Heated Surface

For each building of the GWR database, the heated surface A_E is estimated by way of the gross surface (number of floors x ground surface) and/or the dwelling surface.

The estimation is based on a set of linear regressions, on ten different building categories, given by 8'951 observations from the SITG database. As an example, Figure 2 shows the linear regression for the category of residential multi-family buildings.

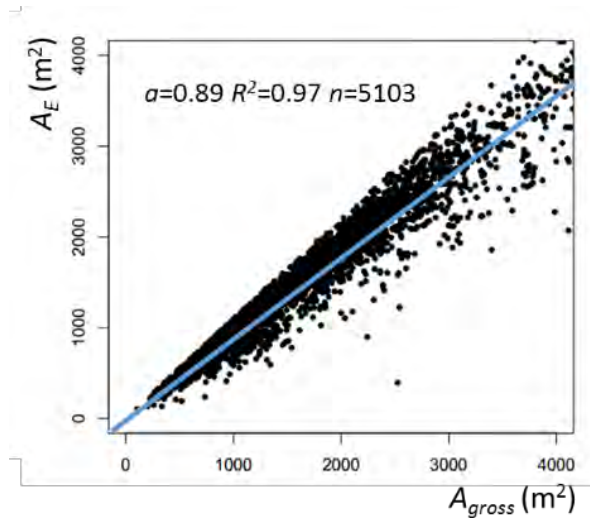

Figure 45: A_E as a function of gross surface (multifamily buildings)

Note that the CECB database, which is anonymised, could not be linked to the gross and dwelling surface of the GWR, reason why it is not used in this part of the process.

2.3 Estimation of Specific Heat Demand

For each building of the GWR database, the specific final energy for heat demand E_B is estimated by way of its age and category, on hand of average values given by the SITG and CECB datasets, which are normalized on a common reference.

Normalization of calibration data to a common reference

Since heat demand data of CECB and SITG concern a variety of energy carriers and locations, it has first to be normalized on a common reference. Therefore, for each building of these datasets, the measured final energy demand E (MJ/m² year) is converted into useful heat demand for space heating:

$$Q_{SH} = \eta_{EC}E - Q_{DHW}$$

Equation 1

η_{EC} is the transformation efficiency factor estimated by [10] and Q_{DHW} the useful heat demand for DHW production according to the SIA 380/1 norm. Since some very low-energy buildings may have thermal solar panels, leading to very low Q_{SH} values, we further add following constraint:

$$Q_{DHW} = \min(Q_{DHW}^{SIA}, 2/3 \eta_{EC}E)$$

Equation 2

The space heating values are further normalized on a common climatic reference (arbitrarily Geneva):

$$Q_{SH}^{GE} := Q_{SH} \frac{DJ(GE)}{DJ(\text{Origin of measure})}$$

Equation 3

DJ(Origin of measure) stands for the norm SIA 2028 heating degree days from the climatic station associated to the building.

Finally, the SITG and CECB data sets allow computing 15'588 and 11'499 Q_{SH}^{GE} values normalized to Geneva's climatic reference.

Statistical analysis by building category and age

For the sake of statistical analysis, preceding data is grouped in four building categories (multi-family residential, individual residential, non-residential, mixed purposes). For each of these categories, the data is further divided into 12 construction periods, and analysed in terms of statistical distribution Figure 3. At this stage, it is worthwhile noticing that the variability within each construction period is much higher than between the periods, as previously put forward by [10].

Finally, for each of the building categories and construction periods, we define the average space heating demand which is used for extrapolation on the GWR database:

$$\overline{Q_{SH}^{GE}} := \frac{\sum_{\emptyset} Q_{SH}^{GE} A_E}{\sum_{\emptyset} A_E}$$

Equation 4

This analysis is done separately for the SITG and CECB datasets, the respective values being used for reconstruction of the entire GWR building stock located in Geneva, respectively in the rest of the Swiss territory.

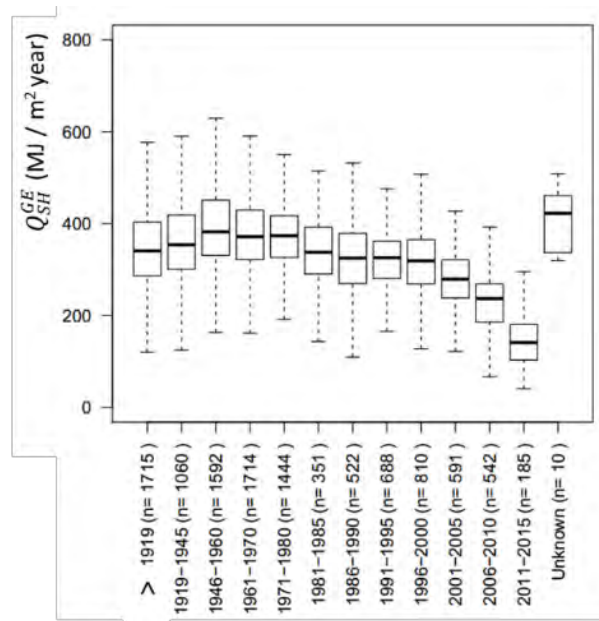

Figure 46: Boxplot distribution of q_{sh}^{ge} by construction period (multifamily buildings, SITG database)

2.4 Heat Demand at Building and Pixel Level

For each building of the GWR database, the specific heat demand is estimated by the average demand of its corresponding category and construction period with

$$\hat{E} = 1/\eta_{Agent} \left(\overline{Q_{SH}^{GE}} \frac{DJ(b)}{DJ(GE)} + Q_{DHW} \right)$$

Equation 5

On this basis, we compute the sum of the heat demand of all buildings contained in a pixel of territory:

$$\hat{E}_{Pixel} = \sum_{B \in Pixel} \hat{E}_B = \sum_{B \in Pixel} \hat{A}_E \hat{E}$$

Equation 6

The procedure is repeated on the entire Swiss territory, on square pixels of scalable sizes, ranging from 100 (m) to 1.6 (km).

2.5 Confidence Intervals

For each of the above pixels, we compute a confidence interval around the estimated heat demand value. It is computed by way of a bootstrap resampling algorithm, which consists in generating a heat demand distribution, which replicates the dispersion of the calibration datasets.

Therefore, for each building of the pixel, a new \hat{E} value is generated by replacing the $\overline{Q_{SH}^{GE}}$ value of (5) by a randomly picked value of the corresponding calibration dataset (same building category and construction period). Similarly, the heated surface \hat{A}_E is replaced by

$$\hat{A}_E^* := (1 + \Delta\hat{A}_E)\hat{A}_E$$

Equation 7

where $\Delta\hat{A}_E$ is a randomly picked relative error of the corresponding linear regression model, defined as:

$$\Delta\hat{A}_E := \frac{A_E - \hat{A}_E}{\hat{A}_E}$$

Equation 8

The replicated \hat{E} and \hat{A}_E values are fed into (6), generating a replicated heat demand of the entire pixel. Repeating of this procedure a 1000 times per pixel generates the heat demand distribution of each pixel. Finally, the limits of the 10% level confidence interval are the 5% and 95% percentiles of this distribution.

2.6 Results

At national level: Around 90% of the 1.93 million buildings listed in the GWR have sufficient data for applying of the appropriate regression model. Summing up all \hat{A}_E values leads to a total heated surface estimation of 706.2 million of m². The total aggregated final energy demand is 340 (PJ/Year) for a reference climatic year.

At pixel level: The results of the model, which cover the entire Swiss territory, are made available by way of a dedicated web service.

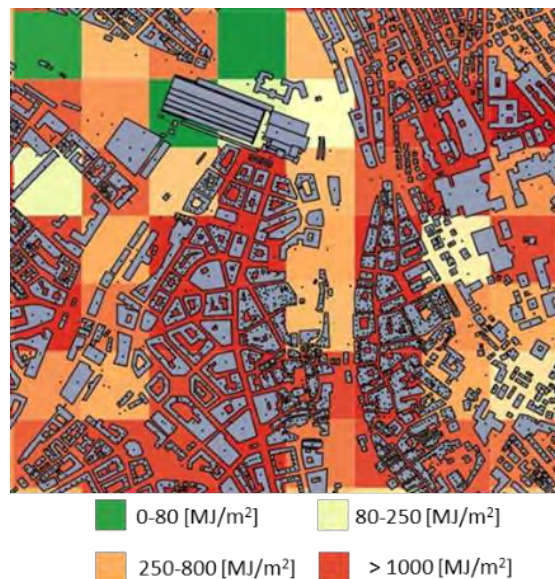

Figure 47: Sample map of a district of zurich

We finally build heat demand GIS maps, with more or less aggregated information, depending on the zoom level. Figure 47 shows an example of such a heat density map for an urban district. A colour ramp indicates the final energy consumption per square meter of territory, for each pixel of 200 (m) size.

3. DISCUSSION

Model variables: In this model, the variables used for determination of the specific heat demand have been limited to building category and age. In principle, the model could be refined with the use of additional factors, like building size or floor area ratio, which could be estimated on hand of the data contained in the GWR. However: (i) a rapid analysis of the SITG calibration dataset shows that, although statistically significant, these factors remain of secondary order; (ii) further subdivision of the calibration datasets would lead to statistically small subsets and related representativeness issues.

Due to similar representativeness issues within the calibration datasets, following finer categorizations were also abandoned (but could be introduced once more calibration data is available): (i) subdivision of the buildings in a larger number of categories, in particular for the non-residential sector; (ii) categorization of the heat demand by Canton, for tracking and taking into account of local specificities (other than the degree day issue, which is included in the model). As seen in section 2.3, and due to the high level of information of the SITG database, Geneva is the only exception to this uniform territorial categorization.

Comparison with national statistics: The total heated surface estimation is 6% below the estimation of 754 million of m² given by [1]. The fact that the GWR is not complete for industrial and services buildings can explain part of this gap. When focusing on the residential sector, the model yields 580 million m², against 509 million m² in [1].

The total aggregated final energy is in line with national demand statistics as [1]. This good concordance speaks in favour of the quality of the model, which was not calibrated for this purpose.

Confidence intervals: A strong added value of the model is the generation of a confidence interval around the estimated heat demand of each pixel. Due to the high dispersion of the specific heat demand within each building category and age class (Figure 46), the confidence interval can turn out quite large for pixels containing only few buildings, and reduces when more buildings are aggregated (averaging of the dispersion effect). A forthcoming paper will expose the relationship between aggregation level and estimation uncertainty in more details. The main outcome is that the uncertainty decreases proportionally to $1/\sqrt{Nb. \text{ buildings}}$ as predicted by the central limit theorem.

4. CONCLUSION

The strength of this bottom-up model is to allow estimation of geo-dependent heat demand at any aggregation level for the Swiss territory. The estimation of consumption based on the distribution of measured consumptions bears the advantage of including the variability between buildings of same category and age. As a result, a bootstrap resampling algorithm allows to quantify the precision of the aggregated heat demand, which is an added value compared to previous approaches. Finally, the good concordance of the total aggregated final energy demand with national demand statistics speaks in favour of the quality of the model.

ACKNOWLEDGMENTS

This research is being financed by CTI within the SCCER FEEB&D (KTI.2014.0119) project. The authors thank the Swiss Federal Statistical Office, for free access to the GWR database. We also thank Professor Martin Kumar Patel of the University of Geneva for giving us access to CECB database (exchange of information within the scope of a collaboration with SCCER CREST).

REFERENCES

- [1] Kemmler, A., et al., 2014. Analyse des schweizerischen Energieverbrauchs 2000 - 2013 nach Verwendungszwecken. *BFE report, Bundesamt für Energie*, Bern.
- [2] Eicher and Pauli AG, 2011. Ausbau von WKK in der Schweiz WKK-Standortevaluation auf Basis einer GIS-Analyse. Verband Effiziente Energie Erzeugung. *Final Report, Dr. Eicher+Pauli AG*, Liestal.
- [3] Connolly, D. et al., 2013. Heat Roadmap Europe: Combining district heating with heat savings to decarbonise the EU energy system. *Energy Policy*, 65(0), pp.475–489.
- [4] Perez, D., 2014. *A framework to model and simulate the disaggregated energy flows supplying buildings in urban area*. Thesis (PhD). EPFL Lausanne.
- [5] **Perez, D., et al., 2011. 'CitySim simulation: the case study of Alt-Wiedikon, a neighbourhood of Zürich City'**, paper presented at the *CISBAT 2011 - CleanTech for Sustainable Buildings*, Lausanne, 14-16 September.
- [6] Eicher and Pauli AG, 2014. Weissbuch Fernwärme Schweiz – VFS Strategie, Langfristperspektiven für erneuerbare und energieeffiziente Nah- und Fernwärme in der Schweiz. *Final report phase 2*, Dr. Eicher+Pauli AG, Liestal.
- [7] The Austrian address and building register (AGWR) [online]. Retrieved from: http://www.statistik.at/web_de/services/adress_gwr_online/index.html [Retrieved on 12 April 2016].
- [8] OFS, 2012. Registre fédéral des bâtiments et des logements: Catalogue des caractères. *User manual 2012*, Office fédéral de la statistique (OFS), Bern.
- [9] Swisstopo Topographic Landscape Model (TLM) [online]. Retrieved from: <http://www.swisstopo.admin.ch/internet/swisstopo/en/home/topics/geodata/TLM.html> [Retrieved on 25 Feb 2015].
- [10] Houry, J., 2014. *Rénovation énergétique des bâtiments résidentiels collectifs: état des lieux, retours d'expérience et potentiels du parc genevois*. Thesis (PhD). University of Geneva.
- [11] Efron, B. and Tibshirani, R., 1993. *An introduction to the bootstrap*. New York: Chapman & Hall.
- [12] SCCER FEED&D Geo-dependent energy supply and demand web service [online]. Retrieved from: <http://wisescer1.unige.ch/> [Retrieved on 12 April 2016]

Quantitative Impact Assessment of SEAP Measures Implementation on Several Districts in the City of Donostia

Xabat OREGI^a, Lara MABE^b, Patxi HERNANDEZ^c, Eneko ARRIZABALAGA^d, Eduardo MIERA^e, Sergio SAIZ^f

^a Tecnalia Research & Innovation, Spain, xabat.oregi@tecnalia.com, xabatoregi@gmail.com

^b Tecnalia Research & Innovation, Spain, lara.mabe@tecnalia.com

^c Tecnalia Research & Innovation, Spain, patxi.hernandez@tecnalia.com

^d Tecnalia Research & Innovation, Spain, eneko.arrizabalaga@tecnalia.com

^e Tecnalia Research & Innovation, Spain, eduardo.miera@tecnalia.com

^f Tecnalia Research & Innovation, Spain, sergio.saiz@tecnalia.com

ABSTRACT

Nowadays municipalities are facing an increasing commitment regarding the energy and environmental performance of cities. In order to answer this increasing demand, municipalities need integrated methodologies and tools which make possible take into account the specific boundaries, strengths and barriers and assess their impacts (environmental, economic and social) at current stage and allowing the evaluation of low carbon refurbishment scenarios with life cycle approach. Considering these needs, Tecnalia is working by different tool and methodologies, allowing the assessment of direct and indirect environmental, economic and social impact of new and existing districts. Using one of these tools, NEST (Neighbourhood Evaluation for Sustainable Territories) within the research projects ESSAI URBAIN and OptEEmAL, authors of this work have carried out the evaluation of several existing districts in the city of Donostia. This evaluation has firstly consisted in analyzing the baseline scenario in terms of **energy performance, environmental and economic impacts; and social “well-being”** of these districts. Then, with the objective of improving the energy performance and reducing the global impacts, authors have proposed several refurbishment scenarios based on specific actions from the SEAP (Sustainable Energy Action Plan) of Donostia municipality. This study has been performed in close collaboration with the city of Donostia which enabled the identification and selection of the most relevant and feasible scenarios from social perspectives. Results from this study have been used for comparing theoretical values extracted from the Donostia SEAPs, for developing a critical view of the achieved results and for proposing a prioritization process between different refurbishment strategies.

Keywords: decision support tool, refurbishment scenarios, environmental impacts

1. INTRODUCTION

Energy security and climate change are driving a future that will require significant improvements in the energy performance of the building sector. The 28 Member States of the European Union (EU) have set an energy saving target of 20% by 2020, which will need to be reached mainly through energy efficiency measures. The EU has also committed to reduce greenhouse gas (GHG) emissions by 80-95% by 2050, as part of its roadmap for moving to a competitive low-carbon economy in 2050 (Directive 2010/31/EU, 2010).

In order to support the energy transition of Europe towards a low carbon economy, municipalities have a key role to play. Launched the Covenant of Mayors for Climate & Energy brings together thousands of local and regional authorities voluntarily committed to implementing EU climate and energy objectives on their territory. Signatories now pledge to reduce CO₂ emissions by at least 40% by 2030 and to adopt an integrated approach to tackling mitigation and adaptation to climate change and to endorse and support the efforts deployed by local authorities in the implementation of sustainable energy policies. A Sustainable Energy Action Plan (SEAP) is the key document in which the Covenant signatory outlines how it intends to reach its CO₂ reduction target by 2020. It defines the activities and measures set up to achieve the targets, together with time frames and assigned responsibilities. These cities have signed the Covenant of Mayors on a voluntary manner and are committed to implement sustainable energy policies to meet and exceed the EU 20% CO₂ reduction objective through increased energy efficiency and development of renewable energy sources. However, there is a lack of connection between global objectives at city level and the implementation of energy strategies at district level. Specific solutions implemented at district level often ignore global issues, failing in the consideration of mid-term and long-term

scenarios. Besides, measures defined at global scale usually underestimate boundaries and barriers at district level.

In order to be effective in their energy and environmental transition, cities need specific tools to coordinate local **stakeholders' information, provide detailed and relevant diagnosis of their city; identify boundaries and barriers of** each district and their potential for energy measures implementation, considering technical and social issues. Using NEST (Neighbourhood Evaluation for Sustainable Territories) (Yepez, 2011), the authors of this work carried out an environmental and social evaluation of three districts in the city of Donostia. The evaluation firstly consisted of analysing baseline impacts. Then, with the objective of reducing environmental impacts and increasing social well-being, **the authors proposed several refurbishment scenarios for the studied districts, in line with Donostia's** strategies for energy efficiency.

2. NEST: NEIGHBOURHOOD EVALUATION FOR SUSTAINABLE TERRITORIES

Neighbourhood Evaluation for Sustainable Territories (NEST) was developed through a PhD thesis (Yepez, 2011) in Nobatek and the Groupe Recherche Environnement, Confort (GRECAU) laboratory, and focused on the environmental assessment of eco-neighbourhoods. Currently, the development of this software is carried out between Nobatek and Tecnalía, French and Spanish research centers with extensive experience in assessing environmental, economic and social impacts of buildings and districts. NEST is a plugin for Trimble SketchUp, which is the most used 3D modeler among urbanists and architects. NEST analysis is performed directly on the 3D master plan of the neighbourhood, and performs the assessment of a set of indicators that was developed through a scientific approach to operational urban planning objectives.

In terms of system boundaries, four major neighbourhood components are taken into account by NEST: buildings, land use, infrastructure (public lighting), and daily mobility of neighbourhood users (inhabitants and non-resident workers). Furthermore, NEST is one of the first tools that aims at assessing environmental impacts of neighbourhood scale projects, based on Life Cycle Assessment (LCA) methodology (social impacts currently are not evaluated with the life-cycle approach). NEST is based on the EN15978 (EN, 2011) standard, which defines **the evaluation scope of a building's assessment with a life-cycle** approach. Based on the conclusions obtained in the study carried out by Oregi (Oregi, 2015), NEST is focused on the assessment of the environmental impact of some of the life-cycle stages. The length of the NEST analysis is 50 years. Regarding the components of the district, the service life of the buildings is 50 years (Malmqvist et al., 2001), of land use is 50 years and of infrastructure is 30 years (Fthenakis et al., 2009).

3. PROJECT

3.1 Goal and scope

The goal of this study is to develop a methodology in order to promote resource conservation, reduction of environmental impacts and also to improve social conditions, adopting a life cycle approach. Using NEST, where **studied the historical part of the city ("Parte Vieja"), the centre of the city ("Ensanche Cortazar") and the new part of the city ("Amara district")** (see Figure 1). In this paper, we will present and discuss how the NEST tool was used in order to support the decision making process of urban refurbishment projects in order to implement the SEAPs measures into the three districts under study.



Figure 1: Screenshots of the three areas studied with the ESSAI URBAIN (Essai Urbain, 2009-2013) framework ("Parte Vieja" – "Ensanche Cortazar" – "Amara").

3.2 Case studies: Presentation

The three districts studied (see Figure 1) were chosen for their representativeness of the city of Donostia. As in most European cities, due to urbanism characteristics, construction age, buildings use, thermal properties, mobility infrastructure, building protection level, etc., the improvement potentials and constraints are quite different for each district. The historic centre of Donostia, founded in 1180, is protected by various regulations, reducing the number **of conceivable options in terms of refurbishment strategies. The “Ensanche Cortazar” was designed in 1864. The** architectural quality of some of these buildings turns them into catalogued or protected buildings, disabling their energy rehabilitation through strategies such as ventilated facades or window replacement. However, due to the high amount of energetically inefficient buildings, the potential of improvement is very high. In the second half of the 20th Century, Donostia city was enlarged and new urban areas had been created to make room for the **increasing population (“Amara” district). The use of buildings in Amara is mainly residential and there is no building** architecturally or urbanistically protected. Consequently, the energetic improvement potential of this district becomes very.

3.3 Evaluation methodology

A classical LCA process, similar to the one recommended by ISO standards on LCA was implemented beginning in the early stages of the study. To start, the goals and scope of the project were defined. As a result, it was decided that interest in the energy refurbishment strategies selected by the SEAP would be assessed, and would encompass each studied area over several time horizons. Next, the inventory analysis phase was carried out. This stage was critical as well as time consuming, because it required the collection of a large amount of data. The third phase consisted in running assessment calculations.

Primarily, a baseline analysis was done for the three districts. The baseline was defined in 2009, and corresponds **to the starting point for Donostia with regard to municipal ordinance implementation (called “eco-ordenanza”)** (Gipuzkoa, 2014). This ordinance aimed at optimizing energy efficiency of new and renovated buildings. After that, three assessments were performed in order to evaluate the efficiency of the measures taken by the city of Donostia: municipal ordinance, horizon 2020 and horizon 2030. Finally, the results provided by NEST were interpreted and compared to the baseline, taking into account three indicators: Primary Energy (PE), Global Warming Potential (GWP) and Air Quality (AQ). It must be noted that because mobility aspects have already been deeply studied by the municipality, it has been excluded from the calculations.

3.3.1 Baseline

The information obtained in close collaboration with the city of Donostia the definition of a vast majority of the inputs required for modelling the baseline scenario of each of the studied districts. Based on this information, Table 1 shows some of the results obtained after inserting the input data in the tool. Ninety-three percent and 91% of PE and GWP impact, respectively, are related to the impact generated during the operational stage of the buildings. During this stage, 43% of PE and 75% of GWP are related to heating consumption. With regard to the air quality impact and with the exception of the historic district, in which mobility is limited mainly to pedestrians, more than 95% of the AQ impact is related to individual and public transport. In terms of comparison among the three districts, it appears that the Ensanche Cortazar has the highest impacts related to buildings.

This is explained by the significant number of buildings without insulation, as well as by its lower density. With respect to public lighting, the Parte Vieja district has the highest impact due to the relatively low efficiency of its public lighting system. And finally, in terms of mobility, the Amara district has the highest impacts mainly because **of the district’s transportation model, which relies more on energy-consuming and GHG-emitting transportation modes than the two other districts.**

Impact indicator	Sector	Life Cycle Stage	Parte Vieja	Ensanche Cortazar	Amara
PE (MJ/year/user)	Buildings	A1-5, B2, B4, C1-4	0.0E+00	0.0E+00	0.0E+00
	Buildings	B6, B7	4.4E+04	9.7E+04	4.7E+04
	Public lighting	A1-3, B4, B6	1.9E+03	1.5E+03	1.3E+03
	Mobility	A1-4, B6, C1-4	1.2E+00	1.7E+03	2.1E+03

GWP (kg _{eq} CO ₂ /year/user)	Buildings	A1-5, B2, B4, C1-4	0.0E+00	0.0E+00	0.0E+00
	Buildings	B6, B7	2.5E+03	3.4E+03	1.5E+03
	Public lighting	A1-3, B4, B6	1.4E+01	1.1E+01	9.8E+00
	Mobility	A1-4, B6, C1-4	0.4E+00	9.7E+01	1.2E+02
AQ (m ³ /year/user)	District		6.6E+03	2.9E+05	6.3E+05

Table 1: Baseline results for each studied district (per year and user)

NEST models also provided the “well-being” profile (see Figure 2) of each district through the social indicator assessment, which provides a better understanding of the district structures, highlighting their main features.

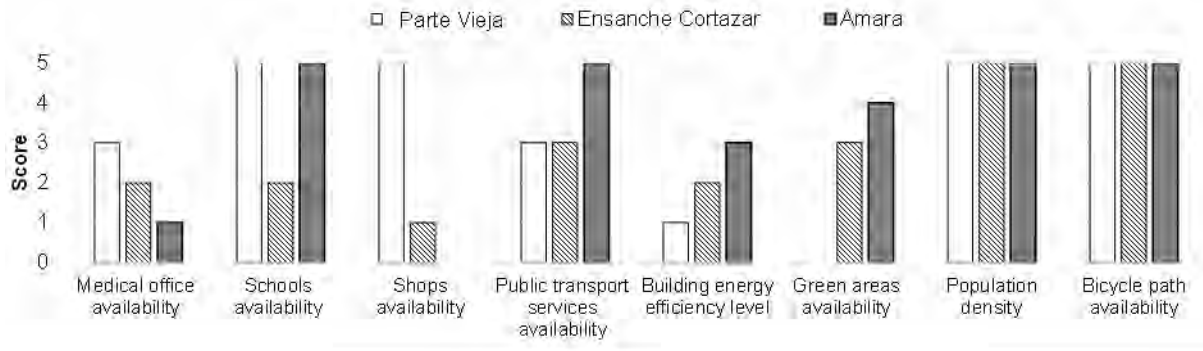

Figure 2: NEST social indicator results assessment of the three baseline scenarios.

3.3.2 Refurbishment scenarios

After evaluating the impacts of the baseline scenario, the second phase of the project was focused on the assessment of different energy refurbishment scenarios. The refurbishment scenarios are divided into three different temporal evaluations:

- Municipal ordinance of energy efficiency (2009-2014 years) (Gipuzkoa, 2014).
- Scenario 2020: Scenario based on the SEAP of Donostia (Minuartia Enea et al., 2011).
- Scenario 2030: Scenario based on Hiri Berdea document (ENEA, 2014).

Based on the information provided by these documents and through direct collaboration with the municipality, Table 2 shows the different energy refurbishment strategies for each aforementioned period.

Refurbishment strategy		<2009 (Baseline)	Eco- ordenanza	2020	2030
Public lighting	Luminary		Mercury vapour	Low pressure	LED
	Boiler	Natural gas		No improvements	Condensation
Public buildings	Lighting			No improvements	
	Cooling system		Standard		Efficient
	Heating reduction		No improvements	15%	15%
Residential buildings (RB) boilers	Oil (PV, EC and A)	20%	10%	0%	0%
	Natural gas (EC)	80%	90%	90%	75%
	Natural gas (A)	80%	90%	90%	60%
	Condensation (PV)	0%	0%	10%	50%
	Condensation (EC)	0%	0%	5%	15%
	Condensation (A)	0%	0%	10%	30%
	Biomass (PV)	0%	0%	0%	0%
	Biomass (EC)	0%	0%	5%	10%
RB replacement	Biomass (A)	0%	0%	0%	10%
	Windows (PV)		No improvements	5%	15%
	Windows (EC)		No improvements	10%	20%
	Windows (A)		No improvements	15%	40%
	Façade (PV)		No improvements	0%	0%
	Façade (EC)		No improvements	5%	10%

	Façade (A)	No improvements	20%	40%
RB heating demand reduction		No improvements	4%	7%
Solar thermal (PV)		No improvements		
Solar thermal (EC)		No improvements	970 m ²	2000 m ²
Solar thermal (A)		No improvements	2000 m ²	3500 m ²
Photovoltaic (PV and C)		No improvements		
Photovoltaic (EC)		No improvements		45 m ²

Table 2: Refurbishment strategies proposed for “Parte Vieja” (PV) – “Ensanche Cortazar” (EC) – “Amara” (A) districts

From Figure 3, it can be seen that results vary among the three districts. The “Ensanche de Cortazar” and “Amara” districts evolve in the same way, with reductions in terms of PE demand and GWP for the three scenarios (between 1% and 28%, depending on the scenario and the indicator).

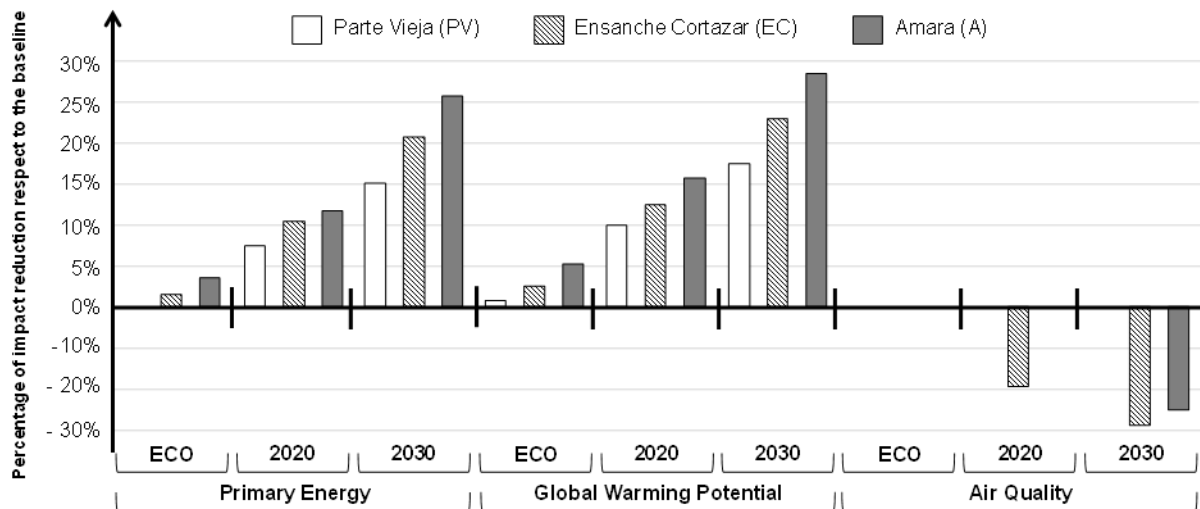

Figure 3: Impact variation (%) for the three districts studied in relation to the baseline.

However, the air quality indicator increases in the 2020 and 2030 scenarios due to the implementation of wood boilers (instead of gas boilers), leading to higher particulate emissions. It must be noted that this analysis should be deeply investigated while the precise type of wood boiler to be implemented is known. For the “Historic city” district, the impact reduction in terms of PE demand and GWP is lower due to historical constraints, which limit the implementation of energy refurbishment strategies. Also, the less frequent use of biomass boilers leads to a reduction in particulate matter, and thus reduces the influence on the air quality indicator.

4. DISCUSSION

Results provided by NEST allow quantifying the performance of the three districts at different time horizons in terms of primary energy demand, GHG emissions and air quality. This evaluation permitted to set the position of the studied districts with respect to the Donostia city objectives in terms of GHG emissions reduction for 2020 and 2030. As indicated in Table 3, results of the simulations show that the envisaged scenarios are not sufficient to reach the city objectives. Consequently, these results shed light on the improvements still needed to reach the defined objectives. However, it has to be noted that the proposed scenarios only tackle the built environment and associated impacts. One of the next possible areas of work in terms of methodology could be related to the influence of historical restrictions in designing energy refurbishment strategies at the city scale. Discovering new paths when designing refurbishment plans for such areas could significantly increase the refurbishment potential of cities.

(Impact indicator: GWP)		ESSAI URBAIN results (Essai Urbain, 2007–2013)	SEAP (Minuartia Enea <i>et al.</i> , 2011) & Hiri Berdea (ENEA, 2014)
	Parte Vieja	1%	
Eco	Ensanche Cortazar	3%	-
	Amara	5%	

2020	Parte Vieja	11%	20,5%
	Ensanche Cortazar	13%	
	Amara	16%	
2030	Parte Vieja	18%	30%
	Ensanche Cortazar	23%	
	Amara	28%	

Table 3: Comparison between ESSAIN URBAIN orders of magnitude and the targets to be reached

5. CONCLUSION

As mentioned, the work carried out during this study aimed at positioning the envisaged energy refurbishment **scenarios and associated environmental impacts in relation to the city's objectives**. The results showed some differences between the three districts studied, and helped the city of Donostia answer some critical questions. First, the assessment performed has allowed for the identification of GHG emissions hotspots in the baseline, and thus for the definition of key areas of action both in terms of geography (which districts) and items (which elements). For instance, it was highlighted that the Historical centre, due to architectural restrictions, will not be able to reach the same performance levels as the Amara or Ensanche districts. Also, building heating has been identified as the main contributor to district GHG emissions in the baseline. Finally, this exercise has provided important information regarding the envisaged energy refurbishment plan **and its corresponding role in reaching the city's objectives**. This has been particularly useful for the municipality to justify the need for additional efforts to reach their GHG emission objectives.

ACKNOWLEDGEMENTS

Part of this work was developed from results obtained during the ESSAI URBAIN (project number EFA287/13), POCTEFA program and "Optimised Energy Efficient Design Platform for Refurbishment at District Level" (OptEEemAL) project, Grant Agreement Number 680676. Another part of this work was developed with financial support from the French State, managed by the French National Research Agency (ANR) in the frame of the "Investments for the future" Programme ITE for the project INEF4 (ANR-10-IEED-0013).

REFERENCES

- [1] Directive 2010/31/EU, 2010. European parliament and of the council of 19 May 2010 on the energy performance of buildings.
- [2] EN, 2010. EN 15978:2011. Sustainability of construction works — assessment of environmental performance of buildings—calculation method.
- [3] ENEA consultancy, 2014. Donostia Hiri Berdea 2030, ingurumen estrategia.
- [4] ESSAI URBAIN POCTEFA, 2007–2013. Project number EFA287/13. Retrieved from: <http://essai-urbain.eu/> [Retrieved on 9 September 2016].
- [5] Fthenakis, V., Kim, H.C., Held, M., Raugei, M., Krones, J., 2009. Update of PV energy payback times and life-cycle greenhouse gas emissions. 24th European Photovoltaic Solar Energy Conference and Exhibition, Hamburg, Germany.
- [6] Gipuzkoa, O., 2014. Ordenanza municipal de eficiencia energética y calidad ambiental de los edificios. Ayuntamiento Donostia. Retrieved from: [http://www.donostia.org/secretaria/normunicipal.nsf/v/Listadold/558B58498F54B932C12575DD003F7534/\\$file/Ordenanza%20Texto_%20BOG_05_06_09.pdf](http://www.donostia.org/secretaria/normunicipal.nsf/v/Listadold/558B58498F54B932C12575DD003F7534/$file/Ordenanza%20Texto_%20BOG_05_06_09.pdf) [Retrieved on 1 May 2014].
- [7] Malmqvist, T., Galumann, M., Scarpellini, S., Zabalza, I., Aranada, A., Llera, E., Diaz, S., 2001. Life cycle assessment in buildings: The ENSLIC simplified method and guidelines. Energy, 36(4), 1900–1907.
- [8] Minuartia Enea, RSM Gasso Auditores, CIMNE, 2011. Sustainable Energy Action Plan of Donostia. Available online at: [http://www.donostia.eus/info/ciudadano/ma_areas.nsf/voWebContenidosld/80FE86B9FAB3DD7DC1257F6002C5878/\\$file/Documento%20PAES.pdf](http://www.donostia.eus/info/ciudadano/ma_areas.nsf/voWebContenidosld/80FE86B9FAB3DD7DC1257F6002C5878/$file/Documento%20PAES.pdf) (accessed 8 March 2015).
- [9] Oregi, X., 2015. Techno-Economic Evaluation of Building Energy Refurbishment Processes from a Life Cycle Perspective. University of the Basque Country.
- [10] Yopez, G., 2011. Construction d'un outil d'évaluation environnementale des écoquartiers: Vers une méthode systémique de mise en oeuvre de la ville durable. Université Bordeaux.

Session 6.7: Innovations Driving for Greener Policies and Standards – Assessment, Analysis and Modelling (2)

Full Cost Assessment: A Method to Analyse Sustainability of Buildings

Alessandra Akemi YOKOTA^a, Lu AYE^b, Masa NOGUCHI^c

^a The University of Melbourne, Australia, aakemi@student.unimelb.edu.au

^b The University of Melbourne, Australia, lua@unimelb.edu.au

^c The University of Melbourne, Australia, masa.noguchi@unimelb.edu.au

ABSTRACT

Quantifying the sustainability of buildings is a complex and very challenging task. Three interdependent factors: society, economy and environment need to be considered. It requires a systematic assessment of all these three factors for the entire life-cycle of the building. Full cost assessment (FCA) is an accounting method that monetises direct, indirect and external aspects. Since external aspects are considered, FCA provides a systematic approach to monetise the current and future impacts of decisions which may cause environmental and social impacts. The oil and gas industry was the first to apply the FCA approach in their decision-making processes. Recently, applications of FCA have been expanded to many areas such as energy supply, waste management, chemical process, transport system, and urban development. This paper aims to identify the benefits and limitations of FCA on the evaluation for the sustainability of buildings. The concept of FCA, the relevant methods available and the applicability of FCA to buildings are discussed.

Keywords: environmental product, life-cycle assessment, affordable housing

1. INTRODUCTION

The today's market demands the delivery of more affordable and sustainable buildings globally. However, the construction industry is facing many challenges to tackle this issue. The definition of sustainable development (SD) by the Brundtland Commission's Report considers three principal factors: society, economy and environment (WECD 1987; Bourdeau 1999). Sustainable construction is an important component and a direct output of sustainable development (Bourdeau 1999). Environment, economy and society are primary aspects of sustainable construction and public participation embraces this concept 'along with all their features throughout its life cycle' (Aye & Mirza 2006, p.386). Four principles denotes a notion that sustainability should include future, equity, environment and public participation in a wider perspective (Aye & Mirza 2006; Bourdeau 1999). Despite many different tools being available for quantifying sustainability in buildings, the lack of consideration given to the impact of external aspects is a major concern in the available sustainability assessment tools of buildings (Aye & Mirza 2006; Xing et al. 2007). Also, inaccuracy or misjudged assessments of sustainability identified in existing valuation tools may lead to further investments constrains and/or result in the mispricing of assets (Warren-Myers 2013). Therefore, economic appraisals shall provide means to support decision-making by quantifying economic, social and environmental values and lifetime benefits with impacts on the economy and society (Smith, Brown & Saunders 2016).

1.1 Full cost assessment

Full cost assessment (FCA) is an accounting method for identifying and quantifying costs of environmental, social and economic aspects in a lifecycle perspective (Bebbington 1998, p.7). It was developed to adjust the existing prices of goods and services by monetising and incorporating both positive and negative sides of internal and external aspects (Jasinski et al., 2015, pp. 1124). The "full cost" terminology was appeared in the oil and gas sector, seemingly as an environmental accounting approach to capitalise productive and non-productive expenditures, and produce data for predicting future earnings (DuBois 1974, p.1). The social sphere was incorporated into the definition of FCA in 1980 (Burchell et al. 1980). However, FCA focused mainly on environmental issues up until 1990's (Huizing & Dekker 1992) and faced challenges to meet companies' interest due to a high level of resources required and complexity (Naggar 1975; Buchanan 1982; Antheaume 2004). Since then, environmental impacts

has been incorporated into accounting-based information for private decision-making and environmental considerations into public decision-making (Milne 1991; Figge & Hahn 2005). Based on accrual accounting principles, revenues and expenses are recorded and costs incurred in the past and future costs are annualised.

FCA has been applied in many sectors for quantifying externalities and their uncertainties in projects and organisations (Bebbington et al. 2001; Jasinski, Meredith & Kirwan 2015). The FCA approaches vary in a range from narrowed to comprehensive applications, accordingly to its objective (Jasinski et al. 2015). For instance, the oil and gas sector, waste management, energy supply, water service, transport, urban development, and agriculture has applied FCA approaches to internalise externalities and increase the level of sustainability of products and organisations. Externalities or costs bear by external parties are viewed as not accountable costs or costs from impacts organisations are not responsible for (Antheaume 2004; Roth & Ambs 2004). Assessing external factors provide an opportunity to assess costs at the whole-society level, bringing the real economic effects of externalities as well as potential costs and prices changes (Smith et al. 2016; Bebbington et al. 2001). Therefore, FCA considers externalities rather than outlays as internal costs (Bebbington et al. 2001). Contingent or intangible environmental costs and externalities are accounted in a lifecycle perspective (Smith et al. 2016).

Environmental impacts can be divided into four categories such as impacts on atmosphere, hydrosphere, pedosphere and biosphere. Air pollutants, greenhouse gas emissions, soil depletion, contamination and noise are examples of negative environmental externalities which may arise from processes and activities in a lifecycle perspective, affecting the human health. Examples of positive economic externalities are higher workforce productivity, travel time savings, reduction in mortality and morbidity. Other effects may cause positive or negative impacts, for instance, community perception of economic equality, collective sense of uncertainty about the future, and standard of living. Social externalities may relate to environmental impacts (Phelan et al. 2017). Some studies included human health impacts as social externality (USEPA 2008; Kerr 2004). Many other negative social impacts may arise from environmental pollutants such as cancer cases.

The consideration of the three spheres of sustainable development has been partially included for quantifying externalities in project and organisations as the FCA concept, frameworks, methods and tools evolved over the time. However, Smith et al. (2016) acknowledged that there is still a lack of clear and established methodology approach (Xing et al. 2007; Liu 2014). Also, few studies have focused in quantifying externalities related to buildings (Xing et al. 2007; Liu 2014). Therefore, this paper aims to identify the benefits and limitations of FCA for the evaluation of sustainable buildings. The concept of FCA, the relevant frameworks available and the applicability of FCA to buildings are discussed.

2. CASE STUDIES

Twenty one FCA studies were selected from the literature for the identification of available FCA frameworks and the applicability of its concepts to buildings. The FCA frameworks found in the selected studies were categorised in five approaches as per Antheaume (2004) and Jasinski et al. (2015). The FCA approaches and externalities were discussed in this section. Table 1 provides detailed information about the selected case studies.

2.1 The avoidance and remediation cost control

The avoidance/remediation cost control approach estimates external aspects by the costs to be incurred, and cost which has not been incurred to prevent or avoid its emissions and meet existing or future regulatory standards (Bebbington et al. 2001). These case studies were selected for avoidance and remediation cost control through the Forum for the Future Framework (FFF). This approach can be utilised as cost control for environmental and social external impacts, avoiding damages to the environment and society. Liabilities are measured for the whole accounting year and impacts are translated into a sustainable operating income. The FFF utilises cost benefit analysis (CBA), sustainable cost calculation (SCC) and SCC combined with multi-attribute accounting are the methods available for the avoidance and remediation cost control approach. The Ontario Hydro utilises market methods whereas the value of damages applies contingent valuation.

2.2 Opportunity cost

Opportunity cost is a form of capital costs for omitted future returns that would have created benefits by alternative investments (Figge & Hahn 2005). The Sustainable Value (SV) concept combines social and financial capitals plus natural capital and applies opportunity cost for the evaluation and allocation of future assets (Figge & Hahn 2005). In this approach, the companies need to adjust their net profit to further receive a value-added indicator (Jasinski et al. 2015). Different from SCC, corporate genuine saving (CGS) is based on abatement costs rather than damage costs.

2.3 Damages cost

Damages are quantified through mathematical models or on-site measurements for reducing future external impacts (Bebbington et al. 2001). Through a multi-criteria analysis, decision-making alternatives are made to reduce future damages to the environment and society. For instance, the ExternE project-series focused on energy-related external and environmental and social impacts and combined with life cycle assessment (LCA) and impact pathway analysis (IPA) to fully quantify sustainability (Bickel & Rainer 2005). This method has certain limitations as it mainly focuses on energy-related external and environmental issues (Lai et al. 2014).

Sustainable Assessment Model (SAM) is the most used approach for the consideration of damages in projects/organisations. SAM enables to take a broader assessment, including many aspects of the evaluation (Jasinski, Meredith & Kirwan 2015). Despite multi-criteria analysis being used as a decision-making tool, CBA is the most applied method for the evaluation of sustainability. CBA has been widely used for assessing social, environmental and economic impacts as all the case studies include internal and external aspects. External costs are estimated through the monetary value of the damage and willingness to pay (Antheaume 2004). However, the use of CBA for FCA does not consider life cycle perspective. Therefore, recent studies have integrated CBA with other valuation methods to provide a comprehensive quantification of internal and external aspects.

2.4 Multiple approaches

Despite the popularity of FFF and SAM in FCA applications, there is a progress towards the utilisation of integrated models/methods. The concept of multiple approaches regards the integration of methodologies, frameworks or methods for achieving a comprehensive FCA (Jasinski, Meredith & Kirwan 2015). Multiple approaches adapt with the context of its implementation, providing means to tackle specific issues related to externalities.

Different from the first FCA applications, the recent case studies which utilised multiple approaches considered an extended life cycle period of about 30 years. Kerr (2004) utilises Damage Function Approach (DFA) and Value Estimated Damage (VED) in industrial processes. Liu (2014) combines Life Cycle Cost (LCC), LCA and Value Score (VS) for quantifying sustainability. The principle component analysis/factor analysis (PCA/FA) was utilised to identify sustainability index in the transport area (Reisi et al. 2014). Although combining methods provides the consideration of a reasonable amount of impacts, some studies acknowledge there are restrictions on quantifying a large number of impacts due to the limitation of tools and methods (Reisi et al. 2014; Mutavchi 2012). A novelty in the selected FCA case studies is the inclusion of Wider Economic Benefits (WEBs), which can be translated as gains to the society. In Australia, many sectors such as transport, communications, energy and water have applied full cost-benefit analysis (FCBA) to assist the decision-making process. The consideration of externalities, WEBs provides means to quantify indirect social benefits, which are usually not assessed. Lai (2015) applies this concept by integrating the traditional CBA and WEBs and, therefore, having a full quantification of positive external aspects.

FCA Approach	EC	E	S	Cost focus	Period	Principal valuation method	Sector	Reference
A	Y	Y	N	Internal and External	1 Year	CBA	Automotive Industry	(Huisman & Dekker 1992)
	Y	Y	N	Internal and External	1 Year	SCC	Forestry Industry	(Rubenstein, 1994)
	Y	Y	Y	Internal and External	1 year	Multi-attribute accounting + SCC	Landscape Research	(Bebington & Gray 2001)
	Y	Y	N	External	1 Year	Market methods	Electric Power Generation	(USEPA 1996)
B	Y	Y	N	Internal and External	-	Contingent valuation	Agriculture	(Whitby & Adger 1998)
	Y	Y	N	Internal and External	5 Years	CGS	Electric Power Generation	(Atkinson 2000)
C	Y	Y	N	Internal and External	1 Year	Opportunity cost	Oil and Gas	(Flogs & Hahn 2006)
	Y	Y	N	Internal and External	-	IPA	Energy	(Bicjel & Rainer 2006)
	Y	Y	Y	Internal and External	3 Years	CBA	Waste Management	(Cavanagh et al. 2006)
	Y	Y	Y	Internal and External	-	CBA	Waste Management	(Cavanagh et al. 2007)
	Y	Y	Y	Internal and External	-	CBA	Building	(Xing et al. 2007)
D	Y	Y	Y	Internal and External	20 Years	LCA + ExternE	Thermal Power	(Verhema & Bang 2003)
	Y	Y	N	External	-	LCI + LCA + Multiple	Industrial Process	(Antheaume 2004)
	Y	Y	Y	External	-	LCA	Coal Industry	(Epstein et al. 2011)
	Y	Y	Y	Internal and External	2-32 Weeks	CBA + EUROPE + COSTBUSTER	Waste Management	(Mutavchi 2012)
	Y	N	Y	External	7 Years	DFA + VED	Oil and Gas	(Kerr 2004)
	Y	Y	N	Internal and External	20-35 Years	LCC + LCOE	Electric Power Generation	(Roth & Armb 2004)
Y	Y	Y	Internal and External	30 Years	LCC + LCA + VS	Building	(Liu 2014)	
Y	Y	Y	External	-	PCAIFA	Transport	(Reisi et al. 2014)	
Y	Y	Y	Internal and External	30 Years	CBA + WEB	Infrastructure	(Lai 2015)	

Table 1: Selected case studies

FCBAs consider elements of agglomeration economies, imperfect competition and economic welfare benefits of optimised labour supply (Department of Transport 2012). Such benefits can be transferred to others and therefore add an external social and/or environmental value to the project or organisation, according to the type of its application. Even though FCBA has been applied in infrastructure and transport projects, this concept is relatively new to building constructions.

3. APPLICABILITY TO BUILDINGS

FCA provides means to quantify costs of external factors, which are usually not identified or are outside the responsibility of companies and/or organisations. Xing et al. (2007) acknowledged current FCA applications available for buildings absence in recognising external social and environmental impacts which are not reflected by the market. Therefore, there is a clear need of identifying, estimating and allocating potential shadow prices of buildings in a life cycle perspective. As most stakeholder easily understands monetary values, an approach for increasing the level of sustainability of buildings may be the inclusion of external impacts in monetary terms by using an economic appraisal.

The benefits of FCA for the evaluation of sustainability of buildings are many. The FCA approach allows measuring costs which may arise from external factors that are usually not considered. We observed that most the studies focused on internalising environmental impacts to, then, reduce, eliminate or avoid the effects of its external aspects considering financial aspects, at the same time. Also, some external impacts can be quantified while others have limitation to be appropriately monetised due to limited availability of relevant information.

Few studies have focused on quantifying externalities in buildings considering its entire lifecycle. No evidence of a FCBA for conventional or prefabricated houses was found in the literature as this approach has not been applied to the residential buildings. Therefore, we propose the utilisation of an integrated SAM by combining the quantification of externalities and WEBs. Not only externalities but also WEBs should be considered for FCBA in buildings and, therefore, decisions will not be made only based on the cost of the damage or externalities, but also by considering indirect benefits. There is a wide range of sustainable indicators which could be used in further FCA applications in the building sector. For instance, impacts on atmosphere, hydrosphere, pedosphere and biosphere, higher workforce productivity, value of time, human health, wellbeing and reduction in mortality and morbidity. Positive and negative impacts of social, economic and environmental externalities need to be carefully identified, analysed and quantified or monetised.

The FCA related to construction and urban development may guide further potential applications in the building sector as some externalities may be very challenging to be monetised. Also, the size of the project or organisation and objectives needs to establish the boundaries of the application. There is a lack of consideration of full costs and benefits to the society in current decision making relevant to buildings. The quantification of social costs and benefits must be considered as it may influence significantly the outcomes of the decision.

4. CONCLUSION

Quantifying externalities in buildings requires, firstly, a thorough understanding of effects on economy, environment and society in a lifecycle perspective to achieve better sustainability. This paper reviewed 21 FCA case studies from literature to identify the benefits and limitations of applying FCA for the evaluation of sustainability of buildings. Many different methods/techniques are used for this propose. However, it was observed in recent studies that the inclusion of both externalities and benefits of external impacts should be considered. We propose the application of an integrated SAM (or FCBA) by inclusion of externalities and WEBs in CBA for quantifying sustainability of buildings. Since the integrated application of CBA and WEBs was first applied in other sector, there is a clear need of adaptations of its concept to buildings. As further studies, we acknowledged limitations may be found as adjustments may be necessary, according to the data availability. We suggest the use of FCA studies in the urban development and building sector as a reference and guidance to identify potential external aspects related to its context.

REFERENCES

- [1] Antheaume, N 2004, Valuing external costs – from theory to practice: implications for full cost environmental accounting, *European Accounting Review*, vol. 13, no. 3, pp. 443–464.
- [2] **Atkinson, G 2000. Measuring “corporate sustainability”. Working Paper** - Centre for Social and Economic Research on the Global Environment, vol. 568. GEC 99-01, pp. 1–35.
- [3] **Aye, L & Mirza, MA 2006. ‘A review of sustainability assessment tools for office buildings’, in 40th Annual Conference of the Architectural Science Association ANZAScA, Adelaide, pp. 382–390.**
- [4] Bebbington, J & Gray, R 2001. An account of sustainability: Failure, success and a reconceptualization. *Critical Perspectives on Accounting*, vol. 12, no. July 2000, pp. 557–587.
- [5] Bebbington, J 1998. Full cost accounting from an environmental perspective: Review. *Social and Environmental Accountability Journal*, vol. 18, no. 1, pp. 21–21.
- [6] Bourdeau, L 1999. Sustainable development and the future of construction: a comparison of visions from various countries, *Building Research & Information*, vol. 27, no. 6, pp. 354–366.
- [7] Brundtland, GH 1987. Our common future: report of the world commission on environment and development. *Medicine, Conflict and Survival*, vol. 4, no. 1, p. 300.
- [8] Buchanan, PG 1982. Income smoothing under the successful efforts and full cost methods in the oil and gas industry. PhD Thesis, Temple University.
- [9] Burchell, S, Clubb, C, Hopwood, A, Hughes, J & Nahapiet, J 1980. The roles of accounting in organizations and society. *Accounting, Organizations and Society*, vol. 5, no. 1, pp. 5–27.
- [10] Cavanagh, JE, Frame, BR & Lennox, J 2003. **‘The sustainability assessment model (SAM): measuring sustainable development performance’.** *Offshore Europe Conference – Proceedings*, November 2015.
- [11] Cavanagh, JE, Frame, BR, Fraser, M & Gabe, J 2007. **‘Experiences of applying a sustainability assessment model’, International Conference on Whole Life Urban Sustainability and its Assessment, p. 15.**
- [12] Department of Transport 2012. **‘Job density, productivity and the role of transport’.** An overview of agglomeration benefits from transport investments and implications for the transport portfolio.
- [13] **Dimitrijevic, B & Langford, D 2007. ‘Assessment focus for more sustainable buildings’, International Conference on Whole Life Urban Sustainability and its Assessment SUE-MoT Conference, June.**
- [14] DuBois, DA 1974. Full-cost accounting for exploration and development costs of petroleum companies: its effect on stock market prices, PhD Thesis, University of Missouri.
- [15] Epstein, PR, Buonocore, JJ, Eckerle, K, Hendryx, M, Stout, BM, Heinberg, R, Clapp, RW, May, B, Reinhart, NL, Ahern, MM, Doshi, SK & Glustrom, L 2011. **‘Full cost accounting for the life cycle of coal’, Annals of the New York Academy of Sciences**, vol. 1219, no. 1, pp. 73–98.
- [16] Figge, F & Hahn, T 2005. The cost of sustainability capital and the creation of sustainable value by companies. *Journal of Industrial Ecology*, vol. 9, no. 4, pp. 47–58.
- [17] Frame, B & Cavanagh, J 2009. Experiences of sustainability assessment: An awkward adolescence, London.
- [18] Gray, R 1992. Accounting and environmentalism: An exploration of the challenge of gently accounting for accountability, transparency and sustainability, *Accounting, Organizations and Society*, vol. 17, no. 5, pp. 399–425.

- [19] Grosskopf, KR 1998. A methodology for operationalizing sustainable residential development. PhD Thesis, University of Florida.
- [20] Haapio, A & Viitaniemi, P 2008. A critical review of building environmental assessment tools. *Environmental Impact Assessment Review*, vol. 28, no. 7, pp. 469–482.
- [21] Huizing, A & Dekker, HC 1992. Helping to pull our planet out of the red: An environmental report of BSO/Origin. *Accounting, Organizations and Society*, vol. 17, no. 5, pp. 449–458.
- [22] Jasinski, D, Meredith, J & Kirwan, K 2015. A comprehensive review of full cost accounting methods and their applicability to the automotive industry. *Journal of Cleaner Production*, vol. 108, pp. 1123–1139.
- [23] Kerr, GL 2004. The design and application of full cost accounting framework on the Athabasca oil sands case study. PhD Thesis, Royal Roads University.
- [24] Krewitt, W 2002. External costs of energy—do the answers match the questions? *Energy Policy*, vol. 30, no. 10, pp. 839–848.
- [25] Lai, J 2015. Risk appraisal for urban development: A decision support technique. PhD Thesis, The University of Melbourne.
- [26] Liu, J 2014. Developing a life cycle assessment model for measuring sustainable performance of buildings in China. PhD Thesis, University of Technology Sydney.
- [27] Milne, MJM 1991. Accounting, environmental resource values, and non-market valuation techniques for environmental resources: A review. *Accounting, Auditing & Accountability Journal*, vol. 4, no. 3, pp. 81–109.
- [28] Mutavchi, V 2012. Solid waste management based on cost-benefit analysis using the WAMED model. PhD Thesis, Linnaeus University.
- [29] **Naggar, AK 1975. An empirical study of evaluating “successful efforts” and “full cost” methods of accounting for finding costs of oil and gas industry from the investor’ s point of view, PhD Thesis, The University of Oklahoma.**
- [30] **Phelan, A, Dawes, L, Costanza, R & Kubiszewski, I 2017, ‘Evaluation of social externalities in regional communities affected by coal seam gas projects: A case study from Southeast Queensland’, *Ecological Economics*, vol. 131, pp. 300–311.**
- [31] Reisi, M, Aye, L, Rajabifard, A & Ngo, T 2014. Transport sustainability index: Melbourne case study, *Ecological Indicators*, vol. 43, pp. 288–296.
- [32] Roth, IF & Ambs, LL 2004. Incorporating externalities into a full cost approach to electric power generation life-cycle costing. *Energy*, vol. 29, no. 12–15 SPEC. ISS., pp. 2125–2144.
- [33] Smith, N, Brown, C & Saunders, W 2016, *Disaster risk management decision-making: Review, Resilient Organisations*.
- [34] Taplin, JRD, Bent, D & Aeron-Thomas, D 2006. Developing a sustainability accounting framework to inform strategic business decisions: A case study from the chemicals industry. *Business Strategy and the Environment*, vol. 15, no. 5, pp. 347–360.
- [35] **United States Environment Protection Agency (USEPA) 1996. Full cost accounting’ for decision making at Ontario Hydro, DIANE Publishing.**
- [36] Venema, HD & Barg, S 2003. The full costs of thermal power production in Eastern Canada, International Institute for Sustainable Development.
- [37] Warren-Myers, G 2013. Is the valuer the barrier to identifying the value of sustainability? *Journal of Property Investment & Finance*, vol. 31, no. 4, pp. 345–359.
- [38] Whitby, M & Adger, WN 1996. Natural and reproducible capital and the sustainability of land use in the UK. *Journal of Agricultural Economics*, vol. 47, no. December 1993, pp. 50–65.
- [39] **Xing, Y, Horner, RMW, El-haram, M A & Bebbington, J 2007. ‘A framework model for assessing sustainability impacts of a built environment’. International Conference on Whole Life Urban Sustainability and its Assessment, Glasgow.**
- [40] Xing, Y, Horner, RMW, El-Haram, MA & Bebbington, J 2009. A framework model for assessing sustainability impacts of urban development, *Accounting Forum*, vol. 33, no. 3, pp. 209–224.

Integrated System for Energy Optimization and Reduction of Building CO₂ Footprint

Ernesto Enrique Echeverria VALIENTE^a, Flavio Celis d'AMICO^b, Manuel de Miguel SANCHEZ^c, Patricia Dominguez GOMEZ^d, Ignacio Delgado CONDE^e, Alvaro Mozas SANTANDER^f, Kevin Moreno GATA^g, Juan Manuel Vega BALLESTEROS^h, Francisco Martin San CRISTOBALⁱ

^a University of Alcalá, Spain, ernesto.echeverria@uah.es

^b University of Alcalá, Spain, flavio.celis@uah.es

^c University of Alcalá, Spain, manuel.miguel@uah.es

^d University of Alcalá, Spain, interpatridg@gmail.com

^e University of Alcalá, Spain, igdeco@gmail.com

^f University of Alcalá, Spain, mozasalvaro@gmail.com

^g University of Alcalá, Spain, kevin.morenogata@gmail.com

^h University of Alcalá, Spain, juanmanuel.vega@uah.es

ⁱ University of Alcalá, Spain, francisco.martin@larentia.es

ABSTRACT

The main purpose is the design and development of an integral system for the energy inspection and energy evaluation for buildings with high energy-saving potential, which will make possible the proposal of effective rehabilitation actions towards the reduction of the CO₂ footprint and the conversion of those buildings into zero-consumption buildings.

First of all, all the typologies of buildings have been studied to choose which one is the ideal model. A multidisciplinary approach has been applied to deal with this task, including the design of an indoor unit mounted on a trolley and a UAV drone unit for the complete, geometric and thermographic, measurement of the building's envelope. All processed data have been compiled in Building Information Models (BIM) containing also all the information required for the energy evaluation of the building. These models were made with all the data georeferenced so they could be automatically incorporated into the energy analysis software. Several of this energy analysis software were used to evaluate the model and the results have been compared, focusing on the complexity and the percentage deviation of results.

A methodology for evaluating the energy generated by buildings has been developed, and it also includes the creation and evaluation of innovative building solutions that would lead us to reduce energy consumption. These solutions have been gathered in a manual for use in several similar buildings.

Keywords: energy efficiency, integrated design, laser scanner

1. BACKGROUND

Energy consumption in buildings accounts for approximately one third of the EU energy consumption and CO₂ emissions, this is more than the consumption of industrial activity or transportation. Therefore, the rationalization of energy consumption in this sector has become a priority on the national and European energy policy, manifested by the appearance of specific regulations. Particularly noteworthy is The Spanish Strategy for Science and Technology, under the "Horizon 2020" of the EU, that states the challenge of producing safe, clean and efficient energy. In the case of existing buildings (in Spain there are 13 million homes most households amenable to be intervened, most of them from the years 1940-80, with non existent rules and scarce resources that difficult their intervention), energy rehabilitation works can bring savings of up to 75% in energy consumption, and a reduction in CO₂ emissions of most of 34% with respect to 2001 (WWF, 2012).

2. OBJECTIVES

2.1 Main objectives

The objective of this research is the development and creation of an integrated system that allows simplify the process of data collection, analysis of the situation and application of energy-saving solutions to a building rehabilitation as much as possible.

The rehabilitation leads to the recuperation of the interior thermal comfort and the reduction of maintenance costs, with a return period of investment assumable. Each building is a unique case, with its particularities in geometry, composition and construction (Celis et al, 2012), as well as its occupation and use, typology, facilities and management. The availability of comprehensive, unified and consistent information is a key factor to do a proper diagnosis and optimal decision making.

2.2 Election of study case

The study case is located in the south-western Galicia region. It has been chosen as a model for this investigation **because in the 70's there were a great expansion of the construction sector, which had to built many new schools,** but with low climatic requirements. Once there were analyzed a number of existing typologies with the previous conditions, it was chosen an educational building located in the south-western Galician region. In the 70s it was experienced a big construction expansion that led to the construction of new schools across Spain but with low climatic requirements. This model has been replicated frequently throughout the national territory (in this area, the same school project was built 35 times), and the study of this unit will provide data to know other similar centers in the area. The study building is the childhood education center of San Roque Elementary in Cangas, Pontevedra, (1972), (Figure 1).



Figure 48: Study Case. San Roque elementary school in Cangas, Pontevedra, Galicia, España. West Facade

2.3 Data collection

Regarding to geometry, the original drawings of the existing buildings aren't always available are not related with the constructed reality. For digital geometric modeling or 3D reconstruction, the laser scanners have an increasing acceptance, with specialist literature (Huber et al, 2011) pointing to its utility in the generation of 3D models BIM architecture.

Within the integrated system designed has been used a technology to acquire the geometry using a moving measuring device without GPS assistance, as the international reference research groups, such as the Video and Image Processing Lab, University of California Berkeley, and the Robotics Lab at the City College of New York, USA, has been developed. It has been also developed an unmanned aerial vehicles (UAV) model, with thermographic and geomatic sensors located in multi-rotor helicopters type (drones), which can fly at slower speeds and even maintain a fixed position (Fernández-Hernández et al, 2012).

BIM (Building Information Models) technology appears as the solution to compile all the information needed for the energy modeling process: 3D geometry, thermographic inspection and boundary environmental and technical conditions of the building (Lagüela et al, 2013; Vanlande et al, 2008). BIM does available to the energy inspector all the information and energy efficiency studies obtained of from the building (Raheem et al., 2011). The benefits from of this technology have been demonstrated by reducing costs and errors in the construction process, making a substantial improvement in the energy modeling of buildings (GSA, 2009) thanks to its large amount of data and faithful reproduction of constructed reality (Wang et al., 2011). However, advances in software on BIM and energy assessment takes focus on the early stages of life in the building: its design and endowment. Thus, the main commercial architectural design software tools offer BIM (© Autodesk, Bentley Systems ©, CYPE ©), but the energy assessment of as-built BIM is still under investigation.

2.4 Energy simulations

Within the integrated system that allows simplify the process of data collection, analysis of the situation and application of energy-saving solutions to a building rehabilitation as much as possible, this article will focus specially on energy simulations on the model of study and its connection with compliance with official regulations, (CTE, 2006) (Spanish Technical Building Code/Código Técnico de la Edificación).

3. ARQUITECTURE AND CLIMATE IN GALICIA

The climate of the village where the school is located under study is a mild, regular and humid climate. Temperatures range between 5 and 17 ° C, in winter and 15 and 25 ° C in summer, with humidity all year between 70 and 95%.

On the current regulation, the determination of climatic zones are given by the CTE, according to topographic height of each municipality, in the form of numerical table. It has developed a mapping with data versions CTE 2008 and 2013, with notable differences and several doubts regarding the correct climate distribution.

In this situation, it is very important for this research to obtain real climate data. Thus, the first step in the research is the realization of a new climate map of Galicia based of a proven methodology and set (da Casa, 2000), with the following phases:

- Consultation of weather information available through the official website of the autonomous community www.meteogalicia.es; all available stations with updated information are analyzed (Figure 2);
- There is established which weather stations are updated frequently, with no more than ten years in between;
- Monthly data of maximum and minimum temperatures, average data of maximum and minimum temperatures and relative data humidities are collected;
- The data are applied to Givoni diagram and bioclimatic strategies are established monthly;
- All the data obtained are arranged in a map and doubted zones are identified, data are analyzed even if the data are less than ten years, completing monthly distributions;
- Ultimately, there are obtained a map of monthly strategies, analyzed and verified the existence of potential clusters of great similarity, establishing zones with common data.
- With the mapping created, it is possible to establish the policy needs on each of the selected schools (35), with the same characteristics of the study case.

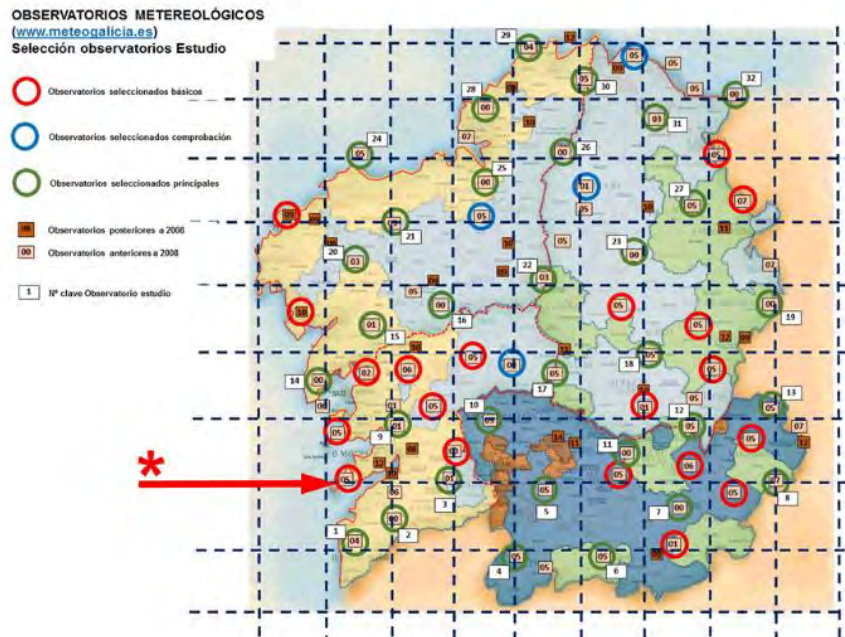

Figure 49: Map of Galicia with the climatic zones according to CTE 2013 and observatories studied. With (*) is indicated the village (Cangas, Pontevedra) where is situated the study case.

4. ANALYSIS OF CURRENT STATUS AND PROPOSED IMPROVEMENTS

As already mentioned in this article has focused attention on the comparison of results between different simulation tools. To analyze the current status and proposed improvements of the building will be used several computer simulations tools:

- HULC: (Herramienta Unificada LIDER CALENER -Unified Tool LIDER-CALENER). It is the official tool provided by the CTE in Spain for energy assessment of buildings. Last version 26/07/2016. (view of results on Figure 5);
- ECOTECT: One of the best simulation tools. It is currently unavailable because it is no longer provided by AUTODESK. (Figure 3, 4);
- **REVIT: It's the BIM of AUTODESK suite, and allows to obtain direct 3D image from the robotic entries and is associated with ENERGY PLUS engine analysis;**
- CASANOVA: It is a free software. Very accessible and intuitive, It has operative limitations and data input;
- SEFAIRA: It is a plugging for SKETCHUP. It has now been bought by the owner of SKETCHUP, ISCAR. Easy to shape but very simple.

Not all the computer simulations tools allows to use the same starting parameters. In some cases (REVIT, CASANOVA and SEFAIRA), there are not taken into consideration the hours of daily or monthly activity. In other cases, is not possible to use the real thermal data of the enclosures (it is only possible with ECOTECT) because they are much lower than the software admitted.

There are established three starting points:

- Case 0: No timetables or schedules of use are applied. External walls data correspond to the CTE. It can be applied to all analysis tools used in this research;
- Case A: Applying schedules and calendars. Using actual data of transmittance obtained "in situ" with measurement devices. It is only applicable with ECOTECT;
- Case B: Same as Case A, but introducing building materials data from the CTE database. It is applicable with HULC and ECOTECT.

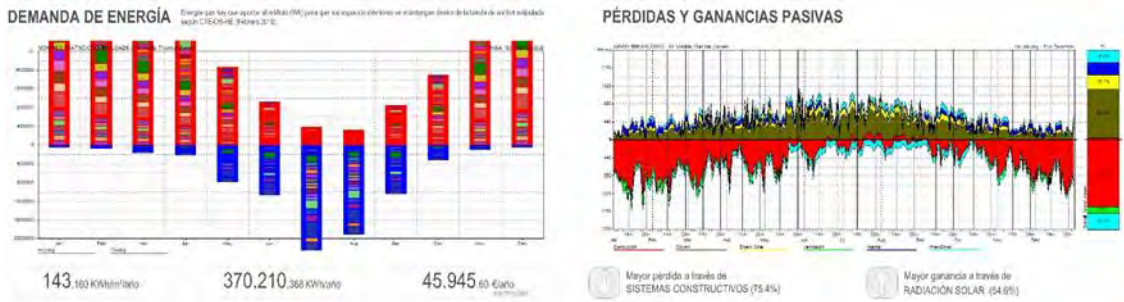

Figure 50: CASE 0 – Current status. Monthly demand for energy. Passive lost and gains.

5. IMPROVEMENT PROPOSALS

The simulations made with the different tools can be seen as requirements are isolation and uptake of radiation. They are used the same premises to discuss the results with all the tools, based on constructive solutions verified by the CTE. Three changes have been proposed but it would be possible to extend the application to many other combinations, using the speed of the simulation analysis:

- Option C: application of a new 15 cm insulation inside the facades is proposed;
- Option D: application of a new 15 cm insulation on the roof/deck is proposed;
- Option E: replacing existing windows by others with thermal break and double low emissivity glazed is proposed;
- Option F: It is the sum of all previous proposals (op. C+ op. D+ op. E).

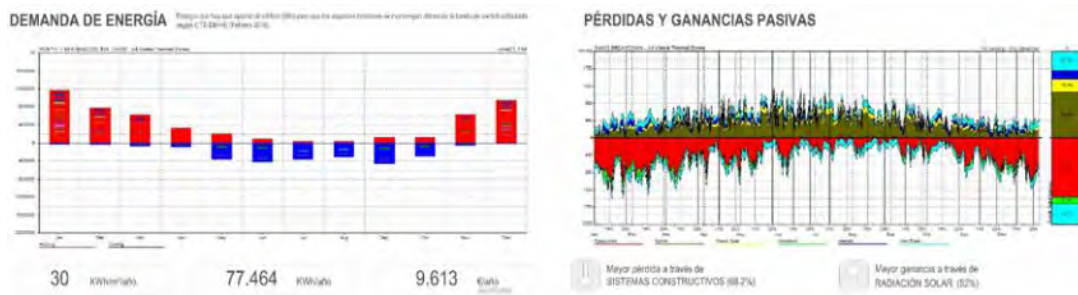

Figure 51: OPTION F - Monthly demand for energy. Passive lost and gains (ECOTECT)

	Verificación Límite de consumo			Certificación				
	Consumo EP no renovable edificio	Consumo EP no renovable edificio Referencia	Porcentaje respecto al edificio de referencia	Califica. EP	Consumo EP no renovable	Indicador or kgCO2/m2 año	Letra	Etiqueta energética
	kWh/m2.año	kWh/m2.año	% máximo 65		kwh/m2 año	m2 año		
OP. 0	77,59	36,05	215,21	G	17,00	G		
OP. C	68,83	36,05	190,90	F	14,70	G		
OP. D	76,40	36,05	211,89	G	16,70	G		
OP. E	60,41	36,05	167,54	F	12,60	G		
OP. F	45,88	36,05	127,25	D	8,90	F		

Figure 52: Summary of Case 0, and each study options C, D, E, and F. (graphic elaborated with HULC)

Studying the summary table of results (Table 1) can be seen that in general, there are further reductions in consumption with constructive solutions applied to the roof or windows (around 20% each), that the reform of the facades (around 7%). With the study of the necessary costs for each case it can be establish an investment plan based in the energy savings, the compatibility of use with the activity and the investment plan of the building's owner.

	<u>HULC</u>		<u>ECOTECT</u>		<u>REVIT</u>		<u>SEFAIRA</u>		<u>Casanova</u>	
	*	**	*	**	*	**	*	**	*	**
Caso 0	77,59		143		120	0%	165	0%	162	0%
Op. A			36							
Op. B	77,59	0%	38	0%						
Op. C	68,83	11%	36	5%	118	2%	156	5%	142	12%
Op. D	76,4	2%	33	13%	98	18%	122	26%	123	24%
Op. E	60,41	22%	30	21%	91	24%	122	26%	122,8	24%
Op. F	45,88	41%	22	42%	75	38%	109	34%	66,7	59%
*	<u>kW·h/m²·year</u>									
**	<u>% Reduction</u>									

Table 9: Comparison of simulation results

6. INTEGRATED DESIGN FOR ENERGY-EFFICIENT HOUSING

In addition to improve the energy efficiency of the building, according with the theories of integrated design, the other objective of the research is to get the most effective way to find the best solutions in building energy efficiency. This strategy aims to promote a more sustainable architecture through early multidisciplinary collaboration, achieving reductions of up to 80% of operating costs (Miotto et al, 2012).

The integrated design includes among others the following features:

- Motivation of participants;
- Prior establishment of measurable goals and project requirements;
- Holistic Business vision with extensive information: site, climate, use, culture, materials, systems;
- Internal coordination of the team work, establishing the direction and aids.
- Multidisciplinary team covering all trades that, in one way or another, are involved;
- Evaluations and simulations of the prototypes from the first sketch in order to take focus on the better solution.

7. CONCLUSIONS AND ACKNOWLEDGMENTS

The following conclusions have been obtained:

- Using the same parameters, there are obtained very different answers depending on the analysis tool used. The differences are both in absolute values and in the type of results that can be obtained.
- There are many differences in each tool or system between the form to input the data and the response received, and in the time spent entering data and the calculation process of the application itself.
- However, as can be seen despite the dispersion of absolute values, the relative values are similar improvement in the tools where these constructive solutions are applied.
- Once the system model is implemented it is very easy to propose a wide range of combinations of improvements over the model.

The procedure suggested for improving the conditions of energy consumption of buildings is, in the first instance, the usage of easier operation tools that can even support the direct import of 3D models from laser scanning tools within the integrated system proposed in this research.

Subsequently, and once channeled the energy solution, it will require a specific modeling using the official simulation tool "HULC", since this introduces data numerically, without modeled complex.

Alongside these simulations the study of the most efficient facilities also arises to improve overall performance and includes calculating the relative cost of each.

The development of this research is conducted within the project "ENE2013-48015-C3-2R" (Integrated system for energy optimization and reduction of building CO² footprint: BIM, indoor mapping and advanced energy technologies UAVs simulation tools) funded by the Ministry of Economy and Competitiveness and executed by the Geotechnologies group applied - University of Vigo, the Technology group information for scanning and 3D modeling in engineering and architecture - University of Salamanca and the Intervention group in the heritage and sustainable architecture - University of Alcalá.

REFERENCES

- [1] Celis, F., Escorcía, O., Díaz, M., García, R., Echeverría, E., 2012, "Incidence of form and envelope in thermal behaviour of dwellings in the Centre-South of Chile", *Hábitat Sustentable*, N.2, vol 2, pag 19-33, ISSN 0719-0700.
- [2] CTE, 2006, "Código Técnico de la Edificación" Real Decreto nº 314 de 17 abril de 2006. Ministerio de la Vivienda. España. Last versión 26/07/2016.
- [3] Da Casa, F., 2.000, Adecuación bioclimática en la subregión de Madrid, para el diseño de los edificios y sus elementos constructivos Tesis Doctoral, Madrid, ETSAM. UPM.
- [4] Fernández-Hernández, J., González-Aguilera, D., Rodríguez-González, P., Juan, M. 2012, A new trend for reverse engineering: robotized aerial system for spatial information management, *Applied Mechanics and Materials*, 152, 1785-1790.
- [5] GSA, 2009, GSA BIM Guide For Energy Performance, version 1.0. vol. 5 <http://www.gsa.gov/bim>: U.S. General Services Administration (GSA).
- [6] Huber D., Akinci B., Adan A., Anil E., Okorn B., Xiong X., 2011, Methods for automatically modeling and representing as-built Building Information Models, *Proceedings of 2011 NSF Engineering Research and Innovation Conference*, Atlanta, Georgia
- [7] Lagüela, S., Díaz-Vilarino, L., Martínez, J., Armesto, J., 2013. Automatic thermographic and RGB texture of as-built BIM for energy rehabilitation purposes, *Automation in Construction*, 31, 230-240.
- [8] Miotto, U.; García, R.; Escorcía, O.; Trebilcock, M.; Celis, F., 2012, Integrated Design for the development of energy efficient housing in Chile: threading abilities. *Habitat Sustentable*, Vol 1, N1, ISSN: 0719-0700. Pags 2-16.
- [9] Raheem, A., Issa, R., Olbina, S., 2011, Environmental performance analysis of a single family house using BIM, in *Proceedings in Congress on Computing in Civil Engineering*, pp. 842-849.
- [10] Vanlande, R., Nicolle, C., Cruz, C. 2008, IFC and building lifecycle management, *Automation in Construction*, 18, 70-78.
- [11] Wang, C., Peng, Y., Cho, Y., Li, H. 2011, As-built residential building information collection and modeling methods for energy analysis, *28th International Symposium on Automation and Robotics in Construction*, Seoul, Korea, June.
- [12] WWF, 2012, Retos y oportunidades de financiación para la rehabilitación energética de viviendas en España, disponible en: <http://www.wwf.es/?20627/WWF-propone-la-rehabilitacion-energetica-de-ms-de-tres-millones-de-viviendas-para-reducir-las-emisiones-de-CO2>.

Environmental Indicators for Monitoring the Swedish Construction and Real Estate Management Sector

Kristina EINARSSON^a, Linda LAGNERÖ^b, Hans-Olof KARLSSON HJORTH^c

^a National Board of Housing, Building and Planning, Sweden, kristina.einarsson@boverket.se

^b National Board of Housing, Building and Planning, Sweden, linda.langero@boverket.se

^c National Board of Housing, Building and Planning, Sweden, hans-olof.karlssonhjorth@boverket.se

ABSTRACT

A monitoring system with environmental indicators has been developed to monitor the environmental impact from the construction and real estate management sector in Sweden, at a national level and from a lifecycle perspective. The indicators are based on the Environmental accounts from Statistics Sweden and are updated every year from 2016. Data is so far available for the period of 1993-2014.

Environmental indicators enable to follow the development of the environmental impact of the sector. Seven indicators are selected to monitor the most significant environmental impact:

- Air emissions - Greenhouse gases, nitrogen oxides, particulate matter
- Use of energy - Fossil fuels, renewable fuel
- Use of health and environmentally hazardous chemicals
- Waste generated (planned)

The environmental indicators show the following results: The construction and real estate management sector emitted 11.6 megatonnes of CO₂e in Sweden in 2014. In comparison with total annual greenhouse gas emissions in Sweden the sector accounted for 19 percent. The total fuel usage of the sector accounted for 79 TWh, which is 31 percent of total fuel use and 17 percent of total use of fossil fuels in Sweden, from a life cycle perspective. The sector also contributes to emissions in other countries through imported products. An estimate of greenhouse gas emissions linked to imported products show that the emissions are big outside Sweden, about 8.7 megatonnes CO₂e. The sector import more environmentally hazardous chemicals than those produced in Sweden.

The environmental indicators show that the environmental impact from the construction and real estate management sector is significant from a life cycle perspective. The indicators will be used to evaluate improvement and inform policy and practice.

Keywords: life-cycle assessment, policy and regulation, environmental indicators

1. INTRODUCTION

The Swedish building authority is responsible for building up and disseminating knowledge about the impact on the environment from the construction and real estate management sector, hence the sector. Environmental indicators have been developed in order to measure and track the progress of the environmental impact from the sector. The method used was developed during the years 2009-2014 and has been presented in two studies (Toller et.al, 2011, and Toller et al. 2013) and in three reports (Boverket, 2009, Boverket, 2011, and Boverket 2014). It is developed by Royal Institute of Technology, in cooperation with Statistics Sweden.

The environmental indicators are selected to reflect the national Environmental Quality Objectives (EQO) in Sweden, covering the most significant environmental impact from the sector. They are intended to be communicable and based on available data. The indicators to monitor the environmental impact are as follows:

- Air emissions - Greenhouse gases, nitrogen oxides, particulates,
- Energy - Fossil fuels, renewable fuel
- Use of health and environmentally hazardous chemicals
- Generated waste

The Environmental indicators show the environmental impact from the sector from a lifecycle perspective. A starting point was to describe the environmental impact based on activities during a building's life cycle, and translate it to a sector level. This includes the environmental impact of all construction activities that occur during a year in the sector. It applies to activities during the manufacturing stage, construction stage, in the finished building, from the demolition phase and transport within and between the various stages. The statistics on waste are under development. The reporting of this indicator differs so far compared to the rest, as it does not emanate from a life cycle perspective.

Emissions from imported construction products are shown separately. Export of building products and household energy is not included.

Environmental indicators show:

- How much is emitted/ used in the sector
- The share of Sweden's total emissions/ usage in the sector
- Development over time – However they are dependent of the economic situation and the temperature

2. METHOD

The basis for the environmental indicators is the National and Environmental Accounts produced by Statistics Sweden. The method used is a so-called input-output analysis (IOA), adjusted for the special needs from the Swedish building authority to illustrate the environmental impact from the sector from a lifecycle perspective.

This adjusted method of an IOA for the construction and real estate management sector was developed by the Royal Institute of Technology in collaboration with Statistics Sweden on behalf of the Swedish building authority. It is based on similar analyses previously made for the energy sector and the agricultural sector. The used method is described in two papers (Toller et.al, 2011, and Toller et al. 2013) and three reports (Boverket, 2009, Boverket, 2011, and Boverket 2014). It has been improved in the past years and the method described below differs slightly on some points.

The National Accounts is an internationally comparable accounting system. Environmental Accounts are based on National Accounts and aims at describing the relationship between economic activities and the impact on the environment. Economic data from the National Accounts is expanded with environmental statistics for each industry such as emissions, fuel usage and chemicals.

An input-output table from the National Accounts describes the relationships between different industries within an economy. It shows how output from one industry is used as input in other industries and vice versa. An environmentally extended input-output analysis therefore enables estimating the impact on the environment from a certain industry, both through direct and indirect effects.

The adjusted input-output method used aims to capture environmental impact throughout a life cycle perspective from the sector, i.e. from the production of material used as input in the building process until the building is demolished. It differs from a traditional IOA regarding industry classification, redistribution of space heating, renovations and additions for imports.

2.1 Industrial classification

In National and Environmental Accounts industries are classified according to EU:s recommended standard, NACE. **The building authority's definition of the sector is represented well by the industries Construction of buildings (NACE 41), Specialised construction activities (NACE 43) and Real estate activities (NACE 68).**

In National and Environmental Accounts, however, the Construction industry normally is presented as an aggregate, (NACE 41-43), which also includes Civil engineering (NACE 42). One reason for this is that the requirements from the European Commission on reporting input-output statistics within the EU are on this aggregated level. To enable analysis of the environmental impact only from the construction of buildings, i.e. NACE 41 and NACE 43, and from the real estate management, NACE 68, a special partition of the official statistics has been made in this project.

The method used for disaggregating the Construction industry has been improved compared to the previously used method. Further improvement of the disaggregation method would be useful and our hopes are that the official statistics will be presented on this disaggregated level.

To sum up, by disaggregating the construction industry and by analysing chosen parts of the construction industry together with the real estate management industry our approach differs from an ordinary input-output analysis.

The environmental indicators are available from 1993-2014. However, due to the change in the industrial classification from NACE Rev.1.1 to NACE Rev.2 the time series is only consistent for the periods 1993-2007 and 2008-2013 separately.

2.2 Redistribution of space heating

In National and Environmental Accounts the major part of the space heating is excluded from the real estate management industry (NACE 68), due to European praxis. Only a minor part of the space heating is included in NACE 68, such as heating of stairwells. The major part, however, is included in other sectors, such as other service industries, the household sector, the government sector and non-profit organisations.

Capturing the lifecycle perspective of the sector therefore requires a redistribution of the energy used for space heating, with the intention to burden the real estate management industry with the environmental impact linked to space heating.

Compared to National and Environmental accounts the redistribution of space heating involves a so-called extended system boundary. The redistribution of space heating implies that information from different industries is combined. The life cycle perspective of the sector is captured in a better way, but comparison with statistics on other industries will be misleading.

A corresponding redistribution is done for environmental impacts from for example repairs and renovation of existing buildings.

2.3 Additions for imports

The products used as input in the sector are either produced within the country or imported from other countries.

The environmental impact of imports does not take place in Sweden, but in the countries where the products are manufactured. Environmental indicators should highlight the total environmental impact of the sector from a life cycle perspective. Hence, emissions from the production of imported products must be taken into consideration.

Different countries have different modes of production. Our experiences are that if emissions from imported products are handled as if they were produced in Sweden, they are underestimated. When it comes to greenhouse gas emissions, Statistics Sweden has improved the method and estimate emissions from imports by assumptions regarding the production in different countries, which would give a more accurate result.

3. RESULTS AND DISCUSSION

3.1 Environmental impact from the sector

The environmental impact from the sector was between 4-31 percent of the total impact in Sweden, see Table 1. The contribution from imported products is considerable. See especially the greenhouse gas emissions which are nearly doubled when emissions from imported products are included in the total emissions from the sector. For the greenhouse gas indicator, the estimation of emissions from imports is improved compared to the method presented in the paper from 2013 (Toller et.al 2013).

Environmental indicators for the sector 2014	Emissions from the sector, domestic production	The share of the sector, total domestic emissions in Sweden	Emissions from domestic production and imported
Greenhouse gases (tonnes CO ₂ -e)	11 568 305	19 %	20 248 149
NO _x (tonnes)	28 840	11 %	43 114
SO ₂ (tonnes)	8 333	13 %	12 713
Particles (tonnes)	12 871	25 %	14 653

Table 1: The total emissions and use for the chosen indicators during 2014

Environmental indicators, the sector 2014	Use in sector, domestic production	The share of the sector, domestic use in Sweden	Total use domestic and imported
Total use of fuels (TWh)	79	31 %	88
– Bio fuels	50	58 %	52
– Fossil fuels	28	17 %	36
Chemicals hazardous for the environment (tonnes)	65 385	4 %	230 494
Chemicals hazardous for the health <i>exclusive cement</i> (tonnes)	991 326	10 %	1 837 646

3.2 Greenhouse gases

The total greenhouse gas emissions from the sector were 20.2 megatons of carbon dioxide equivalents in 2014, including emissions from imported products (Figure 1). Of those, 11.6 megatons were released in Sweden. Compare with total annual greenhouse gas emissions in Sweden this amounts to about 19 percent. The indicators are dependent of the actual climate, e.g. in 2010's the higher emissions is explained by the colder temperature that year.

Emissions of greenhouse gases in the sector

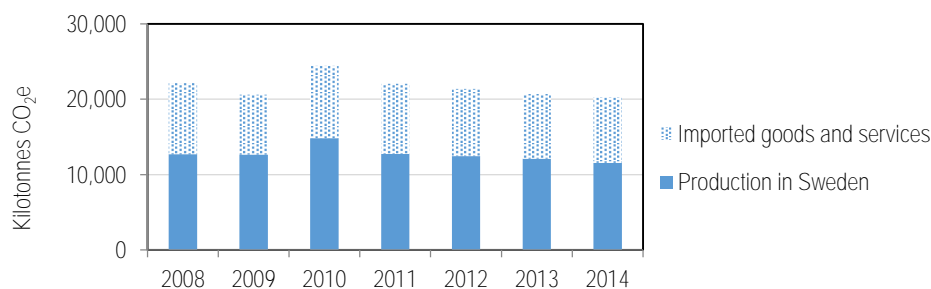

Figure 1: Total greenhouse gas emissions from the construction and real estate management sector in kilotonnes of carbon dioxide equivalent (CO₂e) released in Sweden (domestic emissions) and from imported products, viewed from a lifecycle perspective

3.3 Use of fuel

The total use of fuel in the sector amounted to 88 TWh in 2014, including imported products. Of these, 79 TWh was used in Sweden, equivalent to about 31 percent of Sweden's total use of fuel. Out of the 79 TWh, 50 TWh was from biofuel and 28 TWh from fossil fuels. The total use of fuel in the sector varies from year to year, depending on how the temperature varies; this applies to the energy for heating. Cold years the use of fuel increases.

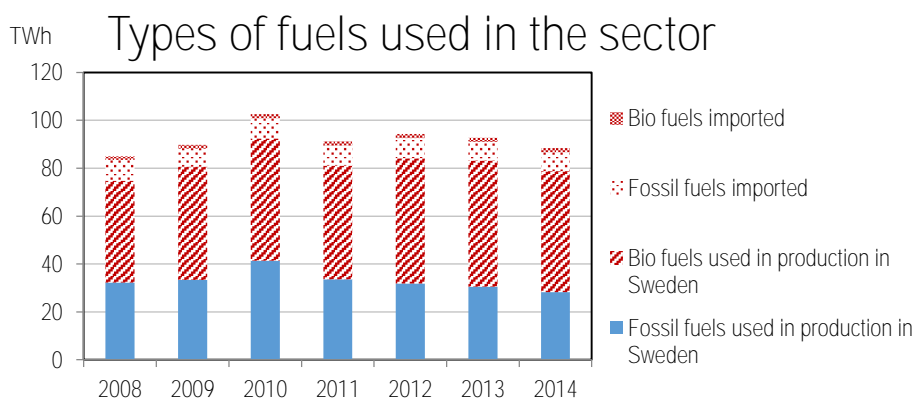

Figure 2: Total use of fuels between 2008 and 2014 in the construction and real estate management sector divided in domestic use and from imported products, and also in bio fuels and fossil fuels. The use of fossil fuels includes coal and coke, petroleum and petroleum products, natural and town gas and peat, fossil waste, etc. The biofuels are solid biomass, liquid biomass, biogas and biogenic waste.

3.4 Use of hazardous chemicals

In 2014 the use of chemical products hazardous for the health in the sector amounted to nearly 1.8 megatonnes if cement was excluded and approximately 3.1 megatonnes if cement was included (see Figure 3). Chemical products hazardous for the environment amounted to a much lower level, 230 kilotonnes in 2014.

The results include the use of chemical products that are classified as health or environmental hazardous in the sector. Examples of such products are paint, thinners and insulation. Products not included in the analysis are for example tar, asphalt and bitumen, as these are not classified and therefore not included in the Environmental Accounts. However, the quantitatively smaller amounts of additives in the asphalt are classified according to the Regulation (EU) No 1272/2008 on classification, labelling and packaging of chemical substances and mixtures (CLP), and are therefore included in the calculations.

The manufacture of cement, lime and gypsum accounts for a large proportion of the use of hazardous chemical products. These products are mainly classified as corrosive (C) and/ or irritating (Xi) according to the CLP Regulation. Products of cement are primarily a health and safety problem in the work environment. After the product has hardened it has no longer these properties. In order to avoid other hazardous chemicals to "disappear" in the statistics we have chosen to present cement separately.

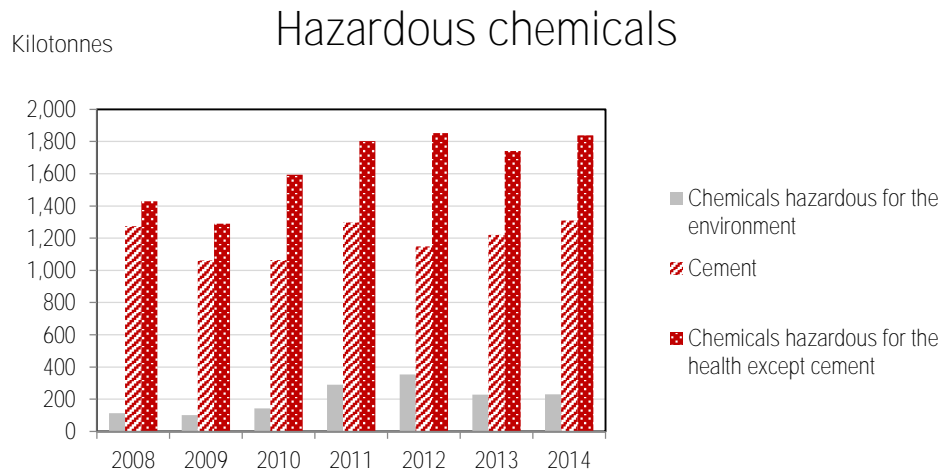

Figure 3: Total use (incl. imports) of health and environmentally hazardous chemical products (kilotonnes) from the construction and real estate management sector during 2008-2014

4. DEVELOPMENT NEEDS

Even though the method is ready to be used as it is presented in this paper, there are needs of further development of the indicators, according to the Swedish building authority. For example a better estimation of the emissions from import is needed for the rest of the indicators (the greenhouse gas indicator has a better estimate). It is a big difference in accounting as if the products were produced in Sweden or in the actual country, due to different modes of production.

The indicators are dependent of the economic situation and temperature. This will be visualized in the figures in **the future. The indicators are also possible to regionalize. That's of interest for the evaluation of the EQO.** The waste indicator is based on official waste statistics and there is an ongoing development of them since the data is inadequate.

5. CONCLUSIONS

The Swedish building authority's environmental indicators show the following about the sector environmental impact: The sector emitted 11.6 megatonnes of carbon dioxide equivalent (CO₂e) in Sweden in 2014. Compared to the total annual greenhouse gas emissions in Sweden this is about 19 percent. The sector's total fuel usage in Sweden is 31 percent. Both from a life cycle perspective. This means a 4-31 percent sector if we keep to the emissions/ use in Sweden.

The sector also contributes to emissions in other countries via imports. An estimate of greenhouse gas emissions linked to imported products show that they are big outside Sweden, about 8.7 megatonnes. The sector import more environmentally hazardous chemicals than those produced in Sweden.

The results show the importance of having a broader perspective in the analysis of environmental impacts. For example the constructions phase (material manufacturing) and the contribution of imports is important to include. You miss a large part of the environmental impact if only domestic emissions are reported.

The method can be used for follow-up. Several countries could use the method as statistics are available. The European requirements for international reporting cover the entire construction sector. It is desirable to have a finer breakdown of the sector. Sharp focus on the environmental impact of buildings creates a need for better statistics/ finer division.

ACKNOWLEDGEMENT

The authors thank the Royal Institute of Technology and Statistics Sweden for developing the method.

REFERENCES

- [1] Boverket, 2009. Bygg- och fastighetssektorns miljöpåverkan. Karlskrona, Sweden.
- [2] Boverket, 2011. Miljöindikatorer för bygg- och fastighetssektorn 1993-2007. Report No. 2011:2. Karlskrona, Sweden.
- [3] Boverket, 2014. Miljöpåverkan från bygg- och fastighetssektorn. Report No. 2014:23. Karlskrona, Sweden
- [4] Toller S., Carlsson A., Wadeskog A., Miliutenko S., & Finnveden G., 2013. Indicators for environmental monitoring of the Swedish building and real estate management sector. *Building Research & Information*, 1-10
- [5] Toller S., Wadeskog A., Finnveden G., & Miliutenko S., 2011. Environmental impacts of the Swedish building and real estate management sector. *Journal of Industrial Ecology*, 15(3), 394-404

Feasibility Study on Implementing Indoor Air Quality (IAQ) Index in Hong Kong

MUI Kwok-wai^a, WONG Ling-tim^b, TSANG Tsz-wun^c

^a The Hong Kong Polytechnic University, Hong Kong SAR, behorace@polyu.edu.hk

^b The Hong Kong Polytechnic University, Hong Kong SAR, beltw@polyu.edu.hk

^c The Hong Kong Polytechnic University, Hong Kong SAR, tsangtszwun@gmail.com

ABSTRACT

People are spending more and more time in indoor, especially for highly populated cities like Hong Kong. Prolong exposure to the indoor air pollutants can induce harmful effects to occupants' health and lower their productivities. Full indoor air quality (IAQ) assessment is the best way to diagnose unsatisfied IAQ and to identify the sources for mitigation and remediation to maintain a comfortable and safe indoor environment. However, without the initiative and support provided, high implementation cost and manpower lower the incentives for conducting IAQ assessment as well as managing the IAQ of a premise voluntarily. With growing concerns regarding the possible health problems and illnesses caused by exposure to indoor pollutants, territory-wide IAQ screening is urged to improve the overall IAQ situation in Hong Kong. In this study, feasibility of implementing IAQ index in Hong Kong is evaluated. Two approaches are suggested: i) IAQ index with surrogate indicators (IAQSI) and ii) IAQ health index (IAQHI). Proposed indices shall be easily understood by general public and thus can serve as an indicator of perceived IAQ of an indoor environment.

Keywords: Indoor Air Quality (IAQ), IAQ index, IAQ policy, screening

1. INTRODUCTION

Nowadays, people spend over 85% of their time indoor (Robinson and Nelson, 1995; Burroughs and Hansen, 2011). Workplace indoor air quality (IAQ) has always received focuses since poor IAQ can impede business. In recent years, IAQ in other indoor environments, for example residential buildings and sports centres, has gained social attentions and concerns regarding the potential health effects caused by poor IAQ. Indoor air pollutants are originated from the infiltration of ambient air pollutants from the outside and the generation from indoor sources. Indoor sources include indoor fixtures, building materials, operating machines and even occupants in the premises. IAQ concerns focus mainly on the potential health threats and the economic consequences of unsatisfied IAQ. Problematic IAQ has been correlated to health effects ranging from mild allergic reactions to adverse cancerous and fatal consequences. It also impedes working performance and causes discomfort to the occupants. Other than health problems, inadequate IAQ management can lead to economic consequences. Decrease in productivity and increase in sick absentees resulting from poor IAQ increase labour and production cost (Fisk, 2000a; Fisk, 2000b; Raw and Leaman, 1990). Costs arose from IAQ-related health problems pose burden on medical sector. In long-term, poor and unsatisfied IAQ creates negative effects to not only the building users and management but also the society as a whole.

IAQ problems in well-developed cities like Hong Kong are relatively complex, and therefore difficult to deal with. While most of the research efforts, legislations and policies in Hong Kong focus on mitigating and controlling the ambient air pollution, little development has been done in managing IAQ. In fact, indoor air pollution can be a greater problem than the ambient one because indoor environments are mostly enclosed with limited ventilation. Conducting full IAQ measurement to identify the root problems and the need for mitigation or remediation is no doubt the best way to manage and improve the air quality of an indoor environment. Yet, recourses and time involve can be a burden to small businesses and parties, which lower their incentives in tackling the IAQ problems they are facing.

To minimize the resources needed to be put onto IAQ management, extensive research has been carried out to develop diagnostic tools for identifying poor IAQ, which is the foremost and an essential step in preliminary IAQ screening strategies. IAQ index, proposed by Wong et al. (2006), provides an easy and understandable screening tool especially useful for IAQ management over a large area of interest. This study investigates the feasibility of implementing the IAQ index as a surveillance tool for managing the overall IAQ in Hong Kong.

2. IMPLEMENTATION OF INDOOR AIR QUALITY (IAQ) INDEX IN HONG KONG

Pre-assessment tools have been proposed in two approaches: i) Surrogate indicator approach; and ii) Health-risk approach. Surrogate approach reduces the efforts by conducting a less complicated but still highly representative assessment, while health-risk approach relates assessment result directly to human well-being. Proposed IAQ index with these two approaches are the IAQ index with surrogate indicator (IAQSI) and IAQ health index (IAQHI).

2.1 IAQ Index with Surrogate indicator (IAQSI)

Indicator approach has also been widely used in a variety of studies, since it is a practical, efficient and economical way to investigate the status of a subject without huge investment of resources. In disease control and medical diagnosis, health indicators, also known as bio-markers, are often used to identify potential diseased patients. For example, HLA-B27 is an antigen with positive linkage to autoimmune diseases (Jenisch et al., 1998; Cauli et al., 2002; Monnet et al., 2004). In the field of sustainable built environment, research has also been done on the investigation of using surrogate indicators for preliminary IAQ assessment, which is believed to be successful in minimizing the implementation cost of IAQ management.

Assessment using IAQSI looks at high fractional quantities of the common indoor air pollutants. The proposed **IAQSI θ uses the average fractional dose φ_j^* of the average level φ_j to the exposure limit $\varphi_{j,0}$ of N parameters j.** Exposure limit selected can be from any standard, with the selection criteria depending on the management strategies. **High value of θ indicates a higher probability of unsatisfied IAQ in an indoor environment.** Equation 1 shows the calculation of the IAQ index (Wong et al., 2006).

$$\theta = \frac{1}{N} \sum_{j=1}^N \varphi_j^* ; \quad \varphi_j^* = \frac{\varphi_j}{\varphi_{j,0}}$$

Equation 1

Surrogate indicators as indication of the quality of an indoor environment are selected based on their respective representative natures, which reflect the performance of the building systems and the occupant situation. Carbon dioxide (CO₂), particulate matter (PM₁₀) and total volatile organic compound (TVOC) are proposed to be the most indicative IAQ parameters, since they represent the occupants load, indoor activities and ventilation rate, system filtration performance and indoor activities, and building emission, finishing and human activities accordingly, at the same time are independent to each other (Wong et al., 2006).

The effectiveness of IAQSI in identifying premises with problematic IAQ can be evaluated using likelihood ratio, where likelihood ratio $L_r > 1$ suggests a high risk of having an unsatisfied IAQ, vice versa. Equation 2 illustrates the computation of L_r , where TP and TN are the number of fail and pass counts, nTN and nTP are the total pass and fail counts.

$$L_r = \frac{TN}{TP} \frac{n_{TP}}{n_{TN}}$$

Equation 2

Different combinations of the abovementioned surrogate IAQ parameters are tested to evaluate and illustrate the possible baseline IAQ control strategies in Hong Kong air-conditioned offices (Wong et al., 2016), i.e. how effective the IAQSI is in identifying problematic IAQ with minimum resources invested in the screening process. The difference between using 1) CO₂ only, 2) CO₂ and PM₁₀, and 3) CO₂, PM₁₀ and TVOC, (IAQSI θ_1 , θ_2 and θ_3 respectively), is investigated. To facilitate the understanding of IAQ screening results among general public, corresponding likelihoods of experiencing poor IAQ are expressed verbally with the proposed expression below.

1. Very improbable ($P'_d \leq 0.05$),
2. Improbable ($0.05 < P'_d \leq 0.2$),
3. Possible ($0.2 < P'_d \leq 0.4$),
4. Probable ($0.4 < P'_d \leq 0.7$),
5. Very probable ($0.7 < P'_d \leq 0.9$); and
6. Almost certain ($P'_d > 0.9$).

P'_d is the post-test probability, which can be calculated using Equation 3. P_d is the pre-test probability, O_d and O'_d is the pre-test and post-test odd, N_d is the number of unsatisfied IAQ in N regional IAQ samples.

$$P_d = \frac{N_d}{N}; O_d = \frac{P_d}{1 - P_d}$$

$$P'_d = \frac{O'_d}{1 + O'_d}; O'_d = O_d \times L_r$$

Equation 3

2248 office IAQ data undergo screening process using IAQSI θ_1 , θ_2 and θ_3 , in which offices are categorized into respective ranks (verbal expression) according to the post-test probability P'_d (Reagan et al., 1989; Vick, 2002). **Result shows that IAQSI θ_1 can** already screen out office samples that have relatively less chance of experiencing poor IAQ, while θ_2 and θ_3 offer better resolution over θ_1 , and are effective in identifying lower and higher risk groups among tested subjects. Ranks of the offices generally fall into the same category when they are subjected to full IAQ test (HKEPD, 2003). This part of the feasibility study shows that even with the measurement of just CO_2 as the indicator pollutant in IAQSI, the screening test already contains substantial usefulness and accuracy in reflecting the general IAQ in a premise with justified resources invested. The proposed IAQSI might be a useful tool for setting up a public IAQ surveillance programme and baseline control policy in Hong Kong.

2.2 IAQ Health Index (IAQHI)

Well-developed cities like Hong Kong should protect the health of general public, therefore maintain good IAQ to ensure good quality of life is essential and shall be incorporated in the management policy. Health-risk approach in risk management emphasizes in the effectiveness and the balance between cost for risk reduction and the benefits gained, and any strategies shall be set as low as reasonably practicable (ALARP) (H.M.S.O, 1974). Health risk-based air pollution index has been adopted in Hong Kong for ambient air pollution. The Air Quality Health Index (AQHI) provides the estimated combined excess health risk by using the sum of the percentage added health risk (%AR) of daily hospital admissions attributable to the average concentration of sulphur dioxide (SO_2), nitrogen dioxides (NO_2), ozone (O_3) and PM_{10} . Equation 4 exhibits the calculation steps of AQHI (Wong et al., 2013; HKEPD, 2013).

$$\%AR = \sum \%AR(c);$$

$$\%AR(c) = \{\exp[\beta(c) \times C(c)] - 1\} \times 100\%$$

Equation 4

Concept of IAQHI takes into the consideration that the effects of air pollutants to health are the same regardless the environment one is in. Therefore, expanding the AQHI by incorporating common indoor air pollutants into the calculation can make AQHI more comprehensive in predicting the total health risk of a person when he/ she breathes in the surrounding air in an environment. The proposed health index is named as IAQ Health Index (IAQHI).

Addition of health risk of a certain indoor air pollutant into the calculation of IAQHI shall be carefully considered due to the complication induced by potential chemical reaction between multiple air pollutants. Dominant or representative IAQ parameters (CO₂ and TVOC), or IAQ parameters which are confirmed to impose health risks (e.g. Formaldehyde (HCHO)) can be included in the calculation, yet linkage between the pollutant itself and the health effects, i.e. relationship between pollutant levels and hospital admissions rate, shall be determined through extensive survey and data collection.

Further consideration of integrating the well-developed risk assessment approaches, for example Disability-Adjusted Life Years (DALY) for quantifying the burden of mortality and morbidity due to the exposure to certain level of air pollutant (Murray and Lopez, 1996), with IAQHI to compute the %AR may expand the coverage of the application of the index to international level.

It is noteworthy that unavoidable difficulties must be encountered in evaluating the health risks regarding the effect of combined exposure to multiple pollutants. No currently available guideline is suggested to deal with such issue. Another uncertainty in identifying health effects is the fact that individuals respond differently to the same exposure of a pollutant. Susceptibility to chemicals can be largely influenced by the conditions of each individual such as gender, ethnics and health history. IAQHI takes hospital admission as the health risk, which is justified enough to minimize such concerns.

In addition, identifying the health risks related to evaluation of some indoor air pollutants such as CO₂ can be difficult, since the related health effects confirmed by far are only general and mild. Correlation between actual hospital admission and pollutant levels may require extensive and long-term health research conducted by national organizations like World Health Organization (WHO).

3. CONCLUSION

Sustainability has always been the main focus of developing Hong Kong into a world-class city. In the context of sustainable city development, provision of a healthy and comfortable environment shall be taken into consideration. IAQ has grown popular in research field in the past few decades. The establishment of statutory region IAQ control and management policy to safeguard the well-being of residents is essential. Extensive regional IAQ database has been developed in Hong Kong which is comprehensive to provide IAQ profile of Hong Kong. Collaborative work between the government, research institutes and the business sector shall be established to put the research efforts into practical use. With incentive measures and resource support by the authority, the proposed IAQ indices: IAQSI and IAQHI might be useful, practical and economical diagnostic tools for setting up a public IAQ surveillance programme as well as IAQ management policies and legislations in Hong Kong.

ACKNOWLEDGEMENT

This research project is funded by the Public Policy Research Funding Scheme from the Central Policy Unit of the HKSAR Government (Project No: 2014.A6.038.14E).

REFERENCES

- [1] Burroughs HE, Hansen SJ. *Managing Indoor Air Quality*. 5th edition. Fairmont Press 2011.
- [2] Cauli A, Dessole G, Fiorillo MT, Vacca A, Mameli A, Bitti P, Passiu G, Sorrentino R, Mathieu A. Increased level of HLA-B27 expression in ankylosing spondylitis patients compared with healthy HLA-B27-positive subjects: a possible further susceptibility factor for the development of disease. *Rheumatology (Oxford)* 2002; 41(12):1375-9.
- [3] Fisk WJ. Health and productivity gains from better indoor environments and their relationship with building energy efficiency. *Annual Review of Energy and the Environment* 2000a; 25(1):537-66.
- [4] Fisk WJ. Estimates of potential nationwide productivity and health benefits from better indoor environments: An update. Lawrence Berkeley National Laboratory Report, Chap. 4 in *Indoor Air Quality Handbook* 2000b.
- [5] HKEPD Indoor Air Quality Information Centre. *Indoor air quality certification schemes for offices and public places*. China: Hong Kong Environmental Protection Department, Government of the Hong Kong Special Administrative Region; 2003.

- [6] HKEPD. The New AQHI System – Purpose and Use. China: Hong Kong Environmental Protection Department, Government of the Hong Kong Special Administrative Region; 2013. [Online] Available at: <http://www.aqhi.gov.hk/en/what-is-aqhi/about-aqhi.html> [Accessed 28 Apr. 2016].
- [7] H.M.S.O, Great Britain. (1974). Health and Safety at Work etc. Act 1974: Elizabeth II. 1974. Chapter 37.
- [8] Jenish S, Henseler T, Nair RP, Guo S, Westphal E, Stuart P, Krönke M, Voorhees JJ, Christophers E, Elder JT. Linkage Analysis of Human Leukocyte Antigen (HLA) Markers in Familial Psoriasis: Strong Disequilibrium Effects Provide Evidence for a Major Determinant in the HLA-B/C Region. *The American Journal of Human Genetics* 1998; 63(1):191-99.
- [9] Monnet D, Breban M, Hudry C, Dougados M, Brézin AP. Ophthalmic findings and frequency of extraocular manifestations in patients with HLA-B27 uveitis: a study of 175 cases. *Ophthalmology* 2004; 111(4):802-9.
- [10] Murray CJ, Lopez AD. The global burden of disease: a comprehensive assessment of mortality and disability from diseases, injuries, and risk factors in 1990 and projected to 2020. Harvard School of Public Health on behalf of the World Health Organization and the World Bank 1996.
- [11] Raw GJ, Leaman A. Further findings from the office environment study: productivity. *Proceedings of the 5th International Conference on Indoor Air Quality and Climate. International Conference on Indoor Air Quality and Climate, Ottawa 1990*; 1:231-6.
- [12] Reagan RT, Mosteller F, Youtz C. Quantitative meanings of verbal probability expressions. *Journal of Applied Psychology* 1989; 74(3):433-42.
- [13] Robertson DS. Health effects of increase in concentration of carbon dioxide in the atmosphere. *Current Science* 2006; 90(12):1607-09.
- [14] Vick SG. *Degrees of Belief: subjective probability and engineering judgement*. ASCE Press 2002.
- [15] Wong LT, Mui KW, Hui PS. A statistical model for characterizing common air pollutants in air-conditioned offices. *Atmospheric Environment* 2006; 40(23):4246-57.
- [16] Wong LT, Mui KW, Tsang TW. Evaluation of Indoor Air Quality Screening Strategies: A Step-Wise Approach for IAQ Screening. *International Journal of Environmental Research and Public Health* 2016; 13(12):1240.
- [17] Wong TW, Ta WS, Yu TS, Lau KH, Pang SW, Wong HS. Developing a risk-based air quality health index. *Atmospheric Environment* 2013; 76:52-58.

Integrating Capital Cost with Energy Efficiency: Cost@Work

TANG Chee-khoay^a

^a CK@Work Sdn Bhd, Malaysia, ck@gbeet.com

ABSTRACT

It has always been a perception that implementing energy efficiency in buildings increases capital cost for developers. Passive features such as additional roof insulation, wall insulation, high performance glazing, daylight harvesting and etc. increases capital cost in new buildings. Active features such as variable flow, radiant cooling system, desiccant dehumidification and etc. are also seen as additional cost to developers. Compounding on to this perception is that the architects and engineers often works independently of one another, with each party often ignoring the benefits implemented by the other party.

A software was developed to integrate both the passive and active features within a simple shoe-box building scenario to provide peak cooling load computation, annual energy consumption prediction, while computing the building material/equipment capital cost at the same time. The most interesting part of this software is its ability to automatically run through a database of building material and equipment to calculate the building energy consumption and peak load of each combination. It then hunts for the lowest capital cost and/or lowest lifecycle cost of the project by calculating the combined capital cost for each of the tested combination of building material, equipment and air-conditioning selection.

A version of this software is in operation since early 2016 and has been providing indications that that in almost all cases, energy efficiency in building can be improved while reducing capital cost. In fact, capital cost reduction up to 7% of total building construction cost has been regularly demonstrated with this software, while at the same time improving energy efficiency in building.

The output from this software is a clear demonstration that a truly integrated design strategy that combines passive, active and costing features within a single platform will yield better energy efficiency at a lower capital cost for the building industry.

Keywords: building energy simulation, lifecycle assessment, energy saving

1. INTRODUCTION

There exist many buildings today that are claimed, designed to be energy efficient. However, it is still very much a market perception today that an energy efficient building is more expensive to build. One of the early successful demonstration of low energy office building in Malaysia was even documented, in 2005, to have an additional cost of 10% above the base total building construction cost.

Additional cost in an energy efficient building is largely fuelled by the increased complexities of air-conditioning equipment and better building fabric on a building. Examples of such items are:

- Variable air volume instead of constant air volume
- Variable speed chiller instead of conventional chiller
- More efficient lighting system instead of conventional light
- High performance double glazing with low emissivity instead of typical single glazing
- Increased building fabric insulation
- And more.

However, improving energy efficiency also reduces the building cooling load. A reduction in cooling load reduces the capacity (size) of air-conditioning system for a building. This lead to a reduction in capital cost. Unfortunately, there is hardly any actual case study of the actual amount of capital cost reduction due to implementation of energy efficiency in building. This leads to the perception that energy efficiency in building is expensive.

A software, Cost@Work, was developed recently that is able to address this missing link between energy efficiency and capital cost. This software is currently based on Malaysian climatic conditions and building construction practices. The software computes both capital cost and running cost instantly based on a shoe-box model allowing important decision related to energy efficiency and capital cost to be made instantly. These information, provided upfront, allows the design team to set the design direction of a building at the onset of the design stage, to optimize both capital and running cost of a building.

Finally, the benefit in being able to demonstrate a reduction in capital cost while implementing energy efficiency is immense in the engaging developers to consider sustainability in all buildings.

2. ENERGY EFFICIENCY IS COMPLEX

Energy efficiency in building design involves the selection of building fabric, lighting system, air-conditioning system, operational practices, passive cooling strategy and more. And within each major element, there are even more elements that can be optimized. For example, a building fabric will need to optimize its insulation, thermal mass, solar absorption, emissivity, shading (as in a double roof) and more. There are at least hundreds, if not thousands of opportunities for energy efficiency in a building. Due to the near limitless possibilities of energy efficiency in buildings, the task of finding the least cost and/or best lifecycle method of addressing and optimizing energy efficiency in a building is not simple.

3. ENERGY EFFICIENCY AND COOLING LOAD

An energy efficient building is often the combinations of many energy efficiency features that is implemented on a building. The Passive and Active Design Guideline provided by the Building Sector Energy Efficiency Project (BSEEP) has shown that most energy efficiency feature provides an improvement in energy efficiency in a building by an average of 1% in Malaysian conditions. The impact on peak cooling load is even less per feature wise. An energy efficiency case study made for a high-rise office tower in Malaysia showed a possibility of reducing building energy consumption over 60% with the implementation of approximately 50 energy efficiency features in the building. However, the peak cooling load reduction is only 30%. This indicates that on average the peak cooling load reduction is less than 1% per implemented energy efficiency feature.

Due to this, many (if not all) air-conditioning engineers have subliminally learned that impact of a single element or product on the cooling load is marginal at best, and therefore are always reluctant to reduce the initial design capacity of the air-conditioning system. Unintentionally, many existing energy efficient buildings have an oversized cooling system installed.

4. BUDGETING OF CAPITAL COST

Budgeting of capital cost in the development of Malaysian buildings are split into 2 categories; the building cost and; the mechanical and electrical equipment cost.

A quantity surveyor will estimate the building cost based on the architectural and **structural engineer's drawings** and specifications; while the mechanical and electrical equipment cost are estimated by the appointed trade engineering consultant. These parties often do not communicate with one another well enough. Products such as roof and wall insulation; and better glazing properties that are specified by architects and quantity surveyors are often not considered by the air-conditioning engineers.

However, these items have an influence on a building peak cooling load. And the peak cooling load of a building is the key determination of the air-conditioning equipment cost. The larger the capacity, the higher the cost will be. With the average installed cost of air-conditioning system today ranging between 10% and 20% of a building total construction cost, air-conditioning represents one of the highest single element cost in a building construction.

5. LACK OF COMMUNICATIONS

Building construction is a very complex process. It involves many parties because it is impossible for any one party to be able to design every part of a building. Over the years, the building industry has fine-tuned this process into a very lean linear system of communication between the different parties.

Putting it simply, the architect provides the drawings and specifications; and the design engineers size the necessary equipment for the building, with very little integrated design opportunity.

Most architects have little knowledge of an air-conditioning system. They have little understanding of the building fabric impact on the air-conditioning load, capital cost and running cost. However, they are the primary decision maker in charge of specifying building fabric. Meanwhile, most air-conditioning engineers have little to no interest in building fabrics, leaving the selection entirely to the architects.

6. BUILDING ENERGY SIMULATION

Building energy simulation studies have often been touted as the solution to the issues raised. Energy simulation enable studies to be made, to optimize building design on energy efficiency and cooling load. However, there are 2 major barriers that needs to be overcome for this solution to work in practice:

- Building simulation studies are complicated.
- Capital cost has not been made as part and parcel of building analysis.

6.1 Complexities in building energy simulation

Building energy simulation study is a fairly complex matter. Even with the most user friendly software in the market today, efforts are required to ensure that the defaulted values and assumptions made by the software matches with the conditions of the building and site location. This is not often the case. All of these software defaulted the values and assumptions based on the standard of practice of their primary market, such as US, UK or Europe. Buildings in other location requires significant changes to the defaulted values. It often takes up to several weeks of intensive work to ensure that the building was even modelled correctly.

Getting a building modelled correctly is not a simple process at all. A 3D model of a building is only the beginning of energy studies in a building. Information is also required on the details of the building envelope for each wall, **glazing and roof; occupant's load and profile; equipment's load and profile; lighting load and profile; type of air-conditioning system used; climatic data; phantom load assumption, elevators and controls power consumption; ventilation in car park; ventilation in toilet; outdoor air quantity; infiltration assumption and more.**

Sometime, part of basement wall is buried under the earth, part of it not. Part of the building is naturally ventilated and part of it is not. Part of a floor may be directly connected to the earth, while part of it is exposed to outdoor air. Standards on construction for walls, roof and glazing is also different from country to country. Thermal breaks requirements are different depending on the climate. Typical working hours, operational practices on lighting, air-conditioning and type of system available is also different based on site location. In short, there are thousands of numbers that need to be reviewed for each simulation study.

Furthermore, a good building energy simulation analysis requires knowledge of multiple trades. For example, a building energy simulation practitioner need to know the different types of building fabrics that is available in the market for wall, roof and glazing. This person also has to understand the properties of insulation, solar absorption, emissivity and more to be able to give good advice to a project. Information provided by manufacturer datasheet can sometimes be wrong or have units mislabeled. There is also a need to understand outdoor air requirement for each spaces and infiltration possibilities based on the construction practices at that location. There is also a need to know about the availability of various types of lighting system based on the building location.

Finally, an air-conditioning system is an extremely complex beast even for an experienced engineer. For example, the available fan and motor efficiency is different for different types of fan and flow rate. The total pressure drop of a fan is different for different types of cooling coil, air filter, distance of duct, duct size and more. Performance of a chiller efficiency at peak and part load is strongly dependent on the selected capacity of the chiller. Small chiller

typically has lower efficiency than larger chiller. Cooling tower optimization of control is different for different wet bulb condition at different location. Even developers of energy simulation software themselves do not have full understanding of the intricacies of each and every equipment. And yet there is a very unrealistic expectation in the building industry that any building architect and engineer can conduct building energy simulation studies accurately for any building in this world with the use of such complicated tool.

6.2 Lack of integration of capital cost within energy simulation

There is hardly any building energy simulation tool today that integrates capital cost into building energy simulation studies. This is a drastic loss of opportunity for these software to provide quick answers to the most important question for a building developer – which building product or strategy of operation will yield the best return on investment on this development?

Typically, the person conducting the simulation study provides the results for different options of design; other trades are then required to provide the costing on these options. This process often takes up several weeks to arrive at the final answer. The long duration of such a process poses a major limit on the number of studies that can be carried out.

7. COST@WORK

Initial version of Cost@Work was a tool called BEET, short for Building Energy Estimation Tool. It was developed in 2005 in Excel, to allow general building design practitioner an easy method to estimate building energy consumption with minimum inputs. The simplicity of input on this software encouraged the tool to be adopted by Association of Consulting Engineers Malaysia (ACEM) for Malaysian building industry. By entering easily understood data into approximately 50 cells, the software is able to make a general estimate of the yearly energy consumption for a building in Malaysia.

The annual cooling load of a building was computed using the definition of Overall Thermal Transmission Value (OTTV). The OTTV is a familiar term in South East Asia and is used by Malaysian Standard, MS 1525, since 1990s. It provides a manual method of calculating the average thermal transmission value through a building fabric over a period of a year. The original form of OTTV was developed for ASHRAE Standard 90 in 1975 and was refined again in 1980 [6][7].

An enhancement of BEET was performed in 2015 under Building Sector Energy Efficiency Project (BSEEP) in Malaysia. A stakeholder consultation was made with the building industry practitioners to seek feedback on how the new **software should work. Feedback received was to make the software 'idiot proof' rather than enhancing the software computational features.** It was highlighted that many architects and engineers do not know the correct value to enter into the software such as U-values, shading coefficient, fan efficiencies, fan total pressure, system coefficient of performance and etc.

Based on the feedback received, BEET made changes to the cooling load computation method to Ashrae Radiant Time Series Method (RTSM). The use of RTSM, allowed the software to estimate the peak and average cooling load of a building instead of just the average cooling as provided by the older version. The peak cooling load allowed an early estimation to be made by the software on the type of fan, pumps and chillers that may to be used without any the need of an expert to provide input. This prevented users from entering values that are not realistic into the analysis. In addition, input data for all technical inputs were fixed to a pull down menu to select the types of wall, glazing, roof, lighting system and etc. using well-known generic terms that is easily recognized in the building industry. Most of the pull down menu was provided based on the selection of 4 options; inefficient, typical, efficient and very efficient scenarios. These features limit the potential error a person can make by ensure that all **values entered are within reasonable range, thereby, 'idiot proofing' the software.**

In 2016, BEET version 2 was developed into Cost@Work with the primary objective of optimizing building design based on capital cost, running cost, payback period, return in investment and lifecycle analysis. A product cost database of building material, lighting and air-conditioning was added into the software. With the inbuilt cost database, Cost@Work able to run a subroutine to test each and every design option that is available in the software

to provide an estimate on net capital cost and running cost of it. A net capital cost refers to the total cost of air-conditioning system together with the building material or product selected.

The software is able to compare all options of wall, glazing, roof and etc. that is available in the database. For each element type in the database, it computes the total element capital cost, building running cost and cooling equipment cost (from the peak cooling load). The net total capital cost of the element with the cooling equipment are then analyzed together to find the best design option for the building and at the same time computing the running cost.

For example, it may compute that the use of a 100mm thick concrete wall will cost the building RM 300k for the wall and RM 17.5 million for the air-conditioning system. An insulated wall option will cost the building RM 900k for the wall and RM 16.6 million for the air-conditioning system. Analyzed individually the additional cost for an insulated wall is 300%, while the air-conditioning cost was reduced by 5%. However, when these numbers are analyzed together in absolute values, the insulated wall reduces the capital cost of the building by RM 300k, while improving energy efficiency at the same time.

This analysis is conducted for the entire database of building envelope and lighting system within minutes by the software, providing a roadmap of design options for the lowest capital cost, highest energy saving and lifecycle analysis of 5, 10 and 20 years.

In short, Cost@Work is able to provide instant documentation with engineering calculation that it is possible to improve energy efficiency in building while reducing capital cost at the same time. It provides an output that is easily understood by the building investors that are focused at their rate of return on investment.

8. VERIFICATION

While, the financial computation in Cost@Work is easily verified using a manual calculator, the verification of the software is required on its cooling load computation engine that was based on Ashrae Radiant Time Series Method.

A verification work was conducted under BSEEP project using IES<VE> and BEET version 2 software, which Cost@Work was developed from. The verification procedure follows similar methodology as Ashrae Bestest 140: **Test Procedures “Building Energy Simulation” Tools, where a range of identical design options were tested on both software and its results compared with one another.**

The verification study compares the predicted Building Energy Intensity (BEI), building yearly energy consumption in kWh/(m².year) and peak cooling load in kW of cooling power. Results of the study showed good agreement between the 2 software as shown in Figure 1 below. A detailed report on the verification study can be found within the BSEEP project.

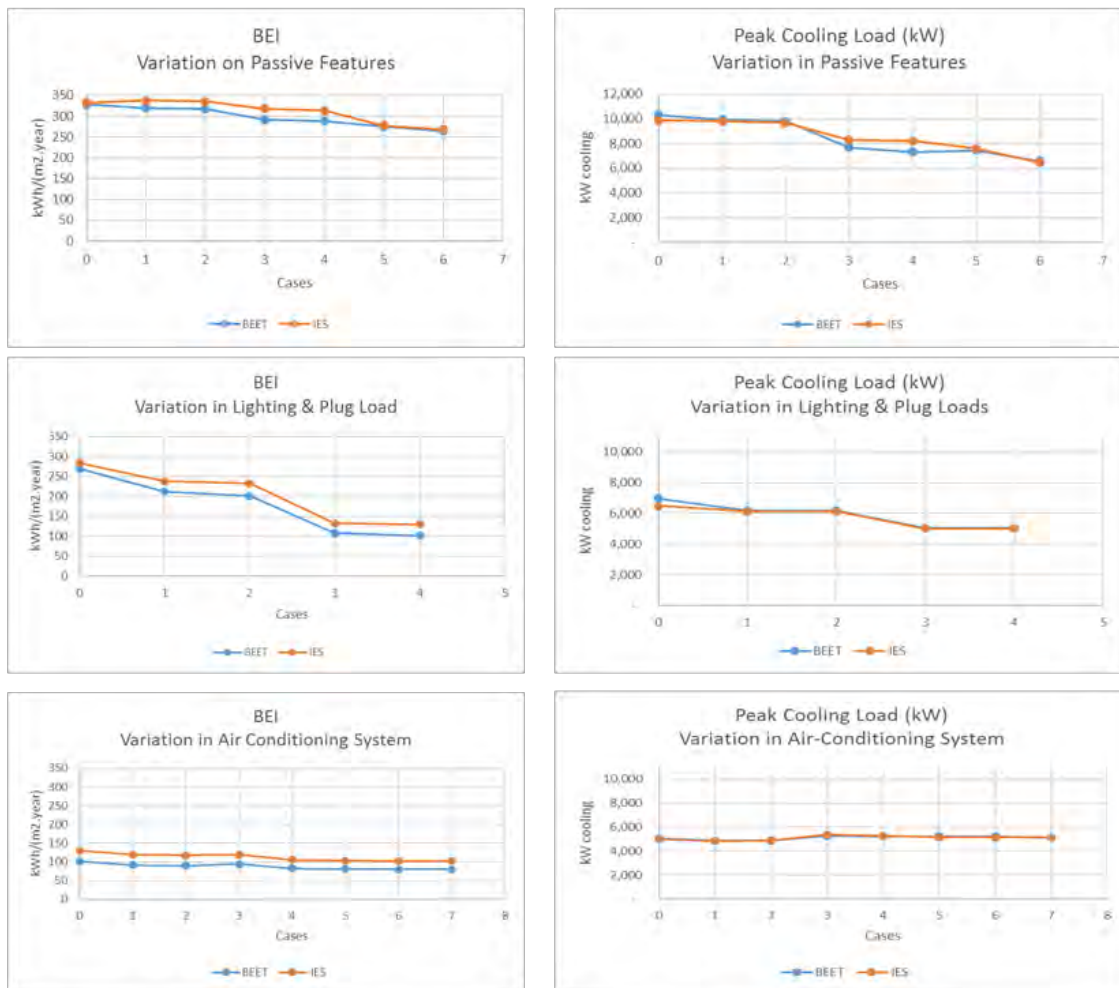

Figure 1: Verification results between IES<VE> and BEET

9. SUMMARY

Cost@Work was deliberately made simple for quick initial analysis to be conducted easily at an onset of building design development while minimizing the risk of errors in data entry. It gives immediate computation of the estimated running cost, peak cooling load and capital cost of building elements and air-conditioning system. This allowed the software to provide immediate comparison of payback, rate of return and lifecycle analysis of various design options in a building.

In addition, the language of the software was kept simple and easily recognizable by building design practitioners. This will encourage better communication between the different trade discipline, allowing consultants to understand each other easily.

As a pre-design tool, the accuracy provided by Cost@Work is more than adequate for key decision to be made early on in the design process to optimize a building capital cost and energy efficiency.

Finally, such a software encourages the building industry to pursue energy efficiency in buildings, as it can now be proven from the earliest stage of design that energy efficiency is capable of reducing capital cost when it is done right.

REFERENCES

- [1] Anish, Rahim, Ole, Steve, Tang, Low Energy Office Building in Putrajaya, Malaysia. Case Studies and Innovations, The 2005 World Sustainable Building Conference, Tokyo 27-29 September 2005, p 7
- [2] ASHRAE Standard 90 Project Committee. 'Energy Conservation in New Building Design. ASHRAE Standard: 90-1975.' American Society of Heating, Refrigeration and Air Conditioning Engineers, Inc., Atlanta, GA.
- [3] ASHRAE Standard 90 Project Committee. 'Energy Conservation in New Building Design. ASHRAE Standard: 90A-1980, 90B-1975, 90C-1977.' American Society of Heating, Refrigeration and Air Conditioning Engineers, Inc., Atlanta, GA.
- [4] BSEEP BEET Workshop Minutes dated 29 April 2015.
- [5] Jubm and Langdon Seah Construction Cost Handbook, Malaysia 2016.
- [6] Tang, 2013, Building Energy Efficiency Technical Guideline for Passive Design, Kuala Lumpur, Building Sector Energy Efficiency Project (BSEEP), Malaysia.
- [7] Tang, 2015, BEET Verification Report, Component 4 of Building Sector Energy Efficiency Project (BSEEP).
- [8] Tang, Julian, Aida, 2015, Optimizing Energy Efficiency for a High Rise Office Tower in the Tropics, Proceedings of 2015 TAU Conference: Mitigating and Adapting Built Environments for Climate Change in the Tropics. School of Architecture, Tanri Abeng University, Jakarta, Indonesia.

Session 7.7: Innovations Driving for Greener Policies and Standards – Smart Initiatives

Smart Cities: Selection of Indicators for Vitória

Carolina SIMÕES ROCON^a, Cristina ENGEL DE ALVAREZ^b

^a *Laboratory of Planning and Projects, Federal University of Espírito Santo, Brazil, carolinarocon@gmail.com*

^b *Laboratório de Planejamento e Projetos, Universidade Federal do Espírito Santo, Brazil, engelalvarez@hotmail.com*

ABSTRACT

Since 2007, urban cities have become the main living environment of humanity, as opposed to rural areas. Thus, with the increase of urban areas, it is appropriate to develop techniques for the orderly and integrated growth of the cities. The concept of Smart City arises in this context. Considering the particular challenges of each city to become a Smart City, it is necessary to select specific indicators to meet these different requirements. This article **aims to select the most adequate indicators to measure Vitória's performance as a Smart City. The European Smart Cities assessment tool was selected and studied to serve as a reference for the selection process of indicators. Afterwards, the indicators were selected based on suitability, clarity and availability criteria, and weights were assigned by their relevance, based on their compliance with the strategic goals of the city. This study suggests the indicators to measure Vitória's performance and reveals the need to improve the tool with the addition of indicators that are more suitable to local needs.**

Keywords: smart city, indicators, green rating tool

1. INTRODUCTION

In 2007, the world's urban population surpassed the rural population for the first time in history. Currently, 54% of the world population live in urban areas, and the forecast is that by 2050 this figure will reach 66%. In Brazil, the urbanization rate is even higher. Currently, 85% of the Brazilian population lives in cities, and it is estimated that by 2050 this figure will reach 91% (United Nations, 2015). Increasing urbanization inflicts obstacles to cities, as it contributes for the emergence of infrastructure, mobility, and environmental problems, and consequently affect the quality of life of the population. In this context, the Smart City concept arises, as an urban planning model aimed at the development of cities through a combination of human and technology capital (Angelidou, 2014).

Although there is no consensus about its definition, it is widely held that Smart Cities are characterized by the use of Information and Communication Technologies (ICT) in order to help cities to make better use of its resources (Neirotti *et al.*, 2014). However, despite the importance of technology, there is a need for investment in human capital for the development of an efficient strategy for Smart Cities. (Angelidou, 2015; Monfaredzadeh and Krueger, 2015). The adopted Smart City concept is based on Caragiu *et al.* (2011), who state that a city is considered to **be smart "when investments in human and social capital and traditional (transport) and modern (ICT) communication infrastructure fuel sustainable economic growth and a high quality of life, with a wise management of natural resources, through participatory governance"**.

According to Neirotti *et al.* (2014) there is some difficulty in establishing worldwide definitions and trends for Smart Cities, since the initiatives are implemented under different contexts and realities. The Smart indicators of the cities should consider specific variables that capture particular characteristics, such as local culture, political leadership, population density, economic development and climate conditions. Therefore, it is noteworthy that each city faces specific challenges, hence its Smart indicators must be particularized. In this context, the focus of this research is on the city of Vitória, Brazil. The choice of this subject matter is because this municipality has a 100% urbanised territory and a high population density, with more than 3,000 inhabitants/ km² (Oliveira *et al.*, 2014).

This study aimed to select and assign weights to assessment indicators for Vitória, according to the Smart City concept. **This set of indicators should measure the city's progress and be periodically updated. Thus, it is assumed that it is possible to evaluate Vitória's evolution in relation to the selected indicators, by providing data to the government assisting the development of specific policies and guiding investments. It is therefore expected that**

the local population be positively affected, since the Smart City attributes are aimed at sustainable development and the improvement of the population quality of life.

2. METHODOLOGY

After a literature review to establish the state of the art theme, this research was developed in three main stages. The initial stage consisted of select an assessment tools, based on specific criteria, which served as reference for the choice of indicators for Vitória (Tab. 1). The selected tool was thoroughly studied, seeking a clear understanding of its conceptual guidelines, specific goals and methodologies associated with the indicators. In the second stage, the reference tool indicators were selected, based on suitability, clarity and availability criteria. In the third stage weights were assigned to the selected indicators, judging their relevance based on their compliance with the strategic goals of the city.

There is currently no unanimity on a methodology or indicators to assess a city in relation to the Smart City concept. **In order to select the reference tool for choosing Vitória's indicators, the main urban area assessment systems** were identified, specific for Smart Cities or related to the sustainability concept. The score was given by evaluating the relevance of the criteria for the research and suitability of the tool to the criterion. For each tool, the values assigned to the evaluated items were added up, and the one with the highest score was selected as reference for the research, according to Table 1.

This research is based on the first version of the tool European Smart Cities, released in 2007. The assessment system was created in order to assess European medium-sized cities, with populations between 100,000 and 500,000 people, comparing them and identifying their strengths and weaknesses. It presents a total of 74 indicators, divided into six key features: economy, people, governance, mobility, environment and living (Giffinger *et al.*, 2007). According to Giffinger *et al.* (2007), the indicators have their values standardised by z-transform. The score of each domain is given by the simple average of the corresponding indicators. The same goes for the key features, obtained by the simple average of the domains. Thus, the indicators have equal weights.

Assessment Tool	Developed for assessment of Smart Cities	Free access to assessment methodology	Selection Criteria			Total sum
			Developed in Brazil	World-wide recognition	Academic relevance	
European Smart Cities	6	3	1	1	1	12
Connected Smart Cities	6	1	3	0.5	0.5	11
CASBEE for Cities	4	3	1	1	1	10
AQUA Bairros	2	3	3	1	1	10
Green Star Communities	2	3	1	1	1	8
LEED ND	2	1	1	1.5	1.5	7
BREEAM Communities	2	1	1	1.5	1.5	7
HQE UPD	2	1	1	1	1	6

Keys:

6	Very relevant criterion and very adequate tool	3	Relevant criterion and very adequate tool	1.5	Irrelevant criterion and very adequate tool
4	Very relevant criterion and adequate tool	2	Relevant criterion and adequate tool	1	Irrelevant criterion and adequate tool

2 Very relevant criterion and inadequate tool	1 Relevant criterion and inadequate tool	0.5 Irrelevant criterion and inadequate tool
---	--	--

Table 1: Selection of reference tool

In the second stage of the research, the reference tool was used as a source for the acquisition of indicators for **Vitória's Smart assessment**. Each item proposed by the structure was analysed according to the following criteria:

- Suitability – considers whether the indicator is adequate to assess Vitória;
- Clarity – evaluates whether the purpose of the indicator or data related to its acquisition is understandable;
- Availability – amongst the defined research sources – IBGE and City of Vitória websites – it identifies if there are similar available data.

The indicators that not fulfilled simultaneously these criteria were not eligible for the following step. After the selection of indicators for Vitória, it was deemed necessary to assign weights in order to provide a hierarchical reading of the items, facilitating the analysis in investment decisions. Thus, in the third stage of the research, the proposed system classifies each indicator according to its relevance, which is based on the relationship with the strategies presented in the 2008-2028 Agenda of the City of Vitória. Each indicator is evaluated under the perspective of the Agenda themes, and its relevance is judged based on the type of relationship they establish with them, whether direct or partial.

The Agenda is the third revision of the strategic plan drawn up according to the 1992 Rio Summit, and it was developed by a multidisciplinary technical team and representatives from various social sectors of the city. The population participated in the Agenda development through debates in seminars and surveys, signalling their main demands and expectations to the City. Thus, the document proposes strategic goals in line with the local reality. **The strategy is based on three main themes that steered the plan's guidelines (Agenda Vitória, 2016):**

- Economy – involves issues related to the dynamics of labour and production, productive investments, Science and technology, innovation, workforce qualification, specialized activities, labour market, ports and airports;
- Urban-Environmental – prioritizes issues related to the environment and urban infrastructure, such as mobility, sanitation, housing, clean energy and urban planning legislation;
- Sociocultural – addresses areas related to citizenship, human rights, social welfare, culture, education, health, security, employment and income and population dynamics.

Considering the above-mentioned criteria, weights were assigned to the indicators. First, we evaluated the relationship of each indicator with the Vitória 2008-2028 Agenda themes, considering its direct or partial affinity (Eq. 1). Then, its weight was calculated in contribution percentage for the scoring of each key feature (Eq. 2).

$$CM_i = ADR_i \times 2 + APR_i \times 1$$

Equation 1

where ADR_i = sum of the amount of themes directly related to indicator i; APR_i = sum of the amount of themes partially related to indicator i

$$IW_i = \frac{CM_i}{\sum_i CM_i}$$

Equation 2

where $\sum_i^n CM_i$ = sum of CM of all indicators of the key feature.

3. INDICATORS FOR VITÓRIA'S SMART ASSESSMENT

The second stage of the research has resulted in the identification of 39 indicators (Tab. 2). Among the excluded indicators, it is noteworthy that about 63% received a negative response only to the data availability criterion, which was the main cause of exclusion of indicators.

The third stage of the research consisted in assigning weights to the selected indicators based on the strategic themes of the Vitória Agenda. We highlight the indicator Social Welfare Return Index (Índice de Retorno de Bem-Estar à Sociedade - IRBES), which stands out with the highest relative weight in the context of its category (Governance dimension), with 46.15%. This indicator compares the tax burden to the Human Development Index (HDI), thus is directly related to the three strategic themes of the Agenda and establish a direct relationship with them. Next, with the relative weight of 27.27%, are the indicators Ratio of Students Enrolled in High Quality Courses, Percentage of Population with 13 or More Years of Schooling, and Ratio of Workers in STEM Occupations, components of the People dimension.

Table 2 presents the set of indicators for Vitória's Smart Assessment, their adaptation based on locally available data and respective weights.

Factor	Indicator	Adapted Indicator	DR	A DR	PR	A PR	CM	IW	
ECONOMY	Innovative spirit	R&D expenditure in % of GDP	E	1	S	1	3	13.64 %	
		Employment rate in knowledge-intensive sectors	E	1	S	1	3	13.64 %	
		Patent applications per inhabitant	E	1	-	0	2	9.09%	
	Entrepreneurship	Self-employment rate	Self-employed workers/Total workers	E	1	-	0	2	9.09%
		New businesses registered	New companies registered	E	1	-	0	2	9.09%
	Productivity	GDP per employed person	GDP per capita	E	1	-	0	2	9.09%
	Flexibility of labour market	Unemployment rate	Unemployment rate	E+S	2	-	0	4	18.18 %
	International embeddedness	Air transport of passengers	Embarked and disembarked passengers/Year.	E	1	-	0	2	9.09%
		Air transport of freight	Participation in national freight handling (t)/Year	E	1	-	0	2	9.09%
	International accessibility	International accessibility	Existing ports and airports	E	1	U+S	2	4	23.53 %
MOBILITY	Availability of ICT-Infrastructure	Computers in households	E+S	2	-	0	4	23.53 %	
		Broadband internet access in households	E+S	2	-	0	4	23.53 %	
	Sustainable, innovative and safe transport systems	Green mobility share (non-motorized individual traffic)	Motorization rate (Vehicles/100 Inhabitants)	U	1	-	0	2	11.76 %

Factor	Indicator	Adapted Indicator	DR	A DR	PR	A PR	CM	IW	
	Traffic safety	Total number of traffic accidents (with or without victims)	U	1	S	1	3	17.65 %	
ENVIRONMENT	Attractivity of natural conditions	Sunshine hours	-	0	U	1	1	7.14%	
		Green spaceshare	U	1	-	0	2	14.29 %	
	Pollution	Particulate matter	Annual square meters of green area per capita (annual measure)	U	1	-	0	2	14.29 %
		Fatal chronic lower respiratory diseases per inhabitant	Annual daily average of PM10 concentrations ($\mu\text{g}/\text{m}^3$)	U	1	-	0	2	14.29 %
	Sustainable resource management	Efficient use of water (use per GDP)	Number of deaths from respiratory diseases per 10,000 inhabitants	S	1	U	1	3	21.43 %
		Efficient use of electricity (use per GDP)	Average estimated water consumption in $\text{m}^3/\text{inhabitant}$, per month	U	1	E	1	3	21.43 %
			Average consumed electricity, in $\text{kwh}/\text{inhabitant}$, per month	U	1	E	1	3	21.43 %
PEOPLE	Level of qualification	Importance as knowledge centre (top research centres, top universities, etc.)	S	1	E	1	3	27.27 %	
		Population qualified at levels 5-6 ISCED	S	1	E	1	3	27.27 %	
	Social and ethnic plurality	Share of foreigners	Ratio of students enrolled in high-quality courses (4 and 5 ENADE scores)	-	0	S	1	1	9.09%
		Share of nationals born abroad	Percentage of population with 13 or more years of schooling	-	0	S	1	1	9.09%
	Creativity	Share of people working in creative industries	Foreigners living in the state/10,000 Inhabitants	E	1	S	1	3	27.27 %
LIVING	Cultural facilities	Ratio of workers in STEM occupations (Science, Technology, Engineering, Mathematics)	S	1	-	0	2	8.70%	
	Health conditions	Theatre attendance per inhabitant	Audience of the National Theatre Festival of Vitória/1,000 Inhabitants	S	1	-	0	2	8.70%
		Life expectancy	Life expectancy at birth	S	1	-	0	2	8.70%
		Hospitals beds per inhabitant	Inpatient beds in public and private health facilities/1,000 Inhabitants	S	1	-	0	2	8.70%
	Doctors per inhabitant	Number of doctors/10,000 Inhabitants	S	1	-	0	2	8.70%	

Factor	Indicator	Adapted Indicator	DR	A DR	PR	A PR	CM	IW
	Satisfaction with quality of health system	Positive assessment of emergency care at home or hospitalization for 24 hours or more by the public health system (SUS)	S	1	-	0	2	8.70%
Individual security	Crime rate	Homicides per 100,000 Inhabitants	S	1	-	0	2	8.70%
	Death rate by assault	Armed robbery per 100,000 Inhabitants	S	1	-	0	2	8.70%
Housing quality	Share of housing fulfilling minimal standards	Percentage of households served by the sanitation system network	U	1	S	1	3	13.04 %
Touristic attractive-ness	Overnights per year per resident	Hotel occupancy rate	E	1	S	1	3	13.04 %
Economic welfare	Poverty rate	Incidence of poverty	E	1	S	1	3	13.04 %
GOVERNANCE	Participation in decision-making	City representatives per inhabitant	-	0	E+ S+ U	3	3	23.08 %
		Share of female city representatives	-	0	S	1	1	7.69%
	Public and social services	Expenditure of the municipal per resident in PPS	IRBES (Índice de Retorno de Bem-Estar à Sociedade – Social Welfare Return Index)	E+S +U	3	-	0	6
	Share of children in day care	Percentage of enrolment compared to demand	S	1	E	1	3	23.08 %

Table 2: Indicators for Vitória's smart assessment

Keys: DR directly related, PR partially related, E economical axis; S sociocultural axis, U urban-environmental axis, ADR amount directly related, APR amount partially related, CM calculation method, IW indicator weighting

4. FINAL CONSIDERATIONS

This article is the first step to develop an assessment tool for Vitória under the Smart City concept. The development of a consistent assessment tool requires the selection of relevant indicators, aligned with the defined goals and targets (Hák *et al.*, 2015). Amid a large number of indicators, it is assumed that the first step in the **development of the assessment framework is to define the city's strategy, in accordance with the adopted concept** of Smart City and Sustainable Development Goals. The importance of defining city level strategies is stressed, due to the relevance of local characteristics and challenges (Shen *et al.*, 2010). The Vitória Agenda defines the strategy at the local level and displays important diagnostics and considerations. However, it is not clear as to setting goals and targets to be achieved, hindering the selection of indicators.

The main challenge of the research was the access to reliable information, especially at the local level. In some cases, the use of the metropolitan region or state data was accepted, in order to not hinder the work, since the percentage of excluded items for lack of similar data was high. The data sources used for this research are public databases, and their publication, in general, does not occur on an annual basis, which also makes it difficult to obtain updated data.

The high weight assigned to the indicator IRBES may have occurred because the Governance dimension has a lower amount of items when compared to the others. Thus, for a proper assessment, the need to add new indicators to this dimension is clear, in order to achieve a better balance in the allocation of weights.

By analysing the proposed indicators for the European medium-sized cities, the authors emphasise the difference between their development levels compared to the Brazilian cities. The tool used as reference does not address issues that correspond to recurring problems in Brazil, such as illiteracy and infant mortality. Thus, the need to continue the research is realised, in order to, once again, supplement the list of indicators with new items according to the local reality, grounded on other existing assessment tools.

REFERENCES

- [1] Agenda Vitória [online]. Retrieved from: http://www.vitoria.es.gov.br/prefeitura/gestao-compartilhada#a_agendavitoria [Retrieved on 15 May 2016].
- [2] Angelidou, M., 2014. Smart city policies: A spatial approach. *Cities*, 41, S3-S11.
- [3] Angelidou, M., 2015. Smart cities: A conjuncture of four forces. *Cities*, 47, 95-106.
- [4] Caragliu, A., Del Bo, C., and Nijkamp, P., 2011. Smart Cities in Europe. *Journal Of Urban Technology*, 18(2), 65-82.
- [5] Giffinger, R. Fertner, C. Kramar, H. Kalasek, R. Pichler-Milanovic, N. Meijers, E. 2007. Smart Cities: Ranking of European medium-sized cities. Vienna University of Technology, Vienna.
- [6] **Hák, T., Janoušková, S., and Moldan, B., 2015. Sustainable Development Goals: A need for relevant indicators. *Ecological Indicators*, 60, 565-573.**
- [7] IBGE – Instituto Brasileiro de Geografia e Estatística [online]. Retrieved from: www.ibge.gov.br/home [Retrieved on 20 May 2016].
- [8] Monfaredzadeh, T. and Krueger, R., 2015. Investigating social factors of sustainability in a smart city. *Procedia Engineering*, 118, 1112-1118.
- [9] Neirotti, P., De Marco, A., Cagliano, A.C., Mangano, G., and Scorrano, F., 2014. Current trends in Smart City initiatives: Some stylised facts. *Cities*, 38, 25-36.
- [10] **Oliveira Junior, A.P., Santos, A.C., Monteiro, L.L., and Bergamaschi, R.B. 2014. “A metrópole na rede urbana brasileira e na configuração interna”, in Lira, P., Oliveira Junior, A.P., and Monteiro, L.L. (Eds), Vitória: Transformações na Ordem Urbana, Letra Capital, Rio de Janeiro, pp. 25-56.**
- [11] Prefeitura de Vitória [online]. Retrieved from: www.vitoria.es.gov.br [Retrieved on 20 May 2016].
- [12] Shen, L. et al., 2010. The application of urban sustainability indicators – A comparison between various practices. *Habitat International*, 35, 17-29.
- [13] United Nations. 2015. World Urbanization Prospects: The 2014 Revision. Department of Economic and Social Affairs, New York.

Establishing Smart Cities for Sustainability: An Analysis of the Japanese Innovation System and Implications for Asia

Masaru YARIME^a

^a City University of Hong Kong, Hong Kong SAR, yarimemasa@gmail.com

ABSTRACT

Smart cities are considered to be one of the key areas in which innovation is expected to play a crucial role in making a transition towards urban sustainability. They require effective integration of a variety of science and technological knowledge through collaborating with various stakeholders in academia, industry, and the public sector. Smart cities, based on advanced systems of hardware and software for mutual exchanges of energy and information between supply and demand sides, will play a crucial role in implementing sustainability in Asia. Innovation systems of smart cities exhibit a significant degree of diversity in knowledge, actors, and institutions. In this paper, we examine technological innovation systems of smart cities in Japan and discuss its implications for Asia. Bibliometric analysis of scientific and project documents in Japan reveal that knowledge domains basically concern renewable energy, energy storage, community energy management, and applications for home appliances and electric vehicles. Network analysis of actors suggests a concentrated structure dominated by large actors, particularly government organizations and electric and electronic companies. Policies and regulations influencing the innovation system include economic incentives to promote renewable energy, liberalization of energy markets for new entrants, participatory road-mapping on key component technologies, demonstration projects incorporating local conditions, platform creation for stakeholder partnerships including academia, industry, government, and end users, and standard setting for smart meters and equipment. Policy for facilitating communication and engagement with end users would be particularly important for implementing innovation on smart cities.

Keywords: smart grid, innovation system, stakeholder collaboration

1. INTRODUCTION

Smart cities are considered as a key area where innovation plays a critical role in making a transition towards urban sustainability. A smart city involves an advanced technological system for efficient, flexible, and resilient energy supply and applications, incorporating the behavior of the actors including generators, distributors, technology developers, and consumers through an intelligent network. Improvement in the efficiency of energy consumption will reduce emissions coming from energy generation, particularly those from coal power plants. Flexibility in balancing energy supply and demand through smart meters and affiliated technologies will facilitate the introduction of renewable energy sources such as solar and wind, substituting pollution-laden fossil fuels. Electrification of urban infrastructure will also support the deployment of electric vehicles, which do not emit pollutants unlike the conventional vehicles driven by internal combustion engines. In these ways smart cities are expected to make a significant contribution to coping with the serious issue of air pollution currently observed in many urban areas.

As a diverse mixture of hardware as well as software are involved in a complex way, however, a variety of approaches would be possible to implementing the concept of smart cities in practice, depending on the economic, social, and environmental conditions. In-depth examination is not yet conducted on the processes of creating innovation on smart cities in different national contexts. Policy and strategic implications of the experiences of the industrialized countries will be particularly important for many countries in Asia, where urbanization is proceeding rapidly in many major cities, posing a formidable challenge of tackling air pollution.

This research is aimed at examining the processes of implementing innovation on smart cities in different countries, particularly focusing on Japan and the United States. Detailed analysis is conducted on what actors are involved at which stages of innovation, what factors influence the behaviour of the actors, and what effects and impacts are made by policy interventions. Projects on smart cities in Japan are analyzed with regard to the actors involved, the technological areas emphasized, and the processes in which the actors collaborate with each other. Information was collected through various sources, such as project reports, academic articles, corporate reports, trade journals,

and web sites, and interviews were conducted with relevant stakeholder, including academia, firms, industry association, and government organizations. The framework of technological innovation systems (TIS) is applied for analyzing smart cities, in terms of the functions identified for TIS, including knowledge development and diffusion, guidance of the search, resource mobilization, entrepreneurial experimentation, market formation, legitimation, and development of positive externalities. **Based on the analysis of Japan's experiences, implications** are discussed for policy options and approaches for making a transition towards urban sustainability in Asia.

2. TECHNOLOGICAL INNOVATION SYSTEM OF SMART CITIES

The concept of smart city hence would vary, used by a variety of actors and scholars to describe different kind of technological assemblages. As such, it is not surprising that there are differences in the nuance of the concept in different contexts. In Europe a focus is given on creating an infrastructure that can use information collected and distributed among all connected users, to ensure that the various objectives of the electricity grid are achieved in a more intelligent way. In the United States there is a specific emphasis on security, involving key features such as self-healing and resilience against physical and cyber threats. Because the functionalities discussed as part of the smart city are many, there is also a breadth of benefits envisioned for society when a smart city is implemented. Potential benefits include higher overall energy efficiency, lower cost of operating the electricity grid, lower environmental impact, higher resilience of the energy system and more empowerment to end-users in the energy system. Given the desirability of these benefits for societies facing climate change and increasing energy prices, and the high hurdles such a complex systemic technology area faces, it is important that governments facilitate the introduction of smart cities. Many efforts towards this end have been taken, and this study aims to take a macro-level view of efforts in two countries, Japan and the United States, to extract valuable lessons for governments and entrepreneurs seeking to promote smart cities.

Macro-level studies of innovation on smart cities are very few, given the short time span in which smart cities have evolved, with only a few studies taking policy perspectives (Lin, Yang, and Shyua, 2013). This study, instead, aims to create a holistic view to smart city innovation. One of the major analytical approaches to studying innovation processes is the approach of technological innovation system (TIS). The TIS framework emerged from the innovation systems field, which itself was created upon the notion that not only activities by firms and researchers determine the character of technological change, but also broader societal structures. The idea of the system of innovation was originally developed to examine the functioning of national systems of innovation, particularly how governments could actively promote innovation through linking different stakeholders in the national context. Traditionally, researchers working on the system of innovation have focused on the role of firms, government and knowledge institutes within the innovation system. The experience of the last decades, however, has shown that other influences, such as activities by end users and discourses in society, can also have an important role in driving innovation.

In an attempt to investigate such broad societal structures, TIS aims to capture the activities directed toward development, diffusion and use of a particular technology (Bergek, Jacobsson, Carlsson, Lindmark, and Rickne, 2008). **A TIS is defined as “a network or networks of agents interacting in a specific technology area under a particular institutional infrastructure to generate, diffuse, and utilize technology”** (Carlsson and Stankiewicz, 1991). It is stressed that it is the analysis of the functions that should receive the most attention, as the aim of a TIS is to fulfil its functions, rather than to achieve a structure. TIS is often regarded as a problem-solving discipline, and many scholars in this field are preoccupied with finding ways to accelerate and enhance innovation processes. Therefore, TIS has mostly been applied to the study of green innovation, which is taken to have a clear positive societal value. Examples include wind turbines in the Netherlands and Denmark, renewable energy systems in Germany, Sweden, and the Netherlands, and renewable vehicle fuels.

A smart city involves an advanced technological system for efficient, flexible, and resilient energy supply and applications, incorporating the behavior of the actors including generators, distributors, technology developers, and end users in a complex way. To capture a broad understanding of the processes of introducing and implementing innovation on smart cities in Japan and the US, interviews were made with experts from different stakeholder groups, including academia, firms, industry association, and government organizations. Each interview explored the seven sub-processes of a TIS, focusing on an appraisal of the existence of drivers or obstacles in the different sub-processes. These are knowledge development and diffusion, guidance of the search, resource mobilization,

entrepreneurial experimentation, market formation, legitimation, and development of positive externalities. A case study approach was adopted because of the exploratory nature of the study.

3. ANALYSIS OF THE JAPANESE INNOVATION SYSTEM ON SMART CITIES

The Japanese government interest in smart grid grew out of the government's promotion of renewable energy sources, an area in which Japan was an early champion. In the first decade of the millennium the New Energy Development Organisation (NEDO), a governmental agency under the Ministry of Economy, Trade and Industry (METI), promoted domestic projects aiming at developing grid-connecting technologies for renewable energy projects. Projects supported included clustered photovoltaic (PV) generation, mega solar generation, wind power stabilizing and power quality management, and micro grids. These projects were not carried out under the label of smart grid, but touched upon some of the functionalities now associated with smart grid. In 2010, smart grid innovation efforts started when METI launched four large-scale smart grid demonstration projects in different areas **of Japan. These were called "Next-Generation Energy and Social Systems Demonstration Areas," later known as "Smart Cities."** The projects are all based on a strong role of local authorities and one coordinating corporation per project, which receives support from METI and coordinates with other partners, and focus on creating practical examples of different smart grid technologies. Other smart grid innovation efforts in Japan have been mainly conducted by potential vendors of smart grid technology, often in collaboration with other enterprises, such as supermarket chains and real estate developers.

Many government organizations are involved in smart grid innovation in Japan. Among them, METI is the most prominent actor, having a broad portfolio of relevant policy areas. Traditionally characterized by a strong relationship with the **business sector, METI's main mission has been to support the development of the Japanese industry.** Situated under METI, the New Energy and Industrial Technology Development Organization (NEDO) is **Japan's largest public R&D funding and management organization.** As one of the responses from the government to the oil crisis of the 1970s, NEDO was formed in 1980 to promote the development and diffusion of new energy technologies in Japan. Prior to the year 2000, NEDO-supported research on electricity grids focused on extending grid connection to single producers of renewable energy. In the first decade of the new millennium, NEDO shifted its focus to inclusion of large-scale, multiple renewable energy producers. Since 2010, a broader focus has been made on the concept of **"smart communities," with more attention to consumer-domain technologies** (Morozumi, 2010).

METI and NEDO conduct their smart grid innovation efforts in close collaboration with the business sector. Local governments, especially the cities that were allocated financial resources through the Japan Smart Cities project and the Future Environment City project, are very active in the smart grid activities. Several cities have partnered with private companies or universities; for example, Fujisawa is partnering with one of the largest electronic companies in Japan, Panasonic, and Toshima ward in Tokyo has collaborated with the Tokyo Institute of Technology.

The most important actors in Japanese smart grid efforts are large firms with strong corporate networks, such as Hitachi, Toshiba, and Mitsubishi. The size of these companies and their networks with other firms provide them with access to expertise in various aspects of smart grid technologies (Office of Energy and Environmental Industries, 2012). Because of their large portfolios of business activities, these companies tend to take a broader definition of smart grid, referring to it as part of smart communities, with many products and services available for residential end-users of electricity. Companies and consultancies in the information and communication technology sector are also active, mostly in the development and provision of software components and services. Residential developers and department stores are also important stakeholders, as they aim to provide customers with additional services and potential for cost reduction through installing smart grid technologies.

While regional monopolistic utilities still control most of Japan's **electricity system, they are currently operating in a very uncertain and economically difficult situation** since the Fukushima nuclear accident. TEPCO, the largest of the utilities in Japan and one of the largest utilities in the world, previously did not show much enthusiasm about smart grid. Prior to the Fukushima disaster, it was argued that Japanese grid was based on the world-class technology and thus smart grid would not be very necessary (Dasher, 2012). In the post-Fukushima era, the financial standing of the utilities would make it difficult for them to make much engagement.

Japan Smart Community Alliance (JSCA) was formed by METI and NEDO, which hosts the secretariat, in April 2020, following the recommendation of a roadmap produced internally that international standardization efforts were needed. By February 2013, 408 companies have joined the organization, with Toshiba serving as the president (Japan Smart Community Alliance, 2013).

The Energy Conservation and Homecare Network (ECHONET) Consortium is a network of private companies in the area of smart housing. Active since 1997, the consortium has developed communication standards for smart appliances, which are open and universal, to promote the emergence of home networks connected to these smart appliances (ECHONET Consortium, 2013a). As of January 2013, the consortium has eight core members representing some of the largest electronics producers in Japan, including Panasonic, Sharp, and Toshiba, as well **as Japan's largest utility company, TEPCO** (ECHONET Consortium, 2013b). After its establishment, ECHONET experienced a steady decline of activities in the early 2000s, as consumer interest in smart appliances remained quite low, and a proliferation of communication protocols meant high cost and uncertainty for vendors. In 2011, the consortium released an enhanced and WiFi-based standard, ECHONET-lite, which was swiftly endorsed for the home energy management system (HEMS) by the Japanese government, with financial support provided to HEMS adopting the standard. This led to a sharp spike in interest and membership in the ECHONET consortium.

In some areas, local associations have been established for private companies and research institutes involved in smart grid or smart house developments. One example is the Yokohama Smart Community Association, which was created following the beginning of the Yokohama Smart City project. It is an association of local small and medium enterprises (SMEs) working in collaboration with smart grid initiatives and acting as suppliers for some of the corporations involved.

To examine the network structure of the actors in the field of smart cities, data on projects and consortia related to smart grid was collected through trade journals, research reports, web sites, and interviews with relevant stakeholders. As a result, a database was constructed with 22 projects and two consortia. Network analysis was conducted to identify key stakeholders in Japanese smart grid innovation and to analyze the relationships between them. In the network, when multiple organizations join the same joint project, they are connected with each other.

The key actors identified from the network analysis are mainly large conglomerates with broad portfolios, covering both electronics and infrastructure areas. They are also members of both JSCA and ECHONET and are participating in several demonstration projects. The top two, Hitachi and Toshiba, are of particular importance, and the government funding agency NEDO also plays a prominent role in the network. The large electric utilities, on the other hand, are not centrally connected in the smart grid network, and their presence is relatively invisible. This is a distinctive feature of the Japanese network of the actors involved in the network on smart grid, in comparison to the U.S. network.

Knowledge creation and diffusion is considered to be one of the key functions of a TIS. It encompasses the creation of different kinds of knowledge concerning scientific, technological, market, and institutional dimensions. In Japan, the respondents overall rated the situation on the knowledge creation and diffusion process as moderately positive. The Smart City projects are regarded as especially important collaborative platforms in which novel technological functionalities could be tried out. While the tightly knit groups involved in the Smart City projects are producing valuable knowledge, the sharing of that knowledge is still limited. Within the smart house and appliances sector, knowledge creation has proceeded further and diffusion platforms have seen as better developed, especially since the Fukushima disaster, after which the government started to promote standardization and to provide financial support to consumers for purchasing home energy management systems (HEMS).

The function of guidance of the search refers to the way in which society creates incentives for a certain type of technology to emerge from a TIS. If this function is performing well, there is a clear common understanding of the expectation and probabilities of technology development and diffusion, shared by industry actors, the government and consumers. This is particularly important as it addresses the often-overlooked phase of interactions among different groups of interest and power within innovation processes. While a more vague vision could be helpful to mobilize a broad coalition, if the interpretative flexibility is too great, the innovation system will not be pulling in the same direction and therefore will not be effective as a system. In Japan the process of the guidance of the search has been performing relatively well, as there is a shared understanding about the basic concept and acceptance of smart grid, although the emphasis varies to a certain extent between different stakeholders. NEDO has been

regarded as the most important actor in facilitating consensus building. As NEDO manages the financial resources for many of the demonstration projects on smart grid, it has a significant amount of capacity to influence the focus and direction of the development of smart grid technologies.

Innovation requires different kinds of capital and assets in order to proceed. Financial and human capitals are the most important among these, and resource mobilization is crucial in enabling innovation. The financial resources provided by METI and NEDO to smart grid projects has functioned as an important stimulus for smart grid innovation, especially through funding the Smart City projects. After the Fukushima accident, in particular, many of the electric utilities have very low financial capabilities to initiate and implement new technological development. This has directly affected their engagements on smart grid that had already existed. The activities of the electric utilities that are still on-going are mostly funded by government grants, which illustrate the significant role played by this function for keeping the momentum on innovation.

Entrepreneurial experimentation refers to experiments carried out by the actors who intend to utilize smart grid technologies to implement something novel for achieving their aims. Their activities would be indispensable for a process to be innovative. From a societal perspective, the experimentation of entrepreneurs would make uncertainty about the development and use of technology lower, as they create hard evidence for the likelihood of success or failure of certain types of technology. In Japan this function has been performing relatively poorly. While established manufacturing firms are making efforts to tap into new markets, the current monopolistic structure of the electricity market and the uncertainty about future policies and regulations discourage ambitious activities of entrepreneurship. Moreover, the membership in the smart grid projects remains relatively closed, with new entrants very limited, and smart grid tends to be regarded as a field giving advantage to the established industrial giants. The smart house and appliance sector sees more involvement and engagement by smaller firms, in addition to the large electronic companies.

For the benefits of innovation to become widespread, a market for technologies needs to be created and developed. As an emerging TIS often has only a very small and weak market, particularly at an initial stage, a strong expectation of market formation in the future with ample possibilities and opportunities for profit making will accelerate the process of innovation. The creation of a market for smart grid technologies in Japan is at this moment considered to face many problems and challenges. While there exists a very limited market, it is still in a very early stage, and the uncertainties surrounding the current environment and future development of the electricity market make potential investors wary. In the smart home and appliances sector, the market has developed further and some demand has already been emerging. Residential developers have played a key role in popularizing various applications for smart home and appliances. The residential developers, however, while actively engaged with the concept of smart home and appliances, only cater to the upper-income groups, with HEMS remaining relatively expensive. The high prevalence and popularity of residential photovoltaics in Japan has also been an important driver for the smart house market.

The creation of legitimacy refers to the process in which technologies become socially accepted and institutionally incorporated into the legal system. When this function is not fulfilled, search guidance and market formation would not be effective ultimately, and regulatory barriers can create obstacles to innovation. In the case of Japan the creation of legitimacy has not been a serious problem for facilitating innovation on smart grid. Although knowledge about smart grid is not necessarily shared in the general public, energy efficiency has basically been understood as an area to be supported since the oil crises in the 1970s. Particularly the planned outages by the electric utilities following the Fukushima accident received strong criticisms, as regions of less economic importance had to endure more blackouts. Accordingly, through smart grid technologies that are considered to contribute to reducing energy consumption are socially accepted, without much resistance based on concerns about privacy or health effects. In the smart house and smart appliance sector, the situation has been less problematic, as smart appliances are generally appreciated by consumers for the benefits to be provided by these technologies.

Empirical studies have shown that the existence of complementary innovation systems is important for a TIS to be successful. For example, the success of civilian nuclear power technology benefited greatly from the advances in nuclear weapon technology, even though they basically belong to two distinctive innovation systems. Similarly, the development of positive externalities has also been observed in the evolution of technologies on smart grid. A crucial area of co-evolutionary development is the fast-developing field of smart home and appliances. The appliance manufacturers who also have interests in the grid equipment market have been the most active

stakeholders in the technological innovation system on smart grid. The electric vehicle (EV) has also been an innovation area of critical importance, and while being at a too early stage to contribute significantly, EV will benefit considerably from smart grid innovation. Renewable energy development has also been an adjacent innovation area. The influence of renewable energy is still relatively small, however, as the electric utilities currently allow only limited amounts of electricity to be connected to the grids, because of the concern about the grid capacities to absorb the fluctuation and interruption of the electricity produced by renewable energy sources, particularly solar power.

REFERENCES

- [1] Bergek, Anna, Staffan Jacobsson, Bo Carlsson, Sven Lindmark, and Annika Rickne (2008). "Analyzing the Functional Dynamics of Technological Innovation Systems: A Scheme of Analysis." *Research Policy*, 37, 407-429.
- [2] Carlsson, B and R Stankiewicz (1991). "On the Nature, Function, and Composition of Technological systems." *Journal of Evolutionary Economics*, 1, 93-118.
- [3] Dasher, Richard B (2012). "The Outlook for Smart Grids," *Fresh Currents - Japan's flow from a nuclear past to a renewable future*. Kyoto: Kyoto Journal, Heian-kyo Media.
- [4] ECHONET Consortium (2013a). "Application Areas." Retrieved on February 12, 2013. ECHONET Consortium. <http://www.echonet.gr.jp/english/echo/application.htm>.
- [5] ECHONET Consortium (2013b). "List of Members." Retrieved on February 12, 2013. ECHONET Consortium. <http://www.echonet.gr.jp/english/membership/kiqyo.htm>.
- [6] Japan Smart Community Alliance (2013). "Membership (as of February 8, 2013)." Retrieved February 13, 2013. Japan Smart Community Alliance: <https://www.smart-japan.org/memberslist/tabid/189/Default.aspx>.
- [7] Lin, Chen-Chun, Chia-Han Yang, and Joseph Z Shyua (2013). "A comparison of innovation policy in the smart grid industry across the pacific: China and the USA." *Energy Policy*, 57, 119-132.
- [8] **Morozumi, Satoshi (2010). NEDO's Grid Connection Related Research Activities. Expert Group on New and Renewable Energy Technologies.**
- [9] Office of Energy and Environmental Industries (2012). "Japan's Electricity Market and Opportunities for U.S. Renewable Energy and Smart Grid Exporters." Market Intelligence Brief, Manufacturing and Services, International Trade Administration, Department of Commerce, United States.

PLUSQUA: Potential of Neighbourhoods to Reduce Thermal and Electrical Loads

Diego HANGARTNER^a, Matthias SULZER^b, Stefan MENNEL^c, Urs-Peter MENTI^d

^a Lucerne University of Applied Sciences and Arts, Switzerland, diego.hangartner@hslu.ch

^b Lucerne University of Applied Sciences and Arts, Switzerland, matthias.sulzer@hslu.ch

^c Lucerne University of Applied Sciences and Arts, Switzerland, stefan.mennel@hslu.ch

^d Lucerne University of Applied Sciences and Arts, Switzerland, urs-peter.menti@hslu.ch

ABSTRACT

Buildings in an urban context can hardly achieve positive primary energy balances throughout a year due to the relative high density in the neighbourhood: low ratio roof area to floor area (low active use of solar energy) and shading through other buildings (low passive use of solar energy). For this reason, renovations on individual buildings shall be assessed in an overall concept at neighbourhood scale, expanding thus the considered system boundary. The aim of the project is to evaluate the additional benefit of specific typological, user-specific and technical interventions in terms of maximal thermal and electrical loads for the neighbourhood compared to a single house.

A typical Swiss urban neighbourhood with a representative utilisation mix has been chosen in Cham in the canton of Zug to analyse the change of its thermal and electrical loads for different scenarios.

- Utilisation mix: Substitution of 20% and 50% office buildings into residential buildings.
- Densification: Increase of 20% and 50% space heating area in the neighbourhood.
- Efficiency (Renovation): Renovation of 20% and 50% of the actual building stock.
- Decentralised production: Impact of 0% up to 100% roof coverage of photovoltaics.
- Storage: Benefit of an ideal daily thermal or electrical storage.

The criteria used to define the additional benefits of each scenario were the highest yearly average daily load and the ratio between daily maximum load and daily mean load.

The results show that the technical measures clearly have most impact on the peak load reduction, but due to their high costs, resulting in the present low retrofit rates, spatial planning measures present a good option to help mitigate thermal (-10%) and electrical (-17%) loads without major effort.

Keywords: smart neighbourhood, transformation building park, load management

1. INTRODUCTION

Buildings in an urban context can hardly achieve positive energy balances throughout a year due to the relative high density in the neighbourhood: ratio roof area to floor area (low active use of solar energy) and shading through other buildings (low passive use of solar energy). Depending on their location, plus energy buildings are not even desirable, since they unnecessarily stress the electricity grid. For this reason, renovations on individual buildings shall be assessed in an overall concept at neighbourhood scale, expanding thus the considered system boundary.

The aim of the project is to evaluate the additional benefit of the neighbourhood compared to a single house for specific typological, user-specific and technical interventions.

2. METHOD

2.1 Choice of the neighbourhood

The following requisites were set in order to define the typical neighbourhood of the suburban agglomeration of Switzerland:

- Frequent typology in urban areas.
- High share of residential buildings with a retrofit potential.
- Potential to change the utilisation mix in the neighbourhood or in the surrounding area.
- Potential for densification of the neighbourhood.

After analysing more than hundred neighbourhoods, “Cham Ost” near Zug has been chosen (Figure 1).

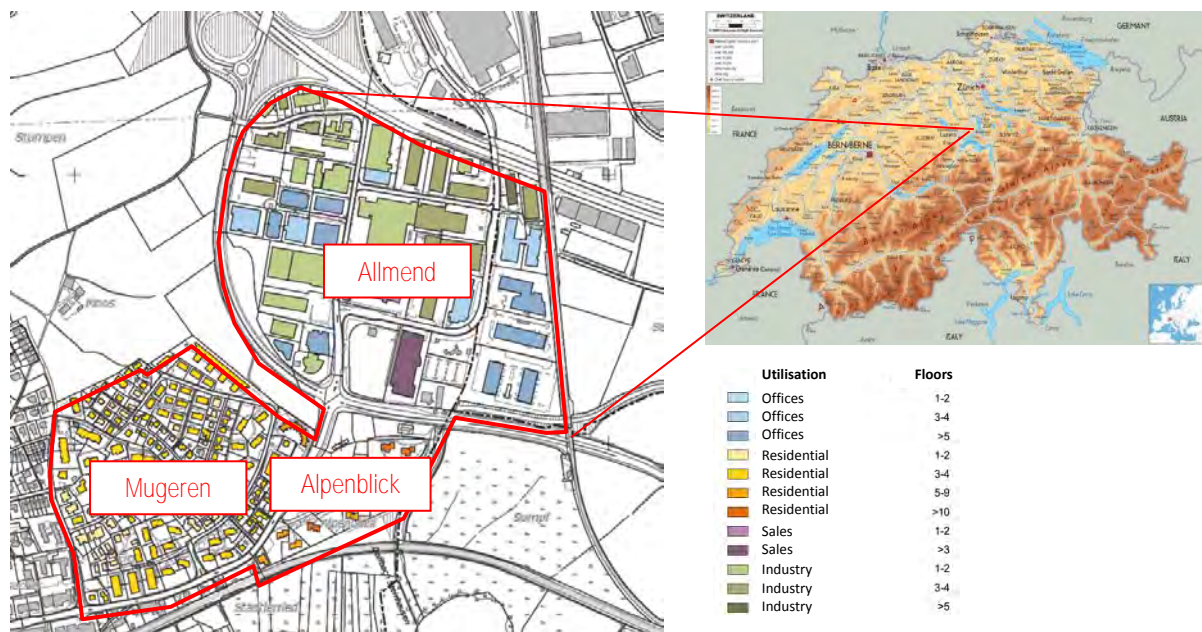

Figure 1: Neighbourhood “Cham Ost” near the city of Zug divided into three subareas, Allmend (offices, sales and industry), Mugerren (residential buildings) and Alpenblick (high-rise buildings)

2.2 Criteria for the evaluation

The criteria used to define the additional benefits of the intervention measures were the highest yearly average daily load and the difference between energy demand and energy supply (= energy consumption) (Figure 2).

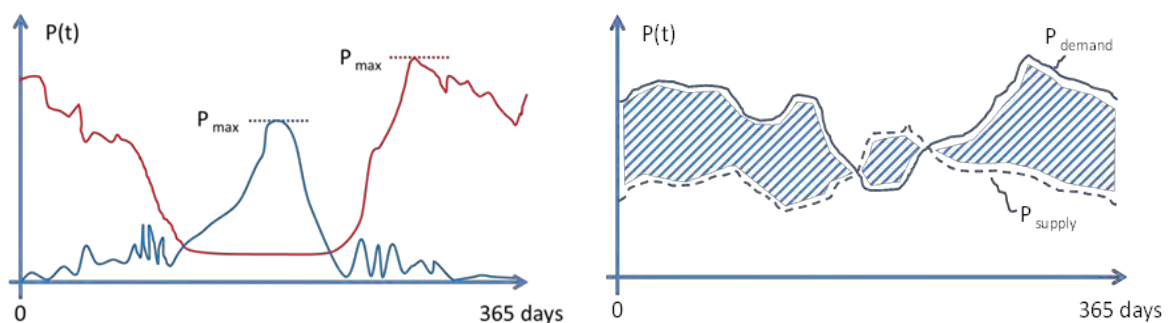
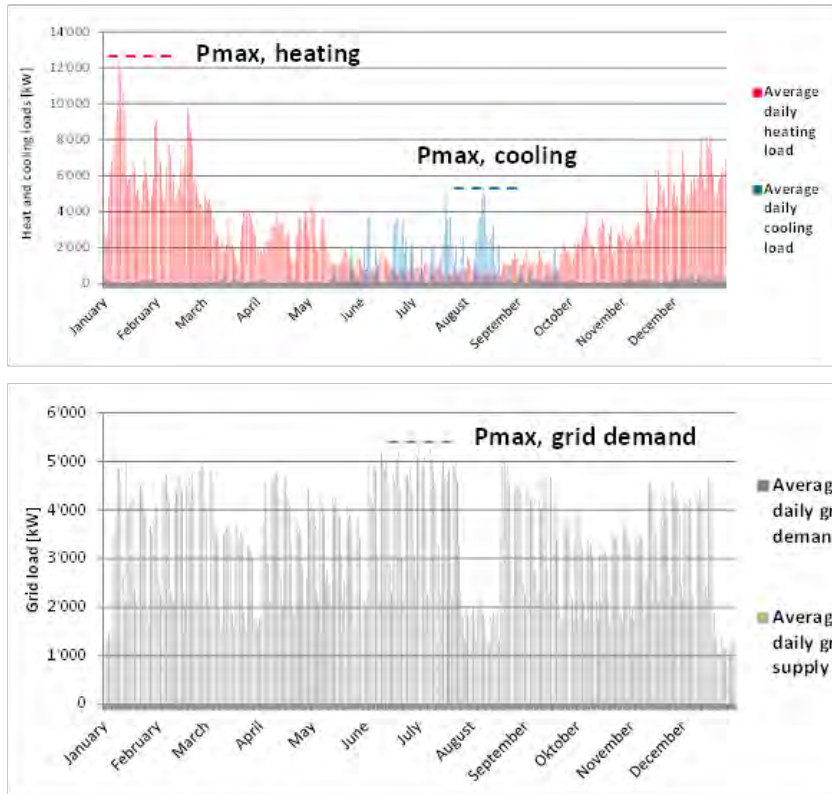

Figure 2: Criteria for the evaluation of the scenarios in the neighbourhood

2.3 Thermal and electrical loads of the neighbourhood “Cham Ost”

The thermal loads of the neighbourhood were determined by means of thermal simulations in IDA-ICE. 16 representative buildings were chosen, modelled and simulated to reproduce the entire neighbourhood. The electrical loads of the neighbourhood were assessed by using measured data on buildings of the same type in the same region. The profiles were then proportionally summed up accordingly to their surface share in the neighbourhood.



Pmax, heating

12.5 MW

Pmax, cooling

5.2 MW

**Heating / Cooling
demand**

25.8 / 3.5 GWh

Pmax, grid demand

5.3 MW

Pmax, grid supply

0 MW

**Grid demand /
supply**

27.7 / 0 GWh

Figure 3: Thermal loads of the neighbourhood “Cham Ost” (upper graph) and electrical loads (lower graph) of the neighbourhood “Cham Ost”

2.4 Scenarios

Different scenarios were analysed in order to assess their potential according to the defined criteria. The scenarios were not set equally in relation with their economic investment, but according to their technical feasibility in the neighbourhood.

- Networking: Potential of connecting buildings electrically and thermally.
- Utilisation mix: Substitution of 20% and 50% office buildings into residential buildings.
- Densification: Increase of 20% and 50% space heating area in the neighbourhood.
- Efficiency (Renovation): Renovation of 20% and 50% of the actual building stock.
- Decentralised production: Impact of 0% up to 100% roof coverage of photovoltaics and combined heat and power technology.
- Storage: Benefit of an ideal daily thermal or electrical storage.

3. RESULTS

The most important results are briefly presented for two scenarios, efficiency and decentralised production of photovoltaic panels.

3.1 Efficiency (Renovation)

The results show that in order to reach the goals of the SIA 2040 (target value for operation), 50% of the building stock shall be renovated to actual standard and 100% of the fossil fuel heating system shall be replaced by heat pumps with a yearly COP of at least 3.5 (Figure 5).

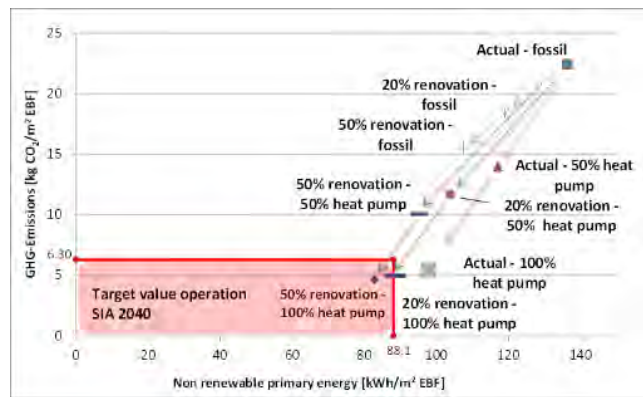

Figure 4: Renovation strategies on buildings for the neighbourhood and environmental impact according to SIA 2040 (target value in operation)

3.2 Photovoltaic production

The results show that even if 100% of the roof surface of the whole neighbourhood is covered by photovoltaic panels, the transmission lines not additionally stressed, i.e. the maximum grid supply load does not exceed the maximum grid demand load. Without demand side management, decentralised production of electricity can only reduce up to certain percentage roof coverage (40% of the roof area = about 50'000 m²) the grid demand peak.

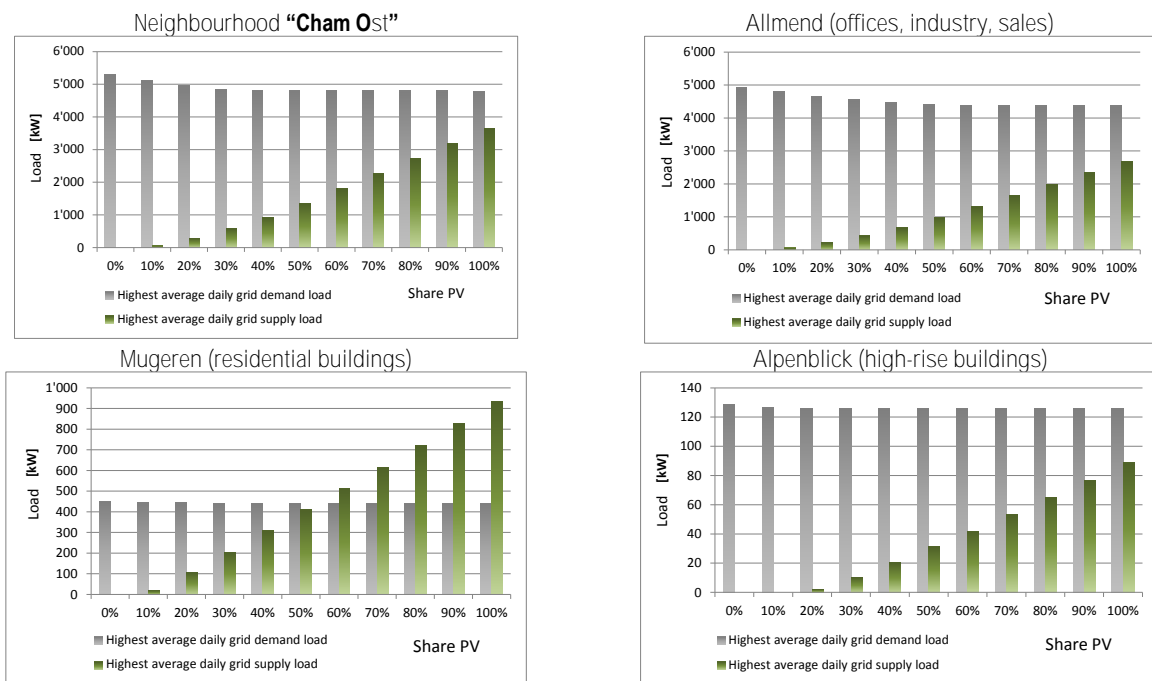

Figure 5: Maximum grid demand (grey) and grid supply peak from PV (green) of the whole neighbourhood and the three subareas when 0% up to 100% of the roof surface is covered by photovoltaics

3.3 Summary of the scenarios

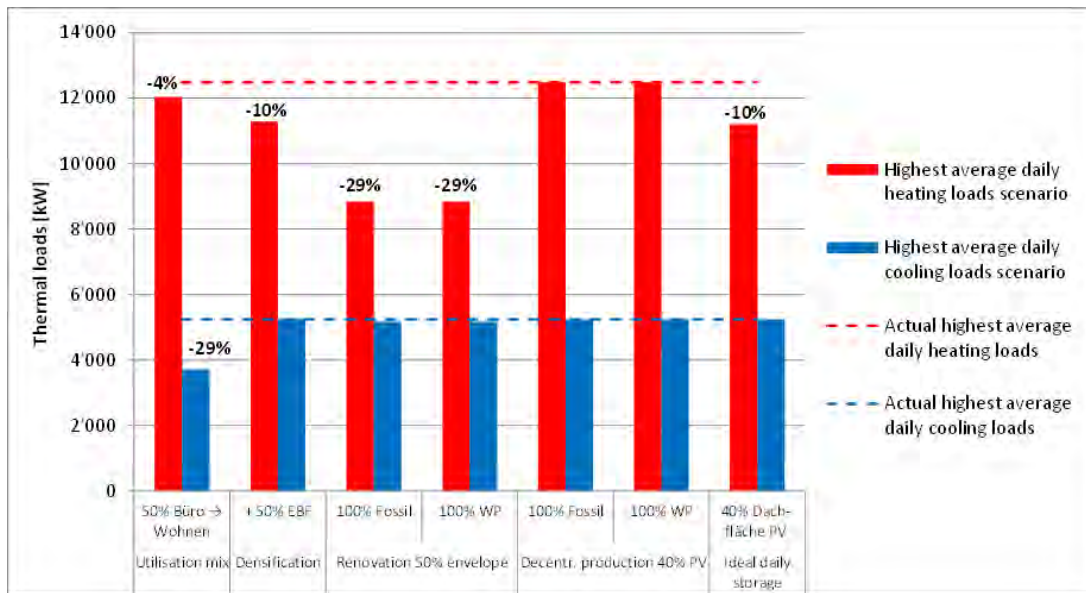

Figure 6: Highest daily average during the year of the thermal loads of the different scenarios (histograms) compared to the actual state (dashed line) by the same surface

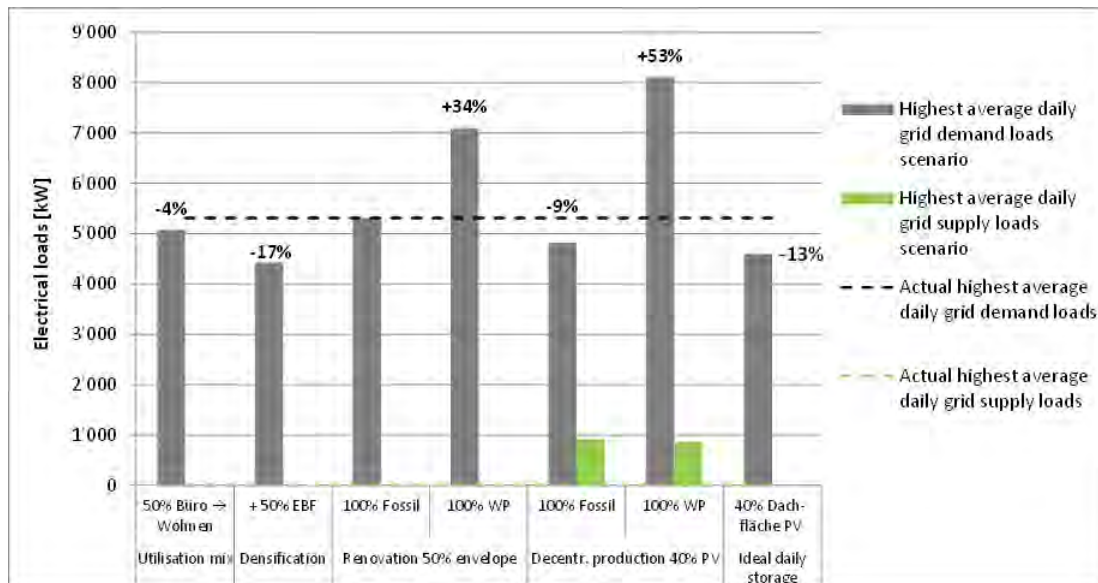

Figure 7: Highest daily average during the year of the electrical loads of the different scenarios (histograms) compared to the actual state (dashed line) by the same surface

The scenario that has most impact on the thermal loads, without increasing the cooling loads, is the renovation of 50% of the building stock in the area. The conversion of offices into residential buildings reduces both heat and cooling loads, since residential buildings carry a higher specific storage mass than offices. If all internal waste heat would be reused for heat purposes on site, final energy demand could be reduced by 3.5 GWh and maximum heat loads can be reduced by around 10%. Densification of the neighbourhood with residential and office buildings reduces the specific electric loads of the neighbourhood, since the present specific electricity demand due to industry is high. Decentralised production of photovoltaic reduces down to 9% the grid demand peak, while increasing the grid supply. The substitution of fossil fuels with heat pumps increases grid demand load by 34% resp. 53%, according to the renovation state. The ideal daily storages have limited potential to reduce yearly peaks, since on the days with highest energy consumption, low thermal and electrical excess energy is generated.

4. DISCUSSION

The overall results show that the technical measures on individual buildings clearly have most impact on peak load reduction, but due to their high costs, resulting in the present low retrofit rates, spatial planning measures still present a good option to help mitigate thermal and electrical loads without major effort. A densification in the neighbourhood (+ 50% surface) brings a yearly specific reduction of the thermal peaks of 10% and a yearly specific reduction of the electrical peaks of 17%. The peak loads engendered by the use of heat pumps shall be considered as a major issue for the future electricity network capacity and cannot be drastically reduced without any demand side management or long term batteries.

REFERENCES

- [1] Bucher, C.: Wie viel Solarstrom verträgt das Niederspannungsnetz? Resultate aus hochauflösenden Lastflusssimulationen. Technologie Smart Grid, S. 4., März 2014
- [2] Göbel V., K. F. (2012). Raum mit städtischem Charakter - Erläuterungsbericht 2012. Neuchâtel: Bundesamt für Statistik (BFS).

Adoption of Smart Initiatives in Developing Anderson Road Quarry Site Towards a Sustainable and Green Living Area

Matthew LAI Sze-yuen^a, Michael LEUNG Chung-lap^b, Barry SUM Pang-tuen^c, Kelvin CHENG Bing-cheung^d, Edwin FUNG Kook-koon^e

^a Civil Engineering and Development Department, Government of the HKSAR, Hong, matthewsylai@cedd.gov.hk

^b Civil Engineering and Development Department, Government of the HKSAR, Hong, michaelleung@cedd.gov.hk

^c AECOM, Hong Kong SAR, barry.sum@aecom.com

^d AECOM, Hong Kong SAR, kelvin.cheng@aecom.com

^e AECOM, Hong Kong SAR, edwin.fung@aecom.com

ABSTRACT

The Anderson Road Quarry is an important facility for supplying aggregate, asphalt and concrete for construction industry in HK since 1956. Following the accomplishment of its historical mission, the vacated 40 hectare site will take up another new mission – land supply for residential development with 25,000 planned population to address the housing shortage problem in the territory.

In view of the unique geographical location and as a piece of precious virgin land in the urban area, it gives us the opportunity to develop the site to an exemplary, sustainable and spongy living area. Smart initiatives are considered for adoption throughout the development process. Smart initiatives including pedestrian walkable network, cycling network with shared/ rental bikes, interactive bus-stop concept, smart phone Apps, etc. will be considered to encourage the residents to use convenient and healthy ways of active mobility for commuting within the area and help reducing vehicular transportation and emission.

Furthermore, integration of total water management with low impact development (LID) concepts has been derived to create a new leisure, healthy, socially integrated and harmonious community. To better utilize the water resource, we study the feasibility of using the first public grey water recycling system in ARQ site. LID as a kind of blue-green infrastructure, integrating water planning with landscape and urban design, comprises an artificial flood attenuation lake cum park, an underground storm water storage tank, rainwater harvesting system, bioretention system, porous pavement, etc, with some of them firstly introduced in HK. The retained rainwater also offers a water source for revitalization of the downstream Tsui Ping River in Kwun Tong area for environmental, ecological and landscaping enhancement.

Keywords: smart initiatives, low impact development, total water management

1. BACKGROUND

In the last 50 years, the economy of Hong Kong grows extraordinarily rapid. Accompanying with the rapid economic growth, a lot of large scale infrastructures works and building structures have been constructed and erected to support the development of Hong Kong. Since 1950s, Anderson Road Quarry (ARQ) has been an important facility and plays a significant role in construction industry for supplying aggregate, asphalt, stone and concrete in Hong Kong.

Following the accomplishment of the historical mission of ARQ, its 40 hectare vacated quarry site will take up another new mission – land supply for future residential and commercial development to accommodate 25,000 planned population with the aim of addressing the acute housing shortage problem in the territory.

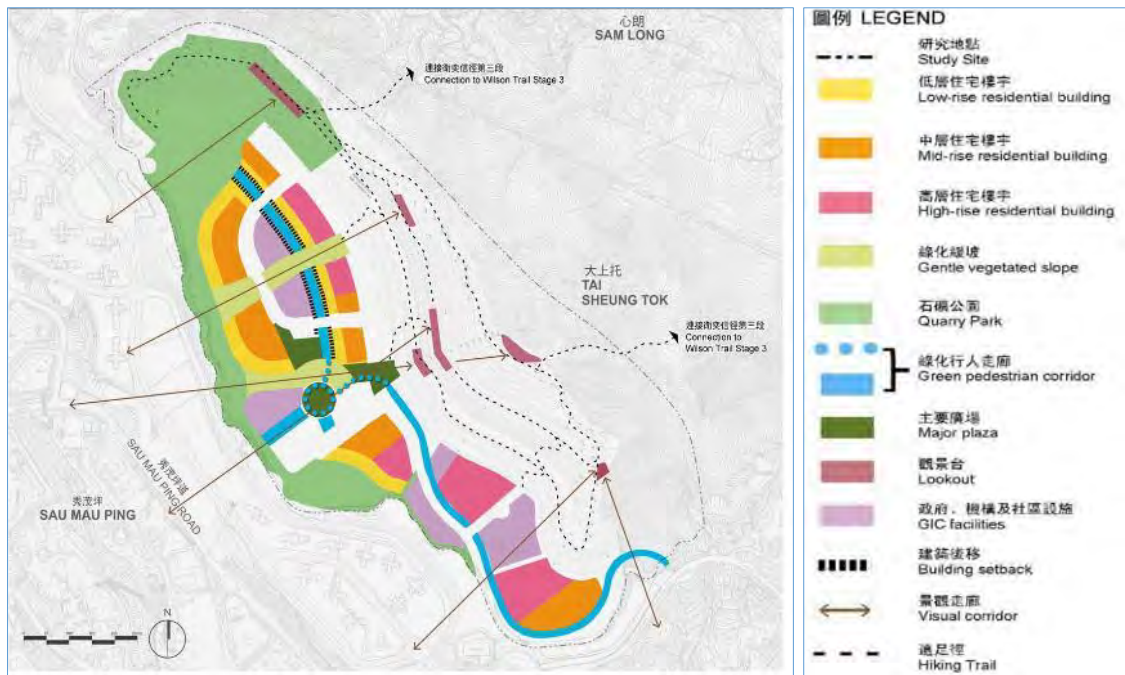

Figure 1: Conceptual development layout of ARQ Sites

2. SMART INITIATIVES ADOPTED FOR THE ARQ SITE DEVELOPMENT

The ARQ Site is a precious piece of virgin land of 40 hectare platform and another 40 hectare slope face in urban area of Hong Kong. It situates at the eastern side of Kowloon Peninsula in the vicinity of Tai Sheung Tok. In view of its dominant geographical location semi-detached with other current users and less conflicts with existing utility undertakers, it gives the opportunity to develop the site into an exemplary and sustainable community for people living there with more smart, green and resilient living environment.

In general, three main categories of smart initiatives will be implemented in the Development of ARQ Site, namely, integration of total water management (TWM) with low impact development (LID); smart energy; and smart mobility.

TWM is a modern concept for managing water resources in all aspects. It seeks to achieve an optimal balance between water demand and water supply in order to ensure sustainable use of water resources. To align with the TWM strategy, grey water recycling system, water intelligent network and automatic meter reading system will become pioneer initiatives for adoption under the Development of ARQ Site. LID initiative here refers to the best practice of stormwater management that integrates flood attenuation planning with landscape and urban design by blue-green infrastructure. The overall aim of adopting LID initiatives is to make urban hydrological systems function more like natural systems. The LID initiatives recommended for implementation in the Development of ARQ Site include artificial flood attenuation lake; underground stormwater storage tank; bioretention system; porous pavement and green roofs.

2.1 TWM – Grey water recycling

Grey water from the sources of bathroom wash basins, baths, shower, kitchen sinks, clothes washers, etc. of residential premises in the ARQ Site will be collected via dedicated grey water collection pipework system. These grey water collection pipes will be laid underneath and along public carriageways and convey the collected grey water to the proposed grey water treatment facilities underneath the regional open space of the ARQ Site. The treated effluent, known as reclaimed water, will be pumped to the flushing water service reservoir located at high level of the ARQ Site.

Use of reclaimed water as flushing water for public has not yet been implemented in Hong Kong so far and this will be the first grey water system if successfully implemented. There are still quite some challenges ahead to facilitate successful implementation of this grey water recycling system - amendment of existing legislation, incorporation of new land lease conditions, adoption of new building design, public education, etc.



Figure 2: Schematic diagram for grey water recycling

2.2 TWM – Water intelligent network and automatic meter reading

With the advancement of the telemetry and sensing technology, it is planned to set up a smart water network in Hong Kong, namely Water Intelligent Network (WIN). Under WIN, an intelligent network management computer system will be established for collecting and analyzing the tremendous amount of time-series flow and pressure data to be collected from the some 2000 District Metering Areas (DMAs) and Pressure Management Areas (PMAs) in Hong Kong. The analyzed results by the system will be displayed in a dashboard and the abnormalities spotted by the system will be reported in the form of alarm so that the attention of the system operators can be drawn easily for timely follow-up action. The water network within the ARQ Site will be the first batch of its kind in Hong Kong for upgrading to WIN.

In addition, the water network at ARQ Site will be equipped with Automatic Meter Reading (AMR) system, which will collect metering data automatically and transmit it to the master station in Water Supplies Department through 3G/ broadband networks. The AMR system will disseminate useful information to customers for raising their awareness on water conservation. Moreover, the data will be imported to the WIN system to enhance water loss management analysis.

2.3 LID – Artificial flood attenuation lake

In order to reduce the loading of existing stormwater drainage system at the downstream of the ARQ Site against potential flooding at low-lying areas, measures have been developed to attenuate the peak flow at upstream. The idea of an artificial flood attenuation lake not only serves the function of flood attenuation during rainfall period, but also serves for recreational and irrigation uses during dry weather period. The proposed artificial flood attenuation lake will become a key landscape feature of the proposed Quarry Park and is the first of its kind in Hong Kong.

The lake is designed to cater for 1 in 200 year return period rainfall intensity with climate change factor incorporated such that the flood attenuation capacity would be around 24,000 m³ and the lake surface area would be 10,000 m² at flooded condition. The lake can attenuate the peak flow from 7.4 to 1.7 m³/s and hence, plays a key role in improving the drainage capacity of the downstream drainage facilities from the worst of less than 1 in 10 year to the average of 1 in 50 year.

Part of the collected rainwater will be drained away immediately while some will be retained inside the lake with proper treatment for recreational and irrigation functions for the Quarry Park. At normal condition, the volume of stored water would be around 7,000 m³ and the depth of water would be around 0.7 m.

The non-submerged area or exposed surface of the artificial flood lake will become an open space in form of gentle sloping lawn area and landscape features for public enjoyment. To ensure the water quality suitable for the recreational uses such as water children play area facilities, an active water treatment facility is required to provide secondary treatment to the stored water, which will include chlorination and possible neutralization and aeration to fulfill the current rainwater harvesting standard.



Figure 3: Photomontage of artificial flood attenuation lake

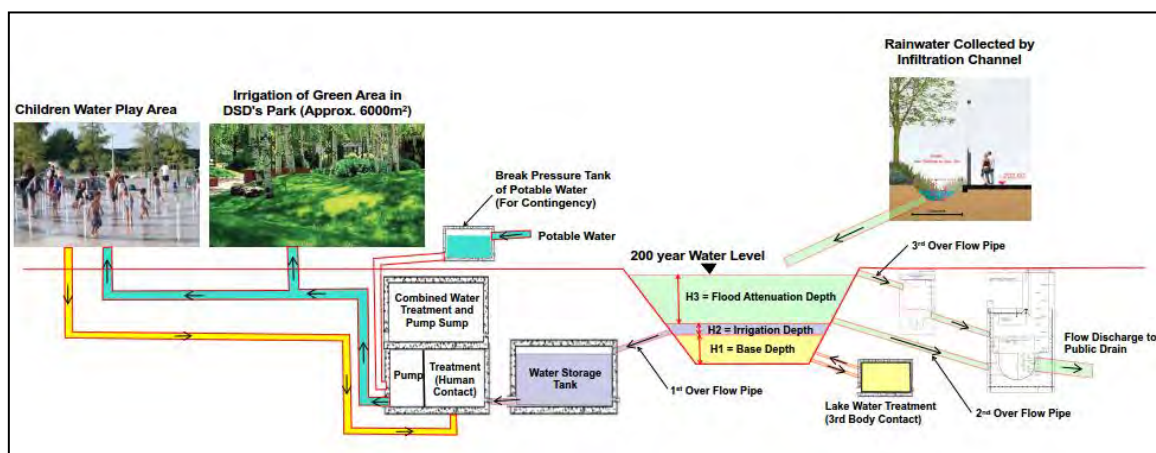

Figure 4: Flow Concept of artificial lake, irrigation and water treatment systems

2.4 LID – Underground stormwater storage tank

In addition to the artificial flood attenuation lake, another underground stormwater storage tank is proposed at the southern portion of the ARO Site serving the similar function as the artificial flood lake for flood control. This retention tank will be situated underneath the regional open space. It will have a flood attenuation capacity of 60,000 m³. The stormwater collected from the surface runoff of the ARO Site during rainfall period will be temporarily stored in the tank. After each rainstorm, the stored water will be discharged to the downstream drainage system and then to the Tsui Ping River in a controlled manner. This discharge of collected stormwater serves as a reliable source of water supplement for the revitalization of Tsui Ping River downstream for environmental, ecological and landscaping enhancement for Kwun Tong area, especially in dry weather condition.

2.5 LID – Bioretention system

The first flush of surface runoff in urban/ developed area usually contains high concentration of pollutants such as petrochemicals. Bioretention channels are used to convey stormwater in lieu of, or with, underground drainage systems, and to remove coarse and medium sediments as well as pollutants and nutrients from the stormwater.

Bioretention system is proposed in the Development of ARQ Site as a pilot scheme. Bioretention system will be adopted at two locations within the ARQ Site – one is located alongside the footpath of the main road. Surface runoff from footpath flows into the bioretention channel of which its catchment area is around 4,000 m². The filtered water will be discharged into the natural water course at downstream. Another location for bioretention system is within the Quarry Park area catering for about 120,000 m² catchment area of the ARQ Site. The proposed bioretention system will collect the surface runoff from adjacent rock slopes. After filtering by the bioretention channels, the filtered stormwater will be conveyed to and stored in the artificial flood attenuation lake.

2.6 LID – Porous pavement and green roof

Use of porous paving material is one of the green infrastructure provisions in the Development of ARQ Site. The porous pavers would increase stormwater infiltration, improve groundwater recharge and reduce ponding from surface runoff. Another benefit is to reduce the heat island effect for the site which in turn reduces the temperature of the site. The porous paver would be applied on most of the major pedestrian footpath within the site.

Furthermore, green roof system will be provided at the proposed fresh and flushing water service reservoirs and fresh and flushing water pumping stations to enhance the environment and reduce the heat island effect.

2.7 Smart energy

Provision of conventional salt water supply facilities for toilet flushing will require significant amount of pumping energy for ARQ Site owing to its high altitude – platform level at +200mPD approximately. The adoption of the grey water recycling system as described above to replace the salt water flushing facilities in another way reduce the energy consumption. From energy saving point of view, the new system will also be a smart initiative to reduce energy consumption for the ARQ Site.

The LIW infrastructure including the artificial flood attenuation lake; bioretention system; porous paving and green roofs discussed above also play a role in energy saving by reducing the heat island effect.

Furthermore, solar panels will be installed on the cover for the Public Transport Terminus (PTT) and the roof of the ventilation room of the underground stormwater storage tank. Operation for the pumping stations and treatment facilities for the flood attenuation lake, road lights and illumination for signs of public carriageways within the ARQ Site will be the main features to be powered by electricity generated from the renewable source. Considering ample space available from the eye-catching rock faces of the ARQ Site and the favorable orientation of absorbing sunlight, feasibility of installing solar panels at the rock faces is also under study. If this idea could be put into reality, it can not only bring much improvement to the original eyesore but also be an energy producer.

2.8 Smart mobility

The concept of smart mobility is to create and promote a walkable city and to adopt environmental friendly transportation mode for residents commuting within the development area. It also fosters public transit oriented transportation by using information and communication technology in order to improve the quality of transportation service. There are two main elements of smart mobility for implementation in the Development of ARQ Site, including Pedestrian and Cycling Mobility; and Interactive Urban Mobility.

2.8.1 Pedestrian and cycling mobility:

To position the Development of ARQ Site as a smart model community, a well-planned pedestrian and cycling network with associated ancillary facilities is essential for providing a convenient and healthy method of active mobility on a daily basis.

Provision of cycling network and ancillary facilities helps to encourage residents to use bikes for internal circulation within the community of the ARQ Site so as to reduce the reliance of vehicular transport. This cycle track to be placed alongside the main roadways of the Development of ARQ Site with single-two lanes ensures cyclists to be able to reach important nodes within the community blocks efficiently while maintaining a safe level of segregation between motorized vehicles and pedestrians, which is regarded as “dedicated cycle track”.

Apart from the implementation of the cycling mobility within the ARQ Site, off-site pedestrian connectivity facilities including escalator and lift systems as well as access to the proposed bus-bus interchange station at Tseung Kwun O tunnel toll plaza will be provided to reduce the demand for short vehicular trips for relieving the pressure on the existing road network in Sau Mau Ping area.

A bike share program is also being considered at the ARQ Site that boosts the community's health by shifting people from passive to active transportation at a relatively low cost. Daily commuters, cyclists, young riders, and inexperienced cyclists are all welcomed to use the shared bikes. An operator of the bike share program will be required to monitor the bike share stations and re-allocate the shared bikes at areas with low stock. Smartphone Apps is a possible tool to enable the monitoring.

Demarcation of management and maintenance responsibilities of the facilities; and administrative control and regulatory measures are always crucial issues to be resolved for implementation. Operation of the shared bike program and provision of private bike parking are also challenges for the successful implementation of this smart mobility initiative. It is believed that there are possible solutions to tackle the difficulties by making reference to those successful precedent cases locally and overseas.

2.8.2 Interactive urban mobility:

Hong Kong, as a city with a substantial number of public transit ridership and an intricate transportation system, has not yet formed a comprehensive interactive mobility system that brings together all travel modes, transport-related services, and mobility concepts in Hong Kong. Well-developed system of providing travel information helps building a smart community.

When future residents move around the community of the ARQ Site, real time travel information gathered from different travel modes can be accessed through the use of smart apps or interactive signage at the bus stops to enhance overall transportation efficiency. Synchronized city-wide information will also be available for residents travelling outside the ARQ Site.

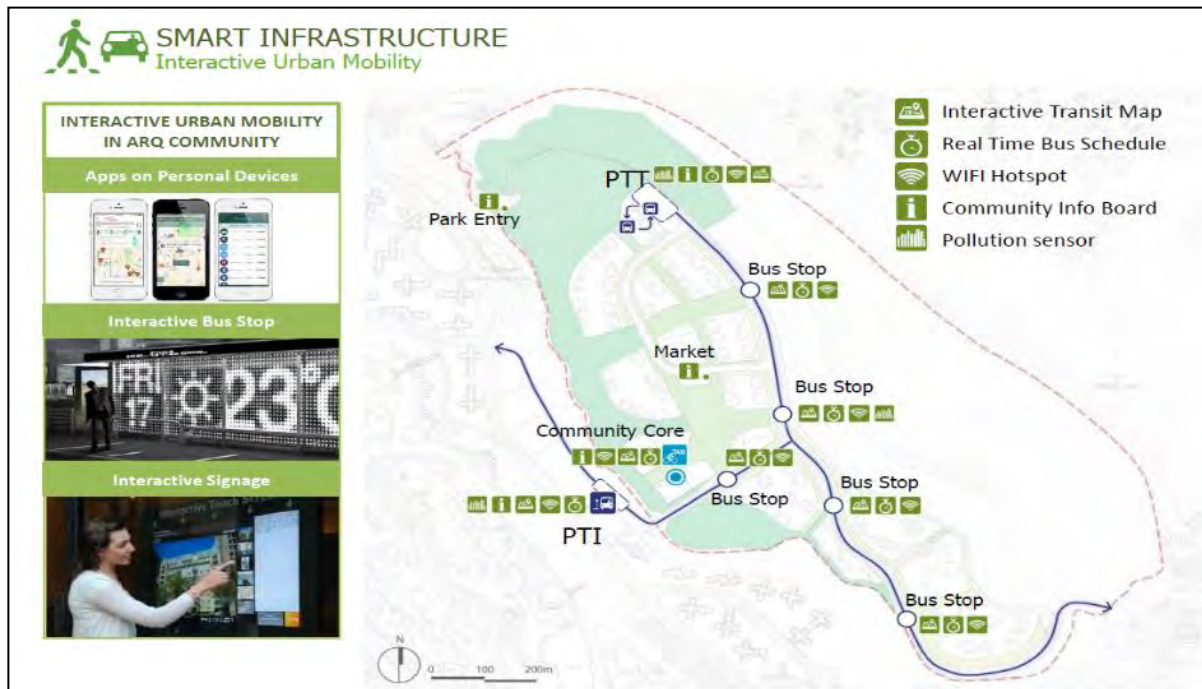

Figure 5: Interactive mobility features

3. CONCLUSION

The Development of ARQ Site will demonstrate Hong Kong as a place that builds exemplary communities for its **residents. A community that even more than “smart” is “wise” by engaging both the future and the past. A** community that seamlessly integrates new technologies in support of timeless world class urbanism to efficiently promote the safety, pride and well being of its residents.

Revolution and evolution always face a lot of resistance and challenges. For instance, to achieve success in the implementation of bike share program and grey water recycling system within the ARQ Site, it is paramount important to foster culture change in the community by collaborating with each other within the government to undertake the responsibilities for operation, management and maintenance and to review the need for legislation amendment, the existing design guideline, the current policy of development and the existing organizational structure.

With devoting collaborative efforts to building smart new community, it is expected that even more smart initiatives could be implemented in other new development areas like Yuen Long South, Kwu Tung North, Fanling North, Hung Shui Kiu and Tung Chung East and West under planning, and could build up Hong Kong to be a more green and smart city.

REFERENCES

- [1] Government of South Australia (2010), Water Sensitive Urban Design – Greater Adelaide Region.
- [2] Smart Cities: Big Data, Civic Hackers and the Quest for a new Utopia (2014), Anthony M. Townsend
- [3] Smart Mobility – A tool to Achieve Sustainable Cities (2015), Siemens AG
- [4] Smart Mobility Solutions (2016), SWARCO
- [5] The Government of HKSAR (2008), 2008 Policy Address, The Government of HKSAR.
- [6] Urban Ecology: Science of Cities (2014), Richard T.T. Forman
- [7] Water by Design (2012), Bioretention Technical Design Guidelines.

PT Roadmap Towards Operational Energy Neutral Sewage Treatment Works

Valeria ALVARADO^a, Charmane LAM Chor-man^b, Sussana W.K. LAI^c, KK CHEUNG^d, Mark HSU Shu-chien^e, Henry LEE Po-heng^f

^a Civil and Environmental Engineering, The Hong Kong Polytechnic University, Hong Kong SAR, valeria.alvarado.viar@gmail.com

^b Civil and Environmental Engineering, The Hong Kong Polytechnic University, Hong Kong SAR, charmanelam@gmail.com

^c Electrical and Mechanical Projects Division, Drainage Services Department, Government of the HKSAR, sussanalai@dsd.gov.hk

^d Electrical and Mechanical Projects Division, Drainage Services Department, Government of the HKSAR, kinkuencheung@dsd.gov.hk

^e Civil and Environmental Engineering, The Hong Kong Polytechnic University, Hong Kong SAR, mark.hsu@polyu.edu.hk

^f Civil and Environmental Engineering, The Hong Kong Polytechnic University, Hong Kong SAR, phlee@polyu.edu.hk

ABSTRACT

Increasing emission of greenhouse gases intensifies global warming. Pollution control, energy conservation and deployment of renewable energy being the core strategies to combat climate change are also the very fabric of sewage treatment. On the one hand, sewage treatment processes are energy intensive endeavours, and on the other, sewage is normally high in calorific value. For the past two decades, the sewage treatment industry has worked assiduously to develop energy efficient and recoverable processes to treat sewage and harvest the treasure trove of resources found in sewage. Studies conducted on major sewage treatment processes reveal that the conventional aeration system for oxidation of organic and inorganic contaminants contributes to 40-60% of the energy consumption of a sewage treatment plant. Smart aeration, frictionless-bearing air blowers, short cut denitrification, sidestream sewage treatment and mainstream anaerobic sewage treatment followed by ammonium oxidation (anammox) are promising energy saving technologies that can significantly reduce the aeration demand. Adoption of advanced sludge treatment processes such as biological hydrolysis process, thermal hydrolysis process, co-digestion of sewage sludge and other organic waste, etc. are measures to boost up the biogas yield in sewage treatment works with the anaerobic digestion process. Intertwining aforementioned energy saving and resources recovery approaches into the design and operation of sewage treatment works paves the road to energy neutrality. Looking above and beyond, biogas fuel cells and novel technologies, such as extraction of the energy content of ammonia from the nitrogenous pollutants with significant specific heat in digestate, are opportunities worth further exploration and may lead to the ultimate paradigm shift – from Energy Intensive Sewage Treatment Works to Net Energy Gain Energy Recovery Centre.

Keywords: sewage treatment, energy budget, energy neutral sewage treatment works

1. INTRODUCTION

Sewage treatment shifting paradigm recognises sewage energetic budget and the treatment capability to meet the stricter regulations for effluent and emissions related to the environment and human health. The energetic budget refers to the energy stored in the chemical bonds and the nutrient content from organics and inorganics compounds, such as nitrogen (N), and phosphorous (P) contained in sewage. In fact, previous estimation for internal energy content in domestic sewage, considering 6.8 billion people in the world producing 60-120 gCOD/person/day and 14.7 kJ/gCOD as energy content value, showed there is $2.2-4.4 \times 10^{18}$ J of energy per year available (Heidrich *et al.*, 2011). Those calculations were based on raw sewage, but during the sewage treatment process, the initial energy content is distributed into the water and solids streams. Several studies have used bomb calorimeter to measure the calorific value for the sewage treatment process (Tomkins *et al.*, 1985; Shizas and Bagley, 2004; Heidrich *et al.*, 2011). Raw sewage intrinsic energy ranged around 1.9 -10.1 kJ/L, 18 - 94 kJ/L for primary sludge, 1,265 – 1,695 kJ/L for thickened combined sludge, 254 - 306 kJ/L for anaerobic sludge, and 1.9 - 2.5 kJ/L for primary clarifier effluent. In general, the energy content values combined with the flow of a sewage treatment works (STW) represent the energy flow at that respective treatment process.

The energy budget for energy production within a STW has been proved to meet, or even exceed, the energy demanded by the treatment process (Remy *et al.*, 2014). By using the appropriate technologies, a STW can achieve energy neutral, or even positive, operation. Researchers have reported their findings of energy neutral technologies, including energy saving and energy production strategies, adopted in full-scale STW; [e.g. Austria (Nowak *et al.*, 2011), Czech Republic (Jenicek *et al.*, 2013) and USA (Proctor, 2010)]. Strass wastewater treatment plant (WWTP) in Austria has even become energy positive. The energy saving strategies mainly present in the

energy neutral STW aforementioned are anaerobic ammonium oxidation (Anammox), smart aeration, chemical enhanced primary treatment (CEPT) completed with anaerobic digestion. The energy production strategies mainly are anaerobic digestion with co-digestion, combined heat and power (CHP), generators and solar panels. The objective of this study was to review literature and to identify state-of-the-art energy efficient technologies that could be implemented to achieve energy neutral operation in a typical sewage treatment works (STWs). The energy flows from Sha Tin and Shek Wu Hui STWs in HK were performed in a R&D project supported by Drainage Services Department (DSD). Results are interpreted to overlook their application niches, and thus, recommendations were made in achieving energy neutral operation in the short- and long- term.

2. ENERGY NEUTRAL STRATEGIES

The current research and development of STWs provides a wide range of options to recover the intrinsic energy in the sewage. Some of those options are the energy production strategies presented in this study. Yet, not only energy production, but energy conservation within the plant is essential to achieve energy neutral operation. Aeration is the focus of the energy conservation due to its significant share in the plant power usage which commonly is around half of the plant power usage (WEF, 2009). Then, this study presents energy saving strategies, which are focused on efficient aeration system and anaerobic/ anoxic biological treatments. In addition, the energy production strategies refer to the making use of the biogas produced by anaerobic digestion in the water and solid stream.

2.1 Energy saving strategies

The energy saving strategies identified in this study include some recent technologies such as shortcut denitrification, smart aeration, and anaerobic treatment followed by Anammox.

2.1.1 Shortcut denitrification

Shortcut denitrification is a strategy evolution from the conventional nitrification-denitrification process. The typical nitrification-denitrification process consists in two steps. In the nitrification step, reduced nitrogen compounds (ammonium, ammonia and nitrite) are first oxidised by ammonia-oxidizing bacteria (AOB), which convert ammonia to nitrite (NO_2^-). Then, nitrite-oxidising bacteria (NOB) further oxidise the intermediate product to nitrate (NO_3^-). In the denitrification step nitrate is then transformed back to nitrite, and further to nitrous oxide, nitric oxide, and finally to nitrogen gas (Jianlong and Ning, 2004; Ruiz *et al.*, 2006).

Nitrite is the key intermediate for both nitrification and denitrification. Thus, a partial nitrification (ammonium oxidation into nitrite, but not further to nitrate) can be followed by denitrification (Ruiz *et al.*, 2006; Jianlong and Ning, 2004). Partial nitrification requires the inhibition of NOB activity, while enhancing AOB activity through appropriate regulation of free ammonia (FA) by manipulating pH, temperature, DO, and sludge retention time (SRT) (Jianlong and Ning, 2004; He *et al.*, 2013). The optimal operating parameters for partial nitrification have been well-studied and its ammonia-nitrogen removal efficiency and nitrite accumulation rate were well-reported (Jianlong and Ning, 2004; Ciudad *et al.*, 2005; Ruiz *et al.*, 2006; He *et al.*, 2013). Literature showed that low DO concentration ranges from 0.7 mg/L to 1.5 mg/L could achieve ammonia-nitrogen removal efficiency over 90% and nitrite accumulation of 67.6 to over 95%.

Low DO supply results in energy savings associated with aeration during nitrification, reduction of organic matter requirements in denitrification, reduce in reactor footprint, decrease in surplus sludge production from reducing growth of NOB, and low cost implementation due to the change of only operational conditions (Ciudad *et al.*, 2005; Ruiz *et al.*, 2006). In addition, Jianlong and Ning (2004) reported that nitrogen-rich high-strength wastewaters with a C/N ratio of over 3 are ideal for application of the shortcut biological nitrogen removal process. Therefore, the dual system for flushing toilets of Hong Kong could be treated through this process.

2.1.2 Smart aeration

In addition to low DO concentration levels for energy saving in the aeration system, efficient mechanical devices for smart aeration highly contribute to energy conservation. The main mechanical elements in the aeration system are the blowers, valves and diffusers.

Åmand *et al.* (2013) reviewed the most efficient technologies for each mechanical element. Centrifugal blowers were presented to have the highest efficiency of about 65-85%. Blowers (not considering influent pumping) are the largest single user of energy at a traditional activated sludge system. The valves and their actuators energy saving strategies are most-open-valve (MOV) principle and direct flow control. Valves and their actuators are closely related to complementary elements such as sensors, and control structures with algorithms. The last element, the diffusers, can be categorised by their porosity or bubble size. Fine bubble aeration has higher oxygen transfer efficiency than coarse bubble aeration. Hence, the fine bubble diffuser could represent energy savings if adapted appropriately.

In overall, Åmand *et al.* (2013) presents the main mechanical elements should include centrifugal blowers, most-open valve (MOV) strategy, and fine bubble diffusers. Yet, the mechanical and complementary elements of the aeration system should be tested and further evaluated to determine their energy efficiency. Upgrade of the aeration elements has been adopted in Strass and Wolfgangsee-Ischl WWTPs in Austria, and Gresham WWTP in the US (Proctor, 2010; Nowak *et al.*, 2011).

2.1.3 Anaerobic treatment followed by Anammox with sewage

The technology termed staged fluidised-bed membrane bioreactor (SF-MBR) is a hybrid system covering both strategies of energy saving and energy production. This technology consists of an anaerobic fluidised-bed bioreactor (AFBR) and a fluidised-bed membrane bioreactor (F-MBR). The SF-MBR omits the use of aeration due to its anaerobic nature, while producing biogas during the process. Strass WWTP in Austria has already adopted the similar concept, leading an energy gain (Nowak *et al.*, 2011).

The AFBR treats the organics through anaerobic conversion to methane and/ or hydrogen sulfide depending on sewage characteristics of high or low saline content. The next stage, the F-MBR, combines biofilm and membrane design configuration for autotrophic nitrogen removal via coupling nitrification and Anammox (Kwak *et al.*, 2012). The coupling occurs by integrating completely external DO supply for stable nitrification, membrane filtration and biofilm fluidised-bed media design configuration in a single stage (Wang *et al.*, 2010; Ni *et al.*, 2010; Lee *et al.*, 2013; Kwak *et al.*, 2012). The oxygen supplied externally through aeration of a recycle stream is then mixed with the influent ammonia-containing wastewater to achieve a given DO to ammonium nitrogen ratio. By this complete DO supply an observation of nitrate formation equalled no more than 2% of the ammonium removed by Anammox, which has usually been reported as around 10% by research (Lee *et al.*, 2013). On the other hand, the produced nitrite by nitrification in this F-MBR would be consumed immediately by Anammox microorganisms which ensure less nitrous oxide formation, thus a reduction in greenhouse gas (GHG) emissions (Kwak *et al.*, 2012). In addition, the F-MBR has good mass transfer and high biomass retention with the traits of effective fouling control (Ni *et al.*, 2010; Kim *et al.*, 2011).

The SF-MBR system has several advantages. First, the system has less direct GHG emissions due to the fast consumption of nitrite by Anammox diminishing nitrous oxide formation. Also, less sludge production from microorganisms associated with anaerobic organic treatment and autotrophic nitrogen removals which have the feature of low yield (McCarty *et al.*, 2011; Kwak *et al.*, 2012). The good effluent quality comes from the use of membrane filtration process. Also, polishing residual organics either by Anammox or integration with denitrification has been found through the limited DO supply (Wang *et al.*, 2010; Lan *et al.*, 2011). The secondary anaerobic biofilm treatment of organics with low or high saline sewage either by AFBR or upflow anaerobic sludge blanket (UASB) has recently been proved to be able to meet the effluent standard of 30 mg/L for BOD (Wang *et al.*, 2009). Regarding resource recovery, the SF-MBR effluent could be sent to a commercialised phosphorous recovery process producing a plant nutrient fertiliser (Rittmann *et al.*, 2011). Additionally, the dissolved hydrogen sulphide and methane contents from the anaerobically-treated effluent could be recovered as elemental sulphur and electricity, respectively (Bandara *et al.*, 2012; Cookney *et al.*, 2012).

2.2 Energy production strategies

The energy production strategies identified in this study include some recent technologies such as co-digestion, solid oxide fuel cells (SOFC), and energy recovery from ammonium in digestate.

2.2.1 Co-digestion

Anaerobic digestion (AD) is a biochemical process for the treatment of organic substrates in the absence of molecular oxygen. The anaerobic pathway to CH₄ formation involves the degradation and stabilisation of complex organic matter by a consortium of microorganisms leading to a methane-rich biogas. Anaerobic treatment for a sole substrate has demonstrated to encounter difficulties to breakdown rigid cell walls and extracellular polymeric substances which lead to poor hydrolysis (Zhen *et al.*, 2014). To tackle these limitations, co-digestion is a strategy that has been developed in recent years. Co-digestion is the simultaneous digestion of a homogeneous mixture of two or more substrates. Co-digestion has unique benefits over the traditional AD including: balances C/N ratio and nutrient, increases pH buffering capacity, decreases ammonia toxicity and accumulation of VFAs, results in better quality of a digested product, and increases loading of readily biodegradable organic matter, which translates in enhanced biogas production (Zhang *et al.*, 2014; Zhen *et al.*, 2014). This technology is of interest to this study, due to its potential adaptability to existing digesters at WWTPs (Zhang *et al.*, 2014). In fact, energy neutral plants have adopted co-digestion with fat, oil and/ or grease (Proctor, 2010) food waste (Adelman and Gill-Austern, 2011) and dairy waste (Shen *et al.*, 2015).

2.2.2 Solid oxide fuel cells

Unlimited by the Carnot cycle, solid oxide fuel cell (SOFC) is a promising technology used to electrochemically convert the chemical energy of fuels to electric power with high energy efficiency and negligible impact on environment. A typical SOFC is composed of a porous cathode, a dense electrolyte and a porous anode. The cathode serves as an electrocatalyst for reduction of molecular oxygen to oxygen ions, a process commonly known as oxygen reduction. And then the electrolyte (assuming oxygen-ionic conducting oxide) allows oxygen ions to transport through continuously and solely under a gradient of chemical potentials of oxygen. Finally, the anode accepts oxygen ions delivered by the electrolyte and converts them into H₂O, CO₂ and electrons by reacting with hydrogen or hydrocarbon fuels, while the electrons transport through an external circuit from the anode to the cathode to realise the production of electricity.

The most attractive feature of SOFCs is their flexibility in selecting types of fuels due to the high operating temperatures, which can effectively activate the processes of reforming and electrochemical oxidation of hydrocarbon fuels (Xuan *et al.*, 2009). The excessive heat produced from the electrochemical oxidation of fuels can be utilised by the highly endothermic steam reforming reaction simultaneously occurring, which makes internal on-cell fuel reformation possible. Such integration has advantages in terms of energy conversion efficiency and system simplification.

The composition of biogas can vary depending on its origin; however, it always includes as major constituents CH₄ and CO₂. With such a composition, CH₄-CO₂ gas mixtures can be also regarded as a relevant biogas fuel for SOFCs. The biogas produced from sludge digestion contains a significant amount of CH₄, which can be an energy source (Van Herle *et al.*, 2004). When CO₂ and CH₄ mixture is used in SOFC, CH₄ can be reformed by CO₂ at high temperature to produce CO and H₂. The CO and H₂ can be used as fuel in SOFC for power generation. The efficiency of SOFC (typically 50-60%) is significantly higher than conventional heat engines with typical efficiency of about 35% (Adams *et al.*, 2013). Thus, SOFC produces less pollutant for unit power generation than that of heat engines. Moreover, SOFCs can generate considerable power even at 20% CH₄ to CO₂ while the combustion engines cannot be applicable under this situation. Finally, SOFC contains no moving components thus it is quiet during operation.

2.2.3 Energy recovery from ammonium in digestate

Coupled Aerobic-anoxic Nitrous Decomposition Operation (CANDO) is a process that recovers energy from nitrogen in three steps: (1) partial nitrification of NH₄⁺ to NO₂⁻; (2) partial anoxic reduction of NO₂⁻ to N₂O, and (3) N₂O conversion to N₂ with energy recovery by either catalytic decomposition to N₂ and O² or use of N₂O to oxidise biogas CH₄. Scherson *et al.*, (2012) demonstrated through stoichiometry calculations that the oxidation of CH₄ with N₂O, rather than with O₂, lifts approximate 30% more energy. In principle, this N₂O is a more powerful oxidant than O₂ due to the release of an additional 82 kJ/mol from N₂O to N₂. The intermediate step- reduction of NO₂⁻ to N₂O may be accomplished abiotically with Fe (II) or biotically with polyhydroxybutyrate (PHB) storage granules as the

source of electrons. Myung *et al.* (2015) studied the biotic strategy and found that the type II methanotrophic enrichments can mediate step two by coupling oxidation of poly (3-hydroxybutyrate) (P3HB) to NO₂⁻ reduction. The potential advantages of this process include the decrease of oxygen requirements by 20%, decrease of biomass production by 40%, mitigates the release of N₂O, increase of organic matter available for recovery as biogas methane, and enable energy recovery from nitrogen by 60% (Scherson *et al.*, 2012).

3. DISCUSSION

The energy flow done by Garrido *et al.* (2013) shows that 70% of the initial calorific energy (MJ/day) is present for biological treatment. In contrast, other studies affirm that 40-66% of the initial energy content is concentrated in the sludge (Shizas and Bagley, 2004; Gyobu *et al.*, 2015). In this context, we recommend shortcut denitrification for the biological treatment, with an upgrade of the aeration mechanical systems in the short-term. For the sludge stream at the anaerobic digesters, co-digestion is recommended. These strategies can be implemented by other similar plants aiming to achieve operational energy neutral. In a long-term planning considering infrastructure construction, change in the treatment, and higher investment; then, anaerobic treatment followed by Anammox for the water stream, and SOFC and ammonium in digestate for the sludge stream, can be implemented. Yet, further study is needed to determine if the organic matter should follow the water stream into the biological treatment or if the organic matter removal in the primary clarifier should be enhanced to obtain higher chemical oxygen demand for the solid stream in the anaerobic digester for biogas production as suggested by Flores-Alsina *et al.*, (2014).

REFERENCES

- [1] Adams, T. A., Nease, J., Tucker, D., and Barton P. I., 2013. Energy conversion with solid oxide fuel cell systems: A review of Concepts and outlooks for the short- and long-term, *Ind. Eng. Chem. Res.*, 52(9), 3089-3111.
- [2] Adelman, L., and Gill-Austern, D., 2011. From Waste to Energy: A conceptual analysis of Anaerobic Digestion at the Saratoga County Sewer District No. 1 Plant. Environmental Studies Capstone Project Skidmore College.
- [3] Åmand, L., Olsson, G., and Carlsson, B., 2013. Aeration control- a review, *Water Science and Technology*, 67(11), 2374-2398.
- [4] Bandara, W.M., Kindaichi, T., Satoh, H., Sasakawa, M., Nakahara, Y., Takahashi, M., and Okabe, S., 2012. Anaerobic treatment of municipal wastewater at ambient temperature: Analysis of archaeal community structure and recovery of dissolved methane. *Water Res.* 46(17), 5756-5764.
- [5] Ciudad, G., Rubilar, O., Muñoz, P., Ruiz, G., Chamy, R., Vergara, C., and Jeison, D., 2005. Partial nitrification of high ammonia concentration wastewater as a part of a shortcut biological nitrogen removal process, *Process Biochemistry*, 40(5), 1715-1719.
- [6] Cookney, J., Cartmell, E., Jefferson, B., and McAdam, E.J., 2012. Recovery of methane from anaerobic process effluent using poly-di-methyl-siloxane membrane contactors. *Water Sci. Technol.*, 65(4), 604-610.
- [7] Flores-Alsina, X., Arnell, M., Amerlinck, Y., Corominas, L., Gernaey, K. V., Guo, L., Lindblom, E., Nopens, I., Porro, J., Shaw, A., Snip, L., Vanrolleghem, P. A., Jeppsson, U., 2014. Balancing effluent quality, economic cost and greenhouse gas emissions during the evaluation of (plant-wide) control/operational strategies in WWTPs. *Science of the Total Environment*, 466-467, 616-624.
- [8] Garrido, J.M., Fdz-Polanco, M., and Fdz-Polanco, F., 2013. Working with energy and mass balances: a conceptual framework to understand the limits of municipal wastewater treatment. *Water Science & Technology*, 67(10), 2294-2301.
- [9] Gyobu, T., Inoue, M., Soda, S., and Ike, M., 2015. Energy content of organics in municipal wastewater treatment streams at Tsumori wastewater treatment plant, *Journal of Water and Environment Technology*, 13(1), 89-97.
- [10] He, Q., Peng, X., and Li, Z., 2014. The treatment of animal manure wastewater by coupled simultaneous methanogenesis and denitrification (SMD) and shortcut nitrification–denitrification (SND), *Chemical Technology Biotechnology*, 80, 1697-1704.
- [11] Heidrich, E.S, Curtis T.P., and Dolfig J., 2011. Determination of the Internal Chemical Energy Wastewater. *Environmental Science & Technology*, 45(2), 827-832.

- [12] Jenicek, P., Kutil, J., Benes, O., Todt, V., Zabranska, J., and Dohanyos, M., 2013. Energy self-sufficient sewage wastewater treatment plants: is optimized anaerobic sludge digestion the key? IWA Publishing, 68(8), 1739-1744.
- [13] Jianlong, W., and Ning, Y., 2004. Partial nitrification under limited dissolved oxygen conditions, *Process Biochemistry*, 39(10), 1223-1229.
- [14] Kim, J., Kim, K., Ye, H., Lee, E., Shin, C., McCarty, P. L., and Bae, J., 2011. Anaerobic fluidized bed membrane bioreactor for wastewater treatment. *Environ. Sci. Technol.*, 45(2), 576-581.
- [15] Kwak, W., McCarty, P.L., Bae, J., Huang, Y.T., and Lee, P.H., 2012. Efficient single-stage autotrophic nitrogen removal with dilute wastewater through oxygen supply control. *Bioresour. Technol.*, 123, 400-405.
- [16] Lan, C.J., Kumar, M., Wang, C.C., and Lin, J.G., 2011. Development of simultaneous partial nitrification, anammox and denitrification (SNAD) process in a sequential batch reactor. *Bioresour. Technol.*, 102(9), 5514-5519.
- [17] Lee, P.H., Kwak, W., Bae, J., and McCarty, P.L., 2013. The effect of SRT on nitrate formation during autotrophic nitrogen removal of anaerobically treated wastewater. IWA 2012 Busan.
- [18] McCarty, P. L., Bae, J., and Kim, J., 2011. Domestic wastewater treatment as a net energy producer can this be achieved? *Environ. Sci. Technol.*, 45(17), 7100-7106.
- [19] Myung, J., Wang, Z., Yuan, T., Zhang, P., Van Nostrand, J. D., Zhou, J., and Criddle, C. S., 2015. Production of nitrous oxide from nitrite in stable type II methanotrophic enrichments, 49(18), 10969, 10975.
- [20] Ni, S.O., Lee, P.H., and Sung, S., 2010. The kinetics of nitrogen removal and biogas production in an anammox non-woven membrane reactor. *Bioresour. Technol.*, 101(15), 5767-5773.
- [21] Nowak, O., Keil, S., and Fimml, C., 2011. Examples of energy self-sufficient municipal nutrient removal plants. *Water Science & Technology*, 64(1), 1-6.
- [22] Proctor, P., 2010. Achieving Energy Independence at the Gresham Wastewater Treatment Plant. Retrieved September 22, 2015 from <http://www.waterworld.com/articles/print/volume-27/issue-3/editorial-features/water-utility-management-special-section/achieving-energy-independence-at-the-gresham-wastewater-treatment-plant.html>
- [23] Remy, C., Boulestreau, M., and Lesjean B., 2014. Proof of concept for a new energy-positive waste water treatment scheme, IWA Publishing, *Water Science & Technology*, 70(10), 1709-1716.
- [24] Rittmann, B.E., Mayer, B., Westerhoff, P., and Edwards, M., 2011. Capturing the lost phosphorus, *Chemosphere*, 84(6), 846-853.
- [25] Ruiz, G., Jeison, D., Rubilar, O., Ciudad, G., and Chamy, R., 2006. Nitrification–denitrification via nitrite accumulation for nitrogen removal from wastewaters, *Bioresource Technology*, 9(2), 330-335.
- [26] Scherson, Y. D., Wells, G. F., Woo, S. G., Lee, J., Park, J., Cantwell, B. J., and Criddle, C. S., 2012. Nitrogen removal with energy recovery through N₂O decomposition, *Energy Environmental Science*, 6, 241-248.
- [27] Shen, Y., Linville, J.L., Urgun-Demirtas, M., Mintz, M.M., and Snyder, S.W., 2015. An overview of biogas production and utilization at full-scale wastewater treatment plants (WWTPs) in the United States: challenges and opportunities towards energy-neutral WWTPs. *Renewable Sustainable Energy Reviews*, 50, 346–362.
- [28] Shizas, I., and Bagley, D.M., 2004. Experimental determination of energy content of unknown organics in municipal wastewater streams. *Journal of Energy Engineering*, 130(2), 45-53.
- [29] Tomkins, R.P.T., Landau, R., and Plichta, E.J., 1985. Internal energies of combustion of samples of sewage sludge. *Energy Sources*, 8(1), 67-76.
- [30] Van Herle, Q., Marechal, F., Leuenberger, S., Membrez, Y., Bucheli, O., and Favrat, D., 2004. Process flow model of solid oxide fuel cell system supplied with sewage biogas. *J Power Sources*, 131, 137-141.
- [31] Wang, J., Lu, H., Chen, G.H., Lau, G.N., Tsang, W.L., and van Loosdrecht, M.C., 2009. A novel sulfate reduction, autotrophic denitrification, nitrification integrated (SANI) process for saline wastewater treatment. *Water Res.*, 43(9), 2363-2372.
- [32] Wang, C.C., Lee, P.H., Kumar, M., Huang, Y.T., Sung, S., and Lin, J.G., 2010. Simultaneous partial nitrification, anaerobic ammonium oxidation and denitrification (SNAD) in a full-scale landfill-leachate treatment plant. *J. of Hazard. Mat.*, 175, 622-628.
- [33] WEF., 2009. *Energy Conservation in Wastewater Treatment Facilities – Manual of Practice – No. 32*, Water Environment Federation, Alexandria, USA.
- [34] Xuan, J., Leung, M. K. H., Leung, D. Y. C., and Meng, N., 2009. A review of biomass- derived fuel processors for fuel cell systems. *Renewable and Sustainable Energy Reviews*, 13(6-7), 1301-1313.

- [35] Zhang W., Wei Q., Wu S., Qi D., Li W., and Zuo Z., 2014. Batch anaerobic co-digestion of pig manure with dewatered sewage sludge under mesophilic conditions. *Appl Energy*, 128, 175-83.
- [36] Zhen G., Lu X., Li Y.Y., and Zhao Y., 2014. Combined electrical-alkali pretreatment to increase the anaerobic hydrolysis rate of waste activated sludge during anaerobic digestion. *Appl Energy*, 128, 93–102.

Poster Session

Climate Responsiveness and Facade Design of AQUA-Certified School Buildings

Doris C.C.K. KOWALTOWSKI^a, Leticia de Oliveira NEVES^b, Vanessa Gomes DA SILVA^c, Giseli Mary COLLETO^d

^a University of Campinas, UNICAMP, Brazil, dkowaltowski@gmail.com

^b University of Campinas, UNICAMP, Brazil, leticia@fec.unicamp.br

^c University of Campinas, UNICAMP, Brazil, vangomes@fec.unicamp.br

^d University of Campinas, UNICAMP, Brazil, giseli.mary.colleto@gmail.com

ABSTRACT

Education is an important element to bring about social, economic and technological changes in any country. The physical infrastructure of schools is however seldom part of education improvement strategies in countries like Brazil. Public school buildings in the state of São Paulo are managed by its Foundation for Education Development (FDE). In 2010 FDE required that all new buildings were certified under AQUA, the French HQE environmental rating scheme adapted to Brazilian contexts. Building certification was devised as an opportunity to decrease environmental impacts, while improving indoor environment quality, among other performance aspects. Our research goals were to investigate if the certification requirements have a tangible positive impact on building quality, induce climate responsive architecture and provide adequate and comfortable environments for education. Nineteen FDE projects currently seeking AQUA certification were studied. First, we analysed the sample regarding climate responsiveness and critical performance aspects for learning environments. Then, we ran thermal and daylight simulations for a representative classroom to assess contribution from the designed shading devices. Our analysis revealed that orientation of school buildings to suit local climates is neglected. Double loaded corridor floor plans are typically adopted even though they prevent cross-ventilation in classrooms. Solar absorptance of external walls is not compliant in half of the cases. Finally, typical shading device design improves thermal conditions of optimally oriented classrooms, but impairs daylight harvesting in over half of the occupied time. The hypothesis was that AQUA certification of public school buildings would have significant effect on design elements which contribute to environmental comfort conditions. This was not confirmed. The certification had limited capacity to induce climate responsive architecture. For this reason, besides certifications the design process needs enhancement. Design decisions impact must learn from assessment loops, simulations and inputs from users and specialists alike. Finally, building assessment data should inform new school building projects, to guarantee that we are actually advancing in the right direction.

Keywords: building energy simulation, climatic responsive architecture, educational building facades

1. INTRODUCTION

Education is an important element to bring about social, economic and technological changes. Improving school buildings design to attain minimum sustainability indicators should contribute to enhance not only the quality of physical learning environments, but of education as a whole.

The State of Sao Paulo Foundation for Education Development (FDE) manages the public school building construction process. FDE is responsible not only for the design and construction of new schools, but also for the management and maintenance of around 5000 primary and secondary education facilities in the state. An example of FDE schools is shown in Figure 1.

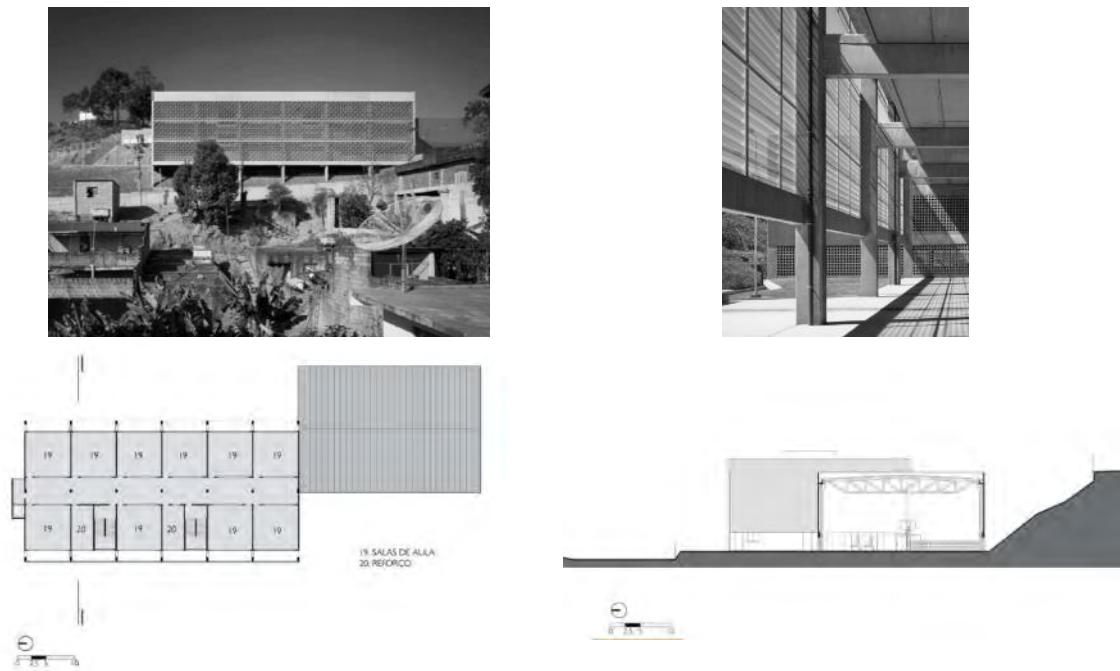

Figure 1: FDE school design example: "Escola Várzea Paulista". Courtesy of FGMF Architects

FDE school buildings are based on prefabricated reinforced concrete elements, similar to those used in other countries, like Spain. Designs are no longer stock-plans, but based on provision of a standardized short brief, minimum design requirements and a catalogue of architectural elements. This linear design process lacks evaluation loops at various stages. A sustainability milestone was established in 2010, when FDE required that all new school buildings must be certified under AQUA, the French HQE environmental rating scheme adapted to Brazilian contexts.

This paper is part of an on-going research project on school building design conducted at the University of Campinas (UNICAMP). Our research goals were to investigate if the certification requirements had a tangible positive impact on building quality, induced climate responsive architecture and provided adequate and comfortable environments for education. Nineteen FDE projects currently seeking AQUA certification were studied. First, we analysed the sample regarding climate responsiveness and critical performance aspects for learning environments. Then, we ran thermal and daylight simulations for a North-facing representative classroom to assess contribution of the designed shading devices.

2. METHODOLOGY

2.1 School building survey

Our surveyed database comprises 19 FDE projects designed between 2002 and 2014. All projects currently seek certification in one of the different AQUA process phases: concept design (13 schools), design (5 schools) and construction (1 school). Surveyed buildings accommodate from 8 to 27 FDE standard classrooms (7.2m x 7.2m) distributed over 2 to 5 floors and built areas ranging between 2,000 m² and 5,000 m². The floor-to-ceiling height varies between 2.7m and 3.0m. All sampled school buildings use the same construction materials and components, and all classrooms have acoustic ceilings.

Once this database was selected, five certification requisites were assessed, according to different sections of the AQUA reference guide:

- Building configuration and solar orientation, analysed according to sections 1.2.1 (Building orientation for solar and wind optimization) and 4.1.1 (Bioclimatic design strategies, including building dimensions and solar orientation of glazed areas);
- Building materials and components, analysed according to section 4.1.1, which demands compliance of the building envelope with level C of RTQ-C, a national energy efficiency label for buildings;

- **Daylight and views, analysed according to AQUA's specific recommendations for classrooms** and school buildings. All classrooms should be day lit (section 10.1.1) and have access to outdoor views (section 10.1.2). A minimum daylight factor of 1.2% must be achieved for 80% of the total number of classrooms (section 10.1.3), while higher values achieve extra points in the certification program. Though not a prerequisite, Section 10.1.4 also assigns certification points for avoiding glare, by protecting sitting and desk areas, as well as black or white boards from direct sunlight.
- Exterior solar protection, analysed according to Sections 4.1.1 and 8.4.3. The guide does not mention any specific recommendations for the design of exterior shading devices. Section 4.1.1 relates the solar orientation of glazed surfaces to the activity developed in a specific room. Section 8.4.3 states that spaces with a probability of being influenced by direct solar radiation (especially glazed areas) must have thermal comfort conditions controlled.
- Natural ventilation: Section 8.3 deals exclusively with thermal comfort of naturally ventilated spaces. There are no specific requirements for window opening dimensions. Section 8.3.1 requires that all naturally-ventilated, regularly-occupied spaces demonstrate, by computer simulation, that the percentage of occupied hours that achieve comfort conditions comply with RTQ-C requirements: between 60% and 70%, for level C (prerequisite); between 70% and 80% for level B (3 points); and above 80% for level A (4 points). Rooms with operable windows must ensure natural ventilation according to Section 8.3.2.

2.2 Computer simulations

One case study was chosen from the 19 schools of the database. Selection criterion was recurrence within our surveyed sample, regarding: building configuration, solar orientation, natural ventilation and exterior solar protection. The selected case study was School Jardim Santa Rita II, in a sub-tropical climate city near Sao Paulo, classified as bioclimatic zone 3, according to NBR 15220-2005. This 3-floor school has eight classrooms and combines a double-loaded corridor plan, with North-South classroom orientation and exterior horizontal fins (25% of perforation and reflective top coating) shading typical louvered windows. A North-facing classroom was selected for the simulation runs (Figure 2). Two models were created (Figures 3a and 3b), following the input parameters listed in Table 1. Sefaira and Energy Plus simulations respectively supported daylight and thermal comfort analyses.

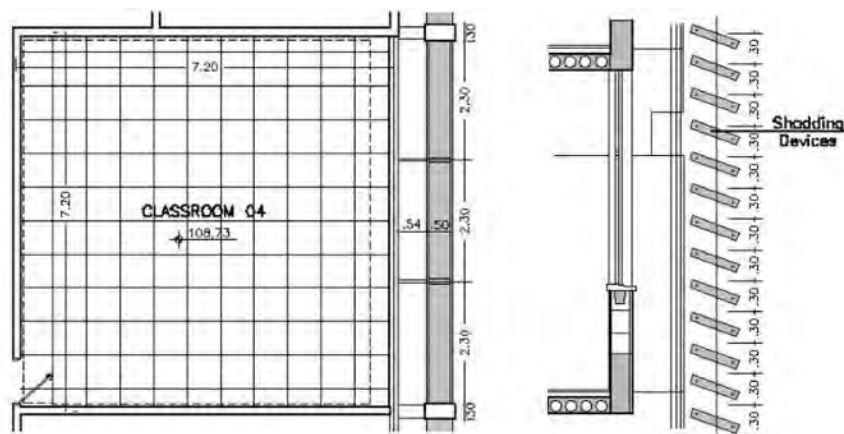

Figure 2: Simulated classroom floor plan and façade section

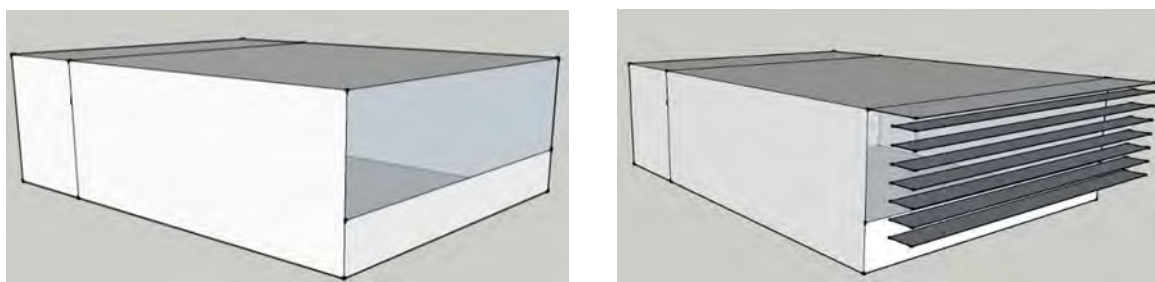

Figure 3: Classroom simulation models (a) without and (b) with shading devices

Daylight and views evaluation was based on AQUA criteria that demand simulation: Daylight factor (DF) and Useful Daylight Illuminance (UDI). DF relates the amount of illumination available indoors and outdoors at the same time, under overcast skies. UDI measures the well lit occupied time (illuminance between 100 lux and 2,000 lux), as well as the underlit and overlit occupied time percentages. UDI also considers the probability of glare for results over 2,000 lux.

Thermal comfort analyses considered ASHRAE 55:2013 adaptive model for occupant-controlled naturally conditioned spaces, which establishes acceptable monthly indoor operative temperature ranges, considering an 80% acceptability limit.

Parameter	Value
Ratio of width to length (building)	0.54
Solar orientation	N-S
Floor-to-ceiling height (m)	2.8
U-value - exterior wall (W/(m ² .K))	2.7
WWR (%)	70
U-value - roof (W/(m ² .K))	0.7
Glazing U-value (W/(m ² .K))	5.5
Glazing SHGC (%)	87
Exterior shading devices	Horizontal fins (North façade)
Solar absorptance –walls (%)	0.3
Lighting Power Density (W/m ²)	12
Electric Power Density (W/m ²)	16
Building operation	7am to 6pm (weekdays)

Table 1: Simulation modelling parameters

3. RESULTS

3.1 School building survey

3.1.1. Building configuration and solar orientation

All surveyed buildings have a rectangular shape, which can be thoughtfully oriented to expose the long facades towards North-South for passive solar strategies optimization (Figure 4b). However, only 32% of the schools are actually best oriented, whilst 26% are oriented East-West (Figure 4a).

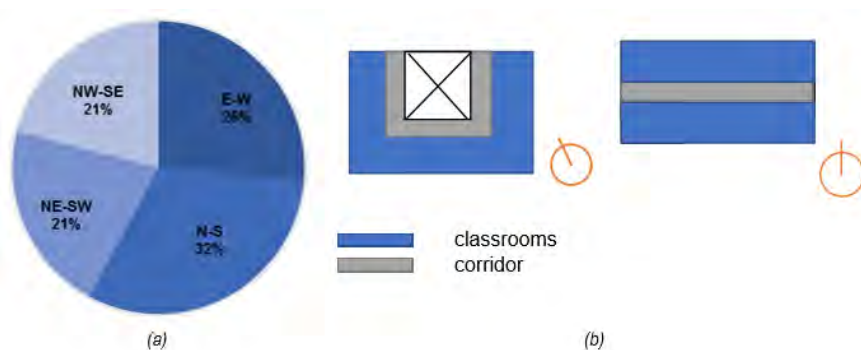

Figure 4: (a) Distribution of long facades orientation within the school buildings sample; and (b) Schematic ground floor plans of courtyard and linear schools

3.1.2. Building materials and components

All analysed schools have 20 cm-thick concrete blocks and plaster walls. Roof construction consists of insulated metal roofing panels over a reinforced concrete slab. Window-to-wall-ratio (WWR) for the two longitudinal façades

is between 70% and 74%. Average window U-value in our sample is $5.5\text{W}/(\text{m}^2\text{K})$, which corresponds to single 4 - 6mm glazing.

To comply with level C of RTQ-C, building façades and roofs in bioclimatic zone 3 must have U-values lower than $3.7\text{W}/(\text{m}^2\text{K})$ and $2.0\text{W}/(\text{m}^2\text{K})$, respectively. U-values of walls ($2.7\text{W}/\text{m}^2\text{K}$) and roofs ($0.7\text{W}/\text{m}^2\text{K}$) fall within RTQ-C's limits. **AQUA does not have any specific requirements for solar absorptance, but rather refers to RTQ-C, which limits it to 0.5 for external walls and roofs, as a prerequisite.** Even so, in the analysed sample, roughly half of the external wall surfaces are not compliant (Figure 5a).

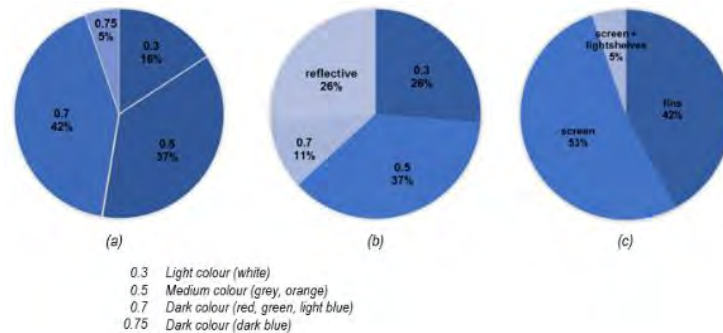

Figure 5: Distribution of (a) Solar absorptance of external walls; and of (b) Colour and (c) Type of exterior shading devices within the studied sample

3.1.3. Daylight and views

Classroom internal surfaces are painted white, to reflect daylight and ensure natural light distribution. While about 37% of the exterior shading devices have a solar absorptance of 0.5 and positively contributes to glare avoidance, one third (26%) of the cases have a reflective topcoat, which would actually provoke an opposite effect (Figure 5b). Windows are large in area, have transparent glass and the sill height permits views when sitting. Simulated results are presented in section 3.2.1.

3.1.4. Exterior solar protection

Classrooms in all buildings in our database have concrete or metallic exterior shading devices. Most designs include a perforated steel plate screen to protect classroom windows while allowing for daylight (Figure 5c). If adequately designed and adjusted, the provided exterior shading devices can potentially avoid glare. Simulated results are presented in sections 3.2.1 and 3.2.2.

3.1.5. Natural ventilation

As the majority of surveyed buildings follows the same floor plan model (central corridor with classrooms on both sides), cross ventilation in classrooms is impaired. In four schools this effect is alleviated by attaching the classroom access corridor to a courtyard (Figure 4b). Louvres (90%) and top hung windows were the fenestration types found in the sample. Classroom façade window height ranges from 1.8m to 2.2m, and totalize between 13.0m^2 and 15.8m^2 , with approximately 71% of operable area. On the corridor side, classroom windows are smaller: window height between 0.35m and 0.8 and area varying between 2.5m^2 and 5.8m^2 . Natural ventilation was out of our scope, but contributes to the overall thermal comfort conditions presented in Section 3.2.2.

3.2 Case study

3.2.1. Daylight simulation results

The simulated average Daylight Factor (Figures 6a and 6b) confirms that only the model without exterior shading devices ($\text{DF} = 3.29\%$, Figure 6a) would comply with AQUA requirements, but users would experience 28% of overlit occupied time (Figure 7), and glare issues should be adequately addressed by design. UDI simulation (Figure 7a) shows that underlit conditions did not occur in this case.

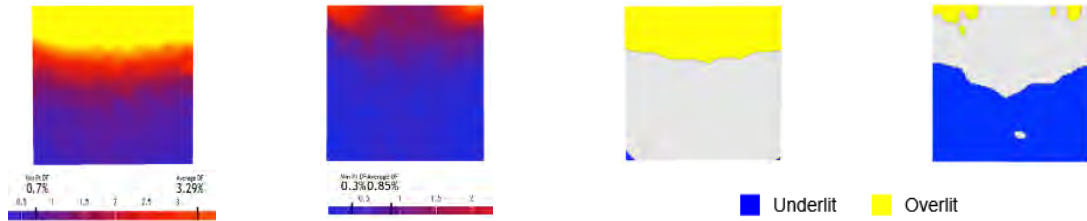
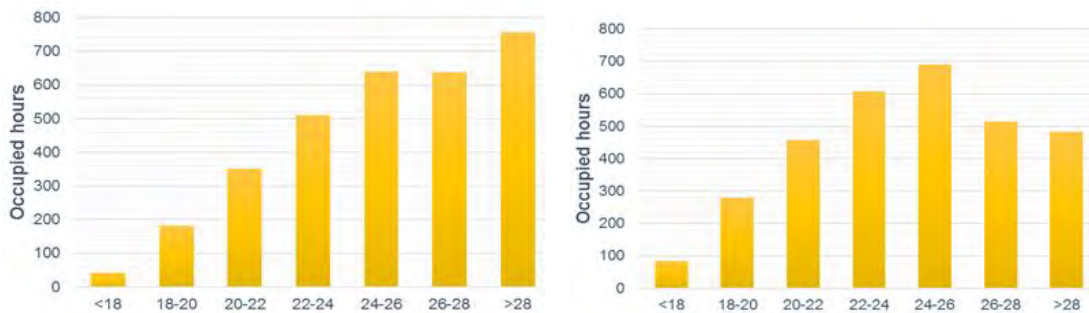

Figure 6: DF simulation (a) Without and (b) With shading devices Figure 7: UDI simulation (a) Without and (b) With shading devices

For the model with shading devices, DF is much lower (0.85%, Figure 6b) and such classroom would rarely experience possible glare (overlit conditions = 1%), but rather be underlit for 55% of the occupied time (Figure 7b).

3.2.2. Thermal comfort simulation results

The model without shading devices provided satisfactory thermal comfort conditions for 64% of the occupied period. Such performance is compatible with level C of RTQ-C, and meets the corresponding AQUA certification prerequisite. When shading devices were added, the comfortable period was increased to 71% of the occupied time. The improved performance would comply with level B of RTQ-C, and grant 3 extra points (Figures 8a and 8b).



Figures 8: Results of thermal comfort simulations (a) Without and (b) With shading devices

4. CONCLUSION

Compelling school architecture comprises a series of spatial qualities and positive user experiences, such as fit of architectural brief, educational methods and perceived socio-cultural values. Certification of school buildings, as required by FDE, is an opportunity to decrease environmental impacts while improving indoor environments, among other performance aspects. Conversely, our analysis revealed that, among building designs seeking AQUA recognition, orientation of school buildings to suit local climates is surprisingly neglected. Double loaded corridor floor plans are typically adopted, though they prevent cross-ventilation in classrooms. Solar absorptance of external walls is not compliant in roughly half of the cases. Finally, typical sun-shading device design improves thermal conditions of optimally oriented classrooms, but at the cost of impairing daylight harvesting in over half of the occupied time.

Though rating systems like AQUA can potentially contribute, the certification per se seems to have limited capacity to induce climate responsive architecture or delivery of adequate indoor environments for educational activities. Aiming for better design outcomes demands design process enhancements. Old, inefficient school models – as well as the design processes that generated them - should be revised. Design decisions impacts must be carefully reflected upon and continuously learn from assessment loops, simulations and inputs from users and specialists alike. Finally, building assessment data should inform new school building projects, to guarantee that we are actually advancing in the right direction.

REFERENCES

- [1] ABNT (2015). NBR. 15220. Desempenho Térmico de edificações. São Paulo, SP.
- [2] DELIBERADOR, M. S. (2010). O processo de projeto de arquitetura escolar no Estado de São Paulo: caracterização e possibilidades de intervenção (Masters Dissertation). Universidade Estadual de Campinas - UNICAMP, Campinas, SP, Brazil.
- [3] FCAV; CERWAY (2007). Referencial técnico de certificação, Edifícios do setor de serviços – Processo AQUA, Escritórios - Edifícios escolares, São Paulo, SP: Fundação Vanzolini.
- [4] FDE (2014). Fundação para o Desenvolvimento da Educação do Estado de São Paulo, FDE obtém certificação de sustentabilidade para 19 escolas.
- [5] INMETRO (2013). RTQ-C: Regulamento técnico da qualidade para o nível de eficiência energética em edificações comerciais, de serviços e públicas. Rio de Janeiro.
- [6] KOWALTOWSKI, D.C.C.K.; DELIBERADOR, M.S. (2014). Understanding school design processes, *Journal of Design Research*, Vol. 12 No. 4, pp. 280–307.
- [7] PONS, O., OLIVA, J.M., MAAS, S.R. (2010). Improving the learning process in the latest prefabricated school buildings. *Improving Schools*, 13(3), 249–265.

Project Guidelines for Construction of Biodigesters in Poor Communities in Brasil

Lizelda Maria MENDONÇA SOUTO^a, Sérgio PERES^b, Emilia KOHLMAN-RABBANI^c, Viviany NOGUEIRA^d, Ana Rita DRUMMOND^e

^a Polytechnic School of University of Pernambuco, Brazil, lizambr2004@yahoo.com.br

^b Polytechnic School of University of Pernambuco, Brazil, sergperes@gmail.com

^c Polytechnic School of University of Pernambuco, Brazil, emilia.rabbani@upe.br

^d Polytechnic School of University of Pernambuco, Brazil, vivianynogueira@gmail.com

^e Polytechnic School of University of Pernambuco, Brazil, anaritadrummond@gmail.com

ABSTRACT

In today's materialistic society, there is a constant pressure to consume goods and services without taking into account that this unbridled acquisition will lead to an increase in the generation of solid waste that, in most cases, will not be properly disposed of, culminating in the proliferation of vectors for Zika, Dengue, Chikungunya, Leptospirosis, and Meningitis, as well as structural problems such as flooding and contamination of soil and groundwater. However, most wastes contains organic materials with the potential to produce biogas that can be used to generate electricity. When sanitation is not properly managed it can cause incalculable damage to the environment, to public health, to the population, and to the urban order. This study presents projectual guidelines for sustainability of low income communities in urban areas through the installation of biodigesters as an alternative for the proper disposal of their organic solid waste and sewage in order to improve sanitation and enable the generation of biogas and power for such communities. The guidelines were elaborated based on interviews with community leaders, the socioeconomic profile of community residents, the amount of waste generated, sewage drainage problems, availability of open areas adequate for the installation of biodigesters, the post-installation maintenance manual, as well as an analysis of the Brazilian laws and regulations that standardize the construction aspects. The proposed guidelines are intended to assist managers in decision making with regard to sanitation and generation of biogas from waste, which is currently a problem for local development.

Keywords: biodigesters, low income communities, sustainability in urban areas.

1. INTRODUCTION

In large Brazilian cities, innumerable informal dwellings, also known as needy communities, lack basic sanitation, safety, transportation, decent housing, and the means to enable the development of infrastructure that could improve the quality of life for the population. According to Fantinatti et al. (2015), informal dwellings arise spontaneously, as in the cases of invasions or irregular settlement in difficult-to-access areas that are established because of proximity to work or availability of open land. Faced with this problem, the need to apply engineering knowledge in support of low-income communities with projects that bring sanitation, leisure, education, sustainable housing, and generation of energy to the population becomes evident.

In Brazil, basic sanitation is defined by Law 11.445/2007 as the set of services, infrastructure, and operational installations for drinking water supply, sewage, street cleaning, solid waste management, floodwater management, and urban drainage. According to etymology, sanitation is the act or effect of sanitizing, disinfecting, deodorizing; it refers to the application of measures to improve hygienic conditions of a place or region, especially drainage, making it suitable for habitation and bringing improvements to health. (Weiszflog, 2016).

Therefore, sanitation implies a determining factor and condition for public health, and must be regarded as of interest to social policy for the protection of the population. According to Embrapa (2010), 75% of hospital admissions in Brazil are associated with the lack of basic sanitation, often related to informal housing combined with the absence of three basic services: running water in at least one room, sewage network or septic tank, and trash collection. (Observatório das Metrópolis, 2010)

Faced with these sanitation problems, the objective of this article is to bring alternatives through project guidelines and a proposed layout for biodigesters, considering economic viability and ease of installation and maintenance,

that can be used to channel sewage and solid waste in needy communities, improving the local basic sanitation and public health, as well as contributing to the improvement of sewage spilled into bodies of water.

1.5 The city of Recife and basic sanitation

In middle- and upper-class neighborhoods of large Brazilian cities, it is not common for the populace to stop and think about how many times they turn on faucets or the shower, or flush the toilet. It is not a habit to analyze the consumption of water by families, the neighborhood, the city, or the state where one lives, much less to think about the collection, treatment, and maintenance of its sewer systems. (Revista Proteção, 2012).

According to the latest census from the Brazilian Institute of Geography and Statistics, the City of Recife has a population of 1.5 million. Recife is a coastal city surrounded by rivers and marshes. Its unplanned territorial occupation, associated with poverty and misery, has spurred the growth of informal housing with innumerable socio-environmental problems, lack of basic sanitation, and numerous clandestine connections of sewage to the **city's drainage network**. (Picarelli, 2016).

The municipality of Recife covers 220 km² of area and is divided into six (6) **Politico-Administrative Regions (RPA's)** for the purposes of forming, executing, and evaluating the policies and plans of the government. Each RPA is subdivided into three (3) micro-regions, which define local-level municipal interventions and coordination with the populace. These micro-regions are subdivided into neighborhoods, and within them can be found the **Special Zones of Social Interest (ZEIS), which are "portions of territory to be given priority in urban recovery, land regularization, and social housing projects, including the recuperation of degraded properties, the provision of social and cultural amenities, public spaces, services, and locally-based businesses."** (Fonseca et al., 2014, p.1).

The ZEIS were integrated in the City Master Plan in 2008. Today, Recife has 66 ZEIS distributed throughout 94 neighborhoods. Such neighborhoods show symptoms of urban land use exhaustion. Many of these neighborhoods are located in riparian areas, near drainage canals, or in sensitive hillside areas highly restrained from expanding and installing urban infrastructure, resulting in a wide range of structural and socio-environmental problems for their low-income residents, who have no other housing options.

The Brazilian reality is that 35% of the population (reaching over 60% in Recife) relies on inadequate solutions for their sewage removal. Only 20 million habitants in Brazil have sewage disposal systems or septic tanks that are considered suitable for the disposal of wastes. (Ministério das Cidades & Secretaria Nacional de Saneamento Ambiental, 2014; Ministério das Cidades, 2014).

1.6 Use of biodigester systems in rural and urban areas

According to the United Nations Development Programme (PNUD) and the Ministry of the Environment (MMA) (2010), a biodigester is a closed chamber that provides appropriate conditions for the fermentation of organic material carried out by methanogenic bacteria. This decomposition process generates biofertilizers and biogas, which is formed from the following gases in these proportions: methane 50-70%, carbon dioxide 25-40%, hydrogen 1-3%, hydrogen sulfide 0.1-0.5%, and other trace gases.

According to Peres (2010), 1 m³ of biogas with 60% methane has a calorific value of 19.52 MJ.m⁻³. The advantages of treating waste in a biodigester are a reduction in the amount of waste, the generation of a renewable energy source (biogas), and the production of biofertilizers with little odor and rich in nutrients that can be used in agriculture.

The study made by Turdera and Yura (2015) in the city of Dourados in Mato Grosso do Sul, Brazil, simulated the home use of biogas, where 8.93m³ of biogas per day was able to provide for the cooking of meals, illumination of four light bulbs for three hours, refrigerate food, and provide a hot bath for a family of five people.

Despite being a reality for many years in other countries of the world, the use of biodigesters remains in its infancy in Brazilian urban areas. However, a few examples of research and development can be seen at Brazilian universities (Pimentel et al., 2015). In urban areas, specifically ZEIS where there is disorderly settlement and high population density, large-scale projects are not applicable due to the absence of free space within the communities, necessitating a new compact design that is simple to install, operate, and maintain.

2. METHODOLOGY

Initially, a literature review was conducted on the political-administrative distribution, neighborhoods, and ZEIS, as well as the sanitation infrastructure of the city of Recife. Subsequently, a descriptive Field study was conducted through photographic registry and informal interviews with community leaders in the ZEIS of Borborema, Vila Arraes, and Carangueijo Tabaires with the goal of identifying, mapping, and observing the flow of sewage and the disposal of Municipal Solid Waste (MSW), discovering the locations of open areas for installation of biodigesters, tracing the socio-economic profile of residents, and estimating the electrical current necessary to supply homes, residents associations, or community centers open to all local residents.

Using the ESIG program, Geographic Information of Recife, it was possible to visualize the proximity of the communities visited to bodies of water, and to map rivers, drainage canals, lakes, basins, and the sea, as well as to store information necessary for a potential study of environmental impacts caused by improper sewage disposal.

Project guidelines were proposed to channel sewer water to a “homemade” biodigester based on laws and technical standards, international and national case studies in urban and rural areas, technical manuals from biodigester manufacturers, a survey of the average wastewater volume produced per family, and the Pernambuco Solid Waste State Plan (PERS), generating as output biofertilizers, and biogas that can be utilized within the local community. The proposed guidelines also take into account the use of low-cost construction materials and the ease of installation and operation by the local community residents.

3. EXPLORATORY STUDY IN A ZEIS OF RECIFE

The exploratory field visits were conducted in 2015 and 2016 at three ZEIS communities in the Recife Metro Area: Borborema, Vila Arraes, and Carangueijo Tabaires. The visits were performed to collect data for a pilot project biodigester proposal and note the existing possibilities for the implantation of biodigesters in needy communities. In the ZEIS of Borborema, a potential area for the biodigester installation was identified, capable of attending the needs of a few homes and whose biogas could be channeled to community centers.

ESIG (Geographic Information of Recife), was used to map the ZEIS and visualize their proximity to bodies of water. With use ESIG, and photographic records, it was possible to identify the irregular and inadequate disposal of waste and sewage in the community of Carangueijo Tabaires, Figure1 and its interconnection with the Capibaribe River, with the ABC drainage canal, and with the Nature Conservation Unit (NCU) Zeca Island.

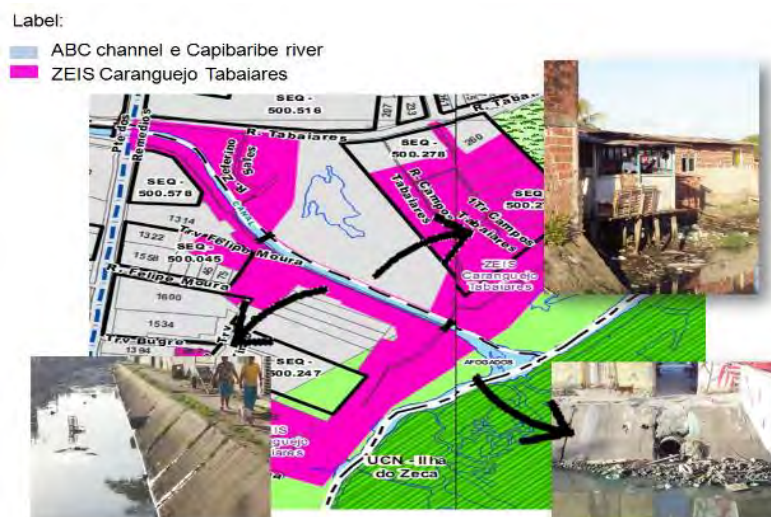

Figure 1: Location of inadequate waste and sewage treatment in the visited ZEIS. Source: Author, 2016

According to the informal interviews with local residents during the exploratory visits, respiratory illnesses, meningitis, leptospirosis, hemorrhagic dengue, chikungunya, zika, and scorpion bites have been reported and have been the cause of death for many children in the poorest communities due to the unsanitary conditions to which they are subjected.

4. DEFINITION OF GUIDELINS FOR THE PREPARTION OF PROJECTS AND LAYOUT PROPOSAL FOR URBAN BIODIGESTERS

The guidelines were divided into four sub-items: (1) basic elements, (2) minimum distances from areas of influence, (3) choice of location and (4) specific elements to establish criteria for the development of biodigester projects in needy communities. Based on **current local legislation, technical standards relevant, guidelines from manufacturers' manuals**, as well as on data obtained from the exploratory visits to needy areas of Recife, the criteria are detailed on the following flowchart:

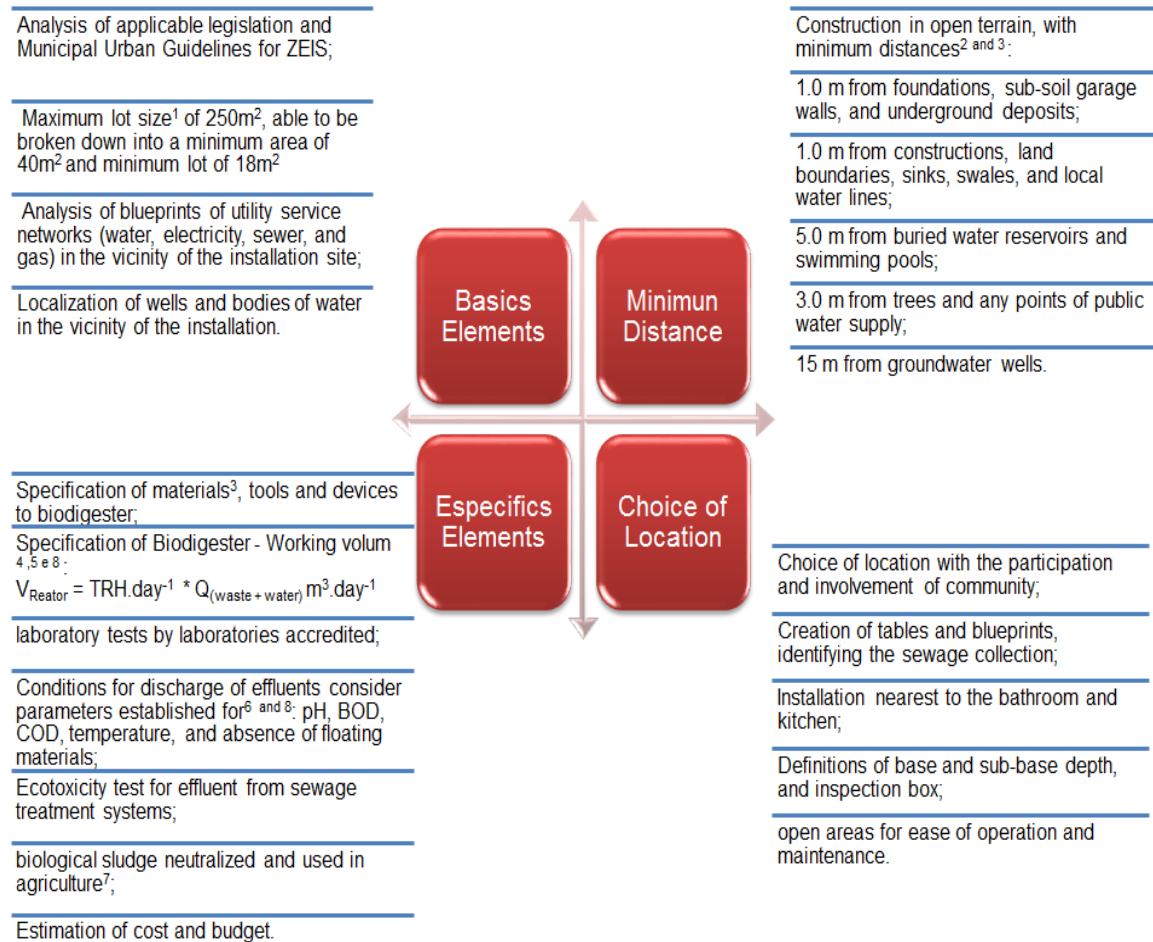

Figure 2: Guidelines for project preparation. source: created by the author based on ¹Recife (1995); ²CPRH (2004), ³Creder (2006); ⁴ABNT (1993); ⁵ABNT (1997); ⁶CONAMA (2011); ⁷CONAMA (2006), ⁸ONUDI (2016).

The Total Waste (RT) value was calculated in accordance with Equation 1, considering the value of Organic Waste (RO) added to the waste water (NA) produced per person.day⁻¹. The RO value 0.9924 kg per person.day⁻¹ was calculated from the PERS (SMAS & ITEP, 2012). For toilet waste water (WW), the value of 0.2 kg feces+urine per person.day⁻¹ was considered, according to NBR 7229:1993. The total waste feeding into the biodigester daily can be calculated by the expression below:

$$RT = Pop \cdot [(RO + WW)]$$

Were, RO in kg per person.day⁻¹, WW in kg per person.day⁻¹.

Equation 1

The dimensions of the system were calculated according to ONUDI (2016), and using Equation 2 below. The process was considered to be mesophilic with fermentation in 30 days and the average temperature of Recife around 30°C, obtaining a reactor volume (fiberglass box) of 5.97 m³. For the gasometer, a PVC tarp attached to the base of the fiberglass reactor that stores the biogas generated, a volume of 30% of the V_{Reactor}, 1.791 m³, was estimated.

$$V_{\text{Reactor}} = \text{TRH} * Q (\text{RT} + \text{Water})$$

Equation 2

were V_{Reactor} in m^3 for the biodigester, Q = total contribution RT sun Water in $\text{m}^3.\text{day}^{-1}$ and TRH = Water Retention time, in days.

To create the Urban Biodigester prototype (Figure 3), materials available in the market were considered and a family made up of five (5) residents was contemplated. The prototype will use a 6000 L fiberglass box (to fit the estimated waste according to Equation 2); 3.40m^2 of PVC canvas, shown in Figure 3 and indicated by the letter (a); 100 mm PVC pipes shown by the letter (b) to transmit waste water (AN), for the output of biofertilizer (c), and for receiving organic wastes (d). To operate the biodigester, a slope of 5% should be used for the waste water pipes. **For the biogas output, the installation of a 4" Spin pipe connection is suggested, as well as a gas filter (g) and a meter to measure the biogas output (h).**

A commercially available inspection/interconnection box must be installed and adapted with an interior grid having a minimum diameter of 30 cm, illustrated by the letter (f) in Figure 3, before the input pipes to the biodigester in order to hold accidental discards of non-biodegradable material in the toilet, such as wipes and plastic packaging that can clog the system. It's necessary a complementary treatment of the liquid effluent through the use of a buried sand filter (ABNT, 1993) is indicated, as shown in Figure 3 (f).

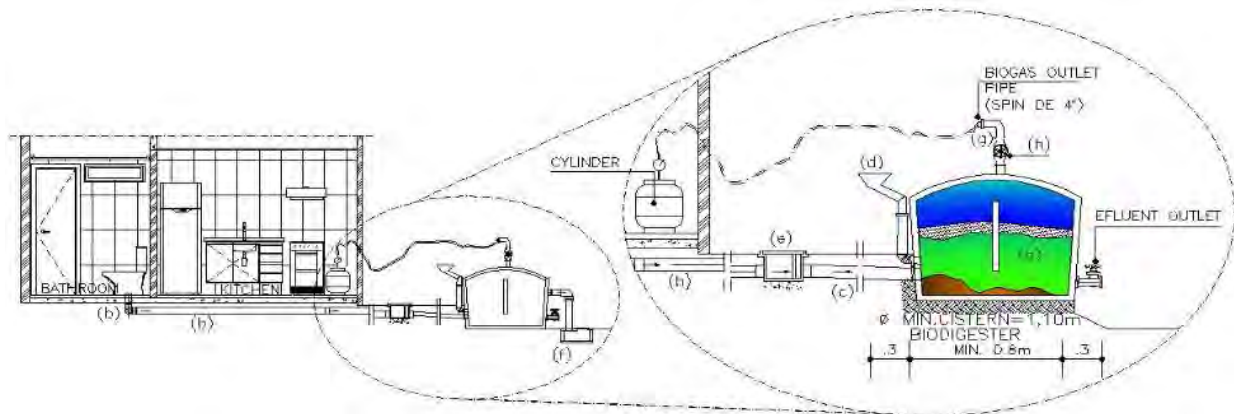

Figure 3: Proposal for prototype urban biodigester to be in Recife. Source: Autor, 2016

This system is expected to generate $\frac{1}{4}$ bottle of LPG. month^{-1} and 20 L of biofertilizer/month, considering that the first withdrawal during the production period should occur after approximately 30 days have passed. The average time to recoup the initial investment was estimated to be 2.6 years, from the sale of biofertilizer and savings from the reduced purchase of cooking gas.

5. CONCLUSIONS

Large Brazilian cities, just like cities in other developing countries, have suffered because of the close link between lack of efficient public policies, unequal income distribution, disorderly settlement, and environmental degradation, which threaten the preservation of remaining natural areas located in protected areas and compromise the quality of life of the general population, and especially that of excluded communities. From this study, it can be concluded that:

- With the use of the ESIG tool correlated to photographic records, it is possible to evaluate the presence of environmental impacts in the areas, identifying affected water bodies.
- Considering local limitations, social Technologies must be invested in (products, techniques, and low-cost equipment that can be replicated anywhere in the country).
- **Public policies that encourage residents and don't create bureaucratic barriers to implementation are needed, as well as training in the operation and maintenance of the equipment, providing autonomy for the families involved.**

- The average time for the recovery of initial investment is estimated at 2.6 years, considering the profit obtained through the sale of the by-products generated by the process.
- The implantation of urban biodigesters is consistent with Law 11.445/2007, contributing to the management of sewage and solid wastes, by using them as fuel for the biodigester itself. They also bring technological advances related to the generation of electricity from biogas.
- The implantation of social Technologies for the treatment of sewage, beyond the direct effects of protecting the environment, improving water quality, scenery, and public health, can above all bring dignity to the families who live in informal housing and the surrounding neighborhoods.

REFERENCES

- [1] Agência Estadual de Meio Ambiente e Recursos Hídricos – CPRH. 2004. Manual Técnico CPRH 001 Dimensionamento de tanques sépticos e unidades básicas complementares. 2nd rev. e atual. Recife, CPRH.
- [2] Brasil.1993. Associação Brasileira de Normas Técnicas. Projeto, construção e operação de sistemas de tanques sépticos: NBR 7229/93. Rio de Janeiro, September 1993.
- [3] Brasil. 2007. Lei 11. 445 de 5 de Janeiro de 2007. Estabelece diretrizes nacionais para o saneamento básico. Retrieved from: http://www.planalto.gov.br/ccivil_03/ato2007-2010/2007/lei/l11445.htm . [Retrieved on 14 May 2016].
- [4] Creder, H. 2006. Instalações hidráulicas e sanitárias. 6 ed. Rio de Janeiro: LTC – Livros Técnicos e Científicos Editora.
- [5] Conselho Nacional de Meio Ambiente – CONAMA. 2011. Resolução n. 430. Dispõe sobre as condições e padrões de lançamento de efluentes. Retrieved from: <http://www.mma.gov.br/port/conama/res/res11/res43011.pdf>. [Retrieved on 20 May 2016].
- [6] Conselho Nacional de Meio Ambiente – CONAMA. 2006. Resolução n.375 Define critérios e procedimentos, para o uso agrícola de lodos de esgoto gerados em estações de tratamento de esgoto sanitário e seus produtos derivados. Retrieved from: <http://www.mma.gov.br/port/conama/res/res06/res37506.pdf> . [Retrieved on 14 May 2016].
- [7] Fantinatti et al. 2015. Indicadores de sustentabilidade em engenharia como desenvolver. Rio de Janeiro, Elsevier, 2015.
- [8] **Fonseca et al. 2014. 'Zonas Especiais de Interesse Social e Meio Ambiente: O caso de Brasília Teimosa'**. V Congresso Brasileiro de Gestão Ambiental. Belo Horizonte, 24-27 novembro 2014.
- [9] Ministério das Cidades &Secretaria Nacional de Saneament Ambiental. 2014. Plano Nacional de Saneamento Básico – PLANSAB. Brasília. Retrieved from: <http://www.saneamentobasico.com.br/portal/index.php/plansab>. [Retrieved on 14 May 2016].
- [10] Observatório das Metrôpolis. 2009. Vulnerabilidade Socioambiental das Regiões Metropolitanas Brasileiras. Retrieved from: http://www.observatoriodasmetrolopes.net/images/abook_file/relatorio004_2009.pdf. [Retrieved on 20 March 2016].
- [11] Observatório de Energias Renováveis para a América Latina e o Caribe – ONUDI. 2016. O Biogás. Retrieved from: <http://www.renenergyobservatory.org/br/programa-de-capacitacao.html>. [Retrieved on 20 October 2016].
- [12] **Peres, S. 2010. 'Biodigestores e Biogás: Soluções Energéticas'**. I Seminário de Tecnologias de Produção de Biogás, Recife. Anais do I Seminário de tecnologias de produção de Biogás, V. Unico.
- [13] Picarelli, S. Saneamento e participação social. Retrieved from: http://www.switchtraining.eu/fileadmin/template/projects/switch_training/files/Modules/Modules_Portugues_e/Case_studies/Estudo_de_caso_Recife.pdf . [Retrieved on 25 June 2016].
- [14] Pimentel, T. J. F.; Souto L. M. M.; Pereira M. L. B. S. B.; Silva E. C. C.; Kohlman-Rabbani E. R. 2015. **'Geração de Energia e Biogás usando Biodigestores: uma opção ambientalmente correta para Região Metropolitana do Recife'**. XXII Simpósio de Engenharia de Produção - Política Nacional de Inovação e Engenharia de Produção. Bauru, SP, Brasil.
- [15] Programa das Nações Unidas para o Desenvolvimento - PNUD & Ministério do Meio Ambiente. 2010. Resumo Executivo: Estudo sobre o Potencial de Geração de Energia a partir de Resíduos de Saneamento. São Paulo: Arcadis Tetraplan.
- [16] Revista Proteção. 2012. Trabalho em esgoto requer medidas de higiene e prevenção. Retrieved from:http://www.protecao.com.br/noticias/leia_na_edicao_do_mes/trabalho_em_esgoto_requer_medidas_de_higiene_e_prevencao/A5yJAQji/4177. [Retrieved on 25 March 2016].

- [17] Secretaria de Meio Ambiente e Sustentabilidade - SMAS & Instituto de Tecnologia de Pernambuco – ITEP. 2012. Plano Estadual de Resíduos Sólidos de Pernambuco – PERS-PE. Jul. 2012.
- [18] Souto L. M. M.; Nogueira V.; Kohlman-Rabbanl E.; Drummond A. R.; Peres S. 'Project guidelines for **construction of biodigesters in poor communities in Brasil**', paper presented at the **Sustainable Urban Communities Towards a Nearly Zero Impact Built Environment**. Vitória – ES: SBE, 2016.
- [19] Turdera M. V. & Yura D. 2006. Estudo da Viabilidade de um Biodigestor no Município de Dourados. Enc. Energ. Meio Rural. An. 6, 2006.
- [20] Weiszflog W. 2016. Moderno Dicionário da Língua Portuguesa Online. Retrieved from: <http://michaelis.uol.com.br/moderno/portugues/index.php?lingua=portuguesportugues&palavra=saneamento>. [Retrieved on 10 May 2016].

Track 5: Innovation for Wellbeing

Session 1.8: Innovations for Occupant Wellbeing (1)

Research and Development of Noise Mitigation Measures for Public Housing Development in Hong Kong

MW WONG^a, John HL HO^b, Stephen YIM^c

^a Hong Kong Housing Authority, Government of the HKSAR, Hong Kong SAR, mw.wong@housingauthority.gov.hk

^b Hong Kong Housing Authority, Government of the HKSAR, Hong Kong SAR, hl.ho@housingauthority.gov.hk

^c Hong Kong Housing Authority, Government of the HKSAR, Hong Kong SAR, stephen.yim@housingauthority.gov.hk

ABSTRACT

Hong Kong is a high density living environment. With scarce land sources, residential developments, including public housing developments, may be located in close proximity to heavily trafficked roads or other noise sources. Embracing a caring attitude to create a healthy living environment to our residents in public housing estates, the Hong Kong Housing Authority has applied a host of noise mitigation measures to reduce the impact and nuisance. Depending on the individual site characteristics, noise mitigation measures can be applied at source, at propagation path and/ or at receiver end. Apart from these measures, where the noise impact is too severe for these mitigation measures to be adequate, more innovative building design in a cost effective manner becomes essential particularly for difficult public housing sites. This paper will highlight our recent research and development of innovative building designs on noise mitigation by making reference to some public housing projects in Hong Kong. A detailed case study will be presented holistically on the evolution of the acoustic balcony from its conceptual arc-screen form to the first generation of acoustic balcony and lately to an enhanced configuration to tackle the most severe noise challenge without compromising the performance of natural ventilation for the flats.

Keywords: noise mitigation measures, high-performance building, acoustic balcony

1. INTRODUCTION

Under the land use planning mechanism, the public housing development need to have noise assessment conducted to demonstrate compliance with the criteria under the Noise Control Ordinance and Hong Kong Planning Standards and Guidelines (HKPSG), especially for sites requiring rezoning to residential use.

Many public housing sites are subject to severe noise impact from the environment such as roads, railways and mechanical plants at industrial/ commercial buildings. Various design measures like single-aspect design, optimized block disposition, architectural fins, noise barriers, non-noise sensitive podiums and buildings such as multi-storey car parks or retail facilities as noise buffers will be applied to address the traffic noise impact. While each measure has its own merits and demerits, site constraints often restrict their full application, and more innovative measures are required at particularly difficult sites. In recent years, we have carried out research and development on innovative mitigation measures under collaborative approaches with our stakeholders in tackling severe noise issues in our developments.

2. SPECIFIC DESIGN TO TACKLE NOISE ISSUES

In general, mitigation at source and mitigation on the path of propagation are the most effective ways of easing noise problem. The choice of mitigation measures at source depends on site constraints and the acoustic performance required for individual housing projects.

2.1 Special noise cover for public transport interchange (PTI)

A number of our public housing sites are located very close to PTIs. Noise barriers are sometimes ineffective in blocking the line-of-sight to the noise source at the PTI as recommended in the HKPSG. Noise cover has to be used instead. To avoid the use of mechanical ventilation and fire services installations in association with a full

cover which will increase the future maintenance costs, we designed a special cover with appropriate openings for PTIs at Hung Fuk Estate (Figure 1) and Shui Chuen O Estate, allowing the use of natural light and ventilation to minimize energy consumption.



Figure 1: Special noise cover with openings for PTI at Hung Fuk Estate

2.2 Specific building block design

While noise impact is more effectively mitigated at source, such mitigation measures may not always be practical for reasons such as lack of space for noise barrier erection. Hence, mitigation measures at the receiver end need to be considered to overcome the noise impact. These measures are based on three types of acoustic principles – screening, setback and reducing view angle.

For some specific sites, the building blocks may be designed to set back from noisy roads and disposition at a skewed angle and farthest away from the noise source to reduce the impact on the building façade. Sometimes, vertical fin walls may also be added adjacent to windows to reduce the view angle towards the noisy roads, thus lower the noise levels at the flats. Single-aspect building design with non-sensitive receivers, such as kitchen and bathroom, facing the noise sources could be a very effective measure to solve severe noise issues. Long Ching Estate in Yuen Long (Figure 2) is an example of successfully mitigating noise impact with passive design and planning.

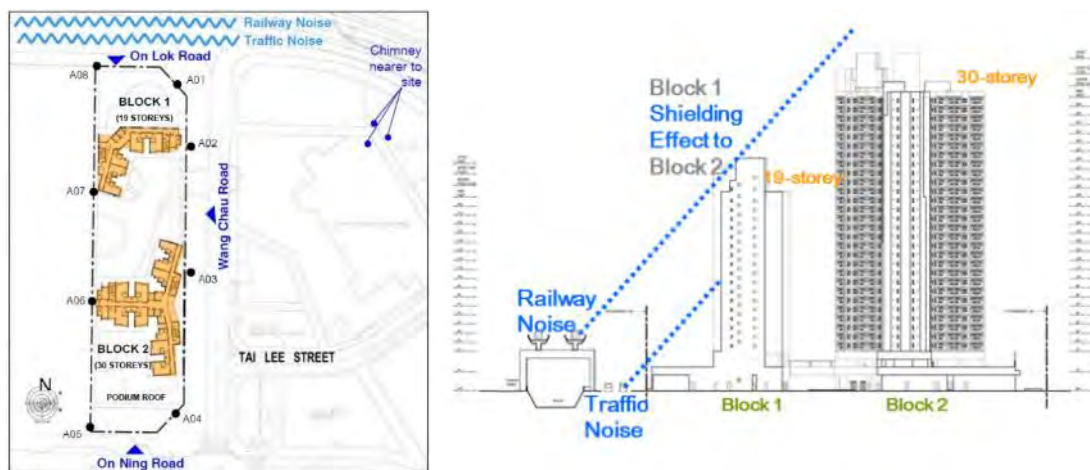

Figure 2: Long Ching Estate

Under extremely severe conditions, indirect mitigation measures in the form of window insulation and air conditioning could be considered as the last resort. However, it would be at the expense of natural ventilation.

3. INNOVATIVE MITIGATION MEASURES

Apart from the above specific noise mitigation measures, we have recently developed more innovative measures at the receiver end for mitigating road traffic noise in order to maximize site development potential and improve the living environment. These are described in details as follows:

3.1. Acoustic window

For San Po Kong public housing development which abuts heavily trafficked Prince Edward Road East, the unmitigated noise level at the site boundary was anticipated at 85 dB(A). Apart from other conventional measures, the project team needed to work out innovative measure to further attenuate 8 dB(A) in order to meet 70 dB(A) noise standard as a rezoning requirement. Hence, we collaborated with Environmental Protection Department (EPD) and the Hong Kong Polytechnic University (HKPolyU) to form a Research Team to work out the design of acoustic window, which would function as a modified double-glazed window with offset openings to allow natural ventilation (Figure 3). In mid 2009, we commenced our exploration by conducting laboratory tests on this window design concept with various window configurations, noise source orientation, use of sound absorption material in the window system etc. to verify the noise attenuation performance of the design. The laboratory testing provided very promising results.

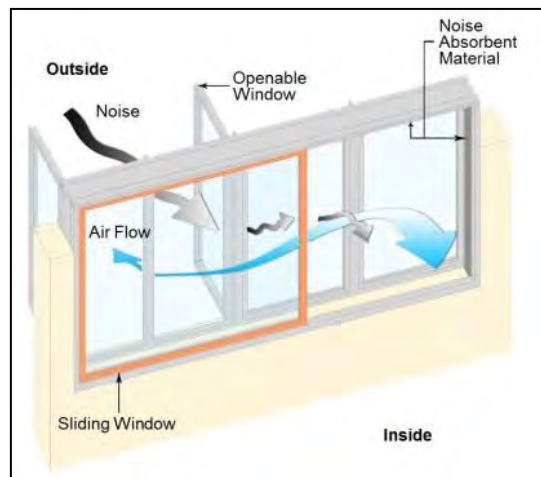

Figure 3: Configuration of acoustic window system

Subsequently, full scale mock-up flats installed with prototype acoustic window was set up on site for in-situ acoustic monitoring (Figure 4). Upon testing of the acoustic window for direct comparison of performance against conventional window, it was established that the acoustic window could achieve noise attenuation up to about 8 dB(A).

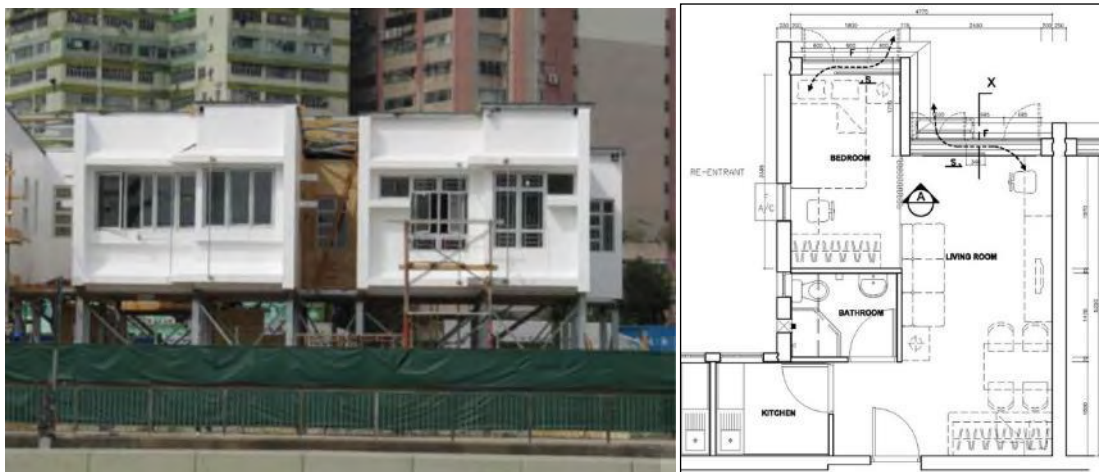

Figure 4: Mock-up flats for comparison of the performance of conventional window and acoustic window

With the employment of acoustic window system, 100% predicted noise compliance with the noise standard can be achieved to enable the San Po Kong project to proceed. Upon completion of the project, further noise monitoring would be arranged in completed flat for verification. During the design process, ventilation and other operational factors like window cleansing, clothes hanging and long term maintenance have been carefully considered from **the residents' perspectives**.

4. A CASE STUDY OF ACOUSTIC BALCONY

4.1 Acoustic balcony (Arc-screen to first generation)

Wing Cheong Estate development, abutting the elevated West Kowloon Corridor, is exposed to severe road traffic noise impact. Since the site and road configuration rendered conventional noise measures impractical, the project team came up with an innovative arc-screen design concept for shielding noise impact in front of the windows.

Desktop numerical analysis was first conducted to explore the effectiveness of the measure. With the promising desktop results, the project team subsequently proceeded with a 3-storey full scale model prototype installation for the in-situ noise measurements. Various arc-screen options, different materials and test scenarios have been worked out for testing (Figure 5). Results demonstrated the effectiveness of noise attenuation by the arc-screen.



Figure 5: Site mock-up model at Dongguan and measurement scenarios

Upon further consultation with various stakeholders, this arc-screen design concept finally evolved in the form of an acoustic balcony for use in the project, as shown in Figure 6.

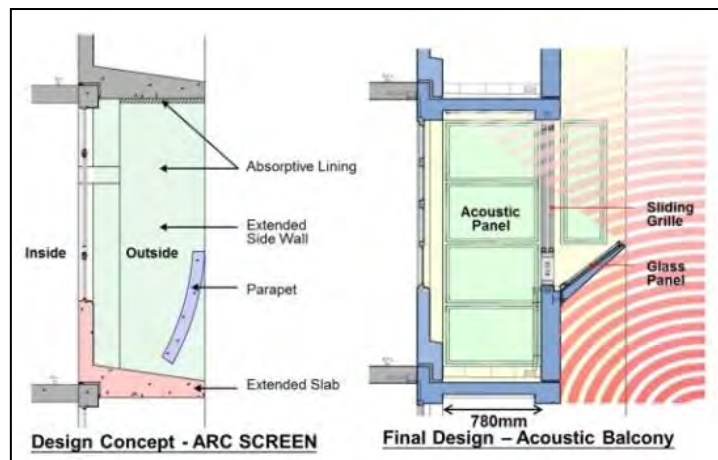

Figure 6: Initial arc screen design concept and first generation of acoustic balcony design

Together with the application of noise absorptive linings, the Acoustic Balcony could achieve maximum noise reduction up to 6.4dB(A). After completion of the building works in July 2013, on-site noise verification has been conducted, confirming the predicted noise reduction could be achieved.

Use of Acoustic Balcony has enabled the Wing Cheong Estate development to proceed amidst the severe noise impact. Consideration has been given to facilitate associated daily operation such as clothes hanging and window cleaning as well as long term maintenance. According to the resident survey taken after its occupation in 2013, this Acoustic Balcony design which could effectively reduce noise by about 2 to 6 dB(A) were much to the satisfaction of the tenants.

4.2 Acoustic balcony (Enhanced design)

Although successful in developing the innovative measures of acoustic window and acoustic balcony (Arc-screen to First Generation), we are not complacent. We looked into an enhanced Acoustic Balcony design (Figure 7), which amalgamates the acoustic window concept in the first generation of Acoustic Balcony. To ameliorate the incidence of noise through the balcony door into the flat, a sliding screen is installed in front of the balcony door in the balcony. This arrangement allows the ventilation path to be of decent width. Other auxiliary feature like noise adsorptive material at the wall and ceiling of the balcony and inclined panel projecting from the parapet would be provided on a site-specific basis for further noise mitigation enhancement. Apart from the noise aspect, other factors such as natural ventilation have to be carefully considered in the enhanced version.

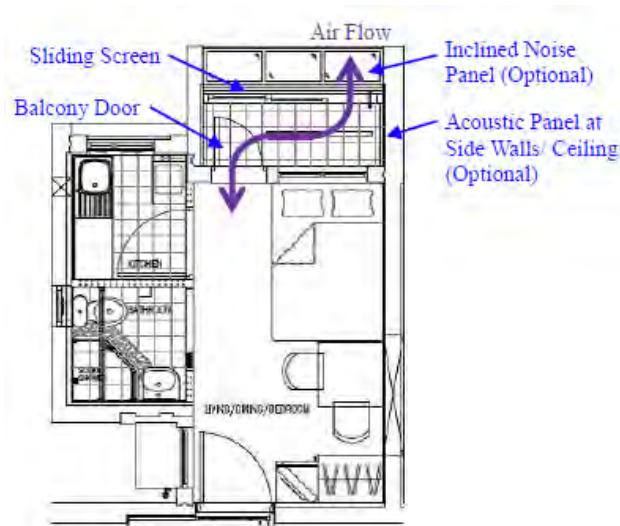

Figure 7: Layout of enhanced acoustic balcony design

In July 2015, we set up full-scale mock-up flats for the test case unit with prototype acoustic balconies and the base case unit with conventional window inside an existing vacant school building at Yue Wan Estate to verify the effectiveness of the noise reduction effect by in-situ acoustic measurements (Figure 8). The existing vacant school building would be demolished and the site would be developed for a public rental housing development providing some 800 flats for 2019/2020. This housing development is the first pilot project adopting the enhanced Acoustic Balcony design. Both in-situ traffic noise source and loudspeaker noise source had been used for the measurements.



Figure 8: Mock-up flats for comparison of the performance of enhanced acoustic balcony and conventional window

At least 20 microphones were employed to measure simultaneously the exterior and interior noise levels of the mock-up flats under 23 scenarios of different flat/ enhanced balcony settings. Besides, loudspeaker arrays at different offset distance representing different inclination angle of noise source were employed to simulate the flats at various levels. Upon testing for different flats and enhanced balcony scenarios, it was established that, the enhanced Acoustic Balcony with the fittings as stated above could achieve relative noise attenuation up to around 10dB(A), which was even higher than Acoustic Window and the first generation of Acoustic Balcony. It would be an effective design for noise mitigation whilst at the same time allow desirable natural air ventilation for the habitable area of the flat. At the moment, we are still refining the design to meet other aspects like buildability and other balcony orientation with respect to road alignment. But this noise mitigation design feature is now being adopted in some of our housing projects with acute noise issue.

5. COLLABORATION WITH EPD AND OTHER STAKEHOLDERS

Over the years, we have been working in close collaboration with EPD and other stakeholders of expertise such as environmental consultants and tertiary educational institutes in the exploration of various innovative measures to mitigate noise impact to our public housing developments. During the research and development of Acoustic Window and Acoustic Balcony, EPD gave valuable advice on the knowledge and experience in similar research projects together with the regulatory requirements of noise control whereas the environmental consultants and tertiary educational institutes were capable of providing acoustic expertise in the investigation and testing. Experience indicates that collaboration approach with other stakeholders is essential and practicable to develop innovative measures for the benefit of the community.

6. CONCLUSION

The HKHA's mission is to implement the subsidized public housing programme in meeting the housing needs of those who cannot afford private housing in Hong Kong in support of the Government policy on housing. Yet land **has always been a precious and indispensable ingredient in HK's housing, economic and social development.** Owing to the limited land supply, we need to make the best use of every piece of land, optimise the development potential and provide as much as domestic flats as practicable within the shortest possible time. All the mitigation measures discussed above, enable us to build more in areas with undesirable noise environment, without compromising the environmental quality of housing estates.

Gaining from past experience, through the development of various innovative noise mitigation designs and measures, we have optimised the development potential of several difficult public housing sites, and holistically improved the environmental quality of these estates at the same time. Looking ahead, we will continue working closely through close collaborations among stakeholders in the academic institutes, regulatory authorities and construction industry to overcome these challenges.

REFERENCES

- [1] 'Hong Kong Planning Standards and Guidelines (HKPSG)' published by HKSAR. Retrieved from: http://www.pland.gov.hk/pland_en/tech_doc/hkpsg/full/index.htm
- [2] 'Noise Control Ordinance (Chapter 400)' published by HKSAR. Retrieved from: http://www.epd.gov.hk/epd/noise_education/web/ENG_EPD_HTML/m3/ordinance_7.html
- [3] Kan, J., Chan, I., Ng, I., Yeung, M., Tang, S. K. and Lo, P., 'Study of Noise Reduction Effect of Acoustic Balconies in High-rise Building', Proceedings of the 44th International Congress and Exposition on Noise Control Engineering, San Francisco, California, U.S.A., 9-12 August 2015.
- [4] KK Lau, Isaac Chan, Maurice Yeung, John Ho, Stephen Yim. 'Noise Planning in Public Housing Development in Hong Kong', paper presented at the 23rd International Congress on Sound & Vibration, Athens, Greece, 10-14 July 2016.
- [5] S.K. Tang, Y.G. Tong and others. 'On-site performance of ventilation windows for public housing development', paper presented at the Acoustics 2012, Hong Kong.
- [6] Yeung, M., Ng, I., Lan, J., Tang, S. K., Lo, D. and Yeung, D., 'Tackling Traffic Noise through Plenum Windows – An Application in Hong Kong', Proceedings of the 43rd International Congress and Exposition on Noise Control Engineering, Melbourne Australia, 16-19 November 2014.

Estimating Typhoon Haiyan's Wind Speeds Using Windicators and Post-Storm Wind Vulnerability Analysis on the Affected Areas

Joshua AGAR^a, Jaime Jr. HERNANDEZ^b

^a University of the Philippines Diliman, Philippines, jcagar@up.edu.ph

^b University of the Philippines Diliman, Philippines, jyhernandez@up.edu.ph

ABSTRACT

On November 2013, there was widespread devastation over the Visayan Region due to the onslaught brought by Typhoon Haiyan, which was hyped as the strongest landfalling cyclone. Despite of that, a new benchmark for future disaster preparations cannot be established due to the discrepancies between various weather bulletins on how strong Haiyan really was, as well as the loss of vital meteorological data during Haiyan's passage. To remedy the shortage and discrepancy of Typhoon Haiyan's meteorological data, a forensic structural analysis was done on windicators through a field survey done on Leyte and Samar Island. Windicators are structural objects of interest whose structural failure will lead to estimating the magnitude of the winds that brought the failure, in this case, the strength of Typhoon Haiyan, which in turn was used to determine and re-assess the wind vulnerability of the regions affected, using also the historical wind data from Tacloban and Guiuan station, comparing with that to the current design wind speeds prescribed by the NSCP. The study determines through the analysis of four windicators, that before its landfall at Leyte Island, Typhoon Haiyan has 1-minute sustained winds of 351 kph, 10-minute sustained winds of 290 kph, and through the analysis of the remaining surface data, which corresponded well into forming a model of the storm, Typhoon Haiyan, before its landfall at Guiuan, Eastern Samar, has 10-minute sustained winds of 317 kph and 1-minute sustained winds of 352 kph, with minimum central pressures of 868.5 mbar and 872.2 mbar at 4:10 am and 5:10 am respectively. Statistical analysis determined that the existence of a storm like Typhoon Haiyan, regardless whether it would make landfall has a minimum recurrence period of 500 years and the event that such storm makes landfall has a minimum recurrence period of 5600 years on the areas affected.

Keywords: windicators, typhoon haiyan; forensic structural analysis, computational fluid dynamics, wind engineering, geophysical fluid dynamics

1. INTRODUCTION

Last November 8, 2013, Super Typhoon Haiyan (PAGASA Designated Name: Yolanda) struck the Visayan Region leaving catastrophic damages and record fatalities along its path, most notably the Eastern Visayan Region where the storm made landfalls at its peak intensity.

The storm was immediately hyped as the strongest storm to make landfall. But amidst the devastation and misery upon those affected, they were in confusion on how strong Typhoon Haiyan really was, with Joint Typhoon Warning Center (JTWC) estimating the 1-minute sustained winds to be about 315 kph through the Advanced Dvorak Technique (ADT) and Japan Meteorological Agency (JMA) and Philippine Atmospheric, Geophysical and Astronomical Services Administration (PAGASA) estimating the 10-minute sustained winds to be about 235 kph using the Doppler effect estimations. Taking into account the differences in the time-base of the wind averaging, using the recommendations of World Meteorological Organization (WMO) on the conversion factors between 10-minute averages and 1-minute averages, there was still a 55-kph difference between these estimates.

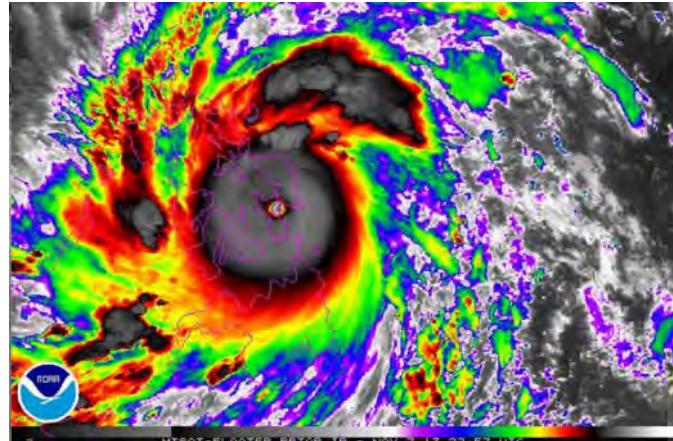

Figure 1: Infrared Image of Typhoon Haiyan

In-situ meteorological measurements were necessary to clear the discrepancy but unfortunately most of the weather instruments were damaged during the passage of TY Haiyan with only the barometric pressure readings from some areas remaining intact which were recorded during the full onslaught of Typhoon Haiyan at peak intensity namely: the 955.6 mbar barometric pressure reported at Tacloban Airport at 7:15 am, the 910 mbar barometric pressure reported at Guiuan Station at 5:10 am and the pressure readings from the barometer of the iCyclone team stationed in Hotel Alejandro in Tacloban City.

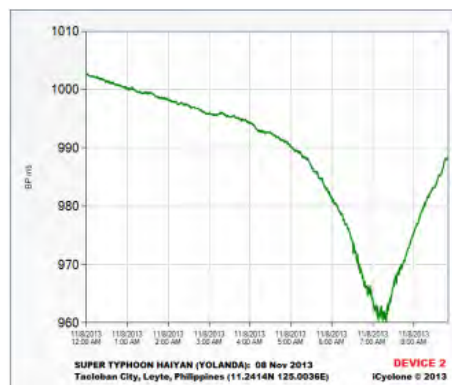

Figure 2: Barograph Reading on Tacloban City. A storm chaser team from iCyclone.com stationed at Hotel Alejandro in Tacloban City recorded the lowest pressure of 959.9 mbar at 7:20 am.

The flux of wind speed reading on weather stations was halted due to the fact that these stations were suffered physical damages from the winds of Typhoon Haiyan. Bantayan Island recorded winds of 77.4 m/s (278.6 kph) at 9:30 am (Nov 8, 2013, PST), which was recorded after Haiyan weakened considerably.

Tacloban Station, before being damaged by the storm surge, recorded winds of 77.7 m/s at 6:45 am. Guiuan Station, before halting its wind speed recording, recorded 10-minute sustained winds of 43 m/s (154.8 kph) peak winds of 53 m/s (190.8 kph) at 4:10 am, hours before its first landfall at Guiuan.

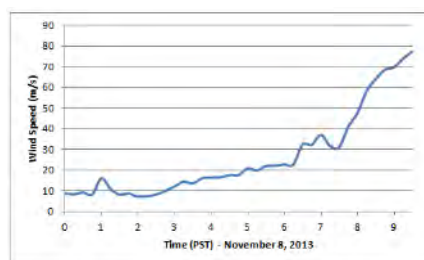

Figure 3: Wind Speed Reading – Bantayan Island

With these following premises given, a forensic structural analysis was performed to estimate the intensity of Typhoon Haiyan by the time it was making its landfalls to settle the discrepancy.

The forensic structural analysis performed on Windicators. Windicators, which were coined from terms ‘wind’ and ‘indicators’, are simple structural objects of interest whose failure leads to the computation of the wind speeds that brought the failure. Figure 5 shows the research framework using windicators.

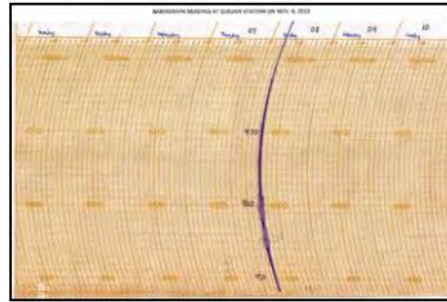

Figure 4: Barograph Reading – Guiuan Station (November 8, 2013). The lowest barometer reading of 910 mbar was recorded at 5:10 am. (Source: Climate Data Section - PAGASA and Guiuan Station Chief Marianito Macasa)

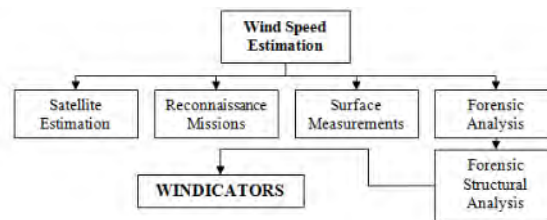

Figure 5: Conceptual Framework for Windicators

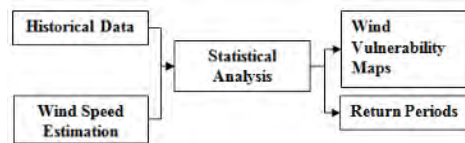

Figure 6: Research Framework

2. FORENSIC ANALYSIS

2.1 Field survey



Figure 7: Windicators (L to R: #4, #10, #9 and #8)

A field survey was performed on the affected areas. Non-inundated areas were surveyed to look for windicators. The area was further narrowed down to the area between Brgys. Guindapunan and San Jose in Palo, Leyte.



Figure 8: Windicators (L to R: #4, #10, #9 and #8) These were lamp posts installed in 2010 at Palo, Leyte. Windicator #9 was included in the study for verifications whether it was tampered or not.

The geographical coordinates, the geometric properties and samples trimmed from the structures were taken.

2.2 Material testing

The samples were taken back to the lab for material testing. Per ASTM A370-21419, a tensile test was performed on the samples.



Figure 9: Tensile test (right) on the sample (left)



Sample Picture	Coupon #1	Coupon #2
		
Gauge Length (in)	2.00	1.8125
Area (x 10 ⁻² m ²)	0.00616	0.00777
F _{ult} (lbs)	6560	6800
σ _{ult} (MPa)	473.71	389.29

Table 1: Tensile test results

Based on the ultimate strengths of the samples and referring to AISC Table 2-1, the material is determined to be A36 steel.

2.3 Computational fluid dynamics (CFD)

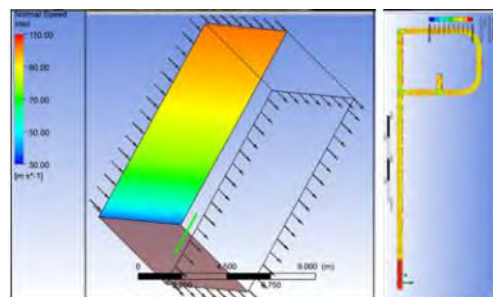

Figure 10: Wind simulation (left) and external pressures (right)

Using a finite-element modeler, winds were simulated over the structure following a logarithmic profile:

$$\bar{U}(z) = \bar{U}_{10} * \ln(z/z_0) * C_{SD}^{0.5} / 0.4$$

$\bar{U}(z)$ – average wind speed at height z

z_0 – roughness length [1]

C_{SD} – surface drag coefficient [1]

\bar{U}_{10} – average wind speed at height $z=10$ m

Equation 1

in order to obtain the external pressures applied on the structure using static wind load analysis. Using the external pressures caused by the wind, the internal forces in the member were determined. The von Mises stresses were used as the failure indicator, which was progressive yielding.

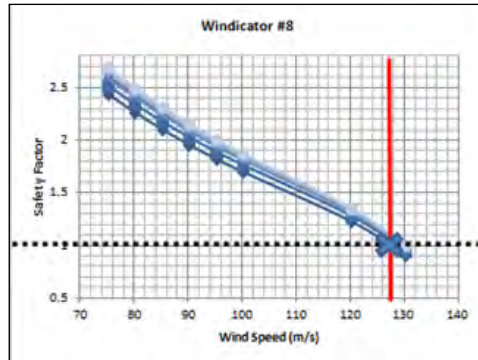

Figure 11: Wind speed v safety factor - #8

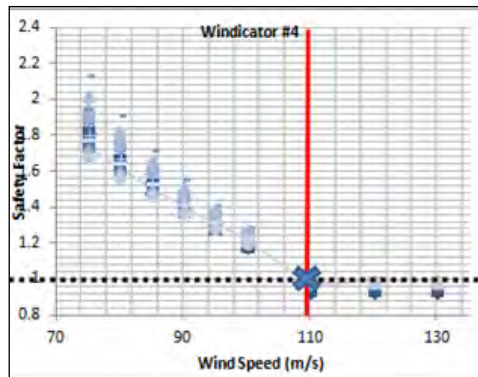

Figure 12: Wind speed v safety factor - #4

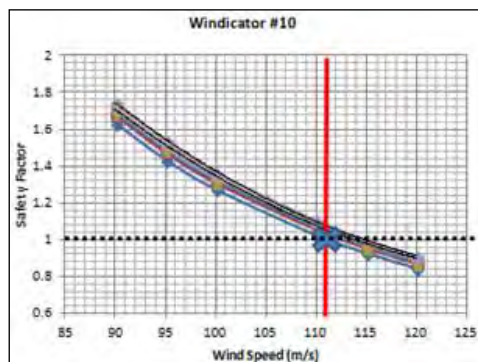

Figure 13: Wind speed v safety factor - #10

The terrain was considered a rough terrain ($z_0 = 0.5$ m and $C_{SD} = 0.019$) for the analysis. On Figures 11 to 14, the safety factor (Yield Stress/von Mises stress) on leeward elements and the wind speed were plotted. The winds simulated were considered to be a 3-second gust and therefore must be converted to 10-minute sustained averages using the conversion factors recommended by WMO. (Table 2)

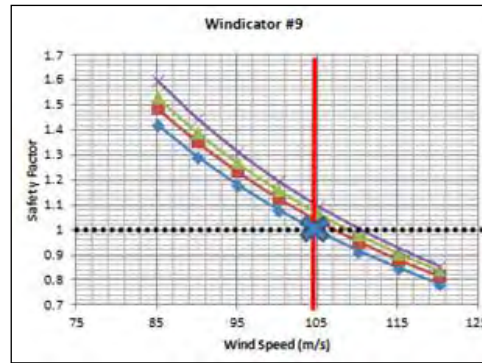

Figure 14: Wind speed v safety factor - #9

Windicator	Gust (m/s)	10-min sustained wind (m/s)
#4	109.48	65.95
#8	127.4	76.77
#9	104.77	63.11
#10	113.48	68.36

Table 2: Results of CFD analysis

2.4 Geophysical Fluid Dynamics

To determine the time of arrival of the winds, the direction of failure of the structures was estimated from the location of the compressive elements, which were considered to be on the leeward side of the winds, and the tensile **elements on the structure's cross-section**.

Next was to consider the effect of the Ekman Spiral, which is the change in direction of the winds as it descends from the boundary layer, where:

$$u(z) = U_{gr} * (1 - e^{-\beta} \cos(\beta))$$

Equation 2

$$v(z) = U_{gr} e^{-\beta} \sin(\beta)$$

Equation 3

$$\beta = z * (f / (2 * v_e))$$

u – magnitude of the wind tangential to the pressure isobars.

v – magnitude of the wind n to the pressure isobars.

f – Coriolis parameter

v_e – Eddy viscosity (constant on rotating bodies)

The height of the boundary layer (H_{abl}), which is dependent on the roughness length (z_0) and the Coriolis parameter (f), is determined by using (1) on the equation of Lettau (1959) :

$$H_{ABL} = e^{(2.5(fz_0^{-0.09}) + \ln(z_0))}$$

Equation 4

The height of the Ekman layer (H_{ekman}), which is dependent on the **roughness length and the Eddy viscosity (v_e)**, is determined by equating (3) to zero:

$$H_{ekman} = \pi * (2 * v_e / f)^{0.5}$$

Equation 5

Due to the circular geometry of Typhoon Haiyan, which had a Dvorak rating of T8.1, the gradient winds were assumed to be parallel to the pressure isobars. At 4:10 am in the morning, the direction of the gradient wind over Guiuan – Station was estimated to be N 42.08°E. The PAGASA Station recorded the direction of the surface wind at that time to be at N 30°E. Using the directional differences of the wind at that time and coinciding the Ekman layer to the Atmospheric Boundary Layer, the eddy viscosity (v_e) was computed to be equal to 0.719144 m²/s.

Typhoon Haiyan’s storm track was interpolated from 6-hour intervals into 1-minute intervals. Using the computed eddy viscosity, Equations (2), (3), (4) and (5), the time of failure was estimated based on the direction of failure and the windicators' location (Figure 14). With the time of failure being estimated the distance from the storm's center at the time of failure was estimated on each windicators.

Windicator	Gust (m/s)	10-min sustained wind (m/s)	Time of Failure	Distance from the storm's centre (km)
#4	109.43	65.95	7:50 AM	30.57
#8	127.4	76.77	6:41 AM	35.93
#9	104.77	63.11	7:20 AM	24.41
#10	113.48	68.36	7:02 AM*	27.31

Table 3: Time of failure and storm's proximity

2.5 Maximum Wind Speed Estimation

An analytical model of Typhoon Haiyan was formulated using the equations of Holland (1980) for the gradient wind profile and the pressure profile, the pressure (p) vs radial distance (r):

$$U_{gr} = -\frac{|fr|}{2} + \sqrt{\left(\frac{fr}{2}\right)^2 + \frac{(p - p_0)AB}{\rho_{air}r^B} \exp\left(\frac{-A}{r^B}\right)}$$

Equation 6

$$\frac{p - p_0}{p_n - p_0} = \exp\left(\frac{-A}{r^B}\right)$$

Equation 7

Using the pressure points discussed at section A and from Figure 2, and assuming the pressure on the outer edges of the storm to be at 1000 mbar based on the RDAP of the Haiyan from JTWC, on (7), the values of A and B were determined to be equal to 2445717313577890000 and 4.14868822191798 respectively. Using (6) to the data from Windicator #10 yielded a value of 68.39 m/s, relatively close to the 68.36 m/s 10-min sustained wind speeds on Windicator #10.

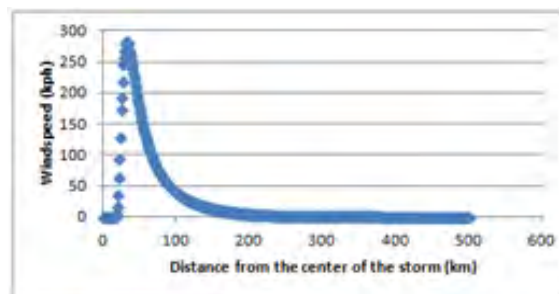

Figure 15: Velocity profile of TY haiyan (7:02 am)

Equation (6) was used not only to determine the maximum wind speeds and the minimum central pressure of Typhoon Haiyan at the time of failure of the windicators (Figure 13).

	#4	#8	#9	#10
Time of Failure (UTC)	2350	2241	2320	2302
10-minute sustained winds (kph)	239.6	290.81	371.82	281.67
1-minute sustained winds (kph)	289.91	351.87	449.90	340.83
Percent Deviation from JTWC(1-min)	8.65%	-10.48%	-	-7.58%
Percent Deviation from JMA/PAGASA(10-min)	19.17%	71.55%	-	23.57%
Minimum Central Pressure	922 mbar	888 mbar	500~mbar	895 mbar

Table 4: Summary of values

The data from Windicator #9 returned erroneous values from the model. Windicator #9, before the survey was conducted, was being used as an anchor to the residents' clothesline, therefore the direction of failure may be compromised thus causing errors on the comparison to the model.

Using the 910 mbar pressure reading on Guiuan station at 5:10 am on (7), the minimum central pressure of Typhoon Haiyan at that time was estimated to be equal to 872.2 mbar, corresponding to a 10-minute maximum sustained winds of 317 kph and 1-minute sustained winds of 352 kph. The 10-minute maximum sustained winds of 43 m/s and the peak gust of 53 m/s from the Guiuan Station taken at 4:00 am and 4:10 am respectively both returned 10-minute maximum sustained winds of 325 kph and 1-minute maximum sustained winds of 352 kph, corresponding to a minimum central pressure of 868.5 mbar, for Typhoon Haiyan.



Figure 16: Minimum central pressure vs time

The conversion of the 77.7 m/s data from Tacloban Station, which was located at an isthmus which account for a sea type exposure, at 6:45 am to 10-min sustained winds, and putting it to the analytical model returned 10-minute maximum sustained winds of 290 kph, almost the same as Windicator #8 which failed around the same time.

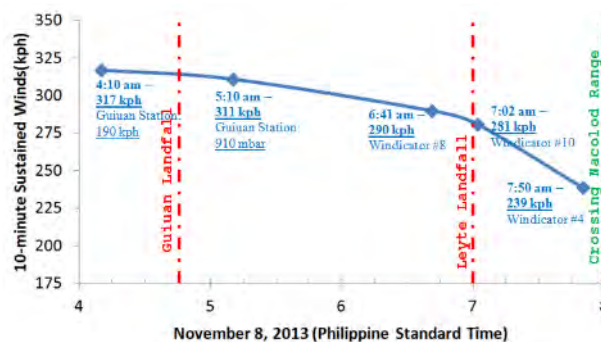

Figure 17: Maximum sustained winds vs time

Summing up the data on the timelines of Figure 16 and Figure 17 showed how Typhoon Haiyan drastically weakened over time. Terrain analysis reveals the limits of the analytical model which was valid until Typhoon

Haiyan crossed the Nacolod Range (a mountain range with 1000+ m mountains) of Leyte, causing disruption of the storm's structure as shown by the comparison of the analytical model and the synthesis of the data from Bantayan Island at Figure 18.

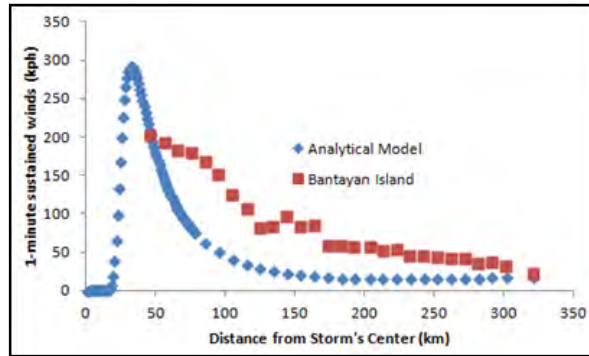

Figure 18: Bantayan island vs the analytical model

3. STATISTICAL ANALYSIS

The study analyzes the historical data from the PAGASA Synoptic Stations in the Visayan Region as shown in Figure 18 and Table 5.

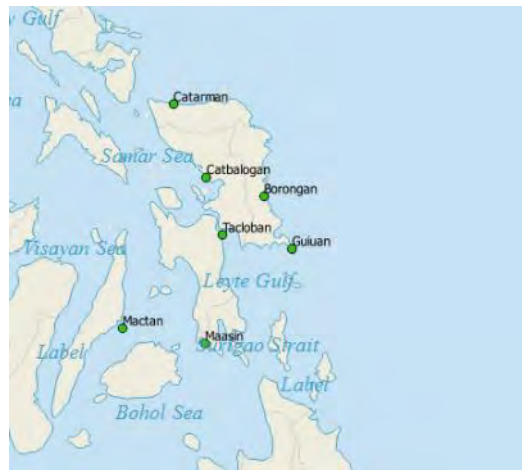

Figure 19: Location of the PAGASA stations analysed

STATION	PERIOD OF COVERAGE	HISTORICAL MAXIMUM WINDS
Borongan	1963-2010	52 m/s
Catarman	1951-2010	54 m/s
Catbalogan	1951-2010	59 m/s
Guiuan	1973-2012	72 m/s
Maasin	1972-2010	52 m/s
Mactan	1972-2010	55 m/s
Tacloban	1973-2012	62 m/s

Table 5: Details about the pagasa stations

Using the historical data, extreme value functions are formulated using the methods of Gumbel (Type I) and Gringorten (Type II) :

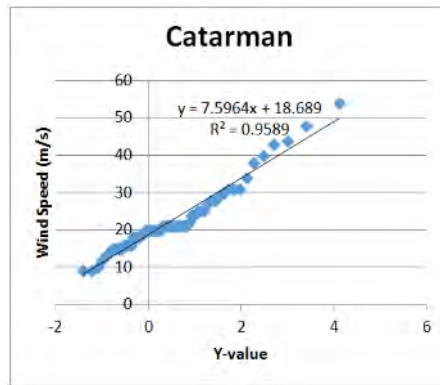

Figure 20: Type I distribution – Catarman

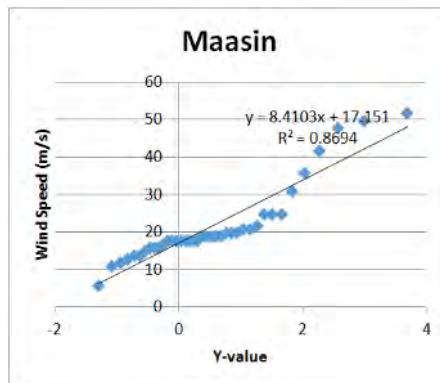

Figure 21: Type I distribution – Maasin

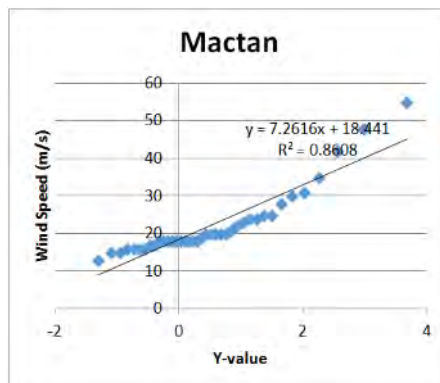

Figure 22: Type I distribution – Mactan

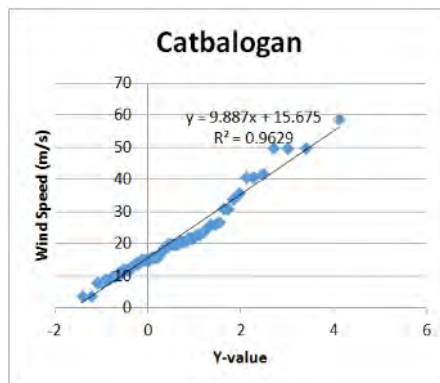

Figure 23: Type I distribution – Catbalogan

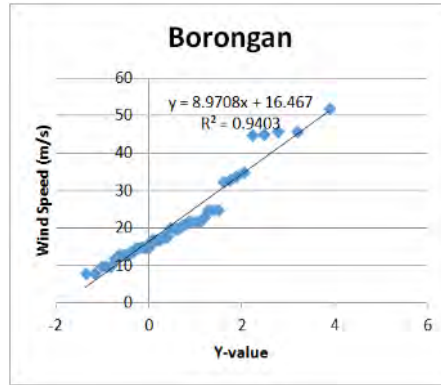

Figure 24: Type I distribution – Borongan

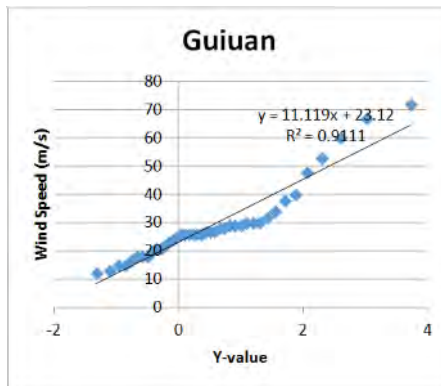

Figure 25: Type I distribution – Guiuan

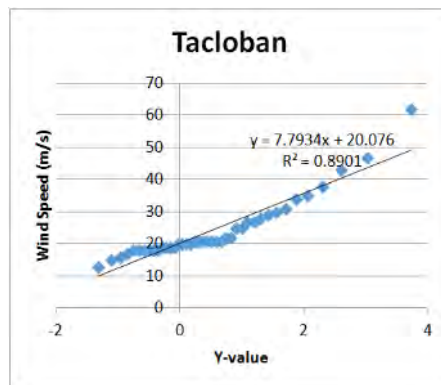

Figure 26: Type I distribution – Tacloban

Station	Daily Max			
	Type I		Type II	
	A	B	A	B
Mactan	18.44143	7.261625	18.52069	6.828771
Maasin	17.15099	8.410334	17.26715	7.865964
Catbalogan	15.6749	9.886965	15.80301	9.361444
Catarman	18.68947	7.596423	18.77932	7.207723
Borongan	16.46741	8.97078	16.60539	8.411409
Tacloban	20.07591	7.793412	20.1574	7.345179
Guiuan	23.11989	11.11882	23.26805	10.42299

Table 6: Shape values for the extreme value functions

Using the shape values for the extreme value functions on Table 6, the expected largest wind speed in the following return periods can be obtained as shown in Table 7.

EV	Return Period	Mactan	Maasin	Catbalogan	Catarman	Borongan	Tacloban
Type I	10	126.583	131.4594	138.3857216	130.2512	133.6442	136.8753
	25	150.5365	159.2021	170.9993254	155.3091	163.2357	162.583
	50	168.6567	180.1887	195.6705643	174.2647	185.6207	182.0301
	100	186.7768	201.1752	220.3418032	193.2202	208.0058	201.4772
	200	204.897	222.1618	245.0130421	212.1758	230.3908	220.9244
	500	228.8505	249.9045	277.6266459	237.2337	259.9823	246.6321
Type II	10	123.2803	127.3651	134.4907131	127.3526	129.5041	133.4531
	25	145.806	153.3122	165.3708088	151.1283	157.2504	157.6822
	50	162.846	172.9403	188.7306995	169.114	178.2397	176.0109
	100	179.886	192.5685	212.0905901	187.0996	199.2289	194.3395
	200	196.9261	212.1967	235.4504808	205.0852	220.2181	212.6682
	500	219.4518	238.1437	266.3305765	228.861	247.9644	236.8973

Table 7: Largest winds on the following return periods (in kph)

Using largest winds over the return periods of 10, 25, 50 and 100 years, basic wind speed maps are made :



Figure 27: Basic Wind Speed Map – 10-year return period (Values are in kph)

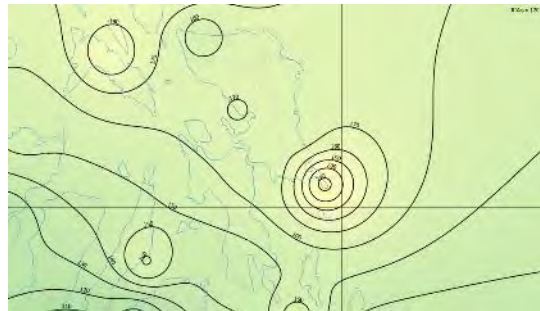

Figure 28: Basic Wind Speed Map – 25-year return period (Values are in kph)

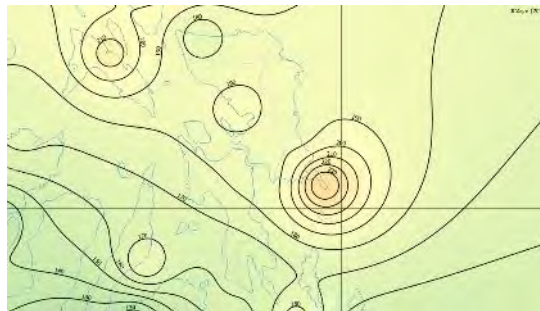

Figure 29: Basic Wind Speed Map – 50-year return period (Values are in kph)

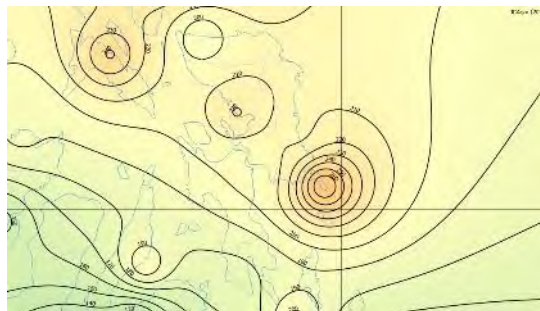

Figure 30: Basic Wind Speed Map – 100-year return period (Values are in kph)

The estimated and recorded wind speeds were also used to produce a wind exposure map brought by Typhoon Haiyan.

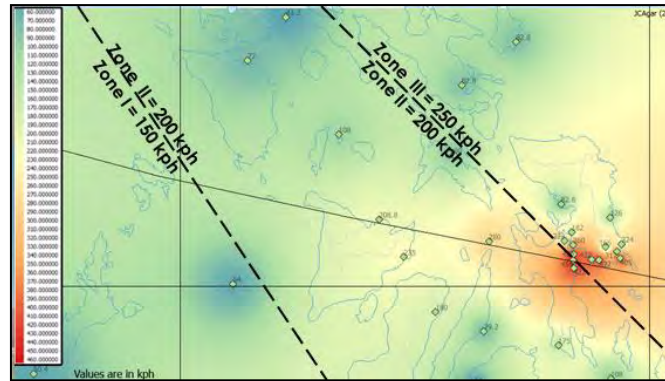

Figure 31: Wind Vulnerability Map of Typhoon Haiyan compared to the wind zones on NSCP (Values are in kph; Lower bound – 60 kph; higher bound – 460 kph)

Many of the areas had exceeded the basic design wind speed recommendations in the National Structural Code of the Philippines with the areas under Zone II experiencing gust more than 300 kph and areas under Zone I experiencing gust more than 400 kph, therefore, even engineered structures built in accordance to the NSCP were damaged.

Also using the values on Table 6, the return period of the winds experienced by Windicator #8 is obtained. Through the Type I extreme value functions, the 127 m/s winds experienced by Windicator #8 give return period values with the least being from the extreme value function from Guiuan Station which is approximately 5600 years. The return period is greater than the design life of the engineered structures.

Furthermore, using the least value expected for the highest pre-landfall wind speeds, highest wind speed recorded after the Leyte landfall in Bantayan Island, 77.4 m/s (278.6 kph), the return periods were computed to be at least 1650 years for Tacloban, and 140 years for Guiuan, also exceeding already the prescribed design life for engineered structures on the areas affected.

In terms of typhoon strengths, a statistical analysis was also done on the historical data of typhoon strength using the data from Japan Meteorological Agency, spanning from 1977-2014, excluding Typhoon Haiyan.

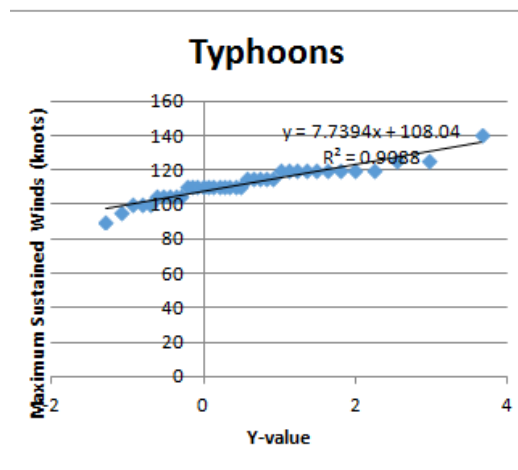

Figure 32: Type I analysis (Gumbel)

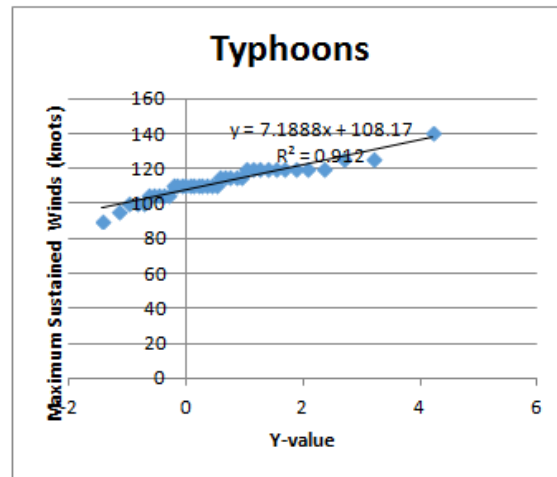

Figure 33: Type II analysis (Gringorten)

4. CONCLUSION

The study concludes that Typhoon Haiyan, before its landfall at Guiuan, has 10-minute sustained winds of 317 kph and 1-minute sustained winds of 352 kph. At its landfall at Leyte, Typhoon Haiyan has 10-minute sustained winds of 290 kph and 1-minute sustained winds of 351 kph. The minimum central pressures were determined to be 872.2 mbar at 5:10 am and 868.5 mbar at 4:10 am.

The wind vulnerability map during the passage of Typhoon Haiyan revealed that the current wind design specifications were not enough to prevent damage to structures.

Using statistical analysis over the historical data of Typhoon strengths and using the maximum sustained winds estimated in the forensic analysis, the existence of storms with the same intensity, whether it will hit land or not, on the Northwestern Pacific Basin as Typhoon Haiyan was analyzed to have a return period of 500 years.

Using statistical analysis over the historical data on weather stations in the Visayan Region, the winds brought by Typhoon Haiyan has a return period of possibly more than 5600 years over the affected areas.

REFERENCES

- [1] Y. OKUDA, H. KIKITSU, H. OKADA, M. MATSUI, Y. TAMURA, M. TSUCHIYA, M. YAMAMOTO, K. HAYASHIDA and K. KONDO, 'High Wind Damages in Miyako Islands under Typhoon Maemi (2003)', Wind Engineers, JAWE, vol. 2003, no. 97, pp. 49-60, 2003.
- [2] H. KIKITSU, K. FUJII and Y. WAKIYAMA, 'High Wind Damages in Hachijo Island under Typhoon 15th, 2003', Wind Engineers, JAWE, vol. 2004, no. 98, pp. 55-64, 2004.
- [3] J. Morgerman, 'Super Typhoon HAIYAN in Tacloban City & Leyte, Philippines', iCyclone.com, vol. 1, no. 1, 2015.
- [4] J. Masters, 'Haiyan's True Intensity and Death Toll Still Unknown | Dr. Jeff Masters' WunderBlog', Wunderground.com, 2015. [Online]. Available: <http://www.wunderground.com/blog/JeffMasters/comment.html?entrynum=2580>. [Accessed: 10- Nov- 2015].
- [5] Upload.wikimedia.org, 2015. [Online]. Available: https://upload.wikimedia.org/wikipedia/commons/2/2f/Typhoon_Haiyan_2013_making_landfall.gif. [Accessed: 10- Nov- 2015].
- [6] B. Cushman-Roisin and J. Beckers, Introduction to geophysical fluid dynamics. Waltham, MA: Academic Press, 2011.
- [7] C. Dyrbye and S. Hansen, Wind loads on structures. Chichester: J. Wiley, 1997.
- [8] T. Olander and C. Velden, 'The Advanced Dvorak Technique: Continued Development of an Objective Scheme to Estimate Tropical Cyclone Intensity Using Geostationary Infrared Satellite Imagery', Wea. Forecasting, vol. 22, no. 2, pp. 287-298, 2007.
- [9] V. Dvorak, 'Tropical cyclone intensity analysis using satellite data', 1984.

- [10] C. Risien and D. Chelton, 'A Global Climatology of Surface Wind and Wind Stress Fields from Eight Years of QuikSCAT Scatterometer Data', *J. Phys. Oceanogr.*, vol. 38, no. 11, pp. 2379-2413, 2008.
- [11] B. Harper, J. Kepert and J. Ginger, 'Guidelines for converting between various wind averaging periods in tropical cyclone conditions', World Meteorological Organization, p. 1555, 2010.
- [12] J. Holmes, *Wind Loading of Structures*, 2nd ed. Hoboken: Taylor & Francis Ltd. Methodological Peace, 2007.
- [13] Z. Zhang, J. Li and P. Zhuge, 'Failure Analysis of Large-Scale Wind Power Structure under Simulated Typhoon', *Mathematical Problems in Engineering*, vol. 2014, pp. 1-10, 2014.
- [14] G. Holland, 'An Analytic Model of the Wind and Pressure Profiles in Hurricanes', *Mon. Wea. Rev.*, vol. 108, no. 8, pp. 1212-1218, 1980.90(12-15), pp.1555-1568.
- [15] T. Fujii, J. Maeda, N. Ishida and T. Hayashi, 'An analysis of a pressure pattern in severe Typhoon Bart hitting the Japanese Islands in 1999 and a comparison of the gradient wind with the observed surface wind', *Journal of Wind Engineering and Industrial Aerodynamics*, vol. 90, no. 12-15, pp. 1555-1568, 2002.
- [16] C. Yoo and S. Lee, *Stability of structures*. Amsterdam: Butterworth-Heinemann, 2011.
- [17] B. Brookes and E. Gumbel, "Statistical Theory of Extreme Values and Some Practical Applications", *The Mathematical Gazette*, vol. 39, no. 330, p. 341, 1955.
- [18] I. Gringorten, "A plotting rule for extreme probability paper", *J. Geophys. Res.*, vol. 68, no. 3, pp. 813-814, 1963.
- [19] N. Lakshmanan, S. Gomathinayagam, P. Harikrishna, A. Abraham and S. Chitra Ganapathi, "Basic wind speed map of India with long-term hourly wind data", *CURRENT SCIENCE*, vol. 96, no. 7, 2009.
- [20] National structural code of the Philippines. [Manila?]: ASEP, 2010.
- [21] **J. Agar, J. Hernandez and W. Mata**, "Estimating Typhoon Haiyan's Wind Speeds Using Windicators", Undergraduate Thesis, 2015

Outdoor Lighting Quality and Glare Rating Evaluation of Night-Time Community Parks

KUO Poyen^a, CHEN Yishan^b

^aChaoyang University of Technology, Taiwan, kuoben@gmail.com

^bChaoyang University of Technology, Taiwan, shan800217@gmail.com

ABSTRACT

There are many community parks use the improper lighting creates light pollution. The study aims to address the issue of glare reduction for outdoor lighting as well as to encourage the installation of lighting with fitting design and style. These eight community parks located in Taichung City were selected for the study, the information collected on-site allows for an analysis of the lighting quality at night-time community parks.

The present absence of proper light shade lead to the problems of glare, uneven illumination and excessive brilliance. An analysis based on the field data reports that all community parks share similar background luminance. In terms of glare rating, Taichung Wen-Hsin Park has the highest outdoor glare rating at 53.56 for the area along the walking trail adjacent to the in-park facilities. The average illumination on the ground of walking trails in some parks are two to four times more intense than the regulation standard because the lighting installations are not properly shaded, and the distance interval between the street lamps are overly concentrated. In terms of brilliance, Taichung Park and Wen-Hsin Park has the highest brilliance index at 1.5 times in excess of the regulation standard. The high brilliance is a sign of excessive spill light, frequently leading to glare. Finally, use the DIALux, a lighting design program, is used to simulate lighting along the trail with various lighting conditions and types of installations.

Light shades are recommended to reduce brilliance so the park users do not feel harsh on the eyes. For those areas with insufficient illumination, direct lighting is recommended to enhance illumination to the ground. For the types of installations, direct and indirect lighting installations are recommended to create a properly-lit night-time environment and prevent light pollution.

Keywords: sustainable neighbourhood, community park, glare rating, background luminance

1. RESEARCH ORIGIN AND PURPOSES

The light hazard, like noise or air pollution, can cause adverse effect on physiology and ecology, so it is also known as "light pollution". The trails in the community parks in Taiwan are universally provided with excessive lamps, but the light environment quality is poor, resulting in glare, ecological disturbance and energy waste. At present, the evaluation of light environment quality is still neglected in the selection and setup of park trail lamps in Taiwan, this study is expected to provide reference for the future planning of park trail lamps.

- The night-time light environment quality of community parks is measured, so as to know the community park lighting design quality in Taiwan.
- The night illumination problem in Taiwan's community parks is analyzed, the improvement method and lamp selection strategy are proposed.
- The lighting evaluation software DIALux is used to simulate the effect of the lamps of different specifications and setup modes for park trails on the light environment quality and glare index of park trails, to provide reference for the future park lighting design.

2. LIGHT ENVIRONMENT QUALITY ASSESSMENT METHOD

2.1 Outdoor lighting glare rating evaluation

The outdoor glare discomforts the user's eyes and increases the danger. The glare evaluation is to establish the glare rating for different lighting occasions, for example, the unified glare rating (UGR) assessment method is applicable to indoor lighting environment; whereas the park lighting is of outdoor lighting, in order to know the lamp glare rating in the community parks in Taichung City, the outdoor glare rating (GR) is used for assessment. According to the International Commission on Illumination CIE 112-1994, the GR represents the glare level, the

GR lower than 50 means the glare is acceptable, that higher than 50 means the glare is unacceptable. Therefore, the lower the glare rating is, the lower is the glare degree, unlikely to discomfort vision (Table 1).

GR	Glare degree	GR	Glare degree	GR	Glare degree
90	Severely glaring	60	Disturbing	30	Slightly sensible
80	Intolerable	50	Slight discomfort	20	Noticeable
70	Glaring	40	Acceptable	10	Unnoticeable

Table 1: Glare rating evaluation relationships (CIE 112-1994)

2.2 Outdoor illumination evaluation

The illumination is most frequently used to evaluate the outdoor lighting environment, for evaluating the brightness in different places, so as to meet the optimal activity requirement. As the light source type, pattern and spacing of lamps can influence the pavement illumination, the "illumination meter" is used to measure the illumination of trails in various community parks, and the illumination in the parks is evaluated according to CNS15015 outdoor landscape lighting lamp specifications to check whether it is proper or not (Table 2).

Object of lighting	Average illumination (lux)	Illumination standard (lux)
Trail	5	1~10
Passageways	3	1~10
Recreation trail	3	1~10

Table 2: Illumination standard for various zones in outdoor space (CNS 15115)

2.3 Outdoor lighting brightness evaluation

The brightness is the brightness degree of the light source or the illuminated surface perceived by human eye, its unit is [cd/m²]. The brightness depends on the area of the illuminated surface and the intensity of light reflected from the illuminated surface to the naked eye. A good brightness is closely related to the lamp cut-off design. This study uses "brightness meter" to measure the brightness of lighting fixtures in various community parks, and evaluates the lamp brightness in the parks according to IS Z 9111 road lighting standard. The brightness of trail lighting fixtures is supposed not to exceed 6,000 [cd/m²], the brightness at the visual center can be reduced, so as to avoid discomforting the pedestrians.

3. FIELD MEASUREMENT OF LIGHT ENVIRONMENT QUALITY

As the community park is the minimum park for recreational activity and social gathering, this study takes eight 4~20 ha community parks in service radius of 1.5km in "Taichung City" in central Taiwan as the subjects investigated (Table 3). There are three types of arrangement of the lamps in the parks, unilateral arrangement, bilaterally opposite arrangement and bilaterally staggered arrangement (Table 4). The trail width, lamp type and setup spacing are investigated, and the trails frequently used by common people are taken as analytes. The "image color analyzer, illuminance meter and brightness meter" are used to measure the lamp glare, pavement illumination and lamp brightness data in parks at night, so as to know current park trail lamp setup situation and quality of lighting, contributing to proposing the way of improvement in the future.

Code	Parks Name (Brief Name)	Construction Year	Area [ha]	Measured Zone
A	Bei-Tun Park (BT Park)	1983	4.6	4
B	Jiu-She Park (JS Park)	1994	4	5
C	Chong-Zheng Park (CZ Park)	1975	7.3	4
D	Taichung Park (TA Park)	1977	10.5	5
E	Museum of Art's Park (MU Park)	1982	10.1	4
F	Wen-Sin Park (WS Park)	2006	7.6	6
G	Chong-Lun Park (CL Park)	1990	6.2	3
H	JianKang Park (JK Park)	1991	5.6	4

Table 3: Community park sample data

Unilateral arrangement	Bilaterally opposite arrangement	Bilaterally staggered arrangement
------------------------	----------------------------------	-----------------------------------



Table 4: Arrangement modes of park road lamps

3.1 Glare rating measurement method and result

In order to measure the glare quality received by the eyes when the pedestrian is walking on the trail, the "DIC image color analyzer (laboratory corrected lens and single lens camera)" is used to take two digital images in front of and behind the measuring point, the images are imported into the DIC analysis program to calculate the average glare rating at the measuring point. As the glare rating is influenced by the lamp brightness and environmental background brightness, but if the difference in background brightness is slight, in unilateral arrangement, bilaterally opposite or bilaterally staggered arrangement of lamps, the glare rating does not vary too much with the arrangement mode, it is mainly influenced by the lamp pattern. For the spot-light well controlled lamps, for example, CZ Park-C Zone keeps the glare rating at 23.92. Only the maximum and minimum results of glare rating in different lamp arrangement modes are listed (Table 5).













Arrangement modes	Park/ Zone	Trail width	Lamp form	Light distribution curve type	GR	Lb
Unilateral arrangement	WS Park C Zone	2			53.56 (Max)	1.47
	CZ Park C Zone	3			23.92 (Min)	1.59
Bilaterally opposite arrangement	BT Park C Zone	9.6			45.07 (Max)	1.85
	WS Park D Zone	5			30.17 (Min)	1.69
Bilaterally staggered arrangement	BT Park B Zone	4.6			50.06 (Max)	1.79
	JS Park E Zone	4			40.62 (Min)	0.51

Table 5: Relationship between community park trail lamps and glare rating

3.2 Illumination measurement method and result

The horizontal illumination of trails is measured by using high precision illumination meter. In this experiment, five measuring points are arranged between two lamps on average, and a train of measuring points is taken along the center line of the trail in width less than 3M; there are two rows of measuring points on the trail in width of 3-10M; there are three rows of measuring points on the trail in width greater than 10M. According to the field measurement, the average illumination value of most of the present trails can reach the minimum illumination 5[lx] required by CNS15015, but the illumination of 21-38 [lx] is too wasteful. A few zones below 5[lx] are related to the trail width, lamp spacing and tree shading. Sparse lamps and trail width will result in insufficient illumination of trail. Only the maximum and minimum results of illumination in different lamp arrangement modes are listed (Table 6).













Arrangement modes	Park/ Zone	Trail width	Lamp form	Light distribution curve type	Lux
Unilateral arrangement	MU Park C Zone	2			38.18 (Max)
	MU Park B Zone	3			0.47 (Min)
Bilaterally opposite arrangement	WS Park D Zone	5			29.94 (Max)
	BT Park C Zone	9.6			20.20 (Min)
Bilaterally staggered arrangement	BT Park B Zone	4.6			21.24 (Max)
	JS Park A Zone	3.4			4.01 (Min)

Table 6: Relationship between community park trail lamps and illumination

3.3 Brightness measurement method and result

According to CNS 5064, the brightness meter is mounted at the measuring point at 1.5m above the ground, at vertical included angle of 85° to the observed lamp light source to measure the lamp brightness value. If the lampshade is transparent, unable to resist the horizontal projection effectively, there will be high brightness value. The lamp brightness situation in the parks is evaluated according to JIS Z9111 road lighting standard, the brightness of lighting fixtures for trails should not exceed 6,000 [cd/m²]. However, it is found in this survey that if the projecting angle of the lamps for park trails is improper, the brightness is 7500~9200 [cd/m²] which is likely to cause discomfort. Only the maximum and minimum results of brightness value in different lamp arrangement modes are listed (Table 7).









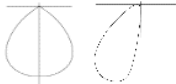

Arrangement modes	Park/ Zone	Trail width	Lamp form	Light distribution curve type	Brightness
Unilateral arrangement	WS Park B Zone	6			8854 (Max)
	CZ Park C Zone	3			1413 (Min)
Bilaterally opposite arrangement	BT Park C Zone	9.6			7567 (Max)
	WS Park D Zone	5			3422 (Min)
Bilaterally staggered arrangement	WS Park A Zone	6			9221 (Max)
	TA Park D Zone	15			1937 (Min)

Table 7: Relationship between community park trail lamps and brightness

4. SIMULATION OF CONFIGURATION OF PARK ROAD LAMPS

4.1 Lighting simulation mode

Due to the limitations of the measured objects, the lighting situation of all park trails cannot be obtained, the quality of lighting in different cases can be known by computer program simulation. This study uses DIALux software for lighting simulation, which is a lighting design software developed by Germany lamp manufacturer DIAL. It has been approved by many lamp manufacturers and lighting designers in the world. The lamp data files provided by lamp manufacturers are installed in the software for simulation. According to current condition of trail lighting, the light distribution curves of lamps in Taiwan's community parks are divided into five classes, and 135 lighting combination modes are studied out according to the road width, lamp spacing and lamp arrangement mode (Table 8), the quality of lighting of park trails is calculated one by one as reference for the selection and arrangement mode of park trail lamps in the future.





Simulated item	Simulation type	Description	
Lamp type	A Type: Direct	A Type 3200 (lm)2800 (k)	
	B Type: Semi-direct	B Type 1200 (lm) 3000 (k)	
	C Type: Perfect diffusion	C Type 950 (lm) 3200 (k)	
	D Type: Semi-indirect	D Type 1800 (lm) 3500 (k)	
	E Type: Indirect	E Type 1497 (lm) 4000 (k)	
Trail width	3m, 5m, 10m	The park trails in width of 3m~10m and over 10m are main passageways.	
Lamp spacing	10m, 15m, 20m	The three spacings are the major road lamp spacings	
Lamp arrangement mode	- Unilateral arrangement - bilaterally opposite arrangement - bilaterally staggered arrangement	The three modes are the major road lamp arrangement modes	
Simulation combinations:5 lamp types, 3 trail widths, 3 lamp spacings, 3 arrangement modes=5*3*3*3=135 simulation combinations			

Table 8: Park road lamps simulation conditions

4.2 Analysis of park road lamps lighting simulation results

Road lamp type-based comparison

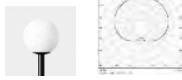
- Semi-direct lamp: 27 situations of this type of lamp are simulated, the trail width or lamp arrangement mode results in glare rating of 51~69, which is an uncomfortable glaring environment.
- Direct lamp: Whatever the trail width or lamp arrangement mode is, the glare rating is about 50, mostly acceptable (Figure 1). When the trail width is 3m and the lamp spacing is greater than 20m, the illumination is 2.1~4.4 [lx]. When the trail width is 5m and the lamp spacing is greater than 15m, the illumination is 1.5~3.9 [lx]. When the trail width is 10m and the lamp spacing is greater than 10m, the illumination is 0.7~3.3 [lx].

- Perfect diffusion and semi-indirect lamps: In whatever configuration mode, the glare rating of the two types of lamps is 51~61, which is likely to cause uncomfortable glare. The illumination of this type of lamp varies with the light source capacity. The types selected for this study generate low illumination of 0.63~4.6 [lx].
- Indirect lamp: Whatever the trail width or lamp arrangement mode is, the glare rating is acceptable 36~49, the pavement illumination is quite high, almost higher than 5[lx] (Figure 2).

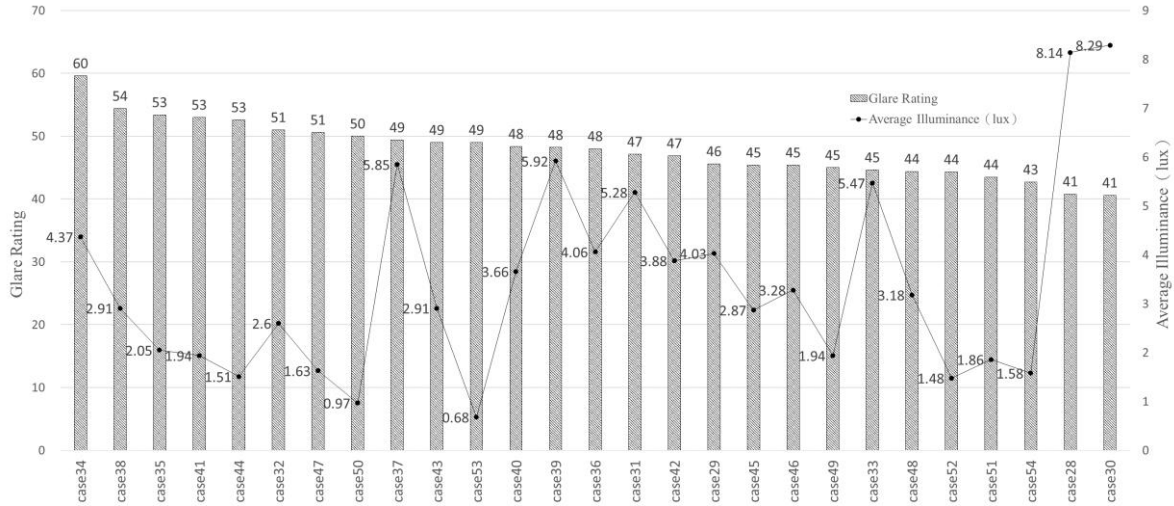

Figure 1: Semi-direct lamp simulation results

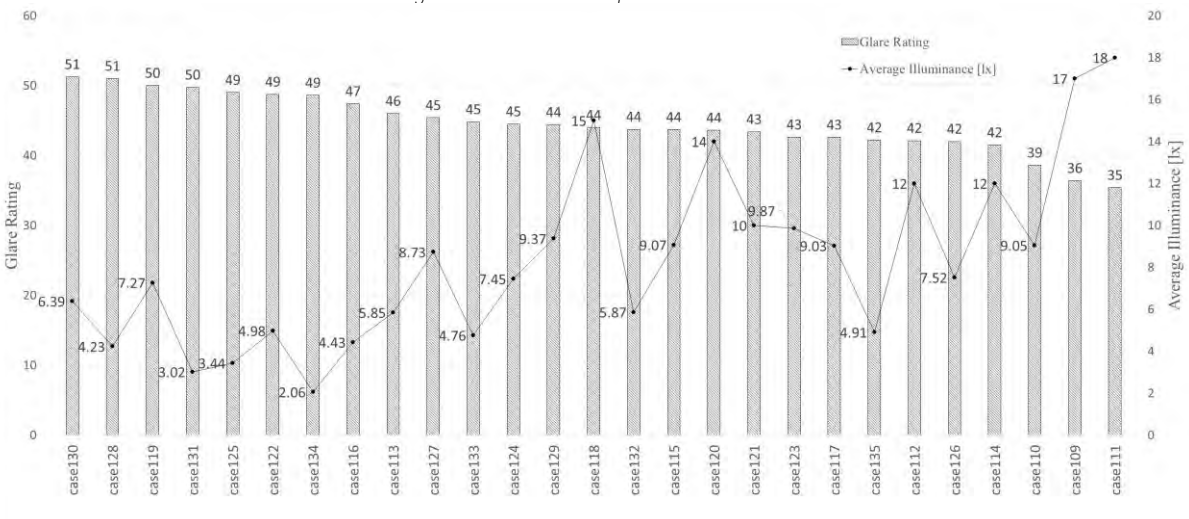

Figure 2: Indirect lamp simulation results

Park trail width-based comparison

- In terms of trail width 3m, the recommended lamp spacing is 15m, and the direct lamps are used for bilaterally staggered arrangement and bilaterally opposite arrangement.
- In terms of trail width 5m, the recommended lamp spacing is 10m, and the direct lamps are used for bilaterally staggered arrangement and bilaterally opposite arrangement.
- In terms of trail width 10m, the recommended lamp spacing is 10m, the direct lamps are used for bilaterally staggered arrangement and bilaterally opposite arrangement, but the pavement illumination is likely to be insufficient, the lamp spacing shall be shortened.

5. CONCLUSION

- A few lamps in the community parks have high brightness and glare problems. The glare level of most lamps in the eight community parks investigated by this study is acceptable. In unilateral arrangement, bilaterally opposite or bilaterally staggered arrangement of lamps, the glare rating does not vary too much with the arrangement mode. The lampshades are transparent in a few zones, which cannot shield light source effectively, so the brightness is relatively high, generating uncomfortable glare.
- The trail illumination is sufficient but relatively high: The average pavement illumination is related to the lamp setup density, the average illumination value of the trails in current community parks is higher than 5[lx], conforming to CNS 15015, but generally speaking, the illumination of 21~38[lx] is too wasteful. Although it is required to avoid too long lamp spacing causing insufficient average illumination, the excessive illumination and energy waste resulted from short spacing shall be noticed.
- The glare rating of park trails using direct or indirect lamps is relatively ideal: This study simulates 135 lighting combinations according to common lighting conditions of the parks in Taiwan, the findings show that when the "direct lamp" or "indirect lamp" is used, whatever the trail width or lamp arrangement mode is, the glare rating is 50 and 36-49 respectively, which is acceptable.

The setup of park trail lamps shall be evaluated carefully, in order to provide an appropriate park lighting environment, the lamps shall refer to the light distribution curve at the design stage, selecting the types which can prevent light rays from dissipating effectively can reduce visual and ecological impacts.

REFERENCES

- [1] J. D. Bullough, J. A. Brons, R. Qi, and M. S. Rea, 2008, Predicting discomfort glare from outdoor lighting installations, *Lighting Research and Technology*, Vol.40, No.3, pp.225-242.
- [2] Lin, H. T., 2008, *The Study of Preventions and Solutions for Light Pollution in Public Outdoor Lighting*. Report of National Science Council. Taipei, National Science Council, Executive Yuan.
- [3] Lin, H. T., Chao, Y. C., & Huang, K. Y., 2010, Light trespass from road lighting in residential areas in Tainan City. *Journal of Architecture*, (72), 101-116.

Better Places for People: Health and Wellbeing Measurement Methods in Workplaces

Maíra DE MACEDO^a, Eleonora ZIONI^b, José Eduardo MODICA^c

^a Green Building Council Brazil, Brazil, mairamacedo@gbcbrasil.org.br

^b Asclépio Consultoria, Brazil, eleonora@asclapioconsultoria.com.br

^c Petróleo Brasileiro S/A - PETROBRAS, Brazil, eduardomodica@gmail.com

ABSTRACT

Considering we spend about 90% of our time in built environments, it is crucial to understand how buildings have an enormous impact on the health and well-being of its occupants. Regarding the workplace, studies demonstrate that indoor air quality and ventilation, thermal comfort, noise and acoustics, daylighting and lighting, interior layout and active design, views and biophilia, look and feel, location and access to amenities, may have a significant influence on the employee's productivity. Such concerns, particularly in large business offices, have already led to considerable investments thus creating a new market with new business opportunities.

Although the scientific community is yet to agree upon consolidated wellbeing metrics and measuring methods, a few alternatives have presented themselves with promising results. Among them, the Green Building Council's Brazil (a nongovernmental organization founded in 2007) in partnership with IPT (Instituto de Pesquisas Tecnológicas – Technological Research Institute), indicates a path by applying the perceptual and physical metrics, based on the report about Health, Wellbeing and Productivity developed by the World Green Building Council (WGBC).

Throughout this session, the authors aim to present the results of the Survey conducted with the occupants of office buildings in Brazil. In order to obtain the perceptive metric, an online questionnaire was applied on LEED CI (commercial interiors) certified buildings, collecting about 300 answers anonymously, considering the topics: indoor air quality and ventilation, thermal comfort, acoustics, lighting, layout and ergonomics, biophilia and views, look and feel, location, transportation and access to amenities. Regarding the physical metrics, the survey demonstrates measurements of illuminance in the workplace, measurements of the acoustic quality of both internal and external noise, and temperature measurements of air, mean radiant, humidity and air velocity. From the gathered data, important evidence of the relationship between the subjective wellbeing and physical concepts are brought to light.

Keywords: green building, wellbeing, acoustic

1. INTRODUCTION

In 1987 during an United Nation Organization meeting, Brundtland commission has defined sustainable development as: **'Satisfy present needs, without compromising capacity for future generations to satisfy their own needs.'** The green movement and assessment science has begun during the beginning of ninetys all over the world. (Marcovitch, 2012). ISO 14000 regulations were created from Agenda 21 decisions during the United Nations international congress for the environment and sustainable development, known as ECO 92. The concern about the sustainability in buildings and the built environment had an advance when the United States Green Building Council USGBC was founded in 1993. The Green Building Council Brasil, GBC Brasil, has been founded just in 2007.

The sustainability concept is based on the equilibrium of three spheres, or the triple bottom line: Planet, People and Profit, known as the 3 P! Basically, all assessment tools were created also based in three contents: Structure, Process and Results. Structure is related to the physical area, space, form, function, installations and maintenance. (Sommer, 1969) Process is consisted on an evaluation of all data, records, orders, protocols and indicators. Results can be assessed comparatively as financial results, costs per unit and productivity. Total quality management and continuous quality improvement are examples. LEAN and Six Sigma are also assessment methods focusing on reducing waste in all building sectors, from industrial to healthcare.

Nowadays there are many sustainable certification systems in Brazil, like: Leadership in Energy and Environmental Design LEED the American model, AQUA- HQE based on a French model, 'Procel Edifica', 'Selo Caixa Azul', both Brazilian systems: besides international systems: the American Living Building Challenge LBC, the German system DGNB, the British system BREEAM, the Japanese system called CASBEE and others. The tendency is that all these quality tools are going to be more challenging, not only to reduce the impact on the planet, but also to be restorative, like the Restorative Design.

It is inevitable to compare the 3P with the health, wellbeing and productivity. Health is inside the Planet and environment, wellbeing is part of the People, the social sphere and productivity is related to Profit. (Wolff, 2013) According to World GBC report, we spend about 90% of our life time in built environments. These built environments should be healthy and collaborate to increase our wellbeing. Handful of organizations and researchers are already using surveys to quantify a range of concepts which had previously been extremely difficult to measure, like The Gallup Workplace Audit, The Leesman Index, Building Use Studies (BUS) Methodology and CBE Berkeley.

Company owners and directors think that sustainable buildings just save water and energy that contribute to 10% of the business operating costs. Although staff costs, including salaries and benefits typically account for about 80 or 90% of business operating costs. It is the value equation, not cost savings, that has driven the business case for energy improvements and green building certification in many markets and there is every reason to think that may begin to happen with health, wellbeing and productivity as well. Green buildings should focus on people and human beings, because human resources are the most important assets.

It is difficult to measure health and wellbeing because is subjective and personal. That is the reason this research focus on Brazilian culture and the way their offices function. The study evaluated real cases, close to Brazilian people and their satisfaction with the workplaces. (Preiser and Vischer, 2008) The survey included physical and perceptual metrics and not financial metrics.

2. METHODOLOGY

The research was conducted for occupants of seven LEED (Leadership in Energy and Environmental Design) certified offices under the CI category (Commercial Interiors), located in São Paulo city, in Brazil. An online questionnaire was applied via web, accessed by independent links by building. The link was sent by to each **company's manager, HR or facilities representative, who was responsible for distributing to the office's occupants.** It took approximately 15 minutes to them to complete the survey.

The development of the questionnaire was based on research literature and discussions with professionals who conducted similar studies, including the reputed IPT (Institute for Technological Research), Skanska England (one **of the world's largest construction groups**), Los Andes University and GBC Colombia. **ISO and ASHRAE standards** were used for the preparation of the questions and qualitative Likert's scale were rather used for the answers choices.

The goal of the questionnaire was to collect anonymously occupant's importance and satisfaction regarding the built factors of the building and workplace, such as: indoor air quality and ventilation, thermal comfort, natural daylight and lighting, acoustics quality, interior layout and ergonomics, green areas and views, aspect and perception, location, transportation and access to amenities. Personal data such as gender, age, work regime, work shift, workstation location and time working for the company were also collected.

Regarding indoor air quality and ventilation, the following points were assessed: ventilation, humidity, individually controlled ventilation, air speed, discomfort due to localized air streams, stale air and unpleasant odours, as well **as the occupant's satisfaction level.**

The goal of assessing the thermal comfort was to verify: thermal sensation in summer and winter, which period of the day there is thermal discomfort, feeling cold or hot at any given time of day and level of satisfaction with the thermal conditions of the working environment.

As for natural daylight and lighting, the use of natural lighting, user's control of natural or artificial lighting, amount of lighting (little or excessive) and user's satisfaction were evaluated.

On acoustics quality, noise from internal equipment (printers, telephones, keyboards and computers), vibration (including air conditioning), **colleagues, noise coming from the building's external environment and user's satisfaction with the level of noise** were evaluated. (Barreto and Silva, 2010)

About interior layout and ergonomics, privacy at the workstation, density of people in the office, pain in hands, back, legs, neck, arms and malaise, the existence of areas to make private phone calls, rest, comfort and information about the chair, computer screen adjustment possibility, if the occupant spends most of the day sitting or standing, **sufficiency of space activity implementation, and the level of the user's satisfaction.** (Ulrich, 1991)

Regarding green areas and views, the research evaluated: occupant's feeling about the existence or lack of plants and flowers in the office; visibility of trees, green areas, gardens and sky through the window and user's satisfaction level in this regard. (Lohr et al., 1996)

Questions about the aspects and perceptions involved cleanliness and organization of space, the occupant's feeling about the shapes, colors and **textures of the walls and floors of the office and the user's satisfaction level** in relation to this category.

Transportation category evaluated the means of transport to get to work, the distance from user's residence to a public transport station, availability of complimentary transport provided by the employer, if the user has no other choice to commute to work, how long the commute takes, user's stress due to commute and level of the user's satisfaction with transportation.

Finally, the access to amenities category assessed the existence of car and bicycle parking in the workplace, bicycle storage, existence of a pantry or cafeteria in the office, if there are restaurants, day care centers, parks or plazas nearby the workplace and the occupant satisfaction level regarding the category.

For the analysis of this research, only companies that registered over twenty respondents were considered, in order to avoid biased samples. Participating companies received a full report with diagnosis of their results, which can be used as a basis for the implementation of improvements.

The evaluation of perceptual method results enabled to identify, in company number 5 (see the matrix importance x satisfaction), that acoustic quality was the greatest dissatisfaction factor to occupants. With this finding, the IPT conducted measurements of sound inside two participating companies. Measurements were carried out during a typical work day, approximately, from 9 am until 3 pm, using two meters of the sound pressure. One equipment was kept fixed at one point considered critical in terms of exposure to noise generated internally, others piece of equipment were allocated in various office points, including meeting spaces areas and collective rooms, with five minutes duration measurements.

3. RESULTS

Questionnaire sent to participating companies considered nine factors of interest in literature: air quality and ventilation (1), thermal comfort (2), daylighting and lighting (3), acoustics quality (4), internal layout and ergonomics (5) green area and views (6), aspects and perceptions (7), transportation (8) and access to amenities (9). Besides questions related to each subject factor, there was also questions about the importance the respondent attributed to each factor, and how pleased he was. With data collected from these responses a matrix of importance and satisfaction was prepared for each company, which can be seen in Figure 1. (Slack, 1994) Each survey were answered only by occupants office staff per company, a total of four buildings were surveyed.

These nine factors represent the structure and workplace physical conditions that most interfere in occupants comfort and wellbeing. Seven factors are related directly to the built environment of the green building and two factors are regarding building location and surroundings.

Likert's qualitative scales were used to measure the answers thus the data analysis was necessary to make a numerical association replacing degrees of importance "Worthless", "Not very important", "Important" and "Very important" by the values 1, 2, 3 and 4 respectively; and replacing the satisfaction levels "Totally dissatisfied," "Dissatisfied" "Satisfied" and "Totally satisfied" also by 1, 2, 3 and 4 respectively.

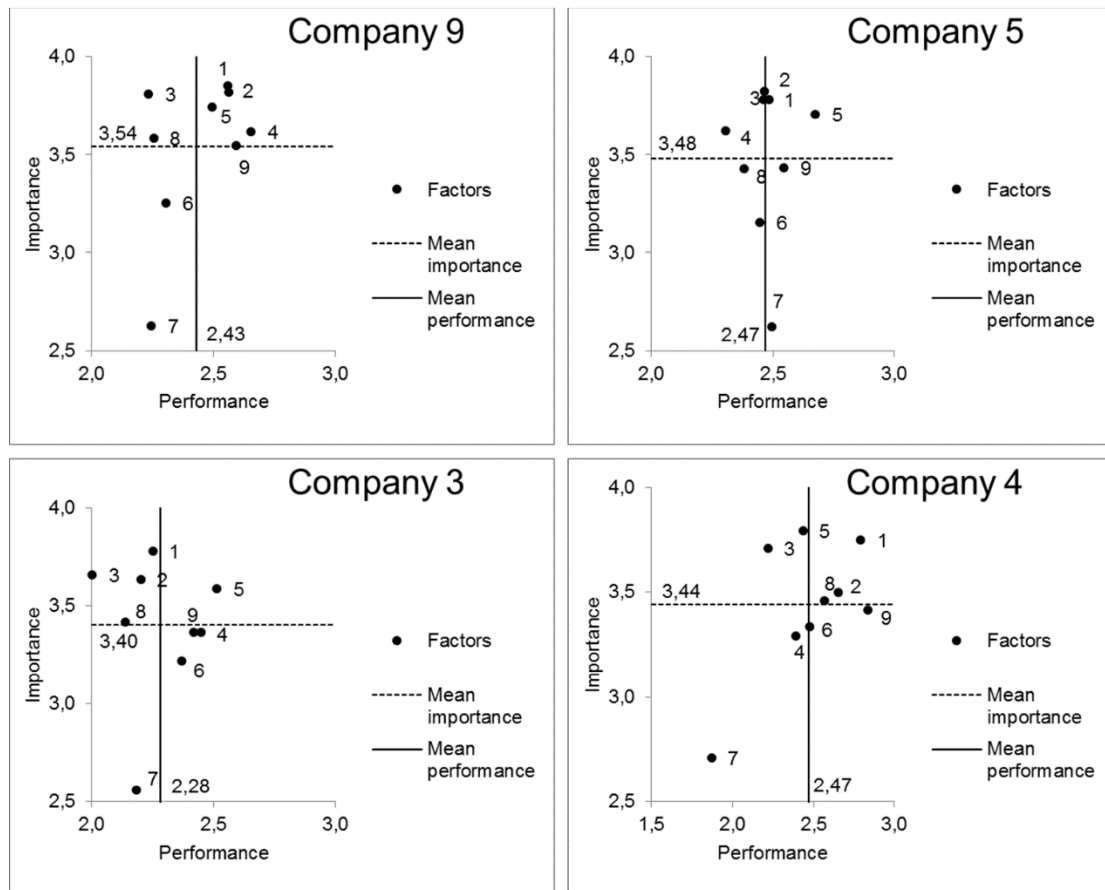

Figure 1: Matrix importance/performance of seven factors separated by company

Matrix was constructed by placing on abscissa axis the average satisfaction of all respondents for each factor and on ordinate axis the average of importance. (Martilla and James, 1977) Also plotted are the points of satisfaction and importance regarding all nine factors so factors comparisons can be done. (Pavot and Diener, 1993)

Regarding Company 3, the factors 1, 2, 3, 5 and 8 were considered more important than the factors 4, 6, 7, and 9; and respondents are more satisfied with the factors 4, 5, 6 and 9 than with the factors 1, 2, 3, 7 and 8. Highlighting the factor aspects and perceptions (7) that was considered least important in all four companies.

Regarding Company 5, the factors (1, 2, 3, 4 and 5) were considered more important, except for the factor 4 (acoustic quality) that was considered below average in terms of satisfaction, although three of them (1, 2 and 3) were situated close to the limit.

Regarding factor 4 (acoustic quality) of the office, 23 of the 116 respondents complained of noise with comments like "Coworkers talk very loudly on the phone", "People should respect the open space," "During the night, when turn off the air conditioning is noticeable the noise it makes and in the morning when they turn it on.

During the day, I think he got used to it.," Open space contribute to inconvenient noise, requiring a higher concentration at work and increased stress at the end of the shift "and even more damning phrases like" I just cannot work when two people are on the phone next to me "or" noise is one of the factors that affects me more than any other factor. Often I have to go to the quiet zone ". This company has a soundproof room called "quiet zone" where people can go at any time and stay as long as they want, when they feel disturbed by office noise.

Specific questions showing users perceptions can be seen in Table 1.

	Never (%)	Sometimes (%)	Many times (%)	Always (%)
I feel distracted/ annoyed by noise from phones, printers, computers, keyboards, and other equipment.	12,96	42,59	24,07	20,37
If windows are opened, there is too much street noise.	61,54	12,09	10,99	15,38
I feel distracted/ annoyed by machine noise from outside.	78,79	17,17	3,03	1,01
I can hear vibration noise	64,42	28,85	2,88	3,85
I feel distracted/ annoyed by speaking people noise at office.	8,41	29,91	28,97	32,71
I feel distracted/ annoyed by air conditioning vibration noise.	56,19	34,29	6,67	2,86

Table 1: Noise level perceptions at workplace

It was also asked about people's satisfaction regarding noise level, and the answers were: 7.41% were totally satisfied, 50% satisfied, 30.56% dissatisfied and 12.04% completely dissatisfied.

To improve the analysis of company acoustic quality, a physical measurement of sound pressure in the workplace was made. All respondents work in a single floor of a LEED CI certified building, and seventeen points were chosen to be measuring points. One point, considered the noisiest, was monitored during all working day, from 9:13 am until 14:53 pm, and others sixteen points were measured for 5 minutes each. At the noisiest point were measured 65 dBA and it is acceptable within offices limit, according to ABNT NBR 10152, Brazilian acoustic code standard. Sound pressure levels can be seen in Figure 2.

Measurement every half second was conducted amounting a total of 7200 measurements per hour. To better understand the sound pressure levels, measurements during lunch time are represented by the solid line, and one hour later is represented by the dotted line, were organized by frequency and sound pressure level. As an example, the average sound pressure levels were calculated of 20 Hz frequency which resulted in 44.54 dBA for lunch hours and 53.07 dBA outside this time (Figure 3). It appears that during lunch break all measured points were below the audible line, except for the frequency point of 125 Hz and sound pressure 58.28 dBA both during lunch time and outside it can be perceived. During working hours, all measured points above 200 Hz are capable of hearing.

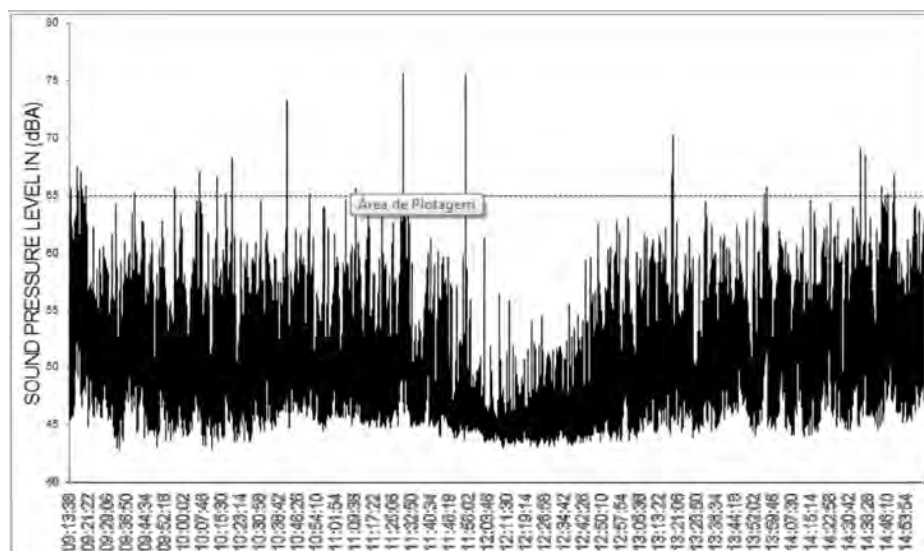

Figure2: Sound pressure level in dbA

At Figure 3 can be seen the frequency band normally used by spoken voice that goes from 500 to 2,000 Hz and the noise perception limit of air-conditioning equipment noise depending on the frequency and sound pressure provided by the equipment manufacturers.

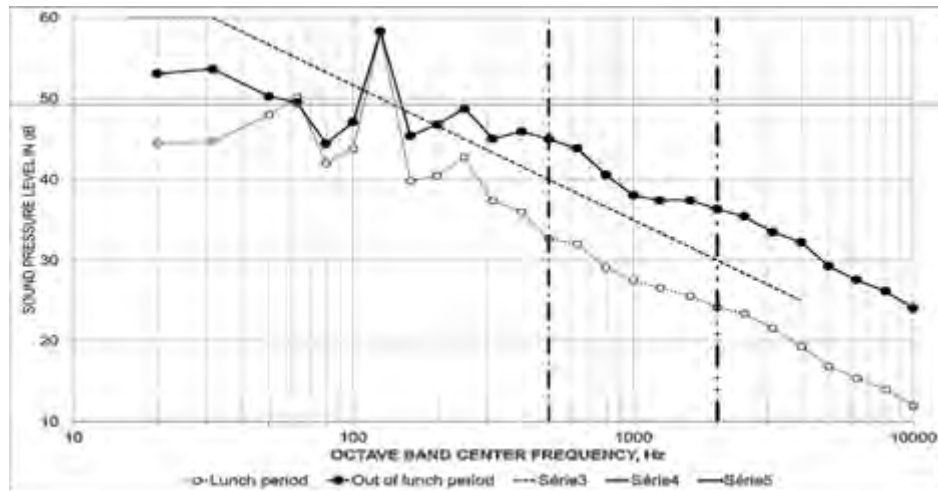

Figure 3: Sound pressure level by frequency during one hour

4. CONCLUSION

As shown on results, offices' acoustics affect people wellbeing in the workplace. Brazilians workers are loud even for LEED CI certified offices. The participant offices have been planned considering acoustics protection, for common offices the results would be really worse. Brazilian culture with the latin root is talkative, passionate, friendly and loudly sometimes! That is why not only the built environment but also the behavioral habits need to be aligned. This research aims to collaborate with the sustainable community of green buildings focusing on people. Training and sustainable courses can help to reduce the disturbance in Brazilian offices, consequently improving workers health and wellbeing and also their productivity. Brazilian sustainable facility managers really need to integrate with human resources managers to benefit all, planet, people and profit.

REFERENCES

- [1] Barreto, J and Silva,L., 2010. Limbic system and emotions - an anatomical review. Rev Neurocienc. 2010.18(3), 386-394.
- [2] BUS Methodology [online]. Retrieved from: <http://www.busmethodology.org.uk/> [Retrieved on 07 August 2016].
- [3] CBE Berkeley- Center for the Built Environment – Occupant Indoor Environmental Quality (IEQ) Survey and Building Benchmarking. [online]. Retrieved from: <http://www.cbe.berkeley.edu/research/briefs-survey.htm>. [Retrieved on 11 July 2016].
- [4] Harter, J. Schmidt, F. Kilham, F and Asplund, J., 2006. Health, Wellbeing &Productivity in Offices- The next chapter for green building. [online]. Retrieved from: http://www.worldgbc.org/files/6314/1152/0821/WorldGBC_Health_Wellbeing_productivity_Full_Report.pdf [Retrieved on 21 January 2016]
- [5] Lohr, V.I., Pearson-Mims, C.H., and Goodwin, G.K., 1996. Interior plants may improve worker productivity and reduce stress in a windowless environment. J. of Environmental Horticulture 1996. 14(2), 97-100.
- [6] Marcovitch, J. 2012. Certification and environmental sustentability: a critical analysis. Thesis (Master). Universidade de São Paulo- USP.
- [7] Martilla, J., and James, J.,1977. Importance-performance analysis. The journal of marketing, January 1977, 77-79.
- [8] Pavot, W. and Diener, E. 1993. Review of the Satisfaction with Life Scale. Psychological Assessment. 1993; 5 (2);164 -172.

- [9] Preiser, W. F. E., and Vischer, J. C., 2008. Assessing Building Performance: its evolution from post-occupancy evaluation. *Archnet-IJAR*, 2008, 2 (1), 84-99.
- [10] Slack, N., 1994. The Importance- Performance Matrix as a Determinant of Improvement Priority. Warwick Business School, UK. *International Journal of Operations. & Production Management* 1994. 14(5), 59-75.
- [11] Sommer, R., 1969. *Personal Space: The Behavioral Basis of Design*, Prentice-Hall Inc. Englewood Cliffs, New Jersey.
- [12] The Leesman Index [online]. Retrieved from: <http://leesmanindex.com/> [Retrieved on 27 August 2016].
- [13] The WELL Building Standard [online]. Retrieved from: <http://wellbuildinginstitute.com/> [Retrieved on 04 September 2016].
- [14] Ulrich R.S., 1991. Effects of interior design on wellness: Theory and recent scientific research. *J Health Care Inter Des.*1991. 3:97-109.
- [15] Wolff, J. The Triple Aim and the Triple Bottom Line. 2013. [online]. Retrieved from: <http://healthierhospitals.org/media-center/spark-blog/triple-aim-and-triple-bottom-line> [Retrieved on 19 August 2016].

Development of a Home Indoor and Outdoor Environment Visualization System

Yusuke NAKAJIMA^a

^a Kogakuin University, Japan, yusuke@cc.kogakuin.ac.jp

ABSTRACT

In recent years, HEMS (Home Energy Management Systems) have garnered attention as an energy-saving measure, and are being adopted in an increasing number of cases in smart houses and smart apartment complexes. As the name indicates, their main focus is energy management functions such as operation/control of appliances, and measurement/display of electric power. On the other hand, adjustment/maintenance of the indoor environment is an important factor for comfortable living in the home, but it is extremely unusual for indoor environment characteristics such as temperature and humidity to be **displayed. Therefore, the authors' laboratory has previously developed an "indoor and outdoor environment visualization system" as a means of raising interest** in the indoor thermal environment, and promoting use of passive technology suited to the skills of the resident and the season. Energy-saving effects and effectiveness in improving the indoor environment have also been confirmed through trial operation in housing complexes.

As the next step in development, for this report the authors improved the versatility of the equipment by packaging devices more compactly, and developed a system with additional innovations in sensing items and information transmission techniques to take into account factors of health and safety. The utility of the system was verified, and issues identified. In the means for transmitting information, small LED light which color and blinking changes with indoor environment was incorporated. From the results of test installation of this kit in a number of houses, passive activities were promoted and the effects of improvement of indoor environment were confirmed.

Keywords: energy saving, indoor environment quality, HEMS

1. INTRODUCTION

In recent years, HEMS (Home Energy Management Systems) have garnered attention as an energy-saving measure, and are being adopted in an increasing number of cases in smart houses and smart apartment complexes in Japan. Japanese government aims to put HEMS into every home in Japan until 2030. As the name indicates, their main focus is energy management functions such as operation/ control of appliances, and measurement/display of electric power. On the other hand, adjustment/maintenance of the indoor environment is an important factor for comfortable living in the home, but it is extremely unusual for indoor environment **characteristics such as temperature and humidity to be displayed. Therefore, the authors' laboratory has previously developed an "indoor and outdoor environment visualization system" as a means of raising interest in the indoor** thermal environment, and promoting use of passive technology suited to the skills of the resident and the season. Energy-saving effects and effectiveness in improving the indoor environment have also been confirmed through trial operation in housing complexes.

As the next step in development, for this report the authors improved the versatility of the equipment by packaging devices more compactly, and developed a system with additional innovations in sensing items and information transmission techniques to take into account factors of health and safety. In this research, the result of a subject experiment using that visualization system kit were reported.

2. OVERVIEW OF INDOOR/ OUTDOOR ENVIRONMENT VISUALIZATION SYSTEM KIT

Based on the results of previous operation experiments using a prototype system, the authors developed an indoor environment visualization kit that can be easily installed in existing homes. The main concepts are indicated below.

- Improved awareness of the indoor/ outdoor environment (Measurement items and screen innovation)
- Health and safety warnings (Heat stroke alerts, etc.)
- Convenience of installation (Can also be installed in existing homes)
- Power-saving design (Long-term drive using batteries)
- Simplification of data gathering (Use of Internet line in each home)
- Screen for comparison between homes (Continuation of interest)

Figure 1 shows the configuration diagram of the system. It was decided to adopt the following measurement items for the prototype kit: (1) Indoor temperature/ humidity and globe temperature, (2) Wall/ floor surface temperature (radiation temperature), (3) Carbon dioxide concentration (+ temperature/ humidity), (4) Dust concentration, (5) Outside air temperature/ humidity, and (6) Electric power consumption (main + 2 branches). It was decided to adopt specifications making it possible to ascertain the indoor vertical distribution of temperature by installing the sensor terminals for (1) – (3) at three different heights (high, medium, low). (1) – (4) are installed in a typical room (living room), and in addition one more sensor terminal for (1) was prepared for installation in any desired room by the resident. Measurement of the thermal environment is conducted every 30 seconds, and measurement of electric power every minute. In addition, the view count is collected for each page.

The indoor environment and electric power consumption are sent from each wireless base unit to a web server via the in-home Internet line, and the data is processed into easy-to-view graphs and the like. These can then be viewed from a smartphone or PC. An existing product was used as the power consumption measurement device. Compact boards (Arduino) were used for the sensor terminals newly developed and fabricated this time, and **ZigBee communication was used as the communication standard with the system's base unit (Raspberry Pie)**. Power-saving design was carried out for each board, and dry cell drive was adopted in the sensor terminals for (1) and (5).

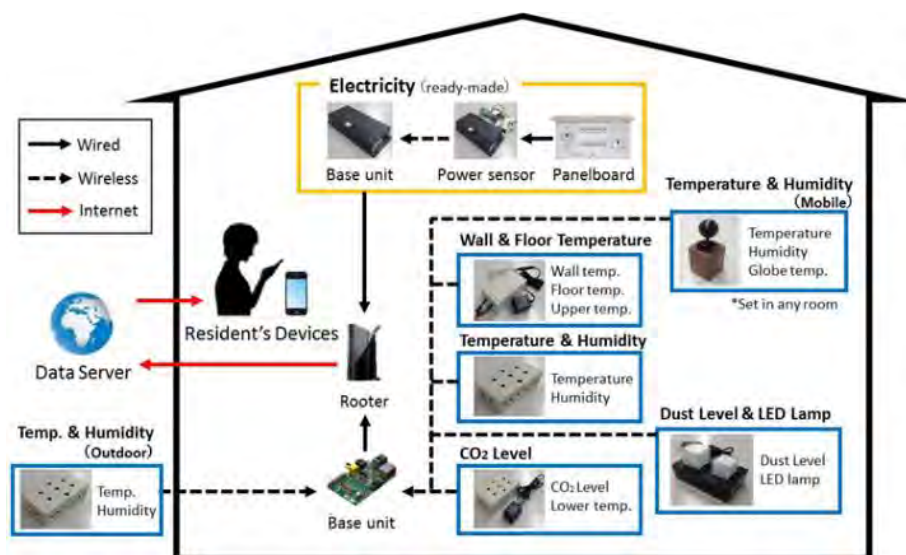

Figure 1: Configuration diagram of the system

Figure 2 shows the functions of the “LED lamp indicator” which is a major distinguishing feature of this system. This indicator provides a real-time display of the measured indoor/outdoor temperature information using the color level of an LED lamp. This allows the user to intuitively ascertain the indoor/outdoor thermal environment even without looking at a smartphone or other device. In addition, the system has a function to enable display of various alerts for ventilation, heat stroke and dryness using a flashing LED display when measurements of temperature/humidity, CO₂ concentration or other values exceed a fixed threshold. Internally, the system has a built-in dust concentration sensor.

Figure 3 shows a sample screen from the “Uchi-Repo” viewing site. The home screen displays the weather forecast for 3 days starting today and real-time values for measurement data, and the system is designed so that information on the indoor environment can be understood at a glance. At the room temperature screen, graphs are displayed of the indoor temperature, window/floor surface temperature, vertical distribution of temperature, and outside air temperature, and at the humidity screen, graphs are displayed of the indoor humidity and outdoor humidity. This enables indoor/outdoor comparison, comparison of times series for 1 week from the current day, and so forth. Time series graphs are also displayed for CO₂ concentration and electric power consumption. Also, using the comparison screen, it is possible to compare the indoor environment and electric power consumption with other households, and to ascertain the whether the indoor environment in the home is good or bad, and where power usage is high or low. The system is designed so that an LED flashes simultaneously when sensor measurements exceed fixed thresholds, and warnings on ventilation, heat stroke, and dryness are displayed on the home screen of the “Uchi-Repo” site. This helps promote quick response. To ascertain differences in the sense of heat/cold in each household, a function is also provided to enable reporting of the current degree of comfort.

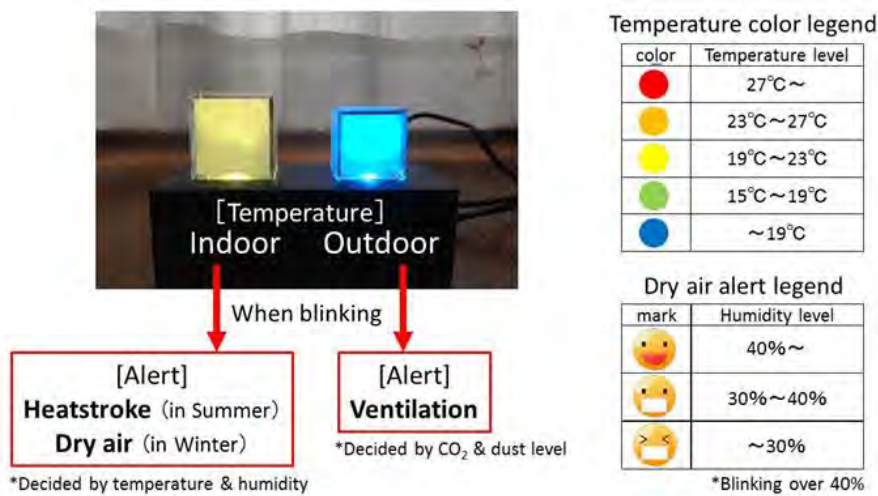

Figure 2: Functions of the “LED lamp indicator”

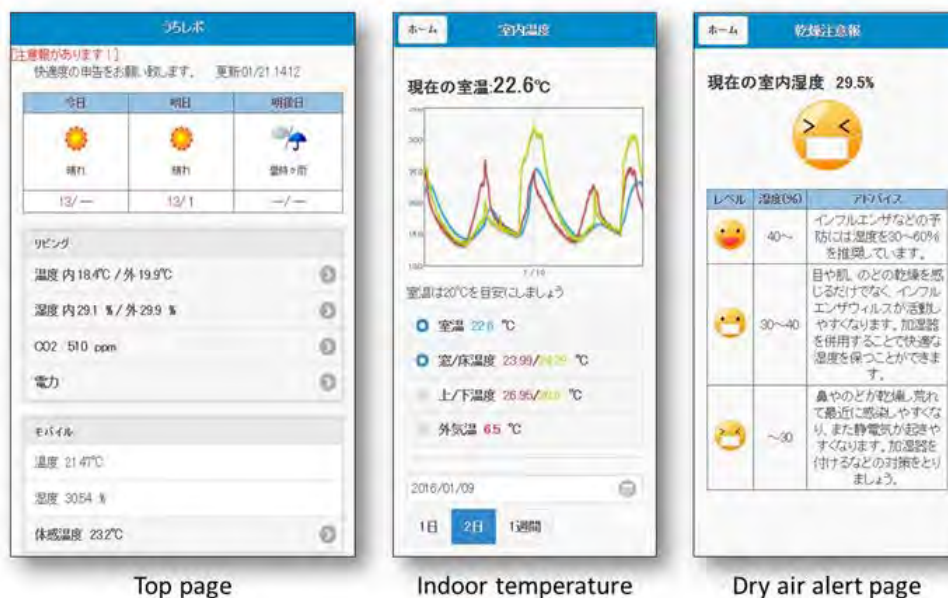

Figure 3: Sample screen from the “Uchi-Repo” viewing site

3. SUBJECT EXPERIMENT USING VISUALIZATION SYSTEM KIT

3.1 Overview of experiment

Table 1 provides an overview of the homes for the subject experiment. Experiments were conducted by installing 4 of the systems improved and developed in the previous section in 4 households. Data was only collected for **about 1 week subsequent to installation of the equipment. After that the viewing site “Uchi-Repo” and how to use it were explained, and then data was collected again for 1 week while performing visualization.** The experiment period was November 11 – 25, 2015, at the start of winter. After the experiment was finished, a questionnaire survey was administered regarding how the subject usually spends the same period each year, changes in awareness due to system adoption, and views on the system itself.

	Location	Number of residents	House type	Construction type
A	Machida city, Tokyo	5	Detached house	Wood
B	Hiratsuka city, Kanagawa	5	Detached house	Wood
C	Machida city, Tokyo	4	Detached house	Wood
D	Saitama city, Saitama	4	Apartment	RC

Table 1: Overview of the homes for the subject experiment

3.2 System viewing and evaluation

Figure 4 shows screen viewing counts for each day and time band in each household, and Figure 5 shows the viewing percentage for each type of screen. It is evident that there are differences in the view count and percentage depending on the lifestyle, interest and concern of the subject. As can be seen, in homes with a high view count (A and D), viewing is done periodically in the morning in A and in the evening in D. From Homes B and C with a comparatively low view count, comments were obtained on the questionnaire such as “the graph screens are hard to see” and “the information I want to see is hard to understand.” In terms of screen types, the percentage for the “home screen” where the full set of real-time data can be viewed is high for all households, and it is presumed that interest is high in current value data on the thermal environment and amount of electric power. The “comparison screen” received the next most views. In this regard, there was a comment that “it is interesting to compare with other households.”

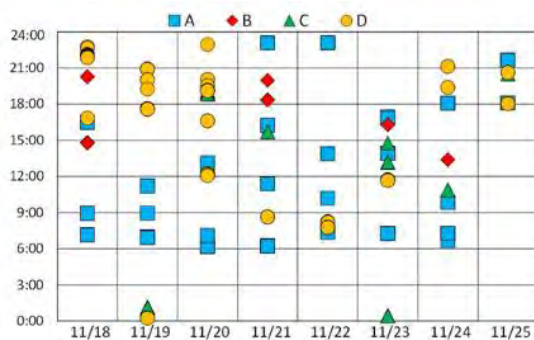

Figure 4: Screen viewing counts for each day and time band

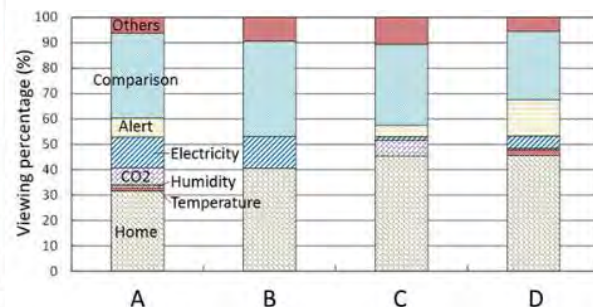

Figure 5: Viewing percentage for each type of screen

3.3 Changes in environment awareness due to visualization

Table 2 shows results regarding the changes in environmental awareness of each household according to the questionnaire. In all households, the item “I began to worry about ventilation” pertained often, and this can be regarded as confirmed by the results of interviews indicating that the subjects periodically engaged in the ventilation behavior of opening/closing doors and windows while looking at the flashing display of the LED lamp. In households where power consumption decreased, it was confirmed that subjects began to worry about use of the TV and other appliances, but it was ascertained that bothersome techniques such as unplugging generally were not translated into action even if they were effective. In addition, among households which responded that they became able to predict the current temperature and humidity, they all responded that information communication using an LED

lamp is effective. In addition, there were also comments such as “I confirmed with the LED color that maybe the current room temperature was too cold for children,” and “I determined the timing for using heating based on the LED color.” This can be regarded as confirming that this sort of visual device has high potential to aid in proper prediction and regulation of the indoor environment.

Classification	Questionnaire list	A	B	C	D	Point
Temperature	a I began to worry about temperature control.	○	△	△	△	5
	b I learned to be able to predict current indoor temperature.	○	×	○	○	6
	c I learned to be able to know my comfortable temperature.	○	△	×	○	5
	d I could control indoor temperature without heating.	○	×	×	△	3
	e I began to get sunlight from the window.	△	○	△	○	6
	f I began to worry about opening and closing curtains.	△	×	△	○	4
Humidity	g I began to worry about humidity control.	○	×	△	△	4
	h I learned to be able to predict current indoor humidity.	△	×	○	○	5
	i I could control indoor humidity without humidifier.	×	×	×	△	1
Ventilation	j I began to worry about ventilation.	○	×	○	○	6
Indoor climate	k I began to worry about indoor climate from the outside.	×	△	×	○	3
	l I began to worry about indoor climate before going out.	△	△	×	△	3
	m I began to worry about indoor climate before going to bed.	△	△	△	△	4
Electricity	n I began to worry about using appliances.	○	○	△	○	7
	o I began to reduce wasteful electricity use.	○	○	△	△	6
	p I began to turn off the TV when no one is watching.	○	○	○	○	8
	q I began to disconnect the plug of unused appliances.	△	○	×	△	4
LED lamp	r I did environment control behavior by LED lamp indicator.	○	×	○	○	6

Table 2: Questionnaire results regarding the changes in environmental awareness

4. EFFECTS OF IMPROVING INDOOR ENVIRONMENT

4.1 Passive techniques

All of the households have a custom of shutting curtains at night and opening curtains to let in light, and no practical actions were seen based on an understanding of the effects of direct gain and heat accumulation. Also, during the period of the experiment, the air temperature was comparatively high, and this may be one reason why passive behaviors were not actively carried out. However, based to the questionnaire results, it can be said that the system provided greater awareness and interest in the indoor environment, such as “I was able to adjust my clothing to suit the temperature by viewing the LED lamp” and “I noticed the difference between my body temperature and the actual temperature.”

4.2 Ventilation behavior

Figure 6 shows changes in CO₂ concentration and CO₂ screen viewing on the 18th at Home A and the 23rd at Home C. At Home A, the living room is used for sleeping, and the CO₂ concentration rises to a high level at night. It is presumed that, due to the flashing of the LED lamp every morning, the subjects viewed the CO₂ screen, and this was connected with periodic ventilation behavior. In Home C too, it was confirmed from the questionnaire that the subjects viewed the CO₂ screen and shifted to ventilation behavior when they noticed flashing of the LED lamp.

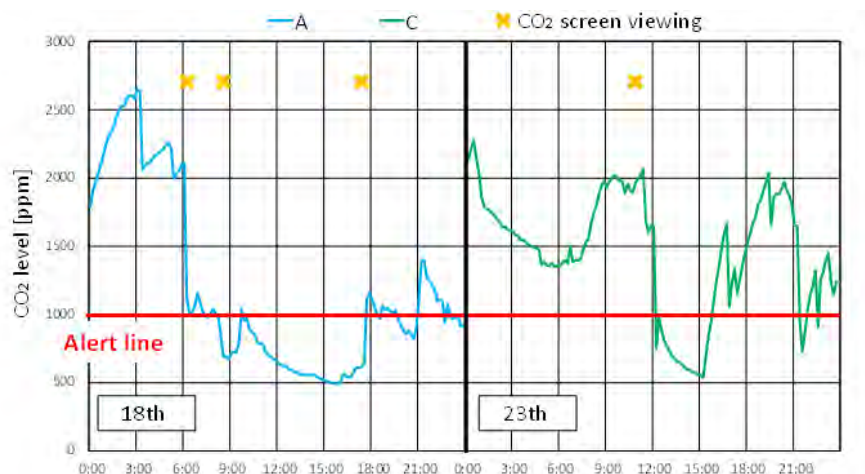

Figure 6: Changes in CO₂ concentration and CO₂ screen viewing

4.3 Energy consumption

Figure 7 shows the daily average of electric power consumption before and after adopting the system at each home. This experiment was done at the beginning of winter, but there was still not much use of heating equipment, and partly for that reason no major overall change was evident. However, in households where the rate of viewing the electric power screen was high (Home A), it was possible to confirm a certain degree of reduction.

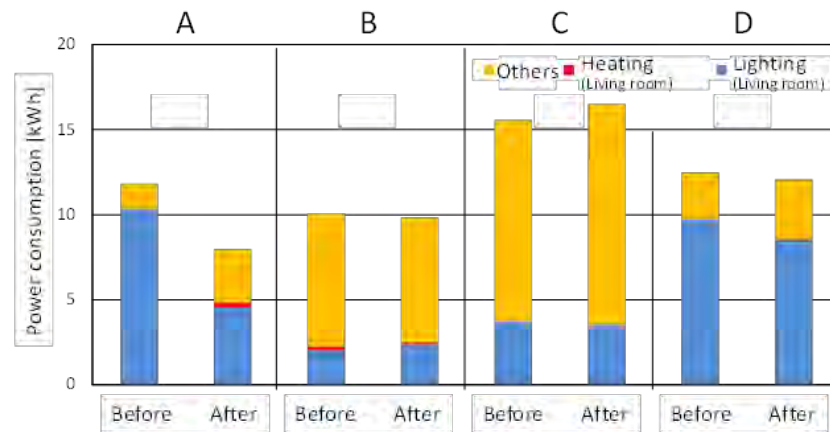

Figure 7: Daily average of electric power consumption before and after adopting the system

5 CONCLUSION

This research is a PILOT project, but the following summarizes the main findings obtained as a result of a subject experiment with the developed kit for visualization of the indoor environment.

- A tendency was evident for use of the system kit to lead to various types of awareness, interest, and concern toward the indoor/ outdoor environment, and cases were seen that were linked with specific passive behavior.
- It was confirmed that the LED lamp indicator promoted routine awareness of the indoor/ outdoor environment in almost all households, and helped to warn about alert items.
- A trend was evident of high interest in the screen comparing with other households.

Going forward, the authors will increase the number of subjects, lengthen the experiment period, conduct detailed verification of the results of improving the environment through communication of information such as warning displays, examine effective comparison screen content, improve to a system and design with less trouble and resistance to installation, and so forth. The author's plan is to proceed with development to make this a system for promoting energy-saving behavior and environment adjustment behavior, and a tool for management of energy consumption, and safety, health and comfort.

REFERENCES

- [1] Yusuke Nakajima : Development of an indoor and outdoor environmental visualization system for residential homes, Summaries of technical papers of annual meeting Architectural Institute of Japan, D-1, pp.895-898, 2015.9
- [2] Yusuke Nakajima, Development of a new type of HEMS (Home Environment and Energy Management System) for cohousing, World Sustainable Building Conference 2014, P-130, pp.1-7, 2014.10

Session 2.8: Innovations for Occupant Wellbeing (2)

Outdoor to Indoor Air Quality in Urban Environment

Alexis LAU Kai-hon^a, Jimmy TONG Chun-kuen^b, CHE Wenwei^c, FUNG Ka-kit^d, Joonho YEO^e, LI Tan-yui^f, PANG Wing-sum^g

^a Division of Environment, The Hong Kong University of Science and Technology, Hong Kong SAR alau@ust.hk

^b Arup, Hong Kong SAR, jimmy.tong@arup.com

^c Division of Environment, The Hong Kong University of Science and Technology, Hong Kong SAR, wenweiche@ust.hk

^d Cheuk Fung engineering co ltd, Hong Kong SAR, kkfungab@connect.ust.hk

^e City university of Hong Kong, Hong Kong SAR, jyeo@connect.ust.hk

^f Division of Environment, The Hong Kong University of Science and Technology, Hong Kong SAR, tyli@connect.ust.hk

^g SMEC Asia Ltd, Hong Kong SAR, wspangaa@connect.ust.hk

ABSTRACT

The World Health Organisation (WHO) stated that air pollution is the world's largest single environmental health risk, and this risk is particularly high in urban areas (WHO, 2014). Heavy traffic, high population density and packed city morphology with deep street canyons have resulted in a very high level of harmful outdoor pollutants in major cities like Hong Kong. Nevertheless, buildings still need to take in "fresh air" from the outside for their occupants. As the outdoor air remains unhealthy, the impact of bringing it into the indoor air environment needs to be further clarified.

This study focuses on the relationship between indoor and outdoor air quality, and examines how outdoor air quality varies with height in the urban street canyon. Field measurements were conducted in a high-rise office building located in a densely populated district in Hong Kong. Using the data collected, analyses were performed to check if the indoor air quality could meet the WHO daily average PM_{2.5} standard of 25 µg/m³ and CO₂ concentration of less than 1000 ppm.

Our result shows there can be an effective reduction of PM_{2.5} from outdoor to indoor, and a satisfactory CO₂ level in the building. Outside the building, our measurements show complex vertical variations of PM_{2.5} with the height that are different from what is expected from simple boundary layer theory. This may be related to the complex urban morphology and the vigorous vertical mixing within the urban street canyon. Nevertheless, even with such complexity, our results also show that it is still possible to have a building operate properly to provide a healthy indoor environment for the occupants, despite the relatively polluted outdoor environment.

Keywords: indoor environmental quality, dense urban environment, street canyon, particulate matter, CO₂ concentration

1. INTRODUCTION

With the release of hourly PM_{2.5} data in China in 2013, the public's concern for poor air quality has grown substantially. The improvement of local air quality has become a top priority in cities around the country. The air pollution problem is the most serious in major cities, where rapid urbanization and vehicular traffic in deep street canyons have led to serious deterioration of air quality.

Apart from outdoor pollution, one also needs to worry about indoor air quality, as people spend most of their time indoors. Indoor air quality relates to the health and comfort of the occupants inside a building. The US Occupational Safety and Health Administration estimated that poor indoor air quality costs employers US\$15 billion annually, including death, sick leaves and worker inefficiency (Black, 2014).

2. METHODOLOGY

2.1. Site description

This study focuses on an 18-storey commercial building with a combination of shopping mall and commercial offices, located in Tsim Sha Tsui, one of the earliest districts developed after the British took control of Hong Kong

in the 19th century. Tsim Sha Tsui has since evolved into a major commercial, shopping and tourist district, with a lot of shopping malls, restaurants, residential and office buildings, and heavy traffic throughout the day. The 18-floor building examined in this study is of average height in Tsim Sha Tsui, with both higher and lower buildings in its vicinity. This building is one block away from the main transport route, and hence the roads surrounding it are neither too quiet nor too congested. It is therefore a good candidate to study in order to understand the typical indoor impact of outdoor air pollutants in the district. Moreover, the building adopts a floor-based central air-conditioning system, and each floor has an individual fresh air-intake and distribution system. This enables us to also examine the variation of outdoor air quality as a function of height in the vicinity of the building.

2.2. Parameters

CO₂ and PM_{2.5} are the pollutants selected in this study. In the absence of indoor combustion sources, CO₂ levels in an enclosed environment are related to the number of occupants and the effectiveness of the ventilation system. Although there appears no long-term health impact from CO₂ at levels typically found in the urban indoor environment, an elevated level of CO₂ may cause drowsiness, headache and lower productivity. In Hong Kong, the Indoor Air Quality Objectives for Office Buildings and Public Places classify indoor CO₂ level lower than 1000 ppm as 'Good', and those under 800 ppm as 'Excellent' (HKEPD, 2003).

PM_{2.5} refers to airborne particles with aerodynamic diameter less than 2.5 micrometers, including dust, soot, smoke and liquid droplets. Their small size allows them to penetrate deep into our bodies, including our lungs, heart and other major organs, causing serious health impacts. Hence, PM_{2.5} is one of the most significant pollutants to be monitored. The WHO Air Quality Guidelines recommends that the 24-hour average PM_{2.5} concentration should not exceed 25 µg/m³ (WHO, 2005). In urban areas, vehicular emission is the main source of PM_{2.5} outdoors, and fuel combustion (e.g. cooking) is the main source indoors. In office buildings without combustion sources, indoor emission of PM_{2.5} should be quite limited.

2.3. Measurement protocol

In this study, the TSI Model 7575 Multifunction IAQ Meter with IAQ Probe 982 (QTrak) was used to measure CO₂, and the TSI DustTrak Aerosol Monitor 8530 (DustTrak) was used to measure PM_{2.5}. In our study, these two portable pieces of equipment were placed together in a backpack, and two backpacks (i.e. two QTrak and two DustTrak sensors) were used in the field measurements. One backpack was used to measure the air quality outdoors and the other was for indoors.

To ensure data reliability, all the portable instruments were first calibrated against stationary, research-grade air quality instruments at the university. The PM_{2.5} and CO₂ measurements from the DustTrak and Qtrak were compared with corresponding measurements by the Thermo Scientific Synchronized Hybrid Ambient Real-time Particulate 5030 Monitor and the Teledyne Gas Analyzer 360E System, respectively.

During each day of the field measurements, two researchers collected the two backpacks at the university laboratory early in the morning, started the recording, and then carried them side-by-side to the building site via **public transport. At the end of each day's work, the two backpacks were also placed side-by-side** for an hour in the building, and then they were carried back together to the laboratory for data download and equipment charging overnight. This protocol dictates that there would be three extended periods of collected data measurements by the two backpacks in different microenvironments. The accuracy and precision of the air quality data (PM_{2.5} and CO₂) from the portable sensors can hence be obtained. This protocol allows easy detection of drift and/or failure that is quite common for such portable sensors. Agreement of the collocated measurements at the beginning and **the end of a day's work can also assure us of the quality of the measurements when the backpacks were placed** separately to measure the air quality indoors and outdoors. Finally, the researchers were also asked to keep logs of their positions, and to take pictures and log remarks if they come across events that may affect local air quality.

2.4. Measurement design

Figure 1 shows the typical floor plan of the sampled building. There was a fan room with louvers to allow air intake into a central air-conditioning system on each floor. In this study, measurements taken near the louvers in the fan room were used to represent the outdoor air quality, and measurements taken at the lift lobby were used to

represent the indoor air quality for that floor. Moreover, measurements taken at a 2/F terrace were used to indicate the near ground outdoor air quality.

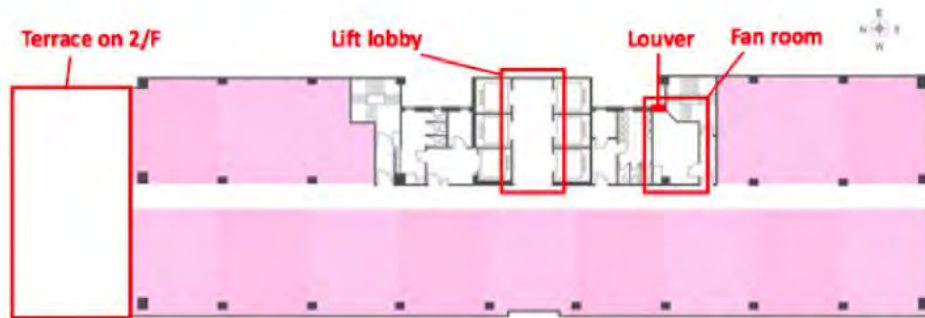

Figure 1: Floor plan of the sampled building

Two measurement programs were designed for the two objectives. For the indoor to outdoor ratio study, backpack 1 was used to measure indoor air quality at the lift lobby and backpack 2 was used to measure outdoor air quality in the fan room. The two backpacks started at the 4/F and moved up to 6/F, 8/F, 10/F, 12/F and 15/F in pairs every one hour. For the study of vertical variations in outdoor air quality, backpack 1 was placed at the 2/F terrace to measure the outdoor air quality at the reference floor throughout the measurement period, while backpack 2 was used to measure the outdoor air quality in the fan room from 4/F to 6/F, 8/F, 10/F, 12/F and 15/F for an hour each. These measurements were completed during the regular office hours from 9 am to 5 pm. Then, the two backpacks were placed together at 2/F for an hour of collocated measurements at the building site. Measurements were also carried out during the trips to and from the sampling site to allow rigorous data quality checks of the portable equipment throughout the measurement period.

3. ANALYSIS METHODOLOGY

3.1 Indoor to outdoor ratio

For both CO₂ and PM_{2.5}, an hourly indoor to outdoor (IO) ratio and the five-day averaged IO ratio are calculated for each floor.

3.2 Vertical variations of outdoor air quality around the building

Vertical variations of outdoor CO₂ and PM_{2.5} concentrations as a function of height were determined by normalizing (dividing) the measured concentrations at different floors against those measured at the 2/F. Ratios greater or smaller than one indicate that the measured concentrations at the higher floors are larger or smaller, respectively, than the corresponding concentration at the 2/F. The **Student's t-test** with *p*-value 0.05 was used to check the statistical significance of data.

4. FINDINGS

4.1 Indoor to outdoor ratio for CO₂

Floor/ Date	18/01/16	19/01/16	20/01/16	21/01/16	22/01/16	Average
4/F	1.3	1.6	1.6	1.4	1.5	1.5
6/F	3.0	2.2	2.8	2.3	2.4	2.6
8/F	1.7	1.5	1.5	1.5	1.4	1.5
10/F	2.3	2.1	2.3	2.1	2.0	2.2
12/F	2.2	2.3	2.3	2.0	1.9	2.2
15/F	2.2	2.2	1.9	2.3	--	2.2*
18/F	2.1	1.9	2.1	1.8	--	2.0*

-- Equipment failure * 4-day averages

Table 1 Summary of the indoor to outdoor ratio for CO₂ in different days

Our results show that the CO₂ concentrations in indoor areas are higher than that of outdoor areas, and the averaged IO ratio for CO₂ ranging from 1.5 to 2.6. This is consistent with our understanding that indoor CO₂ concentrations should be higher as a result of the respiratory production of CO₂ by the building occupants.

Furthermore, we found that almost all the indoor CO₂ concentrations were in the Excellent (< 800 ppm) or Good (< 1000 ppm) class (HKEPD, 2003), except for one case for the 6/F on 18th Jan, when the indoor CO₂ concentration was recorded as 1350 ppm. Our observation log noted heavier-than-normal human traffic during that morning, which may have contributed to the higher CO₂ concentration recorded.

Nevertheless, the CO₂ levels at all floors are considered safe and unlikely to cause adverse health impacts like headache, nausea or dizziness, as these symptoms are not expected for CO₂ concentrations less than 5000 ppm.

4.2 Indoor to outdoor ratio for PM_{2.5}

Floor/ Date	18/01/16	19/01/16	20/01/16	21/01/16	22/01/16	Average
4/F	0.34	0.24	0.25	0.16	0.28	0.25
6/F	0.37	0.42	0.37	0.50	0.36	0.40
8/F	--	0.34	0.42	0.36	0.45	0.39*
10/F	--	0.24	0.25	0.25	0.21	0.24*
12/F	--	0.27	0.33	0.32	0.47	0.35*
15/F	0.41	0.41	0.51	0.36	0.48	0.43
18/F	0.21	0.17	0.38	0.19	0.29	0.27

-- Equipment failure * 4-day averages

Table 2: Summary of the indoor to outdoor ratio for PM_{2.5} for different days

Our measurements show that all IO ratios of PM_{2.5} are significantly less than 1, showing substantial reduction of PM_{2.5} through the central air-conditioning and filtration system in the selected building. We further note that the hourly outdoor average PM_{2.5} levels were mostly above 25 µg/m³, while all of the hourly indoor average PM_{2.5} levels were below 25 µg/m³; the highest hourly indoor PM_{2.5} concentration of 17 µg/m³ were measured on the 6/F on Jan 20th. 25 µg/m³ is the WHO daily average Air Quality Guideline for PM_{2.5} (WHO, 2005). Our results showing that all the hourly average indoor PM_{2.5} concentrations were below this guideline value indicate that the central air-conditioning and filtration system in the sampled building has been effective in maintaining good air quality with respect to PM_{2.5} during our measurement period.

4.3 Vertical variations of outdoor CO₂

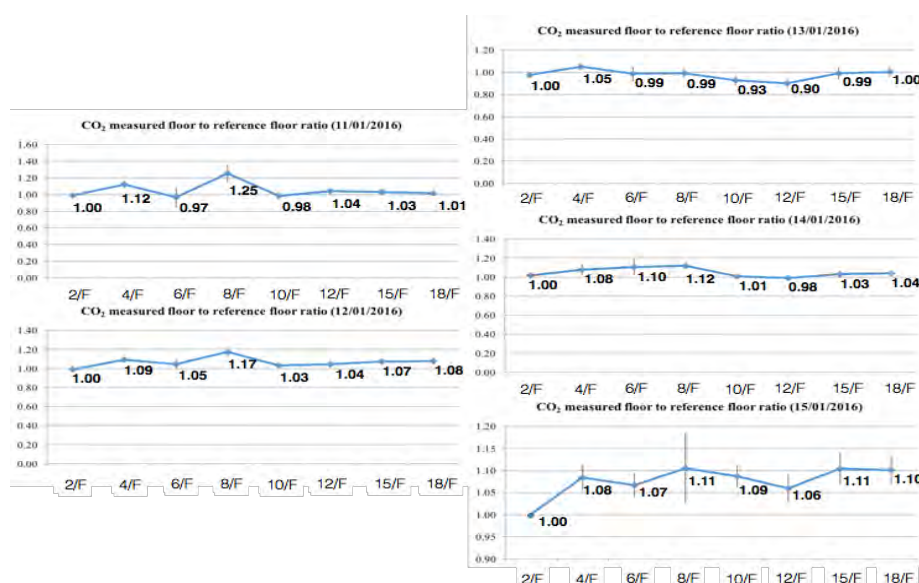

Figure 2: Normalized plots of CO₂ levels in measured floors to reference floor in different days (Error-bars denote ±1 standard deviation)

Figure 2 shows the average ratios of outdoor CO₂ concentrations at different floor heights with respect to the corresponding outdoor CO₂ concentration at the reference level on 2/F for different measurement days; error-bars at one standard deviation are also shown. It is found that the ratios were all very near one, suggesting that in the urban environment surrounding the selected building, the vertical variations of CO₂ from the surface to the top of this 18-storey building is very limited, if any.

4.4 Vertical variations of outdoor PM_{2.5}

Figure 3 shows the average ratios of outdoor PM_{2.5} concentrations at different floor heights with respect to the corresponding outdoor PM_{2.5} concentration at the 2/F reference level for different measurement days; error-bars at one standard deviation are also shown. Different from CO₂, there appears more vertical variation with height in the outdoor PM_{2.5} concentrations, and the variations are quite complex.

In particular, there was an apparent concave shape in the vertical variations of PM_{2.5} concentration with height, with maximum PM_{2.5} level occurring between the 8/F to 12/F and lower PM_{2.5} concentrations above and below these levels for most days, except on the 13th Jan 2016 when the maximum PM_{2.5} level occurred around the 4/F. This is quite different from what one would have expected from simple boundary layer theory that predicts a gradual drop in PM_{2.5} with height.

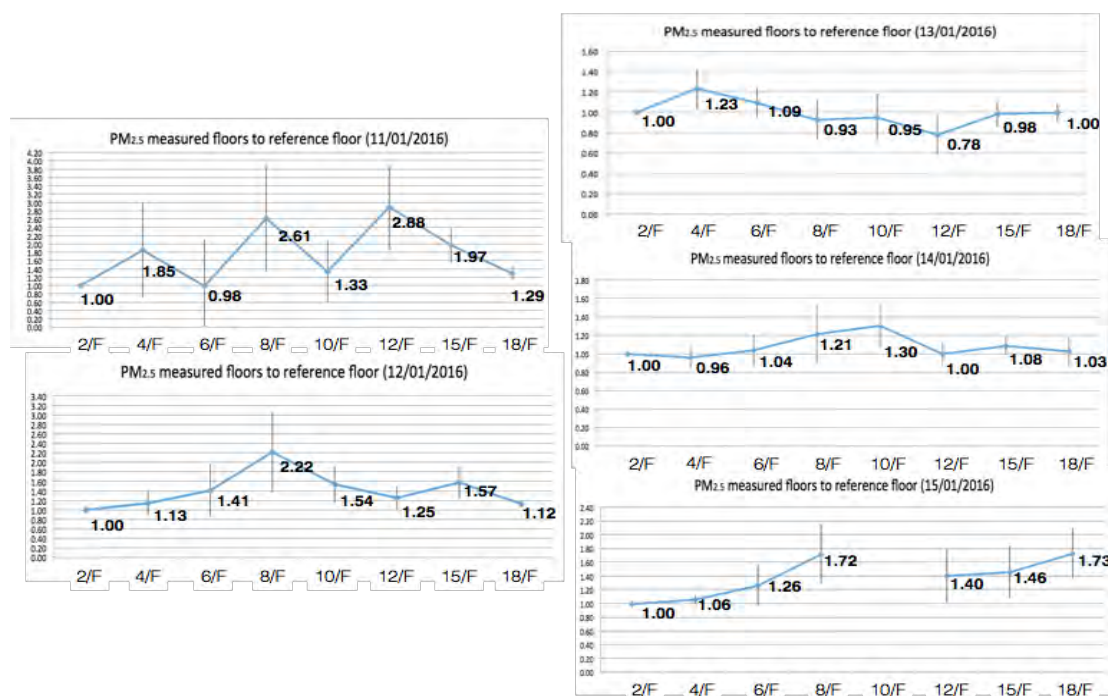

Figure 3: Normalized plots of PM_{2.5} levels in measured floors to reference floor in different days (Error-bars denote ± 1 standard deviation)

To better understand the possible cause(s) of this unexpected vertical variation in PM_{2.5} concentration, we examined the built morphology around our sampled building. Figure 4 shows the building heights of our sampled building (shown in grey) and a few buildings around it along an east-west cross-section. We noticed that there is a shorter building to the immediate east of our sampled building and its roof is approximate at the same level as the 8/F of our sampled building. We also note that from Figure 1 that the fan rooms are on the eastern side of our sampled building.

These configurations make us suspect that the wind circulation may have become more complicated and have affected the average vertical distribution of PM_{2.5} on the eastern side of the sampled building. To assess that possibility, a computational fluid dynamics (CFD) run using the built morphology shown in Figure 4 was conducted. Average wind data recorded at the Hong Kong Observatory over the measurement period was used as background wind to drive the CFD model.

The prevailing wind direction during our sampling period was easterly, and the average wind speed simulated in the CFD model is shown in Figure 4, which shows a recirculation cell next to our sampled building and on the top of the roof of the shorter building to the east. Under the influence of such a recirculation cell, the wind speeds around the 8/F floor on top of the adjacent building would be reduced, and trapping enhancement of pollutants like PM_{2.5} could occur there.

Further, the recirculation cell can help re-suspend particulates deposited on the rooftop of the adjacent building, leading to a high concentration of PM_{2.5} just above its roof top level of 8/F in our sampled building. Lastly, we have not checked whether there was any exhaust on the rooftop of the shorter building, which (if exists) could also increase the local PM_{2.5} around that level.

In summary, our measurements show that, near our sampled building, the vertical variation of outdoor PM_{2.5} is complex, with maximum PM_{2.5} concentration between 8/F to 12/F, which is different from a decreasing distribution from the ground expected from simple boundary layer theory. The complex built morphology, the re-entrainment of pollutants from nearby rooftops, or exhaust emissions from nearby rooftops may have contributed to this difference.

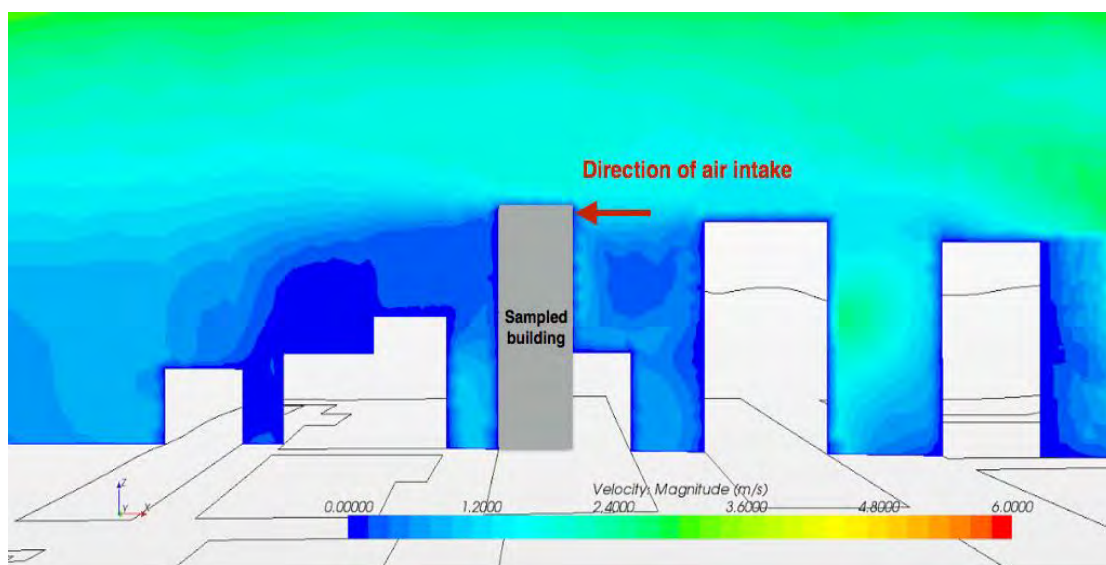

Figure 4 Simulation of wind motion at the sampled building during 11/1/2016-15/1/2016

5. CONCLUSION

This study examines the indoor to outdoor ratio of CO₂ and PM_{2.5} in a typical commercial building in a densely populated urban metropolis. We found that the average indoor to outdoor ratio for CO₂ ranged from 1.5 to 2.6, and the average indoor to outdoor ratio for PM_{2.5} ranged from 0.24 to 0.43 in our sampled building.

Moreover, the air-conditioning and filtration system of the building was able to keep most of the indoor CO₂ concentrations below 1000 ppm, and the hourly indoor PM_{2.5} concentration below the WHO daily guideline for PM_{2.5} at 25 µg/m³, despite the outdoor PM_{2.5} concentrations that exceeded this guideline level most of the time. These results show that **it is possible to have a building managed properly to provide a healthy indoor environment for the occupants despite a relatively polluted outdoor environment.**

Taking advantage of the fan rooms at different levels, we also examined the vertical variations of CO₂ and PM_{2.5} in the outdoor environment. We found little vertical variation in CO₂ concentration from the ground to the top of our sampled building. On the other hand, we found that the vertical distribution of PM_{2.5} around the sampled building to be more complicated (with highest PM_{2.5} concentration between 8/F to 12/F) and different from what is predicted by simple boundary layer mixing theory. Subsequent CFD analysis suggests that this may be related to the microenvironmental flow created by the complex urban morphology. Hence, our results suggest that one should not assume pollutant concentrations must be decreasing with height in complex urban environments. More detailed analysis and simulations are needed.

6. ACKNOWLEDGEMENT

The authors like to thanks Sino Estates Management Limited, specifically, Nelson Chiu, Raymond Sin, Peter Tang and Daniel Tsang, for providing their Hong Kong Pacific Centre as the sample building and their supports throughout the testing process.

REFERENCES

- [1] WHO. (2014, March 25). World Health Organization. Retrieved from News release: <http://www.who.int/mediacentre/news/releases/2014/air-pollution/en/>
- [2] Black, M. (2014, July 25). How Employee Productivity Chokes on Indoor Air. Retrieved from Huffpost Healthy Living: http://www.huffingtonpost.com/marilyn-black/how-employee-productivity_b_5620941.html
- [3] HKEPD. (2003). IAQ Objectives for Office Buildings and Public Places.
- [4] WHO. (2005). WHO Air quality guidelines for particulate matter, ozone, nitrogen dioxide and sulphur dioxide.

Redesigning Long-Term Senior Care: Design Solutions to Facilitate Different Levels of Care Needs in Senior Housing - Using Hong Kong's Latest Senior Housing as Example

Bryant LU^a

^a Ronald Lu & Partners, Hong Kong SAR, bryantlu@rlphk.com

ABSTRACT

Over the next two decades, between 2017 and 2037, China will see an enormous increase in its population of senior citizens (people over 65). This increase will result in two hundred million seniors needing to be accommodated. In Hong Kong, the issue of an aging society is even more critical: in just 15 years, the city will need to accommodate another one million seniors, one-seventh of its current total population.

Thanks to advances in healthcare and technology, today's seniors are expected to enjoy a dynamic and high-quality lifestyle for a much longer period of time after they retire. **The extended lifespan of these "new generation senior citizens" poses a number of uncertainties and unprecedented challenges in terms of the design** of senior housing and the provision of sustainable elements – these designs need to be adapted to help seniors enjoy their dynamic lifestyle as well as assist them through the aging process.

This paper explores how the different stages of life and aging are categorised in different countries and which long-term senior care needs are associated with these categorisations. It also investigates the country-specific regulations and guidelines formulated for the needs of seniors, and discusses how design solutions can facilitate their implementation. Japan, Australia and Canada have comprehensive pension and senior care policies. Their long-term care systems were studied in this paper.

Lastly, the paper discusses two senior housing projects in Hong Kong, Harmony Place and The Tanner Hill, as case studies. The paper concludes four design strategies that will help achieve sustainable long-term senior care in housing developments in China and Hong Kong.

1. THE AGEING TREND IN THE POLULATION OF CHINA AND HONG KONG

1.1 Rapid ageing

The ageing of China's population has become more apparent as it enters the 21st century. According to scholar Florian Coulmas' definition of an ageing society in his study on Japan, a country is an 'ageing society' when its seniors (aged 65+) account for 7% of the total population. It becomes an 'aged society' when the percentage rises to 14%, and a 'hyper-aged society' when the percentage reaches 21% (Figure 1). According to the census and forecast data of the World Health Organization, China became an ageing society in 2000, and will become a hyper-aged society come 2040.

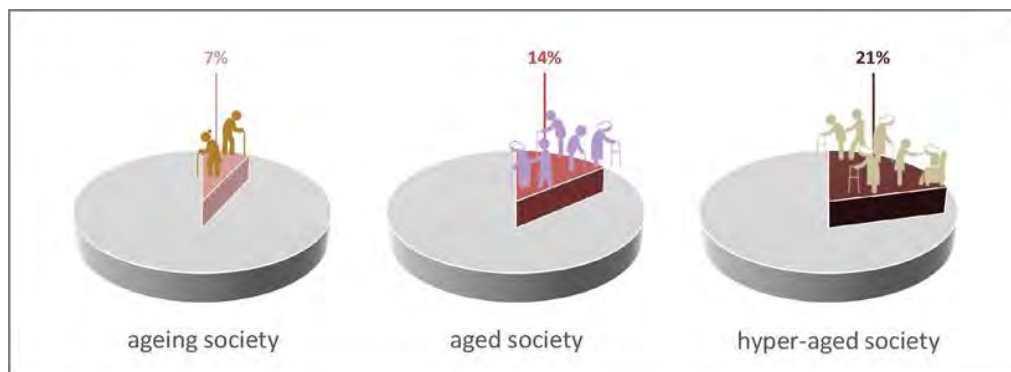

Figure 1: Definition of "ageing society", "aged society" and "hyper-aged society"

Based on the ageing rate, China will enter a period of rapid ageing after 2030. It takes 30 years (2000 - 2030) for an ageing society to become an aged society, but it takes only 10 years (2030 - 2040) for it to move further into a hyper-aged society. As far as the senior ratio is concerned, it takes merely 22 years (2010 - 2032) for it to double to 25%. It is estimated that by mid-century, China's senior ratio will reach its peak, with one-quarter of its population aged 65+. This ratio is higher than the definition for a hyper-aged society, and far higher than the world average (Figure 2).

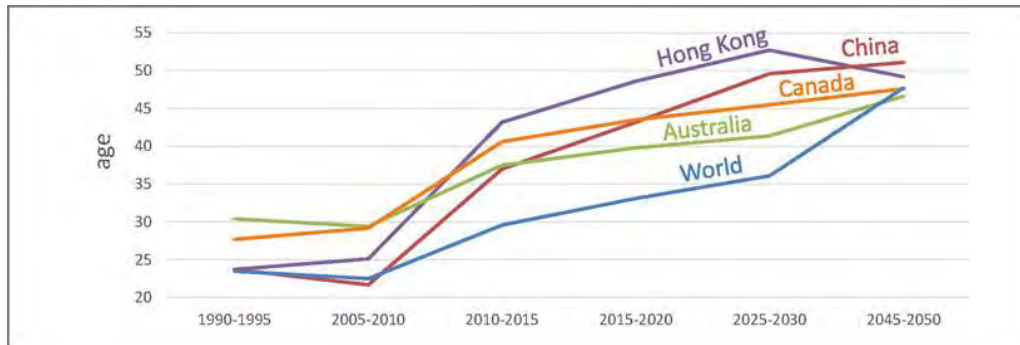

Figure 2: Median age of population in China, Hong Kong and other countries

(Source: United Nations, Department of Economic and Social Affairs, Population Division (2015). *World Population Prospects: The 2015 Revision*. New York: United Nations)

Although the senior ratio at its peak in China is still far lower than some of the developed and developing countries (such as Japan and Singapore, etc.), in terms of absolute numbers, it still represents an enormous growth, and the number of seniors has long topped the global league. It took Hong Kong and China merely 30 years from the end of the last century to evolve from an ageing society into an aged society, a speed that far surpasses the ageing process of developed countries at the beginning of the last century (Figure 3).

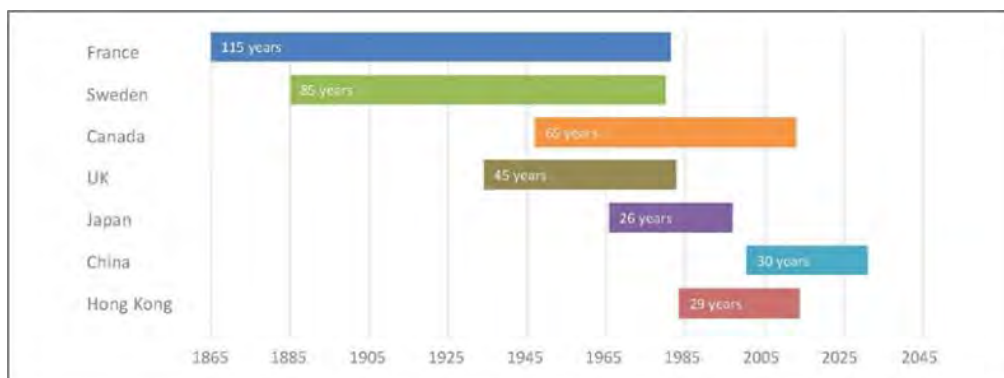

Figure 3: Time required for seniors of various countries to grow from 7% to 14%

(Source: United Nations University, and WHO Kobe Centre. "The Wisdom Years: Ageing into the 21st Century". <http://wisdom.unu.edu/en/ageing-societies/index.html> and United Nations, Department of Economic and Social Affairs, Population Division (2015). *World Population Prospects: The 2015 Revision*. New York: United Nations)

So what are the implications for the economy of a rapid rise in population and an enormous number of seniors? Statistically, China will, within the next two decades (2017-2037), have an added 200 million seniors (aged 65+), which is equivalent to Japan's current population x2 (Figure 4). This means society must now make provisions for the many challenges brought about by these 200 million seniors.

Compared with China as a whole, Hong Kong's ageing population problem is even more serious. Its senior population will grow by close to a million within 15 years (2014-2029) (Figure 5). Seniors numbered 1 million in 2014, accounting for 15% of the population, but rapid growth will take the numbers to 2 million and 26% respectively in 2029. It will be a serious challenge to provide housing and related senior care services for these additional 1 million seniors in the next 10 to 15 years.

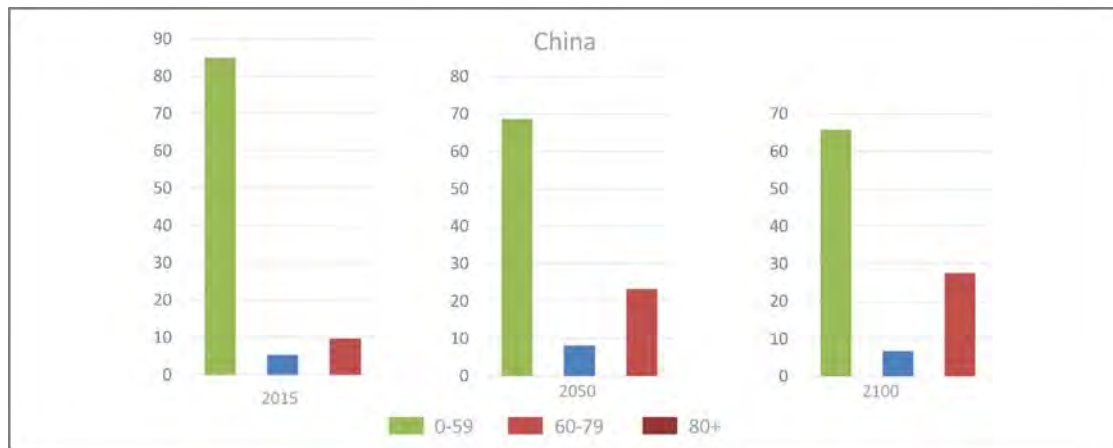

Figure 4: The ageing trend in China's population, 2015, 2050, and 2100
(Source: United Nations, Department of Economic and Social Affairs, Population Division (2015). *World Population Prospects: The 2015 Revision*. New York: United Nations)

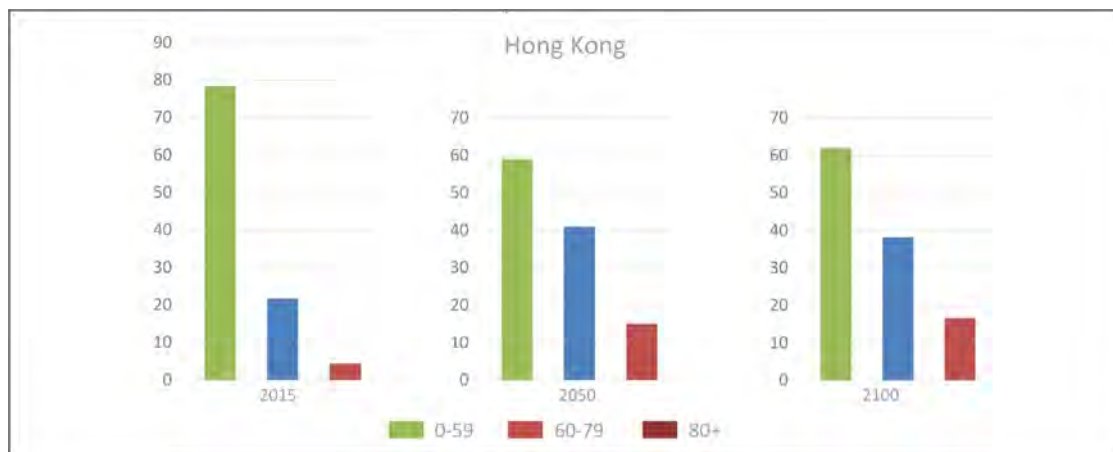

Figure 5: The ageing trend in Hong Kong's population, 2015, 2050, and 2100
(Source: United Nations, Department of Economic and Social Affairs, Population Division (2015). *World Population Prospects: The 2015 Revision*. New York: United Nations)

1.2 The extension of senior living

Following the ageing in the population, there is also an extension in the period of senior living. As the general retirement age in China is around the age of 60, related rule and regulations and definitions on senior care are also based on 60 years of age. Consequently, the drastic changes in the lifestyle of a senior actually precede his physiological changes.

Due to historical reasons, and using 60 years of age as the cut-off point, the growth in the ratio of younger seniors will be more rapid than those in the 65+ group. At its peak, one-third of the population could be over 60 years of age. Therefore, the number of people approaching or entering a senior lifestyle could exceed the number based on physiological grounds.

There is a continued rise in life expectancy in China, exceeding the age of 80 at mid-century when the number of seniors reaches its zenith. In other words, seniors will, in future, enjoy more than 20 years of old-age living. The situation in Hong Kong is even more pronounced, as its general life expectancy will remain on top from now until mid-century (Figure 6). Between 2045 and 2050, its life expectancy is close to 90 years of age, meaning that Hong Kong seniors will enjoy almost 30 years of old-age living. The extension of senior living creates different demands on senior care services and housing facilities.

2010-2015			2025-2030		2045-2050	
1	Hong Kong	83.7	Hong Kong	86.0	Hong Kong	88.7
2	Japan	83.3	Japan	85.5	Singapore	88.3
3	Italy	82.3	Singapore	85.4	Japan	88.1
4	Switzerland	82.7	Italy	85.3	Martinique	88.1
5	Singapore	82.6	Switzerland	85.0	Italy	88.0
6	Iceland	82.3	Iceland	84.7	Chile	87.8
7	Spain	82.3	Spain	84.7	Republic of Korea	87.7
8	Australia	82.1	Israel	84.7	Switzerland	87.6
9	Israel	82.1	Chile	84.7	Israel	87.5
10	Sweden	81.9	Australia	84.6	Guadeloupe	87.4

Figure 6: Life expectancy of the Top 10 countries/ regions based on year of birth
(Source: United Nations, Department of Economic and Social Affairs, Population Division (2015). World Population Prospects: The 2015 Revision. New York: United Nations)

Date of appointment	Normal retirement age
On or after 1 June 2000 but before 1 June 2015	- 60 for civilian officers
	- 55/ 57 for disciplined services officers
On or after 1 June 2015	- 65 for civilian officers
	- 60 for disciplined services officers

Figure 7: Normal retirement age for civil servants in Hong Kong
(Source: Administration of the Civil Service, Civil Service Bureau, The Government of the Hong Kong Special Administrative Region 2016)

2. DIFFERENT LEVELS OF SENIOR CARE IN OVERSEAS COUNTRIES

2.1 Levels of care based on age in Canada

In the population ageing process, the speed of ageing and the physiological changes vary based on age. The speed of physiological decline varies from person to person, but is largely related to age. The decline in body functions must be matched by an appropriate level of care, therefore different age brackets are often used to determine the level of care. According to the Canadian Department of Health definitions in the 1990s, 60+ senior care is divided into three categories:

- Independent self-care: Generally refers to from retirement to 75 years of age (varying according to individuals). Seniors in this category have not experienced serious decline in their body functions, and may only require simple assistance for certain activities. They can choose to live independently, or in nursing homes that provide only basic lodging facilities. They can seek limited care services as required. From the age point of view, independent self-care is the most important stage of senior care.
- Semi-independent: Generally refers to 72+ of age. Seniors in this category have undergone certain levels of decline physiologically, and would find it difficult to stay fully independent. They would be recommended to choose nursing homes that provide basic care services.
- Full care 1: Generally refers to 79+ of age. Seniors in this category have experienced a higher level of decline. A full-service nursing home would provide the needed care.
- Full care 2: Generally refers to 84+ of age. Depending on individuals, seniors in this category may need to live in a nursing home or an associated medical care facility indefinitely.

2.2 Different levels of senior care and daily assistance facilities in Japan

In 1997, Japan introduced standards for long-term senior care needs. The assessment divided senior living self-care capabilities into 7 categories, viz, independent, assistance needed, and care services needed (class I to V). 'Independent' seniors refer to those who can live independently without any assistance. 'Assistance needed' seniors refer to those who can basically live by themselves, but may need assistance for social activities. 'Care needed' seniors class I refer to those who need some care; class II refer to those who need a low level of care; class III refer to those who need a medium level of care; class IV refer to those who need a high level of care; and class V refer to those who need the highest level of care.

In 2006, Japan revised the standards from the original 7 categories into 8 categories by splitting the 'assistance needed' category into class I and II. It also re-confirmed that all 'care services needed' categories require care services.

The long-term senior care classification is not solely based on the individual's health condition, but also on the time needed for the care services, and the level of care needed. Initially, Japan adopted a method of measuring the degree of care per minute for the sake of standardization. They assigned a bar code for each type of care services, and then recorded two consecutive days of care services data. After electronic processing, they worked out the degree of care on a per minute basis, and came up with the time required for individual care services, and hence the basis for classification.

However, the resultant data can show a significant difference from the actual time, and tend to push the services onto a higher category. By using a number of other approaches, the Japanese government improved on the original software in 2003. They put all the care services through a statistical analysis, and based on their inter-relationships, devised a tree-like model in order to measure the care time. In deciding on the classification, they take into consideration the seniors' physical and psychological well-being, and their medical diagnosis.

Based on the time required for the care services, the classification works out as follows: independent - below 25 points; assistance needed: 25 - 32 points; care needed - class I: 32 - 50 points, class II: 50 - 70 points, class III: 70 - 90 points, class IV: 90 - 110 points, and class V: 110+ points (Figure 8).

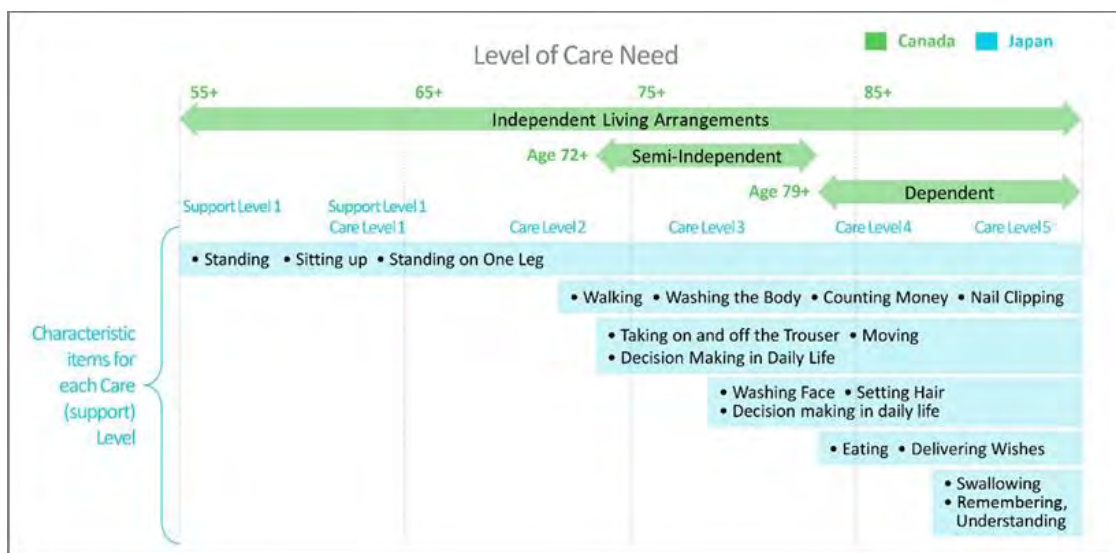

Figure 8: Canadian senior classification and Japanese senior care classification

2.3 Different levels of senior care system and policy in Australia

Based on different levels of senior care needs, Australia divides its hostel type of senior care, or the traditional nursing homes, into three categories. Its low level care allows the seniors to lead an independent life, but receive, at the same time, assistance with meals, washing, personal matters and care. The typical mode of operation is the specialized serviced apartments for seniors. Its high level care provides 24-hour care, in addition to meals, washing, cleaning, health care and personal care. The typical mode of operation is the traditional nursing home. Hospice

care provides for specialized care and medical attention for seniors with a terminal illness, making sure that patients enjoy a quality life to the very end.

As the majority of seniors opt for a low level of care and only parts of the high level care, a substantial portion of Australian seniors prefer to remain at home, or live in the local community with access to care services. Some seriously ill seniors or those with Alzheimer's disease also share the same preference. In order that these people can receive the same level of care services as in nursing homes, the Australian government has, in recent years, reinforced its support for community care services, and has, since August 2012, included community care services for Alzheimer's disease sufferers in the National Health Priority Area.

Currently, Australia has a very comprehensive community care service, and can provide for bespoke services to meet specific needs. Therefore, seniors can enjoy a longer period of independent living. This not only leads to very obvious social benefits, but also alleviates the pressure on nursing homes, thereby reducing social costs.

Based on different classes of care, Australia's community care services include:

- Home and community care (HACC): It includes seniors' daily care and health care services, home services, meals, transport, and repairs & maintenance.
- Community aged care project (CACP): It provides a variety of care services for seniors or those in weak health, and seniors with more complex needs.
- Long-term home care project: It provides for more flexible and personal services than CACP for those who need a high level of care.

2.4 Classification of current senior care policy in China

Currently, China's "Basic Policy of Social Welfare Agencies for Seniors" divides the care needs of people of 60+ years of age into three categories:

Self-care: Fully independent in everyday life without relying on others;

Device-aided: Relies on railing, walking stick, wheelchair and elevator in everyday life;

Nursing-cared elderly: Relies on care services in everyday life.

Based on the care needs of different age groups, the policy provides guidelines on the range of specific services (Figure 9).

For self-care seniors: Daily cleaning to ensure there are no flies, mosquitoes, rats, cockroaches and bugs; provision of clean, proper clothes plus washing (weekly in winter, spring and autumn, and more regularly in summer); maintaining a flow of fresh air; assistance with bedding management; weekly replacement of blanket cover, bed sheet and pillow cover (including immediate replacement as necessary); 2 bathing sessions per week in summer, one in other seasons; reminders on washing and cutting hair, and nail clipping; 24-hour care services based on established procedures; and adjustment of services depending on circumstances.

For device-aided seniors: Daily cleaning to ensure there are no flies, mosquitoes, rats, cockroaches and bugs; provision of clean, proper clothes plus washing (weekly in winter, spring and autumn, and more regularly in summer); maintaining a flow of fresh air; assistance with bedding management; weekly replacement of blanket cover, bed sheet and pillow cover (including immediate replacement as necessary); 2 bathing sessions per week in summer, one in other seasons; assistance with washing hair and nail clipping; regular barber service to ensure proper grooming; regular washing of towels and cleaning of wash basin; weekly toilet disinfection; assistance with visits to the toilet; 24-hour care services based on established procedures; and adjustment of services depending on circumstances.

For nursing-cared elderly: Daily cleaning to ensure there are no flies, mosquitoes, rats, cockroaches and bugs; provision of clean, proper clothes plus washing (weekly in winter, spring and autumn, and more regularly in summer); maintaining a flow of fresh air; assistance with bedding management; weekly replacement of blanket cover, bed sheet and pillow cover (including immediate replacement as necessary); assistance with dressing in

the morning and undressing at night; 2 bathing sessions per week; regular hair washing and nail clipping; dental care; regular barber service to ensure proper grooming; regular washing of towels and cleaning of wash basin; weekly toilet disinfection; meal delivery and feeding; assistance with visits to the toilet; provision of walking stick, wheelchair and other devices as needed; assistance with personal cleaning in the morning and feet washing in the evening; weather permitting, accompanying the elderly daily for a one-hour session of outdoor activities; 24-hour care services based on established procedures; adjustment of services depending on circumstances; assistance with purchasing tickets for travel; special protection for females, the intellectually handicapped and those suffering from mental illness; and special provisions for elderlies with communicable diseases, including isolation arrangements and treatment, based on the principle of maintaining their dignity and consideration for others.

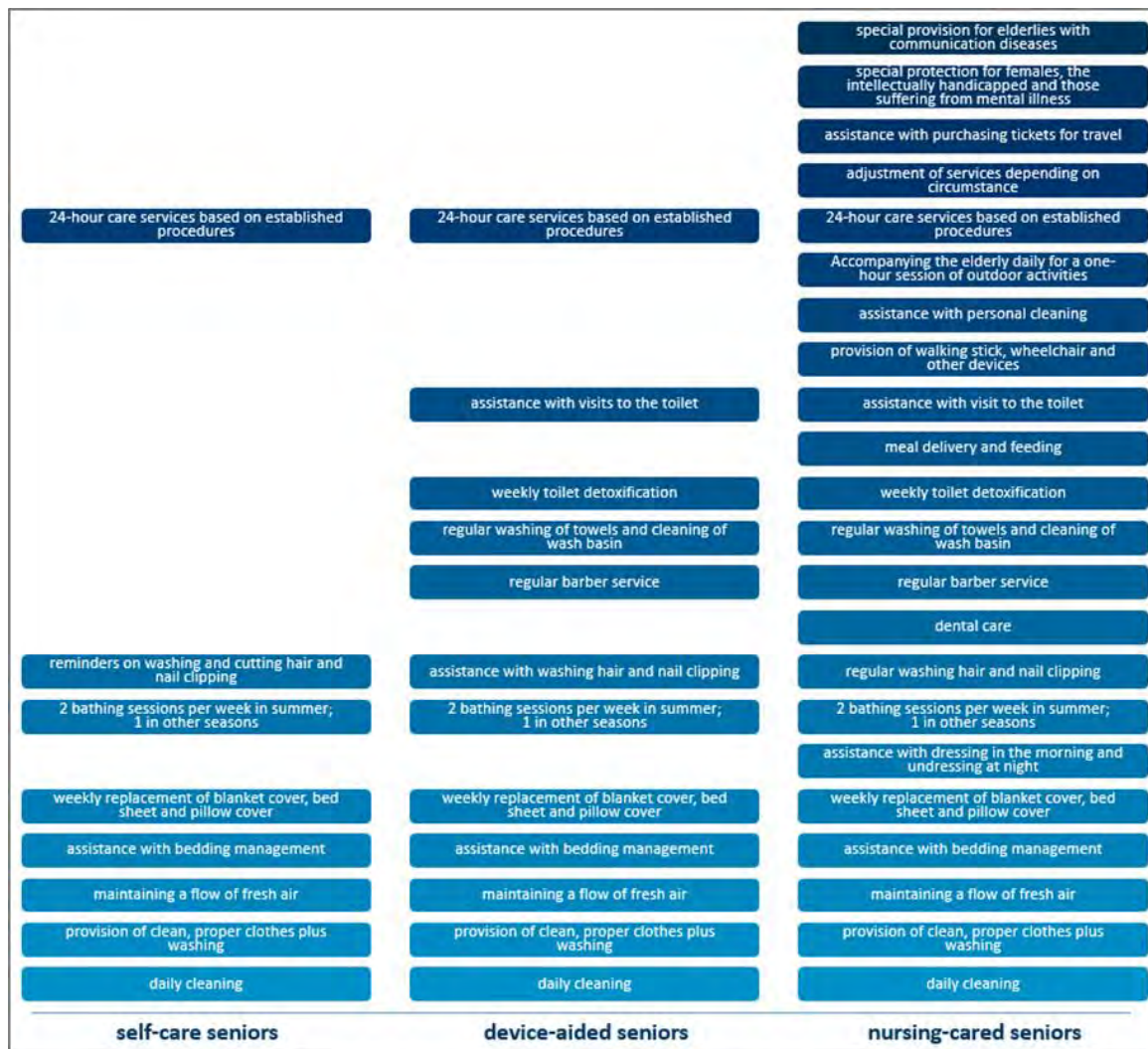

Figure 9: Guidelines on the range of specific services to be provided to different age groups with different care needs

To meet the different levels of care needs, China's senior care facilities feature different modes:

- Homes for the Aged: Cater to seniors who are independent, need assistance or care. They provide lodging, entertainment, rehabilitation and medical care services.
- Hostels for the Elderly: Provides communal living facilities for the elderly, including meals, hygiene, entertainment and medical care services.
- Homes for the Device-aided Elderly: Provides assistance to the elderly, including lodging, entertainment, rehabilitation, and medical care services.
- Nursing Homes: Provides care services to the elderly, including lodging, entertainment, rehabilitation, and medical care services.

- Homes for the Elderly in the Rural Areas: Provides services for those without certified volunteer helper, or with certified volunteer helper who does not have the capability to provide care services; those who are incapable; and those who have no sources of income. Services encompass meals, clothing, lodging, medical care and funeral services, in addition to entertainment and rehabilitation.
- Nursery for the Elderly: Provides short-term (day care, full care and contingency care) services, including lodging, entertainment, rehabilitation, and medical care services.
- Center of Service for the Elderly: Provides a comprehensive range of social services, including entertainment, rehabilitation, medical care and home visit services.

3. ASSISTANCE AND DESIGNS GEARED TO THE NEEDS OF CHINESE SENIORS

3.1 Senior assistance principles

3.1.1 Evolution of the concept of senior care

Ageing population has become an important social issue in both China and Hong Kong. Census data show that China is fast becoming an ageing society, and the trend will intensify in the first half of the 21st century. But with the advances in medical science and the improvement in the physiology of seniors, the definition of old age is becoming out of sync with the actual rate of physiological decline.

Old age is the final stage of a person's life when **physiological decline no longer allows the person to handle the demands of social activities**. While a person can live with complete independence in his youth, he will begin to need special care as he gets older. Therefore, old age demands **adjustments in one's lifestyle**. The normal work life gives way to a complete withdrawal from work into a lifestyle that requires assistance. In other words, a retirement lifestyle.

But this concept is beginning to veer from actual practice. China established the retirement age at between 50 to 60 (for special jobs, it could be as early as 45), which no longer matches the actual rate of physiological decline. The majority of retirees at age 50 to 60 are still bubbling with energy, and physically they can keep up with the younger set both in lifestyle and, to some extent, in work. This situation looks set to continue for 10 to 20 years.

Nowadays, many people who have just entered the old age bracket choose to continue to live at home, until they become incapable of looking after themselves, because traditional hostels and nursing homes tend to focus on the physiological decline in seniors, and overlook their social and psychological needs. In providing a certain degree of medical care, these establishments should also respond to these demands, so that seniors can live their life to the full independently in the post-retirement period which may last for 20 years.

3.1.2 The psychology and social needs of younger seniors

Like their younger counterparts, seniors have a host of psychological needs that must be satisfied, in addition to their basic survival needs. They include:

A sense of security and affection: They long for care and attention; they would like to live in a familiar environment where everything is agreeable, or at least bearable.

Social recognition: They look for respect from people that matter.

Personal values and dignity: They look for the ideal life.

Besides physiological decline due to ageing, the change in his social role also triggers a psychological impact on the senior. This is especially apparent in the early stage of ageing when the abrupt change in his social role causes discomfort. Retirement leads to a change in lifestyle and the loss of his old circle of friends, personal values and social status. The decline in physique and consciousness, and the reduction in income lead to a progressive decline in a sense of security. Other traumas in life, like the loss of spouse, also demand a transition period of adjustment.

Traditionally, senior care facilities focus on medical services without sufficient attention to psychological adjustments and care for the seniors. Accommodation-wise, we need to create a comfortable and secure living

environment for them. On a social level, we should ease them into a new chapter of their lives by maintaining as much as possible their pre-retirement social life. If we prematurely limit their new lifestyle and social circle to their contemporaries, or even older people, as practiced in most nursery homes, they would find it very hard to make the necessary adjustments. Senior care establishments should encourage them, health permitting, to at least maintain a part of their previous lifestyle, continue to work to a certain degree, and to actively participate in community activities.

3.1.3 Medical care

When a senior falls ill, its severity could vary by a wide margin, so the best way is to send him expeditiously to the nearest medical facility for treatment. A senior, no matter he is living by himself or with his family normally could not afford a 24-hour medical care service, so senior housing should aim at being able to send the patient to hospital within a specified time, and providing the doctor with accurate and detailed data.

A doctor from resident medial services of a local private hospital points out that when they treat emergency cases of seniors, the crux lies in early detection and in whether those who accompany the patient can accurately **determine its degree of seriousness. Doctor needs to know the patient's condition** to facilitate diagnosis and treatment. As time is of the essence, the trip to the emergency ward of the hospital must be as short as possible.

3.1.4 Domestic safety and convenience

Statistics shows that the majority of seniors who have had a domestic accident, such as slipping, would sustain a degree of injury. With their physiological decline, some of these injuries could cause serious harm, and it is often very difficult to recuperate. Therefore, domestic designs for seniors should take into account not only the convenience factor, but also the safety factor. The decline in physical capability means that seniors cannot independently deal with certain household chores, and require an appropriate level of assistance.

- Decline in memory and consciousness: Seniors are slow to react to changes in the domestic environment because of weakened sensory functions and memory, leading to accidents when they engage in day-to-day household matters and activities. Most younger seniors live alone, and even if they have company, they often perform certain functions by themselves, like taking a bath or going to the toilet. Therefore, there must be warning signs for any steps in the domestic environment. When accidents occur, such as a fire, an additional alarm system would minimize casualties.
- Decline in mobility: Seniors are physically not as strong as young people, and with ageing and/or illness, they would need a walking stick or wheelchair to facilitate movement. When there is insufficient support or the standing duration is too long, accidents will happen. Toilets equipped with railing support and anti-slippage designs will reduce the incidence of accidents.

3.2 Design strategy for senior housing

Ageing population has become a social problem that must be faced squarely in both China and Hong Kong. The composition of the senior population and the new trend of their health status mean that traditional senior care facilities lag far behind current needs, stretching into the next 50 years. The new generation of seniors are looking forward to a new model in senior care facilities, something that can provide assistance for 10 - 20 years of high-quality retirement living. Given proper assistance, seniors can maintain a lifestyle that is not vastly different from their youth. If their previously neglected psychological needs are met in addition to their physiological demands, **they can make a smooth transition to a more advanced stage of ageing. In response to seniors' multifarious needs,** housing designs can make specific adjustments to provide for a high-quality senior lifestyle.

3.2.1 Private and social space

The abrupt change in the social role after retirement often causes discomfort for seniors, so social activities can maintain their contact with society and the community, thereby easing the feeling of loneliness. Seniors also feel that the private space they enjoyed while they were young have now been reduced to a certain extent, because of the need for care and assistance due to their physiological decline. As long as their safety is in place, we should let them enjoy as much of their serene private space as possible. At the same time, we should, through the

provision of convenient space for social activities, meet their psychological desire for company or for participation in group activities (Figure 10).

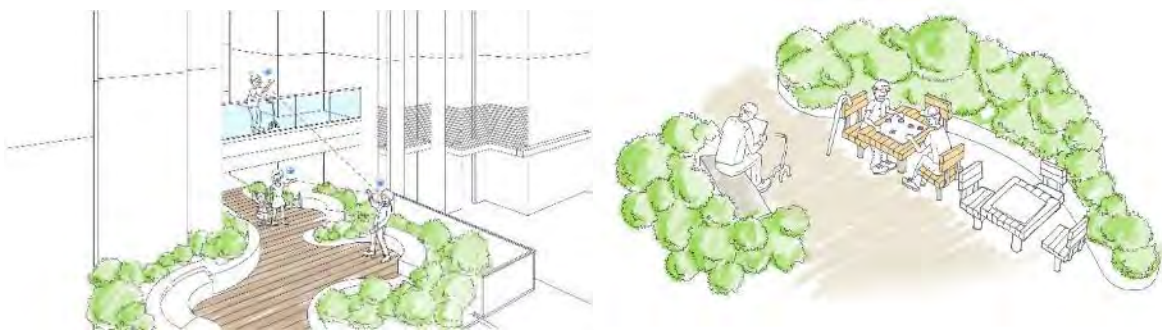

Figure 10: Social infrastructure and stimulation for establishing new friendships and interaction with peers

3.2.2 A comfortable and agreeable environment

Your submission must provide the details of the work to readers. It should be clearly divided into sections, with heading/ sub-headings, so that readers can follow the logical development of work. Using headings is a great way to organise the paper and to increase its readability, so make sure to format them correctly.

Seniors are comparatively more sensitive to environmental impacts such as noise and light pollution. The abrupt change in their social role and their ageing body have created a sense of insecurity, making them yearn for a comfortable and predictable living environment. If their building makes use of natural materials like timber, and opts for a warmer palette, they will nurture a more homey feel, and, at the same time, reduce the sensory impact and feeling of loneliness. Natural lights, ventilation and greenery not only improve the general hygiene indoors, but will also enhance the overall tranquillity and comfort level. Conditions permitting, we should let seniors come into contact with a green outdoors environment as much as possible (Figure 11).

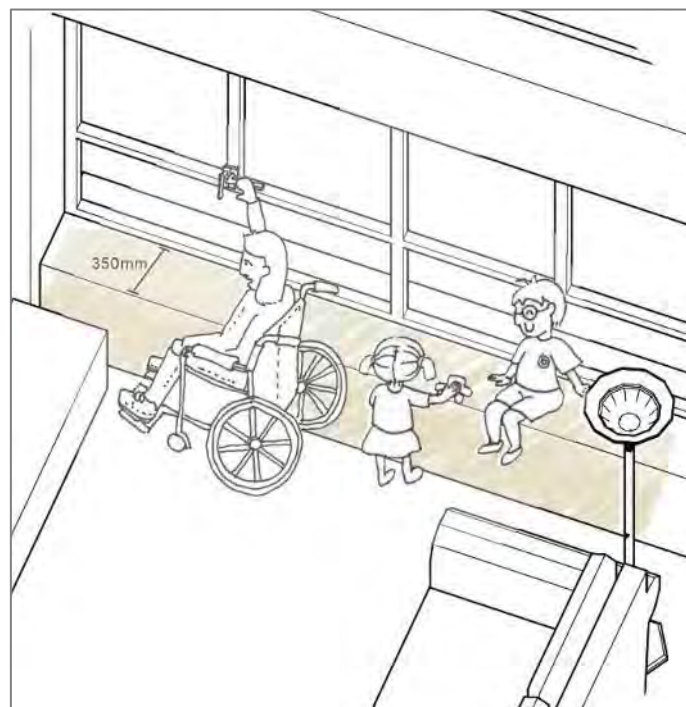

Figure 11: A shallow bay window and appropriate window designs would facilitate lighting and ventilation, and enables seniors to open/ close them more easily.

3.2.3 Prominent signage

To enable seniors to familiarize with their living environment and understand any changes, both interior and exterior signage should be bold and clear. For example, each floor level and emergency exits should be marked in bigger fonts and in strong colours, so that those with poor eyesight can easily read them (Figure 12). The front door peep-hole should be installed at both standing and wheelchair levels, so that seniors can identify visitors at various stages of their mobility (Figure 13). Corridors and partitions should be installed with built-in night lights, so that seniors do not have to grope for the light switch; and they should be soft enough as not to affect sleep. Other safety installations, like smoke sensors and fire alarms, should be set at levels that are visible to wheelchair users.



Figure 12: Seniors will be able to read the signage more easily if it is in bigger fonts and stronger colours

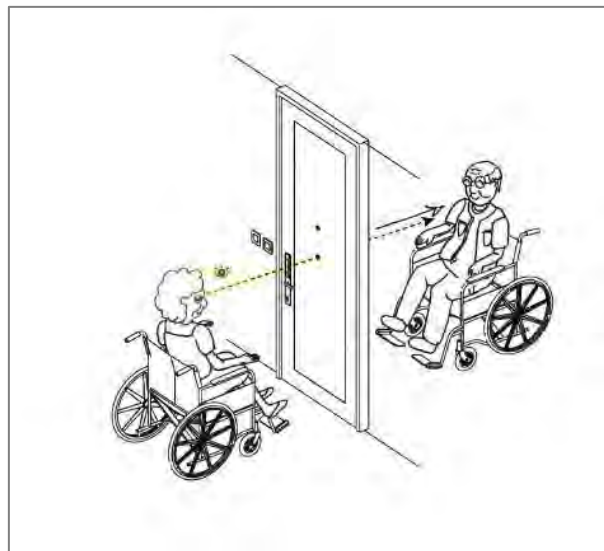

Figure 13: Peep-holes in front doors should be installed at both standing and wheelchair levels.

3.2.4 Smooth emergency passage

Your submission must provide the details of the work to readers. It should be clearly divided into sections, with heading / sub-headings, so that readers can follow the logical development of work. Using headings is a great way to organise the paper and to increase its readability, so make sure to format them correctly.

Accidents and sudden illness could have very serious impact on seniors, and they must receive prompt medical attention. Therefore, the trip from home to the hospital should be as short as possible. Senior homes must be so **designed as to enable the early detection of sudden changes in the senior's health. Seniors who live by themselves** or in private rooms should install a motion detector, so that if there is no movement for an extended period due to illness, his family can be alerted as early as possible.

In private spaces like the bathroom or the toilet, they should install sliding doors that can be opened in emergencies, to facilitate entry without hitting the senior who may have fallen or fainted (Figure 14). In order that patients may reach the hospital as soon as possible in emergencies, senior housing should be sited close to medical facilities with pre-determined transport routing and arrangements. There should also be provisions for ambulance loading/unloading. The lobby and lifts in the building must be able to accommodate mobile beds or stretchers, so that whether lying or in wheelchair, the senior who needs urgent medical attention can directly access the ambulance (Figure 15).

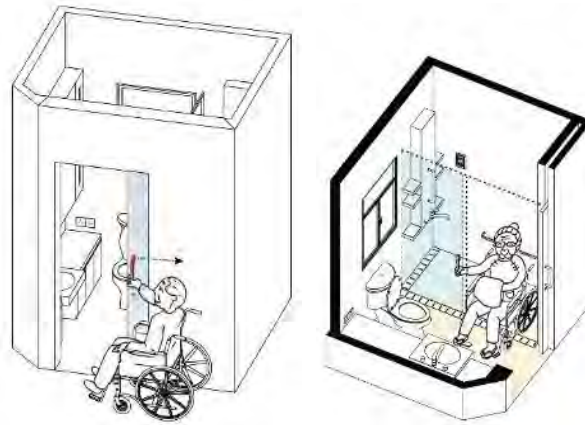

Figure 14: Bathrooms and toilets should install sliding doors that can be opened in emergencies.

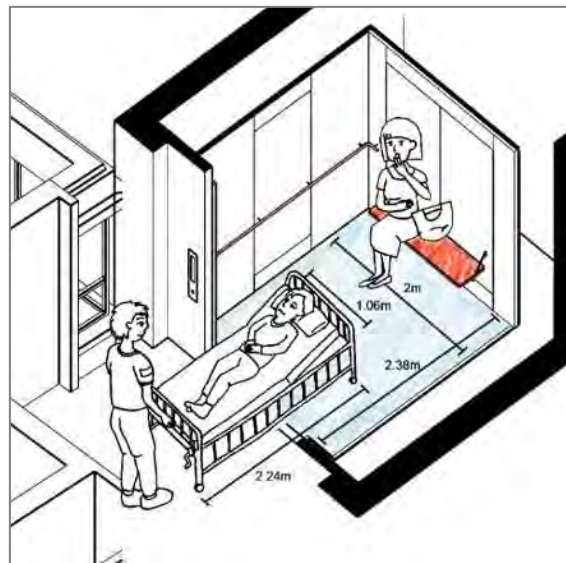

Figure 15: Lifts that can accommodate mobile beds.

3.2.5 Convenience and safety considerations

Senior housing should be designed to assist occupants in their daily lives so that, despite their physiological decline, they can still conveniently accomplish a majority of household tasks free of accidents. Owing to their failing physique, seniors often require additional assistance and support. Therefore, corridors should be installed with railings that seniors can avail of, whether standing or in wheelchairs. The same principle applies to public spaces, including lifts and passageways (Figure 16).

There could be provisions for a bench in lifts for tired legs to minimize the danger of falling due to weakness or movements. As some physically handicapped seniors may need a wheelchair on a short-term or long-term basis, building designs should cater to their special needs, for example, lowering the height of furniture. Kitchen benchtops should be lowered by 0.8 meters, and microwave and cupboards should be installed below 1.3 meters (Figure 17).

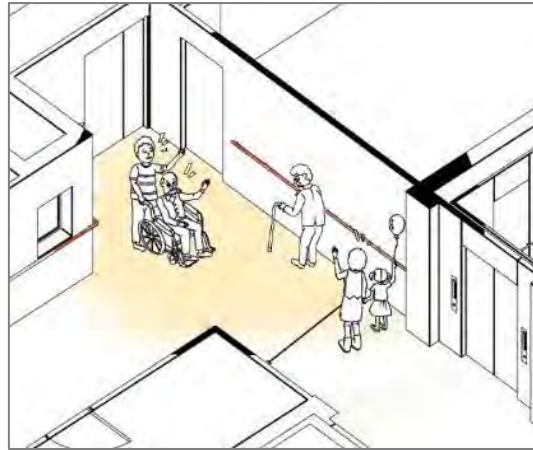

Figure 16: Public spaces should install support railings.



Figure 17: Household designs that cater to wheelchair users.

3.3 Senior housing development in a high-density city environment

China's ageing population has created a heavy demand for senior housing that meets their specific needs. To meet this rising trend, different countries are exploring a variety of options. In the Asian region, a senior care community model that adapts to a high-density city environment is probably the answer. This model should be based on a 'family first' concept, and re-create the living environment of a traditional family mansion in the spatial context of a high-density city environment.

China's cultural tradition has always been based on the family and its close relationships as the bedrock of society, with the older generation enjoying a lofty position in the hierarchy. This characteristic is reflected in China's traditional housing designed for extended family living together. A typical example is seen in the rectangular garden mansions (Si He Yuan 四合院) commonly seen in northern China, where family elders live in the main house, and the younger generations live in the subordinate blocks, creating a central open compound for family bonding and communal activities. Different generation members look after one another, providing spiritual support and nurturing a sense of belonging among their members.

The Chinese society has, over time, undergone modernization. As more and more people congregate in the cities, the urbanization process has ushered in high-density cities as major hubs of habitation, and traditional family mansions have been replaced by units stacked vertically on top of one another. The old extended family concept has evolved into individual families creating their own nucleus of living, posing a threat to traditional family values. As a result, seniors not only face new difficulties with their physiological decline, but also a loss of spiritual and physical support and sense of belonging, because of the separation with their children in their habitation. This situation is even more pronounced in high-density Hong Kong and in China's other major cities.

However, this traditional practice of extended family living and respect for elders runs deep in Chinese culture, and most families are still prepared to share the load of looking after the older generation. We may be able to solve the problem of senior care brought about by ageing population through the study of two approaches in spatial utilization in a high-density city:

3.3.1 Vertical 'generational integration' model

In a multi-storeyed, high-density development, the building can be divided into zones on a vertical basis. The lower-level zone is devoted to senior hostels, with special provisions in the design to meet their needs, while the higher-level zone is made up of normal apartments, together with related communal facilities. This configuration allows members of an extended family to live in different zones of the same building. Each generation has its own private space, but can maintain communication and meet in communal spaces. It is, in reality, the remake of the traditional garden mansion in a vertical mode.

3.3.2 A consolidated model with diversified lodgings

A second approach features a small community that comprises a diversity of lodgings to suit different families. Seniors would live in low-rise terrace houses/units, while the younger generation would live in adjacent high-rise blocks because of their smaller number of family numbers. The two types of lodgings would share the same outlook and communal facilities. It is, in essence, a modern version of extended family living which promotes inter-generation interaction and mutual care.

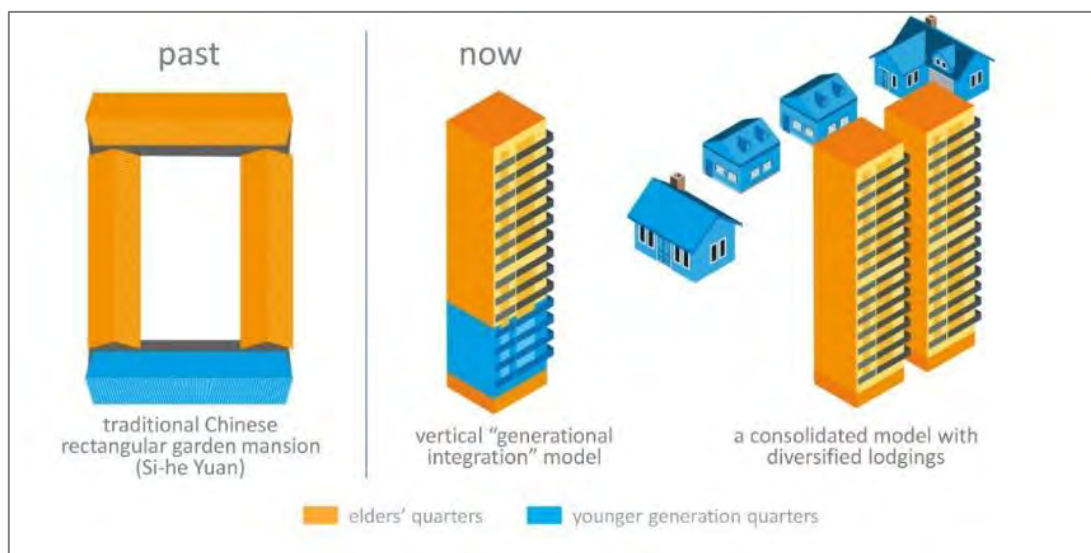

Figure 18: Harmony living in Asia

3.4 Case studies

3.4.1 Vertical 'generational integration' model

Located in Shau Kei Wan on Hong Kong Island, Harmony Place is an urban renewal project completed in 2015. It comprises a multi-function block and a 42-storey residential block. The project aims to promote a senior care mode with the senior living close to other family members, and addresses the current trend of ageing population. About 30% of the development is made up of senior apartments for lease, while the rest are private residential units for sale (Figure 19). Residential unit owners have priority in leasing the lower-level apartments for elders in the family, so that seniors and their family members each have their own private space, and are close to each other. The multi-function block is designed with seniors in mind, and comprises retail shops, clinics and senior service centres.

Generational integration design aims to encourage younger family members to live with the older generation, and provides support to seniors suffering from physiological decline. Although retirees these

days are physically much fitter than previously, improvements in the finer details of interior design would lift their quality of life. More importantly, a number of ancillary medical facilities and household services, like clinics, can provide basic medical services to seniors from their retirement to a more advanced hostel-bound stage of their old age, a period that could span nearly 20 years.

A senior hostel obviates the need for a senior who lives in an ordinary apartment to make a move to a nursing home as he grows older and suffers from physiological decline. The older one gets, the lower the ability to adapt to new circumstances. The abrupt change in the living environment impacts heavily on seniors both physically and psychologically. Senior hostels have adequate basic facilities which can be adjusted to meet changing needs, enabling seniors to continue living in a familiar and caring environment for as long as possible. It is a blessing for both the senior and his family members.

Generational integration also dovetails with the new trend of an extended retirement life and a new breed of healthier and more agile seniors. It not only effectively looks after their health, but also provides private space for both parties in spite of their physical closeness. This mode of living largely maintains their original lifestyle, including family gatherings, reunion with friends, and to a certain extent their previous **work. Therefore, it meets the seniors' two psychological needs: the care of family and friends, and their social status and recognition.** Living close to family members in a semi-independent mode can effectively alleviate the feeling of loneliness, and of isolation from society due to retirement.



Figure 19: The generational integration design of Harmony Place comprises lower-level senior hostel for lease, and higher-level private residential units for sale.

3.4.2 Thoughtful interior designs: The Tanner Hill

Your submission must provide the details of the work to readers. It should be clearly divided into sections, with heading/ sub-headings, so that readers can follow the logical development of work. Using headings is a great way to organise the paper and to increase its readability, so make sure to format them correctly.

Located in North Point on Hong Kong Island, The Tanner Hill comprises two 24-storey towers and a 29-storey tower, offering a total of 588 units that range from 344 sq ft to 1,231 sq ft. The lower-level podium comprises the **residents' clubhouse and medical services centre that offers entertainment and** medical services respectively. There is also a day-care centre, a cognitive training centre and a nursing home, providing rehabilitation treatments, plus day care and 24-hour care as needed.

The residential units have been designed with seniors in mind, and incorporate many detailed considerations. The unit entrance is deliberately wide and free of doorsteps. The front door is fitted with a U-shaped handle at an appropriate level, as well as two peep-holes at two levels. The interior signage and alarm systems have taken into account the decline in sensory sensitivity of seniors. Therefore, the fire alarm adopts an audio-visual approach to enable hearing or sight impaired seniors to detect such mishaps as early as possible. All rooms and corridors are installed with night lights so that seniors can find their way with ease; and there are stripe designs on the sliding door of the shower.

As seniors grow older, some of them may have to resort to wheelchairs, therefore the positioning and measurements of furniture and fittings in bathrooms and toilets have been adjusted in accordance with the height of wheelchair users (Figure 20). Cabinets in the open kitchen and specified bathrooms are movable for their convenience. Kitchen amenities have also been adjusted so that they can easily manage, while the shower sliding door can be replaced with shower curtains. All light switches and sockets have been enlarged and conveniently positioned. For the sake of safety, interiors, and especially the bathroom and showers, are equipped with emergency call buttons.



Figure 20: Kitchen cabinets and benchtop have been adjusted to suit wheelchair users.

The interior design concepts are extended to the exterior public places. For example, there are clear signage and alarm systems. Each floor level is clearly labelled in bigger-than-average fonts to help residents identify their own abode (Figure 21). The lift lobby, the lift interiors and corridors are all fitted with support hand railings at an appropriate height; and the lifts all feature seating for those weak on their feet. To prevent slipping, the floors feature anti-slippage designs.

Another important consideration in the design of public open space is to ensure that ambulances can arrive at the scene promptly in the event of accidents or other unforeseen circumstances. After the application of first aid, they must be able to transport the patient to the hospital as quickly as possible. The crux lies in the design of the lifts, the residential unit and the lobby of the building. The Tanner Hill has made provisions for special jumbo lifts that can accommodate stretchers or mobile beds. In the event of an emergency, the senior patient can be transported in these lifts directly to the ambulance with a minimum of delay.



Figure 21: The Tanner Hill features clear level signage and appropriately positioned lift buttons.



Figure 22: The Tanner Hill provides extra common areas for leisure and social gathering.

REFERENCES

- [1] Chellis, Robert D., Paul John Grayson, and Symposium Farnsworth Trust. *Life Care: A Long-Term Solution?* Lexington, Mass.: Lexington Books, 1990.
- [2] Coulmas, Florian. *Population Decline and Ageing in Japan: The Social Consequences*. London; New York: Routledge, 2007.
- [3] Division, United Nations Department of Economic and Social Affairs/Population. *World Population Prospects: The 2015 Revision, Key Findings and Advance Tables*. New York: United Nations, 2015.
- [4] *Hong Kong Population Projections 2015-2064*, Census and Statistics Department, The Government of the Hong Kong Special administrative Region, 2015.
- [5] United Nations University, and WHO Kobe Centre. "The Wisdom Years: Ageing into the 21st Century." <http://wisdom.unu.edu/en/ageing-societies/index.html>.
- [6] 中華人民共和國民政部社會福利和社會事務司 “老年人社會福利機構基本規範” 北京：中華人民共和國民政部，2000.
- [7] 張瑩 “日本介護保險制度中老年長期護理分級標準研究” *中國全科醫學*，第 14 卷，第 8 期，2011: 2544-2545 頁.
- [8] 杜鵬，翟振武，陳衛 “中國人口老齡化百年發展趨勢” *人口研究*，第 29 卷，第 6 期，2005: 90-93 頁.
- [9] 許巖麗，劉志軍 “澳大利亞老年保健服務現況分析及其對我國的啟示” *醫學與哲學（人文社會醫學版）*，第 29 卷，第 8 期，2008: 68-70 頁.

Occupant-Related Energy Use: a Qatar Office Case Study

Chimay J. ANUMBA^a, Yewande ABRAHAM^b, Zhidan ZHAO^c, Somayeh ASADI^d

^a University of Florida, United States of America, anumba@ufl.edu

^b Pennsylvania State University, United States of America, ysa104@psu.edu

^c QEERI, United Arab Emirates, zzhao@qf.org.qa

^d Pennsylvania State University, United States of America, asadi@enr.psu.edu

ABSTRACT

Accounting for human behaviour while striving to improve energy efficiency has been brought to the fore in recent studies since occupant behaviour impacts energy use in buildings. Maintaining occupant satisfaction with indoor environmental conditions can promote their wellbeing and productivity especially in office buildings. In order to improve efficiency and maintain occupant satisfaction indoors, it is important to capture actual occupant-energy-related behaviour and occupant preferences in buildings. Some of the parameters that influence occupant behaviour indoors are the environmental conditions such as the ambient temperature, lighting levels, and air quality.

Preliminary results obtained from monitoring an office building in Qatar are presented. This study seeks to capture **occupants' indoor preferences and behaviours to give an insight into how they impact energy use or may be** impacted by the indoor conditions. To achieve this, measurements of energy use (lighting, plug load devices, space conditioning), indoor environmental parameters and occupant feedback (satisfaction, preferences, behaviour) are collected using a combination of approaches including sensors, power meters and surveys. The preliminary findings show that the occupants took action to improve their comfort with the temperature and airflow. The highest energy consumption was when the building was not fully occupied which could provide an opportunity to improve the building operation and achieve energy savings while taking into account occupant needs, preferences and behaviour. Observations made regarding the lighting use pattern are also highlighted. It is intended that this study will provide an important contribution to understanding building occupant behaviour in a hot climate region like Qatar.

Keywords: indoor environmental conditions, occupant behaviour, building energy monitoring

1. INTRODUCTION

Sustainable high performance building strategies have been increasingly adopted by various countries as the building sector seeks to improve efficient use of resources. Due to the high environmental impact and the amount of energy consumed by this growing sector, there is an increasing need to ensure the environmental footprint is minimized by ensuring new buildings are energy efficient, improving existing building performance, using renewable energy sources and identifying and cutting down areas of wastage. Statistics from different countries emphasise the need to conserve energy. The US, for instance, is one of the top energy consumers in the world even though it is about one-fourth the population of China, about 40% of US energy is used by the building sector. In Hong Kong, about 90% of the electricity produced is consumed by the building sector (The Energy Efficiency Office, 2016). Qatar is a very small country in the Gulf region and one of the top crude oil producers in the world. It has the highest GDP per capita in the world and one of the top energy consumptions per capita in the world with growing electricity and energy demand (EIA, 2015) as technological advances and population increase. The building sector needs to continuously make efforts to improve its energy conservation efforts.

The main drivers for energy monitoring and energy use measurements are the need to mitigate climate change, to comply with legislation and better understand how energy is used in buildings to improve performance (Ahmad, Mourshed, Mundow, Sisinni, & Rezgui, 2016). While reducing building energy consumption, the industry has begun to recognize the need to ensure occupants have an environment that is conducive and promotes their health and productivity. People could also impact the way energy is used in a building through their behaviour. As various countries strive to meet the energy reduction targets, the needs of the occupants should be taken into consideration. In order to assess and better quantify the impact of people on buildings and be able to provide preferred indoor conditions, their needs and preferences including their actions should be captured. Energy simulation tools oversimplify their representation of occupants and do not properly account for their behaviour.

This study investigates energy consumption, indoor environmental conditions and occupant behaviour in an office building in Qatar. Qatar has a dry subtropical desert climate and also experiences high temperatures in the summer (around 40°C) and cooler winters (around 15-25°C) (WeatherOnline, 2017). There are a number of strategies in place to ensure resource conservation in Qatar buildings such as imposing fines for wasting water, leaving exterior lights on during the day, promoting the culture of energy conservation (Meier, Darwish, & Sabeeh, 2013). In order to capture different occupant-related characteristics, values, preferences and behaviour indoors, experimental approach using sensors, metering devices and a survey application for the occupants to provide their feedback on the indoor conditions and their level of satisfaction with the indoor environment are used. The indoor environmental monitoring includes temperature, relative humidity, air quality, and light intensity measurements, sub metered energy use for the lighting, plug loads and space conditioning, and occupant behaviour and satisfaction tracking through sensors and a Preference Monitoring Application (PMA) survey that was administered to the occupants. The study could provide an insight into occupant-related energy use and occupant preferences in an office. Preliminary results from the study are presented focusing on a few of the parameters.

2. BUILDING ENERGY USE AND OCCUPANT FACTORS

Occupants should be accounted for as energy efficiency strategies are implemented in buildings since people majority of their time indoors. Identifying the needs of the occupants and their energy use habits can help with providing preferred indoor conditions and reducing energy wastage associated with individual efforts to improve their comfort. Studies have suggested that occupant behaviour can significantly increase energy consumption by about 90% (Hong & Lin, Occupant Behavior: Impact on Energy Use of Private Offices, 2012). Investigating energy use behaviour can help with identifying the wasteful habits and possibly encourage a change in behaviour through education or other indirect means such as providing access to energy use information through dashboards.

Data collection techniques for building energy monitoring were explored by (Hong, Taylor-Lange, D'Oca, Yan, & Corginatti, 2016). Buildings are different and identical buildings sometimes exhibit different energy consumption patterns, using a context-aware approach enables the actual building characteristics to be captured, though the results may not be generalised or directly applicable to other office buildings but there are lessons that can be learned and applied to a larger number of buildings. There are very limited studies on building energy consumption and occupant-related factors in Qatar. About 80% of the energy use in buildings in Qatar is for air conditioning (Meier, Darwish, & Sabeeh, 2013).

Studies have addressed occupant values (what they consider is of importance) and mentioned their effect on the indoor environment. The values are thermal comfort (temperature and humidity), lighting/ visual comfort (light intensity), indoor air quality (airflow/ ventilation), perceived health and personal productivity. Hong, et al. (2016) mentioned the parameters needed for occupant behaviour studies have been discussed. Human behaviour is dynamic so gaining better understanding could give a better understanding of their preferences and behaviour indoors. Occupants engage in adaptive or non-adaptive behaviour indoors. They could adapt the environment to their needs like adjusting thermostats or adapt to the environment by wearing additional clothing.

Actual occupant-related energy use data is beneficial to improve estimates from building energy simulation tools. Machine learning algorithms could also be used to learn occupant behaviour and predict their needs and provide preferred indoor conditions that minimize energy wastage.

3. METHODOLOGY

An academic office building located in Doha, Qatar was selected for the case study due to its availability and the willingness of the occupants (professors and instructors at the college) to participate in the study.

3.1 Building characteristics

On average the occupants spend about 20 hours in the office since most of their tasks involves teaching. Additional information about the building is presented in Table 1. All the occupants are in private offices and are able to control their thermostats within 6°C (18-24°C). The building has an automation system that controls the whole ventilation and air conditioning system, which is a single variable air volume (VAV) system.

Building Type	Medium-sized office
Year of Construction	2005
Size	680 m ² (zone monitored)
Number of Floors	2 (ground floor, west zone monitored)
Climate	Subtropical dry hot desert climate
Cooling System	Single variable air volume system
Energy Source	Electricity
Power Distribution	Three-phase
No of Occupants	22 in the zone monitored

Table 10: Case study building characteristics

3.2 Instrumentation

The monitored zone in the office building is presented in

Figure 53. Each room has a temperature and relative humidity sensor. Three air handling units serve the zone and each one has an air quality sensor. Ten illuminance sensors were installed in 10 of the 22 offices in the zone the selected rooms represent different areas of the office namely the interior offices at the core, and a few offices at the perimeter of the building with access to daylighting and some with interior shading devices and others without shading. There is also shading on the exterior of the building (

Figure 53). The sensors were also placed based on whether the occupants were interested in taking part in the study.



Figure 53: Floor plan and exterior of case study building

The set point temperature varies for each office and is between 18 and 26°C. Occupants can control the lights manually to turn them on and off. **The sensors were placed close to the occupants' working spaces on their desk**

Figure 54. The illuminance sensor measures light intensity as seen by the human eye. The energy use by three major end use categories- lighting, plug loads and space conditioning are considered. The lighting and HVAC energy consumption are measured with power meters while the plug loads are measured virtually. The sensors were tested and calibrated before they were installed.

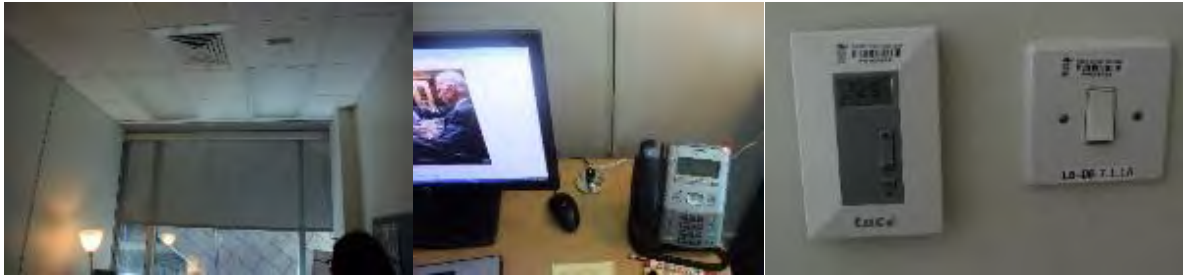

Figure 54: Office interior, illuminance sensor placement and thermostat and lighting controls

Occupant satisfaction with the thermal (temperature and airflow) conditions, lighting and indoor air quality are monitored through the Preference Monitoring Application (PMA) which is a survey provided to them which can be completed daily and is accessible on mobile devices and computers. It is a 3-5 minute survey for occupants to provide feedback on their perception of the indoor environment, their satisfaction and actions related to energy use.

The indoor conditions and energy use measurements are monitored with sensors and stored in the data acquisition system. The data is retrieved from the vista workstation on-site every other week to check the quality of the data and ensure there are no technical problems. Remote access to the workstation was not granted due to security concerns. Information on outdoor weather conditions are collected from local weather stations some of which are available online. Occupant feedback is retrieved online. The study is still ongoing and the total duration is for one year.

4. RESULTS

Preliminary results from the case study are presented in this section. The monthly energy consumption for major end use categories show that the energy use for space conditioning was the highest which is attributed to air conditioning accounting for over 75% of energy consumption monthly (Figure 55).

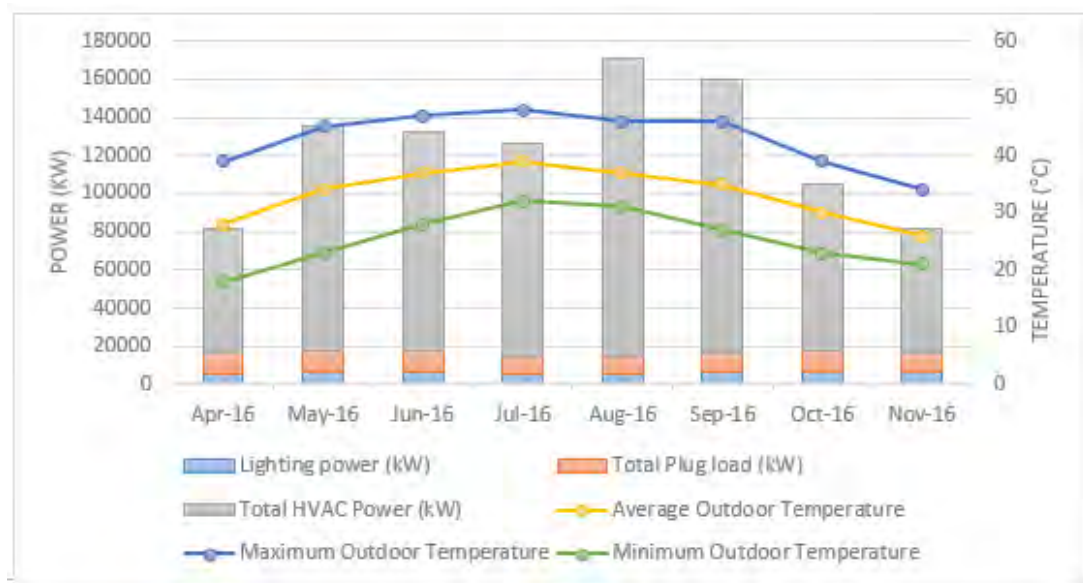

Figure 55: Monthly power demand and average outdoor weather

The peak temperature from April to November 2016 was about 48°C in July. The building was partly occupied in June, unoccupied in July and unoccupied for most of August due to the extremely high temperatures and the college being closed for the summer holidays. The peak average temperature was about 40°C in July while the peak overall power consumed in August (Figure 55). The minimum power measured was in April and November which were not as hot as the average temperature in July.

The response on the PMA surveys from April to October are presented in Figure 56 below, 343 responses were collected from 14 occupants over that period. The feedback rates from the occupants vary from daily to weekly depending on how often they choose to respond.

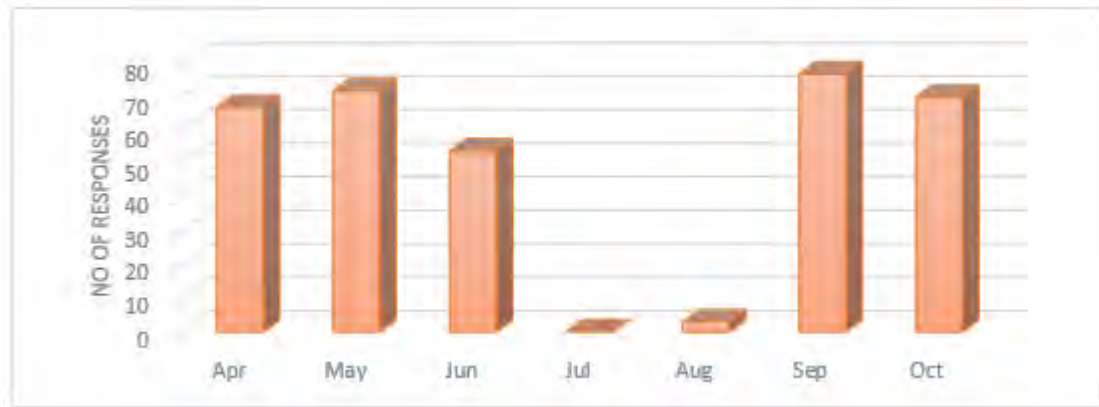

Figure 56: Monthly responses from occupants

A few parameters were considered from the feedback of the occupants. Figure 5 shows that they were mostly satisfied with the lighting, and indoor air quality. They were moderately unsatisfied with the thermal comfort. They took more action on their temperature and airflow than on the lighting levels as seen in Table 2 below.

	Took no action (%)	Took action (%)
Temperature	33.4	66.6
Humidity	100	0
Airflow	42.2	57.8
Lighting	61.1	38.9

Table 11: Response on Actions

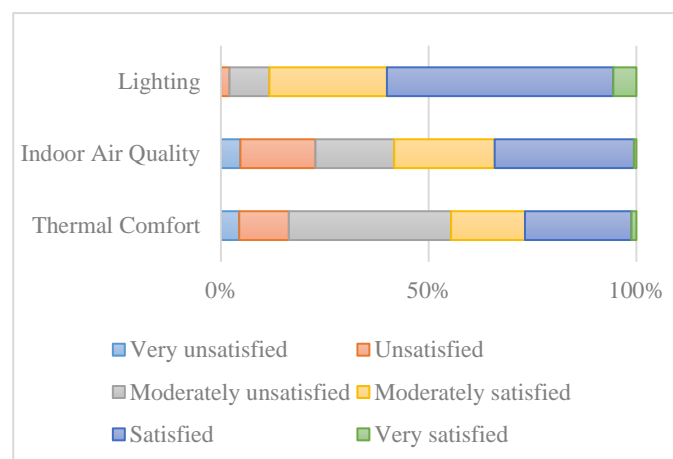

Figure 57: Satisfaction with indoor environmental parameters

Focusing on the occupants' perception of lighting, most of the time, they felt neutral about the lighting but a few other times they felt it was slightly bright (Figure 58).

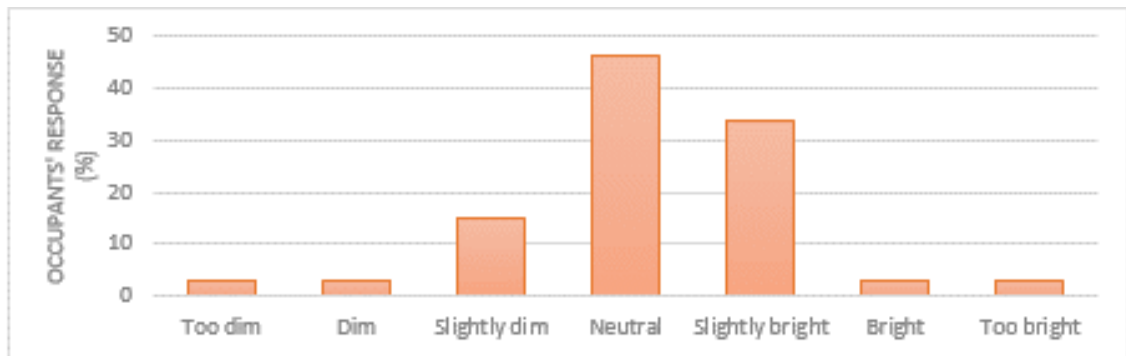

Figure 58: Occupants' response on their perception of lighting indoors

From Figure 8, we observe a strong correlation between the illuminance levels and the lighting energy consumption which is expected. The average illuminance of the 10 rooms was plotted against the overall lighting energy consumption over a working day in April (Figure 7) which also showed a close correlation even though not all the rooms have sensors installed but the rooms selected seem representative of the entire zone.

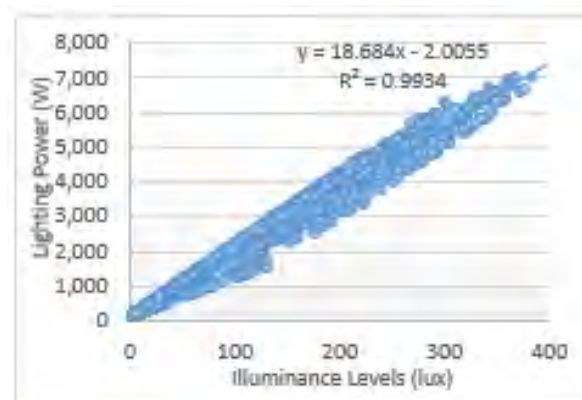

Figure 59: Lighting profile from a working day

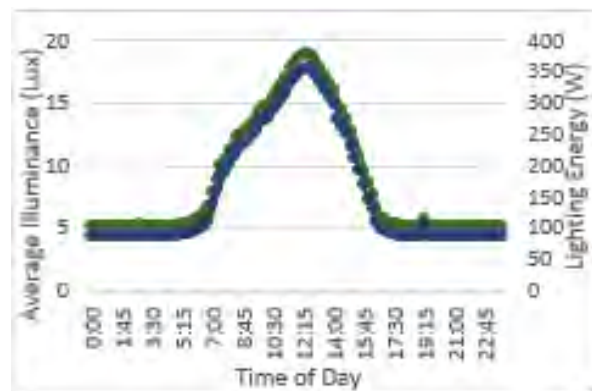

Figure 60: Lighting power vs average illuminance (April- November 2016)

The illuminance by natural daylighting was not separated from that by artificial lighting since the sensors measure how a human perceives light, this might introduce some errors. Overall, the occupants seem more satisfied with the lighting levels than with thermal comfort and indoor air quality.

5. DISCUSSION

July was the hottest month but August had the highest energy consumption overall. Energy consumption was lower in some of the hottest months since the building was unoccupied but it was still cooled for the equipment in the offices. The most obviously fluctuating energy use category is for space conditioning, which was the highest in

August perhaps because people were returning to work in the extremely hot weather and their cooling demand increased.

The strong correlation between the illuminance levels and the lighting energy measurements could indicate that natural lighting has very little contribution to their interior lighting which could be because of the associated heat gain through the large windows. Also since they felt the lighting was too bright at times, it could be reduced to achieve energy savings due to the strong correlation between the illuminance level and lighting energy while also maintaining satisfaction levels. Some offices had additional plug-in lamps without the room lights to dim the environment, these may increase the illuminance but the energy use is measured as plug loads but this does not seem to adversely affect the results since only a few of the offices use the lamps. The illuminance measurements **also closely reflect the occupancy patterns and the occupant's lighting use.**

6. CONCLUSION

Occupants should be considered in energy efficiency improvements since their behaviour can impact energy consumption. Gaining an insight into not only the energy consumption but also the indoor environment conditions and the occupant behaviour and can bring into focus how occupants impact energy use in buildings and help to identify areas for energy improvements while maintaining occupant satisfaction using actual energy use data. The paper covered some aspects of an ongoing energy monitoring project in an office building in Doha, Qatar. The PMA provides more insight into occupant behaviour, preferences and their satisfaction indoors. The indoor measurements and the energy use measurements also display the building energy use profile. This is still a preliminary analysis of a portion of the results since the study is still ongoing. A more robust analysis will be completed for conclusive findings while translating occupant factors to be included in analysis to predict energy consumption.

ACKNOWLEDGMENTS

The authors acknowledge the support of Qatar National Research Fund (QNRF), a member of Qatar Foundation (Grant No. 6-1370-2-552). We will also like to thank Ke Xu for his advice on the instrumentation and the building owners and occupants for providing access to their buildings and for their help with this study.

REFERENCES

- [1] Ahmad, M. W. et al., 2016. Building Energy Metering and Environmental Monitoring – A State-of-the-Art Review and Directions for Future Research. *Energy and Buildings*, pp. 85-102.
- [2] EIA, 2015. Qatar: International Energy Data and Analysis. [Online] Available at: <https://www.eia.gov/beta/international/analysis.cfm?iso=QAT> [Accessed 6 February 2017].
- [3] Hong, T. & Lin, H.-W., 2012. 'Occupant Behavior: Impact on Energy Use of Private Offices', paper presented at the International Building Performance Simulation Association Conference, Shanghai, 25-27 November.
- [4] Hong, T. et al., 2016. Advances in Research and Applications of Energy-Related Occupant Behavior in Buildings. *Energy and Buildings*, pp. 694-702.
- [5] Meier, A., Darwish, M. & Sabeeh, S., 2013. Complexities of Saving Energy in Qatar. France, ECEEE.
- [6] The Energy Efficiency Office, 2016. 2016 Hong Kong Energy End-Use Data, Kowloon Bay: The Energy Efficiency Office.
- [7] WeatherOnline, 2017. WeatherOnline. [Online] Available at: <http://www.weatheronline.co.uk/reports/climate/Qatar.htm> [Retrieved on 6 February 2017].

Purifying City Air in Densely Urban Environment

Jimmy CK TONG^a, David W.L. NG^b, Vincent S.Y. CHENG^c, Ricky Y.C. TSUI^d

^a Arup, Hong Kong SAR, jimmy.tong@arup.com

^b Sino Green, Hong Kong SAR, davidng@sino.com

^c Arup, Hong Kong SAR, vincent.cheng@arup.com

^d Arup, Hong Kong SAR, ricky.tsui@arup.com

ABSTRACT

Worsening air pollution poses a large and growing public health problem. More than 80% of people currently live in urban areas with air quality levels that exceed WHO particulate matter (PM) concentration limits. They are subjected to a higher risk of cardiac arrests, peripheral vascular disease (PVD), lung cancer, respiratory diseases, and asthma. Poor air quality is mainly caused by rapid urbanisation and industrialisation, which require high energy consumption and transportation flow. Air pollutants are emitted from power plants and vehicles, and are trapped in the built environment, to which people on the street are exposed all the time.

In view of the pressing need to combat roadside air pollution, Arup and Sino Green have developed a novel, patented system called the City Air Purification System (CAPS) that won the second prize of the Construction Industry Council (CIC) Innovation Award 2015. The prototype, a stand-alone system with a ventilation system that filters out pollutants and purifies air for pedestrians in proximity to the system, has been tested in Hong Kong and Beijing and has effectively reduced air pollutant (PM_{2.5} and PM₁₀) concentration within the system by 30% to 70% under various ambient conditions. This paper focuses on the simulations and analysis showing the improvement of roadside air quality resulting from CAPS when it is incorporated into buildings located in a busy district in Hong Kong.

Keywords: air pollution, purification, roadside health, public transportation

1. INTRODUCTION

In many Asian cities, pollutants emitted from vehicles permeate through the crowded city roads, poor air quality has become a threat to pedestrians or roadside stores. Air pollutants emitted from vehicles in densely-built cities such as Hong Kong, where streets are narrow and bounded between high-rise buildings, cannot be naturally circulated and diffused to the atmosphere; instead, they accumulate at the bottom of the street due to the Street Canyon Effect. This poses health problems to urban residents using nearby pedestrian walkways. Chinese cities like Beijing and Shanghai share similar difficulties in maintaining acceptable air quality level on the street. On a high-pollution day in Beijing, the roadside monitor could record over 600 Air Quality Index (AQI), which is twice the index level considered hazardous to human health. In the 2016 Environmental Performance Index (EPI) developed by Yale University and Columbia University, China, India, Myanmar, South Korea, and Vietnam ranked 170-179 out of 180 countries in the air quality category. Other than pollutants emitted from vehicles, smoke coming out from chimneys of coal power plants and factories worsen air quality by raising the ambient pollution level. If the layer of heavy pollution and the ambient pollution level are not treated and continue accumulating, the risk of respiratory disease of pedestrians would increase.

The main purpose of the CAPS innovation is to develop a solution that could mitigate major air ventilation difficulties in urban areas with the Street Canyon Effect, and to study the feasibility of different roadside ventilation systems for improving roadside air quality.

1.1. Street canyon effect in built environment

One main difficulty in ensuring natural ventilation in urban areas is the massive number of high-rise buildings on narrow streets and roads. Pollutants emitted by heavy traffic do not have sufficient energy to rise up to high altitudes to escape the containment of surrounding buildings. As a result, air quality worsens as pollutants like particulate matters and nitrogen oxides accumulate at the pedestrian level of the street canyon. The geometry of the street canyon, along with the wind direction and wind speed, are the major parameters that affect the air **pollution's dispersion** in the area. In a dense and compact cosmopolitan city like Hong Kong with population of

over 7 million, the aspect ratio between the building height and the street width ranges from 3 to number larger than 10. A study showed that an increase of 30% to 80% on the retention time of pollutants in the street canyon was due to the air ventilation impact from the high-rise buildings and its 'wall effect'. **The air pollution problem in a mega city like Beijing with a population of over 16 million, which has an aspect ratio of 2 to 4.5, is also affected by the effect. Beijing's building development is comparatively less compact, but it faces more severe ambient air pollution in general.** Hong Kong and Beijing have different characteristics in terms of city development and environmental conditions, but both are affected by air pollution due to the Street Canyon Effect.



Figure 1: A Typical street canyon in an urban area

Street Canyon Effect, as shown in Figure 1, represents the inability of normal wind channel to flow into and ventilate the road and the formation of a primary vortex of wind circulating inside the area between buildings. Both characteristics of the Street Canyon Effect reduce the chance for pollutants to escape; as a result, they accumulate to a hazardous level of concentration, which is harmful to human health. Over-exposure to highly polluted air would lead to a greater risk of allergies and respiratory diseases.

2. CITY AIR PURIFICATION SYSTEM (CAPS)

2.1 Engineering design

To mitigate the immediate and pressing air pollution problem due to the Street Canyon Effect in cities like Hong Kong and Beijing, Arup and Sino Green developed a patented innovation called the City Air Purification System (CAPS). Since its debut in March 2015, CAPS has gained attention from international and professional media, including: Forbes, Bloomberg, The Guardian, China Daily, Architect Magazine and Global Construction Review. The main goal of the innovation is to provide purified air for pedestrians through a ventilation system that filters out pollutants and generates cleaner air in proximity to the system.



Figure 2: City air purification system (CAPS)

The innovation, illustrated in Figure 2, was designed with fluid mechanic principles so that it could build up an air curtain and a positive pressure to create a cleaner environment. The polluted air is drawn into CAPS at a low level, which is then filtered and recirculated to improve the air quality of the space inside CAPS. Purified air is supplied at the top of CAPS at a high velocity that serves as an air curtain, or an invisible barrier, isolating the occupied space inside CAPS from the adjacent polluted ambient. The purified air emitted through the fan chamber creates a positive pressure inside CAPS and pushes the polluted gas away. CAPS is equipped with a quiet and high energy efficiency fan and a High Efficiency Particulate Arrestance (HEPA)-type (medical-level) filter that is capable of filtering away up to 95% of PM_{2.5} and larger suspended particulate matters (PM) in the ambient air. With CAPS, people who are standing or waiting in the outdoor polluted roadside environment will be able to breathe in cleaner air.

2.2 Engineering simulation

Based on the design of CAPS, a computational fluid dynamics (CFD) model was developed to study the effectiveness, practicability, usability, and flexibility of different design solutions. Furthermore, the CFD modelling technique was used to optimise the system operating conditions that maximise the overall filtration effectiveness, while minimising energy consumption.

In the CFD model, a wide range of different scenarios and operating conditions were simulated and investigated. The scenarios covered various system variability and ambient factors such as external wind and background ambient pollution level at the system and city-wide levels. Sample results, shown in Figure 3, verify that CAPS is effective in maintaining a cleaner air zone (blue in the Figure) and to keep away from the surrounding pollution (green to red in the Figure). Under different ambient conditions, simulations were carried out to investigate the impact of different system operating parameters on overall filtration effectiveness and fan requirement. Using the results, the optimised system operation in terms of air pollutant level inside the system area, air balance of the air delivery system, and fan operating speed were determined.

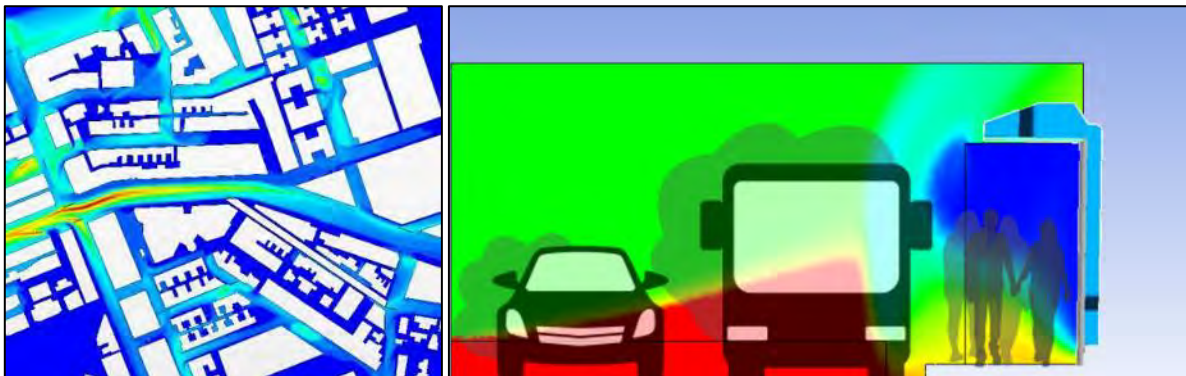

Figure 3: City-wide CFD simulation (left) and system CFD simulation (right)

2.3 Roadside testing

To demonstrate the effectiveness of the system, CAPS was first placed in Wan Chai, Hong Kong for two months and then relocated to Tsinghua University in Haidian district of Beijing. During the demonstration, continuous performance data logging and on-site manual measurements were conducted. The testing results showed that CAPS is able to provide clean air within its covered area, which achieved an air quality that complies with the World Health Organisation (WHO)'s PM_{2.5} guideline values.

Roadside testing in Hong Kong was conducted from March to May 2015 to analyse the real system performance **with respect to the ambient air quality data inside the system area. CAPS was installed in Queen's Road East** in Wan Chai, one of the busiest districts in Hong Kong situated between two official government roadside air monitoring stations located in Central and Causeway Bay. The collected data were compared to the published data. After verifying performance in Hong Kong, CAPS was relocated to Beijing for roadside testing in different environmental conditions from July 2015 onward. A similar approach, including continuous data logging and manual on-site measurements, was adopted. Similarly, the collected data inside CAPS were compared to the ambient data in Beijing.

Different system operation settings were tested using a set of testing protocol for on-site measurements. After the air quality inside the system was measured, the fan speed and the air delivery angle were adjusted for studying different design scenarios. The maximum power for the system was 13A and it cost HK\$16 per day for continuous operation. The measurement was also used to identify the filter conditions. Owing to particle blockage and aging of the filter, filter performance deteriorates when the flow rate reduces. The measurement results provided alerts for when to clean or replace the filtration system. Depending on the roadside conditions, the filter is expected to be replaced every two to six months. Further testing details can be found in.

Based on the collected data in Hong Kong and Beijing, a correlation analysis was conducted using measured data from roadside testing and simulated data from the CFD model. As shown in Figure 4, results showed that the simulation model is able to predict the real situation with a difference of less than 10%. Based on the current data analysis, CAPS is capable to reduce the PM_{2.5} concentrations by 30%-70%, depending on the ambient pollution level.

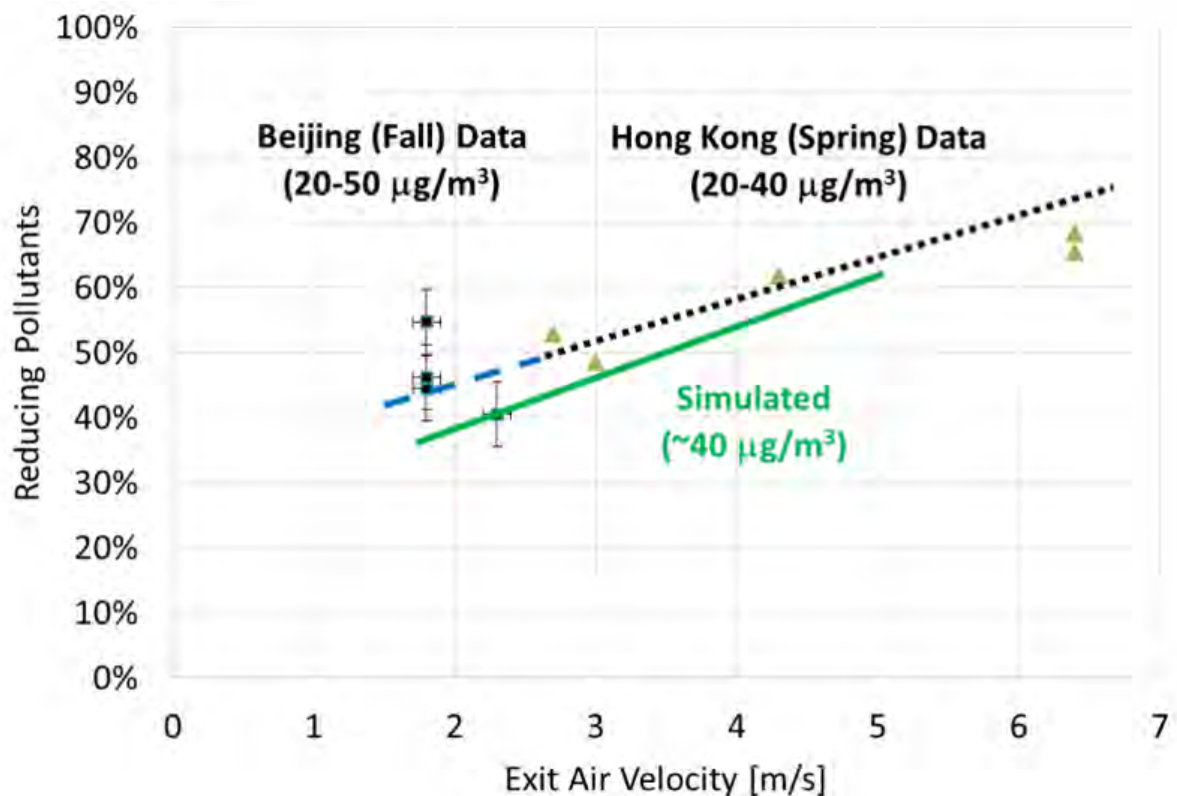

Figure 4: Correlation results between measured and simulated data for Hong Kong and Beijing roadside testing

2.4 Economic benefits

Many researchers have also attempted to quantify the economic cost due to the air pollution problem. One such analysis for Hong Kong case is done by Hedley Environmental Index. Accounting for deaths, hospital visits, and productivity loss, the Hedley Environmental Index estimated about HK\$41 billion economic losses due to pollution-related health problems in 2013.

If 200 CAPS are implemented in the 10 districts most impacted by poor air quality, as shown in Figure 5 (base map from [18]), CAPS would be saving HK\$330 million per year for Hong Kong, which is four times of the social benefit relative to the initial cost of the system. The benefit is achievable even with the assumption of only about 30 minutes of protection inside CAPS per day while waiting for the traffic, and the benefit can be observed by 60% of the entire population in Hong Kong in those mentioned 10 districts (1. Central & Western, 2. Wan Chai, 3. Eastern, 4. Kwun Tong, 5. Kowloon City, 6. Yau Tsim Mong, 7. Sham Shui Po, 8. Kwai Tsing, 9. Tuen Mun, and 10. Yuen Long).

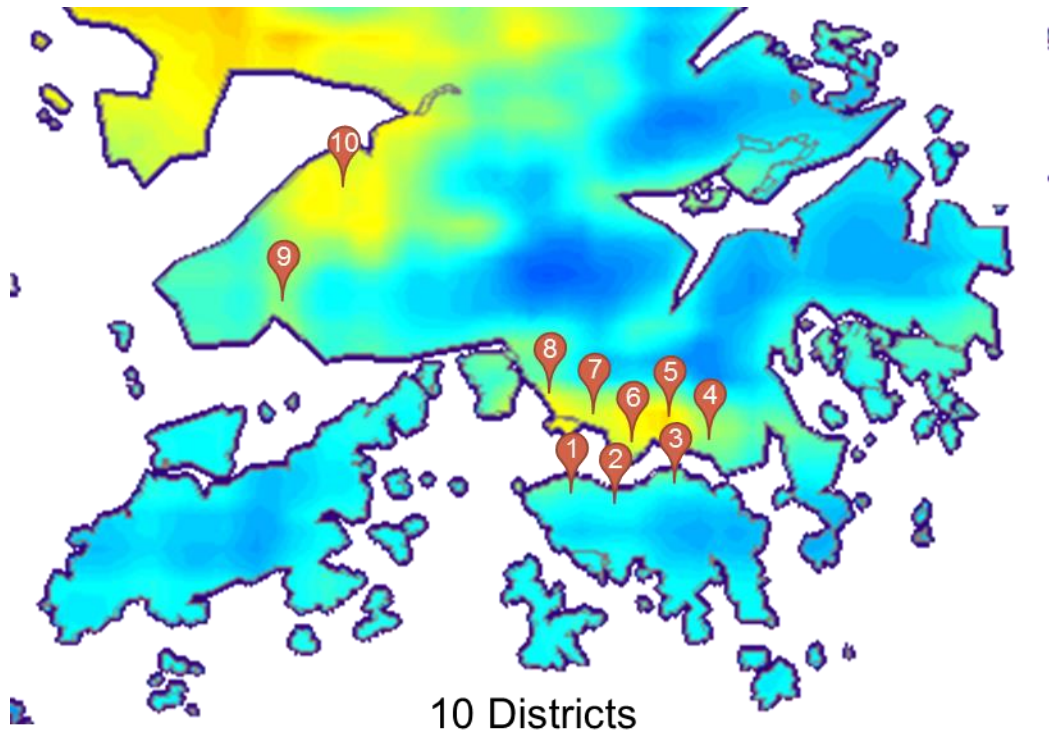

Figure 5: Most polluted districts in Hong Kong

3. CONCLUSION AND FURTHER DEVELOPMENT

Based on the analysis and tested data, the CAPS can reduce the air pollution level of PM2.5 by about 50% on average under various ambient pollution levels. Figure 6 shows CAPS's demonstration model in Hong Kong and Beijing during the testing period.



Figure 6: Demonstration in Hong Kong (left) and Beijing (right)

CAPS has wide ramifications and applications. For instance, given that Hong Kong has a well-established public transport network, the system can be adopted for bus shelters, tram stations, and other applications to improve air quality. The patent covers different forms of CAPS, including building canopy, outdoor kiosk, and central underground filtration system. For example, buildings canopy could supply fresh air to the pedestrian level and keep clean air recirculated right in front of the building entrance to improve the overall air quality around the area. The ideas can work for new designs; it is also possible to retrofit existing bus shelters and buildings. With such

appealing performance data, CAPS could be produced in mass and applied in major Asia cities, such as Beijing, Shanghai, Ho Chi Ming City, etc., all of which suffer from severe air pollution problems.

As the measured data reveal that CAPS can effectively reduce pollutant levels to a recommended level of PM_{2.5} according to WHO standards, CAPS can be developed into next-generation systems in the future. The major objective of developing the next-generation systems is to further improve its effectiveness, so as to make it low-carbon or even zero-carbon, in order to improve air quality inside the system area.

4. ACKNOWLEDGEMENT

The patented City Air Purification System (CAPS) was developed by Arup and Sino Green.

REFERENCES

- [1] Hsu, A., et al. (2016). 2016 Environmental Performance Index. New Haven, CT: Yale University. [online] Available at: www.epi.yale.edu [Accessed 31 Aug. 2016].
- [2] Afq, W.M., Azwadi, C.N., Saqr, K.M. (2012). Effects of buildings aspect ratio, wind speed and wind direction on flow structure and pollutant dispersion in symmetric street canyons: a review. *International Journal of Mechanical and Materials Engineering*, 7 (2), pp. 158-165.
- [3] Mirzaei, P., Haghighat, F. (2011). Pollution removal effectiveness of the pedestrian ventilation system. *Journal of Wind Engineering and Industrial Aerodynamics*, 99 (1), pp. 46-58.
- [4] Li, X.X., Liu, C.H., Leung, D.Y. (2009). Numerical investigation of pollutant transport characteristics inside deep urban street canyons. *Atmospheric Environment*, 43 (15), pp. 2410-2418.
- [5] **Yim, S., Fung, J., Lau, A., Kot, S. (2009). Air ventilation impacts of the "wall effect" resulting from the alignment of high-rise buildings. *Atmospheric Environment*, 43 (32), pp. 4982-4994.**
- [6] Fu, L., Hao, J., Hertel, O., Berkowicz, R. (2000). Modeling Traffic-Related Air Pollution in Street Canyons of Beijing. *Journal of the Air & Waste Management Association*, 50 (12), pp. 2060-2066.
- [7] Clifford, M.L. (2016). Beat the Hong Kong Smog: Outdoor Air Purifier Doubles as Bus Stop. [online] Available at: www.forbes.com/sites/mclifford/2015/04/07/beat-the-hong-kong-smog-outdoor-air-purifier-doubles-as-bus-stop/ [Accessed 31 Aug. 2016].
- [8] Khan, N. (2016). Air Bubble Shield for Dangerous Smog to be Tested in Beijing. [online] Available at: www.bloomberg.com/news/articles/2015-05-13/air-bubble-shield-for-dangerous-smog-to-be-tested-in-beijing [Accessed 31 Aug. 2016].
- [9] Abraham, J. (2015). Adapting to Air Pollution with Clean Air Stands in China. [online] the Guardian. Available at: www.theguardian.com/environment/climate-consensus-97-per-cent/2015/aug/24/adapting-to-air-pollution-with-clean-air-stands-in-china [Accessed 31 Aug. 2016].
- [10] Wang, S. (2016). New Way to Improve Beijing's Air Quality. [online] Available at: www.chinadaily.com.cn/beijing/2015-07/01/content_21154748.htm [Accessed 31 Aug. 2016].
- [11] Liao, A. (2015). Five Projects that Clean the Environment. [online] Available at: www.architectmagazine.com/technology/five-projects-that-clean-the-environment_o [Accessed 31 Aug. 2016].
- [12] Rogers, D. (2016). Smog-eating bus shelter developed to combat China's deadly air. [online] Available at: www.globalconstructionreview.com/innovation/smog-eating-bus-shelter-dev7e19o8ped-combat-chinas/ [Accessed 31 Aug. 2016].
- [13] WHO. (2005). WHO air quality guidelines for particulate matter, ozone, nitrogen dioxide and sulfur dioxide. Geneva: World Health Organisation.
- [14] Aqhi.gov.hk. (2016). EPD - Air Quality Monitoring Network. [online] Available at: www.aqhi.gov.hk/en/monitoring-network/air-quality-monitoring-network.html [Accessed 31 Aug. 2016].
- [15] Stateair.net. (2016). U.S. Department of State Air Quality Monitoring Program. Available at: www.stateair.net/web/historical/1/1.html [Accessed 31 Aug. 2016].
- [16] Tong, J.C.K., Cheng, V.S.Y., Lo, V.W.S. (2016). Roadside Performance Validation of a Novel City Air Purification System, *Innovation in Construction Research Journal*, pp. 40-49.
- [17] HKU. (2016). Hedley Environmental Index. [online] Hedleyindex.sph.hku.hk. Available at: hedleyindex.sph.hku.hk/html/en/ [Accessed 31 Aug. 2016].
- [18] Envf.ust.hk. (2016). Satellite Informatics System for Surface Particulate Matter Distribution (v2.10). [online] Available at: envf.ust.hk/itf-si/ [Accessed 31 Aug. 2016].

A Healthy and Sustainable Living Space – LOHAS

Josh CHENG^a, Annie SHAO^b, Tony LAM^c, Vincent CHENG^d

^a Arup, Taiwan, josh.cheng@arup.com

^b Arup, Taiwan, annie.shao@arup.com

^c Arup, Hong Kong SAR, ngan-tung.lam@arup.com

^d Arup, Hong Kong SAR, vincent.cheng@arup.com

ABSTRACT

The vision of LOHAS (Life of Health and Sustainability) is to enrich and live up to a healthy lifestyle which has become a trend worldwide. Health and Sustainability are the two major elements of LOHAS. In the past decades, we were more focused on sustainability for the physical living environment, but may have overlooked the importance of healthy lifestyles. In the concept of LOHAS, a healthy living lifestyle and its environment has again become the core spirit of design.

Mental and physical health are inextricably connected in terms of the health of LOHAS. It discovers beyond the healthy spaces and facilities, but also the relevant activities organized in order to satisfy residents both mentally and physically which are compliant with interests and local context.

The Waveland, consisting of three 14-floor RC mixed-use buildings with residential units, shopping mall, art village, and sport club. It is not only a stylish construction with integrated design, it is also injected with LOHAS spirit throughout the entire site, from exterior to interior, from large scale master planning to furniture details; it represents an organic carrier providing smart living. There are three parts of LOHAS design concepts introduced in the development.

- For sustainability, the building orientation and landscape are conducted by computer simulations for a comfortable environment filled with daylight and natural ventilation to reduce energy consumption.
- For health, organic gardens are inserted into green roof and landscape. All residents can obtain food ingredients planted by themselves, and visitors can also enjoy healthy foods in the restaurant.
- For wellness, diverse venues with nature and a pedestrian path winds between and around buildings like a hillside trail to encourage social interactions throughout the site.

This paper will discuss the concept of LOHAS designs and the details in design development stage.

Keywords: sustainable neighbourhood, wellness design, Taiwan

1. INTRODUCTION

In most of modern cities, people live a fast-paced life under various pressures. The convenience that human get from modern life may not be a healthy one as it usually accompanies along with pressure, pollution, and the feeling of alienation. Even though the threat to health is recognizable, the majority of the public could not just leave where they are at, and therein lays the problem. Thus, some of them started to look for the possibility of new urban lifestyle, which may be relatively inconvenient but more importantly, healthy.

In order to build a healthy and sustainable building, style or form should no longer be the only thing architects care about. There are numerous issues to be responded in the design such as nutrition, fitness, and wellness. In the coming chapters, a newly designed community following the concept of LOHAS will be a demonstration that showcases a living space where metropolitans would be desired to live in.

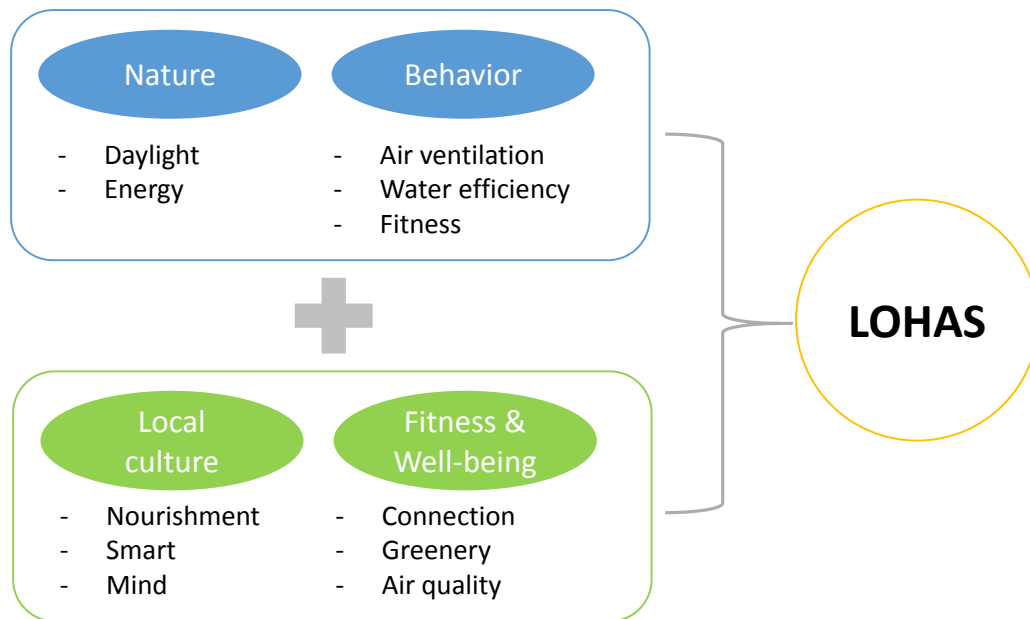

Figure 1: LOHAS concept

1.1. Design Trend

Since the Industrial Revolution in the 18th century, architecture and construction had got into a vast evolution. New materials and the change of the society had driven urbanization to bloom in that period of time. In the 20th century, the world was already occupied by lots of modern buildings constructed by concrete. People soon recognized that this was growing to become a threat for which themselves were the causes, so they began to talk about building sustainability. In the past 20 years, green building took the spotlight in this industry. Energy savings and environmental friendly design was the key topic that architects use to sell their designs. During this design trend, the needs of occupants were pretty much ignored.

Discussions and topics regarding the health of occupants emerged after the sustained debate of building sustainability. Engineers, scientists, and researchers have all joined the design team to contribute on the pursuit of healthy and sustainable designs. Nowadays, architectural designs not only emphasize solely on the importance of energy saving but also the impact on the human health and welfare.

1.2. Taiwan lifestyle

The economy and society of contemporary Taiwan was built upon agriculture. Looking back 50 years from now, the life was regular and simple in Taiwan. In that agricultural society, the economy was mainly dependent on crops productivities. Physically, people were healthy due to the daily works in the farmland; mentally, Taiwanese were happy because of the close interpersonal relationship in the small villages. The air was clean and the environment was full of greenery in that period of time.

As time goes by and along with the industrial development, most people left the farmland and moved into major cities as a metropolitan such as Taipei and Kaohsiung. Today, they can only experience the fresh air either in the countryside or in front of the air purifier. If you choose to live in the countryside, the life will be a bit dull due to the isolation of the location. Therefore, Taiwanese who live in big cities are used to and keen to have a weekend in the countryside to take a breath mentally and physically. That is one of the main reasons for the growing trend of stylish villas in Taiwan.



Figure 2: Life in modern city Taipei is tense and fast

1.3. Next generation of lifestyle

In consideration of the advantages of both urban and rural life, a new design concept is inspired - A LOHAS community that benefits the natural environment and the occupants at the same time. The environment is one **point which shows human's care to others like biodiversity indicator in Taiwan green building system. Convenience** would be another key point for which this design should also consider advanced systems, social activities, and interpersonal relationship that enables the occupants to feel like they are still living in an urban area and not isolated.

In addition to the points described above, the next generation of lifestyle should be affordable and able to blend into the daily life rather than a weekend holiday mode only. In this kind of community, people are able to actually enjoy their life with anything they need, as if they were still in urban areas.

In the following chapters, a newly designed community, the Waveland, consisting of three 14-floor RC mixed-use buildings with residential units, shopping mall, art village, and sport club will be an example to show what a LOHAS living space is.



Figure 3: The Waveland (Highlighted) is surrounded by nature

2 SUSTAINABILITY

Meanwhile, Sustainability remains a key in the contemporary building designs. More and more designers have recognized the importance of the environment, and thus more and more sustainable strategies have been invented and implemented in the design and construction process. For a community intending to support a LOHAS lifestyle, the practice of environment friendly design plan is essential.

2.1 Nature

2.1.1 Daylight

A successful lighting design not only aids to achieve energy saving in lighting but also in HVAC. Daylighting diminishes the demand for artificial lighting, and the accurate control of daylight penetration helps to minimize the impact of solar radiation, for which it may lead to the increases of energy consumption required for indoor thermal comfort if solar heat gain is not properly addressed. In the Waveland, retail lobby and residential flat unit have applied computational daylight simulation to information daylight design.

2.1.2 Energy

Low carbon and energy efficiency design is the primary element in LOHAS. The Waveland applies the energy conservation hierarchy – first, make use of the natural environment to have passive design; second, optimise the efficiency of building services system; lastly, apply renewable technology to further offset the energy use. The technology development of renewable energy is on the cutting edge of trend day by day, and as a result, higher acceptance and usage in the architecture design. On-site produce and on-site consume is recommended for renewable energy planning as to minimise energy loss during the delivery process.

2.2 Behaviour

2.2.1 Air ventilation

Taiwanese are welcoming natural ventilation, and they generally have a behaviour to accept the slightly higher indoor temperature in naturally ventilated environment. This can greatly increase the usable period of natural ventilation. Advanced natural ventilation design reduces the energy consumption for air-conditioning equipment, and also provides sufficient fresh air to improve the indoor air quality. In this case, advanced computational fluid dynamics (CFD) technique is used to enhance the mountain shape design figure to maximize natural ventilation.

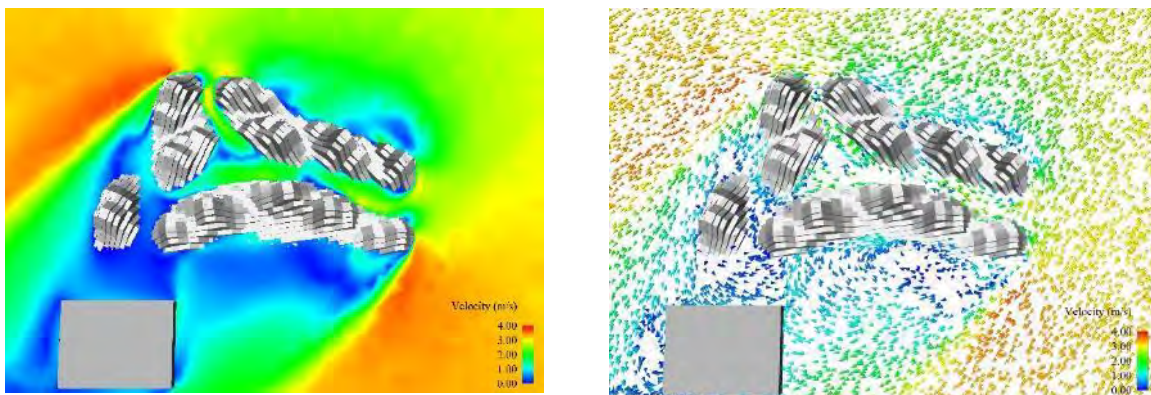

Figure 4: CFD air-flow simulations facilitate the wind environment design

2.2.2 Water efficiency

Waste water and the demand of potable water are two major issues to influence the environment on the water resource aspect. The uses of water efficient fixtures are common now, but this implementation is not good enough to reduce the impact and burden on the environment. Water recycling design should be the most significant strategy to deal with these issues such as gray water treatment and rainwater recycling systems for irrigation and flushing. However, in Taiwan, people have the perception to avoid using recycling water with human contact. In Waveland, **the rainwater recycling is applied, and sufficient educational panels and facilities are provided to drive for users' behavior change.**

2.2.3 Fitness

In urban cities nowadays, advanced transportation and labor-saving jobs has provided us a convenient life but at the same time threats has been brought to impact the citizen health. A high portion of the citizens cannot reach the suggested daily activity hours, which may cause obesity and cardiovascular diseases. It has been proved that

sufficient exercise everyday benefits both physical health and mental health for humans. Some special fitness design ideas are inserted into this case such as horse riding, windsurfing, jogging path, and stair promotion.



Figure 5: Fitness concepts are applied into the design to provide a healthy living space

3 HEALTH AND WELLNESS

Human health issue was easily neglected in contemporary sustainable design. In the past 20 years, architects and designers paid more attentions on the outdoor built environment and building energy efficiency, but have ignored the indoor occupants and their needs. The new lifestyle, LOHAS, emphasizes the balance between outdoor and indoor living qualities. Today, a healthy living space, both mentally and physically, has become a core that cannot be ignored anymore.

3.1 Local culture

3.1.1 Nourishment

Food is the main source that humans obtain their nutrients and therefore has a direct impact to human health. Nowadays, the industrialized agriculture has altered the quality and quantity of food we take. There are more and more processed foods and artificial ingredients on the dining table, and it is either difficult or expensive to have a healthy meal. In the LOHAS community, the nutrition information of foods are to be shown clearly and those unhealthy products should be limited. On-site farming with local species is encouraged to control the quality of foods to be served in the community.



Figure 6: Organic farm and restaurants provide a healthy and local choice to occupants

3.1.2 Smart

One of the **distinctive attractions of urban life that people nowadays can't live without is convenience**. For example, U-bike, the public city bike rent system provides an easy way to ride and explore in Taipei City. A smart and

convenient transportation system encourages citizens to take public transportation for their daily move to reduce carbon footprint. In addition to smart transportation, a smart building system which is based on the advanced information and communications technology (ICT) in Taiwan effectively influences occupants' behavior to avoid energy wastes like daylight sensor, information dashboard, and demand control. Smart Home concept is implemented in the Waveland.

3.1.3 Mind

The mental status somehow influences the physical health both directly and indirectly. Anything that makes occupants happy and peaceful in mind benefits their health status too. In the concept of LOHAS, nature and beauty are two key points to evaluate design level in this category. A design linked to local context and culture is highly probable to be recognized as beauty. Plants, animals, arts are all included in this aspect.



Figure 7: In terms of beauty, nature and culture are two major factors

3.2 Fitness and well-being

3.2.1 Connection

The feeling of alienation is common in the urban life which may lead to negative impact on mental health. In this LOHAS community, the architect designs many meeting corners such as coffee station, vanilla garden, and links them together by a jogging path which winds between and around buildings to encourage social interactions throughout the site. There are also many courses and activities arranged for all residents to improve the connection in the community with the intention of providing a living environment as close as they were in urban area, or even better.



Figure 8: Specific space design links occupants together and improves interpersonal relationship

3.2.2 Greenery

Greenery benefits a lot in reducing urban heat island effect. Additionally, it is one of the key points to recover the natural habitat and to reduce energy consumption. A new thinking for greenery is to have the awareness on the plant species selection which influences the water demand of irrigation and the efficiency of cooling down the ground or roof temperature. For example, in this case, the roof is 100% recovered by greenery and the roof temperature is lower than concrete roof.

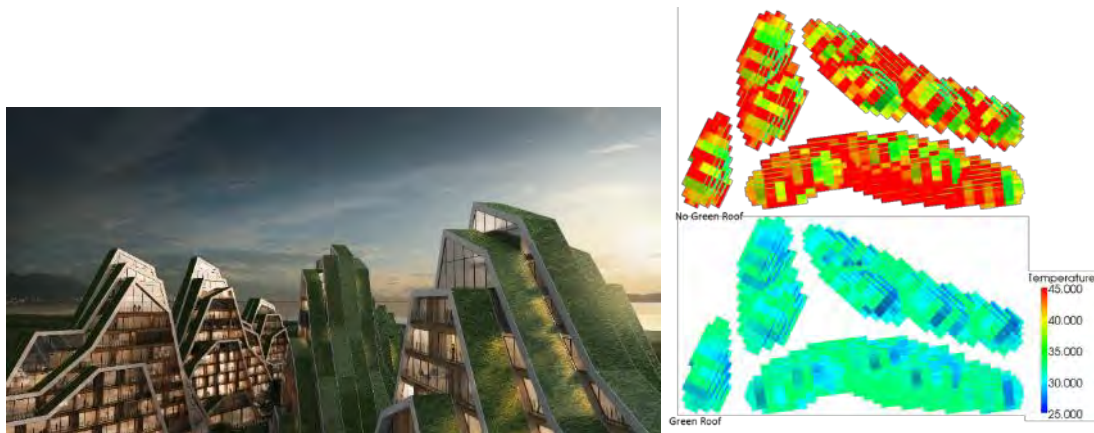

Figure 9: Maximum green roof design efficiently reduces urban heat island effect

3.2.3 Air quality

Urban residents in Taiwan would drive for hours just to go to the countryside to spend their weekends, in search for clean fresh air. The air pollutants such as PM_{2.5} and PM₁₀ have been threatening human health tremendously in big cities. That is why natural ventilation may not be welcomed in the urban area. Before the outdoor air quality is improved in big cities, a high efficient air filter and indoor air quality monitoring are recommended to maintain **the occupants' health, integrated with the Smart system. People spend 90% of their time indoors like in workplace, home, shops, restaurants, and therefore the indoor air quality is the first priority to ensure a healthy living space.**

4 CONCLUSION

The two core values of LOHAS are “sustainability” and “health and wellness”. According to the study of Taiwan society, there is an obvious and strong trend of demand for new lifestyle that combines the advantages of urban and suburban area. This situation is believed to be common in the modern cities around the world, and LOHAS may be one of the best solutions to this.

LOHAS represents a balance between the environment and its occupants. The human health, including both physical and mental parts, is as important as building sustainability. Nowadays, if a building only focuses on sustainability aspect would not be good enough to meet the public desire of life. Thus, a healthy and sustainable living space where the designers pay more attentions on the health issues such as nourishment, fitness, and interpersonal relationship could be an exemplary approach to response to the desires of residents in the modern cities, and it is expected to soon become the standards for future building industry.

REFERENCES

- [1] Architecture & Building Research Institute, Ministry of the Interior Library (2014) Green Building Evaluation Manual. Basic version. 2015th edn. Taiwan: Architecture & Building Research Institute.
- [2] International WELL building institute (2014) Available at: <https://www.wellcertified.com/> (Accessed: 20 September 2016).
- [3] LEED | U.S. Green building council (1993) Available at: <http://www.usgbc.org/leed> (Accessed: 10 September 2016).
- [4] Ritchie, A. and Thomas, all (2002) Sustainable urban design: An environmental approach. Edited by Randall Thomas. New York: Taylor & Francis.

Session 3.8: Innovative Practices for Occupant Wellbeing – Bioclimatic Design Bringing Sustainable Neighbourhood Design into Reality – Case Sharing by Brickell City Centre, Miami

Raymond YAU^a, Benny AU^b, Denise LEUNG^c, Bernardo FORT-BRESCIA^d, Hugh DUTTON^e

^a Swire Properties Ltd., Hong Kong SAR, raymondyau@swireproperties.com

^b Swire Properties Ltd., Hong Kong SAR, bennyau@swireproperties.com

^c Swire Properties Ltd., Hong Kong SAR, deniseleung@swireproperties.com

^d Arquitectonica, United States of America, miami@arquitectonica.com

^e Hugh Dutton Associes, France, hda@hda-paris.com

ABSTRACT

Place making is one of Swire Properties' key strategies in integrating our sustainability commitment in our business. Brickell City Centre is our latest project in Miami, United States, which showcases our commitment and brings sustainable neighbourhood design into reality.

Brickell City Centre is a 5.4 million square feet mixed-use development comprising shopping mall, two office towers, one hotel and two residential towers across four city blocks. The buildings are inter-connected by the 150,000 square feet Climate Ribbon™ forming an inviting central concourse and semi-open space for people to gather. We believe we have introduced a vibrant and connected community hub for Miami city.

Climate Ribbon™ provides a naturally lit, covered, naturally cooled environment for pedestrians. This pedestrian-friendly design is complemented with its connectivity with surrounding pedestrian walkways, bike paths and a site-integrated Metromover light rail station, allowing our properties to connect to mass transit networks. A two-storey parking garage spans the entire underground area beneath the development site, freeing up above-ground surface area and allowing for more traffic control.

Brickell City Centre incorporates various planning and design elements from LEED Neighbourhood Development (ND), and is targeted to achieve LEED ND Gold certification. Various new green building design features and needs from the neighborhood have been adapted.

As a symbol of sustainability, Climate Ribbon™ encourages natural breeze, water recycling and visual connectivity. **Its “scoops” at the eastern end of the development collect the southeast trade winds which are guided through the central concourse and ended with “spoilers”** at the western and northern ends by creating low pressure. This passive design eliminates the need for mechanically ventilating the large volume of the multi-story, multi-block shopping concourse. Significant energy savings as well as more efficient space planning and a quieter environment without all the mechanical equipment are significant benefits from the outset.

This paper will further explain the details of the environmental design and how the community can be influenced in a better way.

Keywords: sustainable neighborhood, microclimate, rainwater recycling

1. INTRODUCTION

1.1 Place making as a transformative idea for improving neighbourhood

Place making is a multi-faceted approach to the planning, design and management of spaces. It improves the gathering places within a community covering its streets, sidewalks, parks, buildings and other spaces¹, and invites greater interaction between people and the build environment and therefore creating a living space². This aligns with Swire Properties' Sustainable Development 2030 Strategy where Place, People, Partner, Performance (Environment) and Performance (Economic) are identified as the five important pillars. We aim to transform places while retaining their character to support communities and enhance people's lives.

Mixed-use development is one of the key elements in successful place making. It creates a hub for people's different needs and become a self-sustained neighborhood. This translates to Swire Properties classic urban proposition – all uses in one place: retail, restaurants, office and hotel. This proposition replicates in Hong Kong (Cityplaza, Citygate, Pacific Place), mainland China (Indigo and Taikoo Li Sanlitun in Beijing, Taikoo Hui in Guangzhou, Sino-Ocean Taikoo Li in Chengdu) and now in Brickell City Centre (BCC) in Miami, United States.

1.2 Brickell city centre

Located at the centre of South Florida's international trade and finance corridor, Brickell City Centre comprises 5.4 million square feet of office, residential, hotel, retail and entertainment space. The building compositions are two condominium towers, two office buildings, a EAST hotel and a 500,000 square feet open-air shopping centre integrates shopping, dining and public space.

The Climate Ribbon™ is part of Brickell City Centre's overall people-centred, human-scale design. It is an elevated trellis of steel, glass and canvas placing above the main pedestrian thoroughfare of the shopping centre, binding each building together.

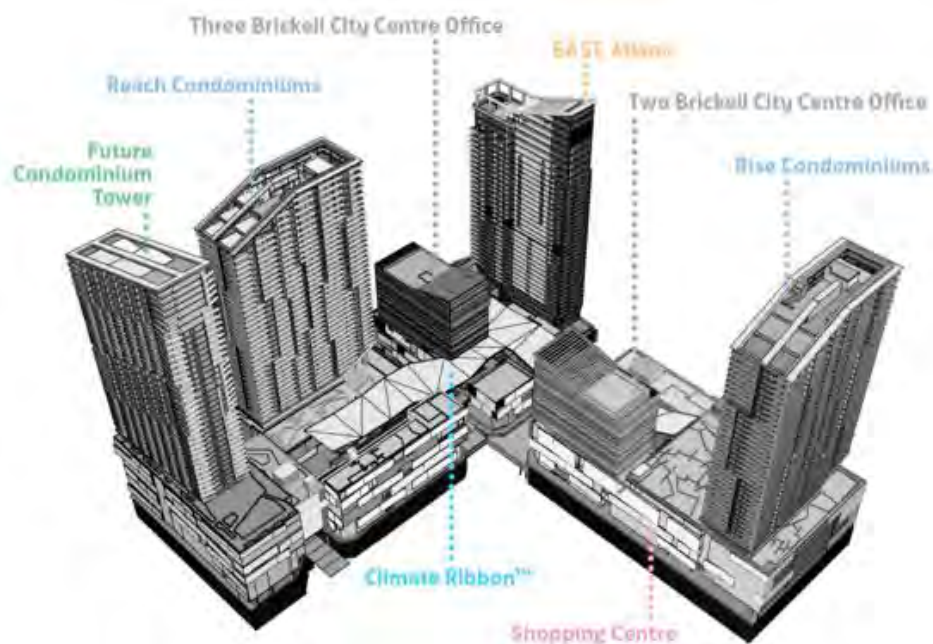

Figure 1: Overview of the Brickell City development

- Reach and Rise are twin luxury condominium towers comprising 780 total units
- **EAST, Miami is one of Swire Hotels' lifestyle business hotels**
- Two Brickell City Centre and Three Brickell City Centre together offer over 260,000 sq ft of prime office space
- The 500,000 sq ft open-air shopping centre integrates shopping, dining and public space
- **The 100,000 sq ft Climate Ribbon™ improves the microclimate of the public spaces**

2. CREATING A SUSTAINABLE NEIGHBORHOOD

Integral to the design and development of Brickell City Centre is a commitment to sustainability principles within its neighborhood. These include improving connectivity in multiple ways (to public transportation, minimized vehicular circulation for a project this size, increased pedestrian circulation); improved neighborhood micro-climate as per heat island effect; and the overall improvement of having a thriving mixed-use development energizing the neighborhood and providing new places to live, work and play where before there were empty blocks. From the initial concept for the project, BCC was designed to improve the neighborhood by factoring in the multiple layers of connectivity. The objective was to create an urban retail environment that is linked to the surrounding streets, sidewalks and public transit; BCC's precedents were Rockefeller Center instead of a suburban mall. This was

done by having multiple entry points as well as by creating pedestrian promenades along the center of each block on multiple levels, so they could cross the streets without conflicting with vehicular circulation. The expensive commitment was made to have two levels of below-grade parking for 2600 cars, allowing retail and lobbies to face the streets at the podium levels instead of the typical Miami parking podium. Access to the parking and loading docks was designed from the beginning with the goal to get cars/ trucks off the streets as quickly as possible, circulate within the building in order to exit where it was most expedient to leave the neighborhood, all efforts that reduces vehicles circling the city streets. Neighborhoods and retail thrives when there is connectivity, with people **flowing through BCC as it becomes the city's centre, located at the historic crossroads of Tamiami Trail (South 8th Street) and Brickell Avenue.**

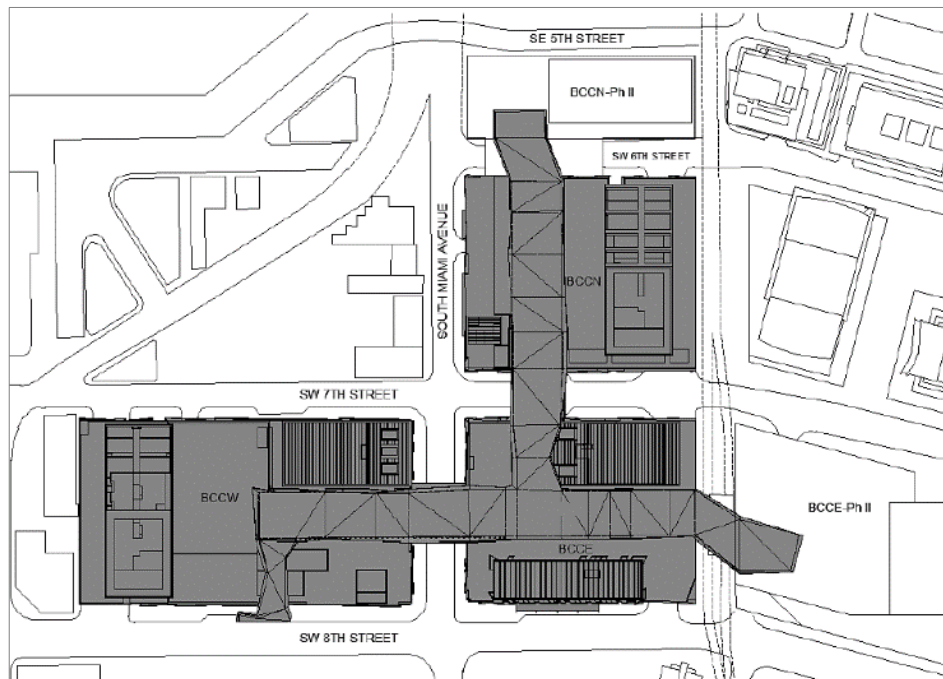

Figure 2: A layout map showing the location of BCC and its vicinity

BCC expanded the adjacent Metromover Station, adding escalators and extending the elevator to connect to the main concourse level above the light-rail platform. Integrating with this station allows easy access to the city light-rail transit network, including the nearby Metrorail, which will soon connect to the high-speed All-Aboard to Orlando. Other public transportation includes surrounding Metrobus stops and new Miami Trolley stops. This encourages BCC residents and visitors to adopt efficient transportation modes and move away from extensive use of single-occupancy vehicles and their heavy reliance on petroleum.

The Climate Ribbon™ above the central shopping concourse connects five towers (residential, office and hotel) across five city blocks, providing interconnected walkways at multiple levels, open civic spaces, active street fronts and tree-lined sidewalks, making it a pedestrian-friendly project. The connectivity with bike paths also allows BCC occupants and visitors to commute in a healthy and environmentally friendly way.

In addition, minimal parking footprint is achieved as the retail and office parking is in two levels of below grade parking. This enabled there to be more pedestrian friendly walkway and sidewalks, articulated building fenestration and the elimination of the bulky above grade parking typical of development in Miami. The pedestrian safety is also considered and improved by multiple access points. This below grade parking allows access from one location and egress from another, working with the one way street system, and thus, reduces traffic congestion and accidents.



Figure 3: Brickell City development

Brickell City Centre is further enhanced by its greenery extended over all concourse levels, amenity decks and streetscape with plant selection primarily of drought-tolerant native species. The landscape design by ArquitectonicaGEO includes regionally appropriate plant communities that transition from coastal dunes, to hammock and tropical foliage. The cumulative effect of BCC's extensive landscaping, with nearly half (46%) of the total roof area landscaped, reduces the ambient temperature within Brickell City Centre and the surrounding neighborhood as the landscaping absorbs the sun's warmth instead of deflecting it, an exemplary example of the heat island effect at work. The landscaping also improves everyone's physical and emotional well-being. Simply the sight of all the variety of landscaping, as biophilia studies have shown, reduces stress, lowers heart rates and increases a calm mood. The scents and leaves moving in the breezes also benefit the senses of smell and hearing, soothing everyone amidst the landscaping.

These sustainable elements in BCC are aligned with the principles of Smart Growth oriented development, for instance, promote mixed land uses serviced by a variety of transportation modes and create walkable site. These enable BCC to obtain recognition from Smart Growth Partnership. Along with the same sustainable neighbourhood concept, BCC is designed with the goal of achieving LEED Neighbourhood Development Gold certification for the mixed-use development complex.

3. CLIMATE RIBBON™

The Climate Ribbon™ acts like a shelter to improve the environmental performance for the general public mainly addressing 3 issues through passive design approach:

- Enhance natural ventilation
- Provide sun shade
- Promote rainwater harvesting



Figure 4: A 100,000 sq ft faceted canopy of steel and glass undulates between the mall, hotel, offices and residential towers

Detail scientific analysis and modelling simulation have been conducted before optimizing the current final design.

3.1 A breeze path

One of the common design practices on ensuring thermal comfort in pedestrian area is by mechanical ventilation or air conditioning system. However, Climate Ribbon™ strives to take the passive design approach which is more environmental friendly. The challenge is how we can introduce a feasible design with respect to the local prevailing wind condition and providing a comfortable condition for public walking underneath the canopy structure in summer time.



Figure 5: The semi-open space underneath the Climate Ribbon™ in retail concourse

The degree of thermal comfort is expressed as Standard Predicted Mean Vote (SPMV) which is a thermal comfort index with consideration on humidity, temperature, wind speed, solar exposure and human activity level in predicting pedestrian comfort levels.

Microclimate simulations have been conducted on the public area underneath the canopy structure, under 5 time slots of day and 4 seasonal periods.

After various canopy designs and corresponding CFD simulations, an optimized design was agreed as indicated in Figure 6 below. The results below indicate that the overall thermal comfort underneath the Climate Ribbon™ in summer time is significantly cooler than the surrounding sidewalks.

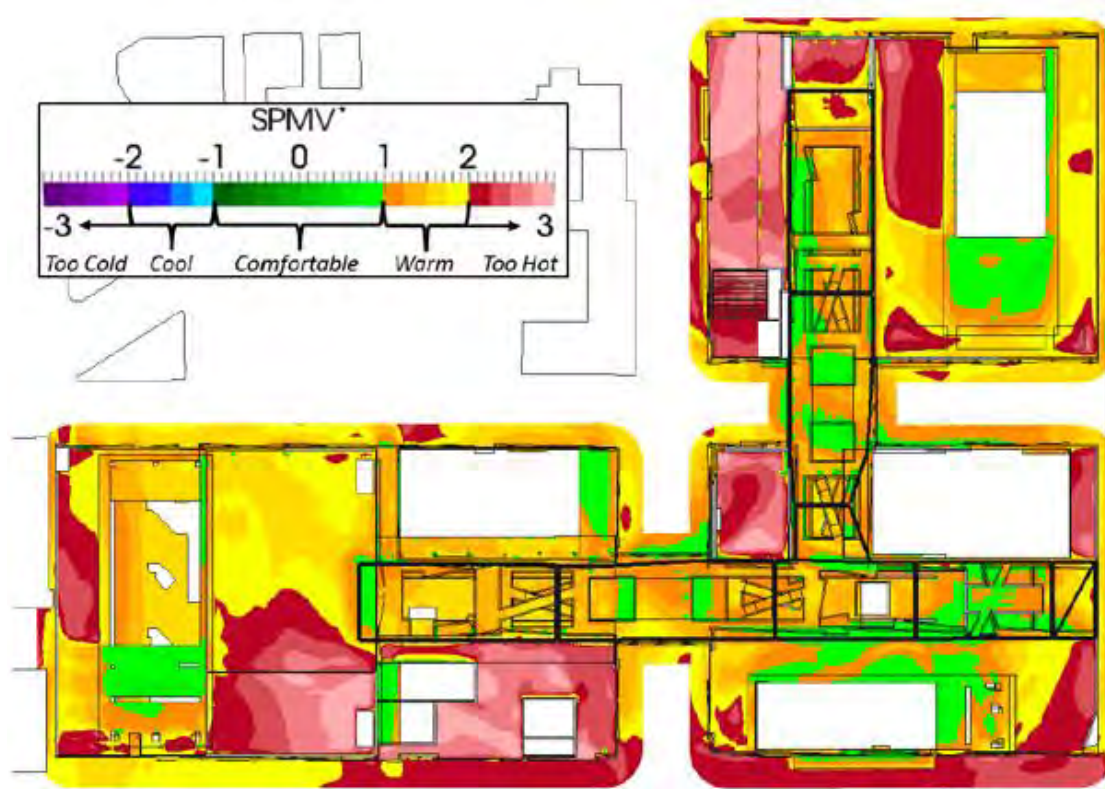

Figure 6: Thermal dynamic simulation results showing the thermally comfortable zone created underneath Climate Ribbon™ [At mid-day in summer period]

Furthermore, we have simulated the breezing flow pattern under different prevailing directions. Figure 7 below indicates a 3D result with breezing flow from South East 8th Street into the pedestrian street from the south side. Wind will split and leave the pedestrian street at the north and west ends. The sectional diagram (Fig. 7) shows how the wind flow pattern and magnitude from east to west. The simulated results indicate that air flow will be maintained at approximately 3 to 4.6 m/s at all times throughout the centre. The thermal conditions at approximately 90% of the locations studied in the public realm under the Climate Ribbon™ will be better than outdoor ambient levels.

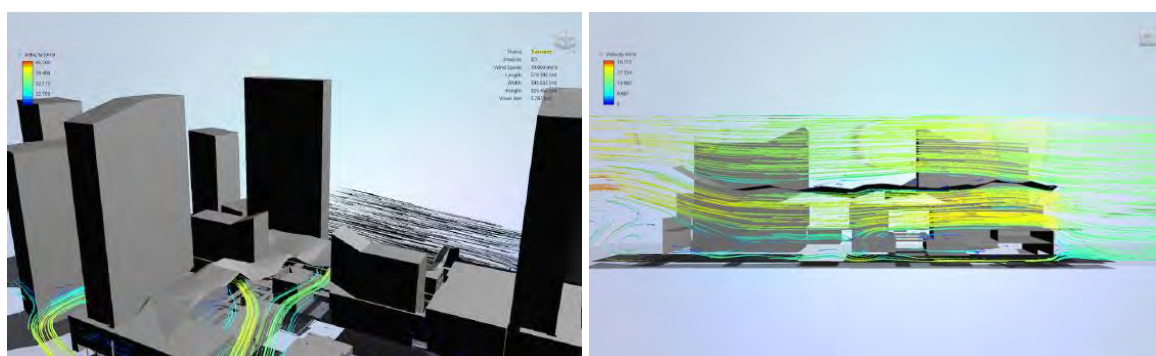

Figure 7: Simulate the breezing flow pattern under different prevailing directions

The reality of the micro-climate is also improved by BCC's lush and extensive landscaping designed by ArquitectonicaGEO. It contributes to the physical micro-climate by reducing solar heat gain. With nearly half (46%) of the total roof area landscaped, including multiple green roofs, the ambient temperature within Brickell City Centre

and the surrounding neighborhood is reduced as the landscaping absorbs the **sun's warmth instead of deflecting** it, an exemplary example of the heat island effect at work.

In addition to the contribution to micro-climate, this passive design in the semi-open area eliminates the need for mechanically ventilating the large volume of the multi-story, multi-block shopping concourse. Wind breeze flowing along the concourse also leads to significant energy savings as well as more efficient space planning and a quieter environment without all the mechanical equipment are significant benefits from the outset.

On top of computer simulation, physical model using wind tunnel test has been conducted to measure building performance under various dynamic buffeting conditions. Figure 8 below indicates the model created for wind tunnel test with a gust wind speed of almost 300km/h, which results in up to 6.5kN/m² wind load. The blade structure has been modelled to demonstrate the structural liability even under strong wind condition.



Figure 8: Wind tunnel test to measure building performance under various dynamic buffeting conditions

3.2 A sun shade

During the design stage of the Climate Ribbon™, we faced another challenge on daylight issue. We intend to provide shading for the pedestrian street while maintains suitable degree of sunlight.

3D shading analysis using typical meteorological year (TMY) data for Miami has been conducted to determine the solar exposure at each location on an hourly basis. Annual sun path (Figure 9) for the site with consideration of the surrounding buildings has been simulated.

In addition, we manage to limit the amount of sun projecting directly into shop fronts. It is now demonstrated that the Hotel East can shade the North South Street from noonday direct sun. Furthermore, the west BCCW condominium tower can shade the East and West Streets from late afternoon direct sunlight.

Regarding the blade angle design of the Climate Ribbon™, Figure 10 shows a mapping of annual direction and intensity of sun exposure for the pedestrian street and shop fronts. Optimized design is achieved with longitudinal blades perpendicular to the sun angles.

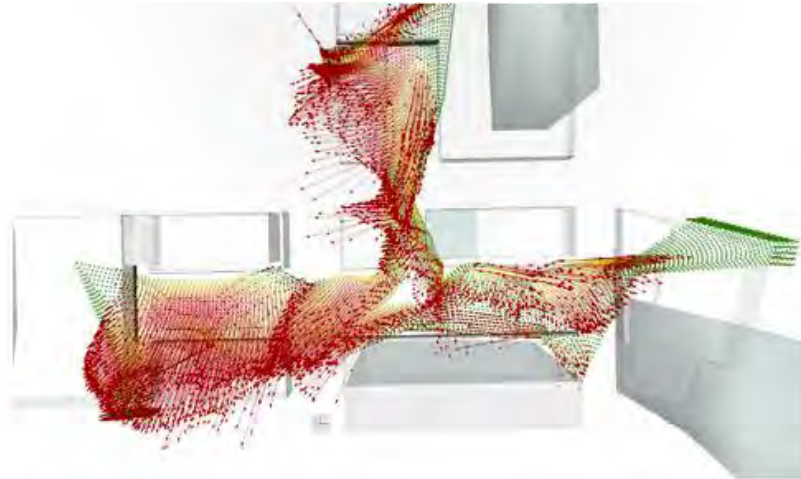

Figure 9: Providing optimal alignment for sun protection by simulating the annual sun path for the site

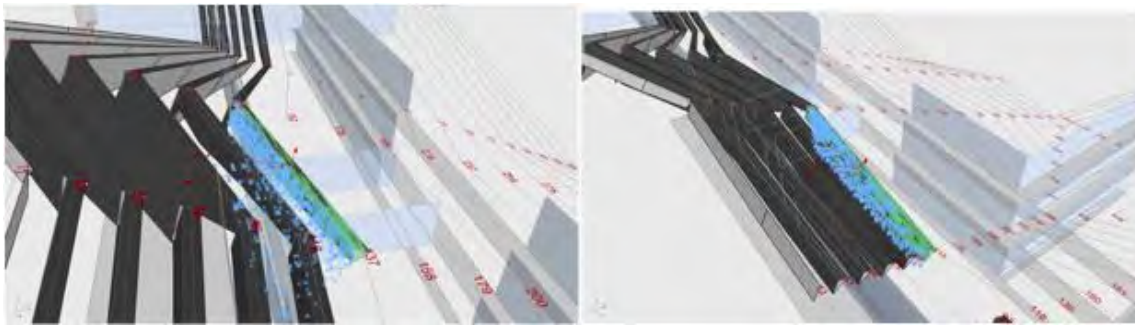

Figure 10: Modelling on effect of different blade angles

3.3 A rainwater collector

Apart from natural ventilation and sun shading, we also considered the possibility of rainwater harvesting, with the **end result of capturing all the water in a total of 6 cisterns that is needed for BCC's irrigation as well as some mechanical functions** (see attached cistern location plan). Since the CLIMATE RIBBON™ is connecting the hotel, **office and the residential towers with an area of 100,000 ft², we have introduced interesting contour with a fluid ceiling beneath of sinuous blades of architectural fabric shading.** Quantity of rainwater collected and the corresponding pipe sizes have been predicted accordingly. With the local rainfall data available, it is predicted that 4.3 million gallons of rainwater for reuse annually. The harvested rainwater provides 100% of the irrigation water and cooling tower make-up water. Figure 11 provides an image of the contour with Climate Ribbon™ angled planes directing the rainwater to the cistern collection points, for information.

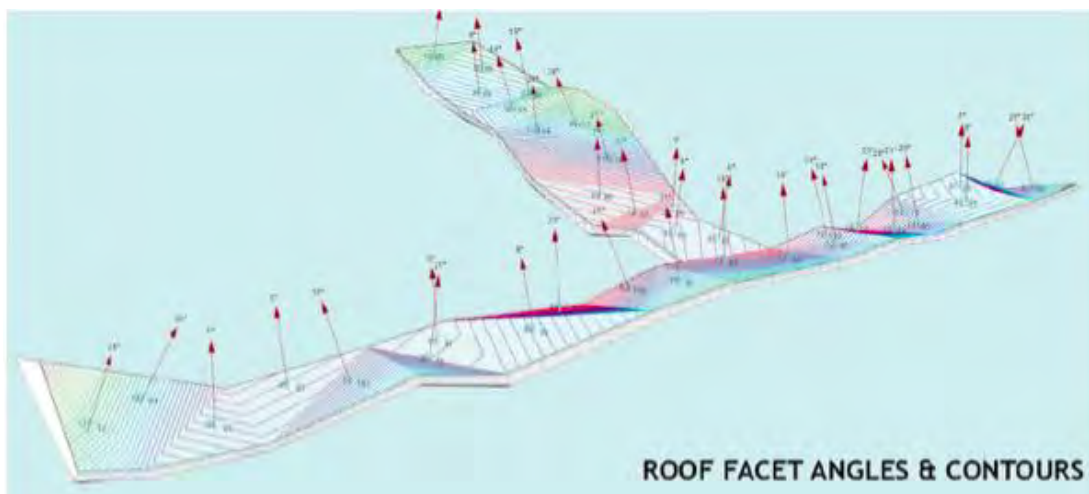

Figure 11: 3D model of the roof facet angles and contours

4. CONCLUSION

Climate Ribbon™ provides a naturally lit, covered, naturally cooled environment for pedestrians and becomes an innovative solution to creating a favourable microclimate for the neighbourhood. It also connects five building blocks, providing interconnected walkways which leads to a pedestrian-friendly development. Integral with its connectivity with a site-integrated light rail station, Brickell City Centre becomes a vibrant and connected community hub in the heart of Miami.

REFERENCES

- [1] A Guide to Neighborhood Placemaking in Chicago. By Project for Public Spaces and Metropolitan Planning Council Chicago, 2008
- [2] Places in the Making: How placemaking builds places and communities. Department of Urban Studies and Planning (DUSP) at Massachusetts Institute of Technology, 2013

On the Study of Shading Effect of Different Paving Materials Inside a Park

SY CHAN^a, CK CHAU^b, Conrad PHILIPP^c, Edwin HW CHAN^d, HK YUNG^e

^a The Hong Kong Polytechnic University, Hong Kong SAR, sandi.chan@connect.polyu.hk

^b The Hong Kong Polytechnic University, Hong Kong SAR, chi-kwan.chau@polyu.edu.hk

^c The University of South Australia, Australia, conphilipp@googlemail.com

^d The Hong Kong Polytechnic University, Hong Kong SAR, edwin.chan@polyu.edu.hk

^e The Hong Kong Polytechnic University, Hong Kong SAR, esther.yung@polyu.edu.hk

ABSTRACT

Nowadays, urban greening is a popular program within urban cities with an ultimate objective of improving the environmental quality. Urban greening in form of parks have been shown to provide numerous benefits like mitigating urban heat island (UHI) effect and improving thermal comfort in urban areas. However, there is a lack of guidelines to inform how park should be designed in order to improve the thermal environment inside parks. This study aims at investigating how different types of paving materials will affect the temperatures of different areas inside an urban park. In addition, it also aims to investigate the cooling ability provided by trees in the park. To this end, a series of field measurements were conducted with the assembled monitoring system and infra red camera. Our results found that the type of paving materials significantly influenced their surface temperatures at different time periods of a day. The shading effect provided by trees could significantly lower the surface temperatures of the park. The findings arising from this study should provide valuable insights on park planning for maximizing the cooling ability within the park environment.

Keywords: urban parks, urban cooling effect, paving materials

1. INTRODUCTION

Nowadays, urban greening is a popular program with an ultimate objective of improving the environmental quality in urban areas including roadside environments. Urban greening can mitigate the urban heat island (UHI) effect and improve thermal comfort by moderating micro-climatic conditions (Taha 1997; Park et al. 2012; Shashua-Bar et al. 2009) and provide shading (Ali-Toudert & Mayer 2007; Shahidan et al. 2012). Also, it can bring other benefits including the ability to attenuate noise levels (Van Renterghem et al. 2012; Islam et al. 2012), improve air quality (Nowak et al. 2006; Jim & Chen 2008) and reduce urban storm water runoffs (Armson et al. 2012).

The cooling effect beyond boundaries of parks is influenced by the physical setting of urban parks, e.g. park area (Lin et al. 2015; Feyisa et al. 2014), park geometries (Kong et al. 2014), type of plant cover (Lin et al. 2015; Cheng et al. 2015), and land cover (Feyisa et al. 2014), and the proportion of vegetated surface versus paved surfaces within a park (Feyisa et al. 2014). Fragmented greenspaces could also provide effective cooling (Kong et al. 2014) **and large parks were found to be cooler than smaller ones. Quite often, a park's cooling effect could extend beyond its boundary into the surrounding streets and buildings (Feyisa et al. 2014), and the extent of influence was also affected by the nature of area around each park despite being related in part to park area (Kong et al. 2014).**

In addition, urban greening can provide cooling effect inside parks. The cooling ability is influenced by area of shade, geometry of parks and tree characteristics (Shashua-Bar & Hoffman 2000). Trees and vegetation lower surface and air temperatures by providing shade and through evapotranspiration (Doick & Hutchings 2013; Landscape 2016). The surrounding air temperature can be 3°C lower and the surface temperature can even be 8°C lower than the unshaded areas (Lin & Lin 2010). A single tree could moderate the climate (Jauregui 1990), and a tree with a wide canopy could even reduce the surrounding air temperature up to 3.5°C during daytime (Potchter et al. 2006). However, the cooling effect of trees may vary from time to time and may vary due to difference in radiation condition (Yu & Hien 2006; Oliveira et al. 2011).

Besides the ambient air temperatures within a park, the surface temperature of different areas within parks should also be an important design consideration as park visitors may have close contacts with the ground surface. In fact, surface temperature has been proposed to act as one of the indicators for investigating the cooling ability of park since reasonable correlations were found between surface and air temperature (Widyasamratri et al. 2013; Li et al. 2008). As a park often embraces many different functional areas, both the ambient air and surface

temperatures are anticipated to vary with the types of paving materials (Santamouris et al. 2012; Santamouris 2013; 2014). Accordingly, this study aimed at investigating the cooling effect provided by trees in an urban park. It also aimed at investigating the cooling ability of different types of paving materials under shaded and unshaded condition.

2. METHODOLOGY

2.1. Studied site

A urban park in Tsim Sha Tsui (Kowloon Park (KP)) was selected for conducting measurements. The park was surrounded by high-rise buildings and medium trafficked roads. Its location and major characteristics are shown in Figure 1 and Table 1 respectively.

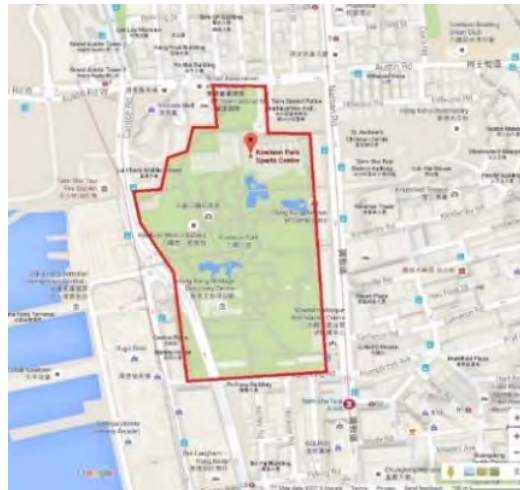

Figure 1: Location map of the studied park

	Kowloon Park (KP)
Area	317m x 417m
Tree coverage inside park	90%
With water features in parks	Yes
Height of Surrounding buildings	100-120m
Distance between the parks and building	30m

Table 1: Characteristics of the studied park

2.2. Field measurement campaigns

Two mobile microclimatic stations had been assembled for recording the microclimatic conditions under shaded and unshaded areas of the center of the park. The mobile stations embraced sensors for measuring and recording air temperature, globe temperature, wind speed, relative humidity and solar radiation. All instruments are compiled for the specification details stated in WMO, No.8 (2008).

2.3. Geographic Thermal Environment Information

Thermal camera with a resolution of 320*240 pixels (Testo 875-1i) (see Figure 2) was used to measure the surface temperatures for different areas within the park by taking remote sensing images. The photos were then further analyzed by the computer software IRSoft after inputting the emissivity, air temperature, relative humidity and wind velocity values of the measurement points. Measurements were carried out in an hourly interval from 12:00 to 23:00 for about ten days from October to November 2015. In addition, the geographic information of the park such as the total park area and the proportion of greenery areas were determined from GIS-System (Holux M-241) (see Figure 3).



Figure 2: Thermal camera



Figure 3: GIS-System

2.4. Measurement locations and materials

Both natural and synthetic paving materials like sand and grass, clay, concrete, brick, rubber used in different functional areas of a park were chosen for investigation in this study. Table 2 shows the photo images and the emissivity values of different types of paving materials. The emissivity values for different types of paving materials were extracted from Mills (1999) and the instruction manual of the thermal camera. Figure 4 shows the designated measurement routes for all the ten measurement days. One of the selected survey spots contained a banyan tree located in the Banyan Court so as to investigate the cooling ability of a tree. As there were sufficient open areas around the tree, the cooling effect of a tree could be observed directly (see Figures 5 and 6). The ground temperatures at 2m, 4m, 6m and 8m away from the center of Banyan tree were measured at different orientations (South, West and North). However, the temperature changes were not monitored at the East orientation because surrounding buildings might have influence on the cooling effect on that side. Infra-red photos were taken in an hourly interval from 12:00 to 23:00 for ten different days so as to analyze the cooling effects of the park during both daytime and night time.

	Type of Material	Emissivity Value	Photos of the materials	Type of Material	Emissivity Value	Photos of the materials	
A	Clay	0.91		F	Concrete	0.91	
B	Clay	0.91		G	Concrete	0.91	
C	Brick	0.90		H	Sand	0.75	
D	Clay	0.91		I	Grass	0.92	
E	Rubber	0.89					

Table 2: The types of studied paving materials



Figure 4: Measurement route



Figure 5: Location of the surveyed tree



Figure 6: Photo of the surveyed tree location

3. RESULTS

3.1. The cooling ability of different types of paving materials under shaded and unshaded condition

Figure 7 shows the surface temperatures for nine different types of paving materials under shaded and unshaded condition at different periods of a day. Dotted lines denote the surface temperatures of the paving material measured under shaded condition (Material A to I), while solid lines denote the surface temperatures of material measured under unshaded condition (Material A to I).

Highest surface temperatures of Rubber (Material E) were observed in Children Playground while lowest surface temperatures were observed in natural environment containing Sand and Grass (Materials H and I) under both shaded and unshaded conditions during afternoon periods. The surface temperatures of paving materials like Clay and Concrete could reach 40-45°C while Brick could reach 50°C in the afternoons.

For all types of paving materials under shaded condition, the surface temperatures fell below 37°C during the afternoon periods. For those materials without shade, the surface temperatures rose over 37°C and could even rise up to 65°C or above. The surface temperatures of all the materials showed a decreasing trend with time period after 1pm under both shaded and unshaded condition. For the same type of materials, the surface temperatures under shaded and unshaded condition after sunset were nearly the same, i.e. around 25 - 30°C. The gradients of temperature difference before and after sunset for those materials under shaded condition were small, between 0 and 5°C. However, the gradients of temperature difference before and after sunset for those materials under unshaded condition were large, which could be more than 10°C and could even go up to 40°C.

Even with a significant difference in surface temperatures during daytime, the results showed that the surface temperatures after sunset were almost the same for shaded and unshaded condition. This suggested that shading could lower the surface temperatures substantially during the afternoon periods. The decreasing trends of surface temperature for all different types of paving materials slowed down and became stabilized at night time. Furthermore, the ambient air temperature measured at the clay surface was linearly correlated with both surface temperatures under shaded ($r=0.716$) and unshaded areas ($r=0.653$), which further confirmed that surface temperature can be used for portraying ambient air temperature.

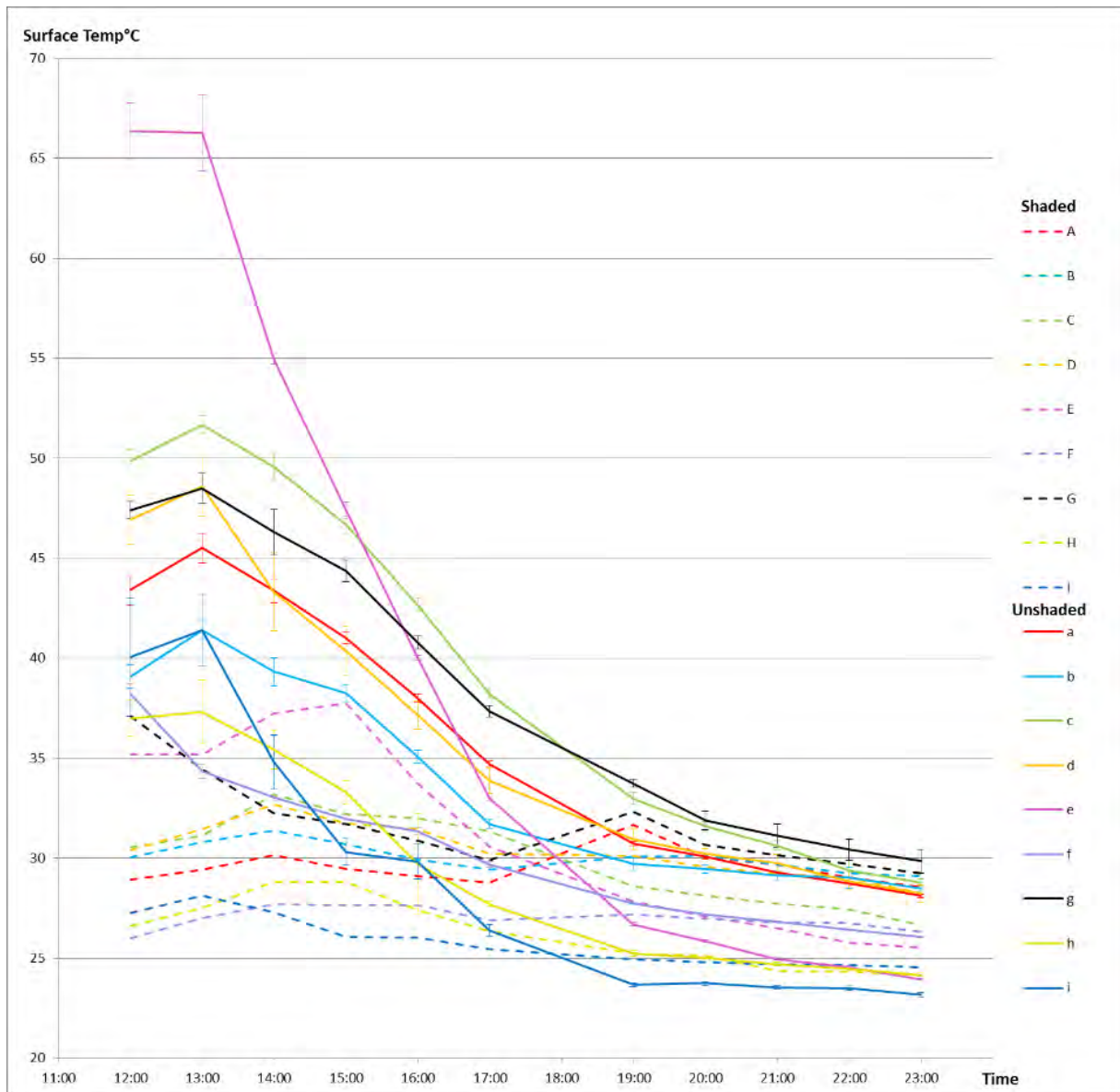

Figure 7: Surface temperatures for nine different types of paving materials located in shaded areas and unshaded areas

3.2. The cooling effect provided by the greenery area in the urban park

The ground surface temperatures at various distances (2m, 4m, 6m and 8m) away from the center of the Banyan tree were measured at three different orientations (South, West and North). Locations 1 and 2 (2m and 4m away from the center of the tree respectively) were mostly shaded by the tree, while Locations 3 and 4 (6m and 8m away from the center of the tree respectively) were not shaded.

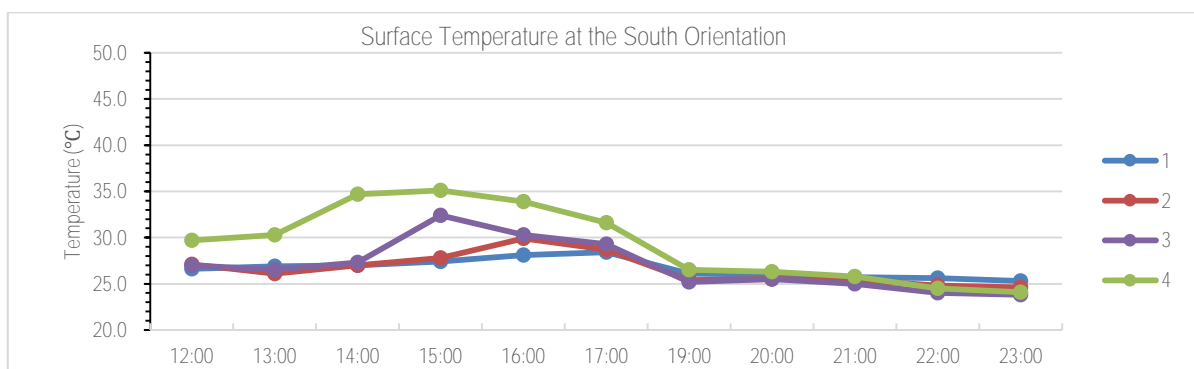

Figure 8: Surface temperatures at the South orientation

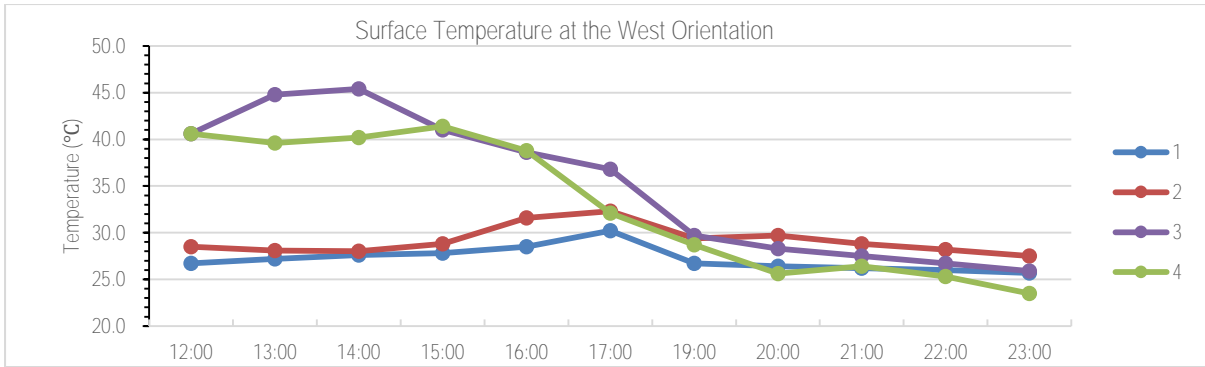

Figure 9: Surface temperatures at the West orientation

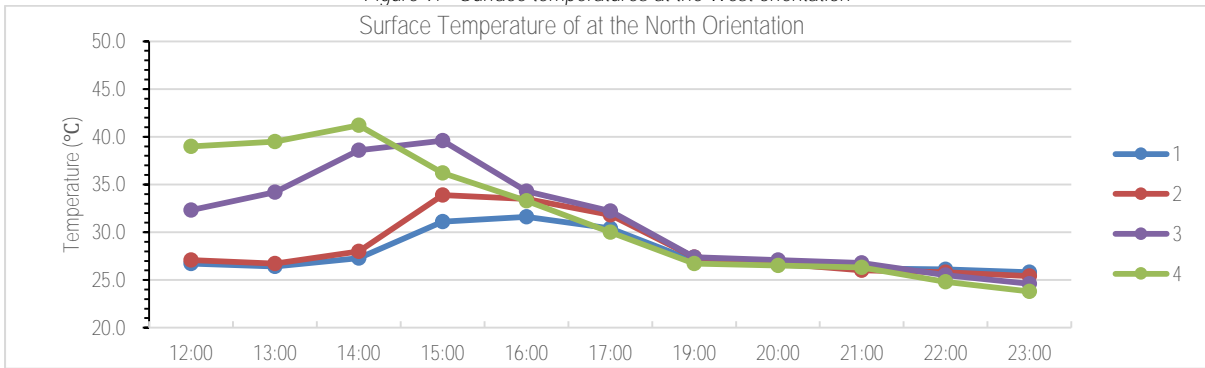

Figure 10: Surface temperatures at the North orientation

Figures 8, 9, and 10 show the surface temperatures at various distances away from the center of the tree for different periods at different orientations. All these 3 figures show that the temperatures at Locations 1 and 2 shaded by the tree were generally lower than those at the corresponding unshaded counterparts (Locations 3 and 4). However, the cooling ability of tree varied with orientation. At the West orientation, the surface temperatures remained around 40°C till 4pm as less amount of shade was provided by the tree due to the sun direction, while the surface temperatures at South and North orientation dropped with time after 2pm. Figure 11 show the effects of shade on temperature variation with and without shade over a 24-hour period. Shade provided by trees could lower the surface temperatures by at least 15°C during afternoon periods, while the presence of tree would not change the cooling efficiency at the nighttime.

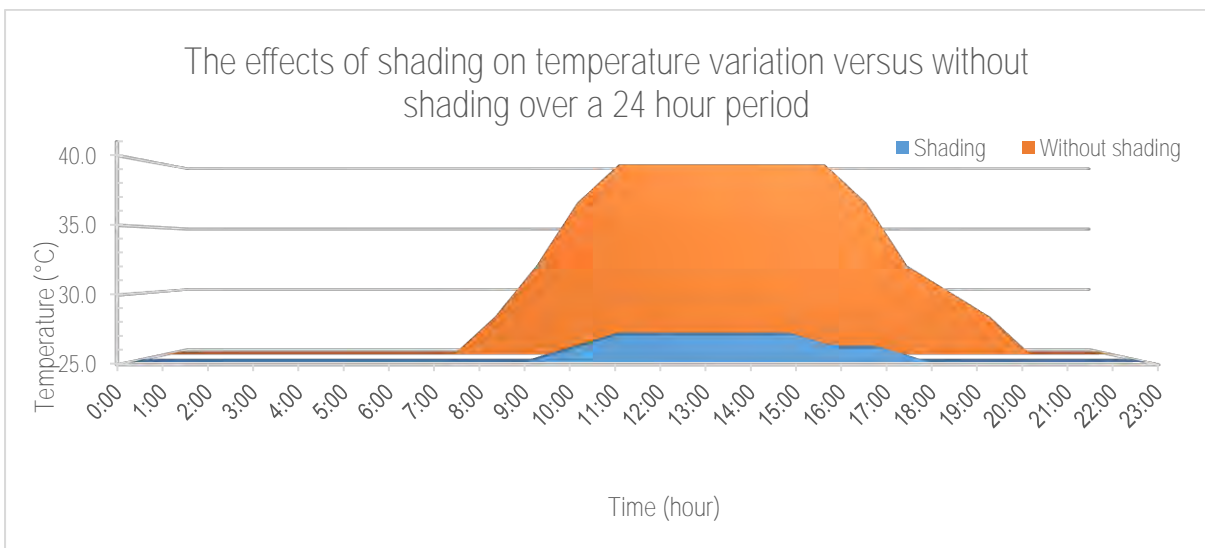

Figure 11: The effects of shade on temperature variation over 24-hour period

4. CONCLUSION

In this study, surface temperatures of nine different types of materials under shaded and unshaded conditions were measured within an urban park in Hong Kong. Basically, it was found that shade was an important means to lower the ground surface temperature inside a park in the presence of sunlight. The more natural the paving material, the cooler the ground surface was. The surface temperatures of clay and concrete (about 40°C) were comparatively lower in the afternoon periods, with higher surface temperatures being detected for bricks (up to 50°C). Alarming higher surface temperatures were determined for the rubber paving in children playground (up to 65°C or above), which can pose health threat to children playing inside the playground. These results should provide valuable insights for urban planners when designing parks as paving materials do not only affect their functional uses but also greatly affect the surface temperatures inside parks.

REFERENCES

- [1] Ali-Toudert, F. & Mayer, H., 2007. Effects of asymmetry, galleries, overhanging facades and vegetation on thermal comfort in urban street canyons. *Solar Energy*, 81(6), pp.742–754.
- [2] Armson, D., Stringer, P. & Ennos, A.R., 2012. The effect of tree shade and grass on surface and globe temperatures in an urban area. *Urban Forestry and Urban Greening*, 11(3), pp.245–255.
- [3] Cheng, X. et al., 2015. Influence of Park Size and Its Surrounding Urban Landscape Patterns on the Park Cooling Effect. *Journal of Urban Planning and Development*, 141(3), p.A4014002.
- [4] Doick, K. & Hutchings, T., 2013. Air temperature regulation by urban trees and green infrastructure.
- [5] Feyisa, G.L., Dons, K. & Meilby, H., 2014. Efficiency of parks in mitigating urban heat island effect: An example from Addis Ababa. *Landscape and Urban Planning*, 123, pp.87–95.
- [6] Islam, M. et al., 2012. Pollution attenuation by roadside greenbelt in and around urban areas. *Urban Forestry and Urban Greening*, 11(4), pp.460–464.
- [7] Jauregui, E., 1990. Influence of a large urban park on temperature and convective precipitation in a tropical city. *Energy and Buildings*, 15(3), pp.457–463.
- [8] Jim, C.Y. & Chen, W.Y., 2008. Assessing the ecosystem service of air pollutant removal by urban trees in Guangzhou (China). *Journal of Environmental Management*, 88(4), pp.665–676.
- [9] Kong, F. et al., 2014. Effects of spatial pattern of greenspace on urban cooling in a large metropolitan area of eastern China. *Landscape and Urban Planning*, 128, pp.35–47.
- [10] Landscape, D., 2016. Using Trees and Vegetation to Curb Heat Island Effects.
- [11] Li, Z. et al., 2008. Applicability of Land Surface Temperature (LST) estimates from AVHRR satellite image composites in northern Canada.
- [12] Lin, B.S. & Lin, Y.J., 2010. Cooling Effect of Shade Trees with Different Characteristics in a Subtropical Urban Park. , 45(1).
- [13] Lin, W. et al., 2015. Calculating cooling extents of green parks using remote sensing: Method and test. *Landscape and Urban Planning*, 134, pp.66–75.
- [14] Nowak, D.J., Crane, D.E. & Stevens, J.C., 2006. Air pollution removal by urban trees and shrubs in the United States. *Urban Forestry & Urban Greening*, 4(3–4), pp.115–123.
- [15] Oliveira, S., Andrade, H. & Vaz, T., 2011. The cooling effect of green spaces as a contribution to the mitigation of urban heat: A case study in Lisbon. *Building and Environment*, 46(11), pp.2186–2194.
- [16] Park, M. et al., 2012. Effect of urban vegetation on outdoor thermal environment: Field measurement at a scale model site. *Building and Environment*, 56, pp.38–46.
- [17] Potchter, O., Cohen, P. & Bitan, A., 2006. Climatic behavior of various urban parks during hot and humid summer in the mediterranean city of Tel Aviv, Israel. *International Journal of Climatology*, 26(12), pp.1695–1711.
- [18] Van Renterghem, T., Botteldooren, D. & Verheyen, K., 2012. Road traffic noise shielding by vegetation belts of limited depth. *Journal of Sound and Vibration*, 331(10), pp.2404–2425.
- [19] Santamouris, M., 2014. Cooling the cities – A review of reflective and green roof mitigation technologies to fight heat island and improve comfort in urban environments. *Solar Energy*, 103, pp.682–703.
- [20] Santamouris, M., 2013. Using cool pavements as a mitigation strategy to fight urban heat island—A review of the actual developments. *Renewable and Sustainable Energy Reviews*, 26, pp.224–240.
- [21] Santamouris, M. et al., 2012. Using cool paving materials to improve microclimate of urban areas – Design realization and results of the flisvos project. *Building and Environment*, 53, pp.128–136.

- [22] Shahidan, M.F. et al., 2012. An evaluation of outdoor and building environment cooling achieved through combination modification of trees with ground materials. *Building and Environment*, 58, pp.245–257.
- [23] Shashua-Bar, L. & Hoffman, M.E., 2000. Vegetation as a climatic component in the design of an urban street: An empirical model for predicting the cooling effect of urban green areas with trees. *Energy and Buildings*, 31(3), pp.221–235.
- [24] Shashua-Bar, L., Pearlmutter, D. & Erell, E., 2009. The cooling efficiency of urban landscape strategies in a hot dry climate. *Landscape and Urban Planning*, 92(3–4), pp.179–186.
- [25] Taha, H., 1997. Urban climates and heat islands: albedo, evapotranspiration, and anthropogenic heat. *Energy and Buildings*, 25(2), pp.99–103.
- [26] Widyasamratri, H. et al., 2013. A comparison air temperature and land surface temperature to detect an urbanization effect in Jakarta, Indonesia. , 2, pp.1097–1104.
- [27] Yu, C. & Hien, W.N., 2006. Thermal benefits of city parks. *Energy and Buildings*, 38(2), pp.105–120.

Passive Design Strategies for Building Envelopes in Different Orientations

Leidy Johana RAMIREZ^a, Elizabeth PARRA^b

^a PVG Arquitectos, Colombia, leidyramirez@pvgarquitectos.com

^b PVG Arquitectos, Colombia, elizabethparra@pvgarquitectos.com

ABSTRACT

Human wellbeing in architecture is highly influenced by its site and climate; there are methodologies that suggest the correct orientation of open facades, depending on pre-existing weather condition, which seek to ensure the user environmental comfort. In tropical cities like Medellin - Colombia, the absence of stations generates a relatively homogeneous climate that allows the use of passive design strategies to naturally condition spaces and to adapt the interior space, according to a particular function or activity; however, the rapid growth of cities and the lack of sustainability criteria in urban planning has limited the orientation of buildings to the pre-existing urban design, narrowing the design options and the use of resources. This article aims to develop a tool for architects, which provides design premises for building envelopes with under bioclimatic criteria, according to the orientations of open facades, on the basis that any orientation can be imposed by the urban setting. For this a hypothetical model, with pre-set parameters and the possibility of opening only two facades, was evaluated. Sunlight incursion, natural ventilation and natural lighting simulations were made, which gave us inputs for the development of the tool. In order to illustrate its use, the premise obtained in the design of the facades of the hypothetical module were applied on an example located in the city of Medellin, in two different orientations, achieving through different facades, a similar indoor environmental conditions.

Keywords: bioclimatic architecture, human well-being, environmental comfort, passive design, building orientation.

1. INTRODUCTION

In the city of Medellin, Colombia, during its development, the rapid growth of the population and the industry, gave way to an slow process of urbanization and legalization, with a lack of sustainability criteria. In the literature on bioclimatic architecture, studies indicate which is the ideal orientation of open facades according to: climatic factors, the latitude, prevailing wind currents and availability of lighting resource (Olgay, 2002). However, given the urban configuration of the city, in some cases it is not possible to choose the orientation of the open facades.

This research seeks to provide a tool for architects to design envelopes with bioclimatic criteria. The importance of this tool lies in promoting and encouraging the construction of buildings designed with bioclimatic criteria that favor human well being in inner spaces and decrease environmental impact. The research studied the behavior of a hypothetical model in eight different orientations, starting from the north and rotating 45° degrees each time to complete 360°, as illustrated in Figure 1.

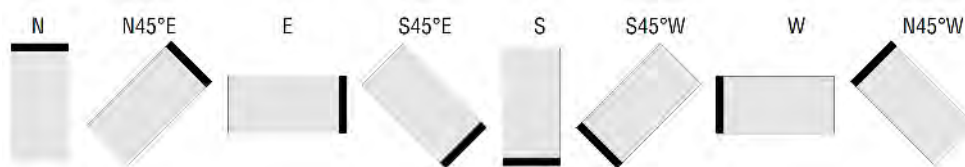

Figure 61: Orientation of the analysed open facades

2. RESEARCH BASELINE

2.1 Geographical location and climatic characterization

The study was developed in the city of Medellin, Colombia, at latitude 6°13'55"N and longitude 75 ° 34'05"O. Its temperature ranges between 12°C and 32°C having an annual average temperature of 22°C. The average relative humidity is 68% and the predominant wind direction is north (23%) - South (14%), with speeds between 1.5 m/ s and 7.9 m/ s (IDEAM, 1999a).

2.2 Hypothetical model properties

It was specified a hypothetical model of a rectangular shaped, 6m wide, 12m long and 3m high, located in a central block, whose areas of intervention are the main facade and the roof. The selected building typology was an "office space", as this are environments that require prolonged stay and in which complex activities with high requirements for sun protection, lighting and ventilation are developed.

2.3 Environmental factors

Solar incursion: To calculate solar incursion into the model, a solar chart for latitude 6.13°N was used. This type of diagrams are easily obtained (Arquitectos, n.d.) or can be built (Bermudez, 1969). The dates chosen for the diagnosis were December 21th and June 21th (solstices); and March 21th and September 21th (equinoxes). According to the spatial typology, it was determined that between 8:00h and 16:00h, direct sunlight should be avoided on the open facade.

Natural Lighting: Daylighting simulations were performed with the Velux Daylight Visualizer 2.8 software, under partly cloudy conditions, on December 21th, June 21th and March / September 21th at 8:00h, 12:00 and 16:00h. This software, presents the amount of lux present in the space at the level of the work plane (0.75 m from the floor surface) in order to identify areas that are over-lit or poorly lit.

To define the required lighting levels in office spaces, this study took as a reference the "technical regulation lighting and street lighting. RETILAP" (Ministerio De Minas Y Energía, 2015). For office spaces, the lightning levels required on the work plane should be between 300 lx and 1.000 lx.

Natural ventilation: To determine the size of openings necessary to naturally ventilate the space, "The Florida Solar Energy Centre Method 1" was used. This method calculates total opening area (TOA) required, considering an inlet and an outlet located in opposite facades, of equal area, and taking into account the effect of wind, regardless of the temperature. This formula was chosen as it proposed corrections to the wind direction and surroundings characteristics.

$$TOA = \frac{1,16 \cdot 10^{-3} \cdot V \cdot ach}{W \cdot f_1 \cdot f_2 \cdot f_3 \cdot f_4}$$

Equation 1

Where TOA = total opening area in m² (the sum of both the entry and the exit); V = volume of the building in m³; Ach = air exchanges per hour; W = wind speed in m/ s; f1 = coefficient determined by wind angle of incidence; f2 = site correction factor; f3 = surroundings correction factor; f4 = height multiplication factor.

According to the chosen spatial typology, 10 Ach were considered as the minimum required and 30 Ach as the optimum air changes per hour (Tobar Arango, 2004).

3. DIAGNOSIS

Once the parameters were established, a diagnostic analysis was performed assuming the main facade is entirely open.

3.3 Solar incursion

Based on the criteria established in the research base line, a solar incursion analysis was conducted for each orientation. In Figure 2, the areas on the floor that receive sun during the set dates and times, are indicated.

Orientation	N	N45°E	E	S45°E	S	S45°W	W	N45°W
June 21								
8:00 h	7.61 m ²	24.71 m ²	23.7 m ²	6.7 m ²	-	-	-	-
12:00 h	5.75 m ²	3.84 m ²	-	-	-	-	-	3.84 m ²
16:00 h	7.61 m ²	-	-	-	6.7 m ²	23.7 m ²	24.71 m ²	-
March 21 / September 21								
8:00 h	-	15.37 m ²	31.13 m ²	15.21 m ²	-	-	-	-
12:00 h	-	-	-	-	-	-	-	-
16:00 h	-	-	-	-	15.21 m ²	31.13 m ²	15.37 m ²	-
December 21								
8:00 h	-	5.1 m ²	25.4 m ²	32.4 m ²	10.0 m ²	-	-	-
12:00 h	-	-	-	6.47 m ²	10.1 m ²	6.47 m ²	-	-
16:00 h	-	-	-	-	10.0 m ²	32.4 m ²	25.4 m ²	5.1 m ²
Sum	20.9 m ²	48.9 m ²	80.2 m ²	60.8 m ²	30.1 m ²	60.8 m ²	80.2 m ²	48.9 m ²

Figure 62: Summary of the floor areas that receive sun during the studied dates and times

At the end of each column the sum of the sunny areas is presented, obtaining as a result that the facade with the lowest solar incursion throughout the year is the one oriented towards the north (N) and the sunniest are the Eastern (E) and western (W) facades, both presenting the same value.

3.4 Natural ventilation

In order to calculate the required ventilation open areas, for each module, the f value (correction factor) were determined according to the facade orientation.

(f1) Wind incidence angle: Considers the loss in efficiency presented when the wind enters a space depending on the inclination of the facade with respect to the prevailing wind direction, thus: 90°=0.08, 80°=0.14; 70°=0.2; 60°=0.25; 50°=0.3; 40°=0.35; 0°=0.35. Two directions of the wind were set, the predominant direction, north (3.23 m/ s) and the second predominant, south (2.5 m/ s) (IDEAM, 1999b).

(f2) Correction factor due to side location: the chosen site location was "great city center", 24 hours a day. For these two conditions a value of 0.47 was determined.

(f3) g (distance)/ h (obstacle height) relation: For all orientations, it is considered that the open façade faces an obstacle (h) corresponding to a three story building (9 m high), located at a distance (g) for the urban section between buildings: sidewalk 1.2 m + street 5 m + road divider 1 m + street 5 m + sidewalk 1.2 m = 13,40 m, being the g/ h ratio equal to 13.4/ 9, 1.49, equivalent to an f3 of 0.63.

(f4) Multiplication factor due to the height: Only one level; f4=1.

Table 1 shows the result of opening areas required for minimum air exchange (10 Ach) and the optimum air exchange (30 Ach). The area presented corresponds to a single opening, the inlet and the outlet must each meet the area indicated.

Opening areas required for ventilation in office space(m ²)					
Facade	N	N45°E - N45°W	E y W	S	S45°E - S45°W
10 Ach	2,17	2,53	9,50	2,81	3,27
30 Ach	6,52	7,60	28,51	8,42	9,82

Table 1: Opening areas required for ventilation purposes

The open facade of the module has an area of 18 m² which prevents the east (E) and west (W) facades from meeting optimal air exchanges. For this reason, the minimum air exchanges (10 Ach) as the comparison parameter.

3.5 Natural lighting

Simulations were performed according to the parameters outlined in the research base line, considering the following materials for each system: walls = semi-gloss white paint; floors = semi-gloss white finish; blinds = wood; profiles = aluminum and glass = clear glass. In Figure 3, three (3) different values are identified at the work plane height (0.75 m from the floor surface), the areas of it that over lit, those that are properly illuminated and those that are poorly lit. Columns show the orientation of the open facade and the rows show the dates that were evaluated. At the end of the table the sum of the optimal lit areas was performed to identify the areas, which have lighting independence throughout the year. The orientations with the highest and lowest area in the final count are the N45°W and N45°E facades, respectively.

Orientation	N	N45°E	E	S45°E	S	S45°W	W	N45°W
June 21th								
over-lit area	7.1 m ²	10.9 m ²	7 m ²	7.3 m ²	7.2 m ²	7.3 m ²	7.1 m ²	7.2 m ²
optimum lighting area	38.8 m ²	29 m ²	40.1 m ²	29 m ²	27.9 m ²	28.4 m ²	28 m ²	31.1 m ²
poorly lit area	26 m ²	32 m ²	25 m ²	35.6 m ²	36.7 m ²	36.3 m ²	36.8 m ²	36.6 m ²
March 21th / September 21th								
over-lit area	6.7 m ²	7.1 m ²	7 m ²	6.6 m ²	9 m ²	6.7 m ²	8.5 m ²	6.8 m ²
optimum lighting area	30.6 m ²	28.6 m ²	33.4 m ²	37.3 m ²	30.2 m ²	34.9 m ²	30.7 m ²	39.2 m ²
poorly lit area	34.5 m ²	36.1 m ²	31.6 m ²	27.9 m ²	32.7 m ²	30.3 m ²	32.7 m ²	25.9 m ²
December 21th								
over-lit area	5.1 m ²	4.8 m ²	5.2 m ²	4.8 m ²	9.8 m ²	5.2 m ²	9 m ²	4.7 m ²
optimum lighting area	28.8 m ²	28.8 m ²	29.2 m ²	41.2 m ²	32.1 m ²	39.5 m ²	32.6 m ²	40.9 m ²
poorly lit area	38.1 m ²	38.4 m ²	37.6 m ²	26.1 m ²	30.1 m ²	27.3 m ²	30.3 m ²	26.4 m ²
Sum	98.2 m ²	86.4 m ²	102.7 m ²	107.5 m ²	90.2 m ²	102.8 m ²	91.3 m ²	111.2 m ²

Figure 3: Optimal daylighting areas on the work plane

4. CONSTRUCTION OF THE TOOL

The proposed tool, was developed by building a calculator that allows to obtain basic outputs to generate solar control strategies, to identify areas of ventilation and promote the balance of the light curve according to the space needs.

Passive design strategies calculator			
Enter data here		Results	
Solar Incursion			
Orientation of open facade	N		
Solar control range	From (h)	8:00:00	
	Until (h)	15:00:00	
Solar control strategies			
Critical design date	June 21		
Critical design hour	8:00:00		
Solar Angle	Azimuth (°)	246	
	Elevation (°)	55	
Ventilation			
Space Volume (m ³)	216		
Wind speed in m/s	3,23		
Air changes per hour	10		
f ₁ Wind incidence angle	90°		
f ₂ Correction factor due to site	Airport or open fields (Night time)		
f ₃ Correction factor due to the surrounding g(distance)/h(obstacle height) ratio	2		
f ₄ Multiplication factor due to height	Others		
Opening system (Inlet)	Blinds		
Opening system (Outlet)	Net area		
	<small>Net area</small> Sliding window, clear opening or projecting win Pivot or swinging window Blinds		
Ventilation			
Inlet: total opening area in m ²	14,04		
Outlet: total opening area in m ²	4,92		
Natural lighting strategies			
Identify that are predominantly over lit areas, areas in the optimal range of lightning levels and those which are poorly lit			
Glare control zones (ZCD), consider furniture and matte finishes and/or dark halftones in materials			
Zone of lighting autonomy (ZAL)			
Zone with constant support of artificial lighting (ZIA), use punctual artificial lighting as support for those areas, consider generating different circuits that can be independdly used			

Figure 4: Passive design strategies calculator

To use the calculator, the designer should enter the data requested in the first column. Once the data is entered, the second column will display the design criteria, as shown in Figure 4. Table 2, shows the instructions on how to read the results obtained in the calculator.

Solar protection strategies		
Critical design date	Indicates the date with the highest solar exposure according to the given orientation	
Critical design hour	Indicates the hour with the highest solar exposure according to the selected time range	
Solar Angle	Azimuth	Angle of solar exposure in the top view
	Elevation	Angle of solar exposure in the section view
Ventilation		
Required inlet area in m ²	Opening area required in facade according to its efficiency	
Require outlet area in m ²	Opening area required in facade according to its efficiency	
Observation: The efficiency of the type of opening will depend on the particular characteristics of each system, for this exercise the following efficiencies are assumed. Net area: 1; Sliding or projecting window open at 90°: 0.8; swinging or pivoting window: 0.6; and blinds: 0.3. If you have a different window system, take the total opening area and divide by the systems efficiency.		
Lighting		
Due to the multiplicity of factors that affect the behaviour of natural lighting is recommended to identify the areas that are over lit, illuminated in the optimum range or poorly lit, and implement the recommendations included in the calculator.		

Table 2: How to read the tools results

5. APPLICATION EXAMPLE. CASE STUDY MEDELLIN

This chapter contains an application example of the use of the calculator. Passive design strategies are chosen for two (2) facade's orientation, the (N) and the (W), which represented the most favorable and critical conditions, respectively, during the diagnosis of solar and wind exposure. As an architectural approach, a flexible, modulated facade was chosen, dividing it into a basic grid with divisions of 1m in the horizontal and 0.6m in the vertical 0.6m. Each module is a projecting. This element is made of wooden slats framed in metal profiles, and inside, a clear glass that has no solar protection coefficient. The opening angle, density and size of the slats depend on the requirements for solar control of the facade's orientation; the windows operation will be defined according to the ventilation needs. Inside the space, 0.75 m from the floor surface (work plane height) is taken as the evaluation height, and the dimensions of the Latin-American population are taken as a reference for comfort analysis purposes (Ávila, Prado, & González, 2007).

5.1 Solar protection criteria

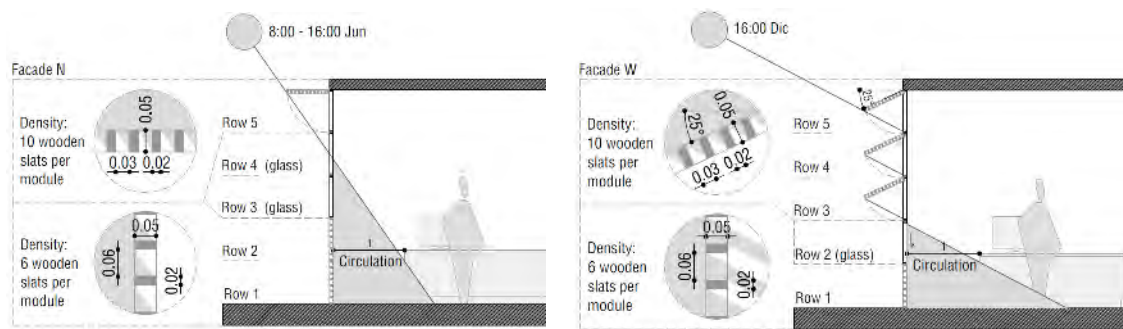

Figure 5: Application of elevation angles for defining elements of solar shading

The facades were divided into rows. According to the defined range of solar control, Figure 5 presents the design strategies apply for both facades, where rows that require solar protection are identified, and for those rows where protection is not needed, the dimensions of the wooden slats and densities of them are given.

5.2 Natural ventilation criteria

The method used to calculate the areas required for ventilation, assumes two openings of equal size, one as an inlet and the other as an outlet. Table 2 gives the total opening area required, which is modified by the loss of efficiency, depending on the chosen opening system.

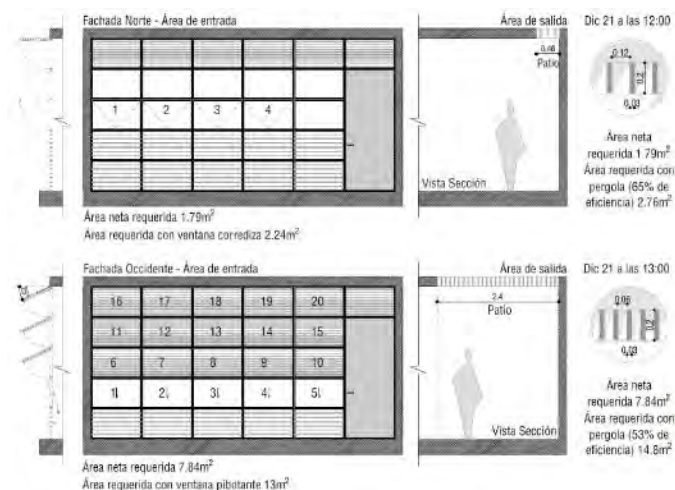

Figure 6: Distribution of the required opening areas in the N and W facades

The facade is assumed to be the inlet location, and a patio is located on the back of the module as the outlet. The **space under the patio is not considered as a “useful area” and can receive sun and rain.** Figure 6 shows the application of this element in the hypothetical model.

5.3 Daylight criteria

The lighting simulations were performed considering the new composition of the facade. For each sample orientation the work plane areas which were over lit, illuminated in the optimum range of lightning levels or poorly lit, were identified. Based on this information, a zoning of electrical circuits was outlined in order to achieve a balance in the light curve, generating visual comfort for the space users and reducing energy consumption by preventing the unnecessary use of artificial lighting.

The space is classified into three zones: areas of lighting autonomy (ZAL), areas with constant support of artificial lighting (ZIA) and glare control areas (ZCD). The first category includes all areas that present appropriate lightning levels within the optimal range required by the spatial typology; the second one gathers the areas of the work plane

that are poorly lit and do not reach the minimum required lighting levels at any time of the year; finally, the third category refers to those areas that exceed the maximum levels, and therefore require glare control strategies.

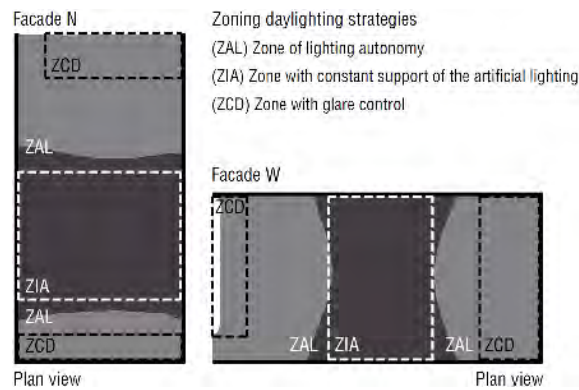

Figure 7: Space zoning to apply lighting strategies, for the modules orientation towards N and W.

6. CONCLUSIONS

As it was shown in the application example, for the architectural typology analyzed in this exercise, all orientations can get the same level of solar control, although the E and W facades require greater design efforts to obtain the same results, than those required by facade N. This refers only to solar shading, in future applications the influence of other variables, such as the thermal behavior, materials and different envelope compositions, should be evaluated.

In the model and the studied space **type, it is not possible to achieve optimal Ach (30), when the space's main open facade is parallel to the wind direction.**

According to the lighting diagnosis which was performed, between 40% and 50% of the total area of the work plane, have lighting autonomy, in both resulting inner environments. This value represents a significant portion of the area, which with a proper distribution of the electrical circuits, can be translated into energy savings by having a lower consumption due to artificial lighting use.

Having a tool that allows unfamiliar architects with the subject of bioclimatic and solar passive design, obtain basic guidelines to integrate the principles of this discipline to their designs, allows to develop an architecture with a greater environmental quality for space users, which in return, decreases environmental impacts. This tool can be applied in the city of Medellín, additionally this methodology can be replicated in cities located in the tropics, which have similar climatic conditions.

REFERENCES

- [1] Arquitectos, P. (n.d.). Diagramas de sombra.
- [2] Ávila, R., Prado, L., & González, E. (2007). Dimensiones antropométricas de la población latinoamericana _ México, Cuba, Colombia, Chile _ R. Avila Chaurand, L.R. Prado León, E.L. González Muñoz.pdf (Segunda ed). Guadalajara, Jalisco: Universidad de Guadalajara.
- [3] Bermudez, S. M. (1969). Asoleamiento Teoría General y Diagramas.
- [4] IDEAM. (1999a). Climatografía de la principales ciudades.
- [5] IDEAM. (1999b). Información Aeronáutica.
- [6] Ministerio De Minas Y Energía. (2015) Reglamento Técnico De Iluminación y Alumbrado Público. RETILAP
- [7] Olgay, V. (2002). Arquitectura y clima (Segunda).
- [8] Tobar Arango, J. (2004). Aire acondicionado para arquitectos. Medellín.

An Integrated Model for Urban Microclimate and Building Energy in High-Density City for Early Stage Design

HUANG Jianxiang^a, Phil JONES^b, PENG Rong^c

^a The University of Hong Kong, Hong Kong SAR, jxhuang@hku.hk

^b Cardiff University, United Kingdom, jonesp@cardiff.ac.uk

^c The University of Hong Kong, Hong Kong SAR, pengrann@hotmail.com

ABSTRACT

The energy performance of an urban building is depended on its surroundings, such as the cast shadows of the nearby buildings, variable air temperature due to radiative trapping in street canyons and anthropogenic heat sources. Existing building energy models are limited in the consideration of the micro-scale variations of the surrounding environment, which can be significant for high-density cities like Hong Kong. In this paper, an integrated urban microclimate and building energy model was developed to assess the energy performance of a cluster of buildings in high-density cities. Results are evaluated by the field measurement data conducted in the Sai Ying Pun neighbourhood in Hong Kong. Measured air temperature, wind speed, and building wall temperature are compared with those simulated by the model. The study enriched modelling literature at the scale of building clusters and contributed to the methodologies of integrated simulation in urban microclimate and building energy. The model has potentials to support building design and urban planning at early stage.

Keywords: building energy simulation, urban microclimate, numerical modelling, high-density cities

1. INTRODUCTION

A building modifies its surrounding microclimate, sunlight, wind, and temperature. This modification affects its own energy performance and those nearby. Overshadowing by neighbouring buildings affects solar radiation; temperature fluctuation of external wall surfaces modifies long-wave heat exchanges. Air temperature in street canyons can rise 4 - 6°C above those of the rural areas (Nichol 2005, Chen et al. 2012), which will affect building energy performance. This effect modifies localized microclimate, thermal comfort, and the use of outdoor spaces (Huang et al. 2016). This interdependency calls for better coordination in the design of a cluster of buildings. Hong Kong's high-rise towers, however energy-efficient they may be, can create the 'wall effects' (Wong et al. 2011) which stagnate airflow (Lau and Ng 2013), raise air temperature (Nguyen et al. 2011), increase the use of air-conditioning in nearby homes. This phenomenon has concerned urban planners and policy makers in recent years (Chen and Ng 2011).

In practice, most buildings are not designed to operate in the actual surrounding microclimate. Most building energy models uses meteorological data that are obtained from rural weather stations; some take into account the urban climate effect at city-scale (Bueno et al. 2013). Rarely can a building energy model account for the modifying effect of both solar radiation and air temperature. This gap in research literature is critical at the scale of building clusters and the space in-between (50 - 500m) in which most planning and development projects are commissioned. Building energy models such as EnergyPlus (Crawley et al. 2001), Ecotect (Li et al. 2014), or IES VE (Crawley et al. 2008) do not account for localized microclimate; Instead, designers rely on weather data measured at remote rural stations which differ considerably from those of an urban site. Urban climatology models often look at city-scale (>1km) which is less useful for the design of buildings.

Currently, there are no tools that can assess the interactions between urban microclimate and building energy performances (Bouyer et al. 2011). The Computational Fluid Dynamics (CFD) method is the primary tool applied in urban microclimate analysis (Chen and Srebric 2000; Bruse and Fleer 1998). It is computationally expensive which cannot be easily coupled with other simulation platforms (Novoselac and Srebric 2002) and it is unsuitable to assess large districts and complex urban configurations (Yang and Li 2009). Recent urban energy assessment tools such as CitySim (Robinson et al. 2009) and UMI (Reinhart et al. 2013) made great progress in European and North American context; yet both accept simplified assumptions in airflow or air temperature which may limit their application in high-density cities.

We developed an integrated model by coupling a multizone airflow network model for urban microclimate with the building energy model (HTB2). To the best of our knowledge, this is the first fully-coupled model between urban microclimate and building energy. Results are evaluated using field experiment conducted on a site of 100 buildings in Sai Ying Pun, Hong Kong. Model results agreed reasonably well with measurement data. Major contributions of this research lies the following aspects: 1) We developed and evaluated an integrated model that can describe the energy performance of a cluster of buildings in place of the surrounding microclimate; 2) The research contributed to the literature of environmental modelling at the scale of a cluster of buildings (50 - 500m) in which most buildings and urban design projects are commissioned; 3) The integrated model can be a useful tool to support sustainable design at early stage.

2. METHODS

The integrated model is based on the Urban Microclimate Model (UMM) (Huang et al. 2015) and a Building Energy Model (BEM) of HTB2 (Jones et al. 2013; WSA 2014). The UMM provides localized external air temperature to BEM, while external building surface temperature and HVAC exhaust data, calculated by BEM, will be provided to UMM in return. The conceptual strategy for the integrated urban microclimate and building energy model is illustrated in Figure 1.

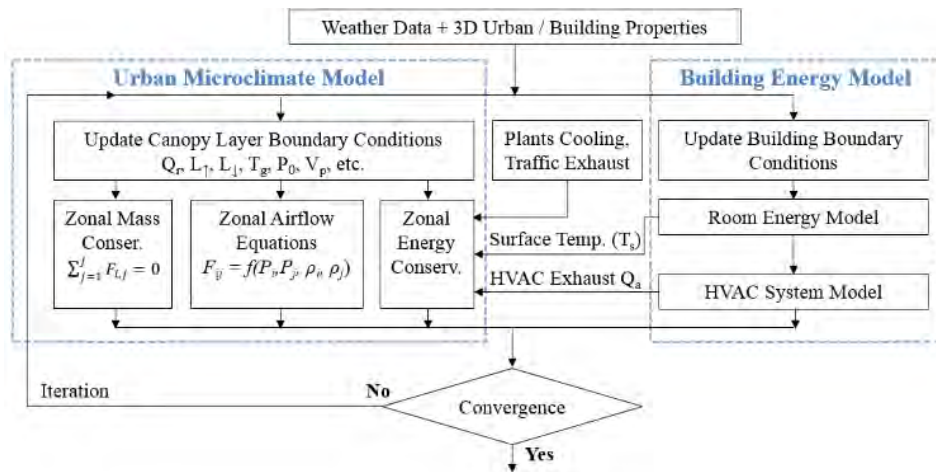

Figure 1: Conceptual strategy for the integrated urban microclimate and building energy model

2.1 Building energy model

Energy performance of individual buildings was modelled using HTB2, an established building energy model (Lewis and Alexander 1990). HTB2 describes energy exchanges among buildings, the external environment, and the heating/ cooling systems in heat fluxes as well as the movement of air and moisture (Figure 2 (left)). The model simulates the dynamic exchanges of mass, energy and moisture exchanges among space. The model takes input information of weather data, 3D spaces and building elements, i.e. walls and windows. Virvil (Figure 2 (right)), a software plugin for SketchUp, has been developed to process 3D geometries spaces and building elements (Jones et al. 2013) in order to simulation energy performance at urban scale.

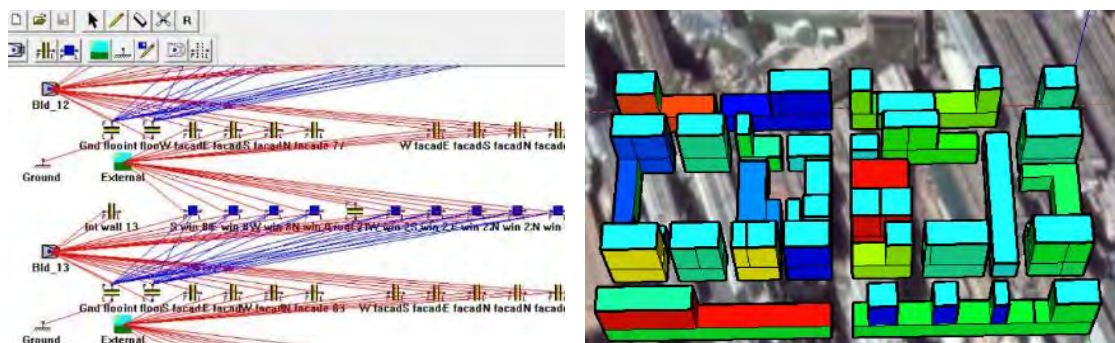

Figure 2: Schematic of HTB2 building energy Model and the Virvil Plugin (HTB2 User manual 2.10)

2.2 A MultiZone model for urban microclimate

We use a multizone airflow network model (Huang et al. 2015) to assess mass and energy in the air of the outdoor space, a simplified approach first developed to describe indoor environments (Musy et al. 2001). We divide the urban canopy layer into a series of semi-enclosed 'zones' resembling a roofless building. The air within the UCL exchange mass and energy with urban surfaces, anthropogenic heating/cooling sources, the Urban Boundary Layer (UBL) above, and the Rural Boundary layer (RBL) on its side (Figure 3 (left)). To simplify, we assume airflow is driven by pressure, temperature and density differences, upholding mass and energy conservations while relaxing the momentum conservation equations. We hypothesize that this relaxation works in high-density cities where wind-drive flow are stagnant yet buoyancy flow dominates (Yang and Li 2009).

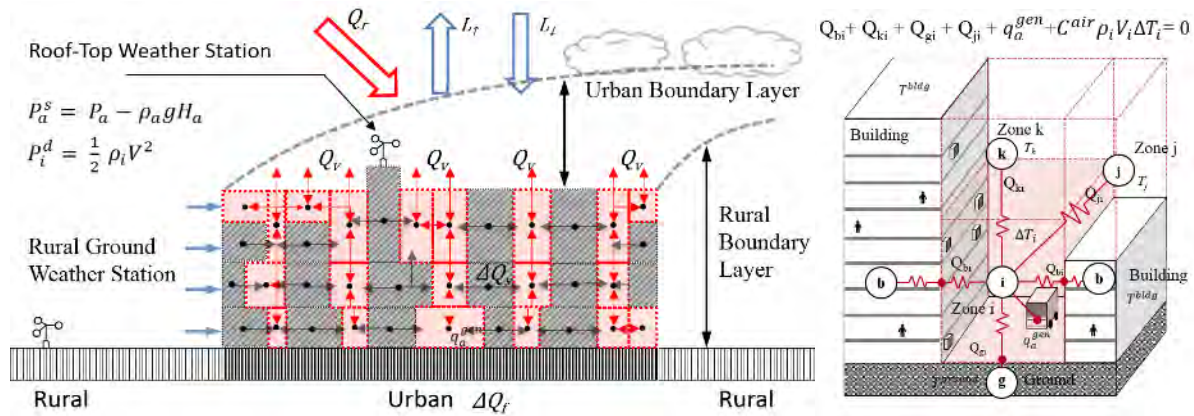

Figure 3: Schematic depiction of the urban microclimate model

The air within each zone is characterized by a uniform temperature (T_i) and density (ρ_i). The zonal air pressure (P_i^e) at any given height (e) is expressed as $P_i^e = P_i^c - \rho_i g H_e$ (1), where P_i^c is the air pressure at the geometric centre of the zone, and H_e is the vertical distance from the zone centre. Pressure, temperature, and density observe the law of the ideal gas ($\rho_i = P_i T_i / R_{air}$ is the gas constant). The airflow rate F_{ij} from zone i to neighbouring zone j is a function of pressure and density differences at the border and characteristics of the openings $F_{ij} = f[\Delta P_{ij}, \Delta \rho_{ij}, A_{ij}]$. Mass conservation is observed in each zone $V_i \frac{\partial \rho_i}{\partial t} + \sum_{j=1}^J F_{i,j} = 0$. Since massing changes caused by density difference is often negligible, we have $\sum_{j=1}^J F_{i,j} = 0$ (ASHRAE 2009). Airflow models calculating the F_{ij} and F_{ji} are provided in the authors' earlier work (Huang et al. 2015).

Energy conservation equation for the body of air within zone i is expressed in formula, which describes heat transfer from solid surfaces, airflows to and from neighbouring zones, thermal massing, and anthropogenic heat generation (vehicles & AC unites):

$$\frac{\partial T_i}{\partial t} C_p \rho_i V_i = \sum_{k=1}^K h A (T_k^{surf} - T_i) + \sum_{a=1}^A \lambda q_a^{gen} + \sum_{j=1}^J (C_p F_{ij} T_i - C_p F_{ji} T_i)$$

Equation 1

where K is the number of enclosing solid surfaces, each with the surface temperature of T_k^{surf} ; h is the convective heat transfer coefficient between solid surfaces and air; T_k^{surf} is the temperature for each solid surface; A is the number of active heat sources within zone i , q_a^{gen} and λ are the power and operational coefficient of each heat source; F_{ij} and F_{ji} are the airflow rates between zone i and neighbouring zone j ; J is the number of neighbouring zones; C_p and V_i are the specific heat capacity and volume of the zonal air.

2.3 Combination of UMM & BEM

We assume each individual building is treated as one or multiple indoor zones with predefined temperature/humidity conditions. Each indoor zone exchanges energy with those of outdoors via conductive and radiative heat transfer. Mass exchanges occur via HVAC systems and natural ventilation. For each building zone with n surfaces, the energy conservation equation is expressed in formula below

$$\frac{\rho_{air} C_p V_{room} \Delta T}{\Delta t} = Q_{other} + Q_{HVAC} + \sum_{k=0}^n U_k A_k (T^{internal} - T_k^{surf})$$

Equation 2

in which Q_{other} is heat gains from internal lights, people, appliances, infiltration, etc. Q_{HVAC} is the rate of heat gains (+) or extraction (-) from building HVAC system. ρ_{air} is the air density; V_{room} is the zone volume; ΔT is the rate of temperature change of indoor zone; Δt is the time interval between each time step. U_k and A_k is the U-value and area of each wall k ; $T^{internal}$ is the set temperature for each indoor zone; T_k^{surf} is the surface temperature for each building surface (walls or roof), which can be estimated by solving energy conservation at each surface expressed in formula below

$$\frac{\Delta T}{\Delta t} C_k M_k = (1 - Al_k) E_k + U_k (T^{internal} - T_k^{surf}) + h(T_i - T_k^{surf}) + \frac{1}{2} \epsilon \sigma (T_k^{mrt^4} - T_k^{surf^4})$$

Equation 3

where Al_k is the albedo of the surface material; E_k is the incoming solar radiation intensity which is accurately calculated using backward ray-tracing methods, where a series of rays will be fired from the centre of the building surface, each returns the property of the obstacle reached, be it buildings, terrain, vegetation or sky dome; T_i is localized air temperature immediately outside of the wall; h is the convection heat transfer coefficient, a function of wind speed and horizontal/vertical position; ϵ and σ is the surface emissivity and Stephan-Boltzmann's constant; T_k^{mrt} is the mean radiant temperature at the building surface. $\frac{\Delta T}{\Delta t}$ is the surface temperature changes during each minuscule time-step; M_k and C_k is the mass and material specific heat capacity of the surface.

2.4 Field studies

To evaluate predicted localized air temperature and surface temperature of building facades, we conducted field experiments in Sai Ying Pun, a high-density neighbourhood in Hong Kong. Measurement was taken on December 9, 2014, a sunny winter day allowing us to avoid uncertainties associated with anthropogenic heat emission from window AC units. The study session lasted from 8:00 to 22:00.

Figure 4 describes the study location and site condition. Meso-scale prevailing wind speed was measured as 4.05 m/s from south west (225° from north) during the study day. Four measurement locations from A to D were chosen. Site A is on the sidewalk of Des Voeux Street, a main street with 4-lane vehicular traffic. Site B is at the road intersection between the Western Rd. and Queen's Rd. West; Site C is in Sai Yuen Lane, a narrow alleyway inside the residential block. Site D is at the end of Chung Ching Street. The street width, density and configurations vary among the 4 sites, allowing for considerable variable in microclimate attributes.



Figure 4: The Sai Ying Pun area and 4 measurement locations (A, B, C, & D) source: Google Earth (300 by 160 meters)

Air temperature and wind speed were measured at the four locations at 1.5 meters above ground. An infrared camera (FLIR E40-NIST) was used to measure surrounding surface temperatures at hourly interval. Vehicular and pedestrian traffic were recorded at Site A and Site B to calculate the anthropogenic heat. A 3-min video were recorded at hourly interval. We counted the number of pedestrians and automobiles as well as the composition of vehicular fleet.

The weather input is obtained from the nearest weather station of Hong Kong Observatory weather station (HKO) network on 9 December, 2016 from 8:00 - 22:00 (Table 1). The wind speed of the simulation domain was adjusted from the weather station according to the exponential vertical profile.

Hour	8:00	9:00	10:00	11:00	12:00	13:00	14:00	15:00
Pressure(kPa)	102.39	102.35	102.29	102.20	102.09	101.99	101.93	101.94
Air Temp.(°C)	18.4	19.1	20	20.6	20.6	20.3	20.5	20.3
Wind speed (m/s)	2.3	2.1	1.5	1.5	2.0	2.2	1.4	1.2
Wind direction (°)	30	30	50	60	50	50	50	190
Hour	16:00	17:00	18:00	19:00	20:00	21:00	22:00	
Pressure(kPa)	101.97	102.02	102.05	102.10	102.14	102.14	101.97	
Air Temp.(°C)	19.7	19.7	19.5	19.8	19.8	19.7	19.6	
Wind speed (m/s)	2.6	2.9	3.1	3.2	3.4	3.5	3.8	
Wind direction (°)	50	50	50	60	60	50	50	

Table 1: Input hourly weather data measured from Hong Kong observatory weather station network on December 9, 2014. Air temperature and pressure are from Hong Kong observatory station (32 meter above sea level), wind speed and direction are measured by anemometer in green island (107 meter above sea level). Wind direction is degrees clockwise from north.

3. RESULTS

We modelled the Sai Ying Pun neighbourhood using the integrated model. The 3D building model domain consists of 71 external zones and 28 buildings. We divided the external zones in two vertical layers, allowing conditions to vary at near-ground (0 - 20m) and higher above (20 - 50m). Four measurement points related to those of the field studies were placed accordingly.

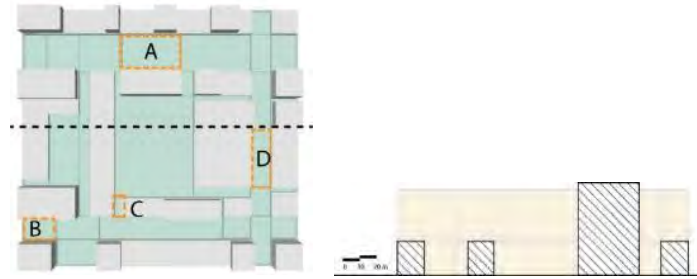

Figure 5: Model domain, 3D building geometries and measurement locations

Model results included surface temperature, air temperature and wind speed at 4 locations. Figure 6 shows predicted air temperature at 4 locations. All curves show coherence of changing trend. The systematic offset is caused because of input environmental temperature. Weather station at Hong Kong Park is 30 meter higher in elevation and in rural area, which is almost 2°C lower than survey area. Figure 7 shows predicted result air temperature and wind direction. The temperature is significant lower in narrow areas than spacious one.

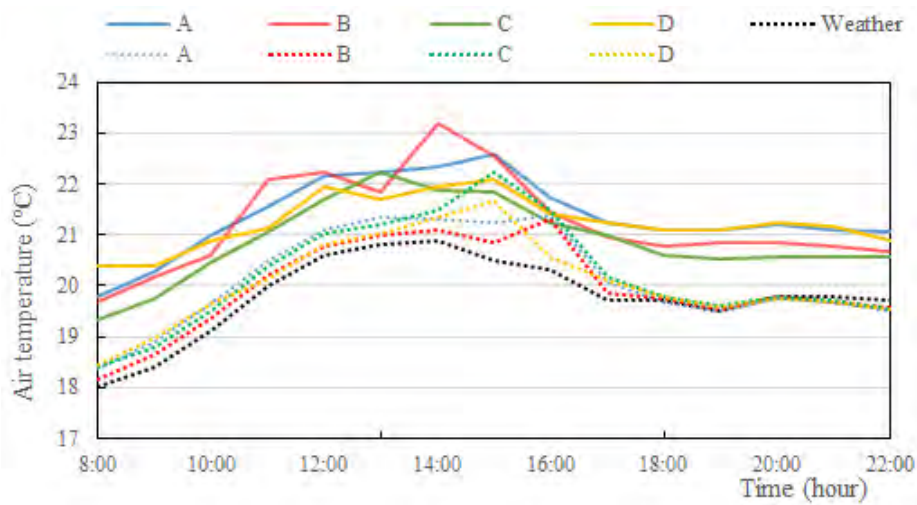

Figure 6: Predicted and measured air temperature at four measurement points. The solid lines are the measurement results, the dash lines are the simulation results of the model.

A visualization of predicted air temperature and wind flow are shown in Figure 7. Zones to the north were of higher temperature than those to the south due to the influence of solar heat gains from building walls.

Comparing Figures a and b, which are at 2 and 3 pm respectively, it is clear that changes of wind speed and direction produce dramatic fluctuation air temperature and flow.

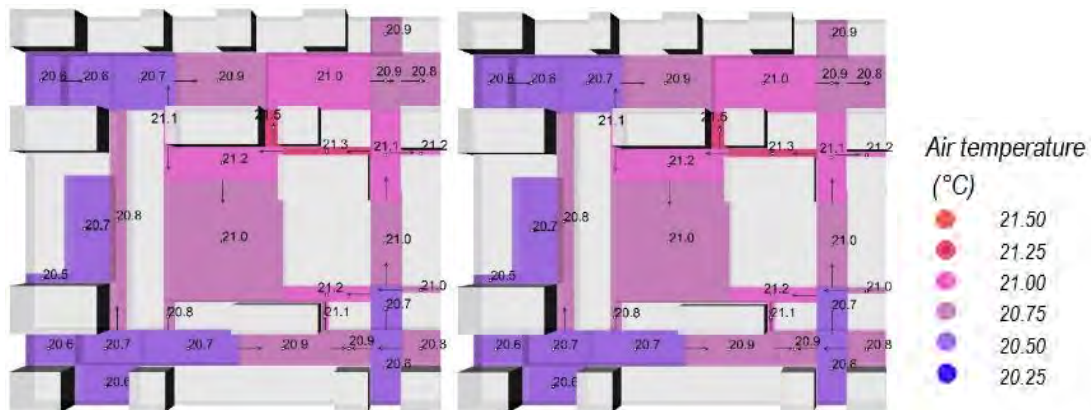

Figure 7: Predicted air temperature (in color) and airflow direction (in arrow) at on December 9, 2014. a) 2 am with wind speed at 1.4 m/s from south-west; b) 3 am with wind speed 1.2 m/s from north-east

Ideally, the system reach balance when amount of air flow in and out of reach zones are closed to each. Test shows that both overall system balance and maximum balance works. The simulation stops when maximum air flow quantity in both vertical and horizontal direction close to each other.

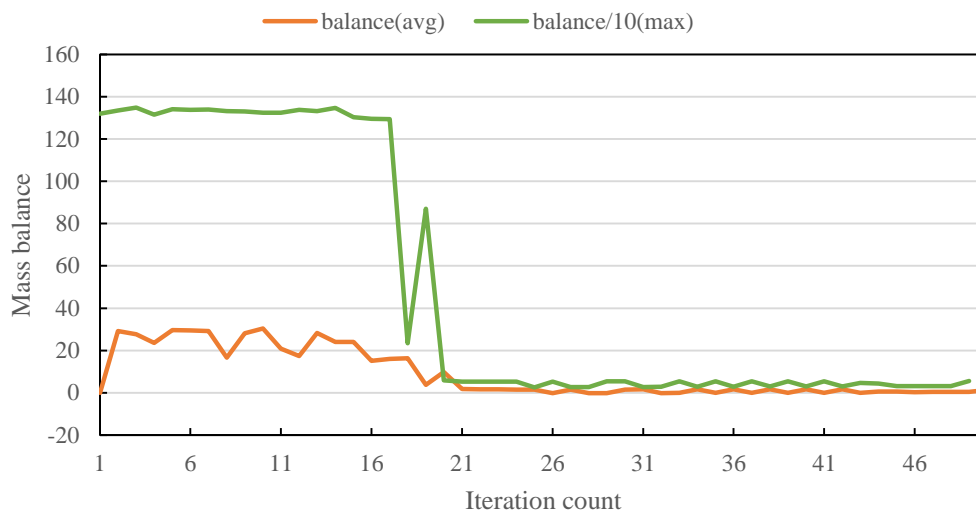

Figure 8: Model convergence criteria, heat balance of whole system

4. CONCLUSION

An integrated model for urban microclimate and building energy was developed. Field measurements were **conducted in Hong Kong's high-density urban area** to partially evaluate the model performance. Simulation results of the outdoor air and building façade temperatures within street canyons showed considerable variations among measurement spots. Although results have not reached satisfactory agreement with measurement data. We expect the reasons being complications from anthropogenic heat sources from traffic, restaurant that were unaccounted for in the model simulation at this stage. The next step is to address the limitations mentioned above and further evaluate the integrated model.

ACKNOWLEDGEMENT

The study is partially supported by the University of Hong Kong SEED Funding for Basic Research (#201509159015, #201411159071) as well as the SEED funding from HKUrban Lab, Faculty of Architecture, The University of Hong Kong.

REFERENCES

- [1] Bouyer, J., Inard, C., & Musy, M. (2011). Microclimatic coupling as a solution to improve building energy simulation in an urban context. *Energy and Buildings*, 43(7), 1549–1559. doi:10.1016/j.enbuild.2011.02.010
- [2] Bruse, M., & Fleer, H. (1998). Simulating surface–plant–air interactions inside urban environments with a three dimensional numerical model. *Environmental Modelling & Software*, 13(3-4), 373–384. doi:10.1016/S1364-8152(98)00042-5
- [3] Bueno, B., Norford, L., Hidalgo, J., & Pigeon, G. (2013). The urban weather generator. *Journal of Building Performance Simulation*, 6(4), 269–281. doi:10.1080/19401493.2012.718797
- [4] Chen, Q., & Srebric, J. (2000). Application of CFD Tools for Indoor and Outdoor Environment Design. *International Journal on Architectural Science*, 1(1), 14–29.
- [5] Crawley, D. B., Hand, J. W., Kummert, M., & Griffith, B. T. (2008). Contrasting the capabilities of building energy performance simulation programs. *Building and Environment*, 43(4), 661–673. doi:10.1016/j.buildenv.2006.10.027
- [6] **Crawley, D. B., Lawrie, L. K., Winkelmann, F. C., Buhl, W. F., Huang, Y. J., Pedersen, C. O., ... Glazer, J.** (2001). EnergyPlus: creating a new-generation building energy simulation program. *Energy and Buildings*, 33(4), 319–331. doi:10.1016/S0378-7788(00)00114-6

- [7] Huang, J., Zhang, A., & Peng, R. (2015). Evaluation the MultiZone Modle for Street Canyon Airflow in High-Density Cities. In 14th International Conference of the International Building Performance Simulation Association (Vol. 1). Hyderabad, India.
- [8] Huang, J., Zhou, C., Zhuo, Y., Xu, L., & Jiang, Y. (2016). Outdoor Thermal Environments and Activities in Open Space: An Experiment Study in Humid Subtropical Climates. *Building and Environment*. doi:10.1016/j.buildenv.2016.03.029
- [9] Lau, K. L., & Ng, E. (2013). An investigation of urbanization effect on urban and rural Hong Kong using a 40-year extended temperature record. *Landscape and Urban Planning*, 114, 42–52. doi:10.1016/j.landurbplan.2013.03.002
- [10] Lewis, P. T., & Alexander, D. K. (1990). HTB2: A flexible model for dynamic building simulation. *Building and Environment*, 25(1), 7–16. doi:10.1016/0360-1323(90)90035-P
- [11] Musy, M., Wurtz, E., Winkelmann, F., & Allard, F. (2001). Generation of a zonal model to simulate natural convection in a room with a radiative/convective heater. *Building and Environment*, 36(5), 589–596. doi:10.1016/S0360-1323(00)00043-3
- [12] Nichol, J. (2005). Remote sensing of urban heat islands by day and night. *Photogrammetric Engineering and Remote Sensing*, 71(May), 613–621. doi:10.14358/PERS.71.5.613
- [13] Novoselac, A., & Srebric, J. (2002). A critical review on the performance and design of combined cooled ceiling and displacement ventilation systems. *Energy and Buildings*, 34(5), 497–509. doi:10.1016/S0378-7788(01)00134-7
- [14] Reinhart, C., Dogan, T., Jakubiec, J., Rakha, T., & Sang, A. (2013). UMI - An urban simulation environment for building energy use, daylighting and walkability. In 13th Conference of International Building Performance Simulation Association, Chambéry, France.
- [15] Robinson, D., Haldi, F., Kampf, J., Leroux, P., Peresz, D., Rasheed, A. & Wilke, U. (2009). CitySimCitySim: Comprehensive micro-simulation of resource flows for sustainable urban planning. In 11th Conference of International Building Performance Simulation Association, Glasgow, Scotland.
- [16] **Wong, M. S., Nichol, J., & Ng, E. (2011). A study of the “wall effect” caused by proliferation of high-rise buildings using GIS techniques. *Landscape and Urban Planning*, 102(4), 245–253. doi:10.1016/j.landurbplan.2011.05.003**
- [17] Yang, L., & Li, Y. (2009). City ventilation of Hong Kong at no-wind conditions. *Atmospheric Environment*, 43(19), 3111–3121. doi:10.1016/j.atmosenv.2009.02.062
- [18] Yang, L., He, B.-J., & Ye, M. (2014). Application research of ECOTECT in residential estate planning. *Energy and Buildings*, 72, 195–202. doi:10.1016/j.enbuild.2013.12.040

Re-Thinking Courtyard Housing: Development of Traditional Islamic Courthouses into Zero-Energy Buildings

Samer EL SAYARY^a, Osama Mohamed OMAR^b

^a Beirut Arab University, Lebanon, s.sayary@bau.edu.lb

^b Beirut Arab University, Lebanon, o.omar@bau.edu.lb

ABSTRACT

Sustainable design is the philosophy of designing physical objects, building environments, and services that comply with the principles of social, economic and ecological sustainability (Lombard, L.P et al., 2008). The idea of courtyards as a method of plan configuration goes back to thousands of years to Neolithic settlements. In the beginning, the logic behind this configuration was mainly to provide a shelter against outside forces, such as invasions by humans and wild animals. Over time, it developed into a solid, logical configuration that not only maximizes the built-up area in the urban context but also allows controlling sunlight penetration, especially in regions where it is abundant. However, it soon became a generic typology in hot, arid, climatic landscapes and therefore formed the basis of the urban patterns of the Madina's in the Islamic World. Furthermore, the cultural relevance **of this plan's typology is of high importance (P. Torcellini et al., 2006). A preliminary study output was performed prior to this research to analyze various physical elements of traditional courtyard houses located in a hot, arid region in Egypt. This paper presents a research project carried out to explore the potentials of traditional Islamic courthouses and to develop them into zero energy consumption houses that suits the Egyptian contemporary lifestyle. Wide and vast studies were conducted to investigate the passive aspects of the traditional Islamic houses in Egypt and to analyze their architectural vocabulary responsible for creating a passive contemporary sustainable house. Then by developing these elements, using environmental analysis of energy consumption calculations and CFD simulations, a contemporary prototype house was proposed as a development of the traditional Islamic houses that were built in middle Ages in Middle East.**

Keywords: low-rise building, housing court house, zero energy house, CFD, sustainability

1. INTRODUCTION

Energy is one of the most important factors of development and production in most countries. The growing trend in building energy consumption will continue during the coming years due to the expansion of built area and associated energy needs, as long as resource and environmental exhaustion or economic recession allows it. Private initiative together with government intervention through the promotion of energy efficiency, new technologies for energy production, limiting energy consumption and raising social awareness on the rational use of energy will be essential to make possible a sustainable energy future as Lombart et al, 2008 indicated. In simple terms, a Net energy building is a very low energy building that balances its low annual energy consumption by the use of renewable energy on site.

To reach the Net-zero energy-building goal, we decided to conduct two important strategies at the design stage:

- To reduce demand using passive solutions and energy efficient systems.
- To generate sufficient electricity by renewable energy systems to achieve the desired energy balance.

Passive approaches play a crucial role in the design of Net ZEBs (Net Zero Energy Buildings) as they directly affect the heating, cooling, ventilation **and lighting loads put on the building's mechanical and electrical systems**, and indirectly reduce the sizing of the renewable energy systems that balance the consumption.

In 2005/2006, the Net zero buildings concept was still generic and in 2006 there was no harmonized understanding about what was really a Net Zero Energy Building (P. Torcellini et al., 2006). This was one of the principal motivations for an international collaborative research project that started in 2008 within the framework of the International Energy Agency "Towards Net Zero Solar Energy Buildings" (NZEBS, 2016). **The objective of the current study is to suggest a sustainable, zero energy consumption, contemporary courtyard house design in**

Alexandria city in Egypt as a development of the passive architectural vocabulary of the traditional Islamic courtyard houses and with the aid of recent computer Environmental analysis to act as a first prototype in such building.

Based on the climatic data of Alexandria downloaded from US department of Energy deduced from ZEH, 2016 and the features of traditional Islamic courtyard house the design has been established and then calculations were performed to compare the energy consumption in the traditional design and the new suggested design.

The courtyard as a volume inside the traditional Islamic courtyard house was re-defined and reshaped using previous environmental analysis to a new proposal to integrate the shade design with the cross ventilation design to eliminate the need of HVAC by achieving the thermal comfort inside the house.

1.1 Redefining zero energy house

The traditional ZEB definitions can be also divided according to the building type. In the prevailing literature there is almost no specific difference between the ZEB definition for neither a commercial building nor a residential building. Commonly in the publications three phrases are used: “zero energy building”, “zero energy house” and “zero energy home”. As the first term is the most comprehensive and includes both residential and commercial building, the two others typically are used for the residences (ZEBD, 2016).

With the ZEB concept gaining in popularity the literature on zero energy/emission buildings is also growing. Most of the publication focuses on documenting different ZEB demonstration projects without referring to the courtyard potentials ; however, a number of documents have significantly contributed to the discussion of understanding and re-defining new ZEB concept. One of those milestones is the report written by Torcellini, et al. in 2006. The authors point out that despite the exciting phrase of ‘zero energy’. Torcellini, et al (2006) indicate that the definition of ZEB concept can be constructed in several ways, depending on the project goals, intentions of the investor, concern about the climate changes and greenhouse gas emissions or finally the energy costs.

2. POTENTIALS OF COURT HOUSES VOCABULARY FORMULATING THE CONTEMPORARY DESIGN

2.1. Relation between zero energy approach and courtyard

Many studies were conducted on courthouses due to its high climatic potentials either in cold whether or hot arid areas. Edwards et al (Edwards B., et al., 2006) studied their climatic impact in his book. Courtyard housing is one of the oldest forms of domestic development spanning from at least 5,000 years and occurring in distinctive form in many regions of the world. Traditionally associated with the Middle East where climate and culture have given shape to a particular type of courtyard housing; other examples exist in Latin America, China and in Europe where the model has been reinterpreted.

Besides having double facades, by courts, one inner and the other outer so increasing the perimeter of the exposed walls to daylight, the Inner facades are under shade most of the day, so providing indirect lighting and good thermal environment. Also, Leslie Martin and Lionel March carried out an extensive study of the environmental performance of courtyards at Cambridge University in the late 1960s. In a number of influential papers they addressed the question: ‘What building forms make the best use of land?’ The question of course implies a definition of ‘best use’. Martin and March bound themselves to quantifiable parameters, such as ‘built potential (the ratio of the floor area of the built form to the site area) and ‘daylight availability’ (Martin, L. and March, L. 1972).

They analyzed different archetypal built forms, such as pavilions, streets and courtyards. Their findings, based on mathematical analysis, showed that the courtyard was eventually the best performing urban type in terms of efficiency in site coverage: the court form is seen to place the same amount of floor space on the same site area with the same condition of building depth and in approximately one-third the height required by the pavilion form.

The ingenious solution of the courtyard house type in hot-arid climates, such as in Egypt, is the use of high thermal mass to store heat through the expansive external surface area during the day in order to benefit from it during the cooler nights.

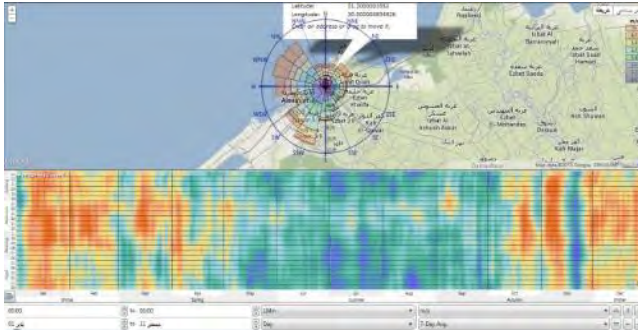

Figure 1: Wind rose of Alexandria

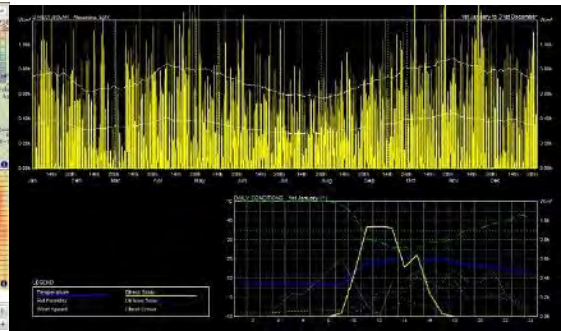

Figure 2: Alexandria average solar radiation

The proposed design, in the current study, addresses the following criteria in designing the new court:

- Increasing the surface to volume ratio to increase the perimeter of the inner façade, which results in a more indirect illumination of natural light.
- Increasing the shadow density based on the average data solar radiation (Figure 2) to create a thermal hot areas versus cold areas to help in breeze immigration from positive to negative pressure areas.
- Breaking down the one volume of the traditional court into multi-volumes to create cross ventilation from dominant wind patterns.
- Increasing sky view factor (SVF) to decrease the solar exposition to the open court aluminum shading louvers were introduced to the design. The function of these aluminum louvers is to reflect the indirect sun light into the court and derive the direct wind breeze into the court as well and to replace the traditional ancient Mashrabia in old courtyard Islamic houses.

The new court design has changed the introversion volume approach into broken down multi volumes mass to allow cross ventilation and was tested by Computational fluid dynamics (CFD) virtual wind tunnel simulation after processing the local digital file obtained from the US department of energy (ZEH, 2016) using the wind-Rose (Figure 1). The other parameter, LUX levels of natural light measurement, is based on detecting day lighting on the ground at hourly intervals on a piece of Alexandria city for a given day of the year (Figure 2). Then the average number of hours of shadows is calculated at each point. Steemers and Ratti (Steemers K. et al. 1999) used this parameter as an environmental indicator to inform bioclimatic urban design,

A thorough study were undergone by J. Climatol (Oke, T. 1981). When he indicate; the Sky View Factor was first introduced in heat transfer literature to model radiative exchange between surfaces, it also offers benefit in terms of urban climatology research. In fact, it represents a good measure of the openness of the urban texture to the sky and has been associated, among other indicators, to the increase in temperature in the urban context compared with the surrounding rural context-the so-called urban heat island phenomenon. The well-established relation between the Sky View Factor and the urban heat island consists of the observation that the smaller the Sky View Factor, the higher the temperature of cities (Oke, T. 1981).

By maximizing the surface to volume ratio, the courtyard acts as heat sink and therefore alleviates the extreme temperature stress: it reradiates this heat indoors as well as to the surrounding and to the sky during the cooler nights due to the time lag of the large thermal mass and the cooler air temperature.

Edwards B., et al., 2006 highlighted the suitability of courtyards for extreme climates due to their climatically buffering and filtering characteristics; he noted the prevalence of courtyard planning in hot-arid climates.

The sun concentrating character of cold areas courtyards is in fact due to the rather low height over width (H/W) ratio of the courtyard as observed by Mänty, which averages 0.6 in Scandinavian areas, compared to 1.3 in middle east as measured in the selected simplified prototype courtyard adopted for this study and more typical of hot-arid climates. It is in fact a matter of proportions that confers either the sun collecting or sun-protecting characteristic to the courtyard.

3. RESULTS AND DISCUSSION

In our proposed new design of the court, it was divided into multi small courts allowing the sun to enter simultaneously during the day hours. In addition to the design, other measures were taken to reduce the house energy consumption and achieve the target of ZEB: a) the substitution of traditional bulb lamps with LED lighting. b) The use of energy star appliances. c) The use of solar panels to provide required electricity. Figure 3 shows the plan of the designed house to be used in the power consumption calculation and its CFD model.

Energy consumption analysis of buildings is a difficult task because it requires considering detailed interactions among the building, HVAC system, and surroundings (weather) as well as obtaining mathematical/physical models that are effective in characterizing each of those items (University of Plymouth, Plymouth, UK, February 1999).

Although this difficulty we substituted the physical model using virtual simulations by Autodesk CFD simulation as a virtual wind tunnel simulation and Autodesk Ecotect 2011 in electrical consumption calculations and Lux levels of daylight using DIALux 4.

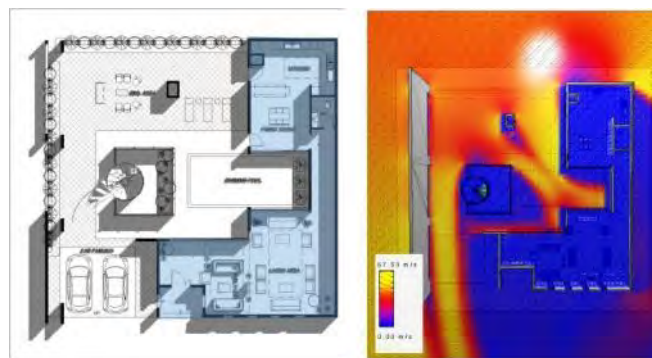

Figure 3a: Plan of the first floor of the suggested design and its CFD

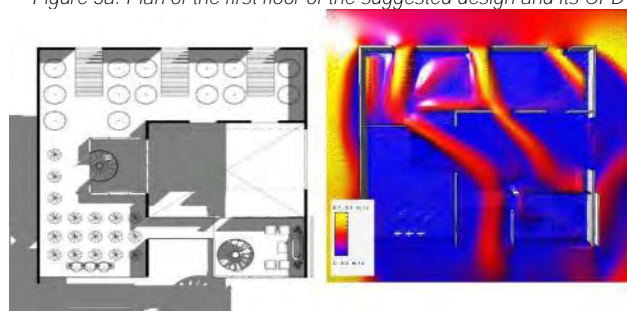

Figure 3b: Plan of the second floor of the suggested design and its CFD

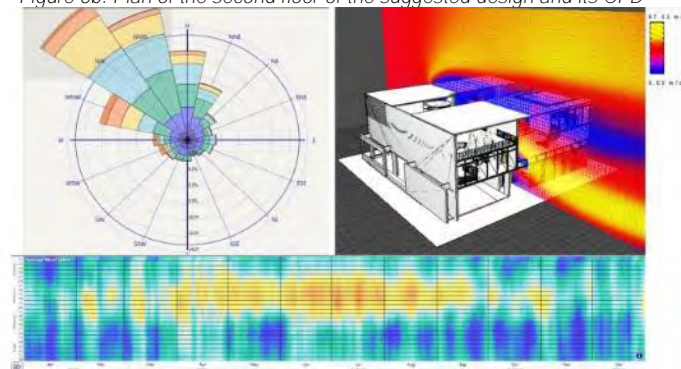

Figure 3c: CFD of the designed house

3.1 Hourly electricity use and energy consumption

By comparing the hourly electricity use before and after the energy conservation measures, it was found that an energy saving of about 60% was achieved as shown in (Figures 4 and 5). This can be attributed to the elimination of air conditioners need due to normal ventilation and the replacement of conventional appliances by energy efficient ones in addition to the increase in daylight factor.

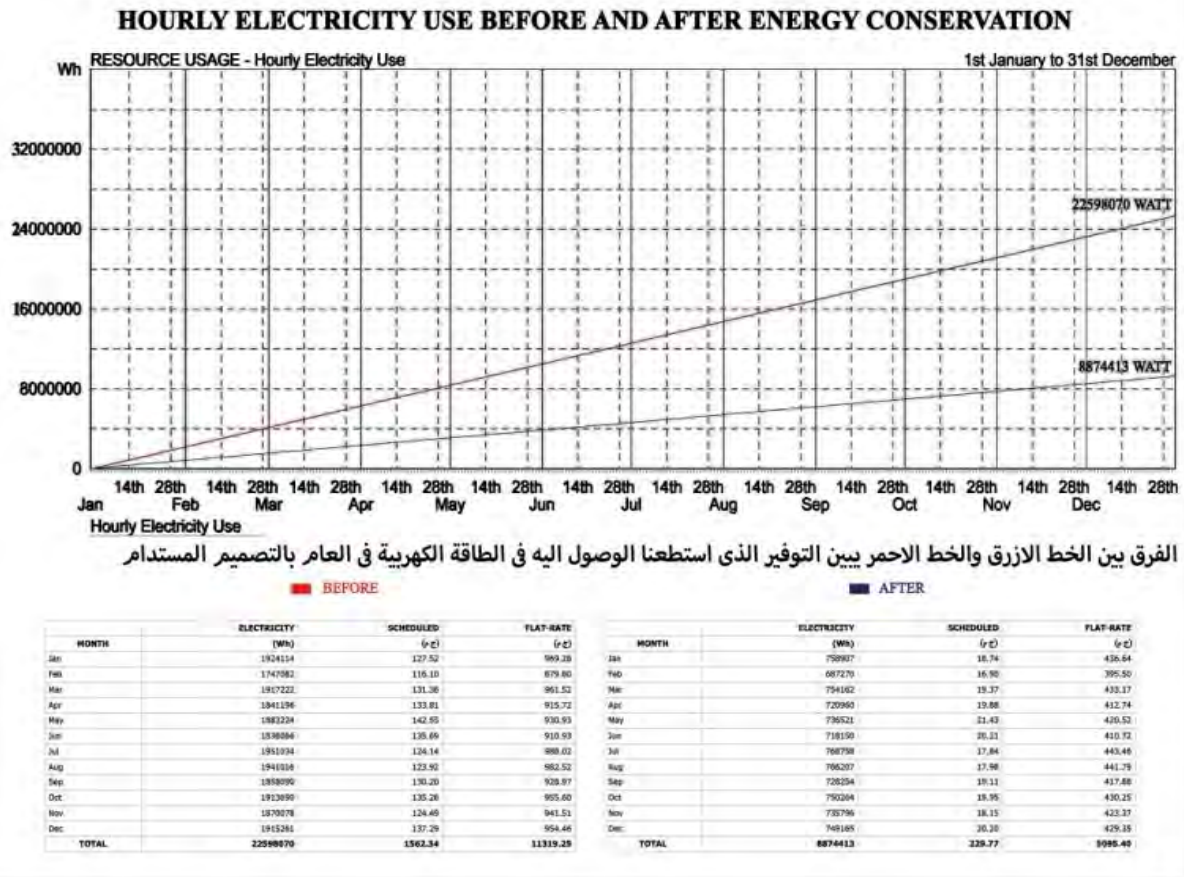

Figure 4: Hourly electricity use before and after conservation

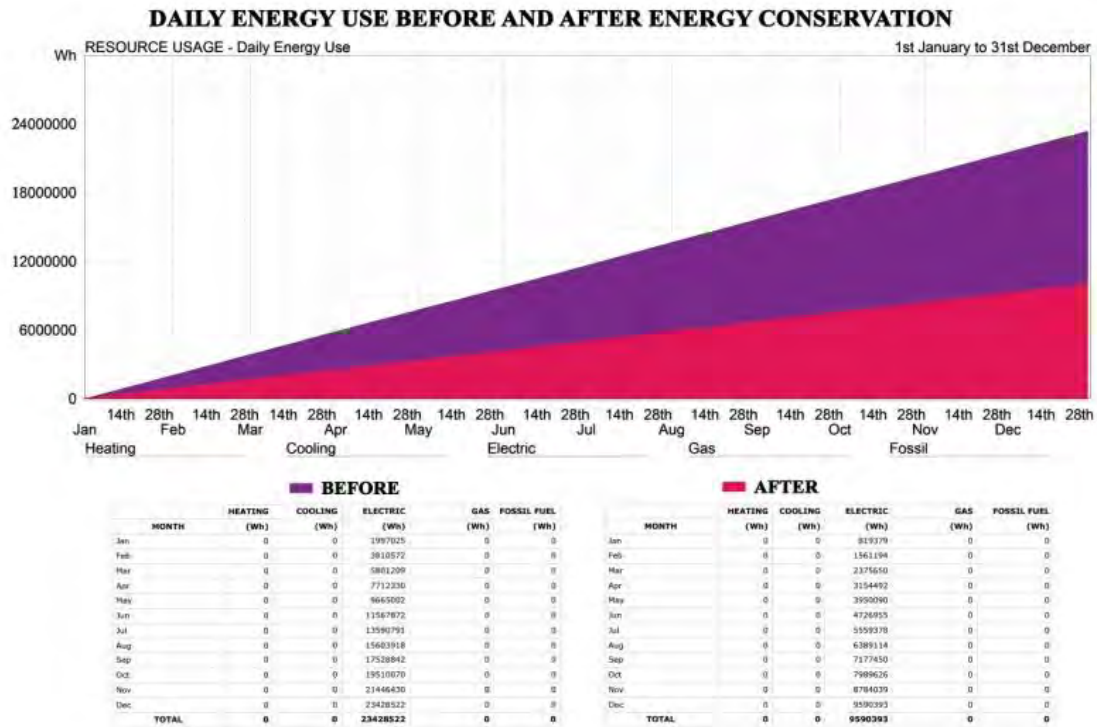

Figure 5: The daily energy use before and after energy conservation

3.2 Light measurement

The interplay between the divided volume of the courtyard surrounding the mass resulted in significance decrease in the need of artificial light as mentioned earlier. (Figure 6) shows the light measurement in Lux determining the sky view factor.

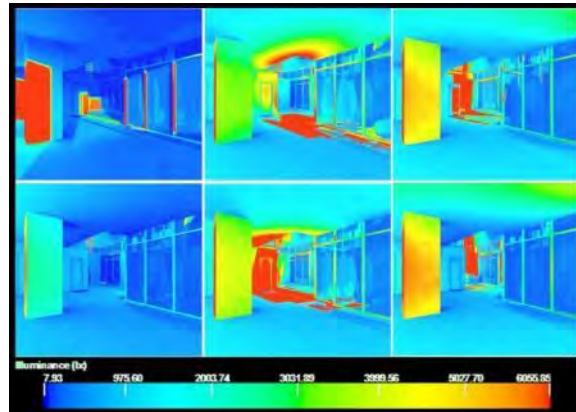

Figure 6: Light measurement in Lux

4. CONCLUSIONS

The overview and simulation of the blending of redefined courtyard and Net ZEBs carried out in the framework of this research has led to the identification of new ways of design for this type of ZEB courtyard house. The courtyard volume should be broken to multi-small courts scattered in the house mass in order to improve cross natural ventilation and daylighting. Its envelope should be multi-functional element to filter the outside environment to a set of free sources of energy such as wind, sun.

REFERENCES

- [1] L. P. Lombard, J. Ortiz, C. Pout. (2008). A review on buildings energy consumption information. *Energy and Buildings*, 40 (2008) 94–398.
- [2] P. Torcellini, S. Pless, M. Deru. *Zero Energy Buildings: A Critical Look at the Definition*. National Renewable Energy Laboratory (NREL) (2006).
- [3] *Towards Net Zero Energy Solar Buildings (NZEBs)*, IEA SHC Task 40/ECB Annex 52 [online]. Retrieved from: <http://task40.iea-shc.org/> [Retrieved on 25 September 2016].
- [4] Edwards B., Sibley M., Hakmi M. and Land P. 2006. *Courtyard Housing., Past, Present and Future*. Taylor & Francis 2 Park Square, Milton Park, Abingdon, Oxon, OX14, 4RN
- [5] L. Martin, L. and March, L. 1972. *Urban Space and Structures*. Cambridge at the University press, Cambridge.
- [6] K. Steemers, C. Ratti “*Informing Urban Bioclimatic Design*”, *Proceedings of the for Architectural Education (EAAE)*, (University of Plymouth, Plymouth, UK, February 1999).
- [7] T. Oke, Canyon geometry and the nocturnal urban heat island: comparison of scale model and field observations. *J. Climatol.* (1981)
- [8] *Zero Energy House*, [online]. Retrieved from: <http://www.energy.gov/> [Retrieved on 25 September 2016]. (ZEH, 2016)
- [9] N. Fumo, M. Pedro, L. Rogelio. Methodology to estimate building energy consumption using EnergyPlus Benchmark Models. *Energy and Buildings*, 42 (2010) 2331–2337.
- [10] *Zero Energy Building definition – a literature review*, A technical report of subtask A, IEA SHC Task 40/ECB Annex 52 [online]. By Anna Joanna Marszal1 and Per Heiselberg1. [Retrieved from: <http://task40.iea-shc.org/> [Retrieved on 25 September 2016].

Session 4.8: Innovative Biophilic Design for Wellbeing

Systems Ecology as a Design Tool for Water Resources and its Environmental Education

DAY Yeong-tyi^a

^a Chung Yuan Christian University, Taiwan, timday@cycu.edu.tw

ABSTRACT

Planning water management of a sustainable campus needs to combine ecological, social, and economical aspects at the same time, which includes water volume control (Amount of input and output), water quality control (Organic and inorganic material recycling), energy management, and environmental education pertaining to water resources. About sustainable issues are traditionally designed separately by architects and/ or school managers, and are usually lack of connection among them. **"Systems Ecology" is a discipline how ecologists describing natural systems with "energy systems language", which invented by ecologists, to interpret the energy flows among compartments of an ecological system.** This article demonstrated a method to integrate those topics with different states clearly and effectively by using and modifying **"Systems Ecology" as a designing tool, which provides a systematical thinking for the designer about water resource management on campus.** An ideal model included 4 states (Water volume, materials, energy, and knowledge) was constructed as a reference. Also, an example was illustrated with a dormitory improvement design on the campus of the Chung Yuan Christian University, Chung-Li, Taiwan.

Keywords: sustainable development, campus sustainability, environmental education

2. INTRODUCTION

Sustainable development has become a universal conscience to achieve environmental, social, and economic goals simultaneously. The input/ output rule has been suggested that to keep waste within assimilative capacities, to harvest within generative capacities of renewable resources, and to deplete non-renewables at the rate at which renewable substitutes are developed. A sustainable campus is one that develops process or management systems that help create a vivacious campus economy and high quality of life while respecting the need to sustain natural resources and protect the environment. The policy of sustainable campus has been promoted in Taiwan since 2000, and environmental education emphasized particularly with improving both green infrastructure and buildings on campuses. However, I found it is difficult for architects and school managers to integrate all aspects of sustainability, and neither able to fulfil multiple and sustained usages of facilities in buildings and on campuses.

Therefore, this paper is to illustrate a systematic method to assist designers or school managers clarifying all possible components of improving campus sustainability.

3. METHOD

This study reviewed assessment discourses of sustainability for national, regional, campus, and building scales to extract issues related to water resources as the foundation of system compartments. The current status of water management on campus was comprehended with interviewing the principals of two elementary schools, and one managing staff of Chung Yuan Christian University. The processes of model developing included (1) defining **boundary of real system (Literature review)**; (2) **modifying Odum's energy language usable** for states other than energy per se; (3) building modular models for each state; and (4) connecting modular models of different states. Graduate students and professors were organized separately into two special task teams (STT) and discussions held to **validate the model's applicability and integrity.** The model were then applied to a dormitory improvement projects of the Chung Yuan Christian University.

4. RESULTS AND DISCUSSION

Study focused on how to build and operate a water resources management hardware and software for a campus **to achieve the goal of sustainability. Energy language of “Systems Ecology” was modified with new notations and objects** interested rather than energy only. It is shown that the water resource management on campus can be made in complete analogy with the natural system. Modular model of different states can be validated to illustrate the conceptual system of both tangible facilities and intangible knowledge in the real world.

3.1 Sustainability issues pertaining to water resources management

In order to define the boundary of the system pertaining to water resources management and its environmental education on a sustainable campus, resubmission must provide the details of the work to readers. The issues related to water resources were extracted from assessment discourses of sustainability for national, regional, campus, and building scales. The contexts of the system were then determined, which includes water volume control (Amount of input and output), water quality control (Organic and inorganic material recycling), energy management, and environmental education. Water volume control plan reduces dependency on tap water and groundwater and increases usages and its efficiency. Water quality control plan retrieves organic and inorganic materials which are reusable and reduces pollution to its outbound. Energy management plan reduces dependency on national or urban electricity supply, and increase the use of renewable energy. Environmental education plan allows teachers, students, and neighbouring communities to create, teach, and learn associated knowledge. Integrity of the system improves holistic development of sustainability on campus.

3.2 Energy systems language to describe natural systems

Ecologist Eugene P. Odum, called "the father of modern ecology," brought the word ecosystem into common **phrase by making it the organizing concept in his 1953 “Fundamentals of Ecology”**. The structure and function of ecosystem were analysed and described with food chain/ web, where the energy flow thru producers, consumers, and decomposers. The energy systems language, also referred to as Emergese, energy circuit language, or generic systems symbols, was developed by the ecologist Howard T. Odum and colleagues in the 1950s during studies of the tropical forests and are used to compose energy flow diagrams in the field of systems ecology.

I modified Odum’s energy systems language to illustrate a multiple states system and applied it on sustainable campus design and management plans. Facilities, buildings, landscape elements, human, teaching activities, etc. are made in analogy with the structure of a natural system, as sun (source), green plants (producer), herbivores/ carnivores (consumer), and micro-organisms/ fungi (decomposer). Three other states of flow within the system were added beside of energy that are only concerned in energy systems language.

3.3 Notations

Compartments of system model are illustrated with notations for elements to interpret the direction and amount of energy or material flows. A system has three basic elements; that is, input, processing, and output. Elements are the smallest components to represent places, facilities, resources, human, functions, actions, and statuses on campus. Six types of element, which are source, producer, consumer, processes, and outbound, are developed to illustrate reality with a diagrammatic model. Outbound element represents inevitable lost states (Figure 1).

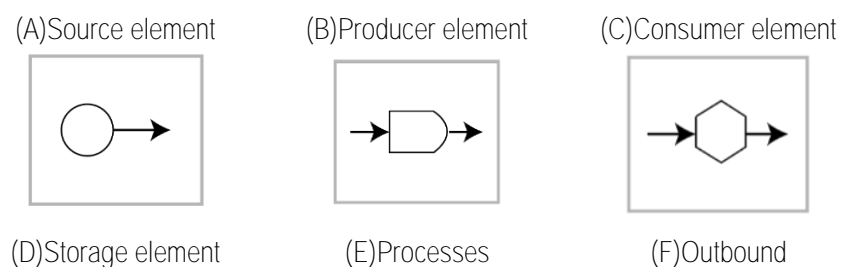

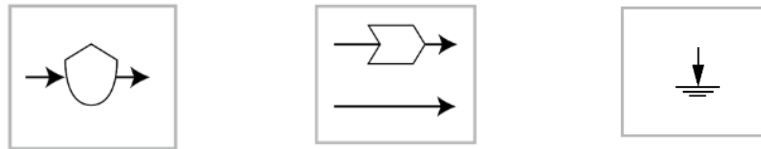

Figure 1: Notations of elements modified from energy language in Systems Ecology

3.4 Modules

Module is a model compartment which contain 2 and more than 2 elements with input and output terminals connecting other elements or modules. First order module connects only 2 elements, second order module connects 3 elements, and n order module connect n+1 elements in means of series connection. Parallel connections are also allowed. In real world, a module represents a repeatable items.

3.5 System of water resources and its environmental education on sustainable campus (SWREESC)

A system is a set of interacting or interdependent component parts forming a complex whole. System of water resources and its environmental education on campus (SWREESC) defines the boundary that enclose the hardware and software related to water resources management on campus sustainably. Utilizing above notation modified from energy systems language in Systems Ecology. SWREESC contains environmental, social, and economical issues of sustainability which should be practiced on the management of water resources on campus. Water volume, organic materials, energy, and knowledge of environmental education are states of systems model; therefore, are able to be organized and merged properly with engineering, interior design, building design, and landscape design, and teaching activities. One of the most important functions is the pathway of above states can be monitored, examined, and controlled. Furthermore, the Systems Model of Water Resources and its Environmental Education on Sustainable Campus (SMWEWWSC) is defined as a systems model that illustrates the paths and relations of each concerned state from source elements (input) to consumer elements and/ or outbound (output) holistically and completely for a SWREESC.

3.6 Four modules of the SWREESC

The source elements of water volume are tap water, ground water, runoff, and precipitation. Water may be retrieved from all stages of treatment which increases the total amount of usable water on campus; therefore, the producer elements are first, secondary, and tertiary wastewater treatment facilities. Storage elements are various, include all kinds of pools, ponds, tanks, and wetlands. Fourteen storage elements are recognized. Consumer elements are devises that use water, such as toilets, gardens, scenic ponds/ pools, kitchens, vanity, RO purifier, swimming pools, sanitary, air conditioning, livestock drinking and cleaning, fire fighting, etc. Interactions (processes) among elements are first, secondary, and tertiary treatments, and pumping. The sustainable principles of water management on campus are to reduce use amount of tap water, ground water, and runoff, and increase usage of rain. On the other hand, designer should increase the water recycling rate and utilization, by decreasing drainage and evaporation, and increasing infiltration and transpiration.

Organic material module includes three source elements, which are runoff, drainage, and black water from toilet drain. Producer elements are elements that increase the concentration of organic materials in the system, which include campus plantation and all devices of wastewater treatment. Storage elements are all sort of ponds for purification and filtration which will accumulate the organic materials in. Six consumer elements are recognized which are generators, fuels, building materials, landfill, composting, and soil improvement. To use nutrients retrieved from wastewater are barely practiced on campus in Taiwanese elementary schools actually. Interactions are mostly processes of wastewater treatment.

Energy module includes five kinds of renewable energy which able to be produced or utilized and is relevant to water resource management on campus. Source elements are solar, biogas, wind, hydraulic, and manpower. Producer elements are therefore solar panel, boiler, windmill, waterwheel, and rickshaw correspondently.

Generators are necessary for transform above energy into a common energy form. Batteries as a form of electrical storage facilities are regarded as storage elements. Consumer elements use at least one sort of energy forms to provide motion, temperature control, and driving fans, such as pumps, testing facilities, and machines. Interactions include heat, motion, electricity, and potential (hydraulic) energy.

Environmental education module includes all knowledge produced by the operation of water resource management on campus. Source element is the environmental knowledge which might be brought into the campus by teachers or NGO's member through lectures or workshops. Twelve producer elements are recognized by the environmental education theory, which include teaching methodologies through the learning of sensory organs, experiences, investigations, and researches. Four storage elements are "Environmental Education Classroom", campus buildings, and outside campus space, where provide space for teaching activities. Consumer elements are students, teachers, school staffs, parents, and people of nearby communities, who receive knowledge from the storage element. Interactions are awareness, knowledge, environmental ethics, skill of civil action, and experience of civil action. Therefore, an ideal systems model of environmental education with all possible knowledge transmitting pathways is able to be constructed.

3.7 Connecting models with different states

A final ideal model connected all four modular models of different states (i.e. water, energy, organic materials, and knowledge). The identical element in separate models provide an interface for transformation among states. For example, "Environmental Education Classroom" is an element to receive the relevant knowledge from outside (such as NGO's and school teachers), and produce (output) knowledge for pupils and publics. At the meantime, the facilities of collecting, filtrating, purifying, recycling, pumping, depositing, are the contents and teaching instruments of the "Environmental Education Classroom". Those sustainable facilities increasing ecological efficiency indeed (Positive to environmental and economical sustainability) are also observable for understanding its function and mechanism (Figure 2).

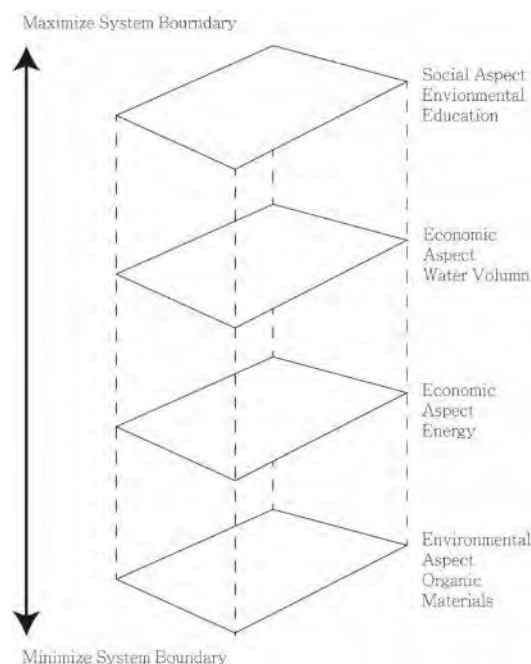

Figure 2: Four states of the water resources and environmental education systems model

3.8 Example: Dormitory design

An example was illustrated with a dormitory design on the campus of the Chung Yuan Christian University, Chung-Li, Taiwan (Figure 3). The hydrological usage was surveyed before modelling and was compared with the full model constructed previously which combined water, materials, energy, and knowledge. A system model therefore can be constructed to describe the current status of the water resource and environmental education for that particular dormitory. Tap water and ground water are two input sources. Tap water is stored in the ground, underground, and roof tanks, then provide to cleaning, drinking, and fire-fighting storage elements. The wastewater

output to the tertiary sewage treatment plant. Ground water needed pump to transport it to the secondary treatment devise to produce purified water to ground water storage elements. After cleaning and gardening, wastewater output to tertiary wastewater treatment plant. Black water form toilet flushing moved to septic tank, then to tertiary wastewater treatment plant. All purified water from the treatment plant leave the site before gardening usage.

The differences from the ideal model provide innovative foundation to increase the ecological efficiency of water resources. Five issues should be improved after comparison current usage with the ideal system model of water resources and environmental education. (1) Depending on ground water should be replaced with new source of water, such as rain. (2) Different pathways may be added before transporting to tertiary treatment plant. (3) If recycled water had other usage beside of toilet flushing. (4) New usages (elements) may be added between gardening and output. (5) Environmental education programs were absent. Therefore, five areas were designed based on above issues, which were (1) Roof rain-light garden: developed usage of solar energy and rain water; (2) Wind-light corridor: both solar and wind energy were induced; (3) Water purified and ecological corridor: living sewage was purified with aquatic water in a stream-like channel, and flow into a pond. (4) Flywheel exercise area: Transforming manpower to generate electricity. All equipment would be used for environmental education with posters and banners to illustrate the relevant sustainable knowledge.

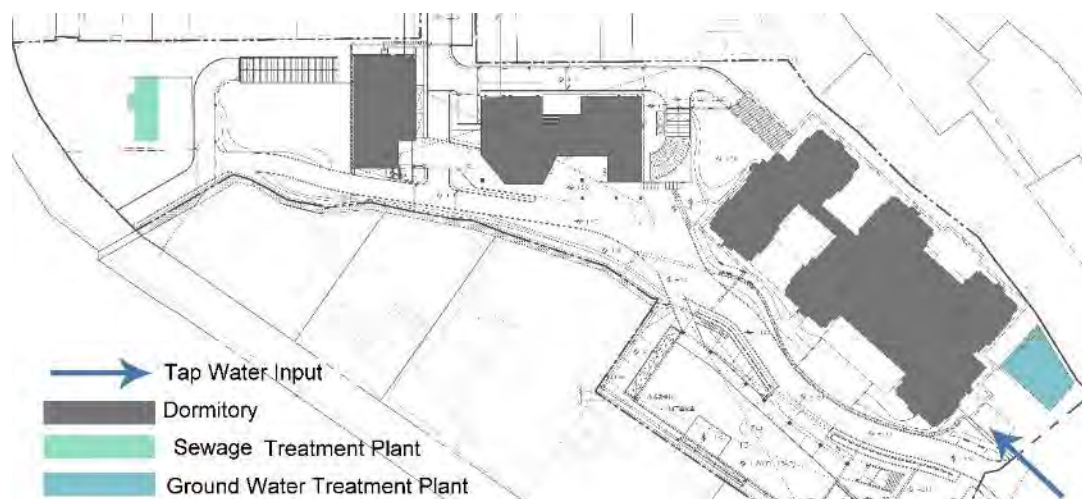

Figure 3: Current hydrological usage of the dormitory at Chung Yuan Christian University

5. CONCLUSION

One of the objectives of sustainable campus is to create a learning space for sustainability, which may adopt the design methodology of systems modelling to connect different model states and elements of a campus. It has used to be neglected usually or built separately without holistic thinking by engineers, architects and school managers. The systems modelling processes provide a chance to consider and discuss the possibility of connections of all needs and disconnection. Moreover, systems modelling may also apply on larger spatial scales, such as community and urban open space, by expanding its system boundary (Figure 4). Campus systems may interact with its surrounding community. The community may provide manpower and extra learning space for educational activities, such as farms, shops, factories which exhibit the production of the community. On the other hand, campus may provide its neighbouring community a space for public education and recreation. The most important connection is the physical infrastructure of water, materials, and energy, which may turn the campus and its surrounding area into a holistically managed system.

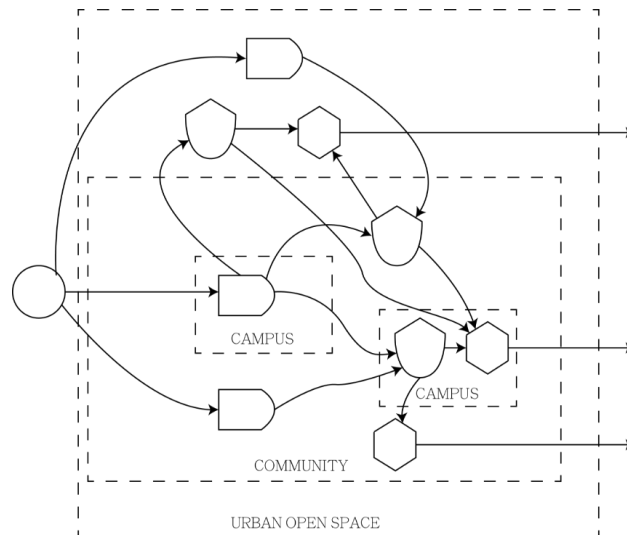

Figure 4: A conceptual diagram of expanding system boundary to bigger and neighbouring area

REFERENCES

- [1] Engleson, D. C. and D. H. Yorckers, 2003. A guide to curriculum planning in environmental education. Bulletin No. 94371. Wisconsin State Dept. Public Instruction, Madison. 176pp.
- [2] Goodland R. and H. Daly, 1996. Environmental sustainability: universal and non-negotiable. *Ecological Applications* 6(4):1002-1017.
- [3] Ministry of Education, 2016. World Wide Web of sustainable campus. <http://www.esdtaiwan.edu.tw/> (In Chinese)
- [4] Odum, E. P. 1953. *Fundamentals of ecology*. Saunders, Philadelphia. 384pp.
- [5] Odum, H. T. and B. Odum, 2003. Concepts and methods of ecological engineering. *Ecol. Engineering* 20:339-361.
- [6] Tien, L. and Y. K. Chin, 2005. Utilization of renewable energy in architecture design. *B. Architecture (PROC)* 2006(2):13-17. (In Chinese)
- [7] Wang, S. M. 2004. Environmental education under social change: green campus plan. *B. Nat. Taiwan Normal Univ. (ROC)* 49(1):159-170. (In Chinese)
- [8] Yang, Y. C. and L. L. Lee, 2003. Comparison of sustainable development index of United Nations with that of Taiwan. *Notes of Sustainable Taiwan* 4(3):9-25. (In Chinese)
- [9] Yeh, J. R., J. T. Liu, L. L. Lee, S. L. Rou, S. L. Huang, J. H. Wang, Z. H. Sun, H. M. Tsai, and W. Z. Shiz, 2003. **Sustainable index of Taiwan. The Jang's, Taipei. (In Chinese)**

Sustainable Neighbourhood of Shek Wu Hui Sewage Treatment Works

WONG Sui-kan^a, LAU Wing-wah^b, Gigi POON Wing-chi^c, Echo LEONG I-man^d, Chris LAU Man-nin^e, Kevin CHENG Ka-yang^f

^a Drainage Services Department, Government of the HKSAR, Hong Kong SAR, skwong@dsd.gov.hk

^b Drainage Services Department, Government of the HKSAR, Hong Kong SAR, wvlau@dsd.gov.hk

^c Drainage Services Department, Government of the HKSAR, Hong Kong SAR, wcpoon02@dsd.gov.hk

^d AECOM Asia Company Ltd, Hong Kong SAR, echo.leong@aecom.com

^e AECOM Asia Company Ltd, Hong Kong SAR, chris.lau@aecom.com

^f AECOM Asia Company Ltd, Hong Kong SAR, kevin.ky.cheng@aecom.com

ABSTRACT

Shek Wu Hui Sewage Treatment Works (SWHSTW) with capacity of 93,000m³/day is currently operated by Drainage Services Department (DSD), the Government of the HKSAR. To cope with the growth of local community and nearby planned developments, SWHSTW will be expanded in phases to attain a treatment capacity of 190,000m³/day by year 2030, to serve a planned population of 600,000. With this largest regional tertiary STW to be built, DSD takes this opportunity to transform the conventionally functional driven SWHSTW to an **“Environmental Campus linking with the Community”**, aiming at changing the community’s perception of sewage treatment, and also blending the facility into the natural environment.

With the state-of-the-art treatment technologies adopted, SWHSTW will purify the wastewater to very high quality effluent before discharging into Ng Tung River, which finally flows into the ecologically sensitive Deep Bay. SWHSTW will also serve as the regional reclaimed water production hub for flushing and other non-potable uses. With dedicated energy efficient design, SWHSTW will strive to be a renewable energy recovery centre through potential sludge and food waste co-digestion. **The integrated design of various sustainable “blue-green” features such as green roof, bioretention system and porous pavement with the plant’s landscaping plan further make SWHSTW itself a “Living Outdoor Classroom”, mimicking nature to cope with climate change challenges.**

To connect this “Environmental Campus” with the community, various ideas including setting back site boundary to create a riverside promenade integrated with river beautification features, co-use of some STW facilities with the community and linking the treatment works with Sheung Shui Town, etc., will be developed to create an open and accessible SWHSTW for public enjoyment and enhancing the quality of life for the community.

Design innovation with Building Information Model is also adopted to facilitate the upgrading of a live STW, and paves the path of information management in future operation.

Keywords: sustainable neighbourhood, Shek Wu Hui sewage treatment works, environmental campus

1. INTRODUCTION

1.1. Climate change and the call for sustainability

The climate is always changing – but in recent years there has been a gradual and significant shift. The Intergovernmental Panel on Climate Change (IPCC) has projected the global temperature to rise between 0.3°C and 4.8°C by the end of the 21st century under various scenarios as shown in Figure 1 (IPCC, 2013). This will further increase the likelihood of severe and irreversible impacts for human and ecosystems. In fact, most of the warming that has occurred in the last 50 years is anthropogenic – attributable to human activities. With a growing human influence on our climate, an urgent global response is demanded to create options for a brighter and more sustainable future.

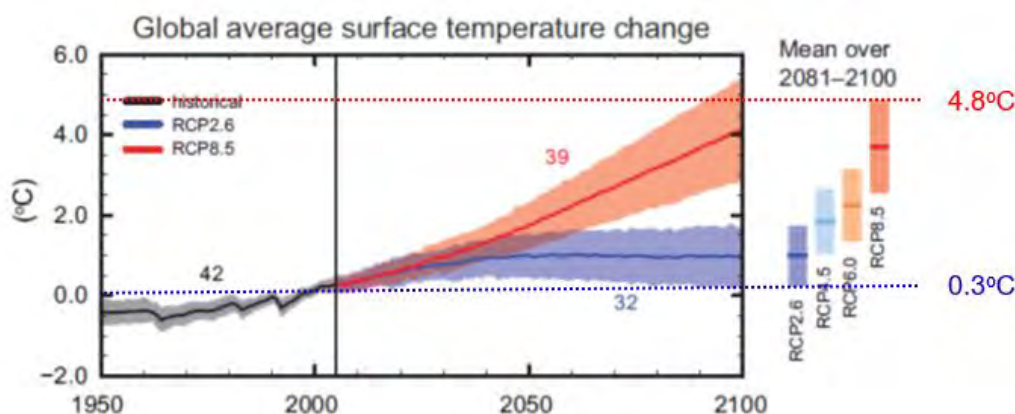

Notes:

RCP2.6: “peak-and-decline” scenario

RCP4.5: “stabilization” scenario

RCP6.0: “stabilization” scenario

RCP8.5: “high greenhouse gas concentration levels” scenario

Figure 1: Global average change in surface temperature (IPCC, 2013)

The term “sustainable neighbourhood” is emerging in recent years that advocates a liveable and enduring neighbourhood which does not compromise the well-being of future generations. It describes an area provided at the suburb scale that emphasizes the balance of social, cultural, economic and environmental aspects of the population, to provide opportunities for social interaction and achieve environmentally sustainable development.

1.2 Expansion of Shek Wu Hui sewage treatment works

Originally built in the 1980s, Shek Wu Hui Sewage Treatment Works (SWHSTW) has served Fanling and Sheung Shui areas for over 30 years, witnessing the rapid development of both towns from rural villages to a major population hub that it is today. With two upgrading works completed in the past, SWHSTW will embark on its third upgrade to become the largest tertiary STW in Hong Kong, aiming to double its capacity from 93,000m³/day to 190,000m³/day. The upgrading works is currently underway since mid-2015 and is anticipated to complete by year 2030. The proposed STW upgrade will enable future planned territory-wide developments to accommodate a potential population of 600,000, while increasing effluent quality to meet rising discharge standards.

DSD takes this opportunity to transform the conventionally functional driven SWHSTW to an “Environmental Campus”, not only to adopt state-of-the-art tertiary treatment technologies, but also incorporate green design and community provisions to change traditionally unwanted “NIMBY (Not-in-my-backyard)” facilities into an integral asset in the local environment, thus highlighting the theme of “sustainable neighbourhood”. Figure 2 shows the aerial photomontage of the future expanded SWHSTW.



Figure 2: Perspective of the expanded SWHSTW

2 GREEN TECHNOLOGIES/MEASURES

2.1 Taking a step further: Tertiary treated effluent reuse

Upon the further expansion of the SWHSTW, the effluent discharge standard will be tightened in order to achieve **“no net increase in pollutant loads” to the ecologically sensitive Deep Bay Ramsar site, and also to honour the commitment of the revised Deep Bay (Shenzhen Bay) Water Pollution Control Joint Implementation Programme (JIP) under the Framework Agreement signed by the Chief Executive of Hong Kong and Governor of Guangdong in 2010.** To achieve this, SWHSTW will be upgraded to a tertiary sewage treatment plant. Part of the treated effluent will be further polished as reclaimed water for toilet flushing and other non-potable uses in Sheung Shui and Fanling areas, and the planned developments in Kwu Tung North and Fanling North. Unlike other regions in Hong Kong, seawater flushing is not practiced in the North District due to its geographical distance to the sea. Therefore, reclaimed water reuse will ultimately save 21 million cubic meters of fresh water per year, equivalent to 8,400 Olympic size swimming pools (WSD, 2014). Reclaimed water will also be used in the SWHSTW for irrigation, flushing and cleansing, etc., which will reduce the fresh water consumption of the treatment works by 22%.

With the upgraded high quality effluent, DSD will also explore the opportunity to beautify Shek Sheung River by replenishing the concrete channel along with new landscaping works to further connect SWHSTW with the **environment and the community. More details will be discussed in “Section 3: Sustainable Neighbourhood” below.**

2.2 From waste to energy: Sludge treatment and renewable energy

One of the key initiatives is to harvest renewable energy from sewage sludge, an energy rich by-product generated from sewage treatment. Sewage sludge mainly composes of settled organic matters and surplus biomass growth in the treatment process, with high organic content and calorific value as high as 18,000 kJ/kg-ds (DSD, 2016). Conventional anaerobic digestion, which decomposes these organic materials in the absence of molecular oxygen, could transform the biosolids to biogas, which is rich in methane (about 60% by volume) (DSD, 2014). With the combined heat-and-power (CHP) system, biogas will be converted into heat energy and electricity for on-site plant operation such as powering equipment, temperature control as well as monitoring performance of sludge digestion process. To strive for innovative energy efficiency, the first-in-Hong-Kong thermal hydrolysis pre-treatment (THP) system will be adopted in SWHSTW **to enhance biogas production by about 30%. This alternative “green” power will be fed back to the treatment plant and is estimated to generate about 20 million kWh per year, equivalent to the annual power consumption for 4,000 families (average household electricity consumption in Hong Kong is about 400kWh per month) (Environment Bureau, 2015).** It will diversify the fuel mix of SWHSTW by offsetting approximately 10% of the total energy from conventional fossil fuels.

To fully utilize the energy recovery opportunity through this enhanced digestion system, DSD is also exploring the potential to turn the SWHSTW as one of the regional sludge treatment centre for other small scale sewage treatment facilities in the North District. We will also explore the feasibility to incorporate food waste co-digestion in the SWHSTW, not only to synergize the biogas thus energy recovery potential, but also to help lightening the demand pressure on landfills. Further studies will be carried out to confirm their feasibilities.

2.3 Sustainable by design: Green buildings

Building Environmental Assessment Method Plus (BEAM Plus) is a standard that provides building users with a single performance label to demonstrate the overall quality of a building. Considering the site area and its usage, the Administration Building and the adjacent landscape area in Zone A are targeted for undertaking the BEAM Plus Platinum Accreditation.

By partaking the BEAM Plus Accreditation, it will ensure the planning, design, construction and future operation **stages of the new Administration Building and CHP Building to be “green” and sustainable, and to further support the overarching theme of “Environmental Campus” for SWHSTW.**

BEAM Plus Accreditation focuses not only green elements, it covers the overall quality of the building including energy use and indoor environmental quality. Design initiatives including LED lighting, displacement ventilation and heat recovery for air conditioning systems, etc. will be implemented to reduce the annual energy consumption by up to 33%, while installation of solar panels atop the building will offset a portion of the energy consumption.

Innovative technologies and performance enhancements will be adopted to improve sustainable living, use energy efficiently, and thus reduce pollution.

2.4 Pioneers in sustainability: “Blue-Green Infrastructure”

Sustainable drainage system (SuDS) has been widely adopted in response to the extreme weather events induced by climate change, and DSD is one of the pioneers in Hong Kong striving to incorporate SuDS as part of our “Blue-Green Infrastructure” concept for alleviating flood risk, and also enhancing the runoff quality as well as promoting greening.

Rather than conventional collection and discharge, the SWHSTW will incorporate various SuDS in its landscape design for stormwater control and polishing, of which the “green” design can serve as an example to the public on tackling climate change and promoting water conservation through exhibition and plant tours. Examples of these SuDS elements, including green roof, bioretention system and porous pavement, proposed for the expanded SWHSTW are shown in Figure 3. In addition to reducing the peak runoff rate, bioretention and green roof could further purify the runoff quality by natural adsorption and microbe reaction through plant roots. Meanwhile, porous pavement, with multiple permeable layers of gradual gradation as shown in Figure 4, can remove between 60% and 95% of total suspended solids (i.e. silt) and 70% to 90% of hydrocarbons (CIRIA Reports C 697, C 609 and C 582). When subjected to low level oil drips, such as in car parks, the pavements can continue to biodegrade the hydrocarbons indefinitely (CIRIA 2007, 2004 and 2002).



Figure 3: Sustainable stormwater management systems in SWHSTW

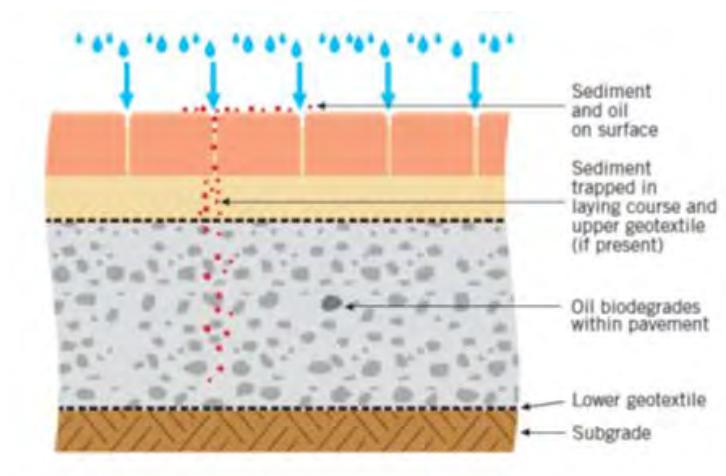

Figure 4: Trapping of sediment in porous pavement (Interpave, 2001)

2.5 Putting it all together: Building information modelling

Design innovation with Building Information Model (BIM) is adopted to facilitate a piece-by-piece upgrade of the SWHSTW whilst in operation, through comprehensive construction planning using powerful time-based modelling and detailed crash analyses of pipelines. BIM also paves the path for information management for future operation and maintenance by identifying the configuration requirements for the model attribute fields to best suit the plant **operators' needs**. **BIM technology will also be incorporated in the asset management system to provide a more reliable and secure sewage treatment service.**

3 SUSTAINBLE NEIGHBOURHOOD

3.1 Learning by feeling: A living outdoor classroom

SWHSTW is located in a low rise industrial area surrounded by an expansive lowland. The surrounding areas are generally flat with agricultural fields and river channels, scattered villages connected by winding lanes and footpaths. Considering the aesthetics of the expanded SWHSTW, surrounding rustic environment and local community requirements, Environmental Campus linking with the Community is adopted as the design theme of SWHSTW.

The landscape theme will be designed for learning in a living outdoor classroom to echo the overarching theme of **“Environmental Campus” in SWHSTW**. **The landscape design will aim to provide a pleasant outdoor learning environment on broad environmental initiatives where educational, environmental, professional, and research organizations can experience and appreciate the harmonious blend of advanced sewage treatment with natural landscape character and context.** We strive to provide educational elements such that visitors or the general public can learn and be inspired by the revamped SWHSTW campus. For example, with the various SuDS incorporated in the landscape design, educational exhibits illustrating the functions of SWHSTW and associated climate change issues provided, visitors can easily understand real-life applications of textbook knowledge in the Campus. The landscape design also aims to provide a green and comfortable working environment to the operators by maximizing greening opportunities without compromising operational requirements. The site greenery coverage will be higher than 30%, giving the surrounding community a better and greener neighbourhood.

3.2 Learning by seeing: Educational plant tour

To enhance public awareness of sustainable development and strengthen their sense of belonging, guided educational tours will be organized to introduce the significance and operation of the expanded SWHSTW as well as the advanced treatment technologies adopted. Multimedia such as interactive models and educational exhibits will be placed along the visiting routes to different parts of the STW, fitting the theme of Environmental Campus.

With the use of BIM, a 3D model and virtual tours will be made available to the visitors for better understanding of the different treatment processes and technologies.

3.3 Giving back to the community: Riverside promenade

The expanded SWHSTW is surrounded by three rivers, namely Ng Tung River, Shek Sheung River and Sheung Yue River, offering a nice foreground view of the site from all sides. Riverside walkway, created by setting back the site boundary of the expanded SWHSTW, will be provided to create scenic spots and promenade areas for public enjoyment and leisure activities.

The proposed riverside walkway will connect to existing walkway and cycle path at Sheung Shui Town to enhance intra-district travel and strengthen connection of the expanded SWHSTW with the community. To provide a more pleasant environment and enhance the recreational value of the riverside walkway, landscape and water features will be introduced to complement the surrounding natural rivers. The perspective of the riverside walkway is shown in Figure 5.



Figure 5: Perspective of the riverside promenade and walkway

3.4 Landscape integration: Shek Sheung River beautification

Part of the Shek Sheung River close to the SWHSTW is proposed to be beautified to further provide a linkage between SWHSTW and the community. High quality treated effluent from the expanded SWHSTW will be the water source of the beautified Shek Sheung River. The effluent will be discharged at Shek Sheung River after passing through the ultra-violet disinfection chamber to ensure a hygienic and safe water course. Figure 6 gives a perspective of the beautified Shek Sheung River and the proposed cascading water feature.

The beautification of Shek Sheung River will also aim to minimize the impact to the surrounding ecosystem. The existing two channels near Sheung Shui Heung will retain its natural course and merge with the replenished Shek Sheung River. Riparian vegetation will be planted on the embankment to segregate the effluent and the public, who may enjoy the scenery on the new timber deck platform adjacent to the river. In addition, fish ladder, animal passage, fish shelter and pools will also be provided for the connectivity and ecological enhancement of the local fauna. Figure 7 presents an impression of the enjoyable view of Shek Sheung River after beautification.



Figures 6 (Left) & 7 (Right): Perspective of Shek Sheung River beautification

3.5 Co-use of space: Public accessible facilities

To further connect the public with the expanded SWHSTW and attract users, co-use of some areas of the SWHSTW with the public is explored. Public accessible facilities will be provided for community enjoyment, including wetland garden, bio-retention lawn garden, seating area, viewing platform of the adjacent Long Valley wetland and multipurpose room in the Administration Building.

Wetland features with different wetland plant species including emerged, submerged and floating plants are proposed outside the Administration Building to welcome visitors to the SWHSTW, as shown in Figure 8. In addition to this public accessible wetland, a welcoming garden with multipurpose lawn is also proposed for public enjoyment.



Figure 8: Welcoming wetland to SWHSTW

SWHSTW sits near Long Valley. Having considered the enjoyable view to the future Long Valley Nature Park, the roof of Workshop Building in the SWHSTW will be designed as a viewing platform and will be open to public for viewing the farmland, birds and the stunning sunset scenery to the west. The pedestrian ramp reaching the viewing platform would also connect to a multipurpose room in the Administration Building. To enhance the integration of SWHSTW to the community, public can use this facility for meeting or other purposes by advance reservation. Furthermore, to allocate more space for public use, large multi-functional recreational platforms above rooftops of treatment buildings and ancillary buildings are currently under review.

4 SUMMARY

SWHSTW does not only provide sewage and sludge treatment. SWHSTW is developed to be a new generation **of sewage treatment works as an “Environmental Campus linking with the Community”**. The proposed education tour in the SWHSTW aims to educate the visitors (especially students in Hong Kong) the importance of sewage treatment and its technologies adopted to minimize the unpleasant feeling of sewage treatment works, which is **servicing the function of “Campus”**. On the other hand, the landscape design aims to **blend the sewage treatment works into the surrounding environment, fulfilling the theme of “Environmental”**. The beautification of Shek Sheung River can also enhance the integration of the treatment works into the environment.

As a sustainable neighbourhood, SWHSTW provides connection with the community. The scenic riverside walkway is proposed for an extensive network connecting the expanded SWHSTW and the Sheung Shui Town. It is aimed to enhance the recreational value of the site and provides an alternative choice for public leisure activities. Sustainable stormwater management system (including bioretention system, porous pavement system and green roof) will be implemented in SWHSTW to manage the quantity and quality of stormwater runoff.

A key lesson learnt in the planning **of the SWHSTW expansion is that development of “NIMBY” facilities, especially with one in such close proximity to local communities, required extensive and comprehensive public engagement activities to ensure smooth progress**. Transforming the community **as well as the designers’ mind set in viewing community infrastructure including the SWHSTW, from functional driven NIMBY facilities to be hidden, to integrated community asset to be shared and co-used as “sustainable neighbourhood” is another lesson we learnt**. In **considering local community's opinions on co-use of land and environmental concerns, we envisaged the Environmental Campus to be a perfect theme for the SWHSTW to seamlessly integrate into the surrounding environment and the community**. Without compromising the capacity of the SWHSTW, the development paradigms are applied in a green, intelligent, cost effective, technically advanced and resilient manner, to provide a world-class wastewater treatment enabling the sustainable development of Hong Kong.

REFERENCES

- [1] CIRIA, 2002. Source control using constructed pervious surfaces. Report C 582.
- [2] CIRIA, 2004. Sustainable Drainage Systems. Hydraulic, structural and water quality advice. Report C 609.
- [3] CIRIA, 2007. The SUDS Manual. CIRIA Report C 697. Scottish Building Standards Agency (2007). Scottish Building Standards: 2007. Technical Handbook 3, Environment.
- [4] DSD, HKSAR, 2016. From Waste to Energy - Development & Use of Renewable Energy in Sewage Treatment Facilities.
- [5] DSD, HKSARG, 2014. From Sewage to Energy, 2014
- [6] **Environment Bureau, HKSARG, 2015. Energy Saving Plan For Hong Kong's Built Environment 2015-2025+.**
- [7] Interpave, The Precast Concrete Paving & Kerb Association, 2010. Guide to the Design, Construction and Maintenance of Concrete Block Permeable Pavements.
- [8] IPCC, 2013. Working Group I Contribution to the IPCC Fifth Assessment Report Climate Change 2013: The Physical Science Basis. Geneva: Intergovernmental Panel on Climate Change.
- [9] WSD, HKSARG 2014. Water Supplies Department Annual Report 2013/14.

Biophilia and Nature-based Features to Support Stress Reduction in Knowledge Workers

Margaret Ann CALLAGHAN^a, Shauna MALLORY-HILL^b

^a Conestoga College, Canada; Algonquin College, Canada, ann.callaghan@gmail.com

^b University of Manitoba, Canada, s.mallory-hill@umanitoba.ca

ABSTRACT

According to Duxbury and Higgins, 57% of full time office employees reported high levels of stress. Stress impacts the productivity, health and well-being of individuals, and the bottom line of employers. A growing body of research suggests that exposure to nature mitigates stress stimuli and therefore has restorative effects on memory and attention resulting in health, well-being and productivity benefits. This paper summarizes the findings of a 2015 MID thesis study that brings together information drawn from the neurosciences and environmental psychology including: attention restoration theory (ART), psycho-evolutionary theory, biophilic design, survival-advantageous characteristics, current case studies, and experience drawn from design practice. In this review, the authors highlight six key biophilic design strategies for stress reduction in office knowledge workers: locating in or near nature, movement in nature, maximizing daylight and views to nature, use of natural materials, plants and natural scents. These strategies focus particularly on providing workers with the most direct and indirect exposure to nature and, therefore, are likely to have the strongest impact on mitigating the stress response. Each strategy is shown in current applications in existing workplaces, where they are used in combination or independent of each other, depending on site conditions and opportunities.

Keywords: biophilia, stress, indoor environmental quality

1 INTRODUCTION

Stress is negatively impacting the productivity, the health and well-being of employees and the bottom line of employers. According to a Canadian study of 25,000 full-time employees 57% reported high levels of stress (Duxbury and Higgins, 2012). It is estimated Canadian employers lose \$20 billion per year due to stress-related illness (Lem, 2013). Stress causes a loss of productivity and chronic stress can cause long term health issues (Posen, 2013).

A growing body of evidence suggests exposure to nature and nature-based or biophilic features may offer a solution to reducing stress in the workplace (Berman et al., 2008). This paper summarizes some of the findings from a 2015 thesis study (Callaghan, 2015) that includes a comprehensive literature review on the topic drawn from the neurosciences, environmental psychology, and examples in design practice. The purpose of the study was to determine strategies that would provide design practitioners with cost effective and straightforward ways of integrating nature-based features into workplace design to enhance well-being and reduce stress.

2 THE BRAIN AND THE NEUROSCIENCE OF STRESS

People are largely unaware of the stress stimuli they experience day to day, since the majority of sensory impulses are sorted in our sub-conscious. Neurosurgeon, Dr. Norman Hill describes that the brain, even during sleep, is constantly responding to sensory stimuli, endlessly coordinating all the chemical and electrical impulses, (N. Hill, personal communication, April 13, 2015 in (Callaghan, 2015) p. 7-9). The brain has evolved to place particular priority on sensory impulses to pass that are necessary to **gain information about one's immediate environment to perform a specific task, typically related to survival.**

Neuroscientist, Dr. Matt Hill, explains that, unfortunately, our response to stressors has not evolved to suit our modern-day workplace environment (Hill, 2013). Our response to life threatening and dangerous situations in the wild is physiologically similar to our emotional response to non-life threatening work pressures and physical characteristics of workplace environments (e.g. high stimulation). When external sensory stimuli trigger an alarm response in our brains, the neurotransmitter cortisol is released, producing a short term increased physiological function or what is commonly known as a flight or fight response.

What was appropriate and effective metabolic response for survival when early humans were faced with a saber-tooth tiger, is very problematic when it is being reproduced by stimuli in modern workplace environments. This is because cortisol thins out dendrites that form the connections between our brain cells (Posen, 2013). Limiting the ability for one cell to speak to other cells effects short term memory. Memory is a key component in learning and cognition. It is theorized that these chemical and structural changes in the brain are the reason that individuals who are stressed experience memory loss and related mental and physical health problems. According to Posen, **chronic stress can lead to depression. Others have identified stress as a risk factor for Alzheimer's** (Le et al., 2016).

With advances in information technology, office workers are now working longer hours and spending more time indoors than workers did during the Industrial Revolution, which means they are being exposed to increasing levels of stress stimuli. Stress is a natural and useful biological response, but long-term stress can have dire consequences. While it is not possible, or even desirable, to attempt to block all of the billions of sensory stimuli received by the human body, designers may, according to environmental design theory and research, be able to mitigate worker stress by incorporating more natural, or biophilic, stimuli into workplace design.

3 ATTENTION RESTORATION THEORY AND BIOPHILIC DESIGN

If the human brain is not designed for the modern workplace, what is it designed for? According to acoustic ecologist **Gordon Hempton, the ear, one of the brain's sensory receptors, is particularly attuned to better hear** certain frequencies of sound (2-5 HZ) that communicate information about the natural environment and events in it relevant to survival (Hempton, 2015). **Our vision system is similarly attuned to process daylight. E.O. Wilson's** Biophilia Hypothesis suggests humans have a certain innate affiliation or love of other living things (Wilson, 1986), which makes sense given how easily we comprehend and communicate in it. Because humans are equipped with the perfectly designed biological receptors for processing relevant natural information means that we can do it effortlessly and without attention. In contrast, focused or directed attention towards something like a work-task or human-made environment requires a great deal of effort and can even overload our sensory receptors, causing mental fatigue and stress.

Thirty years ago, environmental psychologists Rachel and Stephen Kaplan developed Attention Restoration Theory or ART, suggesting that involuntary and effortless attention to nature rests the brain and thereby helps to restore memory and concentration (Kaplan and Kaplan, 1989; Kaplan, 1985). Kaplans' **theory has been repeatedly** tested and supported by numerous studies, with over 2046 citations currently in Google Scholar, including one in **Li and Sullivan's recent 2016 study revealing the importance of views, over exposure to daylight alone, of school** landscapes on recovery from stress in high school students (Li and Sullivan, 2016).

Roger Ulrich's (Ulrich, 1993; Ulrich et al., 1991) own experiments suggest stress recovery during exposure to nature are derived from psycho-evolutionary theory related to positive emotional state and physiological changes, rather than involuntary attention, which Ulrich et al. was able to elicit with non-nature-based stimuli. Although Kaplans and Ulrich et al. provide us with different explanations of what happens during the restorative process, both (and many other researchers) found that views of nature, versus human made settings, account for cognitive recuperation and increased perceptual capacity (Hartig et al., 2008).

In 2008, social ecologist, Stephen Kellert began translating biophilia, ART, and psycho-evolutionary theory into a **framework for biophilic design (Kellert, 2008)**. As a work in progress, Kellert's many different levels consisting of two dimensions, six elements and 70 attributes, can be difficult to follow and keep straight (Callaghan, 2015, p. 17). The attributes overlap and there are varying levels of detail within the elements. Architect and historian, Grant Hildebrand has proposed a similar nature-based design framework, but it is much smaller in organizational scale. **Hildebrand's theoretical framework consists of five preferred architectural characteristics that emulate natural settings useful or advantageous to human survival.** For example, Hildebrand references Jay Appleton's "prospect and refuge" (Appleton, 1996), a location offering a view of resources from a "protective place of concealment" (Hildebrand, 2000; Hildebrand, 2008). Although still mainly theoretical, both Kellert and Hildebrand's work to organize key ideas emerging from environmental design research has made it easier for designers to apply in actual design solutions.

In biophilic design, it is important to note that Kellert (2008) differentiates between three types of exposure to nature. The first is direct biophilic experience or self-sustaining features such as: plants, woods, gardens, daylight, views,

landscapes and scents. Indirect biophilic experience is nature that requires on-going human intervention to survive, such as potted plants, which require watering and other maintenance. A third is symbolic represented in natural motifs such as leaves on column capitals or organic shapes on finish materials or images. Research by Kahn, et al., (2008) found that direct and indirect experiences with nature have greater potential for stress reduction. Interacting with images of nature, or technological nature, provides some, but not all, the enjoyments and benefits of interacting with actual nature (Kahn et al., 2009, p 41).

4 BIOPHILIC WORKPLACE DESIGN STRATEGIES IN PRACTICE

Biophilic workplace design is still relatively new, with relatively few examples, and of these, very little performance-based evaluation research has been done. While there are potentially many approaches to induce stress recovery through exposure to nature into workplace design, the following is a list of six practical design strategies drawn from a sample of seven biophilic workplace designs, along with additional related literature research. All six strategies focus on providing direct or indirect exposure to nature, or a combination of both.

4.1 Locating in or adjacent to nature

Locating work environments in natural areas provides opportunities for direct experience of nature immediately adjacent to, and usable as, a work environment. The Pond Studios, designed by Elva Rubio in a rural area near Lagrange, Georgia is a 15,000 ft² building extended over a large pond, providing a panoramic view of the surrounding nature. Several expansive decks encourage movement and use of outdoor spaces during office hours (David Oakley Designs, 1997).

In the case of SC3 Offices, the multidisciplinary design firm's building is located within an urban location (Winnipeg, MB) between two highways, a light industrial, and suburban residential neighbourhood (Canadian Architect, 2006) (see also Figure 1, Figure 2, Figure 3). Here the designers enhanced existing nature on the urban site, preserving and adding to a stand of spruce trees on the north side of the building and working with the local Municipal government to re-introduce a native prairie grassland along the south side of the site facing, and thereby mitigating sound from, the busy roadway. Walking paths, shared with the adjacent neighbourhood, are designed throughout. A broad, forest-sheltered exterior deck, fitted out with appropriate furnishings to minimize relocation time, extends the studio space into the new urban forest as a place for employees to unwind as well as undertake work tasks and meetings (see Figure 6).

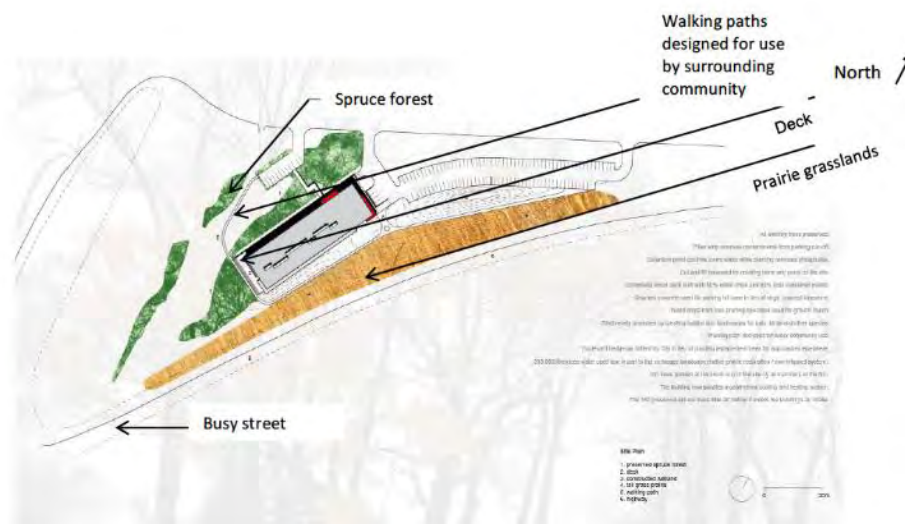

Figure 63: SC3 site plan (with permission Giles, 2014).



Figure 2: SC3 exterior. View of natural prairie grassland in the "front" yard view and tops of urban spruce forest in side and back area (with permission Giles, 2014).

Figure 3: SC3. View to urban spruce forest (with permission Giles, 2014).

4.2 Moving in nature

Several research studies (Berman et al., 2008; Nisbet et al., 2011) support the restorative benefits of not only viewing nature, but moving through it on vegetated paths and in urban parks and forests, compared to walking in urban settings without green infrastructure. Making nature both readily accessible, and possibly unavoidable, is a design strategy intended to build healthier workplaces. In the case of the proposed Google Campus in San Francisco Bay, California, designed by Architects NBBJ, a series of linked outdoor spaces and rooftops promote scooter-riding, jogging, biking, yoga classes all created from data on how employees work and relate in order to **maximize "casual collisions of the workforce"** (Radcliffe, 2013).

4.3 Daylight and views

Probably one of the most well-known and applied biophilic design strategies is the provision of natural daylight and view. As mentioned earlier in this paper, some research suggests that restorative benefits are more likely to be attributed to natural views, than to daylight, although both are important to human well-being and biological circadian function. Exterior glazing for daylight and view provides an additional opportunity to include operable windows for natural ventilation and improved indoor air quality and control.

The Selgas Cano architectural office provides its workers with an unusual ground level view of nature (Figure 4). It is also an example of maximizing daylight and views by moving enclosed offices off glazed exterior walls and into the interior of the building floor plate, low (under 42 or 48") or no partitions and overhead storage units, and the incorporation of light colour furnishings and finishes to maximize day light penetration. SC3 uses similar strategies, including full floor to ceiling windows to optimize daylight and vegetated views (Figure 5). Glazed interior partitions and light shelves are also effective strategies for maximizing daylight and view.



Figure 4: Selgas Cano Architecture office set in suburban Madrid, Spain (with permission Cano, 2014).



Figure 64: SC3. View to nature from open workstations (with permission Giles, 2014).

4.4 Natural materials: wood

Tactile and visual stimulation provided by natural materials in indoor environments, and in particular, wood, has been shown to impact stress and relaxation responses. Researchers, Tsunetsugu et al., (2007) suggest that the ideal proportion of wood as an interior finish on walls and floors is between 30% to 45% of the combined surface area of a living space. **Path, designed by Geremia Design in 2011, is a social networking application company's** office located in a dense urban site in San Francisco. **Path's** office space cannot provide direct experience of nature, so the designers provide an indirect experience of nature through the use of well-placed plants, wood and other natural materials. Confronted with a similar dense urban location, **Google's Tel Aviv's office designers' use** spatial planning to create an interior park like setting with materials such: as wood benches, crates, flooring and natural tree trunks.

4.5 Plants

Another well-known and easily applied biophilic design strategy is the inclusion of plants in the workplace. Research studies by Raanaas et al. (2011) and Shibata and Suzuki (2004) suggest between one and five plants within the sight of the worker for stress reduction and improved health and well-being. On the ninth floor of its building in London, England, Goggle offers indirect nature in the form of gardening boxes on its decks and balconies, so popular there is a waiting list. Google Tel Aviv and Path's office areas also use the indirect nature of potted plants as discussed in 4.4 above.

4.6 Natural scents

Environmental psychologist, Sally Augustin suggests certain natural scents can reduce stress, promote relaxation (lavender) and can improve brain functions such as memory (rosemary), creativity (cinnamon-vanilla), and alertness (peppermint) (Augustin, 2009). The health benefits of the Japanese practice of shinrin yoku, or forest bathing, is supported by research that finds the scents, or essential oils, emitted by evergreen trees are associated with improvements to the **immune system and production of natural killer cells (Tsunetsugu et al., 2010)**. **SC3's** location within a spruce wood forest provides an opportunity for workers to benefit from such essential oils, which also permeate into the indoor office space (Figure 6).

The introduction of scents inside buildings, sometimes referred to as environmental fragrancing, as in the Fredric's office building in Philadelphia, is intended to boost productivity of employees (Kadaba, 1994). Scents, especially ones from artificial or chemical sources, however, can be problematic for people with sensitivities. Moreover, the efficacy of scents is inconclusive. According to environmental psychologist, Susan Knasko, five out of eleven published studies, including her own, showed no effect of scents on task performance (Kadaba, 1994). Interestingly, congruency (how much an introduced scent matches its setting) has been shown to impact consumer behaviour in retail settings (Mitchell et al., 1995).



Figure 65: SC3 and surrounding deck area set in urban forest, natural spruce scent permeates indoor and outdoor spaces (with permission Giles, 2014).

5 CONCLUSION

Stress is a natural human response to dangerous or threatening situations, but according to neuroscience, the **human biological response has not appropriately adapted to sources of stress stimuli found in today's work environments**, contributing to the rise of chronic stress and its related health problems. A growing body of environmental design research suggests that the introduction of nature-based stimuli, or biophilic design, might help to recover from stress through restorative attention or by inducing positive emotional state.

The literature research from the MID thesis study summarized in this paper highlights how including nature and nature-based features in workplaces could potentially have a significant impact on worker health and well-being. An important finding drawn from the literature was that direct and indirect exposure to nature has the greatest impact over symbolic nature experiences. The implication of this finding is that designers should prioritize strategies that provide direct contact. Four examples provided include locating workspaces adjacent to or in, nature, maximize movement in nature, exposure to scents in nature and optimize the provision of daylight and vegetated views. Where direct contact is not possible, exposure to indirect nature is recommended. Two strategies identified include the use of natural materials (wood), interior landscaping and potted plants. The case studies show how these various biophilic design strategies have been applied in practice.

The authors note that biophilic workplace design is relatively new and that additional building performance evaluation research of buildings employing it is required to determine its impact on reducing worker stress. With a growing interest in promoting human health and wellness in buildings, biophilic design is now being integrated into green building rating systems such as Leadership in Energy and Environmental Design (LEED), Living Building Challenge (LBC) and the Well Building Standard, which likely will transform how future buildings are located and built. Rating systems, along with more multidisciplinary approaches to design delivery, will provide an excellent opportunity to integrate environmental design research with lessons-learned from measurement and monitoring of buildings employing biophilic design strategies.

REFERENCES

- [1] Appleton, J., 1996. *The Experience of Landscape*. London: Wiley.
- [2] Augustin, S., 2009. *The Place Advantage: Applied psychology for interior architecture*. Hoboken, NJ: John Wiley & Sons.
- [3] Berman, M., Jonides, J., and Kaplan, S., 2008. The cognitive benefits of interacting with nature. *Psychological Science*(19), 1207-1212. doi:10.1111/j.1467-9280.2008.02225.x
- [4] Callaghan, M.A., 2015. *Interior Design Strategies for Nature-based Features to Support Stress Reduction in Knowledge Workers*. Winnipeg, MB, Canada: University of Manitoba. Retrieved from <http://hdl.handle.net/1993/30767>
- [5] Canadian Architect., 2006, May 1. SC3-Smith Carter Office. *Canadian Architect*. Retrieved March 2016, from <https://www.canadianarchitect.com/features/sc3-smith-carter-office/>
- [6] David Oakey Designs., 1997. *The Story Behind Pond Studios*. Retrieved March 2016, from David Oakey Designs: <http://davidoakeydesigns.com/pond-studios/>
- [7] Duxbury, L. and Higgins, C., 2012. *Revisiting Work-Life Issues in Canada: The 2012 National study on balancing work and caregiving in Canada*.
- [8] Hartig, T., Bringslimark, T., and Patil, G., 2008. Restorative Environmental Design: What, when, where, and for whom. In J. H. S. Kellert, and M. Mador, *Biophilic Design: The theory, science, and practice of life* (pp. 133-151). Hoboken, New Jersey: Wiley.
- [9] Hildebrand, G., 2000. *The Origins of Architectural Pleasure*. Berkley, CA: University of California Press.
- [10] Hempton, G., 2015, October. *Generation Anthropocene: The Soundtracker*. Retrieved March 2016, from Soundcloud: <https://soundcloud.com/generation-anthropocene/the-soundtracker>
- [11] Hildebrand, G., 2008. Biophilic Architectural Space. In S. Kellert, J. Heerwagen, & M. Mador, *Biophilic Design: The theory, science, and practice of life* (pp. 263-276). Hoboken, New Jersey: Wiley.
- [12] Hill, M., 2013, August 29. CBC Radio 1 - The Natural Brain. (R. Walker, Interviewer)
- [13] Kadaba, L. S., 1994, December 14. Workplace Aromas: The Scent of Productivity. *Orlando Sentinel*. Retrieved March 2016, from http://articles.orlandosentinel.com/1994-12-14/lifestyle/9412130251_1_scent-fragrancing-fredric
- [14] Kahn, P., Friedman, B., Gill, B. H., Severson, R., Nathan, G., and Stoylar, A., 2008. A Plasma Display Window? The shifting baseline problem in a technologically mediated natural world. *Journal of Environmental Psychology*(28), 192-199. doi:10.1016/j.jen8
- [15] Kahn, P., Severson, R., and Ruckert, J., 2009. The Human Relation with Nature and Technological Nature. *Current Directon in Pscyhological Science*, 1(18).
- [16] Kaplan, R., and Kaplan, S., 1989. *The Experience of Nature. A psychological perspective*. New York: Cambridge University Press.
- [17] Kaplan, S., 1985. The Restorative Benefits of Nature: Toward an integrative framework. *Journal of Environmental Psychology*(15), 169-182.
- [18] Kellert, S., 2008. Dimensions, elements, and attributes of biophilic design. In J. H. S. Kellert, *Biophilic Design: The theory, science, and practice of bringing buildings to life* (pp. 3,5-6,9,11-13). Hoboken, New Jersey: Wiley.
- [19] Le, M. H., Weissmiller, A. M., Monte, L., Lin, P. H., Hexom, T. C., Natera, O., Wu, C., and Rissman, R. A., 2016. Functional Impact of Corticotropin-Releasing Factor Exposure on Tau Phosphorylation and Axon Transport. , 11(1), e0147250. <http://doi.org/10.1>. (A. E. Ryabinin, Ed.) *PLoS ONE*, 1(11). doi:10.1371/journal.pone.0147250
- [20] Lem, M., 2013. *Mental Health Commission of Canada (MHCC)*. Retrieved from <http://www.davidsuzuki.org/blogs/docstalk/2013/04/connect-with-nature-to-reduce-stress/>
- [21] Li, D., and Sullivan, W., 2016. Impact of Views to School Landscapes on Recovery from Stress and Mental Fatigue. *Landscape and Urban Planning*, 149-158. Retrieved March 2016, from <http://www.sciencedirect.com/science/article/pii/S0169204615002571>
- [22] Mitchell, D., Kahn, B., and Knasko, S., 1995, September. There's Something in the Air: Effects of Congruent or Incongruent Ambient Odor on Consumer Decision Making. *Journal of Consumer Research*, 22(2), 229-238. Retrieved March 2016, from <http://www.jstor.org/stable/2489814>
- [23] Nisbet, E., Zelinski, J., and Murphy, S., 2011. Happiness is in our Nature; Exploring nature relatedness as a contributor to subjective well-being. *Journal of Happiness Studies*(12), 303-322. doi:10.1007/s10902-010-9197-7

- [24] Posen, D., 2013. *Is Work Killing You: A doctor's prescription for treating workplace stress*. House of Anansi.
- [25] Raanaas, R., Evensen, K., Rich, D., Sjoström, G., and Patil, G., 2011. Benefits of Indoor Plants on Attention Capacity in an Office Setting. *Journal of Environmental Psychology*(31), 99-105. doi:10.1016/j.envp.2010.11.005
- [26] Radcliffe, D., 2013, February. Exclusive Preview: Google's new built-from-scratch googleplex. *Vanity Fair*.
- [27] Shibata, S., and Suzuki, N., 2004. Effects of an Indoor Plant on Creative Task Performance and Mood. *Scandinavian Journal of Psychology*(45), 373-381. doi:10.1111/j.1467-9450.2004.00419.x
- [28] Tsunetsugu, Y., Miyazaki, Y., and Sato, H., 2007. Physiological Effects in Humans Induced by the Visual Stimulation of Room Interiors with Different Wood Quantities. *Journal of Wood Science*, 1(53), 11-16. doi:10.1007/s100086-006-812-5
- [29] Tsunetsugu, Y., Park, B., and Miyazaki, Y., 2010. Trends in Research Related to "Shinrin-yoku" in Japan. *Environmental Health and Preventative Medicine*, 1(15), 27-37. Retrieved from <http://www.springerlink.com.proxy2.lib.umanitoba.ca/content/1hh427h988533734/fulltext.pdf>
- [30] Ulrich, R., 1993. Biophilia and Natural Landscapes. In S. Kellert, and E. Wilson, *The Biophilia Hypothesis* (pp. 73-137). Washington, D.C.: Island Press.
- [31] Ulrich, R. S., Simons, R. F., Losito, B. D., Fiorito, E., Miles, M. A., and Zelson, M., 1991. Stress Recovery During Exposure to Natural and Urban Environments. *Journal of Environmental Psychology*(11), 201-230.
- [32] Wilson, E. 1986. *Biophilia*. Cambridge: Harvard University Press.

Pioneering “Comprehensive Urban Landscape Technology” (CULT): An Integrated System Model for Urban Sustainability as Community Amenity in A Compact Urban Environment

Thomas CHUNG Wang-leung^a

^a The Chinese University of Hong Kong, Hong Kong SAR, tchung@cuhk.edu.hk

ABSTRACT



Floating Fields is at once an edible pond-scape and enjoyable public space. Conceived as a productive landscape for an architecture and urbanism exposition, the built project reinterprets the local cultural context and water-based agricultural traditions to create integrated sustainability. The 3,200m² project comprises a self-cleaning water cycle with floating farm plots, fish, duck, silkworm and microalgae cultivation, as well as filtering plants. Aspiring to an alternative, place-based bio-social urbanism, the project was awarded the Organizing Committee Grand Prize for the Shenzhen Hong Kong Bi-city Biennale of Urbanism\Architecture UABB (SZ) 2015-16. The project continues to act as a multi-disciplinary laboratory and research node on urban food production, sustainable design and green development.

Currently, Floating Fields is being transformed to demonstrate possibilities of comprehensive sustainability through calibrating an urban landscape system as innovative model for future community amenity. Eventually, the intention is to optimize the system to develop a prototype for other new urban developments.

Keywords: integrated sustainability, productive landscape, inclusive eco-design

1 INTRODUCTION: BACKGROUND AND CONTEXT

Floating Fields is a major architectural landscape commissioned for the Shenzhen Hong Kong Bi-city Biennale of Urbanism\Architecture UABB (SZ) 2016 at the Former Dacheng Flour Mill in Shekou. At once a productive edible pond-scape and enjoyable public space **responding to the biennale theme of 'Re-Living The City'**, the 3,200m² project comprises a self-cleaning eco-water cycle of ponds with floating farm plots, fish, duck, silkworm and microalgae cultivation, as well as filtering plants. The project draws from the site contexts, inspired by the operation and tradition of oyster cultivation using floating bamboo plots in Deep bay, while also reviving the roots of the water-based polyculture ecology (multiple agri + aqua-cultures) that once defined the unique territorial landform of the Pearl River Delta in Southern China.

In the past, inhabitants of the low-lying, flood-prone, delta landscape fused agriculture including silkworm, mulberry leaves and fish cultivation with inventive eco-engineering to evolve the Mulberry-dyke Fish-pond, one of the most celebrated examples of intensive eco-agriculture of the region. It engendered a once flourishing water-based commerce that has now all but vanished leaving abandoned landscapes. The existing site, an obsolete flour factory,

is a product of Shenzhen's rapid modernization, whose concrete construction was cracking up to allow the enduring resilience of nature to return as overgrown wild blossoms.



Figure 1: Left: Disused dormitory, middle: Traditional mulberry-dyke fishpond, Right: Deep Bay oyster rafts

2 CONCEPT AND DESIGN

The design operates on several levels to resuscitate the lifeless site. The presence of an existing covered waterway running diagonally through the site parallel and west of the oblong former factory dormitory spawned the idea to reintroduce the aquatic theme. The life-giving waterway is revitalized into a row of filtering ponds. The idea of a connected series of ponds holding various aquatic functions is extended around and outwards from the building. Their orientation, size and configuration derive from the structural bay rhythm and main entrances of the existing building, a linear block that has itself been converted during the biennale into a multi-use learning resource centre with exhibition, roundtable space, mezzanine library and a café restaurant.

Concrete ground east of the building is broken up to form larger ponds. Part of the rubble is crushed and recycled as gravel to fill pathways between ponds. The productive ponds are themselves formed from concrete bricks, and complemented with various pathways, platform and bridge with steps, benches and pavilions to create a walkable landscape combining food production and leisure.

3 ECO-WATER CYCLE AND FLOATING PLOTS



Figure 2: Eco-water cycle plan diagram showing complete cycle from 1 to 8.

A complete ecological pond-scape wraps around the old dormitory. The self-sustaining water cycle begins with nutrient-rich 'waste' water fed into the algae pavilion's ponds (7). Two types of colourful micro-algae are expertly cultivated in two ways to enhance the water purification. A specially designed three-step cultivation open pond sequence culminates in the harvest tank where the grown algae can be collected to ultimately produce organic fish feed, fertilizers and even biofuel.

Next comes a corridor of filtering ponds that purify the project's waste water using filtering gravel and filtering plants as the filtering medium (8). Volcanic rocks, broken tiles, and coarse river sand make up the gravel, while the plants include Umbrella Grass, Powdery Thalia, Iris, Alocasia plant, etc.. Water trickles through the medium successively in a zigzag fashion to elongate the filtering distance. The water-based plants are chosen for both their filtering capabilities and their visual qualities, and can be viewed along the elevated brick bridge.

The 'cleaned' water then flows into the prominently placed water lily pond (1), through the koi carp pond (2) and duck pond (3), into the big ponds where a contemporary version of the Mulberry dyke-Fishpond cultivation is combined with aquaponics (4 and 5). Carp stool, uneaten fish-feed and duck droppings nourish the water. Edible fish ponds and floating plots are surrounded by mulberry beds that are grown to feed cocoon-spinning silkworms inside a silkworm pavilion (6).

The floating plots return oxygen to the water while partially absorbing nutrients in it, before it is fed back to start of the cycle to the algae pavilion. The floating plot, inspired by existing flotilla of bamboo rafts that is part of the oyster cultivating tradition of neighbouring Deep Bay, is tested out within the ponds as light-weight, mobile farming plots. This latter idea is tested on different horizons, on water-bodies, filling pavilion roofs or on top of the converted dormitory. Part of the cleaned water is also used for rooftop plot irrigation.

Floating Fields integrates multiple cycles, wherein each pond can have two-way nutrient provision, waste water recycling, crop production, water purification and landscape features, creating more flexibility than conventional systems. The connected pond-scape operates as a self-sustaining ecology to demonstrate a virtuous cycle of hybrid urban-agricultural environment that can also become at once a productive and leisure public space for the enjoyment of all.

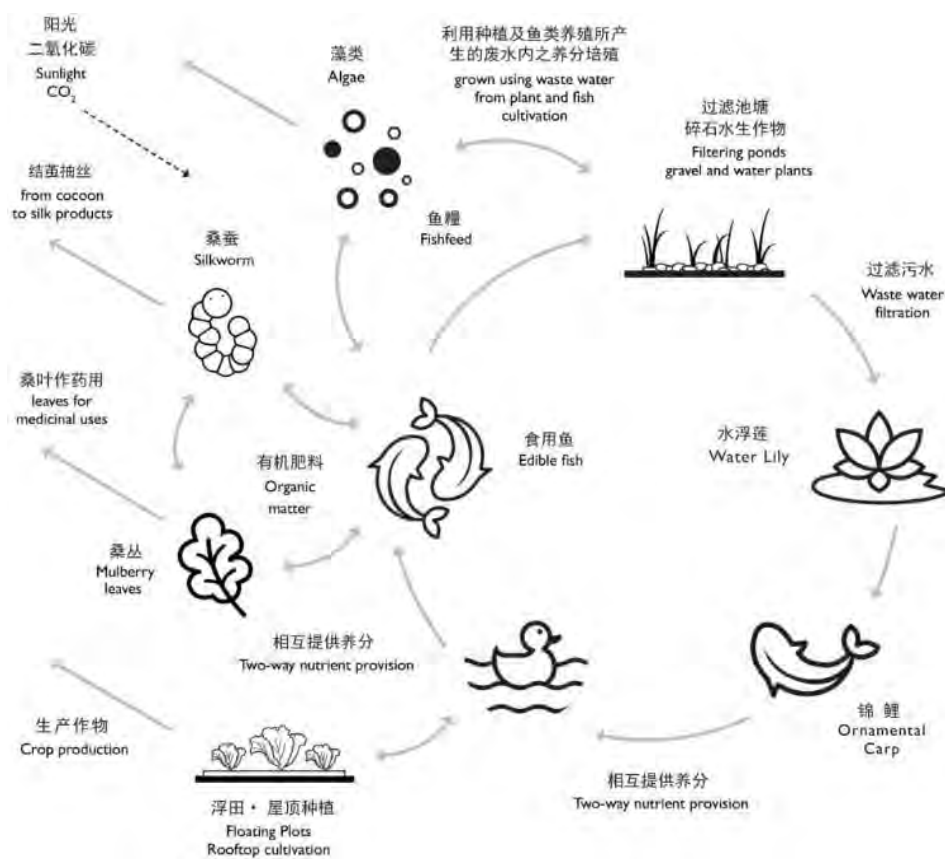

Figure 3: Multiple-cycle ecology

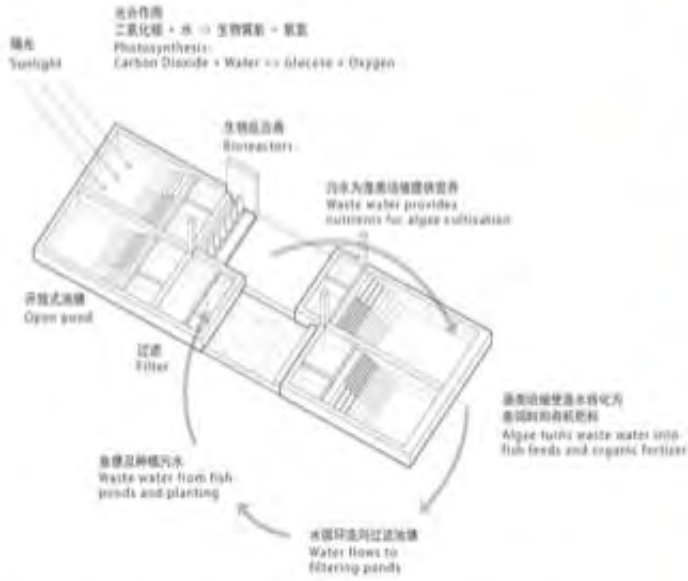

Figure 4: Algae pavilion diagram (Left), open ponds day + night

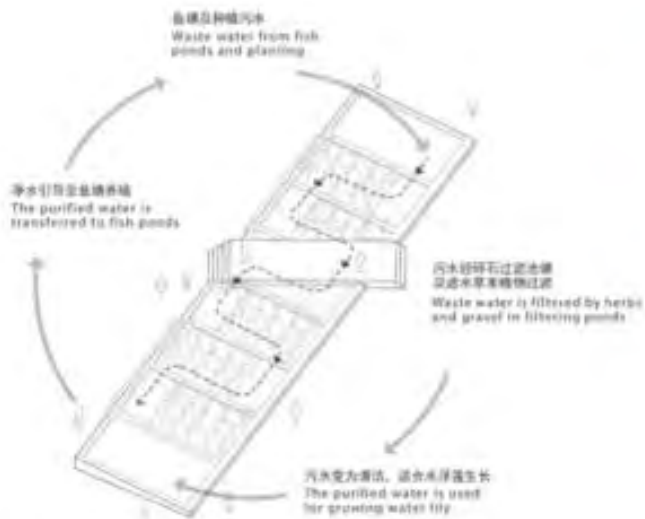

Figure 5: Filtering ponds diagram (Left), photo (Right)

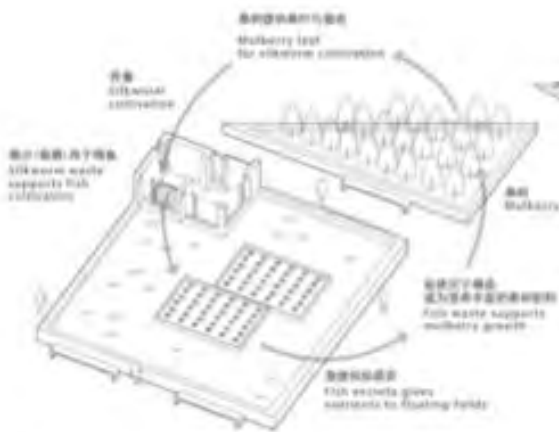

Figure 6: Floating plot aquaponics diagram (Left), photo (Right)



Figure 7: Floating fields as productive edible pond-scape and enjoyable public space

4 PUBLIC ENGAGEMENT AND RECOGNITION

Floating Fields generated events with great response and publicity from local community and media. At the Biennale 'Opening Forum', in the presence of all curators, international critics, architects and exhibitors, Floating Fields was a featured project in the discussion on notion of envisioning PRD 2.0. 'Planting Day' gave over 100 city kids and their families the chance to sow their own floating plots, catch fish and learn about duck, silkworm and algae life-cycles first hand. 'Tasting Festival' supported by local CSA (Community Supported Agriculture) groups offered participants fish soup and salad rolls (harvested on site) with talks on urban agriculture and the potential of microalgae in architecture and urban ecology. 'Harvest Parade' at the Biennale Closing successfully harvested the first crop of floating plots, presented algae cultivation results, and included a forum "Envisioning urban agriculture and ecology for Bio-social living". At the Biennale Closing, Floating Fields was awarded the UABB (SZ) 2016 Organizing Committee Grand Prize. Recently it has been shortlisted as the World Architecture Festival 2016 (WAF) Production Energy and Recycling Completed Building category Finalist.



Figure 8: a + b) Pond side leisure space; c) Brick bridge allow elevated view over filtering ponds



Figure 9: a) Planting Day sowing; b) Tasting Day fish catching; c) Pond side café boating; d) Water proximity

5 CONTINUITY AND EXTENSION

Currently, Floating Fields is being transformed to demonstrate possibilities of comprehensive sustainability through calibrating an urban landscape system as innovative model for future community amenity. There are three main objectives:

- To demonstrate the key role architectural and landscape design play in integrating biodiversity and environment-related technologies to create sustainable public amenity.
- To test and optimize the constructed system as a dynamic, multi-functional facility that addresses: minimising carbon footprint, resource recycling, waste reuse, urban food production, waste water recycling in the water-carbon-food nexus.
- To combine productive, leisure and educational functions and operate as a live demonstration of urban sustainability within a real-life community.

General research themes include: low carbon energy production, turning waste into energy; cultivation of wide range of local species – from microorganisms (algae) to plant form (edible crops and filtering plant, fish and poultry); waste reduction and recycling – food waste for algae, fishfeed cultivation; and improving water treatment – water purification by algae, aquaponics – converting it into part of productive cycle.

With pertinent urban problems such as dwelling space shortage, urban food supply and production, carbon footprint, wise use of resources 3Rs (food and water waste), there is a great need in Hong Kong to educate and raise public awareness via demonstration projects that also function as community amenity public space. Separate studies of aforementioned research themes have been carried out, but an integrative comprehensive approach at a larger scale, using a real design on a living community has not been attempted.

Specific scope includes 1) optimising individual parts into the integrated system (data analysis); 2) evaluate architectural and landscape design of system; 3) refinement of integrated system and individual parts through periodical feedback loop (eg. review every 3-4 months); 4) develop comprehensive evaluation framework to coordinate system effectiveness and optimize production (perform the multi-objective optimization of the whole

system to achieve design goals with efficient resource allocation); 5) display and educational aspects evaluation through questionnaires; and 6) community participation, contribution of food waste, assistance with cultivation and monitoring, engagement through events and promotion. Eventually, the intention is to optimize the system to develop a prototype for other urban developments.



Figure 10: Innovative public space model of hybrid productive leisure architecture-landscape

6 CONCLUSION

To continue the project as a live experiment, it is hoped that Floating Fields will eventually become a multi-disciplinary laboratory and research node on sustainable design and green development. Using the site and Shekou as base and context, the intention is to engage in innovative research on topics such as bio-social design, architecture and urbanism; empirical research on water ecology and algae cultivation; and sustainable urban food production and its integration with the built environment.

Returning to fundamental urban re-living, disbanding excessive construction, and resuming a symbiotic space for nature, Floating Fields hopes to engender an innovative public space model that cultivates comforting nourishment and soothing experience amidst the restlessness of our buoyant city.

Foster a Healthy Community Through Active Design and Biophilic Design

WANG Hong^a, LIN Han^b, TONG Yun-on^c

^a AECOM Asia Company Ltd., Mainland China, hong.wang@aecom.com

^b AECOM Asia Company Ltd., Mainland China, han.lin@aecom.com

^c AECOM Asia Company Ltd., Hong Kong SAR, nelson.tong@aecom.com

ABSTRACT

Humans are inherently interested in connecting with the natural environment. With the increasing urban constructions, they not only induced severely environmental impact, but also separated us from the nature. Despite the adoption of conventional green building technology can mitigate some of the adverse environmental impact, seldom can it help to re-establish the human-nature connection. To regain the missing link, Biophilic Design has become one of the strategic developments for AECOM Sustainability in the recent two years. Through a proper way to articulate the relationships between nature, science, and built environment so that we may experience the human benefits of biophilia in our design applications. Through a proper architectural design and the utilization of building physics, Biophilic Design can successfully integrate various natural elements within our working environment or habitat and positively influence our living style. Numerous research efforts have supported the benefits of adopting biophilic design in various development, which include helping hospital patients to recover **within a shorter timeframe, increasing the students' learning motive and achievements, enhancing the working efficiency of employees and strengthen the communication within the community.**

Currently, the lack of physical activity is being listed as one of the world's top ten major risk factors for death. The decline in the rate of physical activity is partly due to the limitation from our workplace and the sedentary living habit of modern society. To promote the concept of healthy living style through exercising amongst local community, the Community Active Design makes use of proper space planning and design to provoke the curiosity and interest of citizens to explore the nature of space around the neighbourhood, which can imperceptibility influence their living habits, enhancing their health and well-being and foster a healthy community.

Keywords: sustainable neighbourhood, biophilic design, active design

1 INTRODUCTION

This paper is mainly divided into two sections. In the first section, the guiding principles of biophilic design will be discussed. In addition, special interests are drawn to examine the applicability and feasibility of integration biophilic design concept into modern architecture development. In the latter section, focuses will be switched to discuss **how Community Active Design positively influences citizen's living habits through appropriate community planning and design.**

2 BIOPHILIC DESIGN

Biophilic Design is a dedicated effort to affiliate human affinity with natural systems. Although the concept has existed for many years, it has not yet been a common consideration factor in modern architectural design. With the growing quantified supports from researches, the positive impacts of biophilic design begin to gain increasing attentions (Kellert, 2005).

To develop a common ground for discussion and to better organize the diverse concept, Terrapin (2014) has issued a paper to identify 14 patterns of biophilic design, which are organized into three main categories namely – (i) Nature in the Space; (ii) Natural Analogues and; (iii) Nature of the Space. Table 1 outlines the overview of 14 biophilic design patterns under these three categories and their possible forms of expression.

Nature in the space:	Natural analogues:	Nature of the space:
Incorporation of plants, water, and animals into the built environment, especially with movement	One degree of separation away from true nature; patterns and materials that evoke nature	The way humans respond psychologically and physiologically to different spatial configurations
1. Visual Connection with Nature – plants inside and out, green roofs, and living walls, water, nature artwork	8. Biomorphic Forms and Patterns – organic building forms, structural systems (savannah effect)	11. Prospect – views, balconies, 6m and above focal lengths, open floor plans
2. Non-Visual Connection with Nature – sun patches, textured materials, bird sounds, weather, nature scents	9. Material Connection with Nature – organic building forms, structural systems (savannah effect)	12. Refuge – protected spaces, overhead canopies or lowered ceilings, places providing concealment
3. Non-Rhythmic Sensory Stimuli – clouds, shadows, nature sounds, water reflections	10. Complexity and Order – fractal patterns, sky lines, plant selection, and variety, material textures, and colors	13. Mystery – winding paths, obscured features, flowing forms
4. Access to Thermal and Airflow Variability – shade, radiant heat, seasonal vegetation		14. Risk/ Peril – floor to ceiling windows, water walks, high walkways
5. Presence of Water – rivers, fountains, water		
Nature in the space:	Natural analogues:	Nature of the space:
walls, ponds, day lighted streams		
6. Dynamic and Diffuse Light – light from different angles, ambient diffuse, lighting, circadian lighting		
7. Connection with Natural Systems – seasonal patterning, wildlife habitats, diurnal patterns		

Table 1: Patterns of biophilic design

2.1 Nature in the space

Nature in the Spaces emphasizes on the direct, physical and ephemeral presence of nature in a space or place. Natural elements like the presence and diversity of plant lives, animal species and water features can be included within the built environment to strengthen the nature-human connection. There are mainly two strategies to bring nature into the interior space including integration or simulation.

The most common approach for integration is to include tangible or integrate visible green features within the built environment. Should there be sufficient space, designers can consider features like indoor-terrace-gardens and courtyards. For area with limited space, features like potted tree and small water features can be adopted. Designers should also use windows strategically to maximize the visual connection with natural landscape. Additional benefits can be realized if natural ventilation or lighting is integrated to the building design to provide

occupants with non-rhythmic sensory stimulation. While no specific criteria is laid down by the biophilic design guide in this area, references can be drawn to some of the internationally recognized standards like the ASHRAE 55 and ISO 7730 standard as design guide.

Besides integration, simulation is another useful technic to mimic the natural environmental for place where space or outdoor view are greatly limited. For examples, landscape representation (e.g. paintings) can be used as indoor decoration to enhance visual experience. Nevertheless, these simulated environments are steady with no variation across time. A more favourable alternative is to simulate the nature scenes through digital medium (e.g. video depicting nature scenes).

2.2 Natural analogues

Natural analogues focus more on evoking the indirection connection with the natural environment. The ultimate intention is to imitate the natural environment and articulate connections between aspects of the built and natural environments.

There are essentially two approaches to applying natural analogues concept, as either a cosmetic decorative component of a larger design, or as integral to the structural or functional design, characterizing mainly through four different forms: representational artwork, ornamentation, biomorphic forms, and the use of natural materials. For the former three forms, much emphasis is placed on using fractal patterns to create a visually nourishing environment that engenders a positive psychological or cognitive response (Salingaros, 2012). Extreme caution must be taken when using such strategy as over complex patterns are found to induce stress and visual perception problems (Hägerhäll et al., 2008). It is more preferable to apply this tactic to common area like corridors or pantries rather than normally-occupied space, which helps avoiding visual fatigue induced by prolonged exposure. For the use of natural materials, it is recommended to preserve the natural forms of the materials or undergo minimal processing. Terrapin (2014) pointed out that the type of material is important for perceived restorative quality and people usually preferred real materials over synthetic one. Hence, designers could consider adopting the natural materials such as natural stone and clay. Priorities should be given to those rapidly renewable materials which can replenish faster than traditional extraction demands, thereby reducing the adverse impact to the environment.

2.3 Nature of the space

Nature of the space pinpoints to the innate and learned desire of human to see beyond our immediate surroundings. The degree of perception of human in this aspect is greatly influenced by the spatial configurations of the space. Examples includes creating an unimpeded views over a distance or conversely, partially obscured views that inspire a sense of mystery.

The understanding in this category of biophilic design has long been demonstrated by a number of ancient and **contemporary architectural examples**. For illustration, the examples from **JWT office in Atlanta and Hubspot's** Headquarter in Cambridge will be used to demonstrate how this biophilic design category can be applied in modern office development to create a sense of prospect and refuge.

JWT Office – Prospect

The design is focused on creating a space which allows people to see from one space to another. This is based on the survival philosophy that it is the human instinct to be able to understand the environment and estimate any threats or opportunities. Hence, the JWT has applied a large number of windows both interiorly and exteriorly to provide users with a condition suitable for visually surveying. The exterior window façade also allows visual connection with nature which optimize the prospect experience with a quality view.



Figure 1: JWT office in Atlanta

Hubspot's headquarter – Refuge

The design objective is to provide users a small portion of protective environment within a large space. The area should limit visual access into the refuge place and offer overhead and back protection. In particular, it can be **seen from the Hubspot's example that entirely enclosure of the refuge place is not necessary; instead a proper opening can provide users visual or aural contact with the surrounding environment for surveillance.**



Figure 2: Hubspot's headquarter in Cambridge

3 ACTIVE DESIGN

The Biophilic Design is usually applied at individual building level, which targeted at enhancing the psychological well-being and health of occupants through applying the 14 biophilic design patterns. Active design, on the other hand, is concerning the ways to form a healthy community through proper space planning and design. It focuses **on inducing peoples' initiatives to explore and utilize their surrounding facilities; thus, promoting the physical health** of the occupants. By applying these two design philosophies at both building and community level, it could maximize the health benefits to occupants both psychologically and physically.

3.1 Oversea and Chinese researches comparison

In recent years, active design and active community concept have becoming a more popular topic in the green building industry. Numbers of researches have been published discussing ways to promote healthy lifestyle. Noticeably, the research direction for oversea researchers and Chinese researches are distinctively difference.

The researches effort in China is mainly focus on application level, especially the difficulties in implementing active design concept in China. Researchers conclude that there are two primary reasons that limit the prevalence of active design community. First, there are inadequate connections between active facilities and communities. Some active facilities are exists independently rather than an integral part of the community. For example, fitness trails

are often only available around stadium which located distance away from the resident blocks. Such inconvenience discourages people to use these facilities. Second, designers sometimes have failed to recognize the cultural differences in planning the construction of community facilities. For instance, people in China are comparatively less enthusiastic about basketball than European countries. As a result, the utilization rate of these facilities are not too satisfactory.

Overseas researches show different areas of focus. They are more interested in establishing the positive relationship between active design and health. The hypothesized Active Community Environments (ACES) model proposed by Scott Doyle (2007) illustrated the process of how active community environments improve the overall health status of occupant (refer to Figure 3). Scott also found that sense of safety and the walkability of community are parts of the influential factors – people living in a walkable community with low crime rates tend to be healthier.

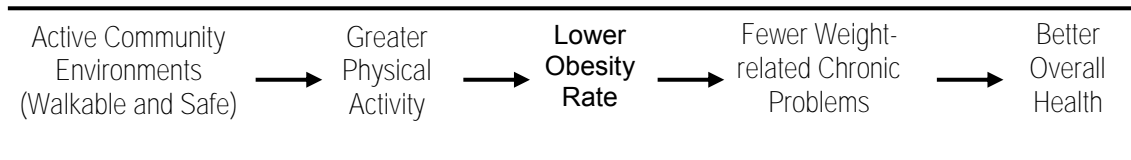

Figure 3: Aces model proposed by Scott Doyle

Although Chinese and overseas researchers have explored various factors influencing the active design, limited attention was paid to investigate the importance of human perception on comfortability. In a survey conducted by Lay (2014), his result proved the relative importance of comfort to active community design. When answering the question 'Why you choose this outdoor space?', over 58% of the respondents replied the primary reason was due to comfort-related concerns including thermal comfort, air quality and acoustic environment. Figure 4 presents the overview of the survey's result.

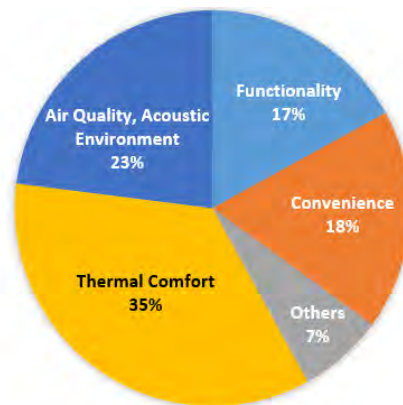

Figure 4: Aces model proposed by Scott Doyle

3.2 Consideration factors in active design

Despite the differences in researches focuses between Chinese and Overseas scholars, their ideologies are not contradictory but complementary to each other. To provide a more systematic approach and overall picture towards Active Design, the following matrix (Table 2) are proposed:

	Community Level	
Building Level	Safety: From a design perspective, it is mainly affected by the environmental design including the lighting level, access control (e.g. locks, guards), surveillance and etc.	Walkability: A measure of how friendly an area is to walking. Factors influencing walkability include the presence or absence and quality of footpaths, sidewalks and etc.
1. Building Facilities – promote physical activity and encourage healthy living style through provision of supporting facilities, e.g. indoor gardening area or bicycle parking facilities)	✓	✓
2. Open Space Design – provision of recreational facilities appropriate to local culture, e.g. For China → provision of Taichi and dance area)	✓	✓
3. Circulation – refers to appropriate design of indoor circulation path and provision of adequate signal to encourage physical activity within indoor environment, e.g. provision of office stair with appropriate length	✓	✓
4. Perception of Comfortability – can be addressed through proper consideration of site characteristics such as site wind availability, noise emitting source from proximity area and etc.	NA	NA

Table 2: Active design consideration matrix

The above table outlines the general design principles to be applied at both building and community level. It should be noted that these principles have to be considered as a whole in order to achieve a satisfactory active community design.

3.3 Active design in application – Foshan MEGAHALL MOMA project

To instil a sense of safety, the carriageway of this project was designed all along the exterior area of the community while all pedestrian areas were centralized in the middle of the project site. This effectively separated the pedestrian and vehicle movements and improved the residents' safety index. Moreover, the community reserved a large, concentrated and open spaces for recreational and leisure purposes of the all-age of occupants. Advanced sunlight analysis and wind environmental analysis were also conducted within the subject site to assist in the strategic planning of community. For instance, the activity spaces for children and seniors were deliberately placed at areas where abundant of sunshine was availability to ensure the maintenance of a comfortable environment.

Regarding the community facilities, a 600 meters long jogging lane was provided within the community site. Calories signs were marked on the lane every 150 meters to promote a healthy lifestyle. Apart from the provision of traditional lighting facilities, fluorescent coating was also painted along the lane. This special feature provided extra incentives or attraction for people to explore the lane and to exercise more frequently.

4 CONCLUSION

This paper presents the design principles in implementing the concept of biophilia and active community. It points out the associated psychological and physical health benefits to the occupants such as the enhancement of **employees' working efficiency and the reduction of risk of having chronic**-related health problems. In particular, based on literature reviews and precedent project experiences, the paper briefly discussed the difficulties in applying biophilic design and active design in real-project situation. To address/ eliminate these potential difficulties, the paper also proposes some practical approaches, through project examples, to provide design insight for optimizing the building and community design which can facilitate the development of a healthy and comfortable community environment.

REFERENCES

- [1] ASHRAE (2004) Thermal Environmental Conditions for Human Occupancy, Atlanta: American Society of Heating, Refrigerating and Air-Conditioning Engineers.
- [2] Browning, W.D, Ryan, C., Clancy, J. (2014) 14 Patterns of Biophilic Design, Improving Health & Well-Being in the Built Environment, New York: Terrapin Bright Green.
- [3] Doyle S. (2007) Active Community Environments and Health: The Relationship of Walkable and Safe Communities to Individual Health
- [4] Hägerhäll, C. M., T. Laike, R.P. Taylor, M. Küller, R. Küller, & T. P. Martin (2008) Investigation of Human EEG Response to Viewing Fractal Patterns, *Perception*, 37, 1488-1494
- [5] Kellert, S. (2005) Building for Life: Designing and Understanding the Human-Nature Connection, Washington, DC: Island Press.
- [6] Lay, D. X. (2014) Outdoor Space Quality: A Field Study in an Urban Residential Community, *Energy and Buildings*, 68, Part B, 713-720
- [7] Ryan, C. O., Browning, W. O., Clancy, J. O., et al. (2014) Biophilic design patterns: Emerging nature-based parameters for health and wellbeing in the built environment, *ArchNet Int J Architect Res* 8: 62-76.
- [8] Salingarios (2012) Fractal Art and Architectural Reduce Physiological Stress, *Journal of Biourbanism* 2(2).
- [9] Salingaros (2005) Biophilia & Healing Environments: Healthy Principles for Designing the Built World, New York: Terrapin Bright Green.
- [10] UNI EN SIO 7730 (2006) Ergonomics of the Thermal Environmental - Analytical Determination and Interpretation of Thermal Comfort Using Calculation of the PMV and PPD Indices and Local Thermal Comfort Criteria.

Poster Session

Development of Solar Photovoltaic Pavement Panels for Application on the Green Deck

MA Tao^a, YANG Hongxing^b, LU Lin^c

^a Renewable Energy Research Group (REG), Department of Building Services Engineering, The Hong Kong Polytechnic University, Hong Kong SAR, tao.ma@connect.polyu.hk

^b Renewable Energy Research Group (REG), Department of Building Services Engineering, The Hong Kong Polytechnic University, Hong Kong SAR, hong-xing.yang@polyu.edu.hk

^c Renewable Energy Research Group (REG), Department of Building Services Engineering, The Hong Kong Polytechnic University, Hong Kong SAR, vivien.lu@polyu.edu.hk

ABSTRACT

Hong Kong, locating at a lower latitude area, is suitable for solar energy application, especially building-integrated solar photovoltaic (BIPV) application for power generation in urban environment. A BIPV system is highly dependent on available installation area of a building because usually the PV panels are placed on roofs or vertical facade of a building due to their broad and open surfaces for receiving more sunlight. However, the available roof and vertical facade area for PV installation in the proposed Green Deck is very limited due to green areas and other facilities. Therefore, in this study, the walkable solar PV panel is proposed for application in the pavements and cycling tracks, which receive a lot of sunshine and can be used for power generation as well. This is a green and innovative solution to integrate sustainable energy technology into the Green Deck and it can help to achieve the target of low carbon city in Hong Kong. The major research activities are presented in this study, including literature review on available technologies, configuration design, prototype preparation, electrical, and thermal performance tests. Results show that the developed PV pavement panel has satisfactory performance in solar energy conversion efficiency and other performance.

Keywords: renewable energy, green deck, solar photovoltaic pavement

1. INTRODUCTION

Solar energy is considered as one of the potential feasible sources of wide-scale renewable energy application in Hong Kong, along with wind energy and waste-to-energy (EMSD, 2002). In urban environment, building integrated photovoltaics (BIPV) system is an attractive application of solar energy (Lo, 2005). BIPV refers to PV cells which can be integrated into the building envelope as part of the building structure, and therefore can replace conventional building materials (Henemann, 2008). BIPV applications in Hong Kong are truly sustainable with short energy payback time and greenhouse-gas emission payback time, around 2-3 years for roof-top type and 3-6 years for other vertical PV façade, both are much less than their lifespans of 30 years (Lu and Yang, 2010, Lu, 2011). A BIPV system is highly dependent on available installation area of a building because usually the PV panels are placed on roofs or vertical facades of a building due to their broad and open surfaces for receiving more sunlight.



Figure 1: The Green Deck project proposed by The Hong Kong Polytechnic University

The Hong Kong Polytechnic University proposed the construction of a Green Deck over the Cross Harbor Tunnel plaza to tackle the problems in the vicinity – poor air quality, overloaded footbridge, poor connectivity within the district and lack of open space (Figure 1). The Renewable Energy Research Group at the university, therefore, has conducted a previous study to investigate the feasibility of using BIPV system for power generation to achieve the zero carbon emission green deck. However, result demonstrates that the available roof and vertical facade area for PV installation is very limited due to green areas and other facilities on the Deck (Yang et al., 2014). To find more possible areas for solar power generation, this research project focuses on how to use the pavements and cycling tracks for installing PV panels so that most or all the electricity consumed by the Deck can be supplied by solar energy. Therefore, walkable solar PV-panelled pavement is proposed to replace traditional floor tiles for the pavements and cycling tracks, which receive a lot of sunshine every day.

This is a green and innovative solution to integrate sustainable energy technology into the deck and to achieve the target of zero energy consumption and zero greenhouse gas emissions of the Green Deck. Moreover, the appealing design of the solar pavement could offer a fantastic range of configuration possibilities in colour to enhance the aesthetic value. The major objectives of this study are as follows:

- To investigate the feasibility of this technology applied on the Green Deck;
- To develop new PV panels used for pavement, and
- **To study the panels' electrical and thermal performance** experimentally.

2. LITERATURE REVIEW ON AVAILABLE TECHNOLOGIES

Currently, there are several demonstration projects of solar road or pavement in the world. The Netherlands built the world's first solar road, which is an energy-harvesting bike path paved with glass-coated solar panel (Figure 2). After one-year's trial, the novel solar road has proved more successful than expected (Macdonald, 2015). It can generate about 70kWh/m²/year, indicating that the 70-metre test bike path is enough to power a small household. However, this cutting edge technology is under its infant development stage and still has some problems, for example, such solar panel is very heavy so it is very difficult to install it, and the anti-slip coating, which provides grip to the surface, has become delaminated due to long term sun exposure and temperature fluctuations.



Figure 2: Netherlands' solar road project

Another innovative technology is the walkable solar PV pavement developed by Spanish tech company Onyx Solar (Onyx, 2016). Such PV floor can comply with the anti-slip regulation and support 400 kg in point load tests. To demonstrate the capabilities of the technology, The George Washington University created what is claimed to be "the first walkable solar-panelled pathway in the world" (Figure 3). This micro power plant has a peak power output of 400 watts, which is enough to illuminate an array of 450 LEDs that light the pathway at night, shining up through the panels from beneath. However, this solar cell is based on amorphous silicon technology with relative low efficiency. Besides, the front glass is translucent so the received solar radiation is reduced. Therefore, the power output is very limited.



Figure 3: A walkable PV pavement system

The third technology is the solar block or solar brick light (Figure 4), which are integrated with a self-contained illuminating device. They can add both day and night-time colour to walkways and other outdoor surfaces without additional wiring. The small PV tiles can generate electricity and store energy (even in rainy days), emitting a soft LED glow at night. This technology is popularly used in some parks and walkways. However, the major problem is that each PV tile can only generate several watts electricity for powering LED lights, not suitable for large scale power generation system.



Figure 4: Solar PV light emitting tiles

3. PROTOTYPE DEVELOPMENT

In this project, we developed a new type of solar PV pavement panel through collaboration with a local solar PV engineering company. Figure 66 shows the layout design of the PV floor configuration, which is sandwiched between anti-slip front tempered glass, EVA/PVB foils, solar cells, and rear support tempered glass. The total front size is 500×500mm, similar to the general pavement tiles. The thickness is about 20mm. In each floor tile, 9 monocrystalline silicon solar cells are connected in series, so that the expected power generation and efficiency are about 30-40Wp and 15%, respectively.

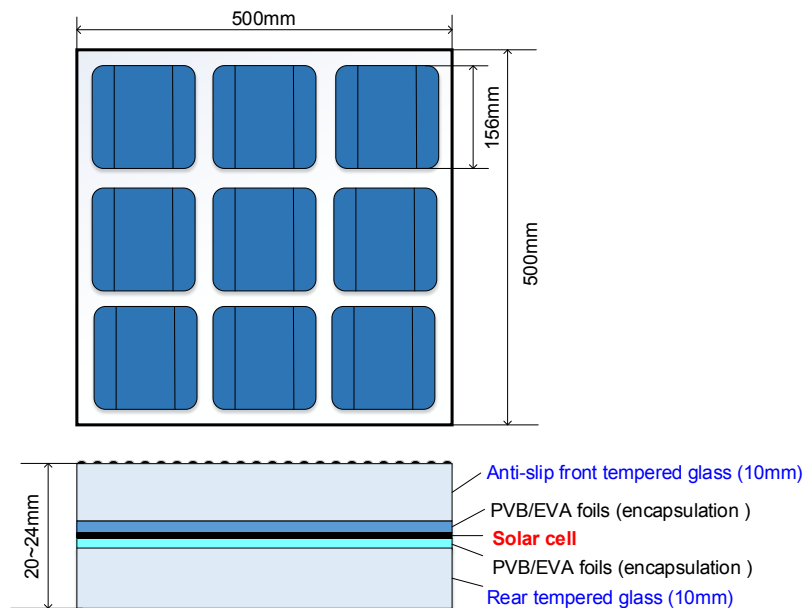

Figure 66: PV floor tile configuration

The raw materials including tempered glass and solar cells were purchased from manufacturers in mainland China, Kong (Eco Engineering Limited).



Figure 67 shows the two developed prototypes of the PV floor tiles with different anti-slip surfaces, i.e. cross-line pattern and dot pattern. In general, the floor tile with cross-line layer has higher anti-slip performance but lower sunlight transmissivity.



Figure 67: PV floor tiles with different anti-slip surfaces

The major features of the developed solar PV floor tile are summarized in Table 12. The static coefficient of friction of the PV floor is 0.78 for dry surface and 0.54 for wet surface, indicating that it is absolutely anti-slip. It also has high transparency with solar light transmissivity of 90%. The heat-resistance temperature can be up to 288 °C, so there is no need to worry about whether it will be broken under long time sun exposure. The energy efficiency of solar cell and module can be up to 18% and 15%, respectively.

Features	Parameters
Anti-slip	Static coefficient of friction (COF): 0.78 for dry surface 0.54 for wet surface
High efficiency	module: 15%
High transparency	transmissivity: 90%
High compressive strength	max load: 74 kpa
High heat-resistance temperature	up to 288 °C

Table 12: Major features of the developed solar PV floor tile

4. PERFORMANCE EVALUATION

4.1. Indoor laboratory test

The test of the developed PV floor tile was first conducted in our solar simulator laboratory in the Hong Kong Polytechnic University. Figure 7 shows the test rig. The instrument EKO MP-11 is used to collect the I-V curve and power output every minute. The pyranometer is used to measure solar radiation intensity at the same level with the PV floor tile.

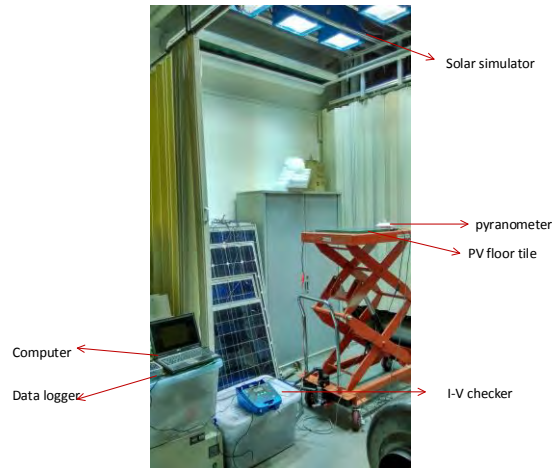

Figure 7: Test rig in PolyU laboratory (indoor test)

Figure 8 shows an example of the collected I-V curves and P-V curves. It can be observed that the maximum power output is 20.5W when solar radiation is 960W/m², and the energy efficiency is 10%.

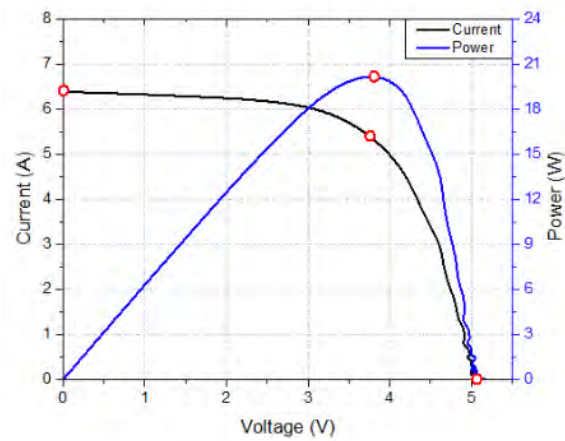

Figure 8: An example of the collected I-V curves and P-V curves

4.2. Outdoor field test

We also conducted outdoor tests on the solar PV floor on the 6th floor of Block Z with an open and no shaded space (Figure 9). The electrical and thermal performance has been tested. Figure 10 illustrates the collected solar radiation and power output from 12:00 to 3:00 in the afternoon. It is obvious that the variation of power output has close relationship with solar radiation. Besides, the solar radiation on the day is not very good because the weather is cloudy, ranging from 200 to 800w/m², therefore the power output of one PV floor tile is from 5 to 20W, and resultant efficiency is about 10%.



Figure 9: Outdoor test system in the 6th floor of Block Z

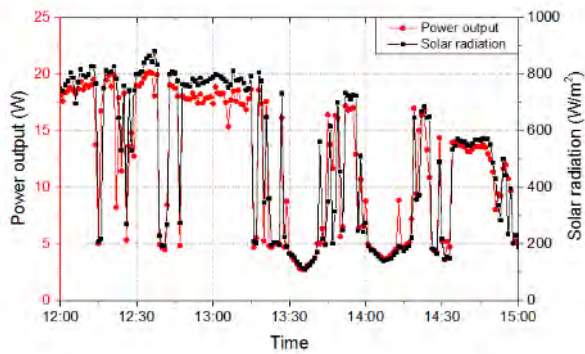

Figure 10: Collected solar radiation and power output

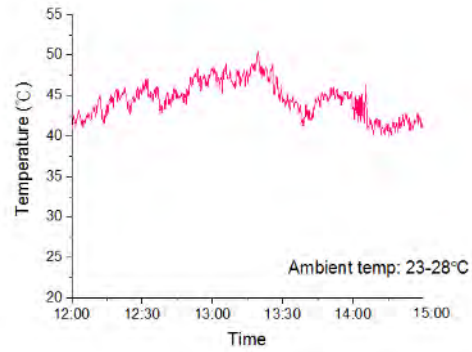

Figure 11: Thermal profile of the PV floor

The temperature of the PV floor tile under outdoor test was measured to evaluate its thermal performance. Figure 11 presents the temperature profile of the back side of PV floor tile. The module temperature is in the range of 40-50 °C although the ambient temperature is about 25°C on that day. Based on the specification of solar cell, the high temperature will have negative impact on power output by $-0.5\%/^{\circ}\text{C}$, therefore, the temperature difference of 25-30°C can result in about 13% (4W) decrease in power output.

The laboratory test and outdoor test results show that the power output are lower than the rated values because the transmissivity of the tempered glass is reduced by the additional anti-slip surface, which means that the received solar radiation on solar cells is decreased and the measured temperature of the PV floor is very high, which can reduce power generation by 10%-20%. Besides, the solar radiation on that day fluctuates greatly and does not reach the standard test condition of 1000W/m².

5. CONCLUSIONS

In this study, the walkable solar PV panel is proposed for installation on pavements and cycling tracks for the Green Deck project. The feasibility and potential area of applying this innovative PV floor on the green deck was investigated. Two prototypes were developed and tested to evaluate its electrical and thermal performance. Results show that the developed PV pavement panel can achieve satisfactory performance in solar energy conversion efficiency, anti-slip, heat-resistance, durability and compressive strength, demonstrating that such panels can be used as a replacement of the pavements and cycling tracks in the Green Deck. This technology can combine active elements (power generation) with passive elements (waste material for back panel manufacture), providing an innovative and green solution to integrate sustainable energy technologies into the deck and help to achieve the target of zero carbon emission of the deck.

6. ACKNOWLEDGMENTS

The work described in this paper is supported by research funding provided by The Hong Kong Polytechnic University, for the Green Deck project.

REFERENCES

- [1] EMSD 2002. Study on the Potential Applications of Renewable Energy in Hong Kong. Electrical & Mechanical Services Department.
- [2] HENEMANN, A. 2008. BIPV: Built-in solar energy. *Renewable Energy Focus*, 9, 14-19.
- [3] LO, E. 2005. Overview of building integrated photovoltaic (BIPV) systems in Hong Kong.
- [4] LU, L. 2011. Environmental payback time analysis of building-integrated photovoltaic (BIPV) applications in Hong Kong (ECF Project 2008-09). The Hong Kong Polytechnic University.
- [5] LU, L. & YANG, H. X. 2010. Environmental payback time analysis of a roof-mounted building-integrated photovoltaic (BIPV) system in Hong Kong. *Applied Energy*, 87, 3625-3631.
- [6] MACDONALD, F. 2015. The solar road in the Netherlands is working even better than expected [Online]. Available: <http://www.sciencealert.com/solar-roads-in-the-netherlands-are-working-even-better-than-expected> [Accessed 07/08/2016].

- [7] ONYX. 2016. Onyx walkable PV floor [Online]. Available: <http://www.onyxsolar.com/walkable-photovoltaic-roof.html> [Accessed 07/08/2016].
- [8] YANG, H., MA, T., LU, L. & QI, R. 2014. Renewable Energy Applications on the Green Deck. Green Deck project final report.

Study on the Prediction Model and Adjustment Strategies of Indoor Environment for Susceptible Populations

LU Mei-chen^a, TSAY Yaw-shyan^b, SU Huey-jen^c, HSU Nai-yun^d

^a Department of Architecture, National Cheng Kung University, Taiwan, mei101546@gmail.com

^b Department of Architecture, National Cheng Kung University, Taiwan, tsayys@mail.ncku.edu.tw

^c Department of Environmental and Occupational Health, College of Medicine, National Cheng Kung University, Taiwan, nyhsu@mail.ncku.edu.tw

^d Department of Environmental and Occupational Health, College of Medicine, National Cheng Kung University, Taiwan, nyhsu@mail.ncku.edu.tw

ABSTRACT

Recently, the occurrence of extreme weather events has gradually increased in many areas due to climate change. Furthermore, human health problems are resulting from such dramatic climate changes, as noted in hospital emergency visits and attendance rates after the occurrence of extreme events. In general, previous studies have used outdoor climatic data from ambient stations to assess the human health risks caused by extreme events. However, elderly people are often more vulnerable to heat exposure and thus spend most of their time indoors. This study aims to propose a predictive model to determine the indoor climate from weather forecasts in order to reduce health risks through the development of a warning system for susceptible populations.

In the present study, we propose a predictive model based on building energy simulations (EnergyPlus) and then performed field measurements of residential buildings to gather one year of data for verification. We further applied the simulation model in order to study the influence of changing building construction/materials in relation to adjusting the climate. Finally, we examined improvements made to indoor environments and their effect on the health risk of the susceptible population. The results demonstrate that not only can the indoor environment be properly predicted by the building energy simulation model, but also that improving thermal insulation, ventilation, and vertical greenery can improve the indoor environment, thus resulting in reduced health risks of the susceptible population.

Keywords: susceptible population, health risk, EnergyPlus

1. INTRODUCTION

Due to the increased occurrence of extreme weather events around the world, many studies have focused on the subsequent related health risks. However, most temperature-mortality studies have been performed in European and North American cities but rarely in areas with a subtropical climate. Crossed by the Tropic of Cancer, Taiwan is an island located in the west of the Pacific Ocean. With extreme weather expected to intensify in the future, evaluating the health risks associated with hot and humid climates, such as that in Taiwan, is important.

According to estimates made by the United Nations, the total number of people aged 65 years and older was 506 million in 2008, which is expected to more than double to 1.3 billion by 2040. Bunker et al. (2016) found that elevated risks for the elderly were noticeable in the outcomes of temperature-induced chronic diseases. Such risks will likely increase with climate change and global ageing. As the elderly often spend most of their time indoors, adverse indoor environments may potentially influence the health status of the elderly and cannot be ignored. Quinn et al. (2014) found that most residences surpass the heat index threshold during extreme events, indicating **that changes in indoor temperature and humidity during heat waves can threaten occupants' health.**

Indoor air quality has recently become a more important research topic with regard to improving the indoor thermal comfort, health, and even work efficiency of the occupants. Thermal comfort is influenced by outdoor environment **and a building's construction/materials, including air temperature, mean radiant temperature, relative humidity, and ventilation.** Kitamura et al. (2016) indicate that dramatic temperature changes in winter lead to the increased **morbidity of cardiovascular diseases.** **After installing insulation on the opening, the aforementioned study's results** showed that simple thermal insulation can slightly improve the indoor thermal comfort of the residents even without heating equipment.

Besides insulation materials, external shading devices are the most effective way to improve thermal comfort by controlling the solar load on buildings. Stazi et al. (2014) compared the thermo-physical behavior of five kinds of external shading devices, and their simulation results demonstrated that shading devices can improve indoor thermal comfort by decreasing the solar heat gain.

With shading, evapotranspiration, and reduced wind velocity, vertical greenery designs have been recommended in cities throughout the world to improve thermal comfort. Sunakorn et al. (2011) studied the effect of temperature reduction by vertical greenery with cross ventilation in Thailand and found that vertical greenery had a significant influence on temperature reduction during the day and increased the temperature difference between indoor and outdoor when wind velocity is low.

In this study, we developed a simulated prediction model and verified it with field measurements. Furthermore, indoor thermal comfort is improved by enhancing thermal insulation and installing external shading devices and vertical greenery on balconies in order to adjust the climate and decrease the health risks to susceptible populations.

2. DEVELOPMENT OF THE PREDICTIVE MODEL

2.5 The object of measurement study

In Taiwan, the most common residential patterns were categorized into townhouse (5F or less), apartment (5F or less), and mansion (6F above); furthermore, 70.9% of residences are under five floors. For this study, we selected a **three-story townhouse located in Tainan with a latitude of 22°99' north and longitude of 120°20' east** for real-time monitoring, as shown in Figure 1.

We carried out real-time monitoring from October 1, 2012 to September 30, 2013. Indoor temperature and humidity **sensors were installed in the study participants' main bedroom, where the occupants spent most of their time when inside the house.** The sensors were attached to furniture under the ceiling, approximately 1 m away from windows and heating devices and out of direct sunlight. The sensors were programmed to record measurements every hour and remained in the residence for 3 months.

2.6 Development of the indoor temperature predictive model

In order to create a predictive model between outdoor and indoor temperatures, we performed monitoring and simulations. The results were used to evaluate indoor health risk.

EnergyPlus, software that analyses buildings' energy performance, was used to simulate the daily average temperature throughout the year. Local weather data using the TMY3 format was used for the simulation; Table 1 shows the parameters of the indoor boundary conditions. The discharge coefficient of windows with screens was set as 0.4 for the calculation of natural ventilation, and the inner heat source of two occupants, lighting, and a television were applied to the main bedroom. Furthermore, the set-point of air-conditioning was set to **27°C between 19:00 and 24:00.**

We studied the correlations between the measurements and the simulation to verify the simulation. Figure 2 shows that the temperature coefficient of determination (R^2) is 0.97, indicating that the simulation model of this study has certain credibility.

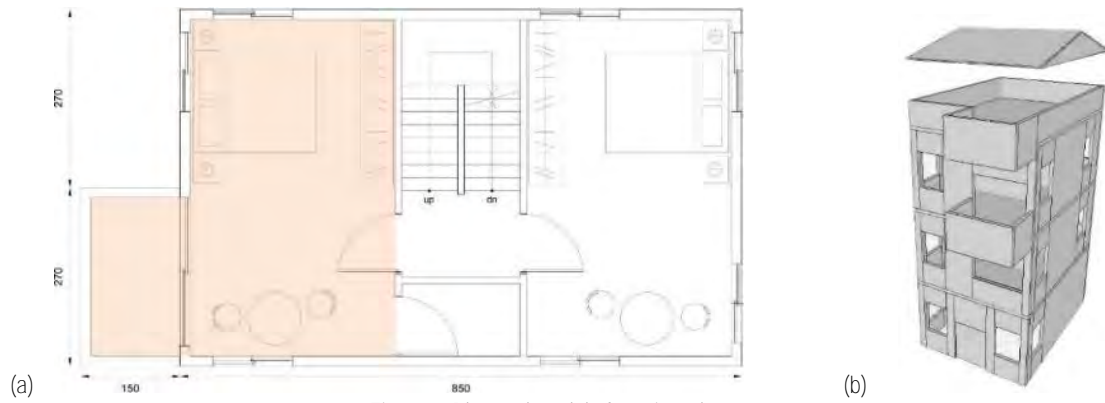

Figure 1: Plan and model of monitored room.

Occupancy	Lighting	Equipment
Number of people	(W/m ²)	(W)
2	1.39	40
20:00-06:00	20:00-23:00	20:00-23:00

Table 1: Indoor boundary conditions of simulation

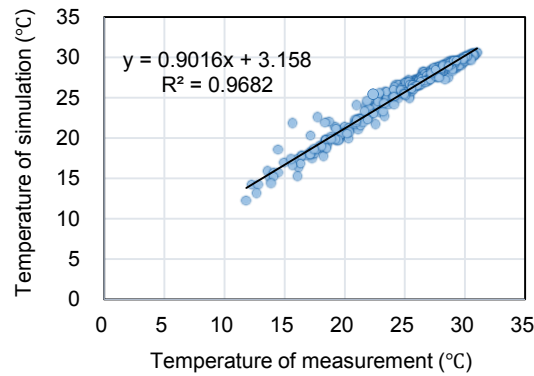

Figure 2: Correlation coefficient of simulation and measurement.

Area	Weather Data	Study Objects	Temperature Threshold	Reference
Hong Kong	1998-2009	Elderly	20.8 °C < AT < 28.2 °C	Xu et al. (2013)
Taipei	1994-2003	All ages	25.2 °C < AT < 31.5	Chung et al. (2009)
Taipei	2000-2009	All ages	<p>< 14°C Cerebrovascular diseases (RR=1.56; 95% CI: 1.23, 1.97) Hypertensive diseases (RR=1.78; 95% CI: 1.37, 2.34) Asthma (RR=2.93; 95% CI: 1.26, 6.79)</p> <p>> 32°C Chronic renal failure (RR=2.36; 95% CI: 1.33, 4.19)</p> <p>14°C < T < 32 °C</p>	Wang et al. (2014)
Taiwan	2000-2008	Elderly / Younger	<p>< 18°C younger than 65 years Respiratory diseases (RR=1.36; 95% CI: 1.31, 1.42) Asthma (RR=1.10; 95% CI: 1.03, 1.18) Chronic airway obstruction not elsewhere classified (RR=1.12; 95% CI: 1.02, 1.22)</p> <p>> 30°C elderly Respiratory diseases</p>	Wang et al. (2015)

			(RR=1.01; 95% CI: 1.00, 1.02) Chronic airway obstruction not elsewhere classified (RR=1.08; 95% CI: 1.03, 1.13)	
			18°C < T < 30°C	
Taiwan	1994-2009	All ages	20 °C < T < 28 °C	Lin et al. (2011)

Table 2: Temperature threshold in subtropical climate zones.

2 CASE STUDY AND EVALUATION

2.1 Definition of temperature extremes

Table 2 shows five recent reviews of subtropical climate zones that describe temperature's effect on people's health. Xu et al. (2013) compared apparent temperature (AT) to mortality outcome and found that an AT below 20.8°C was related to an increase in mortality risk of all causes of cardiovascular and respiratory disease for every 1°C decrease in AT over the following three days.

To assess the risk of emergency room visits for both cardiovascular diseases and respiratory diseases associated with ambient temperature, Wang et al. (2014) studied the related risk in Taipei and found that temperatures below 14°C and above 32°C were correlated with an increased rate of hospital emergency visits. Likewise, Wang et al. (2015) evaluated the association between environmental factors and health risks in Taiwan, determining that younger people had more outpatient visits for exposure to temperatures below 18°C and that seniors more vulnerable to temperatures above 30°C.





Since climate changes every year and the frequency of extreme events has gradually increased, a temperature index between 18°C, which is at approximately 5th-20th percentiles of the average temperature, and 30°C, which is at approximately 95th-97th percentiles of the average temperature in 2000-2008, was selected in this study to evaluate health risk with the recent weather data, as well as to discuss the health risks of the elderly in Taiwan.

2.2 Strategies to reduce health risk

To determine potential townhouse reforms and improve indoor thermal comfort during extreme weather events, the aforementioned building was used as a prototype of a common townhouse in Taiwan with a balcony on one side of the building's long side. The studied room was on the top floor and on the west side to simulate the warmest situation. The parameters were the same as the predictive model, except that the HVAC was not set in this case study so that we could evaluate the true properties of the improvement projects.

As shown in Table 3, the six improvement projects mentioned in the study can be categorized into insulation (case 1-3), external shading devices (case 4-5), and vertical greening on the balcony (case 6). In order to decrease thermal heat transfer, improving insulation material is one kind of method to reduce indoor air temperature differences. Two methods common in Taiwan for improving roof insulation were studied, including installation of a metal canopy on top of the roof or an insulated layer of polyurethane and foam concrete.

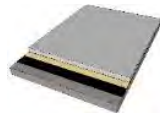
We performed analytical simulations of two types of opaque external shading devices that were installed outside all of the windows in a dynamic regime, including external horizontal shading and an aluminium horizontal louver. The width of the horizontal shading was 0.5 m and the louver's slats vertical spacing and slats width maintain a unitary value of 0.085 m.

Case 0	Case 1	Case 2	Case 3
15 cm RC + Ruberoid	Case 0 + Metal canopy	Case 0 + Insulation layer	Case 0 + Metal canopy + Insulation layer
			



Case 4	Case 5	Case 6
Horizontal shading	Aluminium louvers	Vertical greenery
		
Slats width 0.50 m Slats thickness 0.05 m Slats length 1.40 m	Slats width 0.085m Slats thickness 0.008m Distance between slats 0.085m Distance slats-glass 0.090m Louver inclination 90°	Discharge coefficient 0.48 Transmittance 0.144

Table 3: The studied cases.

In the EnergyPlus software, the vertical greenery system composite model was set up to simulate the activities of plants with two planes of shading and ventilation. We do not address the evapotranspiration effect in this study. Wild allamanda (*Urechites lutea*), a subtropical trailing plant, was used for the vertical greenery system located on the balcony. We conducted an experiment that included field measurements and properties experiment of plants. Transmittance was also measured to be used as a parameter in the simulation. With shading and ventilation effects in the simulation, the transmittance and discharge coefficient were set to 0.144 and 0.48, respectively.

2.3 Results and discussion

Figures 3 and 4 show the simulation results of temperatures lower than 18°C and above 30°C, respectively. We used the data of June 1–September 30 in the summer and November 1–February 28 in the winter to determine the **effect of a building's adjusting strategies for reducing the accumulated hours that exceed the threshold. Regarding extreme heat, the effect of decreasing solar heat gain from windows (cases 4-6) was found to be much better than changes to the roof's insulation (cases 1-3) by at least 1.13%. Furthermore, the effect of installing a metal canopy is better at reducing the roof's temperature than changing the roof's insulation material due to the shading effect.**

Compared to the horizontal external shading devices, an aluminium grille more effectively reduced the amount of solar heat gain from windows, indicating that a high temperature health risk can be reduced 0.31% more by an aluminium grille than by horizontal external shading devices. However, considering the lighting effect when the shading devices were used, an intensive aluminium grille may result in lighting problems. Therefore, with the effects of shading, evapotranspiration, and reduction of wind velocity, vertical greening on the balcony has the best results with regard to decreasing indoor air temperature by obstructing the majority of solar radiation at a low angle from the west, even if the accumulated risk hours in the summer are slightly worse than with the aluminium grille.

Furthermore, regarding extreme cold, our results demonstrated that installing a metal canopy (cases 1 & 3) can improve indoor temperatures in winter but also obstruct the solar heat gain (case 4-6), thus having the opposite effect.

The simulation results of vertical greening on the balcony are contradictory because they are the best in summer but worse in winter. The variability of the vertical greenery system, from which the plots can be removed in the winter, compared to the fixed external shading devices, is the project with the most potential to improve thermal comfort. Furthermore, therophyte, which has a life cycle of growing in the summer and withering in the winter, can be planted on the vertical greenery system to obstruct solar radiation in the summer and increase solar radiation transmittance in the winter.

3 CONCLUSIONS

In this study, we discussed the building's adaptability of thermal health risks in extreme weather events and proposed six strategies. According to the improvement projects' results, the fixed external shading device is not recommended to improve indoor thermal comfort in the winter. In contrast, installing a vertical greenery system on

the balcony, which can be removed in the winter, or planting some kind of therophyte is a better way to improve thermal comfort and reduce the health risk to susceptible populations.

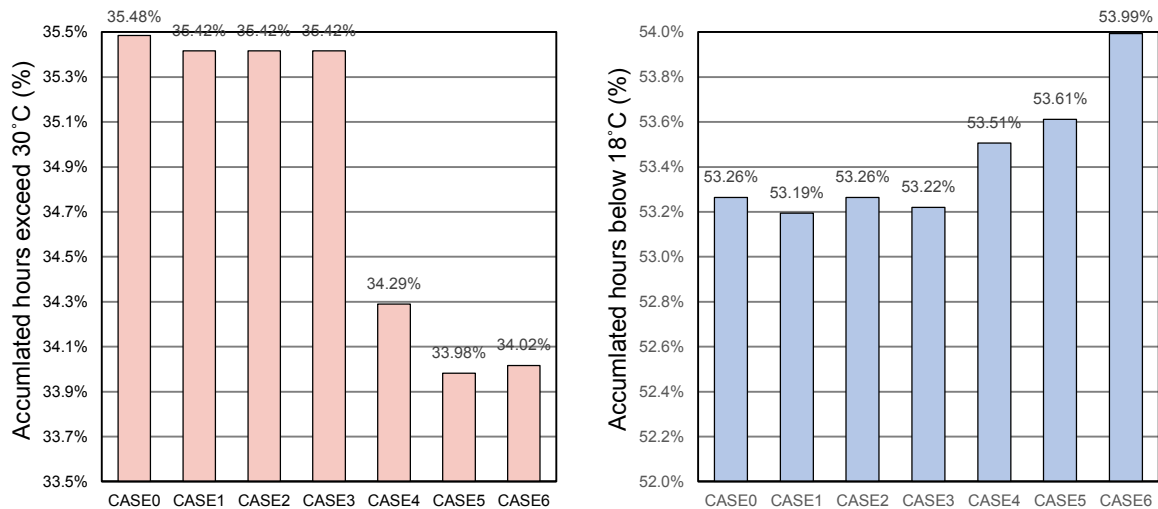

Figure 3: The simulation results of accumulated hours that are above 30°C and below 18°C

However, this study has some limitations. The attributable burden of risk to high and low indoor temperatures could not be quantified in this study due to the threshold of indoor air temperatures and the relative health risks not having been defined in Taiwan. Therefore, more research should be done to examine the relationships between various indoor temperatures and outpatient visits for temperature-related cardiovascular diseases and respiratory diseases.

REFERENCES

- [1] Bunker A., Wildenhain J., Vanddenbergh A., Henschke N., Rocklov J., Hajat S. and Sauerborn R. 2016. Effect of air temperature on climate-sensitive mortality and morbidity outcomes in the elderly: a systematic review and meta-analysis of epidemiological evidence. *EBioMedicine*, 6, 258-268.
- [2] Chung J.Y., Honda Y., Hong Y.C., Pan X.C., Guo Y.L. and Kim H. 2009. Ambient temperature and mortality: An international study in four capital cities of East Asia. *Science of the Total Environment*, 408, 390-396.
- [3] Kitamura E., Shibata Y. and Matsubara N. 2016. A study on the prevention of heat shock from the viewpoint of residents. *Japanese Journal of Biometeorology*, 53(1), 13-29.
- [4] Lin Y.K., Ho T.J. and Wang Y.C. 2011. Mortality risk associated with temperature and prolonged temperature extremes in elderly populations in Taiwan. *Environmental Research*, 111, 1156-1163.
- [5] Quinn A., Tamerius J.D., Perzanowski M., Jacobson J.S., Goldstein I., Acosta L. and Shaman J. 2014. Predicting indoor heat exposure risk during extreme heat events. *Science of the Total Environment*, 490, 686-693.
- [6] Stazi F., Marinelli S., Perna C.D. and Munafo P. 2014. Comparison on solar shadings: Monitoring of the thermos-physical behavior, assessment of the energy saving, thermal comfort, natural lighting and environmental impact. *Solar Energy*, 105, 512-528.
- [7] Sunakorn P., Yimprayoon C. 2011. Thermal performance of biofacade with natural ventilation in the tropical climate. *Procedia Engineering*, 21, 34-41.
- [8] Wang Y.C. and Lin Y.K. 2014. Association between temperature and emergency room visit for cardiorespiratory diseases, metabolic syndrome-related diseases, and accidents in metropolitan Taipei. *Public Library of Science*, 9 (Issue 6).
- [9] Wang Y.C. and Lin Y.K. 2015. Temperature effects on outpatient visits of respiratory diseases, asthma, and chronic airway obstruction in Taiwan. *International Journal of Biometeorology*, 59, 815-825.
- [10] Xu W., Thach T.Q., Chau Y.K., Lai H.K., Lam T.H., Chan W.M., Lee R.S.Y., Hedley A.J. and Wong C.M. 2013. Thermal stress associated mortality risk and effect modification by sex and obesity in an elderly cohort of Chinese in Hong Kong. *Environmental Pollution*, 178, 288-293.

Improvement Strategy of Urban Street Thermal Environment

WANG Wen-an^a

^a Tamkang University, Taiwan, rumm0924@yahoo.com.tw

ABSTRACT

Owing to the increase in building structures and road system, lack of sufficient green area in urban environment, imperviousness of ground surface and large amount of waste heat, a large heat retainer has been fabricated, which has resulted in the heat island effect. This research mainly focuses on the geographic feature of the urban buildings groups in its investigation of the outdoor thermal environment. This research used factors such as improving the reflectivity of the building materials, increasing the permeable rate of the paving material and planting arbours as shade trees as the design variables. Moreover, the research has employed the Computational Fluid Dynamics as the prediction and analysis tool to analyze the feasibility and efficiency in order to improve cooling through the design variables in the urban street canyons where there is only limited room for improvement. This research then proposes the guidelines which help in reducing the heat island effect based on the analysis results. Partly from the research results, the wind speed can improve the cooling effect of the variables. Compared with the preset reference temperature, it was observed that 5% discomfort zone can be improved through improving the reflectivity of the building materials, 13% through improving the permeable rate of the paving material and 40% through the shade from arbours, which is the maximum.

Keywords: micro-climate, temperature lowering, computational fluid dynamics

1. INTRODUCTION

Aggravating global warming problems have intensified extreme weathers, engendering an increase in the number and severity of natural disasters. The rapid growth in urban population also exerts a substantial impact on the environment, in which urban heat island effect is a primary factor influencing global warming. Excessive population density inevitably causes a considerable rise in the demand for living spaces, which leads to increased land use density, frequent construction of buildings and road systems, insufficient green land in urban areas, generation of impervious ground surfaces, and intense anthropogenic heat dissipation. Ultimately, these reactions form a massive heat-storing entity, thus creating a thermally uncomfortable street environment. Thermal environment in urban areas directly influence the quality of living and comfort level for humans. Therefore, improving the heat island effect in urban areas is a topic meriting immediate attention.

1.1 Research objectives and methods

Vegetation, green lands, and permeable pavements effectively absorb heat because of their large heat capacity. Furthermore, the evapotranspiration functions of these elements exert a cooling effect that facilitates regulating microclimates and stabilizing weather conditions (Sun et al., 2010; Lin et al., 2001). The present study was conducted to investigate the geographical characteristics of an outdoor thermal environment—building clusters in urban areas. By improving factors such as the reflectivity of outer walls of a building, permeability of ground pavements, and shades under plants and trees and using these factors as design variables, we analysed the effects of these design variables on cooling environment of urban spaces. Subsequently, computational fluid dynamics (CFD) was employed as a simulation tool to analyse the feasibility of using the design variables to reduce temperature for improving such limited space as urban street canyon. Finally, the analysis results were used as the basis for proposing plans to mitigate the heat island effect in urban environments.

1.2 Research scope

The research site of this study is a community in Neihu District in Taipei City. Prior to its renewal, the community was a five-storey apartment building. Following an urban renewal plan implemented by the government, the building was reconstructed into a dual 23-storey high-rise building. Because the building volume before and after reconstruction differed considerably (Figure 1), this study examined the effect of reconstruction on the thermal comfort in peripheral spaces.

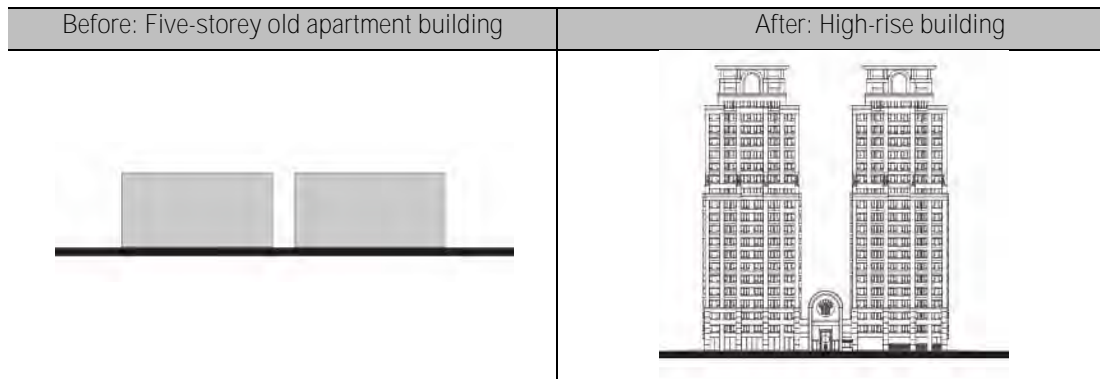

Figure1: schematic diagram of research site

1.3 Data establishment and simulation setting

1.3.1. On-site measurements

Measurements were taken in pedestrian environments and areas around buildings (Figure 2) to collect information on wind speed, wind direction, temperature, humidity, and precipitation. Same numerical values were collected from different measuring points in areas around the buildings. The collected data were employed as the basis for verifying numerical simulations. The relationships among the collected data were evaluated to examine the effects of different pavement materials and plant types on the physical environment of a street.



Figure 2: Experimental measurement equipment configuration and meteorological station

1.3.2. Boundary condition setting

Taipei City is located near the 25th parallel north. Because it is on an island located between the East Asian continent and the Pacific Ocean, where the island is subjected to influence by the cold, dry Pacific high pressure and warm moist Mongolia interaction, Taipei City experiences subtropical monsoon climate, which is exposed to the effects of south-westerly airstream in summer. Therefore, we selected the summer season for our simulation, and configured the boundary conditions according to the highest insolation amount at noon. Table 1 presents the boundary parameters used in the simulation.

Summer Meteorological Parameters		
	Onsite Measurement	Bureau-Monitored Data
Temperature (°C)	35	27
Wind speed (m/s)	1.5	2.2
Humidity (%)	47	77.3
Direct insolation intensity/(W/m ²)	-	617
Diffused insolation intensity/(W/m ²)	-	175

Table 1: Meteorological parameters

1.3.3. Simulation of the current status of the research base

Urban heat island effect is strongly influenced by local climate factors, particularly temperature, cloud cover, and wind speed. The scope of this study comprised Tainan County and City, which are located in a subtropical zone where monsoons are prevalent. Therefore, Tainan is situated in monsoon climate zone. The meteorological factors closely related to urban heat island effect are described below.

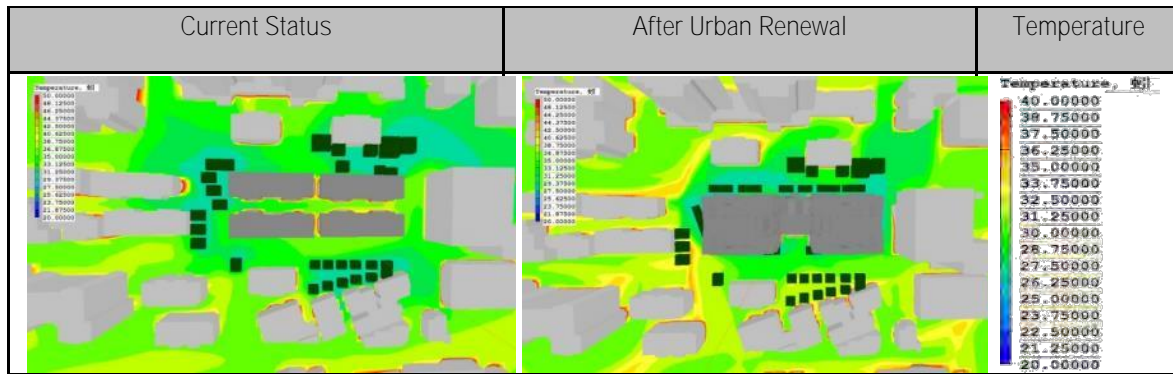

Figure 3: Simulation analysis of the current situation and improve

	<30°C	31–33°C	33–35°C	>36°C
Current Status	411.63 m ²	536.7 m ²	804.07 m ²	108.62 m ²
After Renewal	914.17 m ²	457.25 m ²	411.06 m ²	78.52 m ²
Difference	-502.54 m ²	79.45 m ²	393.01 m ²	30.1 m ²
Ratio (increase)	27%	-	-	-
Ratio (secrease)	-	4.26%	21.11%	1.61%

Table 2: After the temperature distribution area and to improve the current situation

According to the simulation results, we analysed the effect of urban renewal (reconstructing a 5-storey building into a high-rise building) on the thermal environment of the surrounding area to investigate differences before and after improvements. Table 3 presents the simulation results of temperature distribution and area, which shows the effects of building volume after urban renewal on the surrounding environments. In particular, when measurements were taken at 1.5 m above the ground, **areas measuring $\geq 36.0^{\circ}\text{C}$ were reduced** by 1.61%; areas measuring $33.0\text{--}35.0^{\circ}\text{C}$ were reduced by 21.11% compared with the current condition; and areas measuring $31.0\text{--}33.0^{\circ}\text{C}$ were reduced by 4.26%. **By contrast, areas measuring $\leq 30.0^{\circ}\text{C}$ increased** by 27%. The simulation results revealed that the thermal comfort in relation to building volume after urban renewal improved. Although the areas measuring $33.0\text{--}35.0^{\circ}\text{C}$ were reduced compared with the current condition.

2. NUMERICAL SIMULATION ANALYSIS

2.1 Formulation of improvement plans

In this study, simulation configuration involved three types of improvement plans (Figure 4). Plan 1 entails increasing the reflectivity of building material; Plan 2 involves improving the permeability of pavements; and Plan 3 was to increase the number of plants and trees. Subsequently, we examined the effectiveness of these three simulation plans on the heat island effect in the outdoor areas of the community building during summer. Tables 3 and 4 present the parameter settings.

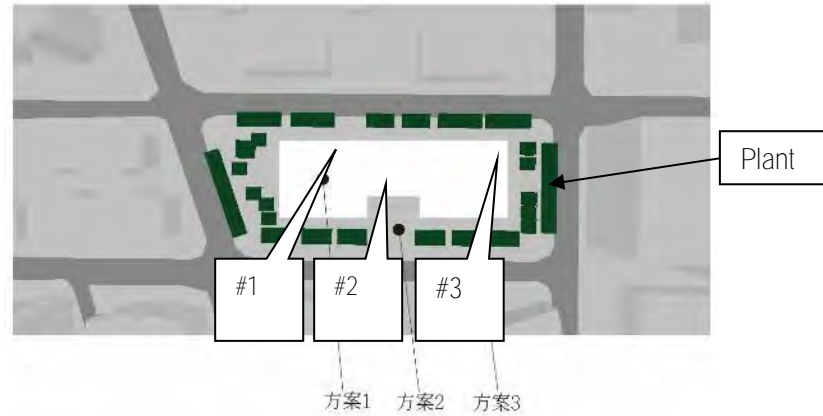

Figure 4: Simulation set up

Model No.	heat flux (W/m ²)	Long-Wave Emissivity	Reflectivity	Thermal Conductivity Coefficient (W · m ⁻² K ⁻¹)	Density (kg · m ⁻³)	Specific Heat (kJ · m ⁻³ K ⁻¹)
#1	-	0.95	0.9	0.5	2000	1600
#2	-40	0.95	-	0.5	2000	1600

Table 3: Parameter setting for building surface material

Model No.	Size	Height from Ground	Reflectivity	Porosity	Estimated Initial Temperature
#3	5x5x3m	2m	0.15	0.7	24 °C

Table 4: Parameter setting for plants and trees

2.2 Simulation analysis of outer building wall variable

In this simulation, we improved the reflectivity of the building material and pavement material to examine the difference in their effect before and after urban renewal. To configure the model, this analytical module was used as the setting for material reflectivity; therefore, the reflectivity coefficient was adjusted whereas the boundary condition settings remained unchanged. According to the simulation result of temperature distribution shown in Table 5, when measurements were taken 1.5 m above the ground, **areas measuring $\geq 36.0^{\circ}\text{C}$ increased by 0.41%; areas measuring $33.0\text{--}35.0^{\circ}\text{C}$ increased by 3.43% compared with the current condition; and areas measuring $31.0\text{--}33.0^{\circ}\text{C}$ increased by 23.28% compared with the current condition. By contrast, areas measuring $\leq 30.0^{\circ}\text{C}$ were reduced by 6.46%. Moreover, regions where wind speed is low or leeward exhibited a rise in average temperature, whereas regions with wind speed of 1.5–2.5 m/s exhibited a reduced average temperature by approximately 1.0–2.0°C. Therefore, increasing material reflectivity is ineffective in areas with low wind speed, whereas such increase can effectively cool the temperature of regions with high wind speed.**

	<30°C	31–33°C	33–35°C	>36°C
After Renewal	914.17 m ²	457.25 m ²	411.06 m ²	78.52 m ²
Increased Reflectivity	793.83 m ²	633.64 m ²	347.21 m ²	86.32 m ²
Difference	120.34 m ²	-176.39 m ²	63.85 m ²	-7.8 m ²
Ratio (increase)	-	9.47%	-	0.41%
Ratio (decrease)	6.46%	-	3.43%	-

Table 5: Parameter setting for plants and trees

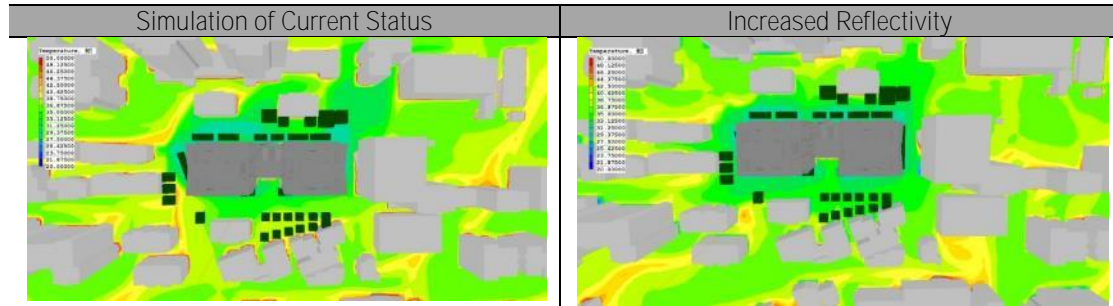

Figure 5: Simulation set up

2.3 Simulation analysis of permeable pavement variable

According to Table 6, which shows the temperature distribution results of a pavement material with improved permeability, **areas measuring $\geq 36.0^{\circ}\text{C}$ were reduced by 1.04% compared with the condition before improvement; areas measuring $33.0\text{--}35.0^{\circ}\text{C}$ were also reduced by 4.13%; areas measuring $31.0\text{--}33.0^{\circ}\text{C}$ increased by 3.96; and areas measuring $\leq 30.0^{\circ}\text{C}$ increased by 1.72%. Increased ratios and decreased ratios were summed to calculate the overall cooling effect, and we determined that approximately 10.85% of the base area exhibited improved temperature-cooling effect. The average temperature in the region decreased by roughly $1.0\text{--}2.0^{\circ}\text{C}$. Figure 11 illustrates the pavement permeability simulation result, which indicates that the optimal cooling effect was observed in areas measuring $33.0\text{--}35.0^{\circ}\text{C}$ after the permeability of pedestrian pavement in the research base was improved, and these areas registered wind speed of $1.5\text{--}2.5\text{ m/s}$. By comparison, areas measuring $\leq 30.0^{\circ}\text{C}$ demonstrated poor cooling effect compared with the current status because these areas are either leeward or lack concave-shaped building layouts to shield the area, causing poor cooling effect.**

	$<30^{\circ}\text{C}$	$31\text{--}33^{\circ}\text{C}$	$33\text{--}35^{\circ}\text{C}$	$>36^{\circ}\text{C}$
After Renewal	914.17 m ²	457.25 m ²	411.06 m ²	78.52 m ²
Improved Pavement Permeability	946.2 m ²	531.08 m ²	334.12 m ²	59.11 m ²
Difference	-32.03 m ²	-73.83 m ²	76.94 m ²	19.41 m ²
Ratio (increase)	1.72%	3.96%	-	-
Ratio (decrease)	-	-	4.13%	1.04%

Table 6: Effect of pavement permeability variable on temperature distribution and area

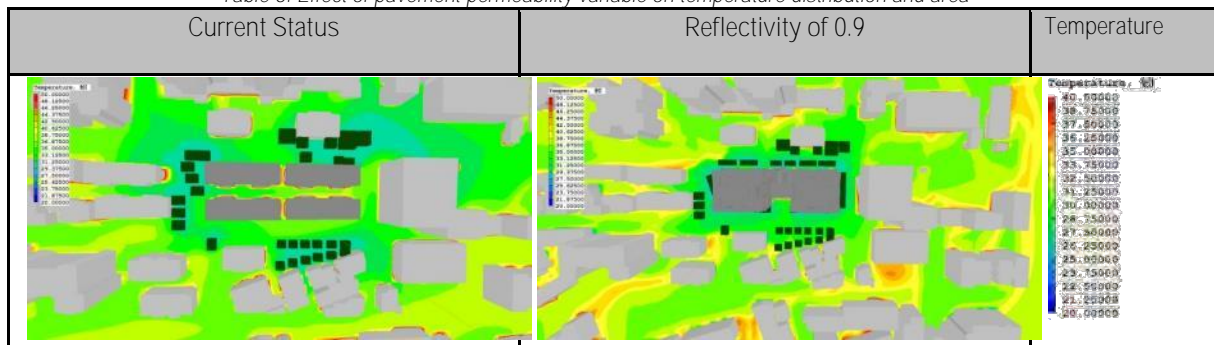

Figure 6: Simulation set up

2.4 Simulation analysis of plant variable

Wind field is a factor influencing environmental conditions. In addition to the cooling effects of plants, the influence of air flow on plant shading effect was also analysed. The simulation results shown in Table 7 indicate that when plant shading is used and wind speed is ranged at $0.5\text{--}1.5\text{ m/s}$, **areas measuring $\leq 30.0^{\circ}\text{C}$ increased by 10.48%** compared with the area distribution ratio of the current condition; areas measuring $31.0\text{--}33.0^{\circ}\text{C}$ also increased by 7.23%; and areas measuring $33.0\text{--}35.0^{\circ}\text{C}$ were reduced by 10.51% compared with the current condition in the same wind speed field; **and areas measuring $\geq 36.0^{\circ}\text{C}$ were also reduced by 2.36%. Increased ratios were used to calculate the overall cooling effect,** and we determined that approximately 30.58% of the base area exhibited improved temperature-cooling effect. Therefore, compared with the aforementioned factors of permeability and reflectivity, planting presented better temperature-cooling effect.

	<30°C	31–33°C	33–35°C	>36°C
After Renewal	914.17 m ²	457.25 m ²	411.06 m ²	78.52 m ²
Increased plants	1109.22 m ²	591.84 m ²	215.34 m ²	34.6 m ²
Difference	-195.05 m ²	-134.59 m ²	195.72 m ²	43.92 m ²
Ratio (increase)	10.48%	7.23%	-	-
Ratio (decrease)	-	-	10.51%	2.36%

Table 7: Effect of plant variable on temperature distribution and area

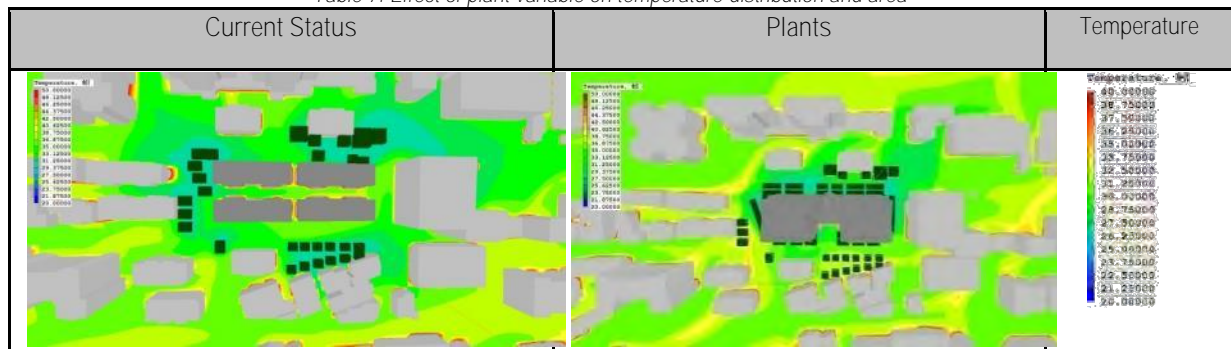

Figure 7: Simulation set up

3. CONCLUSION

This study obtained the following findings:

According to the experimental result, regions with wind speed of 1.5–2.5 m/s can reduce temperature by 0.5–1.0°C, whereas regions with wind speed of 0.5–1.5 m/s can reduce temperature by only 0.1–0.3°C. The temperature did not decrease substantially when wind speed is low or in regions with insufficient wind speed. In addition, regions where wind speed approximates 0 m/s exhibited slight increase in temperature.

According to the analysis result based on improved pavement permeability, the overall cooling effect manifested by the sum of increased ratios and decreased ratios showed that approximately 55.79% of the base area exhibited improved temperature-cooling effect. When the wind speed ranged between 1.5 and 2.5 m/s, optimal cooling effect of approximately 1.0–2.0°C on average was observed.

The overall cooling effect according to increased ratios showed that approximately 67.82% of the base area exhibited improved temperature-cooling effect. The optimal cooling effect of 3.0–4.0°C was observed; therefore, regions with a strong flow field such as shades under a tree exhibited optimal cooling effect. When air flow is insufficient, the shade still provided a cooling effect of 0.5–1.0°C. Therefore, compared with the aforementioned factors of permeability and reflectivity, planting presented better temperature-cooling effect.

REFERENCES

- [1] Wu, T.T., 2007, A Study of the numerical simulation on urban microclimate-The influence of vegetation in the open space of condominiums, Thesis (PhM), National Cheng Kung University.
- [2] Sun, C.Y., 2006, Annual Variation of Urban Heat Island Intensity in the Tainan Region, City and Planning, 33 (1), 51-68.
- [3] Sun, C.Y., Lin, H.T., Lu, K.M., Liu, C.C., Cheng, R.L., 2010, Relationship between Surface Temperature and Land-cover in Tainan City, City and Planning, 37 (3), 369-391.
- [4] Chiu, Y.H., Wang, C.C., Chiang, C.C., 2014, Simulation of the Influences of Planting and Pervious Pavement on the Street Surface Temperature, Journal of Architecture, 88, 61-78.
- [5] Lin, Y.P., 2001, The Influence of Porous Screens on Natural Ventilation in a Dwelling Unit, Thesis (PhM), National Cheng Kung University.
- [6] Asaeda, T., Ca, V. T., 2000, Characteristics of permeable pavement during hot summer weather and impact on the thermal environment, Building and Environment, Vol. 35, pp. 363-375.

- [7] Pomerantz, M., Akbari, H., Chang, S.C., Levinson, R., and Pon, B., 2002, Examples of Cooler Reflective Streets for Urban Heat-Island Mitigation: Portland Cement Concrete and Chip Seals, Lawrence Berkeley National Laboratory, Publication No. LBNL-49283.
- [8] 林波榮, 朱穎心, 李曉峰, 2002, 太陽輻射下建築外微氣候的實驗研究-建築外表面溫度分布及氣流特徵, 太陽能學報, 22(3), 327-332.

A Preliminary Exploration on the Climate Adaptive Design of Green Rural Houses in the South Shaanxi Province

CAI Wei^a, HAN Yue^b, LIU Yi^c, ZHOU Haoran^d, WANG Runsheng^e

^a Northwestern Polytechnical University, Mainland China, geeking.cai@gmail.com

^b Northwestern Polytechnical University, Mainland China, yuffiehan@sina.com

^c Northwestern Polytechnical University, Mainland China, solarlily@7gmail.com

^d Northwestern Polytechnical University, Mainland China, 1611937015@qq.com

^e Northwestern Polytechnical University, Mainland China, 1216693714@qq.com

ABSTRACT

This paper explored on the climate adaptive design of green rural houses in the south Shaanxi province through literature review, field investigation, analysis and summarization methods. Pattern language of architecture design which reflect climate adaptive features and regional architectural characteristics in existing local traditional rural houses were extracted and summarized. Influencing factors were analyzed, relevant design strategies and their tentative application in the researched region are proposed. Results of this work is expected to provide references for the green rural houses design in south Shaanxi province and other regions with similar climate features.

Keywords: green rural house, climate adaptive design, China

1 BACKGROUND

Observing that traditional rural houses mostly adapted very well to their regional natural environment and possess distinguished climate adaptive features, it is considered worthwhile to conduct exploration and studies on traditional rural houses in different regions. Base on this understanding, a preliminary exploration has been conducted targeting climate adaptive design of green rural houses and their contemporary application in the south Shaanxi province of China, which locates at the southern foot of Qinling mountain area.

2 CLIMATE ADAPTIVE LANGUAGE IN THE TRADITIONAL RURAL HOUSES

Taking traditional rural houses in Qiangning County Hanzhong City as the object of research and through practical observation and interview in Caochangba village and Jinjiaping village, with the analysis of a great number of documents, this paper conclude some architecture vocabulary which could reveal the climate adaptability and regional features of local traditional rural houses.

2.1 Plan and envelope system

Generally speaking, the traditional rural houses contain merely one floor with large height. Its planar formats are **mainly linear or look like capital "L"**. **The main part of these houses include 3 or 4 bays, the width of each bays is** about 4 to 6 meters and the depth is about 4 meters. The outer fence structure is 300-500mm rammed earth wall that possess excellent thermal storage ability and obvious heat preservation effect. As the rainfall is pretty large, the base is formed by stones and rocks, the middle part of the walls are rammed earth structure and the top of walls are applied Chuandou system with wooden structure. (Figure 1) In order to decrease heat loss in winter, the traditional windows in Ningqiang region are very small with 1, 5-meter width and 1.2-meter height. (Figure 2) The sills of the house are normally 1 to 1.2 meters high. The door of the house is generally 1.4 meters width and 2.3meters high and its threshold is about 0.2 meter. The window frame and doors are all made of wood.

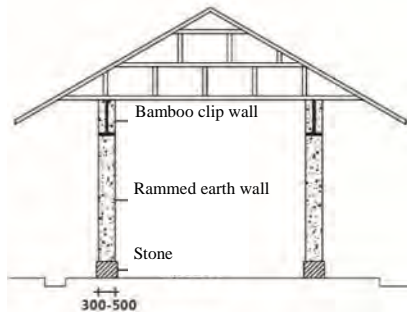

Figure 1: Wall structure

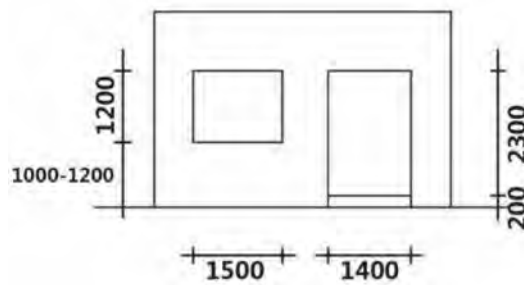

Figure 2: Window and door

2.2 Functional layout

The local traditional rural houses consist of yard, main architecture and attached rooms. The yard can be divided into five types, including backyard, front court, front yard, combined yard and courtyard. (Figure 3) Yard is mainly for sun drying, family activities and neighbor exchange. The main architecture is evolved from “one bright and two dark” building. The hall is at the center part of the entire house, located at north and facing south. The entire house is situated at the principal part of the symmetric axes of the building, which could link all rooms and is the center of family daily activities and guests’ exchanges. The center of the space is hall, then the bedrooms are at left, right and back of the hall. Compared with hall, the space of bedrooms is smaller and connected with hall. Attached rooms contain kitchen, toilet, storage room and many other rooms which are for breeding and crop cultivating.

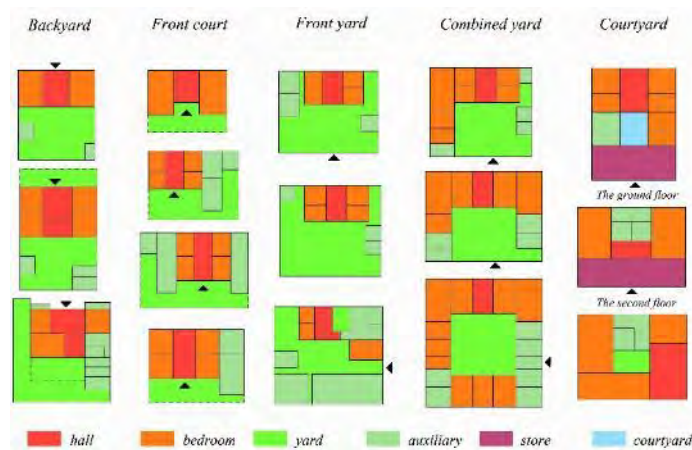

Figure3: Space layout

2.3 Eave

The summer in this region is sultry and eaves of houses spread a long distant from roof (nearly 2.5 meters), which could not only could shelter from sunshine and rain but also is a daily living place for chatting and dining. This eave is named cornice and it possesses a variety of types. (Figure 4) The forms and functions of the space beneath cornice vary. It could be an attic, Meirenkao for rest and observation or a platform for sun-drying or storage. (Figure 5)

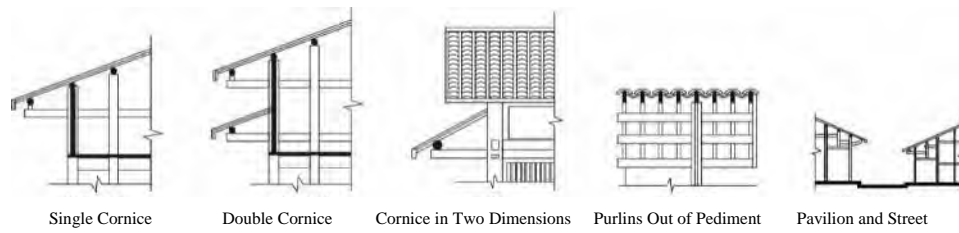

Figure 4: Types of cornice



Figure 5: Space forms beneath cornice

2.4 Attic

Attic is a general type of architecture in traditional rural houses where we investigated. As the room for storage, it mainly connect beneath space with a ladder or fix stair. In addition, attic is also an air layer which could buffer thermal exchange between inside and outside air. With the opening on the top, the attic could keep warm in winter and reduce the temperature and humidity in summer. (Figure 6)



Figure 6: Attic



Figure 7: Opening

The opening on the top of attic are with different forms, such as “Swallow Grotto” and “the Cat Drilling”. “Swallow Grotto” is the opening on the wall and “the Cat Drilling” refers to a small opening on roof which is piled with tiles and the shape could merely pass a cat. (Figure 7)

2.5 Entrance hall

A The entrance hall is also call “the room without walls” and refers to two big halls that connect with each other. Seeing from the Figure, the hall could nearly link up all rooms. It is comparatively small and without opening roof. In order to adapt to hot and sultry summer, the local entrance halls could be applied to ventilate rooms. (Figure 8)

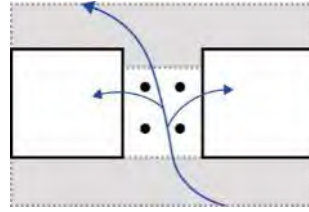

Figure 8: Entrance hall

2.6 Courtyard

The courtyard refers to an open narrow space which is surrounded by buildings. However, it is not very common in local region. Merely the old houses with three halls and five halls still contain courtyard. Generally, it is located at central part with two wings on the sides. Its width is the same as main room and its depth is equivalent to wings. The courtyard could change buildings with too big depth and could provide more sunshine demand and enhance ventilation function and heat dispersion and supply sharing space. (Figure 9)

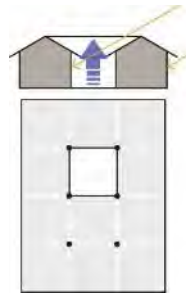

Figure 9: Courtyard

2.7 Huotang

Huotang is also called “Huokeng” 、 “Huopu” , which consist of Huotang scaffold 、 fire stove 、 base and wooden fence .Generally speaking, it is used for cooking, heating, lighting and sleeping on. At the same time, it also involved in many activities, including personal exchange, party, discussion and sacrificial activities. The investigation discovered that the majority of families are using Huotang and they even replace it with movable fire brazier. It possesses various forms and its location is flexible. Normally, it is located at lee of main hall, one side of living room or kitchen, even under eaves. It is applied to smoked meat, boiling, drying and cooking and in winter, it is an important heating producer.

3 THE FORMATION FEATURES OF MODERN NEW RURAL HOUSE



Figure 10: Modern rural houses plan

The traditional rural houses possess excellent climate adaptability but there are few traditional rural houses at local area. The majority houses are commonly modern buildings. According to investigation, the new rural houses are normally brick-and-concrete composite building with one or two floors and planar or oblique roofs. One floor is about 3 to 3.3 meters and the second floor could reach 2.8 to 3 meters with width 3 to 4. The width of main rooms is about 3.3 to 3.6 meters and its depth is about 4.5 to 5 meters. Its space structure is similar with traditional rural houses. The hall is located at the principal part of symmetric axes and connect with all rooms. Although the modern rural houses are improved in the aspects of layout and humidity reduction, it is hot in summer and cold in winter with less sunshine and storage space. The Figure 3.1 above includes two plans of local rural houses. (Figure 10)

4 THE INTRODUCTION OF MODERN GREEN DESIGN STRATEGIES AND TECHNOLOGIES

Based on the extraction of local traditional architecture vocabularies, this paper analyzed that, according to local climate conditions, economic level and so on, the construction of sun room and rain collection these two types of modern green design strategies and technologies could be taken into consideration.

4.1 Attached sun room

Attached sun room is a kind of passive solar building, which consist of sun room, main room and warm protection walls. Compared with other methods, the attached sun room added heat-absorbing devices and it not only is a buffer between outside and inside but also reduced cold air infiltration and heat loss and extremely enhanced the comfort of rooms beside the sun room. Therefore, designer could directly install a glass space on the main rooms toward south or corridor and the glass space is sun room. (Figure 11)

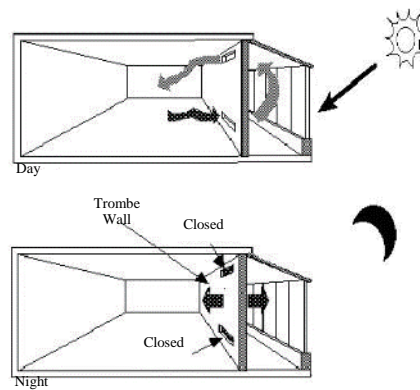

Figure 11: Working principle of attached sun room

4.2 Rain collection

Considering local realistic situation, the low technological rain collection system could be applied to this region, which include eave gutter, rain tank, rain pipe, filtering layer and water tank and without equipment devices, the cost of this system is low and its installation is convenient. There is a gutter above eaves. Through inside drainage system, the collected rain will be gathered to eave gutter, then rain funnel and rain pipe will conduct rain and water to the water tank on the second layer. There is a filtering layer inside water tank, which is formed by stone layer and sand layer. After filtration, a part of water will be transferred to storage tank on the ground. And the rest water can be used to flush toilet. (Figure 12)

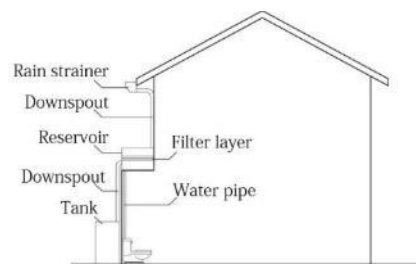

Figure 12: Rain collection system

5 REFERENCE PROJECT

Combined with background above, we could conduct the entire plan of green rural houses. The project covers 196.18 square meters and include three bedrooms and two halls, total two floors. The plane layout will be applied to modern rural houses. The living room is located at axis, connected with all rooms. Besides garage, the roofs are sloping and the eave nearly spread out 900 to 1800 mm, which could not only shelter summer sunshine but also can prevent the erosion of rain water, and the abundant space beneath the eave is also a type of benefit . The design could increase the space of storage room, garage and sunshine platform and garage could also be applied for storage. The rooms toward south and bedrooms will be attached with sun rooms and rain collection systems. The second floor will be installed a ladder toward attic. (Figure 13 to 15)

6 CONCLUSION

Based on bibliography and investigation on site, the climate adaptive language of traditional rural houses in Shanxi province has been extracted. The paper concluded the formation features of modern new rural houses. Combined with modern green design strategies and technologies, the paper proposed design advice and reference project of climate adaptive green rural houses in Shanxi province. As the limitation of time and ability, the paper has not fully discussed many contents about other perspectives and hope that the relevant results could be enhanced and perfected in the future research.

REFERENCES

- [1] Wu Xinlan. The strategy and evaluation research of green rural house climate adaptability in southern Shanxi province. Northwestern Polytechnical University. 2016.03
- [2] Yin Shuangxi. Study on Thermal Load Characteristics on Passive Solar House with Attached Sunspace [M].Xian University of Architecture and Technology.2011.12
- [3] Zhang Gejuan. Research on Cultural Inheritance of New Rural Construction in Southern Shanxi Province Xian University of Architecture and Technology.2011.06
- [4] Zheng Jingyun; Yin Yunhe; Li Bingyuan. A New Scheme for Climate Regionalization in China [j]. ACTA GEOGRAPHICA SINICA. 2010.06.65(1)

APPENDIX



Figure 13: First floor plan



Figure 14: Second floor plan



Figure 15: Section

Socio-Environmental Framework for Integration of Lightweight Tensile Structure Windcatchers in Contemporary Hot-arid Urban Context of Tehran

Homeira MIRHOSSEINI^a, Shane Ida SMITH^b

^a University of Arizona, United States of America, mirhosseinihomi@email.arizona.edu

^b University of Arizona, United States of America, shaneida@u.arizona.edu

ABSTRACT

A design framework for integrating windcatcher functions within the contemporary hot-arid urban Iranian context of Tehran responds to two major changes impacting their current utilization: 1) urban densification resulting in modified access to adequate airflows, and 2) sociocultural shifts towards dependencies on modern mechanical air-conditioning systems. Windcatchers are ubiquitous and integral to buildings throughout the hot-arid regions in the Middle East, and traditionally provide human comfort cooling functions through combinations of thermal mass, stack effect, and evaporation techniques. In historic context, the windcatcher is effective for passively moderating indoor temperatures by means of these natural ventilation cooling strategies. However, this passive technology is rarely used in recent decades due to emerging disadvantages such as maintenance difficulties, lack of urban air filtration methods, decline of cooling efficiency due to modified airflow patterns, habitable space utilization modifications, and the resulting dependencies on mechanical cooling systems.

Modular lightweight tensile structures are identified as a potential method for integrating windcatcher functions to reduce energy use and engage regional textile industry. The beneficial aspects of this design strategy emphasize adaptability through inhabitant control for localized modulation to airflow through potential integration in existing multi-story apartment buildings. In addition, the framework suggests advancements for environmental performance of lightweight textiles, such as particulate matter filtration, kinetic energy transformation, and photo-response for passive shading or natural daylighting strategies.

The specific objective presented in this study is to define the parameters required for improving natural ventilation cooling and inhabitant adaptability. Existing windcatcher dimensions, microclimate conditions, and urban morphology are identified to inform the Sangelaj neighborhood in Tehran to develop the heat transfer and airflow analysis theory alongside human interface metrics that will inform lightweight tensile structure designs. The comprehensive research project situates intersecting transformations between evolving urban fabric and sociocultural agency with environmental performance and local material industry.

Keywords: windcatcher, adaptable design, climate responsive architecture

1. INTRODUCTION

Windcatchers are utilized for natural ventilation of living spaces in buildings to provide passive cooling and achieve thermal comfort for many centuries and can be found in traditional Persian-influenced architecture throughout the Middle East in both hot-arid and hot-humid regions (Saadatian et al., 2012), (Elmualim, 2009), (Pearlmutter et al., 2008), (Hughes et al., 2012). Windcatchers play an effective role in moderating residential space temperatures for humans by means of natural ventilation (Mahmoudi, 2010), (Bahadori Nezhad and Dehghani, 2008). The windcatcher provides natural ventilation by taking advantage of stack effect, air buoyancy, thermal mass, cross ventilation, and evaporation techniques (Elmualim, 2009). While windcatchers are a passive cooling strategy that could widely benefit humans, they are rarely utilized in recent decades because of emerging drawbacks such as:

- High installation and maintenance costs (Hughes et al., 2012);
- Minimal ability to control of the volumetric flow rate to maintain a comfortable indoor climate (Hughes et al., 2012);
- Draughts through the tower may cause discomfort to occupants during the winter (Hughes et al., 2012);
- Small birds, insects and dust may enter the building (Hughes et al., 2012), (Dehghani et al., 2015);
- Lower wind speeds and higher temperatures due to the effects of the urban heat islands and increasing desertification due to climate change (Hughes et al., 2012);

- Enhanced noise and pollution in dense urban environments prohibits natural ventilation strategies (Hughes et al., 2012); and
- Increasing urban density resulting from population growth and immigration is limiting apartment building massing and floor plan layouts with access to adequate airflow (Hughes et al., 2012).

Increasing dependency on mechanical cooling systems is a result of modernization and these emerging disadvantages of windcatchers. However, the energy consumption for mechanical cooling systems in these climate zones is exceedingly high (Saadatian et al., 2012). Dependency on high-grade electricity for low-grade thermal comfort control is not sustainable for long-term environmental management. If some of the drawbacks of windcatchers can be addressed through contemporary integrative design techniques, then socially accepted practices for passive comfort cooling strategies in Iranian dwellings could be achieved.

Through a comparative analysis of existing vernacular windcatchers throughout Iran with the increasingly dense building typologies of contemporary Tehran, techniques for re-integration of original socio-cultural and comfort cooling functions of windcatchers are identified (Figure 1). We propose the integration of lightweight tensile structures with thermal mass components in the designs of new and existing multi-family apartment buildings to replace or assist mechanical ventilation systems in contemporary hot-arid, high-density urban contexts like Tehran.



Figure 1: Framework diagram: Existing urban context and vernacular windcatchers of Yazd (upper left) compared with dense modern urban context of Tehran (bottom left) informing new strategies for integration of windcatcher concepts through tensile fabric techniques

2. BACKGROUND CONTEXT

2.1 Windcatcher characteristics

Windcatchers work on the principles of natural ventilation, employing both wind driven and stack effect ventilation (Moghaddam et al., 2011). The wind-induced forces will always be the main factor influencing natural ventilation (Hughes et al., 2012). In so doing, windcatchers need a driving force to operate where the first force is stack effect of air buoyancy, which occurs due to a difference in indoor-to-outdoor air density resulting from temperature differences. The stack effect is dominant through regions and periods with low wind speed or without prevailing wind (Koch et al., 2004) (Figure 2). The second force is external wind. Windcatchers are generally dependent on wind to operate; therefore, air velocity and volume of induced air circulation are important factors. Research

experiments indicate that windcatcher efficiency is altered by changes in outdoor air velocities, temperature differentials, wind angle orientation and number of openings (Saadatian et al., 2012), (Montazeri, 2011). Cross-section shapes of windcatchers (square, rectangle, hexagon, octagon, and circle) affect induced airflow rates and consequently their efficiency. A square shape windcatcher has the highest rate of induced airflow (Saadatian et al., 2012), (Pearlmutter et al., 2008), (Hughes et al., 2012) (Bahadori et al., 2014) (Figure 3).

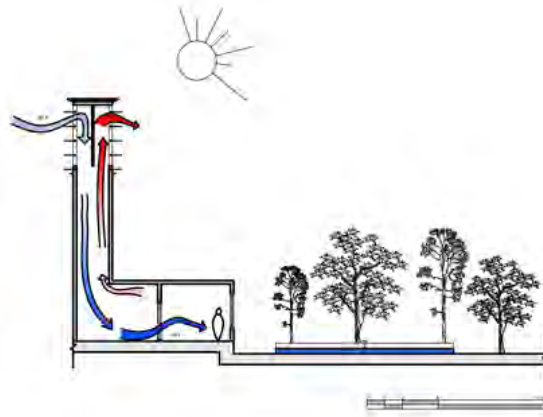

Figure 2: Typical vernacular windcatcher: Natural ventilation caused by stack effect

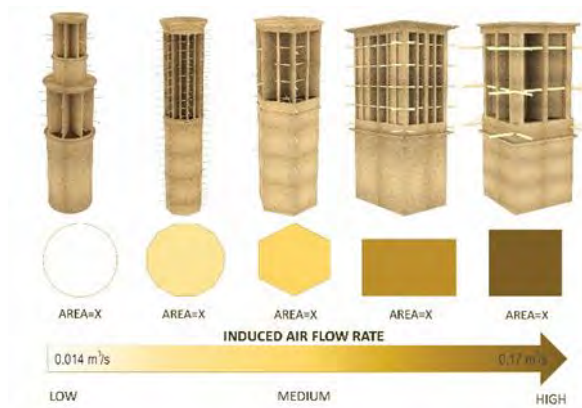

Figure 3: Effect of cross-section shape of windcatchers

2.2 Tensile structure characteristics

Tensile structures are light in weight because their structural stability results from pre-stressed shape rather than the mass of the materials used (Forster and Chilton, 2004), (Berger, 2005). Thus, despite being lighter than conventional building structures, they still offer high stability. The lightweight quality of tensile structures provides unique characteristics such as mobility, adaptability and convertibility. Tensile structures are the most convertible systems that are flexible in configuration and form for a variety of spatial arrangements in response to social and climatic variations (Forster and Chilton, 2004), (Schock, 1997).

The resistance of membranes to soiling is beneficial for their appearance and maintenance cost. Nanotechnology can provide high durability and self-cleaning chemistry for fabrics (Forster and Chilton, 2004), (Koch et al., 2004). One of the most important qualities of tensile structures is optional translucency to provide adequate daylight for inhabitants and reduce dependencies on electric lights. Also, when applied to the building roof, tensile fabric membranes provide radiant cooling effects (Forster and Chilton, 2004), (Scheuermann and Boxer, 1994) (Figure 4a).

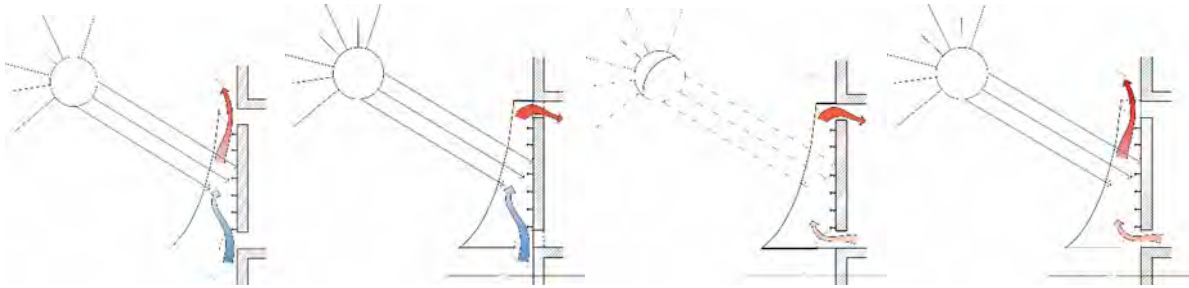

Figure 4: Lightweight tensile structures integrated with exterior building walls for convective functions: a) Heat removal; b) Preheating of fresh air; c) Reheating circulated air; d) Venting and flushing of exhaust air (Berger, 2005)

The effective shading capability of tensile structures due to the membrane coating materials can reflect a high portion of solar radiation. Also, this shading capability provides a cooling effect, which then can be promoted by using natural ventilation, thermal mass and driven airflows inside or underneath the tensile structure. The variations in solar radiation during daytime and also radiation heat losses to the clear sky at night make the surface temperature of the membrane swing rapidly. The exposure of membrane skin to unequal solar radiation and sky temperature provides a vertical temperature satisfaction. The membrane surface temperature can swing rapidly because of variations in solar radiation during daytime as well as radiation heat losses to the clear sky at night. Vertical temperature stratification is derived from exposing the membrane to unequal solar radiation and sky temperature. (Forster and Chilton, 2004) (Figure 4a, 4b).

3. METHODS

The adaptive integration of thermal mass windcatcher functions through lightweight tensile structures in the contemporary hot-arid urban context of Tehran requires identification of specific parameters addressing natural ventilation cooling and inhabitant adaptability. The existing urban morphology and correlated airflow patterns (velocities and directions based on microclimate conditions) of the Sangelaj neighborhood in Tehran are documented in order to identify information on air speed potentials for windcatcher effectiveness. Existing building typologies are identified as multi-story apartments with double-loaded corridor configurations. Because of limitations of open space surrounding existing buildings in this context, integration of traditional thermal mass windcatcher forms as additions to these buildings is not possible. Therefore, concepts for achieving windcatcher thermodynamics through lightweight structures is addressed a mode of transforming the mechanical cooling functions towards passive mechanisms.

Multiple tools are used in the design development and performance analysis process. First, initial climate analysis is conducted with Ladybug plug-in for Grasshopper-Rhino. Second, Computational Fluid Dynamic (CFD) visualizations for wind velocity, pressure, and vectors are conducted through the OpenFoam platform for the existing urban context to determine realistic airflow patterns influencing potential windcatcher ventilation cooling techniques. Third, the design analysis tool for tensile structure morphology is implemented to develop viable fabric forms in response to documented wind pressures.

Physical models of the proposed tensile windcatcher forms are being developed for empirical analysis in a wind tunnel laboratory. These results will aid in corroboration of digital simulation techniques. Implementation of wind tunnel experiments by experimenting different types of physical models from vernacular thermal mass models to modern tensile structures and gathering information about the adaptation of these two to find the best possible adapted model of traditional windcatchers and tensile structures. Steps can be first, making a model of vernacular windcatcher using a material that behaves like thermal mass in order to measure the wind velocity and volume for inlet and outlet. Second, making a simple tensile model in order to test the behavior of tensile structures in the wind tunnel and to measure the identified parameters for inlet and outlet. Finally, making a simple adapted model of tensile structure integrated with thermal mass in order to compare measures of the wind velocity and volume of the new model with both the basic traditional thermal mass model and the basic tensile structure model. Development of the adaptive physical model will be based on some effective characteristics like height, form and location to find the efficient Integration.

4. ADAPTATION

The proposed adaptation is based on a typical existing apartment building in Sangelaj neighborhood in Tehran (Fig. 5a). A cool tower is introduced as a source of fresh air within the central core of the building. Hydro-equipped units are located at the top of the cool tower to provide cool air from evaporation water in a closed loop and gravity flow (Chalfoun, 1991). Hence, fresh cool air sinks through the tower and then enters the openings of each floor in order to provide required natural ventilation into the dwelling units. The exterior windows are replaced with Phase Change Material (PCM) glazing systems to provide thermal mass. PCMs are ideal products for thermal management solutions and they can be translucent (Simen and Jelle, 2015). Hence, by applying translucent fabric for tensile structures and translucent PCM windows for thermal mass within the windcatchers, diffuse natural daylight for each floor in multi-story buildings can be provided. This adaptation works seasonally:

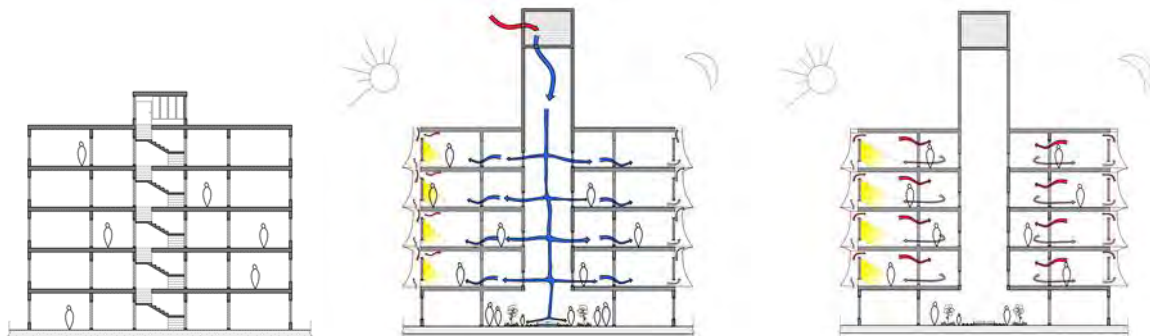

Figure 5: Integration of lightweight tensile structures to existing multi-story apartment buildings for windcatcher functions: a) Section of an existing building in Sangelaj neighborhood in Tehran (left); b) Function of thermal mass integrated tensile structures by using cool tower and adapting with section of existing apartment in Tehran in summer (center); c) Function of thermal mass integrated tensile structures by using cool tower and adapting with section of existing apartment in Tehran in winter (right)

Summer-Day: During day, sun heats up the thin fabric layer of tensile structures. Airflow absorbs heat from the fabric and rises through stack effect while aiding exhaust of warm air from inside the building (Figure 6a). This circulating air movement inside of the building cycles a replacement of the exhaust air with fresh air from the cool tower (Figure 6a). Also, the thermal mass absorbs the heat from the sunlight, which could be useful in the night as it re-radiates to warm the interior spaces (Figure 5b, 6a).

Summer-Night: During night, thermal mass releases back the stored heat to outside because of temperature differences between outside and inside of the building. Cool air from outside enters into the fabric area and absorbs the heat released from thermal mass and rises through stack effect while aiding exhaust of warm air from inside the building (Figure 6b). By this way, not only warm air of inside the building is exhausted, but also fresh cool air from the cool tower is pulled through the interiors of the building in order to replace the warm exhaust air (Figure 5b, 6b).

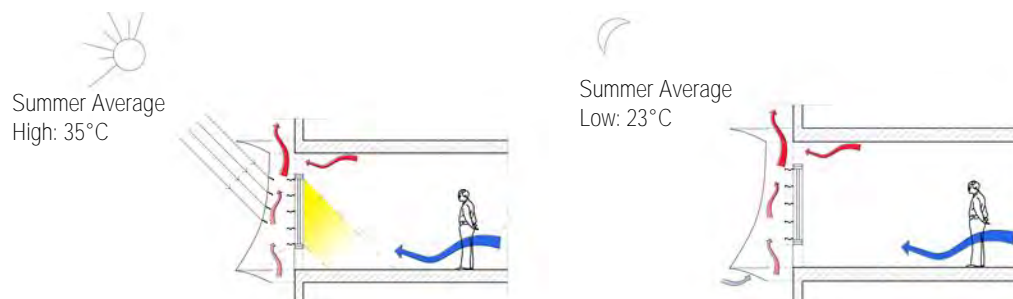

Figure 6: a) Adaptive wind-catcher concept for the summer day; b) Adaptive wind-catcher concept for the summer night

Winter day: Cold air coming from the bottom opening becomes warm as a result of contacting the heated fabric by sunlight and rise. Airflow after absorbing heat from fabric rises due to stack effect and captures warm air inside the building from the opening on top (Figure 7a). The warm air will flow inside and heat the interior spaces of the

building. Also, the thermal mass absorbs heat from the sunlight, which is beneficial for re-radiating into the building at night (Figure 7a, 5c).

Winter Night: During the night, all external vent openings will remain closed. The thermal mass will release the absorbed heat back to the interior. The airflow coming from inside the building absorbs heat from the thermal mass and becomes warm (Figure 7b). The warm air rises to circulate back into the building again and completes the loop (Figure. 7b, 5c).

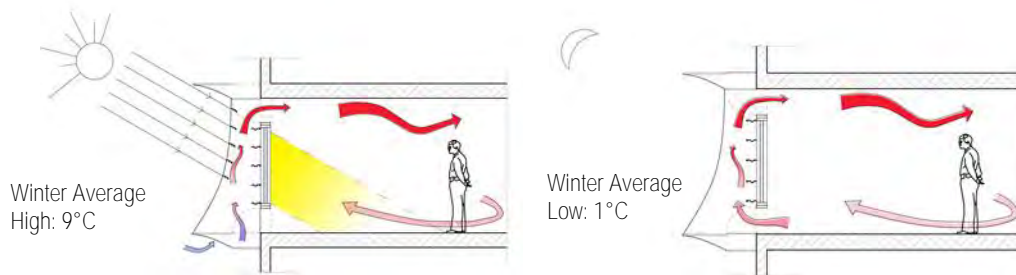

Figure 7: a) Adaptive wind-catcher concept for the winter day; b) Adaptive wind-catcher concept for the winter night.



Figure 8: The proposed adaptive wind-catcher concept in the existing urban context of Tehran

5. CONCLUSIONS and FUTURE WORK

This research establishes the framework for adaptation of traditional thermal mass windcatcher functions into contemporary dense urban contexts to maximize their passive cooling advantages and take measures towards solving its disadvantages. In so doing, the tensile structure is identified as an adaptive membrane that can **potentially accommodate variant airflow patterns and thermal regulation for inhabitants' social needs through** energy efficient means. Additionally, due to the increasing density of cities during recent centuries, the research considers the exterior integration of lightweight tensile structure windcatchers in multi-story buildings. The façade adaptation considers natural ventilation by stack effect and Bernoulli principle in the design of the lightweight tensile windcatchers in conjunction with other characteristics of the fabric and PCM glazing to assist natural daylighting to the building interiors. The work is being progressed through the physical modelling and CFD simulation analyses (Figure 9a, 9b).

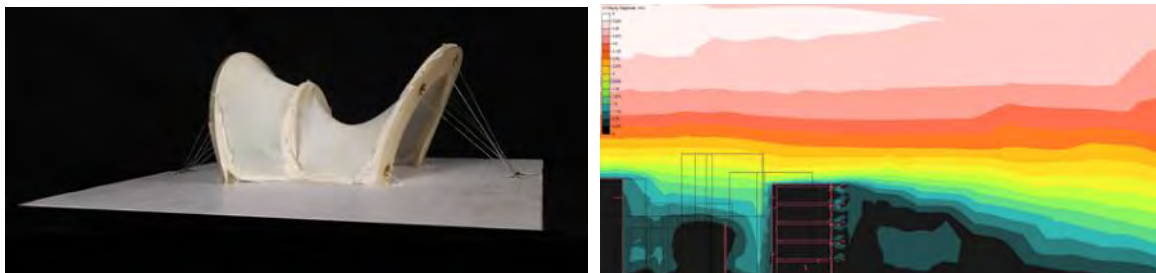

Figure 9. a) Photograph of physical model of one module; b) Image of CFD simulation (wind velocity) in urban context of the neighbourhood

The next step in this research would be to find a relation between height, inlet, and outlet of vernacular windcatchers to be optimum, to work on form and aerodynamic of windcatchers based on airflow patterns, and to scale up for initial physical prototype construction and testing when simulation validations are complete. Additional research is also being conducted on the Iranian textile industry to consider how to adapt cultural heritage weaving techniques into modernized fabrication processes for the lightweight fabrics. Further work is also required with inhabitant interface and social interactions with the adaptive tensile windcatchers.

REFERENCES

- [1] Bahadori Nezhad, M., Dehghani, A. 2008. "Windcatcher as a Masterpiece of Iranian Engineering", Yazda, Tehran, Iran.
- [2] Bahadori, M.N., Dehghani-s Anij, A. and Sayigh, A., 2014. Wind Towers. Springer International Publishing.
- [3] Berger, H., 2005. Light structures, structures of light: the art and engineering of tensile architecture. AuthorHouse.
- [4] Battle McCarthy Consulting Engineers, 1999. Wind towers. Academy Press.
- [5] Chalfoun, N.V., 1991. Energy-saving construction techniques performed by the "House Energy Doctor®"; An educational, research and community service program at the College of Architecture, The University of Arizona.
- [6] Dehghani-sanij, A.R., Soltani, M. and Raahemifar, K., 2015. A new design of wind tower for passive ventilation in buildings to reduce energy consumption in windy regions. *Renewable and Sustainable Energy Reviews*, 42, pp.182-195.
- [7] Elmualim, A., 2009. Integrated building management systems for sustainable technologies: Design aspiration and operational shortcoming. *Sustainability in Energy and Buildings* (pp. 275-280). Springer Berlin Heidelberg.
- [8] Forster, B. and Chilton, J., 2004. Introduction [European design guide for tensile surface structures] (pp. 17-24). Tensinet.
- [9] Hughes, B.R., Calautit, J.K. and Ghani, S.A., 2012. The development of commercial wind towers for natural ventilation: A review. *Applied Energy*, 92, pp.606-627.
- [10] Koch, K.M., Habermann, K.J. and Forster, B., 2004. Membrane structures: innovative building with film and fabric. Prestel Publishing.
- [11] **Mahmoudi, M., (2010). "Windcatcher, The Symbol of Iranian Architecture.", Yazda, Tehran, Iran.**
- [12] Moghaddam, E.H., Amindeldar, S. and Besharatizadeh, A., 2011. New approach to natural ventilation in public buildings inspired by Iranian's traditional windcatcher. *Procedia Engineering*, 21, pp.42-52.
- [13] Montazeri, H., 2011. Experimental and numerical study on natural ventilation performance of various zmulti-opening wind catchers. *Building and Environment*, 46(2), pp.370-378.
- [14] Ng, E. ed., 2009. Designing high-density cities: for social and environmental sustainability. Routledge.
- [15] Noble, A., 2009. Traditional buildings: a global survey of structural forms and cultural functions. IB Tauris.
- [16] Pearlmutter, D., Erell, E. and Etzion, Y., 2008. A multi-stage down-draft evaporative cool tower for semi-enclosed spaces: Experiments with a water spraying system. *Solar energy*, 82(5), pp.430-440.
- [17] Roaf, S., Crichton, D. and Nicol, F., 2009. Adapting buildings and cities for climate change: a 21st century survival guide. Routledge.
- [18] Saadatian, O., Haw, L.C., Sopian, K. and Sulaiman, M.Y., 2012. Review of windcatcher technologies. *Renewable and Sustainable Energy Reviews*, 16(3), pp.1477-1495.
- [19] Scheuermann, R. and Boxer, K., 1996. Tensile architecture in the urban context. Architectural Press.
- [20] Schock, H.J., 1997. Soft shells: design and technology of tensile architecture. Birkhauser.
- [21] Simen, E.K. and B.P. Jelle, 2015. Phase change materials and products for building applications: A state-of-the-art review and future research opportunities. *Energy and Buildings* 94, pp.150–176.

Track 6: Market Transformation & Green Building Management

Session 1.9: Practices & Methodologies for Green Building Management (1)

Incorporating Sustainability Criteria in Commercial Workplace Fit-Out Guidelines for A Banking Operation

Mary Myla ANDAMON^a, James WONG Pow-chew^b

^a RMIT University, Australia, mary.andamon@rmit.edu.au

^b RMIT University, Australia, james.wong@rmit.edu.au

ABSTRACT

Organisations are increasingly expected by shareholders and the community at large to demonstrate corporate social responsibility in consideration of the environment, employees and the community. Leading organisations **are demonstrating that corporate social responsibility starts at 'home', using their workplaces as practical** exemplars of their commitment. This study investigated the key performance areas and priorities of a major international banking organisation in developing and incorporating sustainability criteria into the design and decision-making processes that govern the commercial workplace fit-outs. The sustainability guidelines established the performance indicators and benchmarks for the workplace environments consistent with the **organisation's expectation for quality, value and sustainability for the accommodation and office environments.**

A key issue in achieving sustainability in office fit-outs is to be informed of the options and their potential impacts and being able to make design decisions that will maintain the integrity of the design but have the smallest ecological footprint. The theoretical framework of life cycle thinking (LCT) is a vital part in understanding sustainability. The selection of the standards and criteria which form this guide drew on this principle and aims to promote holistic decision-making during the fit-out design process and implementation. The Sustainability Guidelines is based on the environmental principles, effective practices and concepts featured in the rating systems Green Star and NABERS (Australia), LEED (US), BREEAM (UK) and BCA Green Mark (Singapore). The guideline is applied to the fit-out of commercial workplace projects, including new facilities and changes to existing facilities. It provides a framework of considerations for reducing environmental impacts and contains information on opportunities and strategies to illustrate achievement of key performance benchmarks. It identified the mandatory minimum standards and facilitates the material specification for sustainable fit-out design and on-going ecologically **sustainable development (ESD) solutions and initiatives outcomes for the bank's commercial workplace fit-outs.**

Keywords: corporate social responsibility, sustainability guidelines, workplace fit-out

1. INTRODUCTION

Expectations on organisations to exercise social responsibility in their corporate performance have led to most to consider their commitment to the environment, employees and the community as a crucial aspect in gaining competitive advantage. These companies are increasingly operating in rapidly changing and more challenging global operations, where the shifting landscapes combined with significant changes in populations and demographics, urbanisation, resource utilisation, climate change, and employee and consumer attitudes have become the impetus to review corporate governance, social and environmental performance.

Leading organisations are demonstrating that corporate social **responsibility starts at 'home', using their** workplaces as practical exemplars of their commitment. This study investigated the key performance areas and priorities of a major international banking organisation in developing and incorporating sustainability criteria into the design and decision-making processes that govern the commercial workplace fit-outs. The sustainability guidelines established the performance indicators and benchmarks for the workplace environments consistent

with the organisation's expectation for quality, value and sustainability for the accommodation and office environments. This paper reports on the process undertaken to formulate the bespoke sustainability guidelines for the office fit-out.

2. DEFINING SUSTAINABILITY IN ACCORDANCE WITH THE ORGANISATION'S ASPIRATIONS AND PRIORITIES

Setting common standards for sustainability initiatives for an organisation with an extensive and diverse property portfolio across different global regions poses a unique challenge. Multiple factors can render readily available prescriptive standards impractical or irrelevant due to project-specific constraints and opportunities. This study was guided by the main objective to develop and incorporate sustainability criteria into the design and decision making processes that govern commercial fit-outs across the operations of the organisation. It was highlighted that the **criteria need to address the organisation's vision of environmental sustainability and must be interpreted by a global audience of operational units.** The standards will leverage existing guidance available through best practice guidelines and relevant rating systems. Standards will adopt a form that is sufficiently detailed to guide the development of detailed, project specific, specifications, however retaining sufficient flexibility to enable deployment globally.

From the outset, the formulation of the guidelines reflected the fact that the banking organisation commitment to the four pillars of sustainability, namely economy in general, the industry, society and the environment. Sustainability understanding in the financial services industry was the underpinning guiding principle for the study. All organisations in this services industry sector will have some issues surrounding these sustainability pillars relative to each other. The approach taken for this study was not designed to be comprehensive nor prescriptive in judging what is good, good enough or bad practice. It was based on a consistent approach of analysing objective and quantitative measures which can be adjusted by the organisation as appropriate for incorporation.

Sustainability has been defined contextually in numerous ways. The popular and often quoted definition is from the 1987 Report of the World Commission on Environment and Development, "Our Common Future" [Brundtland Report]. Simply put, this defines sustainability as referring to human society being capable of continuing indefinitely. The development that will move society in that direction is sustainable development. However, the concept of sustainability become relevant only when the un-sustainability inherent in the current activities of society is understood. "Sustainability is a term that arises in response to a potential environmental and human disaster ... and cannot be separated from that other great concept ...globalisation".

Predominant models of sustainability include the 'triple bottom line' (TBL), coined by Elkington in which the environmental, social and financial outcomes are taken into account (Figure 1).

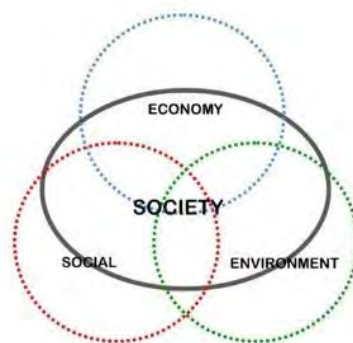

Figure 1: Triple bottom line framework for sustainability

Miller et al further contend that building sustainability knowledge requires a fundamentally different approach to the ways organisations coordinate capacity building and research and how it relate to society.

2.1 Sustainability knowledge as the guiding principle: Overarching sustainability principles

In the development of the set of generic environmental sustainability requirements relating to office fit-out which **reflect the organisation's corporate sustainability vision, the research team, in collaboration with the bank's heads**

of Sustainability and Property Advisory Services, drew on the bank's corporate responsibility framework and priorities (CRF). The organisation is committed to reducing the impact of its business activities and operations on the environment. The CRF guides and underpins this commitment to improve environmental performance which is integral to the bank making a sustainable contribution to society (Figure 2).

The bank has demonstrated this commitment by achieving a carbon neutral footprint across its portfolio globally. In its commitment to invest in the management of environmentally, socially and commercially sustainable banking operations, it has established targets for greenhouse gas (GHG) emissions, energy use, water use, paper use and waste to landfill to assist in the management of its environmental performance.

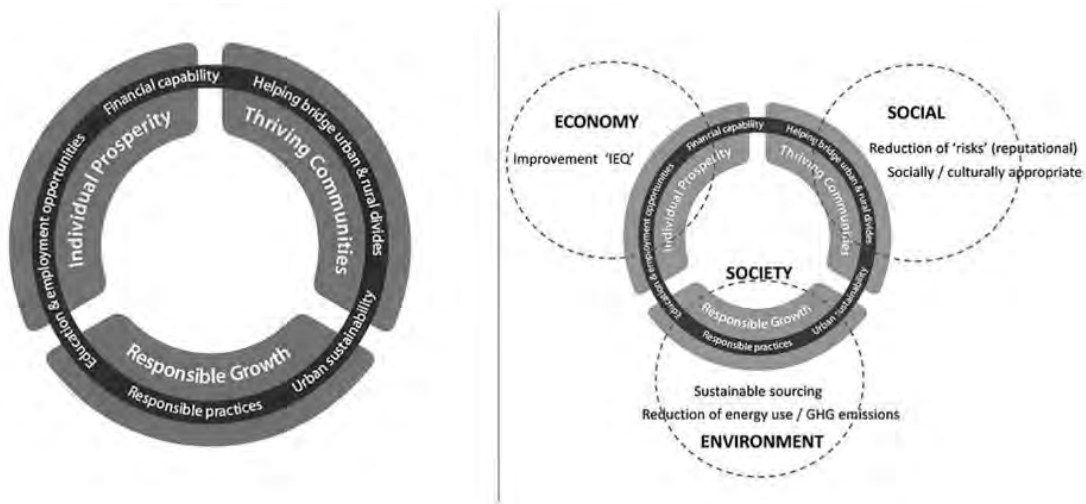

Figure 2: Translation of the corporate responsibility framework (CRF)

3. APPLICATION OF SUSTAINABILITY PRIORITIES: FRAMEWORK FOR THE SUSTAINABILITY GUIDELINES

The outcome of the study is a document that provides general standards for achieving sustainability outcomes in **the bank's new commercial office fit-outs**. The guidelines were presented within a framework that provided explanation and rationale. The objectives and scope for formulating the document allow its suitability for deployment as part of a generic design brief provided to fit-out designers and will be sufficient to enable detailed project specifications to be developed.

A key issue in achieving sustainability in office fit-outs is to be informed of the options and their potential impacts and being able to make design decisions that will maintain the integrity of the design but have the smallest ecological footprint. The theoretical framework of life cycle thinking (LCT) is a vital part in understanding sustainability. The selection of the standards which form this guide drew on this principle and aims to promote holistic decision-making during the fit-out design process and implementation.

3.1 Reference to green building rating systems

The standards outlined in guidelines define the attributes of a sustainable commercial workplace fit-out and provide **definitive criteria for evaluation of its performance from a 'tenanted space' perspective. The Sustainability Guide is based on the environmental principles, effective practices and concepts featured in the rating systems Green Star and NABERS (Australia), LEED (US), BREEAM (UK) and BCA Green Mark (Singapore).** It was recommended that these ratings systems as well as the locally appropriate assessment tools be referenced in relation to the performance goals and technical strategies contained in the guide.

3.2 Key performance areas and priorities

In close consultation with the bank, particularly the sustainability and corporate social responsibility teams, key principles from the five (5) reference green building rating systems were identified and formed as the standards to align with the four (4) overarching key performance areas and priorities of the bank (Figure 3): climate change and

resource use (CRU), well-being and health (WH), socially and culturally appropriate (SC), and reduction of risks (RR).

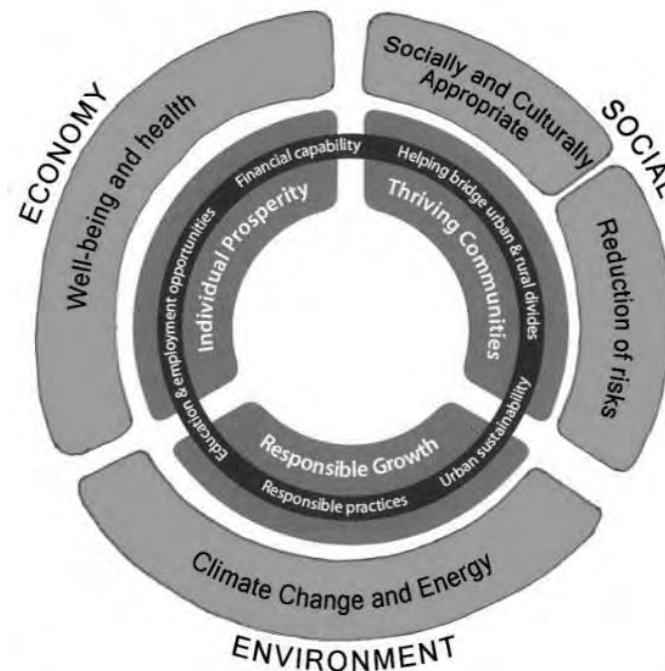

Figure 3: Application of sustainability priorities

Climate change and resource use (CRU)

- Energy management: Achieve benchmarks and performance targets in energy efficiency and minimising loads on energy supply infrastructure.
- Reduction in GHG emissions: Achieve performance targets in absolute emissions reductions.
- Water conservation: Achieve benchmarks and targets in water use reduction.

Well-being and health (WH)

- Indoor environmental quality (IEQ): Improve indoor environmental quality (IEQ) and achieve healthy internal building environments.

Socially and culturally appropriate (SC)

- Waste minimisation and Avoidance: Reduce waste generated by building occupants that is collected, hauled to and disposed of in landfills; material re-use.

Reduction of risks (RR)

- Materials: Minimise the environmental impacts materials used in the fit-out and works.
- Responsible sourcing: Supporting regional economies and reducing environmental impacts resulting from transportation and servicing.
- Management of risks and compliance issues: Minimising operation costs, potential compliance issues and reputation through recognition and management of risks related to the fit-out process and its implications for ongoing business performance.

3.3 Structure, interpretation and use of the guidelines

The Guidelines apply to the fit-out of office accommodation occupied by organisation, in Australia and its global operations. All up, 15 standards were identified and these provide a framework of considerations for reducing environmental impacts and contain information on strategies and opportunities relating to key performance benchmarks (Table 1).

Climate and Resource Use (CRU)		
	CRU 1-1	Lighting power density
	CRU 1-2	Lighting zones and controls
	CRU 1-3	Energy efficiency (equipment and appliances)
	CRU 1-4	Energy monitoring (energy sub-metering)
	CRU 1-5	Water efficiency (fittings)
Well-being and Health (WH)		
	WH 2-1	Visual comfort
	WH 2-2	Indoor air quality – low-emitting materials
	WH 2-3	Thermal comfort
	WH 2-4	External view and daylight
	WH 2-5	Internal noise levels
	WH 2-6	Water quality
Socially / Culturally Appropriate (SC)		
	SC 3-1	Reduction of waste
Reduction of risks (RR)		
	RR 4-1	Responsible sourcing
	RR 4-2	Regional materials
	RR 4-3	PVC Use

Table 13: Structure of standards

The purpose of the guide is to direct and complement the structured fit-out planning, design and construction process provided by design professionals. It facilitates the material specification for sustainable fit-out design and on-going ecologically sustainable development (ESD) solutions and initiatives outcomes. Each of the standards follows a common format which outlines the Intent – a summary statement of the key performance principles or practices, the performance Target which indicates the requirements, the rationale and benchmark for the standard, and a range of Potential Technologies and Strategies to be used in achieving the requirements. A number of the standards also contain opportunities Beyond Compliance which outlines the potential performance targets beyond the mandatory requirements. Information on Reference Protocols with achievable scores as required by the selected building rating tools is provided for each of the standards.

As an illustration, the standards CRU 1-1: Lighting power density and CRU 1-2: Lighting zones and control are as follows:

Sustainability standard	Target	Beyond compliance
CRU 1-1: Lighting power density		
[a] Efficient light fitting, electronic ballasts [b] Low standby power not greater than 0.001 watts per watt of lighting power [c] Fixture uniformity – maintain uniform lumen levels through group relamping	9 W/m ² LPD	7 W/m ² LPD
CRU 1-2: Lighting zoning and controls		
[a] Maximum lighting zones [b] Individual lighting controls [c] Occupancy sensors [d] Daylight controls for daylit areas [e] Daylight controls for 50% of the lighting load	to be 100m ² for 90% (min) of office space 75% (min) of the connected lighting load.	

4. REFLECTING SUSTAINABILITY REQUIREMENTS: SUSTAINABILITY GUIDELINES FOR COMMERCIAL WORKPLACE FIT-OUTS

The guide applies to the fit-out of all the bank's commercial workplace projects, including new facilities and changes to existing facilities. It provides a framework of considerations for reducing environmental impacts and contains information on opportunities and strategies to illustrate achievement of key performance benchmarks. The purpose of the guide was to direct and complement the structured fit-out planning, design and construction process of organisation's Workplace Environment provided by design professionals. Crucial and key to the formulation of the

guidelines was the close collaboration with the bank's sustainability team, property services, environmental and services project design. Prior to finalisation, training workshop session and sign-off, the draft document was circulated to key personnel interstate and overseas groups for review and comments. Complimentary feedback received from the bank's sustainability team generally referred to the guide meeting the needs of the organisation in being comprehensive yet concise and easily able to be used by both staff and external contractors and consultants.

The office fit-out contributes significantly to efficiency and operational effectiveness. For example, an energy-efficient office fit-out design offers the possibility of significantly increased worker productivity. Healthier working environments include favourable lighting, acceptable acoustic levels, indoor air quality and indoor thermal comfort are affected by many energy-efficiency measures. An increasing number of case studies reported that healthy indoor environments can increase employee productivity. Because office workers are by far the largest expense for most organisations (typically for offices, salaries are 72 times higher than energy costs and account for 92% of the life cycle cost of a building), therefore increased employee productivity has a significant effect on overall profitability. **An audit of the organisation's offices, on average, salaries are approximately 45 times higher than energy costs.**

Office fit-outs designed for energy-efficient performance have very attractive economic returns. A case in point is an efficient lighting design and well-managed lighting system which can contribute to significant improvements in energy efficiency in office tenancies. Although it varies from office to office, as an example, lighting can typically **account for 30% of a commercial office tenancy's power consumption. Case studies indicated that, depending on the installation and usage patterns, energy savings on lighting in the range of 20-70% can be achieved in a typical office with a 3 to 5 year-payback of investment.**

REFERENCES

- [1] ASHRAE, Advanced Energy Design Guide for Small to Medium Office Buildings: Achieving 50% energy savings toward a net zero energy building. 2011, American Society of Heating Refrigerating and Air-Conditioning Engineers (ASHRAE): Atlanta, GA. p. 236.
- [2] Building and Construction Authority, BCA Green Mark for Non-Residential New Buildings (Version NRB/3.0). 2008, Singapore: Building and Construction Authority.
- [3] Cullingford, C 2004, 'Sustainability and Higher Education', in J Blewitt & C Cullingford (eds), The sustainability curriculum: the challenge for higher education Earthscan Publications, London, pp. 13-23.
- [4] Elkington, J., Cannibals with Forks: The Triple Bottom Line of 21st Century Business. 1997, Oxford, UK: Capstone Publishing Limited.
- [5] Green Building Council Australia (GBCA), Green Star - Office v3. 2008, Green Building Council Australia (GBCA): Sydney, New South Wales.
- [6] Kats, G., et al., The Costs and Financial Benefits of Green Buildings - **A Report to California's Sustainable Building Task Force**. 2003, California Department of Resources Recycling and Recovery (CalRecycle): Sacramento, CA. p. 134.
- [7] Miller, N.G., et al., Green Buildings and Productivity. Journal of Sustainable Real Estate, 2009. 1(1): p. 65-89.
- [8] Miller, T.R., T. Munoz-Erickson, and C.L. Redman, Transforming knowledge for sustainability: towards adaptive academic institutions. International Journal of Sustainability in Higher Education, 2011. 12(2): p. 177-192.
- [9] NSW Government Office of Environment & Heritage. National Australian Built Environment Rating System (NABERS). 2013 [cited 2016 10 October 2016]; Available from: <https://nabers.gov.au/public/webpages/home.aspx>.
- [10] Romm, J.J. and W.D. Browning, Greening the Building and the Bottom Line (Revised). 1998, Rocky Mountain Institute.: Boulder, CO. p. 17.
- [11] UK Building Research Establishment (BRE), Building Research Establishment Environmental Assessment Method (BREEAM) New Construction: Non-Domestic Buildings Technical Manual (SD5073-2.0:2011). 2011, Watford, Hertfordshire, UK: Building Research Establishment.
- [12] United Nations World Commission on Environment and Development 1987, Our Common Future (Brundtland Report), Oxford University Press, Oxford.

- [13] US Green Building Council (USGBC), Leadership in Energy and Environmental Design (LEED) for Commercial Interiors. 2009, Washington, DC: US Green Building Council.

Adopting Green Building Concepts in Housing Estate Development Projects in Abuja F.C.T., Nigeria: Exploring The Potentialities of End-Users' Preferences

Salisu Gidado DALIBI^a, FENG Jing-chun^b, Abubakar SADIQ^c, Bello SANI BELLO^d

^a Business School of Hohai University Nanjing, Mainland China, salgidos@yahoo.com

^b Business School of Hohai University Nanjing, Mainland China, feng.jingchun@163.com

^c Business School of Hohai University Nanjing, Mainland China, sadiq635@yahoo.co.uk

^d Business School of Hohai University Nanjing, Mainland China, bellsann@yahoo.com

ABSTRACT

Abuja F.C.T. is the Federal Capital Territory of Nigeria; with a population growth rate of about 25% - 45% annually and is projected to reach 10million by 2018. This has led to housing shortages and the need for many housing schemes. Many Residential housing developments do not reflect the desired housing needs of the end-users in terms of satisfaction and sustainability, despite a growing interest in green buildings among the various stake holders. Previous research efforts showed that the results are still uncertain and conflicting. Nonetheless, such studies have exposed the main variables especially the human factors affecting green building projects such as different success criteria, divergent success factors and lack of common or shared perspectives among the stake holders. **Incorporating green building features are at the developer's disposal** but should align with the potential end-users preferences as it affects the rentals and sales values of such developments. The aim of this paper is to explore the potentialities of using or adopting the **End-users' preferences in green building features** in estate development projects in Abuja, with a view of adopting green building features that satisfies the interest of both the developers and the end-users thereby promoting green building projects. Review of literatures helps identify and narrow the residential end-users satisfaction in various housing estates and their preferred green features. A 5-point Likert scale questionnaire survey was conducted on Estate Development Firms in Abuja; selected through random sampling method. The results showed that green building features such as: Energy Efficiency systems, Building Envelope, Water efficiency systems, Indoor Environmental Quality and Day-lighting systems were the features favoured by the End-users as they are also adoptable, affordable by the developers. Conclusively, they have the potential of providing a common ground to these stakeholders in adopting green features in residential housing developments in Abuja.

Keywords: end-users, estate developments, green building management, housing, stake holders, potentialities

1. INTRODUCTION

Abuja Federal Capital Territory (FCT) is the Capital of Nigeria the most populous African country located in western Africa; geographically located at the centre of Nigeria. Abuja under Köppen climate classification features a tropical wet and dry climate with three weather conditions namely; warm, humid rainy season and a blistering dry season; with a brief interlude of harmattan in between the two (WECSI 2014, demographia.com; Wikipedia.org and Dalibi et al., 2016). A good observation makes Abuja the largest construction site in Nigeria. It is considered among the fastest growing cities in the world, with a present population of about 4million; projected to reach 10million by 2018-20 (Muhammad 2013; Sundaram, 2012; demographia.com; Wikipedia.org). This explosive growth rate has created severe housing problems due to high demand resulting in problems such as overcrowding, inadequate electricity (power) and water supply, other degrading public infra

structure, deplorable urban environment especially the Built environment etc. Despite being a pre-planned city, Abuja is also affected by spontaneous and uncontrolled urbanization like any other city in a developing country and has led to growth of suburban city-like districts and springing up of many satellite towns around the city (Dalibi et al., 2016).

These housing conditions have continued to evoke considerable concern due to its effects on the built environment and also, the need for modern infrastructure that will serve the needs of the present and the future. This goes a long way in affirming the increase in global population growth accompanied by massive resource consumption and its negative impacts on the environment (Dalibi et al., 2016). The combination of these challenges gave birth to a

new concept in design, construction/ renovation, operation and maintenance of buildings in conformity with sustainable practices known as Green Buildings (Dalibi, 2014).

The relocation of various headquarters of Major corporations, banks, companies and businesses further compounded the housing challenges for the end-users with the need for high taste and or high-end housing Estate developments in Abuja FCT; specifically houses with features that add to user comfort ability and save running costs etc. such feature are common in green building projects.

1.1 Research problem

The problems of housing supply in meeting the ever increasing housing demand remains one of the most pressing problems facing Nigerian urban centres (Israel and Basiru, 2008). Although residential quality studies have gained increasing attention in recent times, the majority of such studies was foreign and focused mainly on factors affecting the quality and performance of construction, particularly in public or social housing programs within specific housing environment (Shinnick, 1997; Djebarni and Al-Abed, 1998, Saari and Tanskanen, 2011). A few studies conducted locally have focused on the perception of residential quality in selected neighbour hoods (Ebong, 1983; Ibem, 2012); whereas others addressed the socio-cultural dimensions and patterns of housing quality (Akinola, 1998; Jiboye et al., 2005; Olayiwola et al., 2006; Jiboye 2010).

Over the years, many housing estates were developed by both the Public and the Private sectors or a partnership of both in the Abuja FCT. However, Such Housing estate developments were insufficient in terms of demands; do not reflect the desired housing needs of the end-users; in most cases affordable but not qualitative; do not possess green building features; affected by insufficient electricity (power) and water supply for residential consumption etc. (Dalibi et al., 2016). These outlined the need for housing estate development projects with features that can take into consideration the end-users preferences in such development projects.

Fenn et al., 1997; pointed out that incompatibility of interests amongst stakeholders caused conflicts and disputes in construction. Notwithstanding, Berke (2002) advocated the holistic inclusion of different interests from stakeholders and involving the public in planning. Incorporating the various interests of stakeholders should be extremely important for the preparation of green specifications, construction and maintenance.

Though, green building construction practice is a new trend (about two-three decades old) in construction with insufficient data about the costs and also the absence of measured building performance data from currently operating sustainably designed buildings (BD&C 2003; ENSAR 2003; Andreau et al., 2004). It is evident from some **developers' attitudes, as they are not fully inclined towards constructing such projects due to lack of comprehensive data about the financial obligations with regards to Incorporating green features into renovation or proposed projects, Premiums, Marketability, Ratings, Cost of renting, Operating and Recurrent costs, Cost – benefit from envisage energy and water savings etc.** (Dalibi et al., 2016).

Morris, 2007; argued that “The most common reasons cited in studies for not incorporating green elements into building designs is the increase in first cost”; the cost of incorporating sustainable designs elements depends on a wide range of factors which includes Building type, Location, Climate, Site conditions and the Project team. These factors may have relatively small or big but noticeable impact on green building developments especially in Abuja and cumulatively, they make a difference.

Sustainable design elements are gradually accepted in the mainstream of project design, in which building owners and tenants are beginning to demand and value those features. It is important to note, however, that advanced or innovative sustainable features can add significantly to the cost of a project and that these must be valued independently to ensure that they are cost and or environmentally effective (ibid). Incorporating green building **features/ elements are basically at the developer's disposal and may have a significant impact on the total development cost which in turn affects end-users/ occupants in terms of Rental value, Sales value, Envisaged savings due to green elements, Future asset value of the green building etc.** (Dalibi et al., 2016).

Thus, those elements must be checked with potential end-users in order to ensure they meet their housing needs, **requirements and also their affordability which will also reflect on the developers' interests in terms of market value and faster sale of the Housing units.**

1.2 Research aim

The aim of this paper is to Explore the potentialities of end-users' preferences in adopting green building concepts in housing estate development projects in Abuja F.C.T., Nigeria. Review of literatures in the Eco/ green/ sustainable building field helps identify and narrow few environmentally sustainable passive and active elements in the particular context of Abuja.

1.3 Research hypotheses

The following hypotheses were formulated for this research; T-test statistical tool was used in testing these formulated hypotheses:

Null hypothesis (H_0); End-users preferences does not have any potential impact in adopting green building concepts in housing estate development projects in Abuja F.C.T., Nigeria

Alternative hypothesis (H_A); End-users preferences have potential impact in adopting green building concepts in housing estate development projects in Abuja F.C.T., Nigeria

2. LITERATURE REVIEW

2.1 The significance of stakeholder (end-users) engagement in green buildings (GB)

Stakeholder engagement is increasingly being recognised as more than just a defensive response to criticism or imminent conflicts but rather it contributes to organisational resilience and flexibility, to learning and innovation, to the identification of new opportunities, and ultimately to the improvement of sustainable performance (Partridge et al., 2005).

Any new building construction method or concept has its own peculiar challenges and green building is not an exception. For example, during the 1990s, green building measures were not been widely adopted, (Gottfried, 1996). Too few green building demonstration projects provide the industry with needed "how-to" information that reduces the perceived risk of "pioneering." Moreover, building owners and tenants are often aware of the connection between building-related environmental improvements and increased building economics and value, as well as increased occupant productivity (Ibid).

As such, incorporating the various interests of stakeholders is extremely important in green building projects from the preparation of green design, specifications, to green construction, operation and maintenance. This is done by acquiring all relevant information on green buildings, interpreting this information and effectively disseminating the information to persons who might need or involved in, and influenced by such projects. Communication is so important to project success that it has been referred to as the lifeblood of a project by many practitioners (Awati K., 2010).

The 5th edition of the project Management body of knowledge (PMBOK) published by the project management institute (PMI); outline Project Communications management and project stakeholder management as part the ten core knowledge areas. These two knowledge areas intersect first at the planning phase with one process each, namely; Plan Communications Management and Plan Stakeholder Management. This affirms the need for effective communications among the stake holders to enable success of projects especially green buildings.

Successful delivery of projects, their operations and management (including green building projects) is attributed to many factors of which stakeholders' perceptions, participation, roles and responsibility is among (Bourne, 2005 and Dalibi, 2014). Stakeholders' input, participation, roles and responsibility in Green buildings projects must be of high cognizance than conventional building projects because of the divergent stakeholders' interests (Dalibi et al., 2016). These warrants the need for exploring the potentialities of end-users' preferences in adopting green building concepts in housing estate development projects in Abuja F.C.T., Nigeria.

Several surveys, evaluations and research works were conducted at the post occupancy stages of various buildings to ascertain the level of satisfaction of the end-users and also to rate the intended performance of the buildings. Post Occupancy Evaluations were normally conducted in both residential and commercial buildings,

using various baselines and comparisons. Some studies focus on occupant satisfaction and/ or perception in green buildings (Armitage et al., 2011; Gou et al., 2012a; Wilkinson et al., 2013). Other studies emphasize the differences **(if any) in the occupants' satisfaction in and/ or perception of green and conventional buildings** (Abbaszadeh et al., 2006; Gou et al., 2012b; Paul and Taylor, 2008; Zalejska-Jonsson, 2012). Still others examine a move from a conventional building/ refurbishment of a conventional building to a green building (Agha-Hosseini et al., 2013; Thatcher and Milner, 2012).

Comprehensive building performance evaluation and monitoring is an essential and no longer an optional way to check whether the actual building performance meets the design expectations and also to map the performance **issues. It reveals the lessons of 'what works in practice and what doesn't' to be fed back to the construction industry** (Bordass and Leaman, 2005 and Bordass 2011).

Occupant surveys are recognized to be a key component of any building performance evaluation study (Stevenson and Rijal, 2008). Recent research shows that different occupant lifestyle and behaviour may result in up to fourteen times difference in energy and water use for the same type of low carbon homes (Pilkington et al., 2011). Also, residents/ end-users provide a valuable source of information about the comfort conditions in a building and their level of satisfaction is an indicator of success or failure of the building performance (Nooraei, 2013)

2.2 Green buildings, end-users' potentialities, preferences and impacts

Green building (GB) sometimes called Green construction/ Eco-building/ High performance building/ Sustainable building is defined based on the features, components and perceived impacts. GB refers to a structure that uses all processes that are environmentally responsible and resource-efficient throughout a building's life-cycle (USEPA, 2009); sensitive to the environment, resource and energy consumption, impact on people, financial impact and the world at large (Greg Kats, 2003); environmentally friendly practices from building design to the landscaping choices by encompassing energy use, water use, storm-water and wastewater re-use (Zane et al, 2009); buildings designed, constructed to provide optimum performance of the building with positive impact to the occupants and the environment by combining energy, water efficiency systems, Day Lighting strategies, Indoor Environmental Quality (IEQ) systems and efficient Building Envelope systems (Dalibi, 2012).

The United States environmental protection agency as cited by Vatalisa et al., 2013; opine that **"GBs are designed to reduce the overall impact of the built environment on human health and the natural environment through the goals of sustainable building such as Life cycle assessment (LCA), Energy Efficiency and Renewable Energy, Water Efficiency, Environmentally Preferable Building Materials and Specifications, Waste Reduction, Toxics Reduction, Indoor Air Quality, Smart Growth and Sustainable Development, Environmentally Innovative materials and services. While according to USGBC 2007; "GB is a holistic concept that starts with the understanding that the built environment can have profound effects, both positive and negative, on the natural environment, as well as the people who inhabit buildings every day. Green building is an effort to amplify the positive and mitigate the negative of these effects throughout the entire life cycle of a building"**.

Thus, the Green building elements and features considered in this work (based on US EPA 2009; Gregg Kats 2003; Zane et al, 2009, Dalibi, 2012; Vatalisa et al., 2013; greenbuildingsolutions.com; USGBC 2007) as cited by Dalibi et al., 2016 are limited to the following:

- Energy efficiency systems,
- Water efficiency systems,
- Day lighting systems,
- Indoor environmental quality (IEQ) systems,
- The building envelope systems.

3. METHODOLOGY

Secondary sources of data such as journals, conference/ seminar/ workshop papers, text books, newspapers, magazines and the internet etc. were used to review literatures in the green building field which helps identify and narrow few environmentally sustainable passive and active elements in the particular context of Abuja, Nigeria. Such GB elements/ features identified and limited in this work include Energy Efficiency systems, Water Efficiency

systems, Day Lighting systems, Indoor Environmental Quality (IEQ) systems and The Building Envelope systems. Moreover, other sub-elements/ sub-features under these systems were also considered; altogether, they formed the Backbone of the research questionnaire.

A random sampling questionnaire survey (as the primary source of data) was conducted to ascertain the end-users' preferences of green building features using a 5-point Likert scale (Highly preferable=5, Preferable=4, Neutral/ Undecided=3, Less Preferable=2, and not preferable at all=1). Frequency count tables, Mean item score and T-test statistics were used for data analyses.

4. PRESENTATION OF DATA AND ANALYSES

The Primary data for this research work was obtained through manually distributed questionnaires from five hundred Occupants/ End-users from twenty different housing estates and Twenty Estate Developing Firms in Abuja, Nigeria. The result collated was arranged and analysed in Table 1-4 below.

4.1 Results from the Administered Questionnaires

The table below shows the responses from the end-users' preferences and Residential estate developers in Abuja obtained from manually distributed.

Questionnaires	End-users		Developers	
	Frequency	Percentage	Frequency	Percentage
Returned & Usable	500	71.43%	20	71.43%
Non-Returned	192	27.43%	8	28.57%
In-complete	8	1.14%	0	0%
Total of Questionnaire Administered	700		28	

Table 1: The responses obtained from manually distributed questionnaires

Source: Authors' field survey 2016

The table above clearly shows that the total response rate for End-users was 508, out of which 8 were incomplete making the usable number to be 500 or 71.43% which was a very good response rate. Whereas, the response rate of developers was 71.43% which was also very good.

GREEN BUILDING FEATURES	Mean Item Score for End-users	Mean Item Score for Developers	Remark
1 Energy Efficiency			
Solar panels	4.79	5.00	Adoptable
Wind turbines	3.09	1.00	Not Adoptable
DC Inverters	4.82	4.10	Adoptable
Solar-water-heaters	4.50	3.60	Adoptable
2 Water Efficiency			
Grey and Black water systems	2.72	2.35	Not Adoptable
Water saving appliances	4.98	4.80	Adoptable
Rainwater harvest	4.85	4.25	Adoptable
3 Day light			
Clerestories	4.16	4.40	Adoptable
Spectral Glazing	3.12	2.90	Not Adoptable
Solar-tubes	4.14	4.70	Adoptable
4 Indoor Environmental Quality			
Indoor Air Quality	4.60	4.70	Adoptable
Accoustics	4.73	4.85	Adoptable
Adequate Lighting (Artificial-lighting+Nat Lighting)	4.33	4.50	Adoptable
5 Building Envelope	3.62	3.00	can be Adoptable

Table 2: Preferential responses of end-users and developers in Abuja, Nigeria

Source: Authors' field survey 2016

The result of the various mean item scores for each green building feature as shown above were compared to ascertain the features that can be adoptable in GB development projects based on the 5-point Likert scale used (Highly preferable=5, Preferable=4, Neutral/ Undecided=3, Less Preferable=2, and not preferable at all=1). Any mean item score (weighted average) of 3.00 and above indicates that a green building feature can be adoptable.

4.2 Testing of hypotheses

The hypotheses formulated for this research work was tested using T-test statistics. The values for the mean item scores in Table 3 above were used as the data for the statistical computations as shown in the table below.

STAKE HOLDERS	MEAN	STANDARD DEVIATION	N	D F	Tcal	Ttab _{0.05, 13}	Decision
1. END-USERS	4.17	0.72	14	13	6.10	-1.77	Reject Ho, Accept H _A
2. DEVELOPERS	3.87	1.17	14	13	0.199	-1.77	Reject Ho, Accept H _A

Table 3: T- test statistical results
Source: Authors', 2016

With 13 degrees of freedom (DF) and 5% level of significance each, the T-test tabulated ($Ttab_{0.05,13} = -1.77$) is less than T-test calculated for both the end-users and the Developers; as such, the Alternative hypothesis was **accepted; which states that "End-users preferences have potential impact in adopting green building concepts in housing estate development projects in Abuja F.C.T., Nigeria".**

5. CONCLUSIONS

From the limited green building features used in this study (shown in Table 2), it can be observed that both the developers and the End-users Highly preferred, preferred, less preferred and remain neutral on certain green building features in terms of their Preferences and interests in estate development projects in Abuja. This affirms that both shared almost the same preferences regarding the features of green buildings; which is further attested by the T- statistical test by accepting the Alternative hypothesis. The following features as shown in Table 2 above can align the interests of both the stake holders since they were preferred by the end-users and are adoptable by the Developers:

- Solar panels, DC inverters and solar-water-heaters under energy efficiency systems.
- Water saving appliances and rainwater harvest under water efficiency systems
- Clerestories and the use of solar tubes under day-lighting strategies.
- Indoor air quality, acoustics and adequate lighting (artificial lighting + natural lighting) under Indoor environmental quality.
- **The end users are in between "neutral/ undecided" and "agree" regarding building envelope whereas, the developers' are "neutral/ undecided". This indicates that building envelope can also be adoptable**

6. RECOMMENDATION

Estate Developers in Abuja (including other cities in West Africa, the Whole African continent and the world at large) need to conduct or sponsor a lot of researches frequently on end-users requirements, preferences choices, operability, and additional needs in terms of qualitative or high end housing especially Green buildings. This will expose features that will enhance the market value of the housing estates. Other green building features/ components/ elements should also be considered and researched on, so as to expose many features that may align the interests of both stakeholders.

REFERENCES

- [1] Abbaszadeh, S., Zagreus, L., Lehrer, D., Huizenga, C., (2006). Occupant satisfaction with indoor environmental quality in green buildings. Presented at the Proceedings of Healthy Buildings, Lisbon, Vol. 3, pp. 365–370.

- [2] Agha-Hossein, M.M., El-Jouzi, S., Elmualim, A.A., Ellis, J., Williams, M., (2013). Post-occupancy studies of **an office environment: Energy performance and occupants' satisfaction**. *Build. Environ.* **69**, 121–130. doi:<http://dx.doi.org/10.1016/j.buildenv.2013.08.003>
- [3] Akinola, S.R. (1998); The pattern of Housing quality in Osogbo, Osun State, Nigeria. *Ife J. Environ. Des.* (Obafemi Awolowo University, Ile-Ife) 1–2, 109–120.
- [4] Akinyode, B. F & Tareef H.K. (2013). Evaluation of Housing Provision during the last two decades in the context of Nigeria: A case study in Ogbomoso. *International Journal of Humanities and Social Science* 3(15), 204 - 215.
- [5] Armitage, L., Murugan, A., Kato, H., (2011). Green offices in Australia: a user perception survey. *J. Corp. Real Estate* 13, 169 – 180. doi:<http://dx.doi.org/10.1108/14630011111170454>
- [6] Awati K.(2010): Obstacles to project communication. Available at: < <http://www.projectsart.co.uk/obstacles-to-projectcommunication.html> >.
- [7] Berke, P.R., (2002): Does sustainable development offer a new direction for planning? Challenges for the twenty-first century? *Journal of Planning Literature* 17, 21–36.
- [8] Bordass, B. (2011): Built environment professionals in the UK: 40 years back, 40 years on? Keynote lecture in world Sustainable Building (SB) conference, Helsinki.
- [9] Bordass, B. and A. Leaman (2005). "Making Feedback and Post-Occupancy Evaluation Routine 1: a Portfolio of Feedback Techniques." *Building Research and Information* 33(4): 347-352. DOI: 10.1080/09613210500162016
- [10] Building Design and Construction (BD&C), editors. (2003). White Paper on Sustainability: A Report on the Green Building Movement. Building Design and Construction (Supplement).
- [11] Carmona Andreu, Isabel and Tadj Oreszczyn. (2004). Architects Need Feedback on Environmental Performance. Jul-Aug 2004, Vol. 32 (4). *Building Research and Information*.
- [12] City and County of Swansea research and Information Unit. (2012): A 2011 Census: Release of Initial Results. Cited at: http://www.swansea.gov.uk/media/pdf/e/q/2011_Census_Summary_-_Release_of_Initial_Results_Jul-12_CCS_R_I.pdf
- [13] Dalibi, Salisu Gidado, Hadiza Balarabe and Jamilu Bala Mai Auduga (2016); Green Buildings: A Concept aligning the interests of Stakeholders (Developers / Clients and End-users) in Estate Development Projects in Abuja - F.C.T (Federal Capital Territory), Nigeria. SBE16 Hamburg, International Conference on Sustainable Built Environment. 8TH – 11TH March 2016
- [14] **David A. Gottfried and Lynn N. Simon (1996): Sustainable Building Technical Manual; "Green building design, construction and operations", sponsored by the USEPA and USGBC.**
- [15] Demographia (2016): Demographia World Urban Areas (Built Up Urban Areas or World Agglomerations) - 12th Annual Edition, April, 2016. Available at: <http://www.demographia.com/db-worldua.pdf>
- [16] Djebarni, R., Al-Abed, A., (1998). Housing adequacy in Yemen: an investigation into physical quality. *Property Manage.* 16(1), 16–23.
- [17] Ebong, M.O. (1983): The perception of residential quality: a case study of Calabar, Nigeria. *Third World Plann. Rev.* 5 (3), 273 – 285.
- [18] ENSAR Group (2003): Sustainable Federal Facilities Task 2.1 Business Case. November 2002 workshop notes. Boulder, Co.
- [19] EUROSTAT (2011): "Consumption of energy" -Statistics Explained .Available at http://epp.eurostat.ec.europa.eu/statistics_explained/index.php/Consumption_of_energy
- [20] Fenn, P., Lowe, D., Speck, C. (1997): Conflict and dispute in construction. *Construction Management and Economic*, 15 (6), 513–528. <http://dx.doi.org/10.1080/014461997372719>
- [21] Gou, Z., Lau, S.S.-Y., Chen, F., (2012a). Subjective and Objective Evaluation of the Thermal Environment in a Three-Star Green Office Building in China. *Indoor Built Environ.* 21, 412– 422. doi:10.1177/1420326X11419311
- [22] Gou, Z., Lau, S.S.-Y., Zhang, Z., (2012b). A comparison of indoor environmental satisfaction between two green buildings and a conventional building in China. *J. Green Build.* 7, 89–104. doi:<http://dx.doi.org/10.3992/jgb.7.2.89>
- [23] **Greg Kats (2003): "The cost and financial benefits of green building" – A report to California's Sustainable building task force.**
- [24] Helen Sundaram (2012): The fastest growing cities in the world: From Quanzhou to Abuja. Available at <http://www.wordsearch.co.uk/the-fastest-growing-cities-in-the-world-quanzhou-to-abuja/> Posted / 15.11.2012

- [25] Ibem, E.O. (2012); Residents' perception of the quality of public housing in urban areas in Ogun State, Nigeria. *Int. J. Qual. Reliab. Manage.* 29(9), 1000–1018
- [26] Israel, A. A. & Bashiru, A. R. (2008). Public and Private Developers as Agents in Urban Housing Delivery in Sub-Saharan Africa: the Situation in Lagos state. *Humanity and Social Sciences Journal*, 3(2), 143-150.
- [27] Jiboye, A.D., (2010): Feedback on Public Housing Satisfaction in Nigeria. A Practical Approach for Housing Development. LAP Lambert, Germany.
- [28] Jiboye, A.D., Ogunshakin, L., Okewole, I.A., (2005); The socio-cultural dimension of housing quality in Osogbo, Nigeria. *Int. J. Housing Sci. Appl. Coral Gables USA* 29(2), 153–164.
- [29] K.I. Vatalisa, O. Manoliadis, G. Charalampidesa, S. Platiasa, S. Savvidisa (2013): Sustainability components affecting decisions for green building projects. *International Conference on Applied Economics (ICOAE) 2013. Procedia Economics and Finance* 5 (2013) 747 – 756
- [30] Katharine Partridge, Charles Jackson, David Wheeler and Asaf Zohar (2005): **The Stakeholder Engagement Manual. Volume 1: The Guide to Practitioners' Perspectives on Stakeholder Engagement.** By Stakeholder Research Associates Canada Inc.
- [31] Katharine Partridge, Charles Jackson, David Wheeler and Asaf Zohar (2005); **The Stakeholder Engagement Manual; From Words to Action Volume 1: The Guide to Practitioners' Perspectives** on Stakeholder Engagement By Stakeholder Research Associates Canada Inc. First Edition July 2005
- [32] **Lisa Fay Mathiessen and Peter Morris (2004): Costing green: "A comprehensive database and budgeting methodology"**
- [33] Lynda Bourne (2005): Project relationship management and the stakeholder circle. PhD thesis submitted to Graduate school of business, RMIT University Melbourne, Australia.
- [34] **Michael Bauer, Peter Mosle, Michael Schwarz (2007). "Green Building: Guide book For Sustainable Architecture". Springer publications.**
- [35] Nooraeei, M; Littlewood, J.R. Evans, N, I. (2013b): Feedback **from occupants in 'as designed' low-carbon** apartments, a case study in Swansea, UK. *Mediterranean Green Energy Forum MGEF-13. Energy Procedia* 42 (2013) 446 – 455
- [36] Nooraeei, M. Littlewood, J, R. Evans, N, I. (2013a): Passive cooling strategies for multi-storey residential buildings in Tehran, Iran and in Swansea, UK. Paper presented at the 4th International Sustainability and **Energy in Buildings conference (SEB'12), 3rd to 5th September 2012, Stockholm, Sweden.**
- [37] Olayiwola, L.M, Adeleye, O., & Ogunshakin, L. (2005); Public Housing Delivery in Nigeria: Problems and Challenges. *World Congress on Housing Transforming Housing Environments Through the design*, September 27-30, Pretoria South Africa, Vol. XXXIII IAHS.
- [38] Olayiwola, L.M., Adeleye, A., Jiboye, A.D. (2006); Effect of socio-cultural factors on housing quality in Osogbo, Nigeria. In: *International Symposium on Construction in Developing Economies: New issues and challenges*. Santiago, Chile. January, 18–29
- [39] **Peter Morris (2007). "What does Green Really Cost?" PREA QUATERLY**
- [40] Pilkington B, Roach R and Perkins J (2011): Relative benefits of technology and occupant behaviour in moving towards a more energy efficient, sustainable housing paradigm. *Energy Policy*, Vol. 39, No. 9, pp 4962-4970. Cited at: <http://www.sciencedirect.com/science/article/pii/S0301421511004745#>
- [41] PMBOK® 5th Edition (2012): A Guide to the Project Management Body of Knowledge (PMBOK® Guide), 5th Edition 2012 - 2016. By PMI USA
- [42] Saari, A., Tanskanen, H. (2011): Quality level assessment model for senior housing. *Property Manage.* 29(1), 34–49.
- [43] Salisu Gidado Dalibi (2012): Cost Impact Assessment of Green Buildings in China (A Case Study of Few Selected Green Building Projects in Shanghai, China). MSc. Thesis submitted to Hohai University Nanjing – Jiangsu Province of China. -unpublished
- [44] **Salisu Gidado Dalibi (2014): Green Buildings: The Clients' & The End Users' Common Ground in Environmental Sustainability.** Nigerian Institute of Quantity Surveyors (NIQS) National Training Workshop; in Uyo, Akwa Ibom State of Nigeria. 9th – 11th October, 2014.
- [45] Senator Bala Muhammed (2013); Abuja population will rise to 10m in 2018 – FCT Minister. available at <http://nationalmirroronline.net/new/abuja-population-will-rise-to-10m-in-2018-minister/> May 22, 2013
- [46] Shinnick, E. (1997): Measuring Irish housing quality. *J. Econ. Studies* 24 (1/2), 95–119.
- [47] Stevenson, F. And Rijal, H. (2008): The Sigma Home: towards an authentic evaluation of a prototype building. *PLEA 2008 – 25th Conference on Passive and Low Energy Architecture*, Dublin, 22nd to 24th October 2008.

- [48] **Thatcher, A., Milner, K., 2012. The impact of a “green” building on employees’ physical and psychological wellbeing.** *Work J. Prev. Assess. Rehabil.* 41, 3816–3823. doi:10.3233/WOR- 2012-0683-3816
- [49] Todd, S. (2007); *Urban Housing Demand*, prepared for the new Palgrave Dictionary of Economics. University of Pennsylvania (Wharton) and NBER, Edited version, March 8.
- [50] U.S. Environmental Protection Agency. (2009): *Green Building Basic Information.* at <http://www.epa.gov/greenbuilding/pubs/about.htm> Retrieved December 10, 2009.
- [51] URL: www.greenbuildingsolutions.com
- [52] URL: en.wikipedia.org/wiki/Abuja. “the global encyclopedia”
- [53] USGBC (2007): *A NATIONAL GREEN BUILDING RESEARCH AGENDA* November, 2007.
- [54] WECSI (2014); *World Engineering Conference on Sustainable Infrastructure*, November 2014, Abuja-Nigeria. Available at: http://www.wecsi2014.org/About_Abuja.php
- [55] Wilkinson, S.J., Kallen, P.V.D., Kuan, L.P., (2013): *The Relationship between the Occupation of Residential Green Buildings and Pro- environmental Behavior and Beliefs.* *J. Sustain. Real Estate* 5.
- [56] Zalejska-Jonsson, A., (2012). *Evaluation of low-energy and conventional residential buildings from occupants’ perspective.* *Build. Environ.* 58, 135–144.
- [57] Zane Satterfield, P. E.(2009); *Tech Brief On Green Building*, Published By: The National Environmental Services Centre (Winter 2009), Vol. 8, Issue 4 Tech Briefs

Project Management Strategies for Green Business Parks: Critical Success Factors, Barriers and Solutions

HWANG Bon-gang^a, ZHU Lei^b, Joanne TAN Siow-hwei^c, CHI Seokho^d, SHAN Ming^e

^a National University of Singapore, Singapore, Singapore, bdghbg@nus.edu.sg

^b National University of Singapore, Singapore, bdgzl@nus.edu.sg

^c Jones Lang LaSalle Property Consultants, Singapore, joanne.tansh@ap.jll.com

^d Seoul National University, South Korea, shchi@snu.ac.kr

^e National University of Singapore, Singapore, bdgsm@nus.edu.sg

ABSTRACT

Green Business Parks (GBPs) as a way of achieving more sustainable industrial and business development are getting increasing interest from both public and private sectors. However, there have been few studies identifying the project management strategies for such projects. In light of this, the objectives of this study are to: (1) identify the critical success factors (CSFs) for GBPs; (2) investigate and assess the barriers hindering the adoption of GBPs; and (3) propose feasible solutions to overcome the barriers. To achieve the objectives, 30 CSFs, 15 barriers and 21 solutions were identified from a comprehensive literature review and then a questionnaire survey and post-survey interviews were conducted. The analysis results first reported that the top three CSFs were “strong top management support”, “strong financial capability” and “adequacy of design details and specifications”, while “perceived higher initial capital cost”, “uncertain trade-off between environmental and financial benefits” and “lack of government supports” were revealed as the top three barriers. The analysis also indicated that “better government funding” and “clients’ advocacy of green management goals” were most feasible solutions to improve the potential adoption of GBPs. This study not only fills the gap in the knowledge area of the project management of GBPs but also points out the right directions for the practitioners to successfully adopt GBPs and ultimately achieve more sustainable developments.

Keywords: green business parks, critical success factors, barriers, solutions

1. INTRODUCTION

The sustainable development of the industrial and business sectors would lead to the great and efficient reduction of global greenhouse gas (GHG) emissions since industrial and energy sectors together are responsible for a major share of GHG emissions. According to Eurostat (2016), nearly half (45.4%) of all GHG emissions in the EU in 2013 were from the activities of electricity, gas, steam and air conditioning supply (26.6%) and the activities of manufacturing sector (18.8%). Together with the increasing developments of green buildings, Green Business Park (GBP), which is a way to create sustainable industrial and business development, has attracted a great attention from public and private sectors. GBP was defined as a hybrid concept between the agglomeration of conventional industry and green buildings (Stewart, 2007). Industrial ecology, eco-industrial park (EIP), industrial ecosystem and by-product exchange are complementary terms of GBP. Numerous Green Business Parks (GBPs) have been developed all over the world. For instance, until early 2001, at least 40 communities in the US initiated eco-industrial development projects (Lowe, 2001). Singapore and China have also launched the highly-specialized business parks such as CleanTech Park (CTP) (Green Business Singapore, 2013) and Sino-Singapore Tianjin Eco-City (SSTEC) (Flynn, 2012).

However, it is also true that the implementation of this concept is still at an early stage and encounters different kinds of difficulties (Gibbs, et al., 2005). Furthermore, the current research focuses just on definitions, benefits, drivers and limitations of GBPs through some case studies, and there have been very few studies focusing on the project management framework for GBPs. As a result, this study aims to: (1) identify the critical success factors (CSFs) for GBPs; (2) investigate and assess the barriers hindering the adoption of GBPs; and (3) propose feasible solutions to overcome the barriers. This study not only fills the gap in the project management knowledge area of GBPs but also points out the right directions for the practitioners to successfully adopt GBPs and ultimately achieve more sustainable developments.

2. BACKGROUND

Green Business Park has the root in industrial ecology or industrial ecosystem (Stewart, 2007). An industrial ecosystem was defined as a system in which “the consumption of energy and material is optimized, waste generation is minimized, and the effluents of the process serve as the raw material for another process” (Frosch and Gallopoulos, 1989). The early GBPs were called eco-industrial parks (EIPs) whose functioning was described as “applied industrial ecology” (Stewart, 2007). GBP is the hybrid of green buildings and EIPs (Stewart, 2007) and emphasizes the clustering of specialized industries by providing shared infrastructure and facilities (Tudor, et al., 2007).

The developments of GBPs attempt to achieve economic, social and environmental benefits, concurrently. First, GBPs have the potential to reduce operating costs, disposal costs and increase the income from the sale of by-products. For example, Mobil which is a park in the United State sold styrene to a recycler for 50 cents a gallon whereby previously it had to pay 1.00 USD per gallon for disposal (Stewart, 2007). Moreover, GBPs lead to a more rooted business, good jobs and a cleaner environment. GBPs are also designed to relieve the environmental pressure by promoting the closing of material cycles (Heeres, et al., 2004).

Critical success factors (CSFs) help to achieve predetermined goals and are indisputably necessary for the success of projects (Chan, et al., 2004). Through an intensive literature review on CSFs for the conventional business park, EIPs and green building projects, this study identified 30 CSFs (Table 1) which have the potential to influence the success of GBPs. Through the literature review, this study also identified 15 barriers (Table 2) having the potential to impede the development of GBPs.

3. DATA COLLECTION PRESENTATION

This study carried out a questionnaire survey to solicit opinions from experts. After developing a questionnaire based on a comprehensive literature review, this study conducted a pilot survey with three construction industry experts before finalizing the questionnaire. The first part of the questionnaire included the questions meant to profile the companies and respondents. Moreover, the questionnaire presented the 30 CSFs, 15 barriers and 21 proposed solutions. The respondents were subsequently asked to assess the criticalities of CSFs, significance of barriers and usefulness of solutions with a five-point scale. Taking the rating of CSFs as an example, “1” indicates “least critical” while “5” means “most critical”. Finally, post-survey interviews were conducted with four experts who were either BCA certified Green Mark Managers (GMMs) or Green Mark Professional (GMPs) to validate the survey results. In post-survey interviews, the experts were provided with the analysis results and they all confirmed that the findings were reasonable and consistent with their expectations.

This study randomly sent out 124 sets of the questionnaire to professionals who are GMMs or GMPs, and 40 completed questionnaires were finally returned. The majority of the respondents (92.5%) had more than two years' experience in green building projects. Moreover, 85% and 57.5% of respondents had the working experience in commercial projects and industrial/business park, respectively. Furthermore, 65% and 32.5% of companies had the business background in green commercial/retail projects and industrial/business park, respectively.

4. ANALYSIS RESULTS AND DISCUSSIONS

4.1 Criticalities of CSFs of GBPs

This study first analysed the criticality of each CSF by adopting methods including descriptive means and one sample t-test (confidence level = 95%; p-value = 0.05). The criticality rankings and test results are summarized in Table 1.

“Strong top management commitment and support” (C06) was ranked first (mean = 4.75) due mostly to the importance of the upper management providing the necessary support and stipulating right policies. Moreover, without adequate and timely support from the top management, the project team will be less productive in completing their duties because of the inefficient access to organizational resources (Alexandrova and Ivanova, 2012). This is even more critical for GBPs because additional workloads are needed to achieve green requirements.

“Strong financial capability” (C07) was ranked second (mean = 4.63). As a property development, a GBP should first meet the business and financial objectives. As a good example, in case of Kalundborg EIP, each business link in the system was negotiated as an independent business deal, and was established only if it was expected to be economically beneficial (Maxwell, et al., 2015). Moreover, as green developments tend to be discouraged by the perceived high initial capital costs (Houghton, et al., 2009), some financial initiatives, such as public private partnerships, can be also considered to maximize financial capability in such developments (Lowe, 2001). The strong financial capability was also emphasized by the post-survey interviewees as a key success factor for GBPs.

Factor Category	F-Code	List of Factors	Mean	p-value	Rank
External Factors	E01	Economic development strategy	4.38	0.00	12
	E02	Extensive government support (such as funding, schemes for workforce training)	4.50	0.00	7
	E03	Preferential policies, e.g. tax exemptions, technical training and standards setting	4.48	0.00	9
	E04	Strong demand from local and foreign companies and the existence of clustering companies	4.33	0.00	16
	E05	Planning guidelines for business parks to be mutually beneficial	4.23	0.00	20
Client Related Factors	C06	Strong top management commitment and support	4.75	0.00	1
	C07	Strong financial capability	4.63	0.00	2
	C08	Ability to convey project objectives and goals clearly	4.55	0.00	4
	C09	Realistic and well-planned project schedule and proper allocation of resources	4.45	0.00	10
	C10	Moderate variation orders during construction	3.68	0.00	28
	C11	Ability to arrange for autonomous management or private park ownership	3.68	0.00	29
Project Team Related Factors	PT12	Competency of project manager	4.53	0.00	6
	PT13	Ability to develop good relationship and continuous communications between teams and stakeholders	4.33	0.00	15
	PT14	Strong commitment and involvement of project team	4.38	0.00	13
	PT15	Technical competency, experience and knowledge of project teams in developments	4.48	0.00	8
	PT16	Effective risk management	4.03	0.00	24
	PT17	Pro-active management continuously evaluating park performance	4.13	0.00	23
	PT18	Competency of facilities management team's response to tenant issues during operations	4.28	0.00	19
Project Consultant Related Factors	CS19	Competency of project consultants	4.53	0.00	5
	CS20	Involvement of Green Mark Managers/Professionals	4.38	0.00	14
	CS21	Strong cooperation in solving problems	4.30	0.00	17
	CS22	Effective marketing of the business park	4.30	0.00	18
Project Contractor Related Factors	CT23	Adequacy of design details and specifications	4.60	0.00	3
	CT24	Emphasis on high-quality workmanship	4.40	0.00	11
	CT25	Skillful workers with adequate trainings in Green Projects	4.20	0.00	21
	CT26	Using advanced technology and automation for construction work	3.70	0.00	27
Project Related Factors	D27	Selection of prime location	3.75	0.00	25
	D28	Provision of enabling environment E.g. restaurants, leisure park and right infrastructure	3.55	0.01	30
	D29	Provision of park design with flexibility and allowance for future expansion	3.75	0.00	26
	D30	Design of buildings to fulfill standardization, simplicity and constructability	4.18	0.00	22

Table 1: Summary of criticality ranking of CSFs

“Adequacy of design details and specifications” (CT23) was ranked third (mean = 4.60). This result could be contributed by the requirements of additional green features and the compliance of green regulations or standards which can be achieved partially through the adequate design and specifications (Lam, et al., 2010). It is better for a contractor to have their own green design and construction team; otherwise, the cost and schedule of a green development would be affected (Samari, et al., 2013). Moreover, experts in the post-survey interviews also suggested that setting standardized design guidelines should be crucial to the success of GBPs. For instance, setting parcel design guidelines in the development of CleanTech Park in Singapore helped the owners to attain a minimum Green Mark Gold rating (Green Business Singapore, 2013).

4.2 Significance of barriers

This study analyzed the significance of the barriers by using methods explained previously, and the results are summarized in Table 2.

Barrier Category	B-Code	List of Barriers	Mean	P-value	Rank
External barriers	B01	Imperfect government regulations	3.80	0.00	4
	B02	Adjustment of functions and changing roles of parks	3.38	0.08	7
	B03	Lack of strategic location due to the scarcity of land	3.10	0.55	11
	B04	Lack of government supports such as funds and tax exemptions	3.83	0.00	3
Client related Barriers	B05	Perceived higher initial capital costs	4.40	0.00	1
	B06	Lack of potential clients' awareness and demand	3.80	0.00	5
	B07	More variance in project deliveries leading to a higher risk level	3.05	0.79	13
	B08	More variance in site practices leading to a higher risk level	2.95	0.76	14
	B09	Unequal distribution of advantages between developers and tenants	3.08	0.68	12
Project team barriers	B10	Uncertain trade-off between environmental and financial benefits	4.05	0.00	2
	B11	Lack of skilled labor in respect of green developments or GBPs	3.15	0.46	10
Consultants barriers	B12	Lack of marketing and promotion	3.20	0.34	8
Contractors barriers	B13	Lack of the effective coordination between key players	3.18	0.32	9
Project barriers	B14	Complexity in obtaining green certifications	2.70	0.08	15
	B15	Lack of proven benefits to entice potential investors	3.78	0.00	6

Table 2: Summary of significance ranking of barriers

Except **“more variance in site practices leading to a higher risk level” (B08)** and **“complexity in obtaining green certifications” (B14)**, the means of the other barriers were all statistically greater than three. Among these barriers, **“perceived high initial capital costs” (B05) was ranked first (mean = 4.40). Just like green building developments,** the developments of GBPs were overwhelmingly discouraged by the perceived high capital costs (Hwang and Tan, 2012; Samari, et al., 2013). **From a developer’s perspective, sustainable developments require the city incentive and government support unless there is a sufficient demand for sustainable developments in the market (Maxwell, et al., 2015).** All post-survey interviewees also agreed with this result.

“Uncertain trade-off between environmental and financial benefits” (B10) was ranked second (mean = 4.05). Currently, there are some difficulties to concretely demonstrate positive environment impacts and financial benefits. Gibbs, et al. (2005) disclosed one reason that there were relatively very few EIP sites which were engaged in measuring energy flows and exchanges. On the other hand, some intangible benefits, such as the increased productivity of staff working in green buildings, were difficult to measure and transfer to financial benefits (Reichardt, 2015). The interviewees in the post-survey highlighted that unbiased independent case studies which could clearly show the trade trade-off are urgently needed.

“Lack of government supports” (B04) received the third position (mean = 3.83). As GBPs are at the preliminary stage, governments play a vital role to promote such developments. Gibbs, et al. (2005) investigated 61 eco-industrial projects in USA and Europe and identified that over 40% of these projects had a lead partner who was local or municipal authority. Singapore has actually initiated some funding and several incentive schemes related to the energy efficiency and clean energy such as Energy Efficiency Improvement Assistance Scheme (EASe) and Grant for Energy Efficient Technologies (GREET) (Green Future Solutions, 2015). However, the industrial practitioners may not be familiar with these funding and incentive schemes since they still thought there was a lack of government supports.

4.3 Feasible solutions for overcoming barriers

This study also identified and provided a list of solutions to be able to overcome the barriers for the respondents to choose the best measures that can tackle the barriers. The frequencies (Freq.) and percentages (Per.) of the respondents who chose particular solutions for each of the barriers are tabulated in Table 3. For the sake of the length of the paper, solutions for barriers B08 and B14 were excluded because they were not statistically significant as discussed above. Moreover, except the solutions for the top three barriers (B05, B10 & B04), the solutions with Per. < 50% were also excluded from Table 3.

“Minimize variations order during construction to avoid delays by having efficient management” was suggested to overcome the high initial capital costs and the lack of potential clients’ awareness and demand for GBPs (B05&B06). However, the low percentage (32.5%) indicated that it is not a useful solution. The interviewees in the post-survey commented that the high initial costs were mainly due to the difficulties in the establishment of interlink between companies, the requirements of additional green features and compliance of green regulations or standards. These could be properly maintained at the planning and design stage but not the construction stage.

As for the clients’ perception of the uncertain trade-off between environmental and financial benefits (B10), 55% of respondents felt that the collaboration with research institutes and firms to study and highlight the long-term social and cost benefits can help to overcome the barrier. This solution aims to get more clients’ advocacy of green management goals. Furthermore, 80% of respondents felt that the government support, such as the increase in the scope of co-funding and the incentives for trainings and technologies were needed. Moreover, the government could also found some supporting structures like the training center or technology research center to educate the practitioners or the public.

Barriers	List of Solutions	Frequency	Percentage
B01	Policies and regulations for green industrial spaces to be structured in a supportive manner, such as flexible planning guidelines, tax exemptions and privileged permits with short time approval	30	75.0%
B03&B04	Government to increase the scope of co-funding and incentives for trainings and technologies	32	80.0%
B05&B06	Minimize variations orders during construction to avoid delays by having efficient management	13	32.5%
B09&B10	Relevant statutory boards to collaborate with research institutes and firms to study and highlight the long-term social & cost benefits in order to promote GBPs to the industrialists	22	55.0%
B11	Select qualified team members with specialized skill and provide proper trainings	25	62.5%
	To include at least one Green Mark Professional/ Green Mark Manager in the project	25	62.5%
	Encourage team to explore compliance requirement under specific standards together with other consultants during planning phase	27	67.5%
B12	Provide trainings for staff to understand such specialized facilities in order to manage them well during operation phase	24	60.0%
	Consultants should provide full cooperation to contractor/ client when their expertise are required	26	65.0%
	Strong communicate with the client promptly to avoid misinterpretation	25	62.5%

B13	Provide proper planning and scheduling during construction to ensure efficient allocation of resources and time to avoid cost overrun and disputes	20	50.0%
	Contractors who are specialized in green design and technologies can increase investors' interest by offering some form of indemnification for certain conditions	20	50.0%
B15	Permit authorities should work collaboratively with project teams to ensure specifications of project design are aligned with the criteria for certifications	22	55.0%

Table 3: Summary of suggested solutions for overcoming barriers

5. CONCLUSIONS AND RECOMMENDATIONS

This study aimed to identify project management strategies for Green Business Parks by investigating critical success factors, significant barriers and useful solutions. To achieve the objectives, 30 CSFs, 15 barriers and 21 solutions were identified from a comprehensive literature review. Having conducted a questionnaire survey, “strong top management support”, “strong financial capability” and “adequacy of design details and specifications” were reported as the top three CSFs. Moreover, “perceived higher initial capital cost”, “uncertain trade-off between environmental and financial benefits” and “lack of government regulations” were revealed as the top three barriers. The analysis also indicated that “better government funding” and “clients’ advocacy of green management goals” were most feasible solutions to improve the potential adoption of GBPs. This study not only fills the gap in the project management knowledge area of GBPs but also points out the right directions for the practitioners to successfully adopt GBPs and achieve more sustainable developments. Future studies could focus on the long-term social and cost benefits of GBPs increasing the clients’ interest and demand of GBPs.

REFERENCES

- [1] Alexandrova, M., and Ivanova, L., 'Critical success factors of project management: empirical evidence from projects supported by EU programmes', Proc., 9th International ASECU Conference on “Systematic Economic Crisis: Current Issues and Perspectives”, Skopje, Macedonia.
- [2] Chan, A. P. C., Scott, D., and Chan, A. P. L., 2004. Factors affecting the success of a construction project. Journal of Construction Engineering and Management, 130(1), 153-155.
- [3] Eurostat, 2016. Greenhouse gas emissions by industries and households. Retrieved from:<http://ec.europa.eu/eurostat/statistics-explained/index.php/Greenhouse_gas_emissions_by_industries_and_households> [Retrieved on 09.05.2016].
- [4] Flynn, A. (2012). "Eco-City in China." Cardiff University, U.S.A, 4.
- [5] Frosch, R. A., and Gallopoulos, N. E., 1989. Strategies for manufacturing. Scientific American, 261(3), 144-152.
- [6] Gibbs, D., Deutz, P., and Proctor, A., 2005. Industrial ecology and eco-industrial development: A potential paradigm for local and regional development? Regional Studies, 39(2), 171-183.
- [7] Green Business Singapore, 2013. Eco-business park CleanTech One officially opens. Retrieved from:<<http://www.greenbusiness.sg/tag/cleantech-park/>> [Retrieved on 21.04.2016].
- [8] Green Future Solutions, 2015. 2015 Guide to Singapore Government Funding and Incentives for the Environment. Retrieved from:<<http://www.greenfuture.sg/2015/02/16/2015-guide-to-singapore-government-funding-and-incentives-for-the-environment/>> [Retrieved on 28.06.2016].
- [9] Heeres, R. R., Vermeulen, W. J. V., and De Walle, F. B., 2004. Eco-industrial park initiatives in the USA and the Netherlands: First lessons. Journal of Cleaner Production, 12(8-10), 985-995.
- [10] Houghton, A., Vittori, G., and Guenther, R., 2009. Demystifying first-cost green building premiums in healthcare. HERD, 2(4), 10-45.
- [11] Hwang, B. G., and Tan, J. S., 2012. Green building project management: Obstacles and solutions for sustainable development. Sustainable Development, 20(5), 335-349.
- [12] Lam, P. T. I., Chan, E. H. W., Poon, C. S., Chau, C. K., and Chun, K. P., 2010. Factors affecting the implementation of green specifications in construction. Journal of Environmental Management, 91(3), 654-661.
- [13] Lowe, E. A., 2001. Eco-industrial park handbook for Asian developing countries. Indigo Development, Oakland, CA.

- [14] Maxwell, E., Foley, M., Braman, J., Sopeth, J., and Marty, R. (2015). "Rosemount Eco-Green Business Park Feasibility Study." University of Minnesota, U.S.A.
- [15] Reichardt, A., 2015. Sustainability in Commercial Real Estate Markets. Springer.
- [16] Samari, M., Godrati, N., Esmaeilifar, R., Olfat, P., and Shafiei, M. W. M., 2013. The investigation of the barriers in developing green building in Malaysia. *Modern Applied Science*, 7(2), 1-10.
- [17] Stewart, G. (2007). "Green Buildings & Green Business Parks: Striving for Sustainability through Design & Operations." Environment Bay of Plenty & AQUAS Consultants Ltd., Tauranga, New Zealand, 66.
- [18] Tudor, T., Adam, E., and Bates, M., 2007. Drivers and limitations for the successful development and functioning of EIPs (eco-industrial parks): A literature review. *Ecological Economics*, 61(2-3), 199-207.

Smart, Green + Productive Workplace

Simone SKOPEK^a, Jiri SKOPEK^b

^a JLL, Canada, simone.skopek@am.jll.com

^b JLL, Canada, jiri.skopek@am.jll.com

ABSTRACT

The desire by corporate occupants to be green, to be seen as green, and to shave costs is changing the way they **manage their corporate real estate portfolios. Until now, there have been few 'greening' metrics for building occupants.** Also it has been difficult to motivate occupants – particularly those in leased spaces – to change their behaviours. Consequently, despite green certifications for so-called **'trophy buildings', there has been virtually no broad market transformation.**

In an age of fierce competition, the greatest driver of change in the workplace is the need to create an environment where ideas can flourish and be turned into business advantage. This means creating a workplace where a corporate culture finds its fullest expression, and where employees feel comfortable, inspired and connected. This paper describes a portfolio methodology that addresses sustainability with workplace comfort and productivity, and which is designed from the user-perspective. The paper touches on how smart building technologies are already **accelerating the convergence between 'green' and 'productive'.**

Keywords: corporate social responsibility, productivity, wellness

1. INTRODUCTION

This paper outlines some reasons that green assessments and certifications are not getting the broad penetration needed to transform corporate real estate; and describes an approach that is more likely to achieve that goal. Green + Productive Workplace, (G+P) is an assessment that targets a particularly challenging segment of the industry: corporate real estate occupants in leased and owner-occupied spaces.

The fact that buildings account for almost 20% of climate change emissions has given rise to certifications such as LEED, BREEAM, Living Building Challenge and many others. These have transformed our understanding of green building design and operations but they have not transformed the industry as a whole. Certified buildings account for less than 1% of building stock – and only about 2 out of ten thousand existing buildings. With a growing body of knowledge and increasingly sophisticated technologies, the certifications become more refined and generally more rigorous. Meanwhile, 99.98% of buildings do not undergo any environmental certification at all. Consequently, the bar gets higher and higher, but for few players. It is therefore time to rethink green assessments and address what we know to be the problems: cost, point-chasing, prescriptive requirements and prerequisites that often need **'interpretation', and complex** submittals and certification protocols.

Reinventing Green Building [1]. by Jerry Yudelson recommends an approach that could be more effective in transforming the mainstream: simplicity without sacrificing rigor, and implementation that is designed from the **user's perspective** – affordable, strategic, focused on continuous improvement and the bottom line. Yudelson talks about one tool that does this: Green + Productive Workplace (G+P). As its name suggests, the objective of G+P is to green the workplace and make it healthy, comfortable and productive. It is for corporate portfolios of leased and owner-occupied facilities – which is one of the most challenging areas when it comes to sustainability in real estate.

2. OCCUPANTS MORE INTERESTED IN PRODUCTIVITY BUT REALIZE THAT THEY MUST ALSO BE GREEN

Office fit-outs and occupant behaviour have a significant impact on building performance, but there have been few metrics for building occupants. Also it is challenging to motivate occupants to adopt sustainability best practices because the value proposition of recycling or energy savings programs pale in comparison to the value proposition of adding features that will improve employee productivity and corporate branding.

Sixty eight percent of global Corporate Real Estate (CRE) executives have alluded to increasing business demand to enhance productivity and 65% have confirmed the need to transform the quality of the workplace – according to **Jones Lang LaSalle's recent Global Corporate Real Estate (CRE) Trends report**, based on a survey of over 630 global CRE executives [2]. The interest in workplace productivity is in response to the accelerated pace of innovation and marketplace flux, which are driving competition in every sector of the global economy. To address these business challenges, the workplace is changing: employees are more digitally connected and mobile; more are telecommuting; and a growing proportion of employees are short-term, contract workers. These factors make it difficult to predict head-count, which is part of the reason that the majority of businesses are adopting an open office environment, with hoteling work stations and an abundance of flexible, common space.

There is also a growing movement to implement features and management operations to support wellness in the workplace.

Meanwhile, there is a perception that a green office is by definition more comfortable and productive. Occupants are drawn to the concept of being in a green building as these tend to be high profile, interesting and attractive. However, one study of the greenest buildings in Australia showed that almost three quarters of occupants in green-certified buildings said that they did not feel any healthier or more productive [3]. One of the benefits of an open office concept is that it supports team collaboration – which is essential to bring new ideas to market. The reality though, is that not all tasks require collaboration, and there are certain features of an open office that many occupants find distracting. The survey of green Australian buildings showed that three things that occupants liked about a green office were: daylight, views and an open layout. The three things which many disliked were: noise, thermal discomfort and lack of personal privacy [4]. A plethora of studies, using many different productivity performance indicators all concur that taking corrective action where there are acoustic, thermal, lighting/daylighting, and air quality problems can have a significant impact on occupant productivity. The findings of many of these studies are summarized in the IFMA Foundation compendium called Applying what scientists know about where and how people work best. [5]

The reason to juxtapose sustainability and productivity is that many features in an office should be examined **through both lenses. For example, daylighting can be a 'green' energy efficiency feature as well as being good for productivity.** However, too much window is not green, and in some cases, can hinder productivity. Heating, cooling and ventilation have an important energy aspect. However, saving energy for HVAC can affect thermal comfort and indoor air quality. The premise of Green + Productive is that every workplace should strive to be both – green AND productive. The goal of G+P is to align criteria that either reinforce one another, or are in opposition, or must achieve a balance. This is consistent with the concept of a high performance building: one that is energy efficient and has a high rate of perceived indoor environment acceptability.

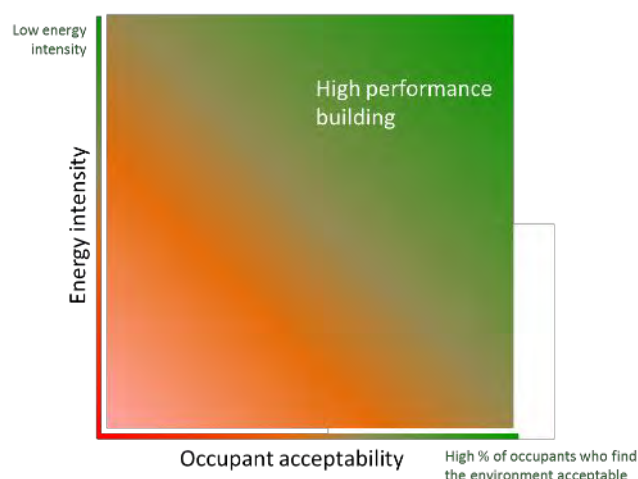

Figure 1: High performance building

Because corporate occupants know that they need to be green (and be seen as green) as part of their corporate social responsibility, the G+P strategy is to align greening of the workplace with the productivity agenda. As smart buildings transform the way occupants interact with buildings, there is now a stronger direct link between occupants

and operations. For example, smart building energy management systems can schedule lighting and air conditioning systems to turn on/off based on peak and off-peak occupancy periods and in response to occupant controls. In a building with multiple tenants, each organization's energy usage can be calculated precisely, in real time, and charged to the respective financial departments. This motivates tenants to examine how they are using energy, and better manage it, for example through a better allocation of space and scheduling. The convergence of 'green' and 'productive' aspects, which is accelerating thanks to smart building technologies, is driving the need to integrate the roles of corporate real estate management (CRE), IT, human resources, and communications to align decision-making with respect to: space planning and management, wellness, and sustainability.



Figure 2: Convergence between 'green' and 'productive'

3. G+P IS DESIGNED FROM THE USER PERSPECTIVE

To achieve a broad penetration, an assessment should be designed with the user experience in mind. An asset manager who wants to optimize their portfolio and make the best use of resources needs to be strategic. That's why G+P takes a portfolio approach, and addresses offices that are owner-occupied and/or leased, and/or contemplating a retrofit. Taking a strategic portfolio approach makes it possible to measure improvement from year to year, recognize and reward top performers, and focus resources where they are most needed. Some portfolios may consist of just one or two offices. Others may be large. For global portfolios, questions are regionally designed to address different standards and references for the Americas, Europe and Asia-Pacific.

Part of an effective portfolio approach is to document and clearly communicate certain portfolio-wide policies. Therefore, part of the G+P assessment is a section called Corporate Leadership. This section is short (less than 15 minutes) but it helps a portfolio manager to review how committed the organization is with respect to: portfolio-wide policies related to greening and wellness; public disclosure of energy, carbon water and waste; as well as directives and specific roles of various members of the organization: business unit managers, facility managers, green teams, employees, Human Resources and IT.

Once the Corporate Leadership section has been completed, the next step is to complete an assessment of each office in the portfolio. The assessment is designed to be done – not by consultants – but by the facility managers (FMs). Because they know more about the offices than anyone and are responsible for ongoing improvements, Facility Managers should therefore 'own' the process. However, there are concerns within the industry that FMs are facing an ever increasing workload. With this in mind, the G+P process is designed to be streamlined and simple: Each facility manager is given a login. Navigation of the site is self-explanatory; the G+P survey itself takes only 45 minutes; questions are clearly worded; responses are graduated; and pop-up tips define terms, explain concepts and describe the verification criteria.

The output is an individual report for each site and a portfolio report which includes an Executive Summary for the C-suite. The Executive Summary presents site scores, an industry comparison, and a thumbnail description of the 'red flag' issues for each site.

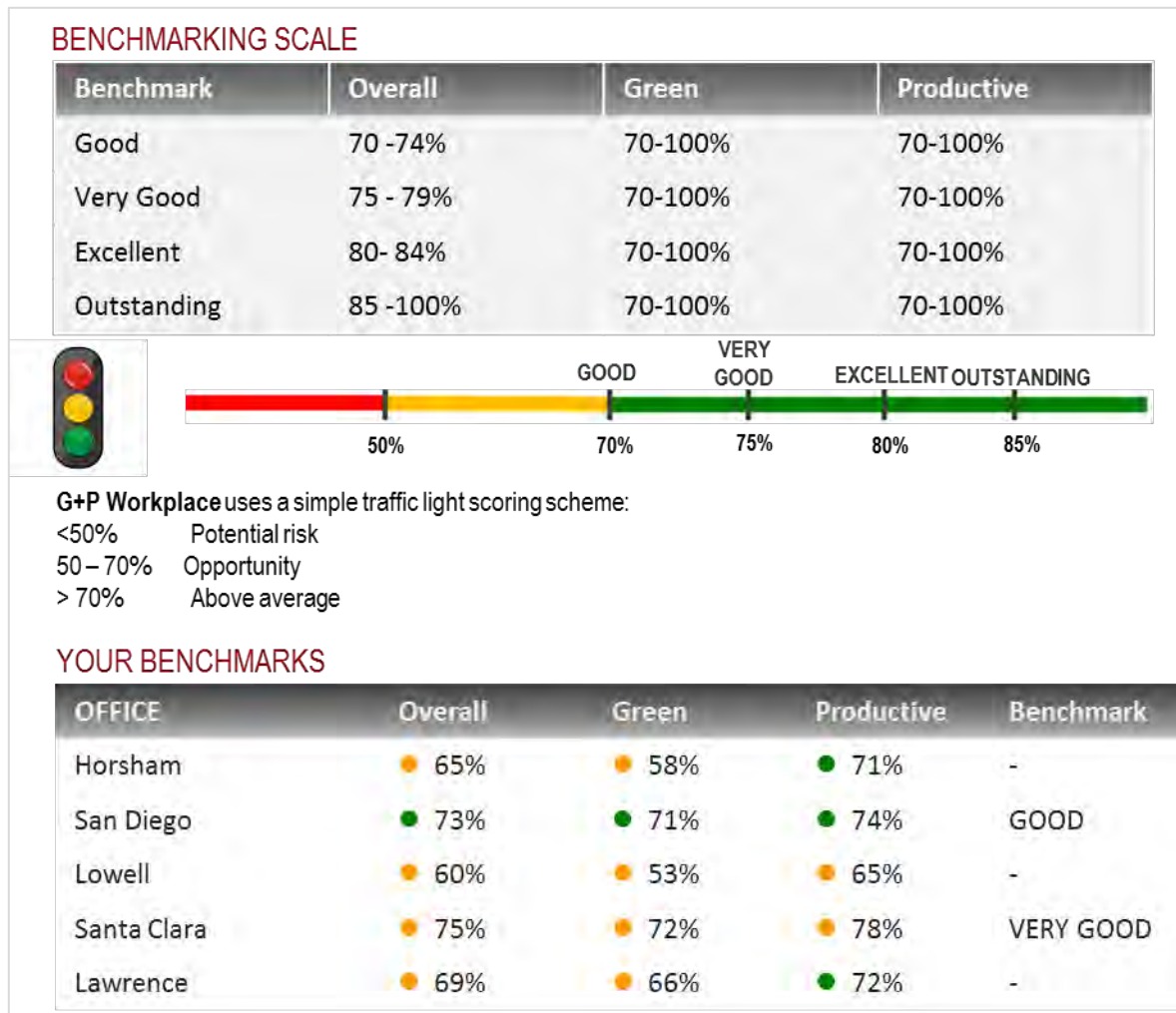

Figure 3: G+P benchmarking for a portfolio

Taking the user perspective, costs are a huge consideration: the cost of the assessment, the cost of certification and the cost and benefits of taking measures to make a portfolio more green and productive. The pricing scheme of G+P is designed to be affordable for entire portfolios, so that time and resources may be focused on improving the portfolio rather than creating endless submittal documentation.

For offices that wish to obtain third party verification, the process consists of on-site measurements and a review on actual in-use documentation – versus documentation that has been prepared expressly for the purpose of a verification, and which then typically sits on a shelf gathering dust.

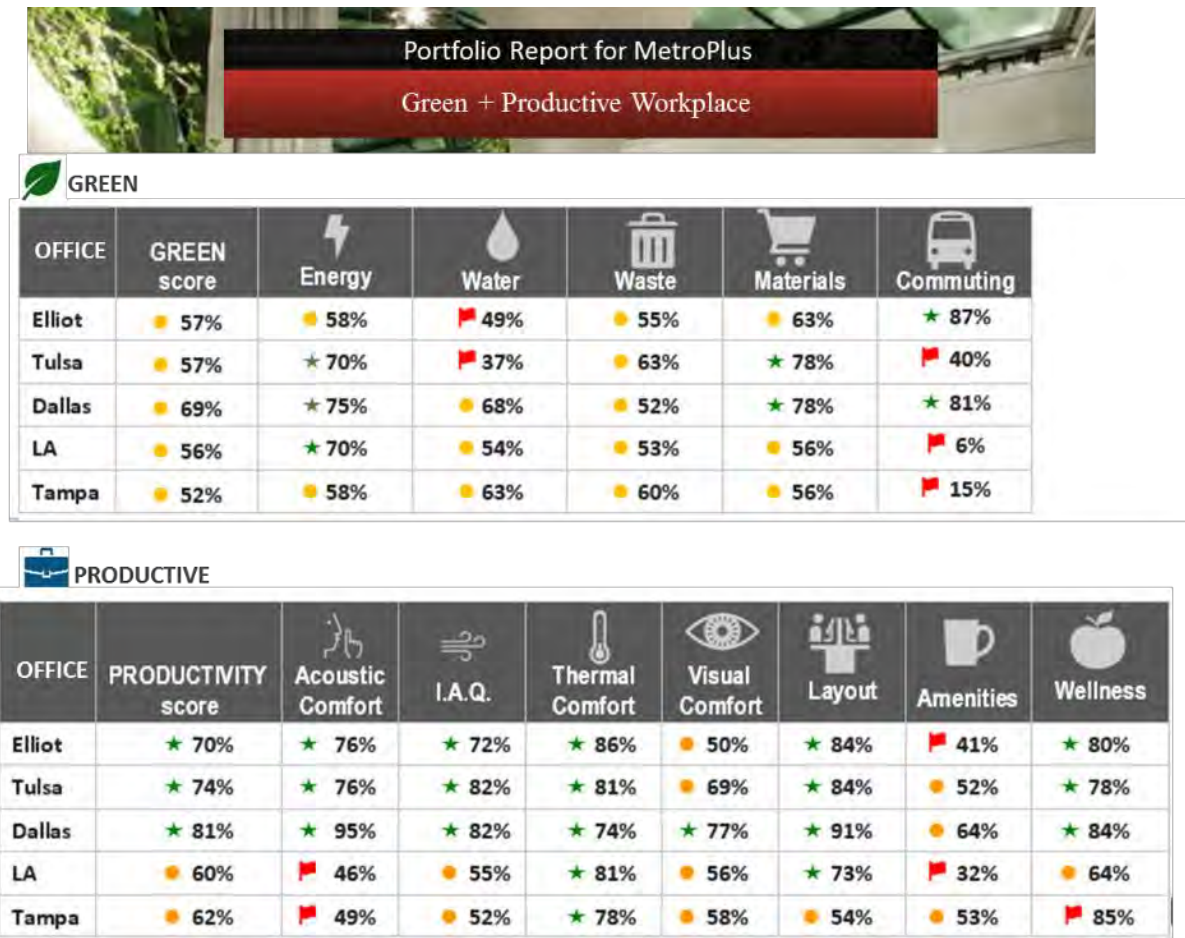

Figure 4: Excerpt of a G+P portfolio report

Part of the strategic approach is to also to identify where to invest resources. G+P provides a high level financial estimate of wasted energy and lost productivity. These calculations are based on conservative assumptions and produce values that are not intended to be precise, but which give orders of magnitude. For asset managers, these can be red-flags, which indicate the need for some further investigation such as detailed measurements or occupant surveys to determine the exact nature and extent of problems and the corrective action needed.

G+P recognizes and rewards high performance using a benchmarking system with the main focus being on continuous improvement. It benchmarks performance by comparing offices, within a portfolio, and by providing an anonymous industry comparison, with all of the offices in the G+P data base. It also offers a comparison with past performance for the portfolio and for individual offices.

One of the challenges of assessments is to make them meaningful to the decision-makers – the ones who control the purse-strings, and who often don't see beyond the marketing value of green building certification. When a portfolio manager is able to show bottom line benefits of improved productivity, demonstrate that there is corporate leadership and a portfolio strategy for continuous improvement – then there is a greater chance of getting the attention and the needed resources.

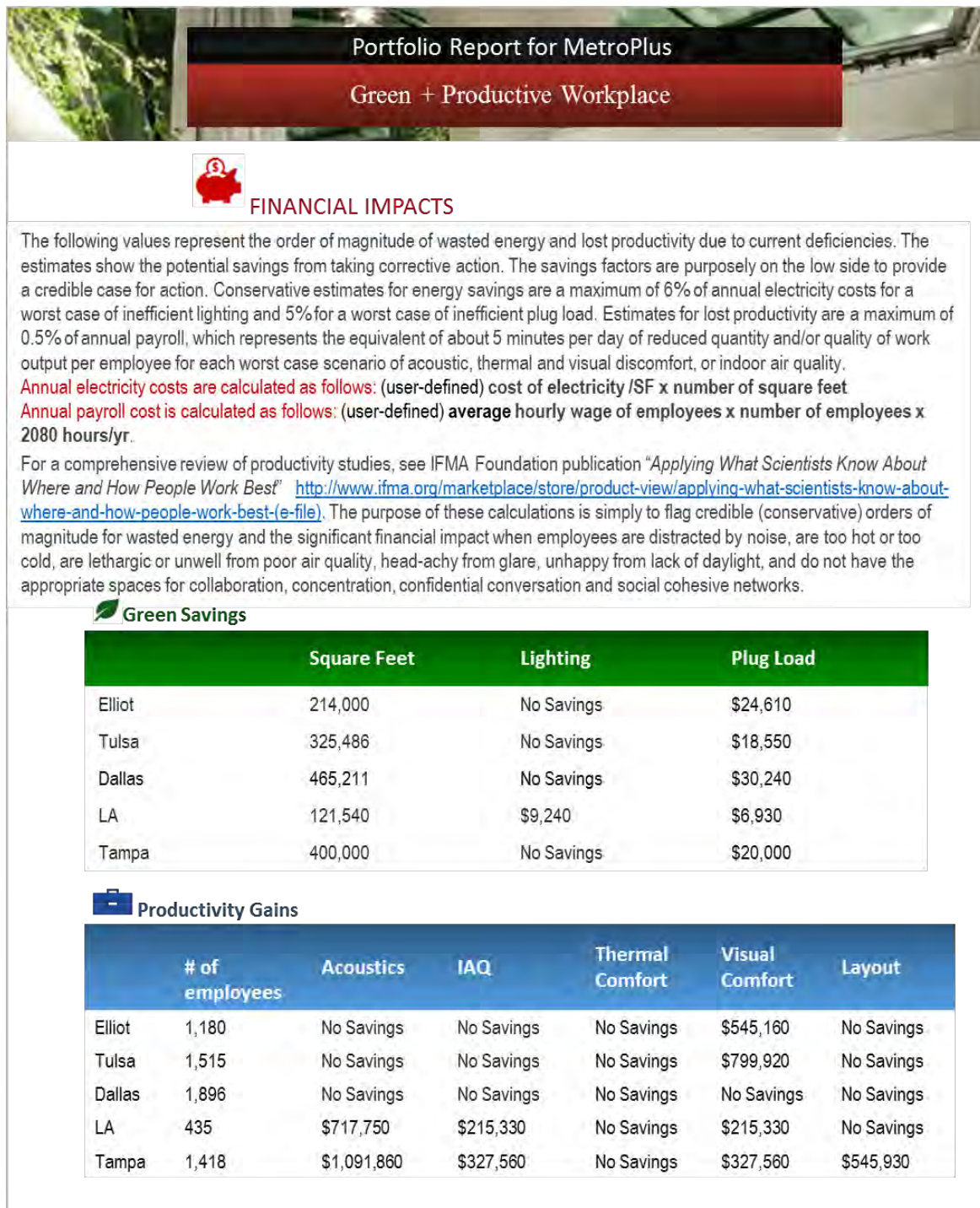

Figure 5: Excerpt from a G+P portfolio report (Executive Summary)

4. SIMPLE AND USER-FRIENDLY, YET RIGOROUS

Corporate real estate has a growing role in business enterprise for productivity, recruitment, retention, and branding. Smart technologies, employee mobility, the recognition of different workstyles and the importance of wellness – all are important aspects of the workplace of the future. Green + Productive Workplace is an online application for global real estate portfolios that aligns space planning and management, wellness and sustainability with IT, HR, and communications.

G+P illustrates that an assessment can be simple, user-friendly and non-punitive, without being simplistic. To date, **some 6 million square feet have undergone G+P assessments. As G+P undergoes pilots by some the world's largest companies** – it is becoming clear that the appetite for point-chasing, certification schemes is declining. This is being replaced with a hunger for streamlined, practical, affordable, strategic asset management and benchmarking platforms for portfolios. Large companies want more than just a certification of their trophy real estate assets. They want to address their entire portfolios in a strategic way that meets their needs: to be green, and to address productivity, CSR and sustainable growth.

REFERENCES

- [1] Yudelson, J. (2016) Reinventing Green Building | New Society Publishers. Available at: <http://www.newsociety.com/Books/R/Reinventing-Green-Building>.
- [2] Global corporate real estate trends 2013 (2014). Available at: <http://www.gcre.joneslanglasallesites.com>
- [3] Murugan, A. and Kato, H. (2010) Performance & perceptions of green buildings. Institute of Sustainable Development and Architecture Bond University, Australia Available at: https://www.gbca.org.au/uploads/PERFORMANCE_AND_PERCEPTIONS_OF_GREEN_BUILDINGS.pdf
- [4] Armitage, L., Murugan, A., & Kato, H. (2011). Green offices in Australia: A user perception survey. Journal of Corporate Real Estate, 13(3), 169-180. Available at: <http://www.emeraldinsight.com/doi/abs/10.1108/14630011111170454>
- [5] Sandquist, N., (2015) Applying what scientists know about where and how people work best, IFMA Foundation. Available at: <https://www.ifma.org/news/what's-new-at-ifma/what's-new-at-ifma-details/2015/01/27/workplace-research-applying-what-scientists-know-about-where-and-how-people-work-best->

Session 2.9: Practices & Methodologies for Green Building Management (2)

Green + Smart Buildings

Jiri SKOPEK^a

^a JLL, Canada, jiri.skopek@am.jll.com

ABSTRACT

'Green' is becoming increasingly synonymous with 'Smart.' There are several reasons for this including: the prevalence of IoT solutions, and the need to ensure that so-called green or high performance buildings will perform to the design or predicted performance once they are up and running. Proper transfer of design information into the operational environment, sophisticated, smart controls and monitoring, and properly trained operational workforce helps to maintain performance and achieve the desired carbon and energy savings.

This paper will examine the typical causes of building performance slippage and remedies including deployment of ongoing commissioning enabled by big data analysis diagnostics, smart building solutions and appropriate staff training.

Keywords: smart building, green building management, high-performance building, post occupancy evaluation

1. HOW TO ADDRESS THE CARBON PROBLEM

It is well known that in order to combat climate change and keep the temperature rise below 2deg C, we need to cut our carbon emissions approximately by 50% for existing buildings and get to carbon neutrality for new construction by 2030. The various conservation efforts around the world show painfully modest reductions of 10 to 15%, often followed by regression due to the performance slippage. Net-zero buildings and certification schemes such as BREEAM, LEED or Green Globes are laudable; however their overall impact is miniscule. While these provide valuable insights into how buildings impact the environment, they are not effective enough to impact the vast majority of the building stock [1]. Something else needs to be done.

An effective approach to meet the carbon challenge can only come through a combination of measures, supported by technology. We need a robust solution on a large number of buildings, effective monitoring and analytics of building operations, advanced proactive maintenance, well trained building operators, and building owners and corporate Chief Executive Officers (CEOs) who are attuned to the ways that buildings impact both the environment and the productivity of the occupants. This would help them to make the right investment decisions on needed building improvements and ways to engage building occupants. With this, SMART will become synonymous with GREEN.

1.1 How to meet deep reduction targets and combat performance slippage

We are the first generation undergoing the transformation of paper based data into electronic bits - a similar revolution to Gutenberg - yet much of our energy data processing is still based on spreadsheets. Any data analyst will affirm that no data is perfect, but big data analysis can provide sufficient degree of granularity to identify likely trends. The mandatory reporting requirements in several jurisdictions are an example of utility metadata that will make it relatively easier to benchmark and establish reasonable targets.

A novel approach to data analysis, successfully tested in Cambridge, addresses districts (rather than individual buildings) and helps to uncover patterns in the data. Developed by the Department of Urban Studies and Planning jointly with Department of Civil and Environmental Engineering at the Massachusetts Institute of Technology (MIT), **an algorithm evaluates buildings' energy consumption performance based on energy bills, building footprint and physical attributes of heat loss.** The data then undergoes statistical analysis to establish, at the district scale, the energy consumption/carbon emissions and potential savings [2]. This can then be related to regional, and national goals.

Rather than using a shotgun approach, this results in a clearer understanding of what type and where specific energy and carbon reduction programs would be most effective. (See Figure 1-Representation of the energy saving potential of Cambridge buildings)

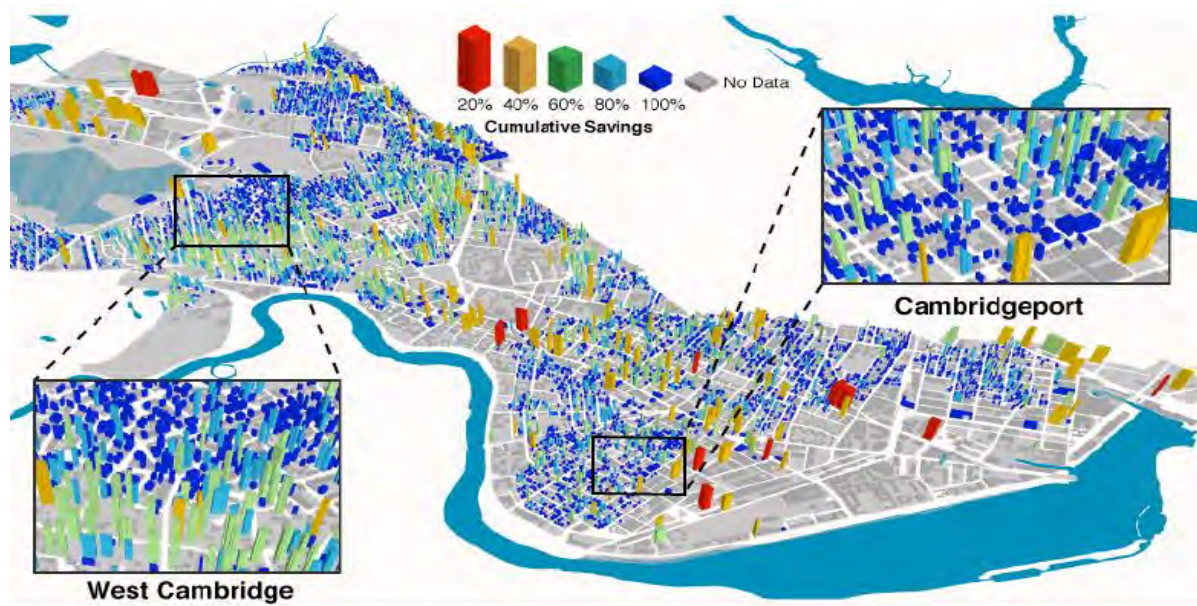

Figure 1: Representation of the energy saving potential of Cambridge buildings

Once areas or buildings with the highest energy improvement potential have been identified, it is much easier to contact the owners of those buildings and discuss with them, one-on-one, their business objectives for those properties. Thousands of energy audits are done each year, yet most of them end up on a shelf with no action taken because they do not fit the organization's business case or investment strategies.

Northwest Energy Efficiency Alliance (NEEA) [3] has identified the barriers to significant progress: First, a lack of understanding of the different drivers depending on whether the decision-maker is a large investor/owner, a Real Estate Investment Trust (REIT), a third party property manager or a smaller independent. Second is the excessive “noise” in the system from service providers, vendors and “helpful” organizations. A third barrier relates to scale. The energy savings gains of individual buildings are often too small to attract the attention of corporate real estate portfolio decision makers.

To achieve results, improvement strategies must be geared to the specific drivers for various types of organizations and decision makers. The building must have a certain business condition such as sufficient long lease with desirable tenants or long ownership pattern to be a good candidate for improvement investment.

1.2 Smart building solutions

Whether a building is new or existing, post occupancy studies [4] indicate what some of the reasons are that buildings are not performing as designed:

- Building occupancy is changing faster than anticipated.
- Building are designed with features that are beyond the capacity and training of the building operations management to use.
- Complex and innovative systems that may require several years to refine and understand.
- Lack of commissioning

Clearly there is a need for greater preparedness of the building operators as well as predictive maintenance or commissioning. Building operators training is of paramount importance. Training courses such as Building Operator Certification® (BOC) give operators the means to run their buildings more efficiently [5].

There are several studies which indicate that commissioning is cost-effective. For example Lawrence Berkeley's “Building Commissioning Golden Opportunity for Reducing Energy Costs and Greenhouse Gas” identifies a 16%

median whole-building energy savings in existing buildings and 13% in new construction, with payback time of 1.1 years and 4.2 years, respectively [6].

Typically issues addressed by commissioning are:

- Equipment running in excess of scheduled operations-coverage
- Simultaneous Heating and Cooling
- Economizer Malfunction
- Leaky Valve
- Night Setback
- Morning warm-up
- Space temperature variations
- Optimum Start-up/Stop
- Duct Static Pressure Reset
- Chiller Analysis

The challenge of commissioning or retro commissioning is that it is time consuming and costly. Also, no sooner has retro-commissioning been completed, the building begins to slip out of calibration and savings achieved start to evaporate. **Because today's buildings are so complex, even small problems or operational variances can** escalate into large performance issues. A typical facility will become 3-5% less efficient every year without intervention. Also, as operations staff try to fix one problem at a time, soon they cannot see the forest for the trees.

This is where smart building solutions can help. Thanks to the diagnostic capabilities of smart buildings, performance optimisation is ongoing. Smart buildings also free the building operator staff from running around trying to catch up with problems, so that instead, they may proactively prepare themselves for the task ahead.

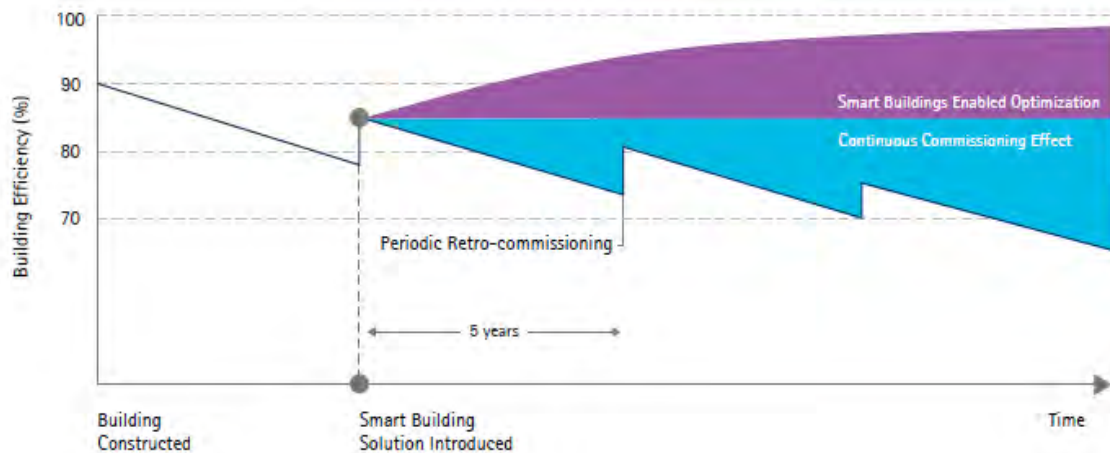

Figure 2: Ongoing, smart commissioning versus a traditional retro-commissioning approach

2. SMART + GREEN BUILDINGS

In one example of a more comprehensive smart building solution, data is collected from buildings of all types: retail, high rise office buildings, industrial or manufacturing, and critical environments such as hospitals or data centres. The extracted data captures the performance of the building systems such as HVAC and lighting, but can be also extend to other systems, such as elevators, security and life safety. The data are pulled from the site to the cloud, where they are analysed through a series of fault detection and diagnostic algorithms and rules engines. This automated analysis is further enhanced by subject matter experts operating 24/7 in a command centre.

3. CONCLUSION

To be effective, carbon reduction measures must be done on a larger scale, combining measures such as monitoring and analytics of the building operations, advanced proactive maintenance, well trained building operators, and buy-in from the building owners and corporate Chief Executive Officers (CEOs).

Smart building approach is especially helpful with operational improvements such as performance monitoring and ongoing commissioning. These technologies exist but have not been deployed to their full effect.

Smart and green building technology offers powerful, scalable e-market opportunities, especially in light of improved near-term and long-term trends in technology, finance, regulations and policy. The near-term business case is bolstered not only by the energy savings potential but even more so by workplace productivity gains from the strategic deployment of certain smart and green building features.

Longer-term market changes are already in play. The business environment is ripe for the arrival of consistent, widespread regulatory policies addressing energy efficiency and carbon reduction. Financing mechanisms already exist that can be scaled up for wider smart and green building technology for property owners seeking energy retrofits. Moreover, electricity markets and tenant expectations will continue to shift in favour of smart and green building deployment and ownership. Against a backdrop of energy efficiency and carbon reduction imperatives and emerging technologies, there is market evidence that the profound opportunities for savings will make smart and green buildings an agile and powerful asset class that is strategically aligned with shifting patterns of tenancy and use.

REFERENCES

- [1] Yudelson, J. (2016) Reinventing Green Building | New Society Publishers. Available at: <http://www.newsociety.com/Books/R/Reinventing-Green-Building>.
- [2] Abdolhosseini Qomi, M.J, Noshadravan, A, Sobstyl, J, Toole, J, Ferreira J, R. J-M, Pellenq, R.J-M, Ulm, F-J, S,1 and Marta Gonzalez, M. Data Analytics for Energy Efficient Retrofits of Cities. Available at: http://humnetlab.mit.edu/wordpress/wp-content/uploads/2010/10/70008_0_merged_pdf_1268810_nrhjqt.pdf
- [3] Northwest Energy Efficiency Alliance (NEEA): Commercial Real Estate (CRE) Market Test Assessment: Understanding Delivery, Partnership Strategy and Program Channels (no date) Available at: <http://neea.org/docs/default-source/rfp-documents/42623-needa-rfp.pdf?sfvrsn=2>
- [4] Do our green buildings perform as intended? (2014) Available at: http://iisbecanada.ca/umedia/cms_files/Conference_Paper_1.pdf
- [5] Why BOC? - NEEC building operator certification. (2016) Available at: <http://www.theboc.info/why-boc/>
- [6] Mills, E. (2009) Building Commissioning: A Golden Opportunity for Reducing Energy Costs and Greenhouse Gas. Available at: <http://cx.lbl.gov/documents/2009-assessment/lbni-cx-cost-benefit.pdf>
- [7] The Changing Face of Smart Buildings: The Op-Ex Advantage, JLL White paper (2013) Available at: <http://www.us.jll.com/united-states/en-us/research/>
- [8] Convergence of Green and Intelligent Buildings (2008) Available at: <http://www.caba.org/resources/Documents/bqb-final.pdf>

Challenges in Realizing Green Building Concepts in Trade and Industry Tower

Alex CHAN^a, Joanna WAI^b, Raymond HO^c, Philip CHEN^d, KT Lee^e, Joyce TAI^f

^a Government Property Agency, Government of the HKSAR, Hong Kong SAR, amkchan@gpa.gov.hk

^b Architectural Services Department, Government of the HKSAR, Hong Kong SAR, waimw@archsd.gov.hk

^c Dragages Hong Kong Ltd., Hong Kong SAR, raymond.ho@dragageshk.com

^d Wong Tung & Partners Ltd., Hong Kong SAR, pchen@wongtung.com

^e Arup, Hong Kong SAR, kam-tim.lee@arup.com

^f Green Building Certification Consultant, Hong Kong SAR, joycetai.jt@gmail.com

ABSTRACT

The newly established Kai Tak Development Area (KTDA) marks a new era of sustainable urban development in Hong Kong featured by its first-ever District Cooling System for air-conditioning of buildings in the district. The Trade and Industry Tower (TI Tower) is the first office building in this new exemplary district of sustainable urban planning and design. With its strategic location at the gateway to the KTDA, the design of the building is set for demonstration purpose using sustainability as the theme to showcase sustainable building design.

The office building is designed not only to meet the building occupants' needs in respect of comfort, security, safety and operational efficiency, but also to achieve an eco-friendly building following the assessment guidelines set out in the BEAM Plus for New Buildings and LEED for New Construction. The project was bestowed a Grand Award of Green Building Award 2014 by the Hong Kong Green Building Council and is certified to Platinum level under LEED® and provisional Platinum level under BEAM Plus.

This paper introduces the exemplary green building designs of the TI Tower, including extensive greening, passive architectural design and active energy efficient features for maximizing building energy performance, automatic refuse collection system, intelligent building control and monitoring systems, educational provisions for promoting sustainable building design to the public. Property management measures are put in place after completion to ensure that the building is managed, operated and maintained to meet the objectives of its green building designs.

In the course of realizing the green building concepts, the project met various challenges in terms of site constraints, technical feasibility as well as time and budgetary constraints. This paper attempts to sum up the invaluable experiences gained by overcoming the relevant challenges through the collaborative effort of all stakeholders involved in the project.

Keywords: green building, green building management, green construction technology

1. INTRODUCTION

The project is organized into a 20-storey Office Tower, in which all the government offices are located and a separate Community Hall, which accommodates the multi-purpose hall and ancillary facilities.

A conscious target is laid down at the outset to make the project “green” in both aesthetic and performance terms. In the design, soft landscaping is seen to meander from one corner of the site to the opposite, covering the roof of the Community Hall, spreading over to all four elevations of the Office Tower, reaching its roof to form a lush roof garden. The distinctive “Green Ribbon” forms the signature of the building and is clearly discernible from all directions. The aesthetic interest is enhanced by introducing an organic, aerodynamic form – the “White Ribbon” of the Community Hall to contrast the efficient and functional image of the Office Tower. The “Ribbons” combine to conjure up a concept of a “gift” of services from the government to the local community the building serves.

The completed building provides daily service and leisure to the general public, and therefore is an excellent showcase for various green features.

2. GREEN BUILDING CONCEPTS

2.1 Extensive greening

In keeping with the “Green City” concept in Kai Tak Development Area, emphasis of the project has been placed on greening.

An exemplary 42% greening ratio is achieved and over 120 trees are planted with over 40 of them on the office tower roof. **Greening wraps around all surfaces of the development in the form of a “Green Ribbon”, which symbolically and visually links and unifies spaces at all levels.** The visual integration of landscape and greening with adjoining streetscapes is achieved by integrating bounding planting which compliment the selection and character of roadside planting outside the site boundary. A rich variety of open spaces, including at-grade spaces which are visually and physically connected to the ground level streetscapes, spaces at footbridge level with connecting staircase to ground level and break-out spaces on the roof of the office tower, provide a variety of passive recreation opportunities for visitors and users.

2.2 Sustainable building design

Sustainability is identified as one of the main themes of the project. Passive consideration of sustainability begins with the site planning and building layout and extends to the application of various features listed below:

2.2.1 Passive devices

- High performance facade material is selected with a Solar Coefficient (SC) value of 0.26. The glazing material is selected to maximize the amount of natural daylight provided to the building whilst reducing the solar heat gain.
- Solar shading is provided to all facades, providing shading from solar energy and from glare to the facade in the east and west under low angle sun conditions. Optimal application of solar shading also contributes to reduction of OTTV.
- Solar chimneys use solar energy to heat the air inside the 2 nos. of chimneys serving the Community Hall and basement car park, leading the air to become buoyant and driving an upward stack, entraining air in the low zones into the chimney to be extracted from the space. This allows the reduction in the amount of air conditioning and ventilation required to the Community Hall and car park respectively.

2.2.2 Active energy efficient features

- Connection to Kai Tak District Cooling System (DCS) provides the centralized air-conditioning system with a reliable supply of chilled water for building heat rejection. The DCS is over 20% more energy-efficient than a conventional air conditioning system using cooling towers. The connection with the DCS eliminates the building space required for accommodating the conventional heat rejection equipment such as cooling towers, thereby sparing more roof space for photovoltaic panel installation and roof garden. The elimination of evaporative cooling towers is also conducive to the saving of cooling tower make-up water, which is used for compensating for the evaporative water loss and regular water bleed-off. The DCS also eliminates the need of installing chillers in the office building, thereby reducing the total electricity demand as well as the space for accommodating power supply transformers.
- Free Cooling Design is adopted for the entire air-conditioning system so that the conditioned space is served by 100% untreated fresh air when the outside air meets the prescribed air intake conditions. During the free cooling mode of operation, the fresh air supply from PAU is shut off whilst the chilled water supply to the AHU cooling coils is also shut off for the sake of saving energy.
- Improved Specific Fan Powers for all Air Handling Units (AHUs) by reducing the external static pressure by paying careful attention to the pressure drop of ductwork.
- Condensate Recovery System is adopted for collecting the cooling coil condensate water from drip trays of CRAC units and AHUs of each floor to a thermally insulated condensate storage tank via a vertical riser. Condensate water is then pumped to a separate cooling coil of a designated PAU for reducing the DCS chilled water demand of the same PAU.

- Heat Recovery Wheels are adopted for all 6 No. of PAUs. Each PAU is equipped with a heat recovery thermal wheel between the supply and return air streams for reclaiming the waste energy from exhaust air and pre-cooling or pre-heating the incoming fresh air.
- Demand Control of PAUs Based on the Indoor CO₂ Concentration Levels and Temperatures facilitate energy saving of the fresh air supply system, especially for indoor spaces with significant variations in the number of occupants. The PAU is equipped with a variable-speed drive for coping with the fluctuations in fresh air demand at different times.
- Active Harmonic Filters of the Electrical Distribution System minimize the electrical energy losses arising from harmonic currents that originate from electronic equipment or components (power switching devices, IT equipment etc.). The Active Harmonic Filters eliminate the undesirable harmonics by using power electronics, reducing the thermal stress induced by harmonic currents and enhancing the efficiency of electrical power distribution.
- Active Power Factor Correction Units of the Electrical Distribution System improve the overall system power factor by counteracting the undesirable effects of electric loads that create a power factor that is less than 1. Power factor improvement is achieved by reducing the reactive component of the supply current by adding capacitors in parallel with the connected inductive load circuits. The inductive effects of an electrical load are cancelled out by the current generated by the capacitors. The power factor improvement enhances **the energy performance of electrical distribution system, including the improvement of cables' current-carrying capacities**, reduction in electrical power losses as well as increase in the portion of useful electrical energy produced from the electrical energy sources.
- Heat Pump System is used to absorb heat from the return chilled water and pre-heat the hot water tank. This serves as a secondary heat source to the Solar Hot Water Supply System when the installed solar collectors cannot provide the required heat energy for pre-heating the incoming water of the water mains, therefore enhancing the overall energy performance of the Solar Hot Water System. At the same time, the chilled water demand of the air-conditioning system is also reduced.
- Service-on-demand Mode of Operation is adopted for the four escalators at G/F and M/F, whereby passenger proximity sensors are installed at the entrance of each escalator for controlling the ON/ OFF operation of the escalator, thereby contributing to a substantial saving of escalator running energy during the period when there is no passenger traffic.
- Demand Control of Mechanical Ventilation for Basement Carpark based on Indoor CO₂ Level and Temperature is an effective means of minimizing energy consumption of variable-speed exhaust air fans whilst keeping concentrations of indoor pollutants like CO and NO₂ below the ceiling levels by use of gas monitoring devices throughout the carpark.
- LED and T5 Fluorescent Lamps are adopted for the lighting system. Tubular LED lamps are installed at selected part of the office areas whilst LED downlights are provided for lift lobbies, lavatories, pantries and outdoor areas. High efficiency T5 fluorescent lamps are installed in office areas, corridors and plant rooms.
- Energy-efficient Fan and Pump Motors are selected to enhance the energy performance of mechanical, electrical and plumbing systems.
- Variable Speed Drives (VSD) are adopted for all chilled water pumps, AHU and PAU fan motors, lift motors, escalator motors and automatic refuse collection system. The extensive use of VSD boosts the energy performance of electric motors running under part-load conditions.
- Occupancy Sensor Control of VAV Boxes reduces the VAV air flow rate to a preset minimum level so as to minimize wastage of cooling energy when the air-conditioned space is unoccupied.
- Lift Regenerative Power Converters are installed to all of the 18 lifts serving the building. The regenerative energy can be reclaimed under light-load lift ascending and heavy-load lift descending operation modes. When a lift car moves down with a heavy car load or moves up with a light car load, the lift traction motor is driven by the lift car load or the lift system counterweight and, motor braking is necessary to prevent free fall of lift car. The energy generated under the motor braking mode is called the regenerative energy. To harvest such regenerative energy, the lift system is provided with a regenerative energy converter for diverting the regenerative **energy to the building's electrical distribution system for use** by other electrical loads.

2.2.3 Renewable energy

- Photovoltaic (PV) system comprises 189 opaque PV panels at the roof top, 48 see-through thin-film PV (TFPV) panels at main entrance canopy and 96 TFPV panels at 1/F elevated walkway. The entire PV system has an installed capacity of 42kW, helping to offset the amount of electricity provided to the building from the local power grid. The orientation of PV panels is optimized by means of sun path analysis so as to maximize the annual collection of solar energy.
- Solar hot water supply system is equipped with evacuated tube solar collectors, which serve to pre-heat the incoming water for a shower room. This type of solar collectors is compact in size and can maintain a high level of solar energy absorption without the need of separate solar tracking device. The solar heating design can reduce the total energy demand of electrical heating energy when compared with the traditional electric water heating system.

2.2.4 Features reducing reliance of artificial lighting

- 27 nos. of Fixed Light Pipes, 3 nos. of Anidolic Sun Pipes and 6 nos. of Sun-tracking Optic Fibre Sun Pipes are installed to reduce the artificial lighting energy consumption. The locations provided with Light Pipes are mainly interior zones of the office tower and the community hall such as basement carpark, multi-purpose hall, dressing rooms and top floor toilets. Sun Pipes make use of its highly reflective internal surfaces for transmitting sunlight from one end to the other. The Sun-tracking Optic Fibre Light Pipes are designed for maximizing the collection of available sunlight by use of automatic solar tracking devices. Sunlight is transmitted to indoor spaces via optical fibres, which can be routed virtually in any direction to the indoor spaces. The Sun Pipes are connected with photo sensors for facilitating automatic dimming of indoor artificial lighting whenever sunlight is available.
- Adoption of task lighting in office areas also helps to reduce the energy consumption of background lighting, the design illumination level of which is generally reduced from 500 lux to 300 lux, resulting in a Lighting Power Density (LPD) of 8.5 W/m², which outperforms the LPD requirements of 15 W/m² stipulated in the Building Energy Codes of Hong Kong (2012 Edition).
- Occupancy sensors are used extensively for both inner zones and perimeter zones and daylight sensors for perimeter zones throughout all open plan offices and cellular offices contributes to the effective saving of lighting energy that is otherwise wasted in un-occupied office spaces and in those perimeter zones with adequate daylight above 300 lux.
- Light colour scheme is adopted for indoor furniture and architectural finishes (e.g. partition walls, carpets etc.) so as to improve the indoor light reflectance and indoor illumination level and hence, reducing the lighting energy consumption.
- Computerized Lighting Control System is utilized to control the On/ Off of the lightings according to the pre-determined time zones at working days, Sunday or holidays.

2.2.5 Automatic refuse collection system

The Automatic Refuse Collection System (ARCS) is designed to facilitate effective waste management for the building. In the refuse room on each floor, two refuse disposal outlets are provided at two vertical refuse chutes for transporting solid wastes, one for recyclable paper wastes and the other for general wastes, to two large waste storage bins at the basement. The ARCS facilitates collection of solid wastes in an efficient and hygienic manner. This system also reduces the traffic of service lifts and manpower for refuse collection when compared with the conventional solid waste collection system. Whenever the wastes collected at the bottom section of the vertical refuse chutes reach a certain volume or after a certain time interval, it will be sucked into the respective container for storage and the paper wastes will be collected regularly for recycling purpose.

The ARCS is connected with a vacuum air system for maintaining a negative pressure inside the refuse chutes. The exhaust air from refuse chute is pre-treated by a dust filter and a water scrubber before discharge to the ambient. The ARCS is equipped with a built-in alarm system, which shuts down the entire system automatically in the event of blockage inside vacuum chutes so as to allow subsequent manual clearing of chute blockage. All vacuum chutes are covered with a layer of fire resisting material for minimizing the risk of fire spread through the chutes.

To achieve efficient operation as well as reduce power losses due to harmonic currents, variable speed drive supplemented with active harmonic filter is provided at the ARCS system local motor control panel.

3. CHALLENGES ENCOUNTERED IN IMPLEMENTATION

The recurring challenge during the design process is to achieve all the design objectives with due respect to the time and cost constraints. Products which are well-proven and commonly available in the market are preferred. Conscious effects were also made in sourcing materials from an 800-km radius from Hong Kong. This would help to reduce the carbon emission caused by transportation of the construction materials.

Selections among different manufacturers are exhausted. For instance, in the selection of the curtain wall glazing, products from no less than 8 glass manufacturers were gathered for on-site inspections before narrowing down to 3 for the full scale visual mock-up. Technical data and visual effects from both directions were thoroughly compared. Bespoke components are thoroughly detailed to ensure practicality in fabrication. In another instance, 6 plant species were kept on site for a full 12-month period to test their growth rate, resilience to weather and ease of maintenance before the optimal species is selected for the Green Ribbon planters.

With the concerted effort from all parties, the project was completed on time and within budget.

4. PROPERTY MANAGEMENT MEASURES

Effective building management measures should be put in place to ensure that the building is managed, operated and maintained to meet the green building design objectives. In this regard, the following objectives have been set in formulating appropriate building management measures:

- To ensure that the green features and facilities function properly;
- To facilitate sustainable development of green management; and
- To promote green features to users.

4.1 Proper functioning of green features and facilities

The building adopts an all-in-one computer software named Central Control Monitoring System (CCMS) for controlling, monitoring and managing all the building operation-related equipment such as lighting, ventilation, air-conditioning, security system, access control, fire services installation, lift and escalator, plumbing system and other engineering system, etc. This useful tool not only facilitates the management party to improve energy performance for a range of building electrical installations and technical services but also ensures proper functioning of green features equipped in the building.

Also, CCMS assists the management party to monitor and record the plant status, environmental condition and energy consumption. With CCMS in place, management party can grasp a comprehensive picture of how well each component is being operated. It also facilitates the fine-tuning and troubleshooting of performance problems. The data provides useful information for further analysis of energy saving plan and formulation of procurement strategy.

4.2 Facilitating sustainable development of green management

To facilitate sustainable development of green technology and management, various house-keeping measures are carried out, including standardising the specified average room temperature of 25.5°C during the summer months and the core air-conditioning hours with a view to maintaining the workplace as a comfortably air-conditioned environment. Other measures including adoption of task lighting, use of installed occupancy sensor and daylight sensor for lighting control, optimising the operating hours of lift services and public lighting, the use of installed timer setting of CCMS to switch off building services installations, etc. are also implemented. Each user department in the building has appointed a Green Manager and an Energy Warden to assist in implementing energy saving house-keeping measures. By means of CCMS, the building management is able to monitor energy consumption of each floor, and review the implementation of the measures and degree of energy saving.

With respect to air quality, arrangements have been made in the building to achieve **“Excellent” class for Indoor Air Quality** in 2016. Waste reduction and recycling programmes and floor-to-floor waste separation are also implemented. Data on the quantities of recyclable wastes collected under each category are recorded and reported to the Environment Protection Department periodically.

User’s awareness and engagement is also critical to the sustainable development of green management. In addition to distributing green tips and guidelines, management party invited user departments to express their views on the facilities/ installations of the building through Building Management Committee (BMC) which comprises representatives from the user departments in the Tower. BMC meetings are held regularly to discuss, among others, issues on green management and energy saving. Messages on green management and energy saving would also be disseminated to all users in the BMC meetings.

4.3 Promoting green features to users

In order to promote energy efficiency and renewable energy technology as well as public awareness of **government’s initiatives on greening development, an education path is set-up** in the building. Along the path, exhibition panels and signage are placed next to the green features which are accessible by building users and visitors. An interactive display, forming part of the education path is located at 1/F of the Tower, provides a virtual tour of the green features in the aspects of energy, water, indoor environmental quality and material, etc. Guided tours are regularly organised for user departments and the public to introduce and promote green building designs in the building.

5. CONCLUSION

The building projects an image of efficiency, practicality and education. The project demonstrates an exemplary performance of energy efficiency, by aiming to reducing energy consumption by around 27%. The high level of greening combines with the green features would result in a saving of around 36% in carbon emission as compared against the Building Energy Code (BEC) 2007 Baseline model.

The **theme of sustainability features prominently on the outside, displaying an iconic “green” image.** The green building concepts in the project are conceived from Day 1 through to completion. This principle is used throughout the complicated design process, despite controls of time and budget. The building is also an education tool – for the occupants and the public. The performance goals cannot be met unless the users appreciate them and use the building responsibly. TI Tower is a building to look at, to work in, to be served in, to play in and to learn from.

APPENDIX



Overall view from Concorde Road showing the "green ribbon"



Vertical greening on façade forming the "green ribbon"



Community hall green roof



Roof garden in office tower



Building integrated photovoltaic panels in canopy



LED lighting at part of the office areas



Photovoltaic panels on upper roof



Solar hot water panel in external landscaped area



Signage totem for education path



Interactive display in 1/F lobby as start of education path

The Perceptible Impacts of Building Envelope on Other Green Building Features: “A Review”

Salisu Gidado DALIBI^a, Abubakar SADIQ^b, Isa IBRAHIM DANJA^c, Abubakar YAHAYA MUHAMMAD^d

^a Business School of Hohai University Nanjing, Mainland China, salgidos@yahoo.com

^b Business School of Hohai University Nanjing, Mainland China, sadiq635@yahoo.co.uk

^c Department of Architecture South-East University Nanjing, Mainland China, danjaisah@yahoo.com

^d Business School of Hohai University Nanjing, Mainland China, yayarisadiq@yahoo.com

ABSTRACT

Nigeria is a West African country with a climate classification of a tropical wet and dry climate with three weather conditions namely; warm, humid rainy season and a blistering dry season; with a brief interlude of harmattan in between the two. As such, Green building (GB) designs and constructions in Nigeria must be characterized by features that suit its weather and the environment. GB features include but not limited to the building envelope (BE), Energy efficiency, water Efficiency, Indoor environmental quality (IEQ), Day lighting systems etc. Such features/ components are integrated into the GB for various purposes and functions; as a whole they help solve sustainability issues within the built environment. The BE consists of structural materials and finishes that enclose space, separating inside from outside with a proportionate impact on other green features. The BE design is a specialised area of design and construction engineering practice that draws from many areas of building science and disciplines. With new trends emerging coupled with the shift toward timesaving standardization; this will necessitates mass customization of BE components. BE technology is important first in uniting the industry to overcome some of the factors and challenges that hinder innovation in buildings. The aim of this paper is to examine and assess the impacts of building envelope on other green building features with a view of ascertaining the impacts of the envelope on the GB concept as a whole. Reviewed literatures were used to identify, explore and examine the various green building features, the impact and the relationship of building envelope on such features **within the context of Nigeria's built environment. The results showed that Building envelope have a significant impact on green building features such as Energy, Day lighting, Indoor environmental quality and water efficiency systems and strategies.**

Keywords: indoor environmental quality, green building management, building envelope, built environment, green features, impacts, Nigeria

1. INTRODUCTION

Nigeria is the most populous African country located in western Africa; a former British colony till October, 1960 when it gained independence. Lagos (a coastal city) was then the capital city till December, 1991 before the seat of power was moved to Abuja within the Federal Capital Territory (FCT) in the same year. Geographically, Nigeria is located in West Africa with the southern part of the country having a long costal line with the Atlantic Ocean and the north with the Sahara Desert. Under Köppen climate classification, it features a tropical wet and dry climate with three weather conditions namely; warm, humid rainy season and a blistering dry season; with a brief interlude of harmattan in between the two (WECSI 2014, demographia.com; and Wikipedia.org). As such, **Construction projects in Nigeria's built environment; be it Housing, Industrial engineering, Roads and other civil and infrastructural projects** were affected by its weather, location and available construction materials. Like any other construction industry of a developing nation in the world, the industry in Nigeria also pollutes the environment.

These showcased the built environment impact (due to human activity) on resources, that is buildings have a significant impact on the environment, accounting for one-**sixth of the world's freshwater withdrawals**, one-quarter of its wood harvest, and two-fifths of its material (Eurostat, 2011); 40% primary energy consumption (Bauer et al., 2007). Structures also impact areas beyond their immediate location, affecting the watersheds, air quality, and transportation patterns of communities (Eurostat, 2011). The combination of these challenges gave birth to a new concept in design, construction/ renovation, operation and maintenance of buildings in conformity with sustainable practices known as sustainable/ eco/ high performance/ green buildings (Dalibi, 2014).

It is worthy to note that since the emergence of Sustainable/ eco/ high performance/ green buildings, there were so many attempts to clearly define it, with each Industry and discipline defining it from its own perspective. Below were some definitions:

- Green building (GB) refers to a structure that uses all processes that are environmentally responsible and resource-efficient throughout a building's life-cycle from Siting to Design, Construction, Operation, Maintenance, Renovation and Demolition. This practice expands and complements the classical building design concerns of economy, utility, durability, and comfort (USEPA, 2009).
- Sustainable/ green buildings are those sensitive to the environment, resource and energy consumption, **impact on people, financial impact and the world at large. While Zane et al, 2009; referred to the term "Green Building" as environmentally friendly practices from building design to the landscaping choices.** It also encompasses energy use, water use, storm-water and wastewater re-use (Greg Kats, 2003).
- According to Dalibi, 2012; Green buildings (GB) are buildings designed, constructed and operated to provide optimum performance of the building with positive impact to the occupants and the environment by combining energy, water efficiency systems, Day Lighting strategies, Indoor Environmental Quality (IEQ) systems and efficient Building Envelope systems.
- **The United States environmental protection agency as cited by Vatalisa et al., 2013; opine that "Although** new technologies are constantly being developed to complement current practices in creating more sustainable buildings, the common objective is that green buildings are designed to reduce the overall impact of the built environment on human health and the natural environment through the goals of sustainable building such as life cycle assessment (LCA), energy efficiency and renewable energy, water efficiency, environmentally preferable building materials and specifications, waste reduction, toxics reduction, indoor air quality, smart growth and sustainable development, environmentally innovative materials and services
- Another definition by green building (GB) solutions is that: green building design and construction provide an opportunity to use resources more efficiently, while creating healthier and more energy-efficient homes and commercial buildings.
- **"Green building** (GB) is a holistic concept that starts with the understanding that the built environment can have profound effects, both positive and negative, on the natural environment, as well as the people who inhabit buildings every day. Green building is an effort to amplify the positive and mitigate the negative of these effects throughout the entire life cycle of a building (USGBC 2007).

Thus, from the above definitions, an adequate building envelope system is one of the features of GB. A Building envelope (BE) is the physical separator between the conditioned and unconditioned environment of a building including the resistance to air, water, heat, light, and noise transfer (Cleveland and Morris, 2009 and Syed, 2012). The BE is all of the elements of the outer shell that maintain a dry, heated, or cooled indoor environment and facilitate its climate control. Building envelope design is a specialized area of architectural and engineering practice that draws from all areas of building science and indoor climate control (Syed, 2012).

According to Straube and Burnett (2005), the functions of the BE can be separated into three categories:

- Support (To resist and transfer structural loads),
- Control (The flow of matter and energy of all types),
- Finish (Meeting human desires on the inside and outside).

1.1 Research problem

Over the years, many housing estates were developed by both the Public and the Private sectors or a partnership of both in Nigeria. However, Such Housing estate developments were insufficient in terms of demands; do not reflect the desired housing needs of the end-users; in most cases affordable but not qualitative; do not possess green building features (Dalibi et al., 2016). Though, green building construction practice is a new trend with insufficient data about building performance from currently operating sustainably designed buildings (BD&C 2003; ENSAR 2003; Andreau et al., 2004). **It is also evident from some developers'/ clients' attitudes, as they are not fully inclined towards such projects due to lack of comprehensive data about the financial obligations with regards to Incorporating green features into renovation or proposed projects (Dalibi et al., 2016).**

Casado (1996) stressed the importance of studying the potential environmental impacts produced by the use of certain building materials with the need to highlight the impact represented by the combination of these materials **when used in a certain constructive assembly. Morris (2007); Asserted that “the cost for incorporating sustainable design elements will depend greatly on a wide range of factors, including:**

- Building type,
- Project location,
- Local climate,
- Site conditions, and
- The familiarity of the project team with sustainable design.

In most cases, these factors have a relatively small but still noticeable impact on the overall cost of sustainability. Cumulatively, however, they can make quite a difference.

Hence, the need to examine the impact of BE on other GB features based on building type, project location, local climate, site conditions, and the familiarity of the project team with sustainable design; which is further compounded by the perceived synergetic effect of GB features in ensuring sustainability within the construction industry.

1.2 Research aim

The aim of this paper is to review the perceptible impacts of BE on other GB features within the Nigerian and global context with the view of improving the existing literature. Review of literatures in the eco/ green/ sustainable building field helps identify and narrow few environmentally sustainable passive and active elements or features of which the impact of BE will be examined upon.

2. METHODOLOGY

The main sources of data were journals, conference/ seminar/ workshop papers, text books, newspapers, magazines and the internet etc. which were used to review literatures in the green building field which helps identify and narrow few environmentally sustainable passive and active elements within the Nigerian and Global context.

Huedo et al., (2016), opined that environmental assessment of the building assemblies used for the envelope requires a scientifically rigorous methodology such as environmental impact assessment. The life cycle analysis (LCA) is the most suitable because it is an analytical procedure focused on evaluating the whole life cycle. LCA, however, it is an exhaustive, very laborious and complex process that must be carried out by highly skilled professionals and the time needed to apply it is often incompatible with the time available for producing designs. As a result, few life cycle analyses of buildings have been carried out in some countries. In the international context, a wide variety of tools based on the LCA methodology have been developed with the specific aim of aiding the planner in the sustainable selection of building assemblies.

These tools hardly apply outside the countries where they were developed since the environmental impact level caused by building materials and assemblies varies from one territory to another, due to the geographic placement of raw materials extraction and transformation plants in relation to the building location as well as to the possible differences in construction techniques (Mateus and Bragança, 2011).

3. LITERATURE REVIEW

3.1 Building envelope

GB is an integrated building system that encompasses all the efficiency systems (into a single system) for the purpose of sustainability. Sustainable design elements are gradually accepted in the mainstream of GB project design, as the major stakeholders (clients and end-users) are beginning to demand and value those features. It is important to note that, the advanced or innovative sustainable features can add significantly to the cost of a project and that these must be valued independently to ensure that they are cost and or environmentally effective when integrated together. Such elements include energy efficiency systems, water efficiency systems, day lighting systems, indoor environmental quality (IEQ) systems and building envelope systems etc. through the use of sustainable building materials.

The building envelope, also called building enclosure, shell or fabric, is the boundary or physical separator between un-conditioned or conditioned interior of a building and the outdoor environment. Building envelope, consisting of external walls, roofs, ceilings, floors, windows, and doors, regulates the flow of energy between exterior and interior of the building and plays a crucial role of both protecting building occupants from external environment by providing them comfort and by enhancing their productivity. Building envelope also plays a critical role in determining the amount of energy a building will use during its operation. The energy costs associated with the production and transportation and overall environmental life-cycle impacts of different envelope materials vary greatly (IEA, 2013).

Thus, to increase the sustainability of construction it is necessary to consider reducing both the energy consumption and the CO₂ emissions of buildings by improving the building assemblies that make up the building envelope. This envelope has to guarantee the quality of the environment inside the building, since the exchange between the inner and outer environment takes place through it. It is also the point where illumination, ventilation or heat flows act as fundamental design parameters (Haapio and Viitaniemi, 2008).

The use of materials and construction technique in building envelope widely differs between developed countries like Europe, USA, and developing countries especially those within the tropics (IEA, 2013). In almost all parts of the world, buildings used to be constructed using local materials to maximize comfort considering local climate. In warm-humid areas larger openings were provided in the buildings for natural ventilation for cooling etc. But, due to modernization and faster urbanization rate, the force of market economy and electronic media along with a change in socio-cultural outlook have made people accepting the gradual change in the building design and construction materials even in remote rural and semi-urban places (Sarkar, 2015a).

Present day construction practices utilize modern standardized building materials and construction methods that dominate the market in the country (Sarkar, 2015a and Sarkar, 2015b). Local climate and function of the building are the two foremost important parameters affecting building envelope design. The thermal loads of residential buildings are primarily external (from sun). The efficiency of building envelope design is significantly affected by the building configuration and foot print also (ibid).

3.2 Envelope and other GB features

Green building elements and features considered in this work as cited by Dalibi (2016), and also based on US EPA 2009; Gregg Kats 2003; Zane et al, 2009, Dalibi, 2012; Vatalisa et al., 2013; greenbuildingsolutions.com; USGBC 2007; include (but not limited to) the following; energy efficiency systems, water efficiency systems, day lighting systems, indoor environmental quality (IEQ) systems and the building envelope systems.

As such, the perceptible impacts of building envelope (BE) in this work also will be based on the following features and their sub-components:

- Energy efficiency systems,
- Water efficiency systems,
- Day lighting systems,
- Indoor environmental quality (IEQ) systems,

3.3 Impact of BE on green building energy efficiency system

Buildings are responsible for more than one third of the total energy use and associated greenhouse gas emissions, both in developed and developing countries (UNEP, 2014). Buildings consume a lot of energy all around the world and are responsible for high environmental pollution. However, the main focus is also put on new construction technologies to assure low energy needs of new buildings (Chwieduk, 2016).

Nowadays building envelopes are designed and constructed according to energy saving measures, with high quality of thermal insulation and high thermal capacity of construction elements. Heat flow through opaque external walls has been reduced significantly, and it takes a minor part of the total energy transport between the outdoor and indoor environment. The influence of solar radiation passing through glazing on the heat balance of a building is especially evident in new low energy buildings with high thermal resistance envelopes (ibid).

It is necessary to be able to establish relationships between these impacts and those produced throughout the lifespan of the building, due to both the actual materials used and the energy consumption linked to the building assemblies employed in the building envelope (Huedo et al., 2016). Residential and commercial buildings consume **approximately 60% of the world's electricity** (www.isi.fraunhofer.de; 2012) in Europe, the residential sector requires 27% of the total energy and it contributes proportionally to the emission of CO₂ (Nejat et al., 2015). Some studies show the impact of energy efficiency measures related to refrigerators, washing machines, air conditioners, televisions and heating and cooling service (Montejo and Pardo 2016; Arto et al., 2016).

Huang and Hwang (2015) studies of residential apartments in Taipei, have observed that cooling demand could increase of 31%, 59%, and 82% over current levels respectively for the 2020s, 2050s, and 2080s. Thus, they have underlined an urgent need to regulate the excessive use of cooling systems, also by remodelling existing buildings with passive design measures. Discussions and new solutions for energy efficiency in building sector are thus indisputable (Huang and Hwang 2015).

By using water piping system, the exterior to interior heat transmission can be reduced, which results in interior thermal comfort and reduced energy consumption by air conditioners. The heated water in the piping system is stored in an insulated water tank and is used for domestic hot water to save energy. Integrating a solar thermal plant with the building envelope reduces the high cost of electric grids, but also generates the electric power by buildings demand. (<http://australia.energy.com>, n.d.).

3.4 Impact of BE on green building water efficiency system

Demand in every area of water use in urban, industrial, and agricultural has increased, often because of mismanagement, overuse, and waste. This clearly indicates that mismanagement, overuse, and waste of water in buildings is a strong issue that needs proper and lasting solution in order to be water efficient (Gottfried, 1996).

In the average household, 68% of drinking water is used for washing and toilet flushing. Laundry and dishwashing actions account for another 19%. The remaining water volume is used for drinking and cooking and also for garden watering and cleaning (Bauer and Schwarz, 2007). As such, Water efficiency in green buildings can be achieved through the combination of the following: systematic rainwater utilization, water conserving appliances, grey water and black water systems

- Rain water use: Systematic rainwater utilization reduces drinking water consumption by about half. Rainwater can be used for flushing, washing and cleaning, as well as for watering the garden. This requires a rainwater tanks and additional piping system.
- Water conserving appliances and technologies: Effective ways to reduce water use include installing flow restrictors and/ or reduced flow aerators on lavatory, sink, and shower fixtures; installing and maintaining automatic faucet/ tap sensors and metering controls; installing low-consumption flush fixtures, such as high-efficiency water closets and urinals; installing non-water fixtures.
- Grey water and black water systems: Grey water is the waste water from households, stemming from shower, bathtub, bathroom sink and the washing machine and which, hence, is not contaminated with faeces or highly polluted kitchen waste water (black water). It only contains a moderate amount of soap residue and skin oil. The average household produces about 60 liters of grey water per day, per person. This type of water can be processed into usable water, which is safe from a hygienic point of view but does not have the same quality as drinking water. It can be used for toilet flushing, watering and cleaning purposes. This means, in effect, that drinking water is then being used twice.

3.5 Impact of BE on green building day lighting efficiency system

Day lighting is the practice of bringing light into a building interior and distributing it in a way that provides more desirable and better-quality illumination than artificial light sources, reduces electricity use and its associated costs and pollution and creates healthier and more stimulating work environments than artificial lighting systems and can increase productivity up to 15 Percent (Romm and Browning, 1994).

Day lighting significantly reduces energy consumption and operating costs. Energy used for lighting in buildings can account for 40 to 50 Percent of total energy consumption. In addition, the added space-cooling loads that

result from waste heat generated by lights can amount to three to five percent of total energy use. Properly designed and implemented day lighting strategies can save 50 to 80 percent of lighting energy. Greater use of day lighting can also provide advantages for the environment by reducing power demand and the related pollution and waste by-products from power production. The greatest savings from day lighting occur during periods when sunlight is most intense, which coincides with periods of peak demand for heating, ventilating, and air-conditioning (HVAC) and refrigeration loads. Therefore, wider use of day lighting would reduce both the need for new peak demand capacity and overall power demand (Andersen windows 1993; Romm and Browning, 1994; Gottfried and Simon, 1996).

Day lighting requires the correct placement of openings, or apertures, in the building envelope to allow light penetration while providing adequate distribution and diffusion of the light. A well-designed system avoids excessive thermal gains and excessive brightness resulting from direct sunlight, which can impair vision and cause discomfort. To control excessive brightness or contrast, windows are often equipped with additional elements such as shades, blinds, and light shelves. In most cases, the day lighting system should also include controls that dim or turn off lights when sufficient natural light is available to maintain desired lighting levels. It is also often desirable to integrate day lighting systems with the artificial lighting system to maintain required task or ambient illumination while maximizing the amount of lighting energy saved. Recent day lighting innovations offer a wide range of advanced, highly efficient, and, in some cases, highly engineered systems. In reviewing these options, the practitioner should recognize that higher efficiency and improved day lighting performance may entail additional costs. The benefits of day lighting include improved visual quality, better lighting-colour rendition, reduced solar heat gain, and improved visual performance and productivity. These benefits can make any increased engineering and installation which costs a worthwhile investment for the building owner or employer (ibid).

The following include some of the day lighting strategies:

- Side lighting (Clerestories in form of windows etc.)
- Top lighting (Saw tooth, stepped monitored etc.)
- Sky lights (Horizontal openings in roof etc.)

New glazing technologies are also in use in green buildings which include:

- Spectral glazing materials
- Switch-able glazing materials
 - Photo-chromic glass
 - Thermo-chromic glass
 - Electro-chromic glass
 - Liquid crystal (LCD)

3.6 Impact of BE on green building indoor environmental quality (IEQ) system

People spend up to 90% of their time indoors, increasing their chances of exposure to pollutants and other indoor environmental stressors including noise, glare and uncomfortable temperatures (USGBC, 2007; WHO 2013).

The process or act of making the link between potential sources of pollution or discomfort and actual health and performance effects are very challenging tasks, involving the interaction of a complex array of variables within the building indoor. First, indoor pollutants may arise from many sources, indoor or outdoor, and may have chemical, biological, gaseous and/ or particulate elements. Second, these pollutants interact with a range of indoor conditions including varying levels of temperature, humidity, ventilation and occupant behavior. Third, levels of occupant exposure to indoor pollutants or stressors will vary based on circumstances, and actual physical reactions will vary not only by pollutant and its level but also by characteristics of the occupant.

The concept of Indoor Environmental Quality (IEQ) in green buildings is broad and complex because it encompasses a lot of design and construction factors. Such factors include but not limited to:

- Indoor air quality
- Thermal comfort (Heating, cooling and ventilation etc.)

- Lighting (Both electric lighting and day lighting)
- Acoustics etc.

It also includes access to views of the outdoors and all other factors affecting the full range of human sensory conditions inside the buildings.

4. ANALYSES, SUMMARY AND CONCLUSION

From above literature reviewed, it can be observed that any GB is an integrated building system where all the elements/ features impact each other in terms of functionality, usability, fitting and or assemblage. However, among the major elements/ features of GB identified in this paper were energy efficiency systems, water efficiency systems, day lighting systems, indoor environmental quality (IEQ) systems, the building envelope (BE) systems. The main focus here is the impact of BE on other features because it serve as the enclosure/ shell/ barrier between the exterior and the interior of any GB.

Several studies conducted reveal the impact of BE on other GB features summarised as follows:

- Energy efficiency system: The BE help in retaining the conditioning inside the GB while also preventing the outside weather condition coming inside. It also allows integrating and fixing of renewable sources of energy within its system. e.g. solar panels etc.
- Water efficiency system: The BE can incorporate additional piping works for grey and black water systems, so also the any additional tank and pipe works required for effective utilization of rainwater.
- Day lighting: The type and positioning of clerestories and glazing choices within the BE system highlights the high impact of BE on the day lighting system and strategies.
- Indoor environmental quality (IEQ): This encompasses indoor air quality, thermal comfort (heating, cooling and ventilation etc.), lighting (both electric lighting and day lighting), acoustics etc. Without an adequate BE system all the four subcomponents of IEQ will not be achieved. The control function of BE improves the indoor air quality, thermal comfort, lighting (especially day lighting) and acoustics within a building.

At this juncture, it is worthy to note that adequate BE system impact other GB features due to: the use of materials and construction technique in building envelope, it is also the point where illumination, ventilation or heat flows while also enclosing and separating the un-conditioned or conditioned interior of a building and the outdoor environment.

5. RECOMMENDATION

There is need for an in depth further study of:

- BE on each GB element/ feature over a long span of time to ascertain the actual impact of BE.
- BE impact based on the perception of professionals and other stakeholders
- Other green building features/ components/ elements should also be considered and researched on, so as to expose how they interact with each other.

REFERENCES

- [1] Arto I, Capellán-Pérez I, Lago R, Bueno G, Bermejo R. The energy requirements of a developed world. *Energy Sust Dev* 2016;33:1–13.
- [2] Building Design and Construction (BD&C), editors. 2003. White Paper on Sustainability: A Report on the Green Building Movement. Building Design and Construction (Supplement).
- [3] Carmona Andreu, Isabel and Tadj Oreszczyn. (2004). Architects Need Feedback on Environmental Performance. Jul-Aug 2004, Vol. 32 (4). Building Research and Information.
- [4] Casado, M.N., 1996. Edificios de Alta Calidad Ambiental. Alta Tecnología, Ibérica (ISSN 0211-0776).
- [5] Cleveland, Cutler J., and Christopher G. Morris. "Building envelopegy. Expanded Edition. Burlington: Elsevier, 2009. Print.
- [6] **David A. Gottfried and Lynn N. Simon (1996): Sustainable Building Technical Manual; "Green building design, construction and operations", sponsored by the USEPA and USGBC.**

- [7] Demographia (2016): Demographia World Urban Areas (Built Up Urban Areas or World Agglomerations) - 12th Annual Edition, April, 2016. Available at: <http://www.demographia.com/db-worldua.pdf>
- [8] Dorota A. Chwieduk (2016): Some aspects of energy efficient building envelope in high latitude countries. Solar Energy 133 (2016) 194–206. Available online at www.sciencedirect.com
- [9] ENSAR Group (2003). Sustainable Federal Facilities Task 2.1 Business Case. November 2002 workshop notes. Boulder, Co.
- [10] EUROSTAT (2011): "Consumption of energy" -Statistics Explained .Available at http://epp.eurostat.ec.europa.eu/statistics_explained/index.php/Consumption_of_energy
- [11] **Greg Kats (2003): "The cost and financial benefits of green building" – A report to California's Sustainable building task force.**
- [12] Haapio, A., Viitaniemi, P., 2008. A critical review of building environmental assessment
- [13] Huang KT, Hwang RL. (2015): Future trends of residential building cooling energy and passive adaptation measures to counteract climate change: The case of Taiwan Appl Energy. <http://dx.doi.org/10.1016/j.apenergy.2015.11.008> [Corrected proof].
- [14] IEA, Technology roadmap (2013): Energy efficient building envelopes. International Energy Agency, France 2013.
- [15] Joseph Romm and William Browning (1994): Greening the Building and the Bottom Line: Increasing Productivity through Energy-Efficient Design (Snowmass, Colo.: Rocky Mountain Institute, 1994).
- [16] K.I. Vatalisa, O. Manoliadisb, G. Charalampidesa, S. Platiasa, S. Savvidisa (2013): Sustainability components affecting decisions for green building projects. International Conference on Applied Economics (ICOAE) 2013. Procedia Economics and Finance 5 (2013) 747 – 756
- [17] Martínez-Montejo SA, Sheinbaum-Pardo C. **The impact of energy efficiency standards on residential electricity consumption in Mexico.** Energy Sust Dev 2016;32:50–61.
- [18] Mateus, R., Bragança, L., 2011. Sustainable assessment and rating of buildings: developing the methodology SBtoolpt –H. Build. Environ. 46, 1962–1971.
- [19] **Michael Bauer, Peter Mosle, Michael Schwarz (2007). "Green Building: Guide book For Sustainable Architecture". Springer publications**
- [20] Nejat P, Jomehzadeh F, Taheri MM, Gohari M, Majidd MZiA. A global review of energy consumption, CO2 emissions and policy in the residential sector (with an overview of the top ten CO2 emitting countries). Renew Sust Energy Rev. 2015;43:843–62.
- [21] Patricia Huedo, Elena Mulet, and Belinda López-Mesa (2016): A model for the sustainable selection of building envelope assemblies. Environmental Impact Assessment Review 57 (2016) 63–77.
- [22] **Peter Morris (2007). "What does Green Really Cost?" PREA QUATERLY**
- [23] Report: Financing the Energy Efficient Transformation of the Building Sector in EU. Available at <http://www.isi.fraunhofer.de/>; 2012
- [24] Salisu Gidado Dalibi (2012): Cost Impact Assessment of Green Buildings in China (A Case Study of Few Selected Green Building Projects in Shanghai, China). MSc. Thesis submitted to Hohai University Nanjing – Jiangsu Province of China.
- [25] **Salisu Gidado Dalibi (2014): Green Buildings: The Clients' & The End Users' Common Ground in Environmental Sustainability.** Nigerian Institute of Quantity Surveyors (NIQS) National Training Workshop: in Uyo, Akwa Ibom State of Nigeria. 9th – 11th October, 2014.
- [26] Salisu Gidado Dalibi, Hadiza Balarabe and Jamilu Bala MaiAuduga (2016): Green Buildings: A Concept aligning the interests of Stakeholders (Developers / Clients and End-users) in Estate Development Projects in Abuja - F.C.T (Federal Capital Territory), Nigeria. SBE16 International Conference on Sustainable Built Environment Hamburg Germany.
- [27] Sarkar,S. Bose, (2015): Comparative analysis of the thermal comfort and sustainability performance of traditional and modern buildings in the lower Himalayan region of Himachal Pradesh, India,in :M.Mani, P.Kandachar (Eds.), Design for Sustainable Well-Being and Empowerment, IIScPress and TUDelft, 2015,pp.475–489.
- [28] Sarkar,S.Bose, (2015): Thermal performance design criteria for bioclimatic architecture in Himachal Pradesh, Curr.Sci.109(9)(2015)1590–1600.
- [29] **Schwarz (2007). "Green Building: Guide book For Sustainable Architecture". Springer publications.**
- [30] Straube, J.F., Burnett, E.F.P. Building Science for Building Enclosures. Building Science Press, Westford, 2005

- [31] Syed, Asif. (2012): Advanced building technologies for sustainability. Hoboken, N.J.: John Wiley & Sons, Inc., 2012. 115. Print.
tools. Environ. Impact Assess. Rev. 28 (7), 469–482.
- [32] U.S. Environmental Protection Agency. (2009): Green Building Basic Information. at <http://www.epa.gov/greenbuilding/pubs/about.htm> Retrieved December 10, 2009.
- [33] URL: <http://australia.energy.com/envelope> – n.d
- [34] URL: <http://en.wikipedia.org/wiki/Abuja>. “the global encyclopedia”
- [35] USGBC (2007): A National Green Building Research Agenda November, 2007.
- [36] WECSI (2014): World Engineering Conference on Sustainable Infrastructure, November 2014, Abuja-Nigeria. Available at: http://www.wecsi2014.org/About_Abuja.php
- [37] WHO (2013): Combined or multiple exposure to health stressors in indoor built environments. An evidence-based review prepared for the WHO training workshop “ Multiple environmental exposures and risks” 16-18 October 2013. Edited by: Dimosthenis A. Sarigiannis

Investigating Critical Safety Performance Factors in Green Building Construction Projects: The Case of Singapore

HWANG Bon-gang^a, SHAN Ming^b, PHUAH Siong-leng^c, CHI Seokho^d, ZHU Lei^e

^a National University of Singapore, Singapore, bdghbg@nus.edu.sg

^b National University of Singapore, Singapore, bdgsm@nus.edu.sg

^c DTZ Debenham Tie Leung Property Management Services Pte. Ltd., Singapore, siongleng1990@gmail.com

^d Department of Civil & Environmental Engineering, Seoul National University, South Korea, shchi@snu.ac.kr

^e National University of Singapore, Singapore, bdgzl@nus.edu.sg

ABSTRACT

Green building construction sector has achieved a rapid development over the past two decades owing to an increasing global recognition for its environmental benefits. However, very limited research effort was made to investigate the safety performance in green building construction projects. This study aims to identify and assess the critical safety performance factors in green building construction projects in Singapore. To achieve these objectives, a comprehensive literature review and three preliminary interviews were carried out, followed by a questionnaire survey conducted with 30 Singapore-based construction companies. The survey results showed that **the top five critical safety performance factors are “safe operation of construction equipment,” “proper and effective two ways communication between the management and workers,” “management commitment towards safety,” “provision of personal protective equipment,” and “establishing a comprehensive companywide safety policy.”** This study contributes to the body of knowledge by exploring the critical safety performance factors in green building construction projects. The findings from this study can also help develop more effective strategies to improve the safety performance in green building construction projects.

Keywords: critical safety performance factor, green building construction projects, Singapore

1. INTRODUCTION

Based on a worldwide recognition for its efficacy of saving energy and resources consumption, green buildings have gained a remarkable momentum in numerous countries recently, and one typical representative is Singapore (Hwang et al., 2015). Singapore is a densely populated city-state with limited areas and resources, making green building a necessity rather than an option for this country (Agarwal et al., 2016). In 2005, the Singapore Government embarked on the green building movement by launching the Building and Construction Authority (BCA) Green Mark scheme. Since then, this country has advanced three rounds of Green Building Masterplans successively (i.e., Masterplans of 2006, 2009, and 2014) to promote the development of green buildings (BCA, 2014). Motivated by this comprehensive suite of schemes and plans, green buildings in Singapore have achieved a rapid development recently, and the number of green buildings in Singapore grew exponentially, from 17 in 2005 to over 2100 in 2014, which was equivalent to 25 percent of the total built-up area in the country (BCA, 2014).

According to the Workplace Safety Health Council (WSHC, 2014), construction, marine, and manufacturing, have been assessed as the top three unsafe industries in Singapore. The numbers of workplace minor, major, and fatal injuries in the Singaporean construction industry increased significantly from 1718, 133, and 22 in 2011 to 2686, 202, and 27 in 2014, respectively (WSHC, 2012, 2013, 2014). Moreover, the local construction industry has been accounting for the largest proportion of workplace fatalities in this country continuously since 2006 (WSHC, 2014). All these statistics show that construction safety remains a significant concern to Singapore.

Given the grave situation of construction safety in Singapore, and the fact that numerous green building projects are under construction in this country, it could be inferable that the safety situation in the green building construction industry of Singapore should be stressful. Nonetheless, current literature reveals that few studies have addressed the safety issues in green building construction projects. Therefore, this study attempted to bridge this knowledge gap by identifying and assessing the critical safety performance factors in green building construction projects in Singapore. This study contributes to the body of knowledge by exploring the critical safety performance factors in green building construction projects. This study is also beneficial to the industry as its findings can help the practitioners develop more effective strategies to improve their safety performances.

2. BACKGROUND

2.1 Green buildings

Green buildings are a particular type of building designed for optimum energy efficiency and constructed with a preference for natural, reclaimed and recycled materials (Hwang & Ng, 2013). These buildings provide healthier, more comfortable and productive indoor environments for occupants by maximizing the efficient usage of resources like energy, water and raw materials (Hwang & Leong, 2013). The American Society of Testing and Material (ASTM, 2009) maintained that green buildings provided the specified building performance requirements while minimizing disturbance and improving the function of local, regional, and global ecosystems throughout its entire building life cycle. Burnett (2007) described that the ideal green building should have five major features: integration with local ecosystems; closed-loop material systems; maximum use of passive design and renewable energy; optimization of building hydrologic cycles; and full implementation of indoor environmental quality measures.

2.2 Safety concerns in green building construction projects

Compared to traditional building construction projects, green building construction projects seemed to have imposed a higher safety risk to the workers. Walter (2011) stated that construction projects that were built to achieve Leadership in Energy and Environmental Design (LEED) certification accounted for a higher recorded injury rate than non-LEED buildings. Dewlaney et al. (2011) found that, compared to those on non-LEED projects, workers on LEED projects were subject to a 36 percent increase in laceration, strains, and sprains from recycling construction materials; a 24 percent increase in falls to lower level during roof work because of the installation of on-site renewable energy (e.g., photovoltaic panels); and a 14 percent increase in exposure to harmful substances when installing innovative wastewater technologies. Fortunato et al. (2011) expressed the similar concerns because their cases studies also showed that workers on LEED construction projects were exposed to work at height, with electrical current, near unstable soils, and near heavy equipment for a greater period of time than workers on traditional projects. The grave safety situation above implies that more efforts should be put in tackling safety issues in green building construction projects to improve their safety performances.

3. METHODOLOGY AND DATA COLLECTION

Despite the grave situation of safety in green building construction projects, few studies have examined the critical safety performance factors in such projects. Fortunately, studies that investigated safety performance factors in traditional building construction projects were abundant, which could provide solid support for this study. Based on a comprehensive literature review (e.g., Sawacha et al., 1999; Jannadi & Bu-Khamsin, 2002; Siu et al., 2003; Choudhry et al., 2008; Ulubeyli et al., 2014; Zhou et al., 2015), 39 factors that affect the safety performances in traditional building construction projects were identified. However, these traditional project related factors might have an issue of compatibility with the context of green building construction projects in Singapore. Thus, this study conducted interviews with three experienced industry experts to refine these 39 identified factors within the context of green building construction projects in Singapore. Finally, a total of 35 safety performance factors were finalized, as listed in Table 1.

Based on the results of the interviews, a questionnaire was developed and then disseminated to 102 BCA certified companies in October and November 2014. The questionnaire included the questions meant to profile the companies and respondents, and the questions meant to evaluate the significance of each safety performance factor using a five-point rating scale (i.e., 1 = least important, 2 = somewhat important, 3 = neutral, 4 = important, and 5 = most important). The survey received valid responses from 30 companies, yielding a response rate of 29 percent, which was consistent with the norm of 20 to 30 percent with most questionnaire surveys in the construction industry (Akintoye, 2000). The collected replies were from various construction-related organizations including 20 contractors, four consultant firms, three private developers, and three quantity surveyors. As for the respondents, 57 percent of them had at least three years of experience in undertaking green building construction projects, and 63 percent of them were holding top-level management positions like project director and project manager. Thus, obviously the respondents had sufficient knowledge and experience to address the research questions of this study. In addition, two statistical methods, namely, the Cronbach's alpha and one sample t-test, were used to analyse the data collected from the questionnaire survey. The Cronbach's alpha was employed to measure the internal

consistency or reliability of the data, while the one sample t-test was used to check whether each safety performance factor has significant impact on safety performance in green building construction projects.

4. RESULTS AND DISCUSSIONS

Data collected from the questionnaire were input SPSS Statistics 17.0 to perform the analysis, and the evaluation results as well as the relevant statistical analysis results were presented in Table 1. In this study, the Cronbach's alpha value of safety performance factors was 0.806, which was higher than the minimum threshold of 0.7 (Nunnally et al., 1967). Thus, the collected data were reliable. In addition, the mean values of all safety performance factors were statistically greater than 3, which was the test value of the one sample t-test. Thus, all the safety performance factors had significant influence on the safety performances in green building construction projects. It could be noted from Table 1 that the top five critical safety performance factors were "safe operation of construction equipment," "proper and effective two ways communication between the management and workers," "management commitment towards safety," "provision of personal protective equipment (PPE)," and "establishing a comprehensive companywide safety policy."

No.	Safety performance factors	Mean	Rank	Std. Dev.	p-value
1	Safety uncertainty	4.43	7	0.57	0.00*
2	Employee commitment/ participation towards safety	4.40	8	0.50	0.00*
3	Provision of safety training & seminar	4.30	15	0.60	0.00*
4	Reckless human behaviour / operations	4.37	11	0.49	0.00*
5	Knowledge of safety system	4.37	12	0.49	0.00*
6	Self-esteem	3.87	32	0.63	0.00*
7	Experience	4.47	6	0.57	0.00*
8	Fatigue in workers	4.03	24	0.61	0.00*
9	Incentives for increased productivity	4.07	22	0.83	0.00*
10	Safety obstacles (Interpersonal safety conflict/support)	4.10	21	0.55	0.00*
11	Proper and effective two ways safety communications between the management and workers	4.57	2	0.50	0.00*
12	Safety attitudes and behaviours of workers	3.90	30	0.66	0.00*
13	Safety attitudes and behaviours of supervisors	3.97	27	0.56	0.00*
14	Perceived level of risk / seriousness of accidents	3.83	34	0.59	0.00*
15	Supervisor's care for the workers	4.03	25	0.56	0.00*
16	Shortfall of safety regulation	4.30	16	0.53	0.00*
17	Performance pressure	4.40	9	0.56	0.00*
18	Overtaxing of workers	4.20	20	0.55	0.00*
19	Incorrect setting of safety screen	3.87	33	0.57	0.00*
20	Provision of proper tools and equipment	4.27	17	0.52	0.00*
21	Inadequate support for scaffolding	4.37	13	0.49	0.00*
22	Infeasible construction sequences	4.07	23	0.45	0.00*
23	Provision of personal protective equipment (PPE)	4.53	4	0.51	0.00*
24	Safe operation of construction equipment	4.60	1	0.50	0.00*
25	Toolbox check/brief	4.33	14	0.48	0.00*
26	Management commitment towards safety	4.57	3	0.50	0.00*
27	Management encouragement and support	3.97	28	0.41	0.00*
28	Safety awareness of management	4.27	18	0.45	0.00*
29	Regular safety talks	4.23	19	0.43	0.00*
30	Regular safety meetings	4.40	10	0.50	0.00*
31	Strong safety leadership role	3.97	29	0.56	0.00*
32	Promotional strategies	3.70	35	0.65	0.00*
33	Establishing a comprehensive companywide safety policy	4.50	5	0.51	0.00*
34	Housekeeping (proper storage of equipment)	4.00	26	0.59	0.00*
35	Tidy working environment	3.90	31	0.71	0.00*

Note: *The one sample t-test result is significant at the 0.05 significance level (two-tailed)

Table 1: Evaluation results of safety performance factors in green building construction projects

“Safe operation of construction equipment” was regarded as the top critical safety performance factor with the highest value of 4.60. Construction equipment are heavy machineries and vehicles that are used for executing construction operations. Construction equipment are also known as heavy machinery, which are used to perform construction tasks such as excavation, lifting, material handling, drilling, hauling, excavating, paving and grading. As for green building construction projects, there are numerous green featured construction tasks (e.g., constructing atria and installing green roofs, and photovoltaic panels) that must be completed with the assistance of construction equipment (Fortunato III et al. 2012). The improper operation of those construction equipment (e.g., cranes and loaders) can impose significant safety risks to the frontline workers and might incur serious injuries (e.g., caught-in injuries and struck-by or against injuries) to them. Thus, the respondents assessed the safe operation of construction equipment as the most critical safety performance factor in green building construction projects. Dewlaney et al. (2012) also emphasized that the proper operation of construction equipment was extremely important to improve the safety performance in those green building construction projects.

“Proper and effective two ways safety communications between the management and workers” was ranked second with a mean value of 4.57. Safety communication mainly refers to the extent, frequency, and effectiveness of the information exchanged on safety issues between the management and workers (Jiang et al., 2015), and **effective and proper safety communication could increase the workers’ safety awareness and knowledge and thus improve the project safety performance significantly.** Safety communications are more crucial to green building construction projects than to traditional building construction projects. This is because green building construction projects always adopt innovative and complicated green construction methods that might bring in some special safety regulations. With the aid of the proper and effective two ways safety communications, the site supervisor can inform the workers all the special safety regulations that must be complied with; while the workers can also have proper channels to report to the management about those hazards omitted by the manuals but existing in reality.

“Management commitment towards safety” was assessed as the third most critical safety performance factor in green building construction projects. **“Management commitment towards safety” mainly refers to a bunch of commitments made by the management,** such as the promise of achieving a high standard of occupational safety and health management for the project implementation, providing adequate resources to implement the safety policies, and ensuring the understanding and execution of safety measures at all levels in the organization. Safety commitments play a vital role in improving safety performance of building construction projects (Demirkesen & Arditi, 2015; Shen et al., 2015), and they are even more crucial to green building construction projects than to traditional ones. This is because normally the management pay so much attention to the sustainability performance of green building construction projects that they may neglect the safety performance of in these projects, while **safety commitments from the management can increase the practitioners’ awareness of construction safety,** restrain them from conducting unsafe operations, and thus improve the safety performance in green building construction projects eventually.

“Provision of personal protective equipment (PPE)” was ranked fourth with a mean value of 4.53. Nowadays, the construction industry has developed an integrated set of PPE to protect the frontline workers from any potential safety hazard. These PPE includes wearing safety helmets, safety shoes, and safety gloves, wearing hearing protection in noisy environments, putting on goggles or eye protectors while doing welding, wearing respirators in dusty conditions, using breathing apparatus when working in confined spaces, putting on a safety harness when working at height, and wearing a reflective vest where good visibility was required (Choudhry, 2014). PPE is even more critical to workers those working on green building construction projects because they are exposed to the toxic substances, work at height, with electrical current, near unstable soils, and near heavy equipment for a greater period of time than those working on traditional projects (Fortunato et al., 2011). Currently, provision of proper PPE has been included into many green rating systems (e.g., Green Rating for Integrated Habitat Assessment, India)(Pearce & Kleiner, 2013), indicating that its importance has been widely recognized by the authority and the industry.

“Establishing a comprehensive companywide safety policy” was considered to be the fifth most critical safety performance factor in green building construction projects. A safety policy of a construction company is a recognized written statement that states the company's commitment to the protection of the health and safety of the employees. It shows the details of all occupational health and safety elements with the policy to protect the

employees' life and health, and the relevant forms include the safety standard, safety regulations, safety procedures, and even the safety incentive programs (Choudhry et al., 2008). Establishing a comprehensive companywide safety policy is extremely important to those organizations working on green building construction projects. This is because can only a comprehensive safety policy cover all those special, hidden, and unexpected safety hazards brought by the green building construction projects. In addition, a comprehensive safety policy can **raise the employees' awareness of safety and health and provide** information and instructions to them on the relevant safety regulations and good work practices. Park and Tae (2016) also reached the similar conclusion that an integrated safety policy was crucial to the safety performance in green building construction projects.

5. CONCLUSIONS AND RECOMMENDATIONS

Owing to an increasing recognition for the environmental benefits brought by the green buildings, there has been a significant growth in green building construction worldwide over the recent years. Nevertheless, minimal research effort has been devoted to examine the safety issues in green building construction projects. This study attempted to make a preliminary investigation of safety performance factors in green building construction projects. Facilitated by a series of qualitative and quantitative research methods such as literature review, structured interviews, and questionnaire survey, this study identified and evaluated 35 safety performance factors in green building construction projects. Results showed that **the top five critical safety performance factors were "safe operation of construction equipment," "proper and effective two ways communication between the management and workers," "management commitment towards safety," "provision of personal protective equipment," and "establishing a comprehensive companywide safety policy."** The findings from this study have presented a general view on the critical factors that affect safety performance in green building projects, which can also help develop more effective strategies to improve the safety performance in such projects. Future studies could be conducted to investigate the interrelationships among these critical safety performance factors in green building construction projects. Also, it would be interesting to compare the safety performance factors between the green and traditional building construction projects.

ACKNOWLEDGEMENT

This work was partially supported by the Korean Federation of Science and Technology Societies (KOFST) grant funded by the Korean government (MSIP: Ministry of Science, ICT and Future Planning).

REFERENCES

- [1] Agarwal, S., Satyanarain, R., Sing, T. F., & Vollmer, D. (2016). Effects of construction activities on residential electricity consumption: Evidence from Singapore's public housing estates. *Energy Economics*, 55, 101-111.
- [2] Akintoye, A. (2000). Analysis of factors influencing project cost estimating practice. *Construction Management and Economics*, 18(1), 77-89.
- [3] ASTM, U. (2009). *Standard Guide for General Principles of Sustainability Relative to Buildings*. PA: Conshohocken.
- [4] BCA, S. (2014). *3rd Green Building Masterplan*. Singapore: Building and Construction Authority.
- [5] Burnett, J. (2007). City buildings—Eco-labels and shades of green! *Landscape and Urban planning*, 83(1), 29-38.
- [6] Choudhry, R., Fang, D., & Ahmed, S. (2008). Safety Management in Construction: Best Practices in Hong Kong. *Journal of Professional Issues in Engineering Education and Practice*, 134(1), 20-32.
- [7] Choudhry, R. M. (2014). Behavior-based safety on construction sites: A case study. *Accident Analysis & Prevention*, 70, 14-23.
- [8] Demirkesen, S., & Arditi, D. (2015). Construction safety personnel's perceptions of safety training practices. *International Journal of Project Management*, 33(5), 1160-1169.
- [9] Dewlaney, K., Hallowell, M., & Fortunato, B. (2011). Safety Risk Quantification for High Performance Sustainable Building Construction. *Journal of Construction Engineering and Management*, 138(8), 964-971.
- [10] Fortunato, B. R., Hallowell, M. R., Behm, M., & Dewlaney, K. (2011). Identification of safety risks for high-performance sustainable construction projects. *Journal of Construction Engineering and Management*, 138(4), 499-508.

- [11] Hwang, B. G., & Leong, L. P. (2013). Comparison of schedule delay and causal factors between traditional and green construction projects. *Technological and Economic Development of Economy*, 19(2), 310-330.
- [12] Hwang, B. G., & Ng, W. J. (2013). Project management knowledge and skills for green construction: Overcoming challenges. *International Journal of Project Management*, 31(2), 272-284.
- [13] Hwang, B. G., Zhao, X., See, Y. L., & Zhong, Y. (2015). Addressing Risks in Green Retrofit Projects: The Case of Singapore. *Project Management Journal*, 46(4), 76-89.
- [14] Jannadi, O. A., & Bu-Khamsin, M. S. (2002). Safety factors considered by industrial contractors in Saudi Arabia. *Building and Environment*, 37(5), 539-547.
- [15] Jiang, Z., Fang, D., & Zhang, M. (2015). Understanding the causation of construction workers' unsafe behaviors based on system dynamics modeling. *Journal of Management in Engineering*, 31(6). 0000350.
- [16] Nunnally, J. C., Bernstein, I. H., & Berge, J. M. t. (1967). *Psychometric theory* (Vol. 226): JSTOR.
- [17] Park, M., & Tae, S. (2016). Suggestions of policy direction to improve the housing quality in South Korea. *Sustainability (Switzerland)*, 8(5). doi: 10.3390/su8050438.
- [18] Pearce, A., & Kleiner, B. (2013). *The safety and health of construction workers on green projects*: Virginia Polytechnic Institute and State University.
- [19] Sawacha, E., Naoum, S., & Fong, D. (1999). Factors affecting safety performance on construction sites. *International Journal of Project Management*, 17(5), 309-315.
- [20] Shen, Y., Tuuli, M. M., Xia, B., Koh, T. Y., & Rowlinson, S. (2015). Toward a model for forming psychological safety climate in construction project management. *International Journal of Project Management*, 33(1), 223-235.
- [21] Siu, O.-I., Phillips, D. R., & Leung, T.-w. (2003). Age differences in safety attitudes and safety performance in Hong Kong construction workers. *Journal of Safety Research*, 34(2), 199-205.
- [22] Ulubeyli, S., Kazaz, A., & Er, B. (2014). Health and Safety Perception of Workers in Turkey: A Survey of Construction Sites. *International Journal of Occupational Safety and Ergonomics*, 20(2), 323-338.
- [23] Walter, L. (2011). "Green" Construction Workers May Face Additional Safety Risks. Retrieved August 16, 2014, from <http://libproxy1.nus.edu.sg/login?url=http://search.proquest.com/docview/906955972?accountid=13876>
- [24] WSHC, S. (2012). *Workplace Safety and Health, 2012*. Singapore: Workplace Safety Health Council.
- [25] WSHC, S. (2013). *Workplace Safety and Health Report, 2013*. Singapore: Workplace Safety Health Council.
- [26] WSHC, S. (2014). *Workplace Safety and Health Report 2014*. Singapore: Workplace Safety Health Council.
- [27] Zhou, Z., Goh, Y. M., & Li, Q. (2015). Overview and analysis of safety management studies in the construction industry. *Safety science*, 72, 337-350.

Green Interior Renovation by Architectural Services Department

Antony HO^a, Vicky NG^b, Eric POON^c, Shirley SETO^d, Vetus LAU^e, LC SHEK^f

^a Arup, Hong Kong SAR, antony.ho@arup.com

^b Arup, Hong Kong SAR, vicky.ng@arup.com

^c Architectural Services Department, Government of the HKSAR, Hong Kong SAR, pooncke@archsd.gov.hk

^d Architectural Services Department, Government of the HKSAR, Hong Kong SAR, setoky@archsd.gov.hk

^e Llewelyn Davies Hong Kong Ltd., Hong Kong SAR, yiptw@llewelynd.com

^f Electrical & Mechanical Services Department, Government of the HKSAR, Hong Kong SAR, lcshek@emsd.gov.hk

ABSTRACT

Architectural Services Department (ArchSD) supports the Government's role to promote low carbon buildings in Hong Kong and at the same time to share the good practices in our green building projects with the building industry. A holistic integrated approach from design to construction and then maintenance is adopted.

To demonstrate the good practice of sustainable project delivery at interior space, this paper introduces two renovation projects in which sustainable and sensible solutions have been implemented. They are the renovation of 1/F Main Block of APB Centre and the renovation of the 10/F Government Logistics Centre (GLC) into an administration office as part of the relocation project of the Printing Workshop for the Government Logistics Department (GLD).

APB Centre is a government building and ArchSD is the premises user. The renovation project at APB Centre was to transform the storage area at 1/F into a green workplace to demonstrate the good practice in achieving low carbon, healthy and modern **indoor environment**. **GLD's Printing Workshop relocation project involved the refurbishment and alteration works of 3 floors of the GLC at Chai Wan to accommodate the printing machineries and office accommodation.** The renovation works at 10/F has transformed the existing space into an administration office of the Printing Workshop with green and pleasant environment for the staff. Sustainable design in both projects was achieved through energy efficient air-conditioning and lighting design, sustainable materials selection, excellent indoor environmental quality, etc. In APB Centre project, an innovative radiant cooling system was also employed for the open office areas. Both projects have achieved Platinum ratings under the BEAM Plus Interiors accreditation and, in particular, the renovated 1/F Main Block of APB Centre is the first government office in Hong Kong achieving the Platinum Rating under this assessment system launched in September 2013.

6. INTRODUCTION

This paper introduces two renovation projects, commissioned by Architectural Services Department (ArchSD), in **which sustainable and green features and practices have been implemented. They are "the renovation of 1/F Main Block of APB Centre" and "the renovation of the 10/F Government Logistics Centre (GLC) into an administration office". Both projects have achieved the BEAM-Plus Interiors Version 1.0 Final Platinum.**



Site Plan



Renovated office area

The new ArchSD office transformed from an existing store is located on 1/F Main Block, APB Centre, Hunghom. It has an internal floor area of around 800m² accommodating about 100 staff. The renovation was completed in March 2015 and successfully demonstrated the feasibility of practice of a sustainable office renovation.



Government Logistics Centre



Reception

The refurbishment of the 10/F GLC is part of the relocation project of the Printing Workshop for Government Logistics Department (GLD). The refurbishment work has transformed the once unattractive space into a green and lively contemporary office for the Printing Division of GLD. The refurbished area is about 930 m² which mainly consists of open plan office, cellular offices, conference room, reception and balcony.

7. KEY FEATURES OF THE RENOVATION OF 1/F MAIN BLOCK OF APB CENTRE

The renovation project adopted a holistic approach on sustainable design, green construction, environmental friendly operation and maintenance to transform an existing office premises to a green workplace. Almost all furniture, partitions and electrical appliances in the new office were reused from the existing office to minimize purchasing of new items. Sustainable and innovative design strategies, such as radiant cooling system, indirect LED lighting, automatic control for building systems, water efficient fixtures, sustainable materials and flexible layout were integrated to create a low carbon, green, healthy and modern indoor environment to the office occupants.

The sustainable design features including interior space design, interior green wall, sustainable materials selection and energy efficiency features are described below:

3 Feature 1 – Sustainable materials

More than 97% of the furniture and partitions in the new office were relocated from the existing office and more than 80% of newly installed materials were from sustainable sources. The new office adopted bamboo for the wall covering (photo below refers) and skirting. Bamboo is a well-known rapidly renewable material having a harvest cycle of less than 10 years. The raised floor system (photo below refers) and carpet were made of recycled materials in the manufacturing process and the doors were made of sustainable timber.



Bamboo wall panel



Raised floor system and carpet were made of recycled materials

The project also planned for the reuse of building materials at the end of life cycle of the office. All newly installed elements are in modular design and easily disassembled in the next renovation for potential reuse.

4 Feature 2 – Waste management from demolition to operation

In demolition stage, the demolished concrete was reused in another ArchSD site, as the filling materials. In construction stage, recyclables were sorted and stored properly in the designated area to facilitate recycling from time to time. Over 98% of the demolition and construction waste (C&D waste) from the renovation work was recycled. In operation stage, several types of recyclables, including Paper, Metal, Plastic, Glass and Rechargeable Batteries are provided.



Demolished concrete was used in another site as filling materials



Recycle collection bins in the new office

5 Feature 3 – Energy

Energy Conservation Measures are applied in this project. The building automation control such as occupancy sensors are installed in the open plan office to turn off the lighting and air-conditioning system after office hours and daylight sensors are installed within 5 metres from the perimeter zones for dimming control, both helping reduce energy consumption in the office.



Occupancy sensors for lighting system

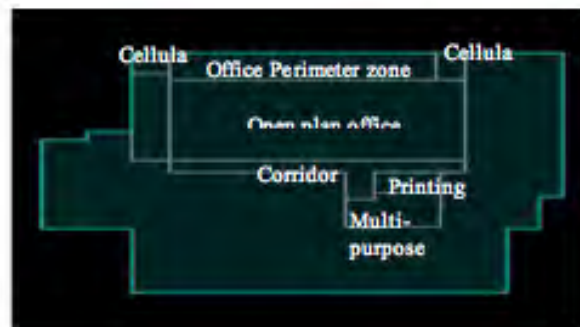

Energy model for the new office

Energy simulation for the baseline building was conducted by the software – eQUEST 3.64, which is a sophisticated building energy use analysis tool that provides professional results. eQUEST has all capabilities described in Appendix A – Building Energy Analysis of Code of Practice for Energy Efficiency of Building Services Installation 2012 Revision 1 (BEC 2012). The baseline building in this project's energy simulation runs used the assumptions and modelling methodology described in BEC 2012 with its addendum.

The predicted baseline annual energy consumption and carbon emissions of the office are 156.5 kWh/m² and 101.0 tonne CO₂ respectively.

The real time energy consumption of the office is monitored by the energy meters, temperature sensors and flow meters. The data are feedback to Building Management System (BMS). The real time consumption is transmitted to the environmental display system at the entrance of the office (photo below refers).



Real time environmental display system

The actual annual operating energy consumption and carbon emissions of the office in the previous year (Apr 2015 to Mar 2016) were 141.8 kWh/m² and 91.2 tonne CO₂ respectively. Therefore, the actual energy consumption is reduced by around 9% from the BEC2012 baseline.



Annual office energy consumption

6 Feature 4 – Indoor environmental quality (IEQ)

To analyse the distribution of indoor air temperature and air speed and evaluate the indoor thermal comfort, a three-dimensional Computational Fluid Dynamic (CFD) analysis has been conducted. The velocity distribution within the study area, which is affected by the office layout and the location of vent openings and mechanical fans, has been simulated under operating conditions. The thermal comfort simulation under steady-state full load conditions has also been carried out.

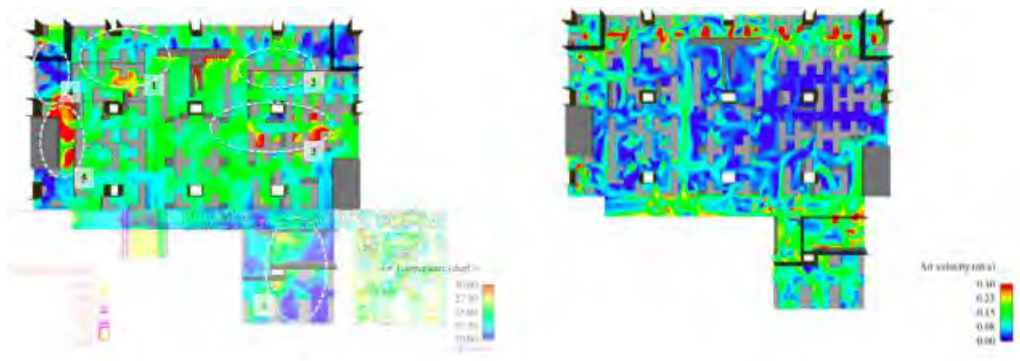

CFD models for air temperature and air velocity

A green wall serving as an air filter is installed in the main corridor of the office. Its combination with the air-conditioning system allows the return air from the office to pass through the green wall before recirculation. This helps refresh air supply to the office.



Bio-filtration green wall

Other key elements of IEO of the office include – A task light for every workstation, CO₂ sensors to monitor the CO₂ concentration and an independent local exhaust system provided for the printing room.

7 Feature 5 – Green roof

As part of the renovation, the existing podium roof has been transformed into a green roof with around 60 m² vegetated area. The greening can help minimize the urban heat island effect.



New green roof

8 Feature 6 – Innovation

Apart from the innovation features of real time energy use display and LED office light fittings and radiant cooling, another innovation approach is adopting the Building Information Modelling (BIM) for Operation and Maintenance in the office on 1/F Main Block, APB Centre. The BIM Application forms an accurate sharable 3D design information database of both the existing building and the new design, and can improve internal evaluation of the cross-disciplinary workflow.

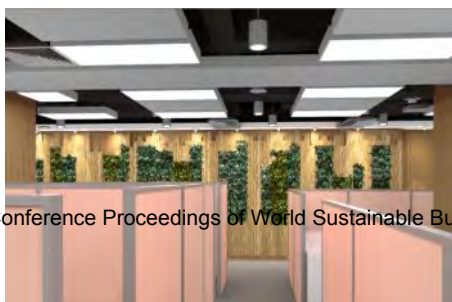

BIM Image

Site

Virtual vs Reality

8. KEY FEATURES OF THE RENOVATION OF THE 10/F GOVERNMENT LOGISTICS CENTRE INTO AN ADMINISTRATION OFFICE

The refurbishment work has adopted a green approach by using various sustainable design features to provide a pleasant working environment for staff. Excellent class in Indoor Air Quality has been achieved and certified by the Hong Kong Environmental Protection Department. The sustainable design features including interior space design, interior green wall, sustainable materials selection and energy efficiency features are described below:

3.1 Feature 1 – Views to outside and daylighting

In order to enhance the liveliness of the office space, workstations are laid out so that at least 65% of them would have a view to the external. Special design is adopted that the upper part of the office cubicle partitions being glazed to facilitate viewing from works stations to outdoor. It also allows employees to enjoy the natural daylight, external scene and reduce the use of artificial lighting.



Office layout plan



Section



New design of office cubicle partitions

3.2 Feature 2 – Interior green wall

Interior green wall is designed as a signature feature to enliven the indoor environment of the new office. It is located at the transition corridor from reception to the interior office space which brings a strong image about this green and sustainable office.



Interior green wall at the corridor

3.3 Feature 3 – Amenity space

The once redundant balcony has been successfully transformed into a welcoming relaxing space for staff. It is a precious opportunity for an office in an urban area to have a breakout space. Planting are provided along the balcony to soften the edge of the building.



External view from balcony



New designed outdoor balcony



Original

3.4 Feature 4 – Green materials

Materials with high recycled content, such as carpet and ceiling, are used in the refurbished office. Recycled timber decking is used at the balcony to match the images of outdoor environment. More than 50% of flooring, ceiling and door products are regionally manufactured materials.

Materials containing rapidly renewable materials such as wall panels manufactured from bamboo are used in the Conference Room. These bamboo panels are regionally manufactured.



Bamboo panels at the conference room

3.5 Feature 5 – Re-use furniture

As the project is a refurbishment project, a lot of existing furniture can be re-used in the new office. A majority of the furniture (over 70%) has been re-used in the new office. It helps to reduce a lot of wastage, transport and manpower for demolition.

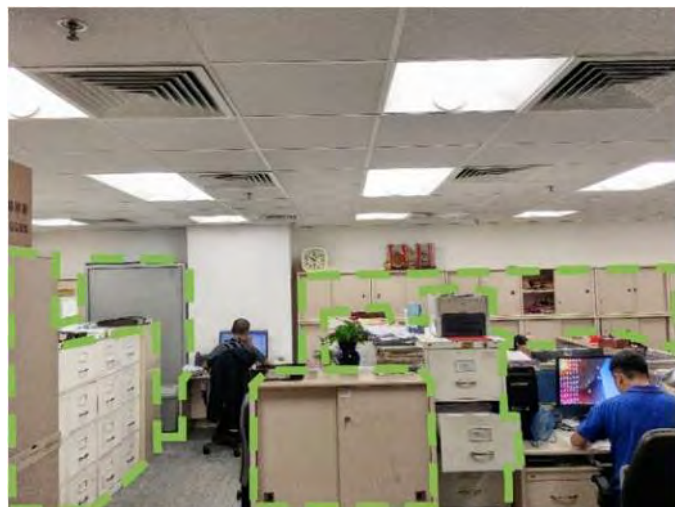

Layout of re-used furniture in the new office

3.6 Feature 6 – Waste recycling facilities

Facilities are provided for recycling glass and small electrical appliance in addition to the standard provision for recycling metal, paper and plastic.



Waste recycling facilities

3.7 Feature 7 – Energy efficiency

Different energy efficiency features have been adopted to reduce power consumption. The new office provides task light for every workstation and high efficient fluorescent lighting for the open plan office. Daylight sensors and occupancy sensors are installed to control the lighting and fan coil units in the office.

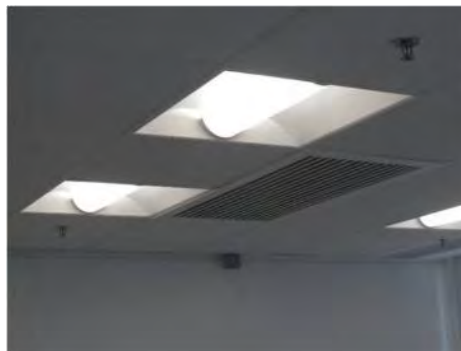

High efficiency lighting at office area

9. CONCLUSION

Finally, both projects have achieved Platinum Rating under BEAM Plus Interiors Accreditation after the successful transformation. ArchSD being the works agent for government properties has implemented green design not only in new development but also in renovation of existing buildings. These two projects demonstrated the sustainable design in existing premises through architectural layout design, lighting design, sustainable materials selection and good indoor environmental quality.

REFERENCES

- [28] BEAM Plus Interiors Manual [online] Retrieved from: <http://www.beamsociety.org.hk/files/Manual/BEAM%20Plus%20Interiors%20Manual.pdf> [Retrieved on 12 September 2016]
- [29] eQUEST [online] Retrieved from: <http://www.doe2.com/equest/> [Retrieved on 12 September 2016]
- [30] Code of Practice for Energy Efficiency of Building Services Installation 2012 Revision 1 (BEC 2012) [online] Retrieved from: [http://www.beeo.emsd.gov.hk/en/pee/BEC_2012%20\(Rav.%201\).pdf](http://www.beeo.emsd.gov.hk/en/pee/BEC_2012%20(Rav.%201).pdf) [Retrieved on 12 September 2016]

Session 3.9: Practices & Methodologies for Green Building Management (3)

Life Story of the Repurposed Shipping Container

Alice L. F. YEUNG^a

^a *Architectural Services Department, Government of the HKSAR, Hong Kong SAR, yeunglf@archsd.gov.hk*

ABSTRACT

Hong Kong has always had a high level of construction activity. This is a sign of prosperity; the waste generated by the construction has always been a problem. Construction waste is anything generated as a result of construction and then abandoned, regardless of whether it has been processed. It comprises surplus materials from site clearance, excavation, construction, refurbishment, renovation, demolition and road works. Every day, Hong Kong generate over 3 500 tones of construction waste. What if we could use the old to create something new?

This paper tells the story of collecting construction wastes and repurposed shipping containers for construction. What makes the unappealing shipping containers such an attractive choice for forward-thinking architects? These all-but-forgotten boxes are almost boundless starting with the industrial strength a steel box that can carry up to 30 tons. The real challenge with the stigma of the containers is how to create architecture out of them without compromising design quality.

Shipping container architecture gets a lot of encouraging coverage in the design world as a green alternative to traditional building materials, a smart choice for eco-consciousness. The story reveals the challenges and opportunities of reusing construction wastes and shipping containers and shares the case studies of Energizing Kowloon East Office (EKEO), the pilot trial of green site office in Government projects and the community green stations in Shatin and Hong Kong East, Hong Kong.

EKEO examines the possibilities of revitalize unattractive land, using left-over spaces under flyovers, utilizing modular construction approach by using recycled shipping containers and other steel structures for construction. Use of recycled, re-used and renewable materials to reduce building's energy footprint through practical and innovative sustainable measures in terms of site planning rather than intrusive mechanical installations.

Adopted construction wastes for the construction of the green site office and collected old plastic bottles to create office greening provides an alternative to traditional building materials for site office. A courtyard is introduced between the site office blocks, to create a different form of cooperation between the site staff and the contractor. When the site office was to be removed, the re-used components and materials would be collected again, to re-erect them for the site office of the next project.

The Community Green Stations, located in Shatin and Hong Kong East Hong Kong were pilot projects to implement the Government's "reduction first" waste management strategy. The challenge is how to use shipping containers to create a recycling station in our neighbourhood that would have positive impact on the community and treated sustainable design not a technique but our local culture. The buildings are composed of modular containers, while modified to suit the need of different functions.

Lean construction methods and low embodied energy materials would be the way to develop Hong Kong into a green and sustainable city.

Keywords: construction waste, lean construction, community green station

6. INTRODUCTION

The consultancy report published by Construction Industry Council (CIC) in early 2016 and said that construction waste generated in Hong Kong is on the rise, which is a concern for the community. In 2014, the overall

construction waste disposed of at landfills averaged about 3,942 tonnes per day, and amounted to 27 per cent of the total waste disposal.

Through four case studies - Energizing Kowloon East Office (EKEO), construction of temporary green site office and Community Green Stations in Shatin and Hong Kong East to present tangible ways in which we might begin to think, act and design differently. The building industry is beginning to approach the design of buildings in a fundamentally different ways by reusing construction wastes and repurposed shipping containers for construction and with the mind-set of using towards zero materials.

1.1 First ultra-low embodied carbon building: EKEO (Case study 1)

The EKEO is a champion of sustainability by using a raft of integrated green building technologies and features, **lean construction method and low embodied energy materials to become Hong Kong's first ultra low embodied carbon temporary office and first BEAM Plus Platinum Government Building**. The temporary office is located at a piece of unattractive land on a site under the Kwun Tong Bypass. The structure of Kwun Tong Bypass shades the roof of the building blocks of which it reduces solar heat gain and it provides lift-shelf effect to light up the courtyard inside the building. With passive design in mind at start to reduce the building energy footprint, building orientation is designed to align with the prevailing southeast wind to facilitate wind passage, planters and green wall are installed. Modular construction by using recycled freights containers and other steel structures, which can be easily dismantled and reused elsewhere in future are adopted in the design.

Recycled materials including paving blocks made from recycled aggregate, glass and fly ash from power plants. New highly efficient technologies/design such as air-cooled variable refrigerant volume air conditioners, T5 fluorescent tubes, daylight sensors to deliver savings in energy use and dual flush toilets, low flow taps and harvesting rainwater for irrigation to conserve water have been incorporated in the design.

Quantifiable features to demonstrate the building performance including projected annual operating energy consumption of about 88 kWh/m² and 32% reduction in energy consumption compared to design based on the requirement of EMSD Performance-based Building Energy Code (PBEC). About 52.2 tones CO₂-e per year and carbon reduction is 28.1 tonnes CO₂-e per year which is equivalent to 1.211 number of trees are projected annual carbon emissions related to the operation. Indoor ventilation rate is increased by more than 30% compared with the basic requirement by ASHRAE 62.1 to enhance IAO. Windows are provided on opposite sides of office area to facilitate natural cross ventilation. The advanced energy simulation software eQUEST is used for energy analysis.

1.2 First new model of green site office (Case study 2)

Every day, we generate over 3,900 tonnes of construction waste in Hong Kong and that includes wastes from the demolition of site offices no longer to be used. Hong Kong Government is committed to reducing the generation of C&D wastes in public works. To this end, we have conducted research and explored the type of prefabricated components to allow reuse in future and reduce C&D wastes, the market readiness to reuse the recycle old construction materials to create green construction office. To enhance a sustainable future of the construction industry, a more environmental friendly site office helps to promote a positive image of the industry in attracting a sustainable workforce.

The concept was to use the old to create something new. The site office for the Kai Tak Schools was the pilot trial; we collected used materials and components to construct the site office. When this first site office was to be removed, we collected the re-used components and materials again, to adapt them for the next site office of Kwun Tong School and further for other future projects.

Apart from adopting sustainable construction, the green site office also worked towards enhancing the working environment of site offices. A courtyard was introduced between the site office blocks, to create a different form of cooperation. Long ribbon windows and screens were used to connect the spaces, the courtyards, the offices and the garden, creating harmonious environment. This aims at shaping a new model for site offices, to re-distribute wastes and materials, and to provide a harmonious environment for our site staffs and contractors.

Essential quantifiable features including actual annual operating energy consumption is 230kWh/m² and actual annual carbon emissions related to the operation is 160kg of CO₂/m². The offices were sited to enhance cross ventilation and maximize use of natural lighting through long ribbon windows and screens while taking advantage of shelter from excessive daylight by sun decks and adjacent existing buildings. Roof greening was also installed to reduce heat gain to the offices below. As such, the contractors have reported average reduction of 20% electricity consumption.

1.3 First community green station: Shatin (Case study 3)

Shatin Community Green Station (CGS) is one of the first CGS in the 18 districts of Hong Kong. It serves for education on recycling and serving as resource collection station. The site is divided into the garden courtyard and the backcourt to serve the function of exhibition and workshop respectively. The buildings are composed of modular containers, while modified to suit the need of different functions. The idea of garden courtyard is to embody a sense of community and a touch of oasis within the heart of an industrial area. It creates multiple layer of space from public to private, from open space, semi-open space to enclosed area, as an interpretation of pavilions in Chinese garden. **These concepts of 'pavilion' and "veranda' are expressed in the exhibition space and circulation area, with diffusion of daylight through the bamboo trellis.**

As there will be no air-conditioning, the building envelope will open up to the courtyards to maximize cross ventilation together with the provision of large overhanging roof and vertical trellis/greening to shelter from the sun. Major components including the containers, bamboo and paving blocks are made of recycled or salvaged materials.

Although the building is temporary, it embodies permanent, cultural value, rediscover our roots and finds parallel with prevailing green features.

Essential quantifiable features including projected annual operating energy consumption is 147.5kWh/m² and actual annual carbon emissions related to the operation is 103.3kg of CO₂/m².

1.4 Community green station in an urban site: Hong Kong East (Case study 4)

The Hong Kong East Community Green Station (CGS) promoting green living and collection of recyclables at the community level in an urban setting. We do not want the Station to be a rubbish collection point, but a positive **asset to the local area. The concept is to create a 'Street' through the site to connect the surrounding communities.** Greenies of the nearby Park are extended to the old district through this urban intercourse. Through the use of green wall, bamboo trellis and courtyard garden, it creates an urban oasis within the city.

We reused the modular containers as the buildings yet modified to suit different functional needs. Various **sustainable initiatives and adopted to put the green culture of "Use Less, Waste Less" into practice. The flyover** above contributes to the passive cooling of the venues thus reducing solar heat gain. The provision of large overhanging roof and vertical greening can shelter the interior from the sun. Natural daylight is brought into the multi-purpose room by large Low-E glazing.

Employing the same technique we adopted in Shatin CGS, although the building also is temporary, we reinforced the cultural value and at the same time incorporate prevailing passive design and green features in the design.

Essential quantifiable features including projected annual operating energy consumption is 98.7kWh/m² and actual annual carbon emissions related to the operation is 70kg of CO₂/m².

7. CONCLUSION

In the pursuit of promoting material reuse and through the life story of reusing unappealing shipping containers, we have created interesting architecture, reinforce cultural value and at the same time find parallel with the prevailing green features to design building that gives back to the world as much as it takes. Now the next question is what more can we do to build a green and sustainable environment for our future.

REFERENCES

[31] Retrieved from <http://www.info.gov.hk/gia/general/201604/26/P201604260804.htm>

APPENDIX

Appendix 1 - EKEO



Rendering for entrance area of EKEO (Fig.1)



Photos of internal courtyard spaces and interior (Fig. 2, 3 & 4)

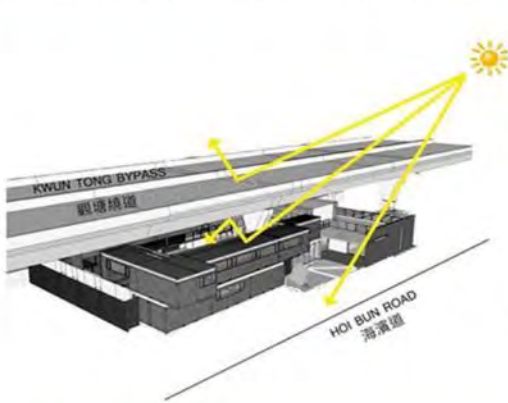

Roof as light shelf for day light reflection (Fig. 5)



Apertures designed for optimized natural ventilation (Fig. 6)

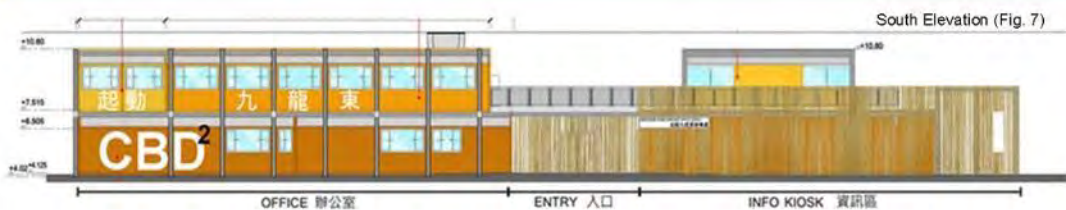

Appendix 2 - Green Site Office



1st generation of green site office at Kai Tak Primary School (Fig. 1)

2nd generation of green site office at Kwun Tong School (Fig. 2)

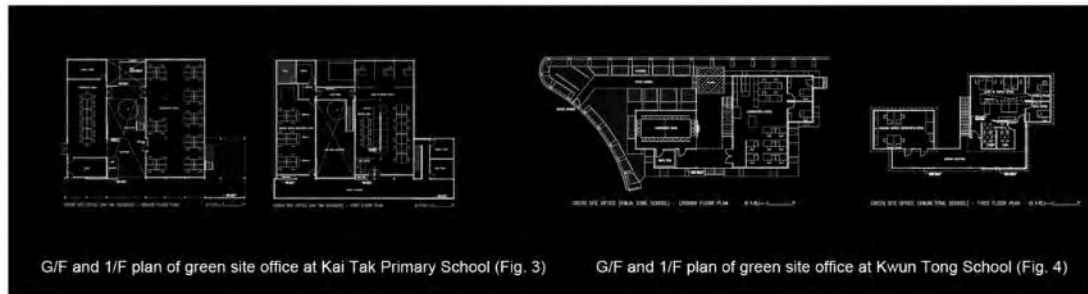

G/F and 1/F plan of green site office at Kai Tak Primary School (Fig. 3)

G/F and 1/F plan of green site office at Kwun Tong School (Fig. 4)



Roof greening (Fig. 5)



Sun deck (Fig. 6)



Modular plastic bottle planter rack (Fig. 7)



Meeting room with green wall (Fig. 8)



External screen (Fig. 9)



Office space (Fig. 10)



Re-use of trash building elements and materials (Fig. 11)

Appendix 3 - Community Green Stations



Transfiguring tradition - interpretation of pavilions in Chinese garden (Fig. 1)



Main Entrance (Fig. 2)



Isometric - layer of multiple spaces (Fig. 3)



Courtyard & semi-open space (Fig. 4 & 5)



Interior space with daylight (Fig. 6)

DESIGN CONCEPT



TRANSFORMATION

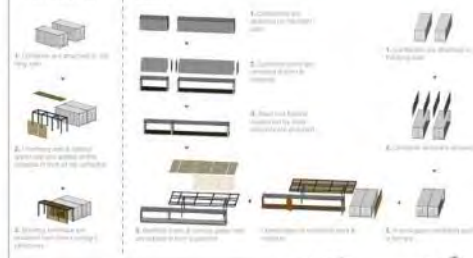

Modular container design (Fig. 7)

Creation of "street" through the site (Fig. 8)



Night view from Oi Shun Road (Fig. 9)

Factor Influencing Human Capabilities for Practicing Sustainable Facilities Management (SFM) - A Review

Fathima Sabrina NAZEER^a, Sachie GUNATILAKE^b, Thanuja RAMACHANDRA^c

^a University of Moratuwa, Sri Lanka, sabrinanazeer@gmail.com

^b University of Moratuwa, Sri Lanka, sachiegunathilake@gmail.com

^c University of Moratuwa, Sri Lanka, thanuja03@hotmail.com

ABSTRACT

Sustainable Facilities Management (SFM) has gained attention due to challenges in today's built and natural environments. SFM is regarded as the delivery of sustainability in facilities Management (FM) practice and this offers several benefits such as; improved productivity, greater financial returns, reduced detrimental effects on the environment and increased reputation. Despite this, it is identified that only few FM professionals are able to embrace the sustainability concept into their operations. Because sustainability efforts are ambiguous, multi-dimensional and generally not easy to understand. On the other hand, research focusing on the soft issues such as human capabilities, and skills are still lagging behind the efforts in developing knowledge portals, technical manuals and guidelines. Thus, this paper aims at developing a conceptual framework identifying the necessary human capabilities that are necessary to practice SFM.

Hence, this study is based upon reviewing the current literature in relation to SFM practices forming a basis to identify the potential paradigm for further research on identifying the required capabilities to practice SFM. The findings on literature review identified 49 human capability factors categorized under five main criteria in which most of the factors (23 factors) were identified in interpersonal competence criteria. Among these factors holistic thinking in systems thinking criteria received 54% showcasing to be the most important factor while 13 factors received 8% and identified to be less important. Hence, this paper theoretically evaluates the human capabilities and leads towards developing a conceptual framework to practice SFM. Hence, this paper highlights the relationship among human capability to practice SFM for FM practitioners through the development of conceptual framework.

Keywords: facilities management (FM), capability, sustainability, conceptual framework

1. INTRODUCTION

Traditionally, Facilities Management (FM) was regarded as an old fashioned profession which operates in the field of repairs, maintenance, cleaning and care-taking (Atkin and Brooks, 2005). In general, it was considered to be more technical-oriented and reactive (Barrett, 2000). Since then, FM profession has evolved and witnessed a rapid development (Meng, 2014; BIFM, 2016). It has moved from being a non-core function towards delivering strategic decision making (Alexander, 1994). In today's environment sustainability is regarded as an enabler in delivering strategic support which helps a FM practitioner to achieve sustained competitive advantage (Chotipanich and Lertariyanun, 2011). This is emphasized by BIFM (2016) stating that embracing sustainability in FM practice is recognized as a strategic response. Improved productivity, greater financial returns, reduced detrimental effects on the environment and increased reputation are some benefits attained through integrating sustainability in FM practice (Shah, 2007).

Hodges (2005) lists a number of capabilities that FM profession should possess in order to carry out sustainable practices in a holistic integrated manner. However, it appears that only few FM professionals are able to embrace the sustainability criteria into their operations (Lai and Yik, 2006). This is due to facts such as lack of specialist knowledge, tools (Hodges, 2005; Elmualim et al., 2009), unavailability of supportive case study materials (Elmualim, et al., 2009), gap between capability and skills (Hodges, 2005; Shah, 2007), unwillingness of Facility Managers and organisations to adopt changes (Elmualim et al., 2010) are repeatedly emphasized.

Further, it is identified that researches on sustainability in FM have primarily focused on approaches, benefits, barriers and stakeholder commitment (Elmualim et al., 2010; Hodges, 2005; Shah, 2007; Wyatt, Sobotka and Rogalska, 2000) while FM personnel's capabilities, skills and knowledge are yet to be researched (Elmualim et al.,

2010). However, Sarpin, Yang and Xia (2016) have highlighted this gap and identified 23 critical human factors that are important to practice SFM. But yet, this study have considered all functional levels of FM namely strategic, tactic and operational level as equal and specified that it require same capabilities. But Kincaid (1994) argues that each of these functional levels require different capabilities and skills to perform their different expected tasks. Further, Sarpin, Yang and Xias study also limits its content to human capabilities without addressing the importance of organisational capabilities. Dosi, Faillo, & Marengo (2008) emphasis that organisational capabilities are firm specific and helps to address the key problems in an organisation. Adding to this Moustaghfir (2009) states organisational capabilities helps to enable a firm to attain distinctive competitive edge. Further, capabilities cannot be identified despite the consideration of key factors such as facility type, scale of organisation (small, medium and large), organisation characteristics, business sector, local context and culture (Chotipanich, 2004). However Sarpin, Yang and Xia (2016) neglects to consider these key factors in identifying human capabilities.

Considering the knowledge gap outlined above, this paper initially critically reviews the current literature and aims to develop a conceptual capability framework to practice SFM. The first part of this paper identifies and integrates the possible capabilities pertaining to sustainable FM practice. It then presents the developed conceptual framework to practice SFM effectively.

2. CAPABILITY AND SUSTAINABLE FM PRACTICE

FM practitioners need certain capabilities to practice SFM. These capabilities are defined by Oxford Dictionary (2016) as the power or ability to do something. This may comprise of competence, experience and expertise a person possess (Ulrich and Smallwood, 2004). However, both Elliot and Dweck, (2005) and Takala (2011) define competence as the specialized system of abilities, attributes, proficiencies or skills that enable an individual to perform in various complex situations.

Environmental management or sustainability is considered as a complex process identified as HR intensive, which requires support from the area of human resources and the development of people capabilities and skills in order to guarantee the success of its implementation (del Brío and Junquera, 2003). Barney (1991) and Wright, McMahan, & McWilliams, (1994) emphasis that human resources are an important potential resource in an organisation to attain sustainable competitive advantage. This is due to the fact that human resources are rare, non-imitable, and non-substitutable who differ in range of capabilities, abilities, attributes and skills etc (Saa-Perez & Garcia-Falcon, 2002).

Hence, this points out the necessity of FM professionals to be highly capable with knowledge, skills, abilities, attributes, experience and values etc to practice SFM. On the other hand, from an organisational perspective, the organisational capabilities refer to particular forms of organisational knowledge that enable an organisation to perform its core operations (Dosi, Nelson and Winter, 2002). These are the collective competence, knowledge, skills etc of its individuals (Ulrich and Smallwood, 2004; Zollo and Winter, 2002), which helps the organisation to be firm specific in dealing with organisational problems (Dosi, Nelson and Winter, 2002). These capabilities are rather constant or stable and do not change rapidly. As organisational capabilities are developed over a long period of time, this in turn can give an organisation a sustained competitive advantage (Schienstock, 2009). This emphasize the importance of both the individual and organisation capabilities are highlighted in practicing sustainability in FM.

Following from above discussions, capability factors are identified under two areas namely; human capabilities (individual perspective) and organizational capabilities (organisational perspective). However, due to space limitations, this paper only focuses on presenting the human capability factors and developing a conceptual framework highlighting human capability as the initial input to practice SFM.

2.1 Human capability criteria and factors

Human capabilities can be judged on infinite variety of factors. This study adapts the framework developed by Wiek, Withycombe, & Redman (2011) for sustainable competence in which the author lists five main competences (which will be referred as criteria from this point onwards) as follows:

- Systems-thinking competence (ST) - allows a professional to build up their ability on collectively analyse the complex systems across different domains namely; environmental, social and economic etc and among different scales such as; organisation, local and global etc.
- Anticipatory competence (A) - the ability to jointly investigate, evaluate, and articulate the future related sustainability issues and sustainability problem-solving
- Normative competence (N) - the ability of assessing the current issue and then the creating more sustainable vision for that issue.
- Strategic competence (S) - the ability to design, implement, intervene and transform strategies towards sustainability agenda.
- Interpersonal competence (I) - refers to the ability to motivate, enable, and facilitate collaborative and participatory sustainability research and problem solving.

Altogether, forty-nine (49) human capability factors to integrate sustainability in FM were identified under the aforementioned five criteria. Table 1 summarises the findings on human capability factors under each of these five criteria.

	Human capability factors	Percentage	Source
	<i>System thinking capabilities (ST)</i>		
ST1	Holistic thinking or seeing as a bigger picture	54%	[2] [4] [5] [6] [7] [12] [13]
ST2	Understand the social justice, equity and challenges of sustainable development (SD)	23%	[2] [12] [13]
ST3	Understand both the natural and human systems and their interactions for sustainable development	15%	[4] [6]
ST4	Understanding how the core business activities create opportunities for other actors in society and how the company can make a contribution to sustainability;	8%	[1]
ST5	Understanding the social and environmental risks and opportunities of the company and its industry sector;	8%	[1]
ST6	Understand the competence demand of different stakeholders related to sustainability	8%	[1]
	<i>Anticipatory competence (A)</i>		

A 1	Act for long-term benefit	23%	[1] [6] [12]
A 2	Recognise any short and long term consequences of any plan or decision	23%	[1] [7] [12]
A 3	Ability in foresighted thinking	23%	[4] [9] [13]
A 4	Able to show the degree of global consciousness as a consequence of present activities	23%	[4] [7] [13]
A 5	Ability to realise their part and limitation in harming the environment	15%	[1] [6]
A 6	Identify the consequences of any actions with regard to environmental, social and economic pillars	15%	[6] [12]
A 7	Able to categorise direct and indirect consequences to environment and eco system	15%	[6] [12]
A8	Ability to think of the future generations welfare	8%	[6]
A 9	Possess a bright vision for future	8%	[5]
	<i>Normative competency (N)</i>		
N 1	Competency in trans-cultural understanding and interdisciplinary work	31%	[4] [6] [9] [10]
N 2	Competency in distanced reflection on individual and cultural models	23%	[4] [6] [9]
N 3	Value diversity, the environment and social justice	15%	[1] [11]
N 4	Able to change thought processes and values to develop an ecologically sustainable culture	15%	[1] [7]
N 5	Understand a variety of perspectives, values and beliefs and their implications for sustainability	15%	[1] [13]
	<i>Strategic competency (S)</i>		

S 1	Taking a strategic view of the business environment and build strategies for change	23%	[1] [2] [11]
S 2	Does not focus exclusively on cost and budgets (Understand Whole life-cycle cost (WLCC) and total cost of ownership (TCO) techniques)	23%	[1] [2] [12]
S 3	Develop organisations sustainability strategies considering the following areas: Environment management, community management, disaster management, energy management, waste management, corporate social responsibility (CSR), health and safety and WLCC etc.	15%	[3] [12]
S 4	Recognising that business does have responsibilities to the broader society.	8%	[1]
S 5	Building capacity and external partnerships and creating strategic networks and alliances.	8%	[1]
S 6	Develop good relationship with the organisations top management	8%	[12]
	<i>Interpersonal capabilities (IC)</i>		
I C 1	Communicating with passion	38%	[1] [2] [4] [8] [12]
I C 2	Critical thinking;	31%	[1] [2] [4] [11]
I C 3	Appreciating and embracing diversity;	31%	[1] [2] [11] [12]
I C 4	Team player	31%	[1] [2] [9] [12]
I C 5	Respect for people, society and environment	31%	[1] [2] [4] [11]
I C 6	The capacity to think outside the box.	31%	[1] [6] [10] [12]
IC7	Managing stakeholder network relationships;	31%	[1] [4] [12] [13]

I C 8	Problem solving and intellectual curiosity	23%	[1] [4] [11]
I C 9	Ethical practice, persistence, and tolerance.	23%	[1] [4] [6]
I C 1 0	Business acumen;	23%	[1] [2] [6]
I C 1 1	Listening skills;	23%	[1] [2] [4]
I C 1 2	Open-mindedness; Generosity	23%	[1] [6] [10]
I C 1 3	Self-motivation, Self-management, Self-assessment	23%	[1] [9] [12]
I C 1 4	well founded and balanced judgment and empathy	15%	[1] [9]
I C 1 5	Creativity, innovation and original thinking;	15%	[1] [2]
I C 1 6	Honesty and integrity	15%	[1] [2]
I C 1 7	Conviction and courage for original thinking	15%	[1] [10]
I C 1 8	The drive to contest resistance;	15%	[1] [6]

I C 1 9	Emotional intelligence	8%	[1]
I C 2 0	IT literacy	8%	[2]
I C 2 1	Reflecting on experiences and Maturity	8%	[2]
I C 2 2	Ability to work across disciplines	8%	[12]
I C 2 3	Ability to plan and implement sustainability efforts	8%	[12]
Sources:			
<ol style="list-style-type: none"> 1. Hind, Wilson, & Lenssen (2009) 2. Thomas, Barth, & Day (2013) 3. Wang, Wei, & Sun (2014) 4. Takala (2011) 5. Cruickshank and Fenner (2007) 6. Boyle (2007) 7. Burger & Christen (2011) 8. Crofton (2000); 9. de Haan (2006) 10. Kelly (2006) 11. Thomas, Hegarty and Holdsworth (2012) 12. Sarpin, Yang and Xia (2016) 13. Wiek, Withycombe and Redman (2011) 			

Table 68: Human capabilities for SFM

Among these 49 factors, 6 factors were identified under the system thinking criteria. Out of these 6 factors holistic thinking or seeing as a bigger picture have the highest percentage of 54% and understand the social justice, equity and challenges of sustainable development (SD) received the second important factor receiving a percentage of 23%. However, out of these 6 factors in systems thinking criteria 3 factors were identified to be least important receiving a percentage of 8%.

Under anticipatory competence 9 factors were identified in which act for long-term benefit, recognise any short and long term consequences of any plan or decision, ability in foresighted thinking and able to show the degree of global consciousness as a consequence of present activities attained equal importance receiving 23%. However, ability to think of the future generations welfare and possess a bright vision for future are identified to be least important factors receiving percentage of 8% each.

Normative competency (N) recognized to have 5 factors in which competency in trans-cultural understanding and interdisciplinary work was identified to be the very important factor receiving 31%.

In strategic competency factors namely taking a strategic view of the business environment and build strategies for change and does not focus exclusively on cost and budgets were identified to be most important factors receiving 23%. This was subsequently followed by factors such as; develop organisations sustainability strategies,

recognising that business does have responsibilities to the broader society building capacity and external partnerships and creating strategic networks and alliances and develop good relationship with the organisations top management in which the first received 15% and the rest considered to be least important factors with attaining equal importance of 8%.

Lastly among these 49 human capability factors most of the factors (23 factors) were categorized under interpersonal capabilities (IC). Here communicating with passion was identified to be the most important factor receiving 38% while 5 factors were identified to be the least important factor receiving a percentage of 8.

3. CONCEPTUAL FRAMEWORK FOR PRACTICING SFM – HUMAN CAPABILITIES

The conceptual framework for SFM was developed based upon the literature findings as shown in the Figure 1. This framework is categorized into four phases namely; FM input phase, FM process phase, FM output phase and impact phase. Each of these phases are elaborated as follows;

FM input phase - This is the initial step needed by a facilities practitioner to practice SFM. The framework suggests that human oriented capabilities (refer Table 1) are the basis input required to practice SFM.

FM process - The second step of the framework instructs how FM professionals need to do their work to achieve sustainability. For that purpose this phase holistically consider the components such as; life cycle, FM functions, people management practices and continual improvement as main area to consider. FM functions has been categorised under three broad functions; namely the strategic, tactical and operational functions (Alexander, 1996; Chotipanich, 2006; Patanapiradej, 2012). These each functions may have its own unique value adding criteria that collectively contribute to the value added facilities management function depending on the work carried out. Also these three FM functional levels require different capabilities and skills (Kincaid, 1994). Keeping this in mind this paper will propose capabilities required in terms of these each functional level. Further in this phase there are two more elements considered important to carryout FM process effectively which are;

- People management practice - This considered vital in an organisation because it influences employee skills, capability, knowledge and experience etc through the acquisition and development of an organisations human capital (Saa-Perez & GarLa-FalcOn, 2002). This refer to functions such as communication systems, reward systems, socialization systems and training programmes, work design, culture, leadership etc to act in the interests of the organisation to attain its goal (Schuler & MacMillan, 1984). To attain sustainable competitive advantage both human capital pool (highly capable skilled work force) and people management practice are required (Dunford, Snell, & Wright, 2001).
- Continual improvement; Any organizational activity to be successful it is very important to have a continues improvement strategy to achieve organizational goal (IAEA, 2006). There are many continues improvement strategies are available but this paper adapts Environmental Management Systems (EMS) - specification with guidance for Use ISO 14001:2005 (ISO, 2017). This will address the following components:
 - Environmental Policy: Continuously review environment related policies for any updates and amendments.
 - Planning
 - Implementation and Operation
 - Checking
 - Management review

This continual improvement component of the framework establishes a process for responding to change, capturing data and implementing processes within an overall goal or set of objectives to attain SFM practices for facilities practitioners.

FM output phase - This phase illustrates that if FM practitioners adhere to the above two phases effectively, then simultaneously would be offering best services while supporting development and maintaining good relationship with stakeholders.

FM Impact phase – Effective practice on this framework expects to be positively impacting on the surrounding specially focusing on environment, economic and social as well as on the core businesses results in satisfaction,

cost reduction, adaptability, culture management and highly reliable which will ultimately expect to lead towards SFM.

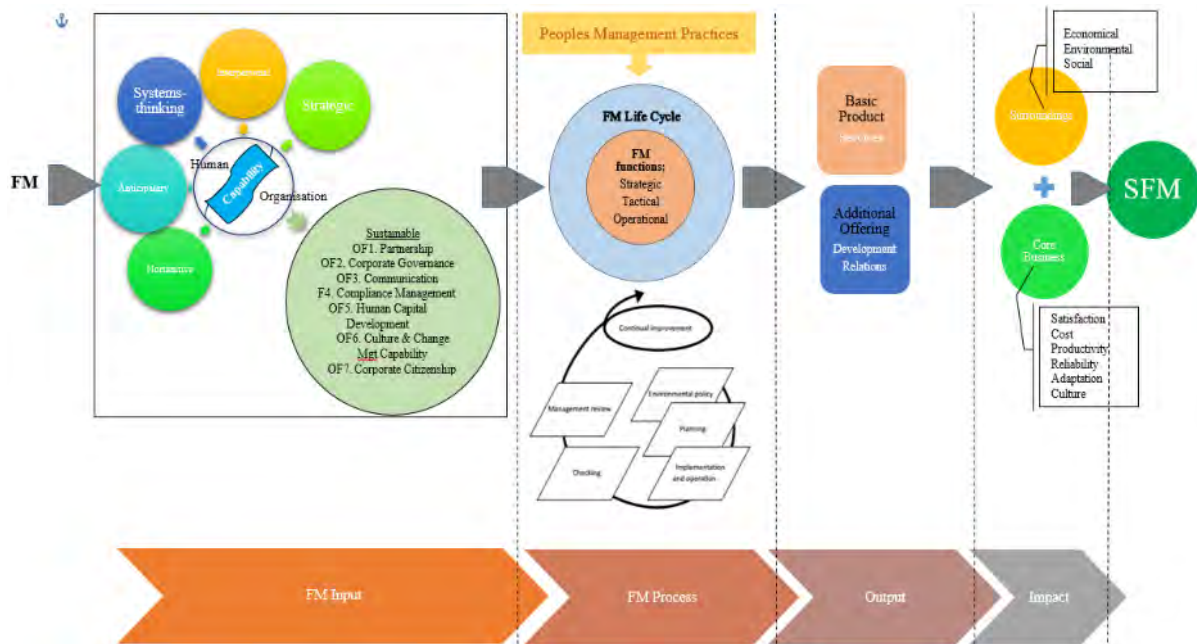

Figure 1

The conceptual capability framework as shown in the Figure 1 for SFM practice expects to provide strategic guidance to the facilities professionals (Facilities managers, property managers, maintenance managers, maintenance engineers, operational managers) who may be faced with the dilemma of practicing sustainability in FM.

4. CONCLUSION

Human capability is the enabler to practice SFM. The literature findings found 49 human capability factors categorized under 5 criteria as listed in Table 1. Among these factors holistic thinking or seeing as a bigger picture in systems thinking criteria received 54% showcasing to be the most important factor. However, 13 factors received 8% and identified to be less important. However, this findings are purely based upon the literature findings and the importance of factors will vary depending on key factors such as; facility type, scale of organisation (small, medium and large), organisation characteristics, business sector, local context and culture.

Further, this findings were carried forward to develop the conceptual framework to practice SFM. For that purpose this framework was organised in terms of four phases namely; FM input, FM process, FM output and impact phase. Among these four phases FM input phase emphasis human capability as the basic input to practice SFM and leads to other phases subsequently as shown in Figure 1. Also this framework will provide FM practitioners a new outlook on pinpointing on the required capabilities and how to master their skills to practice SFM.

5. FUTURE DIRECTIONS

Human and organisational capabilities are identified to be most important to practice SFM. However, this paper initially addresses on human capability perspective while future studies will be focused on addressing organisational capabilities.

Further, capabilities cannot be identified despite the consideration of key factors such as facility type, scale of organisation (small, medium and large), organisation characteristics, business sector, local context and culture where the FM practice takes place. Moreover, capabilities also cannot be determined in general for all FM scope and FM functional level namely strategic, tactic and operational. Keeping this in mind the future studies will intend to examine the capability requirements with the consideration of these factors.

REFERENCES

- [1] BIFM (2016). Sustainability in Facilities Management Report 2015. [online] Hertfordshire: The British Institute of Facilities Management (BIFM)., pp.1-25. Available at: <http://www.bifm.org.uk/bifm/knowledge/sustainabilityinfm/2015> [Accessed 26 Sep. 2016].
- [2] Alexander, K. (1994). A Strategy for Facilities Management. *Facilities*, 12(11), pp.6-10.
- [3] Atkin, B. and Brooks, A. (2005). Total facilities management. Oxford: Blackwell Pub.
- [4] Barney, J. (1991). Firm Resources and Sustained Competitive Advantage. *Journal of Management*, 17(1), pp.99-120.
- [5] Barrett, P. (2000). Achieving strategic facilities management through strong relationships. *Facilities*, 18(10/11/12), pp.421-426.
- [6] Baumgartner, R. and Ebner, D. (2010). Corporate sustainability strategies: sustainability profiles and maturity levels. *Sustainable Development*, 18(2), pp.76-89.
- [7] BIFM, (2016). BIFM - Facilities Management Introduction. [online] [Bifm.org.uk](http://www.bifm.org.uk). Available at: <http://www.bifm.org.uk/bifm/about/facilities> [Accessed 26 Sep. 2016].
- [8] Boyle, C. (2007). Considerations on Educating Engineers in Sustainability. *IEEE Engineering Management Review*, 35(3), pp.26-26.
- [9] Burger, P. and Christen, M. (2011). Towards a capability approach of sustainability. *Journal of Cleaner Production*, 19(8), pp.787-795.
- [10] Cagnin, Loveridge, & Butler, (2005). Business sustainability maturity model. Inity. Accessed 26 Sep. 2016]. *ity levels functional level namely strategic, tactic and operational*. Keepin http://www.crrconference.org/Previous_conferences/downloads/cagnin.pdf
- [11] Chotipanich, S. and Lertariyanun, V. (2011). A study of facility management strategy: the case of commercial banks in Thailand. *Journal of Facilities Management*, 9(4), pp.282-299.
- [12] Chotipanich, (2006). Positioning facility management: informed by case investigations in Thailand (Doctoral thesis (PhD)). University of London.
- [13] Crofton, F. (2000). Educating for sustainability: opportunities in undergraduate engineering. *Journal of Cleaner Production*, 8(5), pp.397-405.
- [14] Cruickshank, H. and Fenner, R. (2007). The evolving role of engineers: towards sustainable development of the built environment. *Journal of International Development*, 19(1), pp.111-121.
- [15] de Haan, G. (2006). The BLK elopment). The evolving role of engineers: towards -based model for Education for Sustainable Development. *Environmental Education Research*, 12(1), pp.19-32.
- [16] del Br), pp.19-32. ation Research *sustainable Development*. le of engineers: towards sustainable develoement in SMEs: implications for public policies. *Technovation*, 23(12), pp.939-948.
- [17] Donnellan, B., Sheridan, C. and Curry, E. (2011). A Capability Maturity Framework for Sustainable Information and Communication Technology. *IT Professional*, 13(1), pp.33-40.
- [18] Dosi, G., Nelson, R. and Winter, S. (2002). *The nature and dynamics of organizational capabilities*. New York: Oxford University Press.
- [19] Elliot, A. and Dweck, C. (2005). *Handbook of competence and motivation*. New York: Guilford Press.
- [20] Elmualim, A., Czwakiel, A., Valle, R., Ludlow, G. and Shah, S. (2009). The Practice of Sustainable Facilities Management: Design Sentiments and the Knowledge Chasm. *Architectural Engineering and Design Management*, 5(1), pp.91-102.
- [21] Elmualim, A., Shockley, D., Valle, R., Ludlow, G. and Shah, S. (2010). Barriers and commitment of facilities management profession to the sustainability agenda. *Building and Environment*, 45(1), pp.58-64.
- [22] Hind, P., Wilson, A. and Lenssen, G. (2009). Developing leaders for sustainable business. *Corporate Governance: The international journal of business in society*, 9(1), pp.7-20.
- [23] Hodges, C. (2005). A facility managers approach to sustainability. *Journal of Facilities Management*, 3(4), pp.312-324.
- [24] IAEA, (2006). Management of continual improvement for facilities and activities: A structured approach (p. 78). Austria: International Atomic Energy Agency. Retrieved from http://www-pub.iaea.org/mtcd/publications/pdf/te_1491_web.pdf
- [25] ISO, (2017). ISO 14001:2015 - Environmental management systems -- Requirements with guidance for use. ISO. Retrieved 15 January 2017, from http://www.iso.org/iso/home/store/catalogue_ics/catalogue_detail_ics.htm?csnumber=60857

- [26] Kelly, P. (2006). Letter from the oasis: Helping engineering students to become sustainability professionals. *nFutures*, 38(6), pp.696-707.
- [27] Kurnia, Mahbubur, Samson, & Singh,. (2014). Sustainable supply chain management capability maturity: Framework development and initial evaluation. In *Twenty Second European Conference on Information Systems*. Retrieved from <http://www.pacis-net.org/file/2014/2232.pdf>
- [28] Lai, J. and Yik, F. (2006). Knowledge and perception of operation and maintenance practitioners in Hong Kong about sustainable buildings. *aFacilities*, 24(3/4), pp.90-105.
- [29] Meng, X. (2014). The role of facilities managers in sustainable practice in the UK and Ireland. *Smart and Sustainable Built Environment*, 3(1), pp.23-34.
- [30] Munajat, & Kurnia,. *TOWARDS SUSTAINABILITY FRAMEWORK DEVELOPMENT: IDENTIFYING ORGANISATIONAL CAPABILITY FOR SUSTAINABILITY PRACTICES* (1st ed.). Retrieved from <http://www.pacis-net.org/file/2015/3035.pdf>
- [31] Moustaghfir, K. (2009). How knowledge assets lead to a sustainable competitive advantage: are organizational capabilities a missing link?. *Knowledge Management Research & Practice*, 7(4), 339-355. <http://dx.doi.org/10.1057/kmrp.2009.26>Oxford Dictionary, (2016). *kcapability - definition of capability in English |*
- [32] Oxford Dictionaries. [online] Oxford Dictionaries | English. Available at: <https://en.oxforddictionaries.com/definition/capability> [Accessed 27 Sep. 2016].
- [33] Patanapiradej, W. (2012). The Scope of Facility Management. *pJournal of environmental design and planning*, 79-90. Retrieved from http://www.arch.chua.ac.th/nakh_ara/files/article/Dy7iL83eICSun13529.pdf
- [34] http://www.arch.chua.ac.th/nakh_ara/files/article/Dy7iL83eICSun13529.pdfictionaries.com/definition/capability [Accessed 27 Sep. 2016].
The International Journal of Human Resource Management, 13(1), pp.123-140.
- [35] Sarpin, N., Yang, J. and Xia, B. (2016). Developing a people capability framework to promote sustainability in facility management practices. *Facilities*, 34(7/8), pp.450-467.
- [36] Schienstock,. (2009). Organizational capabilities: Some reflections on the concept. *Research Unit for Technology, Science and Innovation Studies (TaSTI)*. Retrieved from <http://nscfund.ir/cbd/wp-content/uploads/2016/04/Organizational-Capabilities-TAVANMANDSAZI.pdf>
- [37] Schuler, R. & MacMillan, I. (1984). Gaining competitive advantage through human resource management practices. *gy, Science and Innovation Studies (TaSTI)*. <http://dx.doi.org/10.1002/hrm.3930230304>
- [38] Shah, S. (2007). *cSustainable practice for the facilities manager*. Oxford: Blackwell Publ.
- [39] Takala, (2011). Sustainability competencies of engineers in the field of water supply and sanitation. In: *Helsinki World Sustainability Building Conference*. [online] Available at: http://www.irbnet.de/daten/iconda/CIB_DC23214.pdf [Accessed 28 Sep. 2016].
- [40] Thomas, I., Barth, M. and Day, T. (2013). Education for Sustainability, Graduate Capabilities, Professional Employment: How They All Connect. *Aust. J. environ. educ.*, 29(01), pp.33-51.
- [41] Thomas, I., Hegarty, K. and Holdsworth, S. (2012). The Education for Sustainability Jig-Saw Puzzle: Implementation in Universities. *ICreative Education*, 03(06), pp.840-846.
- [42] Ulrich, D, & Smallwood, N 2004, Capitalizing on Capabilities, *iHarvard Business Review*, 82, 6, pp. 119-127, Business Source Complete, EBSCOhost, viewed 27 September 2016.
- [43] Wang, N., Wei, K. and Sun, H. (2014). Whole Life Project Management Approach to Sustainability. *Journal of Management in Engineering*, 30(2), pp.246-255.
- [44] Wiek, A., Withycombe, L. and Redman, C. (2011). Key competencies in sustainability: a reference framework for academic program development. *tSustainability Science*, 6(2), pp.203-218.
- [45] Wright, P., McMahan, G. and McWilliams, A. (1994). Human resources and sustained competitive advantage: a resource-based perspective. *pThe International Journal of Human Resource Management*, 5(2), pp.301-326.
- [46] Wyatt, D., Sobotka, A. and Rogalska, M. (2000). Towards a sustainable practice. *dFacilities*, 18(1/2), pp.76-82.
- [47] Zollo, M. and Winter, S. (2002). Deliberate Learning and the Evolution of Dynamic Capabilities. *Organization Science*, 13(3), pp.339-351.

Sustainable Construction: Quality of Life of Construction Workers in Private Sector: Case Study of L.P.N Development Public Co., Ltd.

Pimchanok SRIRUTTRAKUL^a

^a *Wisdom Consulting and Solution, Thailand, sriruttrakul.p@gmail.com*

ABSTRACT

Sustainable construction often refers as the processes that are environmentally responsible and resources-efficient. Most efforts for sustainable building focuses on the construction management and less to human resources management. As a vital part of construction process, contributing towards sustainable development the **construction worker's welfare is something cannot be neglected.**

One of the biggest real estate development company in Thailand, L.P.N. Development Public Co., Ltd., have made commitment to continuously enhance its long-standing dedication to Corporate Environment and Social Responsibility (CESR) is demonstrated, and promote and take part in corporate social and environmental responsibilities with in and after process in line with sustainable development principles. L.P.N. has developed a set of core values that emphasizes performance standards in sustainability for construction workers. By **considering construction workers as one of the resources involves in the built environment, the workers' welfare** must be sustained as well. The company has taken care of workers in all dimension from working condition, **workplace safety, living quarter aim to enhancing and supporting workers' wellbeing.**

Green Construction Workers camp practical guidance, developed by L.P.N., sets out new commitment to improve the **workers' quality of life. The company aims build a healthy-hygiene durable and remote camp** that feature accommodations, kitchen and facilities, recreation spaces to encourage workers to work efficiently while avoid negative environmental impact on neighborhoods.

Inside living quarter the company provides safe spaces for children of construction workers to learn and play. These spaces have been established at a number of L.P.N. construction sites. Children are given a safe environment assuring the on-site construction workers that their children are in a safe and sound environment. The company also foresee the importance of early childhood development, by providing caretakers to teach them a basic knowledge, thus they can have equal opportunities with other children in the society.

Keywords: corporate social responsibility, construction workers, construction camp

1. INTRODUCTION

The implementation of 'Sustainable Development' and green construction practice has become priority for many developer, many real estate companies are focusing on integrate environmentally responsible principles into real estate industry and build up new policy initiatives. The challenges of developing sustainable framework is how to shift the paradigm of the investors, proves that socially responsible or sustainable real estate development does **more than turn a profit. The concept of "Triple Bottom Line; People, Planet and Profit" theory was adopted as a** part of sustainable strategy to real estate investing aiming to achieve the result in long-term profitability, reduce negative environmental effects of development and contributing social responsibility.

L.P.N. Development Public Co.,Ltd. is the developer of residential condominiums for middle to low income group of customers at the affordable price in Thailand. The vision and mission of the company stresses the importance of all stakeholders. The Company does not only focus on financial aspect of the operation but the environmental and social responsibility one also. As the leader of **residential condominium development under "Lumpini" brand,** the Company is well aware of direct environmental and social impacts as a result of large-scale project development. It is thus ensured that all operational processes are strictly controlled and the organization is managed to enhance the sustainability of the business operation.

In order to develops integrated values in the operation in all departments to be delivered to the stakeholders, society and environment the Company strives to be a "Value Organization" that gives importance to the

sustainability in all aspects according to "6 Green LPN" concept including; Green Enterprise, Green Financial Management, Green Marketing Management, Green Community Management, Green Design Concept, and Green Construction Process

2. L.P.N GREEN CONSTRUCTION

In early 2014 L.P.N. decided to standardised the company's construction process and set up the standard in L.P.N. way, and successfully implement in all construction project in 2015. It helps codified best practices and methods of how to construct sustainably, reduce construction project disturbances to neighbouring properties, rainwater systems and the site itself. Brainstorming workshop are usually held twice a year to develop construction process standard and construction pollution prevention plan as construction can cause a risk of producing pollution into the environment which can affect the neighbourhood and local ground. It is vital to control the impact of construction activities on human and environmental health.

L.P.N. Green Construction Process **Standard concentrate on a construction manager's roles and responsibilities** during the construction phase of a project not only to minimizing the impact of construction activities but also enhancing the quality of life of construction worker as well. Moreover, random checks and on-site visit by L.P.N. staffs are usually occurred once a month throughout the project duration to ensure that the standard practices are implemented on-site properly.

3. CONSTRUCTION WOKERS; QUALITY OF LIFE

Working in building construction sector related with building material and life-risking task, due to workplace surroundings. Adequate safety equipment must be provided in order to preventing harm in the workplace, keeping workers healthy and safety, and reducing the severity of accident that may occurred on construction site. All workers need to be trained to acknowledge basic first aid and to avoid any unsafe conditions Furthermore, safety meeting will be held every morning in order to remind them to work carefully and safe.

In order to ensure that working environment is harmless to the construction workers' health air and noise pollution are conducted once a month, since construction activities is the main cause annoyance and affect the health.

In terms of living conditions, construction labours are mostly migrating from different provinces or different countries into the city centre. They move from place to place, depended on the project they are working with their families and live in the place provided by the owner of the construction company or somewhere nearby, building temporary shelters. In order to achieve maximum mobility, most of the shelter are construct roughly by steel and wood structure, lack of safety inspection and vulnerable to weather conditions. The labours live there for the duration of the construction project which may last for years before move to other project, forcing them to live in an extreme condition.



Figure 1: Shelter for construction workers

L.P.N. has developed a set of core values that emphasizes performance standards in sustainability for construction workers. The standard has been set to improving housing condition for workers. By considering construction

workers as one of the resources involves in the built environment, the workers' welfare must be sustained as well. The company has taken care of workers in all dimension from working condition, workplace safety, living quarter aim to **enhancing and supporting workers' wellbeing.**

3.1 Construction workers camp; practical guide

L.P.N. oversees housing for construction workers and set up standard regarding their living conditions, such as fire safety, living space and sanitary. The typical standard camp made entirely from steel structure and metal sheet. Provided appropriate protection against heat, rain and, in particular, insects. These are less vulnerable to weather condition, although metal sheet roof still lead to heating up the living quarters, the ventilation is good enough it can cool down the space quickly.

Furthermore, the company is ensure that the housing which is provided is not overcrowded, be in good condition and not pose a risk to the health and safety.



Figure 2: L.P.N. construction camp

In the camp, there is also recreational space and health facilities for workers to relax and exercise while they not at work, **encouraging the worker's wellbeing.**



Figure 3: Recreational space for construction workers

Instead of letting the workers cook inside the temporary house causing fire risk and being unclean, the company provided common kitchen area for workers. They will bring their own kitchenware and ingredients to cook together, influence people to interact with others.



Figure 4: Common kitchen area in construction camp

For drinking water, washing clothes and bathing. The company arranged number of drinking water machine, washing machine for the construction workers. The toilet facilities are also conveniently accessible and clean. Sanitary inspections conducted at least once every 3 months to assure that all facilities are in a sanitary condition.



Figure 5: Basic amenities: drinking water machine, washing machine and toilet facilities

3.2 Children in construction site

The company provides safe spaces for children of construction workers to learn and play. These spaces have been established at a number of L.P.N. construction sites. It is a standard nursery room and playground area for children while their parents are working, instead of let them wandering around construction site and risk their life. The children in construction camp are given a safe environment assuring the on-site construction workers that their children are in a safe and sound environment.

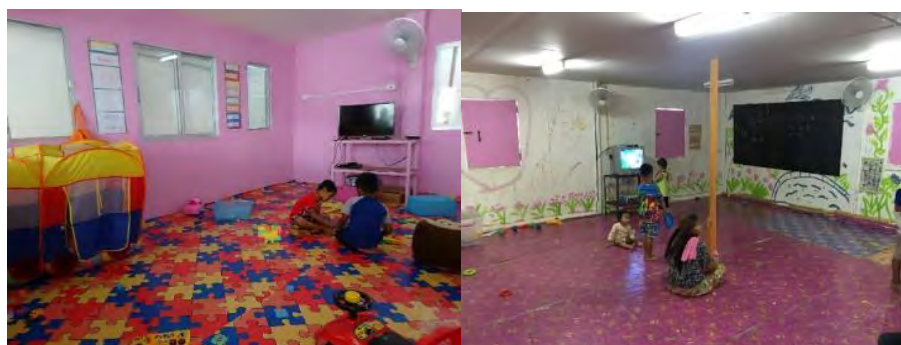

Figure 6: Nursery room at L.P.N construction sites

The room are well manage, clean and organized. There are basic educational aid and toys provided for the children as the company also foresee the importance of early childhood development, by providing caretakers to teach them a basic knowledge and Thai language for alien children.

Day/ Time	9.00-10.00	10.00-11.00	11.00-11.30	12.00-13.00	13.00-14.00	14.00-15.00	15.00-16.30
Monday	Thai practice	Watching Cartoon	Lunchtime	Sleep	Drawing and Painting	Watching Cartoon	Playtime
Tuesday	English practice	Dancing	Lunchtime	Sleep	Playtime	Watching TV	Playtime
Wednesday	Basic Match	Watching TV (English Program)	Lunchtime	Sleep	Playtime	Watching Cartoon	Meditation
Thursday	Thai	Watching TV	Lunchtime	Sleep	Drawing	Watching Cartoon	Playtime
Friday	English	Watching	Lunchtime	Sleep	Drawing	Watching Cartoon	Meditation
Saturday	Basic Match	Watching TV	Lunchtime	Sleep	Playtime	Watching TV	Playtime
Sunday	Thai	Watching Cartoon	Lunchtime	Sleep	Playtime	Watching Cartoon	Meditation

Figure 7: Example of class schedule for children in construction camp

By organizing classes in the construction camp managed to give the children an experience of learning thus they can have equal opportunities with other children in the society.

4. CONCLUSION

By considering construction workers as one of vital resources of the company. L.P.N. has develop the standard regarding the quality of life of the labours, aiming to improve both on working condition and living condition. After 2 years of implementing the standard, it is clear that L.P.N. construction camps become a high quality camp site, ensuring good standard in living facilities, and enhance the quality of life.

By applying this standard the labours' welfare is raising up variously, benefit includes; less turnover rate in employment, reduce serious accident, minimizing negative environmental impacts on neighbouring area, improving a better living environment for children of construction workers, and helps them work more efficiently.

L.P.N. is one of Thai developers who step up and take serious responsibility in construction workers' health, safety and living condition. The company makes a public commitment by setting a standard, not just to be a policy or guidebook but to protect and promote the worker's rights in the construction industry. L.P.N. will continually manage the construction process to ensure the high standard of practice has been carried on, and to collaborate with other stakeholders, in order to support the company's vision and mission of sustainable strategies.

Mining for Resources: Problem-Oriented Building Information Management and Development of Agile Facility Management Methodologies Through Industry-University-Public Collaborations

Yu MORISHITA^a, Bumpei MAGORI^b, Tomonari YASHIRO^c

^a The University of Tokyo, Japan, ymorishi@iis.u-tokyo.ac.jp

^b The University of Tokyo, Japan, magori@iis.u-tokyo.ac.jp

^c The University of Tokyo, Japan, yashiro@iis.u-tokyo.ac.jp

ABSTRACT

Advanced information-embedded buildings are considered to bring opportunities for mining data for the purpose of revenue improvement and cost reduction, resources that will enable sustainable service provision and facilities management (FM). While the initial cost of informatization of buildings are still high, the onsite reality of existing facilities in operation alludes to necessity in development of problem-oriented information management methodologies, where it is hardly possible to obtain complete data of the whole of the building as in the case of new construction. The paper illustrates the development of agile facility management methodologies through the case of 3-year industry-university-public collaborations onto an existing facility complex. The exemplary case was Okinawa Convention Center, 29 years old, large-scale (55,000m²) convention and cultural facilities complex in Japan, where the operational cost was overwhelming its annual revenue. A 3-year collaboration began with filling the gap of information that allowed for overarching, cross-stakeholder 'mining' of recourses out of the existing built environment. The development of the management methods focused on problem-oriented quantification that is operationally effective to the actuality of the building operation over the years. Mining of data thus targeted, 1: energy and environment monitoring toward an adequate billing system, 2: project monitoring toward the re-evaluation of maintenance budgeting, 3: monitoring of shift in demand in original design and renovation method re-evaluation and resource reorientation, and 4: maintenance record monitoring toward the identification of unexpected risk reduction. The result displays the outcome development of methodologies for agile FM through showcasing the quantified improvement through each instance of resource mining. The collaboration resulted in a set of communications where the shift from as-built maintenance to profit-oriented improvement of the existing environment was agreed.

Keywords: agile management, information management, facility management

1. INTRODUCTION

1.1 Background

Recent technological advancements in sensors, networks, as well as software has brought the building industry into a new paradigm of advanced information-embedded buildings. This concept embraces the utilization of building information to conduct better management of the facility as well as value production, which had previously been untouched. However, much of the discussions on technological applications are based around new construction. Since the proliferation of the concept of Facility Management (FM) in the 1980's (Rondeau et al. 2006), the information management of the operational phase of the facilities have slowly become a norm for the building industry, yet there are many buildings and organizations that have not caught up on the actual operational level. Discussions on strategically aligning the FM often begin with an information inventory, where building the database determines its operational planning, then down to project planning (Rondeau et al. 2006). However, the realities of older buildings are an unavailability of information stock, which are either too obsolete or too incomplete to initiate the inventory processes necessary for strategic FM implementation. Such cases of information production require large investments, where the financial capability of the organization hinders the previously aligned priorities of financial plans for facility improvement on the hardware side, such as overhauling mechanical equipment. These info-less facilities need more agile and small-scale project-based information production methodologies to initiate their informatization processes, resulting in mid-range schematizations of their FM strategies.

1.2 Previous studies

The data requirements or guidelines for each FM organization are diverse, where they are often prepared by each organization itself. It is an ad hoc combination of tools that is supporting different FM projects, where industry standards are yet to be established (Teicholz & IFMA Foundation 2013). In order to establish individualized yet workable management systems for each facility, FM stakeholders must necessarily undertake the management processes which best fit and are adaptable for their own organizations. To initiate such processes under uncertain, info-less situation, the agile management methodology suggests some potential in the “action first” mode of operation. Since the release of a statement in 2000, agile project management methodology (Beck et al. 2001) has seen a few cases of adaptation in the construction industry (Everts et al. 2011). Since the methodology itself has not yet become wide spread within the FM realm, there are few cases of actual project-based analysis of methodological applicability and evaluation of its effectiveness. While the field of business management shows applicability and potential hazard of agile process (Rigby et al. 2016), the FM realm also needs to establish better ways of bringing the info-less, unmanageable facilities into the state of manageability.

1.3 Purpose of the paper

This paper aims to give a concrete example of an agile FM process and its potential for existing facilities in the state of ill-structured information management. A case study showcases the project-based, problem-oriented agile information management processes applied to an existing FM process of a facility complex. The paper exhibits ways for currently info-less buildings to bring itself up to the strategic level with small degrees of upfront investment. This research finds the ideal process of information management and its structure-building from a learning-by-doing process as well as a learning-from-failure process (Edmondson 2011) that are akin to an agile management process. Compared to a waterfall process that places action as the last step of the management process (Figure 1: Left), the agile process defined within the paper places small scale, dispersed project planning and action as the first step (Figure 1: Right). The aim of this process was to enable the structurization of information for strategic planning. Through the case study, the analysis identified the types of informational operations that lead to quick and concrete output toward the strategic communication among the involved stakeholders.

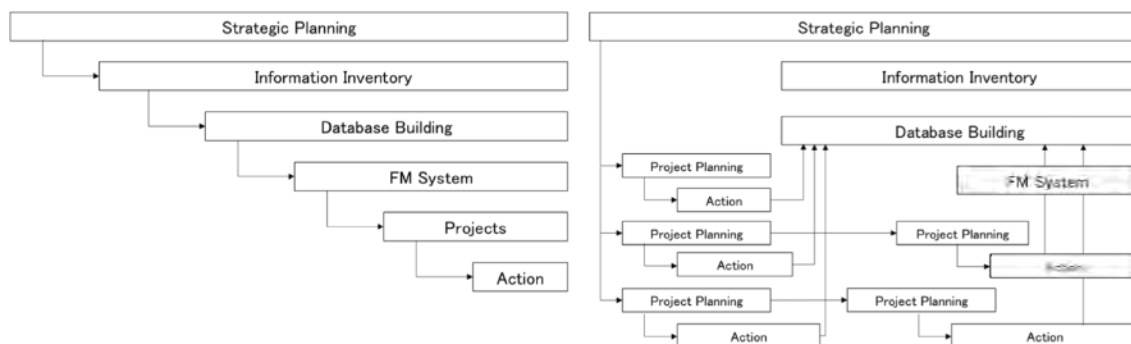

Figure 1: Left: FM decision system redrawn from Rondeau et al. 2006, pp.71, Right: Agile FM methodology

2. METHODOLOGY

2.1 The role of third party institution added to FM stakeholder relationship

The exemplary case followed industry-university-public collaborations, where the academic positioned itself as the third party institution to enable the process of FM structure renovation. After nearly 30 years of operation, a vertical organizational structure built by the prefecture, the operational staff, building management companies, and contractors has become a barrier for a necessary adaptation of the FM operation. In order to break the ice, a third party advisory position was established, aiming for a horizontal mode of communication among stakeholders. The goal was to enable an open discussion of the existing problem so as to reframe the problems into opportunities within existing capabilities and resources, shifting the organization away from structure-based processes toward communication-based processes. From the academic perspective, testing the effectiveness of rapid and partial implementation of advancing technologies such as BIM for FM, 3D scanning, or various sensors and monitoring systems was a paralleling goal, which is often a burden for the public-run existing organization to implement as a complete package of upfront investment.

2.2 Mining for resource-oriented information

The actual activity began with mining for information that can become a resource for value-creating processes within the existing facilities. This process was different from initiating the management process by acquiring a large amount of data. Rather, the process aimed to define the most problematic issues the facility and the operation team were facing. The set of meetings and walkthroughs with the operational team was intended to compare and criticize the initially planned operation of the facilities to the current operations and its problems, and was followed by the potential solutions. The major problems of the current operation were often tied to a lack of adaptation to social and cultural shifts in the demand of facility usage over the years. These apparent problems were then analyzed from the different facets of data mining that can be applied toward project implementation. These acts of mining were initiated through energy and environment monitoring, project monitoring, demand monitoring, or record monitoring (Figure 2).

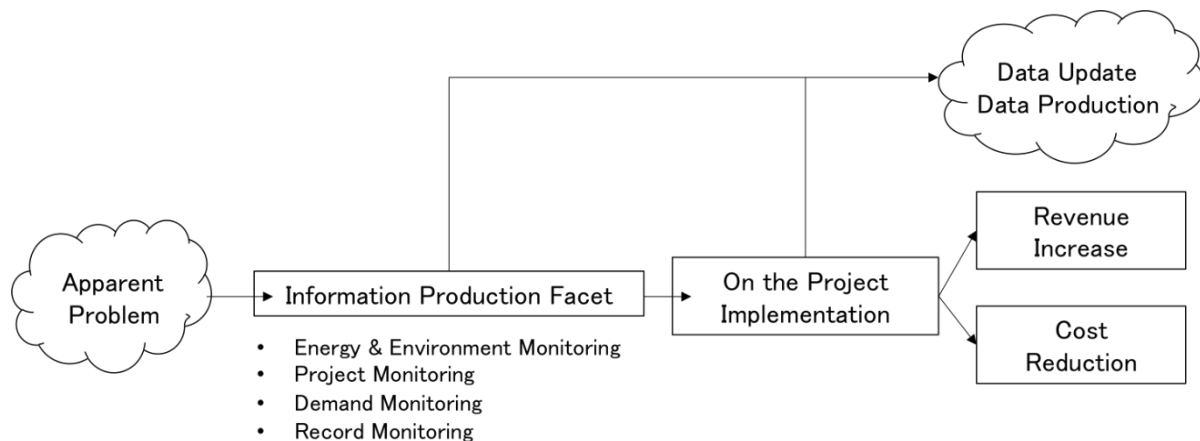

Figure 2: Problem-oriented information management

Analyzed information was grouped into two major outcomes, where the information helps the facility to increase its revenue, while the other reduces the cost. The former outcome took a design-based approach to questions of the basis of the problem, while the latter took an engineering approach to measure, report and verify. The focus was understanding the cost and time it takes to resolve the problem, while capturing the return of investment (ROI) from the resulting solution. The less time it took for the solution to come into effect with a larger ROI was the best fit for the methodology in discussion. As problem-solving projects get implemented, the assumed benefits of the small-scale investment manifest themselves as ROI. The outcome is not only a set of information but also a resource for further investment. Here, the management process assumed the delivery of three outputs: increase in revenue, reduction in cost, and data updates and production for information inventory.

3. CASE STUDY

3.1 Okinawa Convention Center

The paper showcases the Okinawa Convention Center (OCC) complex to exemplify the above given methodologies of mining resources. This public complex is 55,000m² and consists of the following fourteen facilities: theater, exhibition hall, two buildings with lecture rooms and smaller halls, open air spaces, administration wing and mechanical rooms. The first part of the complex was built in 1987, and has been in operation for 29 years. The major problem of the complex is the ill-structured balance of the cost of operation and the revenue, where the large-scale renovation both in building itself and mechanical equipment is on its way. OCC can be considered prototypical of many existing mid-aged, public, large-scale building complexes, where initial investment at the time of construction was high due to the economic boom (in Japan), the current operational demand for the facility is still high. In addition, the operational budget has shrunk, its lifecycle management problem is complex, while the human resources are limited. The overarching aim of the academic research is to establish a better-fit methodology to bring these info-less, management-lacking facility complex into the realm of well-structured management.

3.2 Three years collaboration

In late 2013, the operational management company (private) and the university began a collaboration process, later involving the prefecture (public). The role of the university was to reevaluate the current structure of FM and to provide engineering and technology advice to the existing stakeholder relationship. The collaboration has now reached its third year, where several results have manifested in figures. The initial survey suggested a potential for large-scale reduction in its overall maintenance/ operation cost, yet closer investigation showed the lack of up-to-date building documents and ledgers, leading to identify necessity for investment in large-scale information production processes. At this point, due to the budgetary constraints, traditional step-by-step FM methodology was not operationally viable for the team of collaborators, where a rather small amount of ad hoc information production and corresponding ROI were necessary to initiate the process of restructuring FM. The underlying goal to compile a strategic facility plan remained, yet the method for OCC was agile, where the result of distributed information production and corresponding opportunities were built-up to result in a set of information that leads to its strategic planning.

4. MININGS

The potential financial resources for FM organization can be, a) to increase operation, b) to reduce cost, c) to apply for subsidies, or d) to recruit for new funding opportunities. Since the option c) and d) were rather nominal and obligatory within the process of a) and b), the paper has focused on the first two processes to understand the existing built environment as a resource to mine. The following four sections show the actual agile information production methodologies applied at the OCC.

4.1 Energy and environment monitoring

The theatre and the exhibition hall of OCC are both large-volume open space with event-based, non-continuous operation schedules. The subtropical climate necessitates pre-cooling of the event space previous to the actual operation, where the cost of cooling was comparatively high in regards to similar scale nominal buildings. The building documents were not up to date to run a fast calculation, therefore it was necessary to produce as-built system diagram of the building, while implementing a partial CO₂ monitoring system with motorized dumpers.

- Identification: We identified the pre-cooling period to be the resource.
- Info production Method: CO₂ monitoring to reduce warm exterior air intake.
- Implementation: Instalment of motorized dumpers to automate the control.
- The result: 10% reductions in annual energy cost per year, after the initial investment on monitoring system.

4.2 Project monitoring

Some of the existing upcoming projects on the list had already been budgeted at the time of collaboration initiation. First, the reevaluation of the renovation method and the extent of project were adjusted, while occupation rate-based synchronization of project priorities took place in order to reduce non-operational periods, as well as to find opportunities of resource sharing among multiple constructions such as scaffolding via separate ordering.

- Identification: We identified several on-the-horizon projects that can be included in the upcoming project by redefining the construction scope. Also, chances of synchronizing the construction period of multiple projects were found.
- Info production Method: project road mapping and operation-rate monitoring.
- Implementation: Reevaluation of project scope and range.
- The result: Reduction in spending on base construction costs such as scaffolding. Cancellation of unnecessary projects. Reduction of non-operational days.

4.3 Demand monitoring

Throughout the years of operation, the initially planned and designed operational scheme has shifted. There were several planned spaces that have rarely been used over the years, yet all of them are maintained at occupational service level. Within the identified spaces, one has history of a major accident, while another has also been a cause of small accidents and maintenance over time. Through monitoring the life cycle occupation rate of each of

these spaces and the revenues they have created, it was possible to identify the life cycle usability of these spaces and their potential alternative uses, turning them into rentable space through minimum grounds keeping, or relatively large-scale demolition if the return of investment can be met.

- Identification: We identified the unused spaces to be the resource.
- Info production method: Life cycle occupation rate and accumulative maintenance costs were compared to the occupational redesigning cost and its operational cost. To calculate the soil removal volume, 3D scanning was utilized.
- Implementation: Demolition of unused landscape features, reclamation of unused open space for a parking extension/ event space, and drawing a plan for the demolition of water feature that caused fatal accident.
- The result: 23% of the aimed parking addition to be completed in the first year (9% increase). Putting hold onto ordering of structural renovation project for water feature that can then be removed and turned into rentable event space. Reduction in accident-based and non-operational maintenance fees.

4.4 Record monitoring

Through a close look at previous maintenance records and a rapid walk-through, it was possible to identify several targets of resource mining, where an unnecessary large amount of maintenance has been executed repeatedly and frequently. In the case of OCC, some were material-prone, with continuous use of original materials, such as steel drainpipes and steel handrails for exterior locations. Others suggested were operation-prone, such as overgrown vegetation, and some were based on the original design problem. Even though the maintenance for these identified risks was frequent, the aging was also rapid, where a complete removal/ renewal of these risk-prone elements enabled not only LCC reduction by number but also better safety assurance and better serviceability towards the tenants. As for the removed vegetation, it has created better parking circulation as well as additional parking lots, which can be counted within the overarching scheme to increase the total number of parking lots for revenue increase.

- Identification: We identified repeatedly maintained failures to be the resource.
- Info production method: Reorganization of a record in timeline and a building walk-through to tag the potential reductions onto the documentation. Updating the landscape planning.
- Implementation: Updating the material specification, plotting and tagging the vegetation with risk-based priorities and removal, removal of risk-prone high-maintenance building details.
- The result: Reduction in LCC, reduction both in everyday and post-disaster (typhoon) landscape maintenance fees, reduction of disaster-based risks.

5. FINDINGS

Considering the role of these agile, fast-tracked, project-first operations as the foundation for larger budget operations through stakeholder communication, different facets of resource mining have distilled the points of communication betterment.

- Small-scale technology implementation with concrete results could draw incentives toward full-scale renewal of existing building operation systems.
- Timeline coordination was effective in synchronizing and communicating operational (revenue-based) data onto building maintenance (cost-based) data.
- Awareness toward shifting demand enabled the baseline mindset to shift from as-is conservation to profit-oriented preservation.
- Numerable expressions of the risks previously hidden in the record clarified the need for risk management and prioritization initiatives, assisting the decision making process for risk-based, bold interventions.

6. CONCLUSION

Through various trials of problem-oriented information management within the given budget of listed projects, we have seen that even within a tight budgeted organization, it was possible to begin the process of mining for chances of information production. Through reorienting the existing FM schemes to more tenant-oriented, clear and concrete result-based operations, the process of information production was accompanied by on-site results that

were more effective in communicating with prefectural staff and other off-site stakeholders. Compared to the upfront planning of strategic schemes and the requesting of a large preparatory budget for information production, it was easier for the off-site financial decision making stakeholders to grasp the visualized information of concrete results and figures that were achieved through the on-site learning-by-doing processes.

Technically, it was difficult to assess whether the subsidy-based, initial large-budgeted information production project may have resulted in a better financial outcome. However, the study provided insight to a more concrete methodology for stakeholder communication, where existing facilities are diverse and need different sets of investment toward its information production. Agile FM as communication-based strategy could be one of the ways to address the needs for strategic FM planning and as an incentive for larger-scale investment in information production.

The developed methodology was more likely to be applicable to information-less and ill-structured facilities with many unsolved problems to start their first steps in defining their sustainable management methods. It may be less applicable to facilities with plenty of as-built information, or where the management has been systematized and the stakeholder relationship well structured.

REFERENCES

- [1] Beck, K. et al., 2001. Agile Manifesto. *Software Development*, 9(August), pp.28–35.
- [2] Edmondson, A.C., 2011. Strategies for Learning From Failure. *Harvard business review*, 89(4), pp.48–55.
- [3] Everts, P., Pries, F. & Nijhuis, S., 2011. Towards agile projectmanagement and social innovation in the construction industry. In *Management and Innovation for a Sustainable Built Environment*. [online]. Retrieved from: <http://repository.tudelft.nl/islandora/object/uuid:cbf5d16b-accf-43b1-8073-990f4f324847?collection=research>. [Retrieved on 15 September 2016].
- [4] Rigby, D.K., Sutherland, J. & Takeuchi, H., 2016. embracing agile. *Harvard Business Review*, 94(5), pp.40–50.
- [5] Rondeau, E.P., Brown, R.K. & Lapidés, P.D., 2006. *Facility management 2nd ed.*, John Wiley & Sons, pp.vii, 70-71.
- [6] Teicholz, E. & IFMA Foundation, 2013. *Technology for facility managers: the impact of cutting-edge technology on facility management*, John Wiley & Sons, pp.24-40.

Development of MERIT and Normalization Factor for Different Operating Hours for Building Energy Intensity (BEI)

TANG Chee-khoay^a, Ahmad IDZIHAR^b, Kevin HOR^c

^a CK@Work Sdn Bhd, Malaysia, ck@gbeet.com

^b Exergy Sdn Bhd, Malaysia, exergy.malaysia@gmail.com

^c Edgenta Energy Services PLC, Malaysia, kevin.hor@uemedgenta.uemnet.com

ABSTRACT

The JKR-UNDP's Building Sector Energy Efficiency Project (BSEEP) in Malaysia is aimed at reducing the growth rate of GHG emission of the building industry in Malaysia. Component 4 task in BSEEP in 2015 was to develop a document allowing the Malaysian building industry to compare energy efficiency of different buildings in a fair manner. The MERIT is one of the output by this project.

MERIT is a proposed methodology for gathering, interpreting and the use of data for the purpose of obtaining an accredited Malaysian Energy Efficiency Rating of Building for Offices (MERIT for Offices) for existing buildings using 12 months of actual data. MERIT is based on the computed Building Energy Intensity (BEI) in kWh/(m².year); an index that is commonly used in South East Asia.

During the development of MERIT, a study was made on the linear normalization of operational hours of office building that is commonly practised by the building industry in South East Asian region. It was found in this study that a linear normalization significantly misrepresents the BEI of an office building operating 24 hours daily versus a building that is operating only 8 hours a day from Monday to Friday.

A linear normalization was unable to capture the effects of building thermal mass and base-load effects of buildings with different operating hours. Further studies establish that a logarithmic fit is more appropriate method for **normalizing operational hours of building's BEI**.

This will be the 1st tool in South East Asia that will use a logarithmic normalization methodology to allow better representation of the BEI due to different operating hours in buildings.

Keywords: *energy use, building energy rating tool, normalization factor*

1. INTRODUCTION

A recent study made by Exergy Sdn Bhd verified the proposed MERIT logarithmic normalization of different operational hours for buildings in Malaysia. Since there is a second verification party that conducted the study using different methodology, building conditions and software; and arriving at the same result; it is hereby proposed **to use the proposed MERIT logarithmic normalization method to compute MERIT's BEI**. The proposed changes to the BEI computation is shown as Equation 1-1 below, incorporating the logarithmic "normalization factor (NF)".

$$BEI = \frac{\text{Total Building Energy Consumption}}{\text{Rated Areas} \times \text{Rated Hours}} \times 52 \frac{\text{hours}}{\text{week}} \times NF$$

Equation 1-1

Where NF is defined as:

Rated Hours per Week (x)	NF
40	0.89
45	0.94
50	0.99
52	1.00
60	1.02
85	1.15
105	1.21
168	1.35

Where, $NF = 0.3113 \ln(x) - 0.2381$, $R^2 = 99.45$

The linear BEI formula that is commonly in use in South East Asia today is as shown as Equation 1-2:

$$BEI = \frac{\text{Total Building Energy Consumption}}{\text{Rated Areas} \times \text{Rated Hours}} \times 52 \frac{\text{hours}}{\text{week}}$$

Equation 1-2

The MERIT logarithmic normalization is a proposed method that accounts for the effect of base building load during unoccupied hours and the thermal mass effect of the building in the computation of BEI.

The development of this “normalization factor” is similar to the development of the constants in OTTV (Overall Thermal Transmission Value) equation used in Malaysian Standard 1525 since early 1990s; that is based on approximately 60 building energy simulation results.

A total of 72 simulation studies was conducted with different base loads and operating hours to derive the normalization fit for MERIT’s BEI.

Finally, it should also be highlighted that the American’s EUI (energy usage intensity) also employed a logarithmic fit to normalise buildings with different operational hours of use. The derivation of the logarithmic fit for building operational hours in US was based on thousands of actual performance data collected from existing buildings.

2. BASE LOAD EFFECT

Consider two identical building with the same occupancy density, same air-conditioning system, same lighting system and same plug load. One is being operated 10 hours per day from Monday to Friday and the other one being operated 24 hours a day, 7 days a week. The BEI computed for the 10 hours building and 24 hours building should be the same because the default BEI is normalised to 52 hours per week (via a linear normalization). However, the linear normalization method does provide the same BEI number and one of the reason for this error is due to the base load effect as presented in Figures 2-1, 2-2 and 2-3.

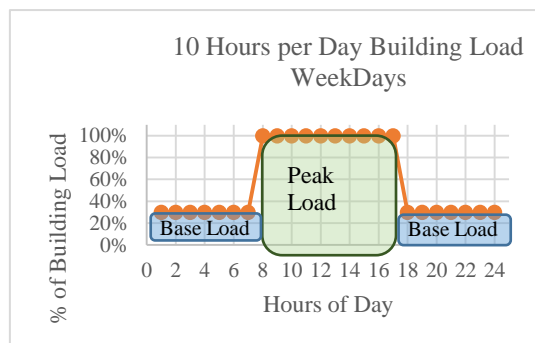

Figure 2-1: Building energy load scenario with 10 hours per day during weekdays

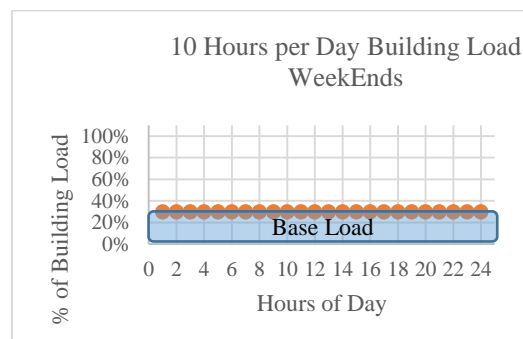

Figure 2-2: Building energy load scenario with 10 hours per day during weekends

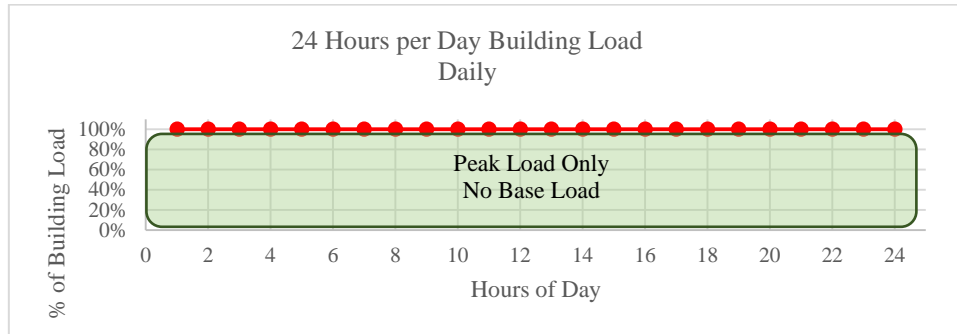

Figure 2-3: Building energy load scenario that operates 24 hours a day

To illustrate the base load effect (ignoring the thermal mass effect for now), a set of BEI computation are provided for 3 scenarios of operating hours: 50, 85 and 168 hours per week following the charts provided. The following assumptions were used on all 3 scenarios modelling a building that is exactly the same, with the only exception of different operating hours; thereby different base load hours:

- Building Size: 1,000 m²
- Peak Load Power: 21.65 kW
- Base Load Power: 6.5 kW

Operating Hours per Week	50 (Base)	85	168
Default Linear BEI, kWh/(m ² .year)	100	76	58
Error from Base	0%	-24%	-42%

Table 2-1: Computed BEI based on linear normalization

Operating Hours per Week	50 (Base)	85	168
Logarithmic BEI, kWh/(m ² .year)	99	87	78
Error from Base	0%	-11%	-21%

Table 2-2: Computed BEI based on logarithmic normalization

The computed BEI with Linear Normalization is shown in Table 2-1 and it showed an error up to 42% for building operating 24 hours daily. Table 2-2 showed the computed BEI with Logarithmic Normalization Factor used and it reduces the maximum error down to 21% for the same building operated 24 hours daily.

However, this set of calculation ignored the effect of thermal mass that is also occurring on the building due to the differences of building operational hours. Therefore, the error computed here, by the Proposed Logarithmic Normalization Factor, seems to be large at 21%.

3. THERMAL MASS EFFECT

The thermal mass of a building caused peak cooling load to be different due to the different operational hours. In a building that operate 5 days a week, the building mass will absorb heat during the weekends and cause a peak cooling load to occur on Monday morning. However, in a building that operates 24 hours daily, this thermal mass effect is not relevant anymore as it does not have any hours where the building mass is allowed to heat up.

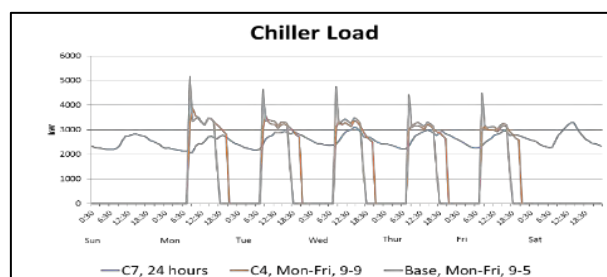

Figure 3-1: Chiller load due to different operating hours

Fundamentally, the longer the operating hours of the air-conditioning system, the less hours the building mass is exposed to heat gain, reducing the relevancy of thermal mass effect on the peak cooling load.

Building energy simulation studies were conducted to capture the effect of building thermal mass effect on the BEI computation. A range of simulation studies were made to calibrate the BEI to account for the base load effect and thermal mass effect at the same time, for buildings with different operational hours.

The dampening of cooling load effect due to longer operational hours of a building is shown in Figure 3-1 above.

4. DERIVATION OF THE MERIT LOGARITHMIC NORMALIZATION FACTOR

The logarithmic normalization factor was derived from a set of 72 cases of simulation study of a typical office building of 17 floors with these conditions:

Different energy use intensity

Three basic building scenarios were created to model the influence of operating hours on the BEI computation. These three building scenarios represents the followings:

- Low Energy Building: This is a model of a building that is reasonably well optimized for energy efficiency. It has good building fabric, low lighting power density, low small power density and efficient air-conditioning equipment. This building is modelled with variable air volume system and variable chill water flow.
- Medium Energy Building: This is a model of a building that has standard efficiency. It has moderate building fabric, medium level of lighting power density, medium level of small power density and average efficiency air-conditioning equipment. This building is modelled with variable air volume system and variable chill water flow.
- High Energy Building: This is a model of a building that has poor energy efficiency. It has poor building fabric, high lighting power density, high small power density and poor efficiency air-conditioning equipment. This building is modelled with constant air volume system and constant chilled water flow.

The lighting and air-conditioning equipment in these three buildings remain exactly the same for all the simulation cases based on the building scenario. The objective of this study is to model the same building with same equipment and occupant density. The only difference that made to the building is the operational hours which impacts the hours of occupancy, hours of small power use, hours of lighting power use and air-conditioning hours.

Different base loads

In addition to the above, three different base loads were simulated for each building scenario. These three base loads were selected to study the influence of different base load on BEI and operational hours of the building. The following assumption on base load were made:

- Small Power base load of 10%
- Small Power base load of 35%
- Small Power base load of 50% (65% for High Energy Building).

Different operating hours

Finally, eight cases of different operating hours of a building were made. These cases modelled building with operating hours of 2080 to 8760 per year. The details of the operating hours are as shown in Table 4-1 below:

Cases	Operating hours (Mon-Fri)	Operating Hours (Sat)	Operating Hours (Sun)	Weekly Operating Hours
Base Case	9am to 5pm	Off	off	40
Case 1	9am to 6pm	Off	off	45
Case 2	8am to 6pm	Off	off	50
Case 3	8am to 6pm	8am to 1pm	off	55
Case 4	9am to 9pm	Off	off	60
Case 5	9am to 9pm	9am to 9pm	9am to 9pm	85

Case 6	9am to 12 midnight	9am to 12 midnight	9am to 12 midnight	105
Case 7	24 hours	24 hours	24 hours	168

Table 4-1: List of operating hours simulated

The simulation studies were conducted using IES<VE> building simulation software, with full modelling of the air-conditioning system. Conventional building material and power consumption was obtained from the building industry professional through stakeholder's engagement; via the Building Sector Energy Efficiency Project in Malaysia to represent the common building industry practise.

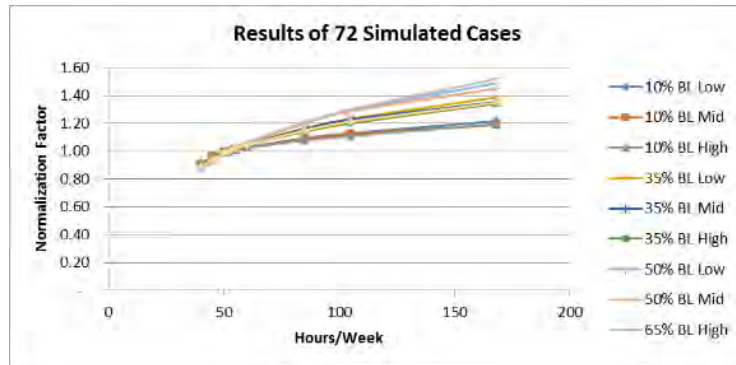

Figure 4-1: Results of 72 simulated cases

Hours/week	Average Normalization Factor	Potential Error of Computed BEI (\pm)		
		Confidence Interval		
		80%	95%	99%
40	0.89	1.1%	1.7%	2.2%
45	0.94	0.6%	0.9%	1.2%
50	0.99	0.2%	0.2%	0.3%
52	1.00	0.0%	0.0%	0.0%
55	1.02	0.2%	0.4%	0.5%
60	1.04	0.6%	1.0%	1.3%
85	1.15	1.9%	2.9%	3.8%
105	1.21	2.7%	4.1%	5.3%
168	1.35	4.0%	6.1%	8.0%

Table 4-2: Confidence interval of proposed normalization factor

The result of the simulation studies indicated that the proposed calibration factors are very accurate for weekly operational hours between 45 to 60 hours per week, as it is within 99% confidence interval that the computed BEI will have a maximum error of less than 2.2%. Longer operating hours have higher uncertainties due to the ambiguity of the actual base load during non-occupancy hours. The uncertainty of the base load also impacts the building thermal mass, causing further uncertainty.

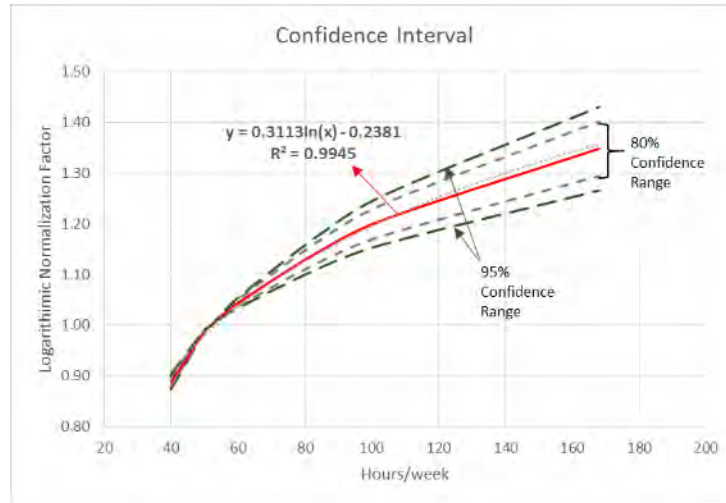

Figure 4-2: Confidence interval of proposed logarithmic normalization factor

Although there are uncertainties, the results from this simulation study showed that the proposed normalization factor will provide a maximum of $\pm 6\%$ error, within a 95% confidence interval in the worst case scenario. This result is deemed accurate enough for such tool to be used by the building industry.

5. VALIDATION BY EXERGY SDN BHD

Exergy Sdn Bhd has completed a verification study on the proposed MERIT logarithmic normalization factor by conducting building energy simulation studies using a different software (EnergyPlus) on four (4) of their actual office building projects. These buildings have BEI ranging from 135 to 180 kWh/(m².year) at 52 hours/week operational hours and has different Gross Floor Area (GFA), different air-conditioned space ratio to GFA, different building orientation, different building heights and different windows to wall ratio for each of the project. The results of Exergy studies are as summarized in the tables below:

Bldg 1	Hr/wk	Act BEI *	Def. BEI**	BEI @ 52 Hr/wk	NF for Bldg 1	MERIT NF	Diff (%)
C1	40	127	164	146	0.89	0.89	0.0%
C2	45	135	156	146	0.93	0.94	-1.1%
C3	50	143	149	146	0.98	0.99	-1.0%
C4	55	152	143	146	1.02	1.02	0.0%
C5	60	161	140	146	1.04	1.04	0.0%
C6	85	204	126	146	1.16	1.15	0.9%
C7	105	241	119	146	1.23	1.21	1.7%
C8	168	349	108	146	1.35	1.35	0.0%

Table 5-1: Comparison of building 1 normalization factor (NF)

Where:

*;

$$Act\ BEI = \frac{Total\ Building\ Energy\ Consumption}{Building\ Gross\ Floor\ Area}$$

**;

$$Def\ BEI = \frac{Act\ BEI\ x\ 52\ Hours/Week}{Rated\ Hours}$$

Bldg 2	Hr/wk	Act BEI *	Def. BEI **	BEI @ 52 Hr/wk	NF for Bldg 2	MERIT NF	Diff (%)
C1	40	151	196	180	0.92	0.89	3.4%
C2	45	162	187	180	0.96	0.94	2.1%
C3	50	180	186	180	0.97	0.99	-2.0%
C4	55	193	182	180	0.99	1.02	-2.9%
C5	60	196	170	180	1.06	1.04	1.9%
C6	85	255	157	180	1.15	1.15	0.0%
C7	105	301	148	180	1.22	1.21	0.8%
C8	168	447	138	180	1.31	1.35	-3.0%

Table 5-2: Comparison of building 2 normalization factor (NF)

Bldg 3	Hr/wk	Act BEI *	Def. BEI **	BEI @ 52 Hr/wk	NF for Bldg 3	MERIT NF	Diff (%)
C1	40	117	152	135	0.89	0.89	0.0%
C2	45	126	145	135	0.93	0.94	-1.1%
C3	50	133	138	135	0.98	0.99	-1.0%
C4	55	141	133	135	1.01	1.02	-1.0%
C5	60	150	130	135	1.04	1.04	0.0%
C6	85	190	117	135	1.15	1.15	0.0%
C7	105	230	113	135	1.19	1.21	-1.7%
C8	168	309	95	135	1.41	1.35	4.4%

Table 5-3: Comparison of building 3 normalization factor (NF)

Bldg 4	Hr/wk	Act BEI *	Def. BEI **	BEI @ 52 Hr/wk	NF for Bldg 4	MERIT NF	Diff (%)
C1	40	129	167	151	0.90	0.89	1.1%
C2	45	139	160	151	0.95	0.94	1.1%
C3	50	147	153	151	0.99	0.99	0.0%
C4	55	157	148	151	1.02	1.02	0.0%
C5	60	167	145	151	1.05	1.04	1.0%
C6	85	215	132	151	1.14	1.15	-0.9%
C7	105	255	126	151	1.20	1.21	-0.8%
C8	168	372	115	151	1.32	1.35	-2.2%

Table 5-4: Comparison of building 4 normalization factor (NF)

Hr/wk	MERIT NF	Bldg 1 % Diff	Bldg 2 % Diff	Bldg 3 % Diff	Bldg 4 % Diff	Ave % Diff
40	0.89	0.0%	3.4%	0.0%	1.1%	1.1%
45	0.94	-1.1%	2.1%	-1.1%	1.1%	0.3%
50	0.99	-1.0%	-2.0%	-1.0%	0.0%	-1.0%
55	1.02	0.0%	-2.9%	-1.0%	0.0%	-1.0%
60	1.04	0.0%	1.9%	0.0%	1.0%	0.7%
85	1.15	0.9%	0.0%	0.0%	-0.9%	0.0%
105	1.21	1.7%	0.8%	-1.7%	-0.8%	0.0%
168	1.35	0.0%	-3.0%	4.4%	-2.2%	-0.2%

Table 5-5: Summary comparison of 4 buildings normalization factor (NF)

The results from Exergy studies verified that the proposed MERIT logarithmic normalization factor provided a good calibration of the BEI due to the differences of operational hours on four of their building projects. The average differences of BEI computation by Exergy to the MERIT proposed logarithmic normalization factor range from a low of -1% to +1%, suggesting a very good fit.

A maximum difference of 4.4% is shown to occur for a building running 24 hours daily. This result corresponded well to the statistical analysis of the proposed MERIT logarithmic normalization factor which showed that the confidence interval gets larger with longer hours of building use.

6. SUMMARY

The proposed logarithmic normalization factor for BEI computation is shown to provide a more correct comparison of energy consumption of buildings with different operational hours of use.

A table providing normalization factor was proposed as a mean of offering the building industry a simple tool for it to be adopted easily. The normalization factor proposed provided a confidence interval of 95% that the computed BEI falls within a margin of error of $\pm 6\%$ even on the worst case scenario.

It is therefore, proposed for Malaysia building industry to adopt this methodology to normalize BEI of buildings with different operational hours.

REFERENCES

- [1] NABERS Energy and Water for offices, Validation Protocol for Accredited Ratings, 2009, Department of Environment, Climate Change and Water NSW.
- [2] Tang, 2013, Report on Malaysian Building Energy Efficiency Rating System (MEERB) – Part 1 & 2: Building Sector Energy Efficiency Project (BSEEP), Malaysia.
- [3] Ahmad, 2015, BEI Normalization based on Operating Hours, Exergy Sdn Bhd.
- [4] Terry Sharp, 2012, Energy Benchmarking in Commercial Office Buildings, Oak Ridge National Laboratory.
- [5] Green Building Index, 2011, New Construction (NRNC) Design Reference Guide & Submission Format, Malaysia.
- [6] Green Building Index, BEI Formula, <http://www.greenbuildingindex.org/FAQs-9.html>
- [7] J.J. derring, J.F. Bush, J. Hall, K.S. Kannan, M.D. Levine, A.C. Ayub and I. Turiel (April 1987), Energy and Economic Analysis in support of Energy Conservation Standards for new Commercial Buildings in Malaysia, Lawrence Berkeley laboratory, University of California.

Session 5.9: Transforming Green Market – Green Economics (1)

Stakeholders View on Commercial Benefits for Energy Neutral Refurbishment of Let Properties

Angela GRECO^a, Thaleia KONSTANTINOUB^b, Roel SCHIPPER^c, Ruud BINNEKAMP^d, Esther GERRITSEN^e, Andy VAN DEN DOBBELSTEEN^f

^a Delft University of Technology, The Netherlands, ar@angelagreco.name

^b Delft University of Technology, The Netherlands, t.konstantinou@tudelft.nl

^c Delft University of Technology, The Netherlands, h.r.schipper@tudelft.nl

^d Delft University of Technology, The Netherlands, r.binnekamp@tudelft.nl

^e Techniplan Adviseurs, The Netherlands, esther.gerritsen@techniplan.nl

^f Delft University of Technology, The Netherlands, a.a.j.f.vandendobbelsteen@tudelft.nl

ABSTRACT

In Europe, the DIRECTIVE 2010/31/EU requires increasing the number of nearly zero energy buildings. The existing building stock needs to be included in order to achieve the 2020 EU environmental targets. The main barriers of energy neutral refurbishment of existing non-residential buildings appear to be financial rather than technical, next to a number of other extrinsic factors that do not stimulate such an investment. While a business case for new energy neutral buildings is believed to exist, controversial opinions can be found with respect to refurbishment of existing large buildings. Let properties, in particular, have a harder-to-justify business case because of contractual agreements between landlord and tenant: the former is usually accountable for renovation and the latter for energy bills.

The present study aims at providing an overview of the barriers and benefits of energy neutral refurbishment according to relevant stakeholders. Through interviews with real estate investors, energy service companies and tenants, the main interests and risks encountered today to undertake deep energy retrofit as well as technical constraints were investigated. Subsequently, a roundtable discussion was organized with the interviewed real-estate investors. During the roundtable, the investment needed to refurbish an existing office building, meeting the zero energy target was presented and different strategies to improve the financial attractiveness of energy retrofitting were discussed.

The study has shown that combining different benefits in the renovation is fundamental to convince investors. When the design provides additional benefits, such as increasing the rent, or allocating an energy budget to the tenant, the refurbishment can become feasible. Ultimately, a screening-checklist is proposed for a qualitative estimation of the potentials offered by a given building for a feasible energy neutral refurbishment.

Keywords: energy neutral, deep building renovation, stakeholders

1. INTRODUCTION

Of all the large building stock in Europe, only about 1.2% is renovated and about 0.1% demolished in any given year (Energy Performance of Building Directive, 2013). Approximately 1% of new constructions are added to the existing stock and since buildings are long-term assets, designed to function for at least 50 years, it is foreseen that 75-90% of those standing today will remain in use in 2050. Given the fact that energy use in buildings **represents about 40% of Europe's total energy consumption and CO₂ emission** (European Commission, 2008), deep energy retrofit should increase strongly, aiming at a rate of at least 2% yearly and with no less than 60% of energy savings (European Commission, 2015). Both the quality and the speed of refurbishment need to improve. This is why this study addresses the zero energy refurbishment, as a way to analyse a high, but soon required, energy goal. Here the term zero energy refers to a building with zero net energy consumption, meaning that total amount of energy used by the building on an annual basis, is roughly equal to the amount of renewable energy created onsite (Torcellini et al., 2006).

Contrary to the case of refurbishment, the business case existence for new buildings to achieve the zero energy target is not subject of discussion. This is not only because of the return of investment new buildings can offer, but mainly because energy neutrality will be a compulsory practice for all new buildings from the year 2020 (European Commission, 2010). A rather complex business case concerns let properties. Rented properties in The Netherlands host 32% of Dutch residents (EUROSTAT, 2016) and 63% of office buildings (Rijksdienst voor het cultureel erfgoed, 2013). The contractual agreement for these properties usually considers the building owner accountable for renovation costs while the tenants for energy bills.

Under this condition, the present study analyses barriers and opportunities of the energy neutral refurbishment according to relevant stakeholders. Knowing the perspective of actors involved in the decision-making and design processes, as well as the one of the users, can help policy makers and designers achieving the zero energy target. First, the main interests and risks encountered today to undertake deep energy retrofit as well as technical constrains, were investigated, through interviews with real estate investors, energy service companies and tenants. Subsequently, a roundtable discussion was organized with the interviewed real-estate investors. Finally, a screening-checklist is proposed for a qualitative estimation of the opportunities of a given building for a feasible zero energy refurbishment.

2. METHODS

The method to discuss the viewpoint of some relevant stakeholders on the zero energy refurbishment of let properties, included two phases: first a set of interviews were conducted, to identify barriers and opportunities; then a roundtable discussion with different real-estate investors was organized, to evaluate the proposed business cases.

2.1 Interviews

For the scope of this research, a general interview guide approach (Turner, 2010) was chosen. A list of questions was prepared but only used as outline to assure covering the intended topics. A total of 9 interviews were conducted covering the following topics:

- Personal knowledge of energy neutral concepts applied to existing buildings;
- Drivers for refurbishment and drivers for zero energy refurbishment;
- Opportunities (business/ market/ design/ innovation related) of zero energy refurbishment;
- Barriers for zero energy refurbishment.

The interviewed stakeholder were investors, designers, real estate experts, energy service companies (ESCOs), tenants.

2.2 Roundtable discussion

At the roundtable discussion the following was presented to investors:

- A case study design, aiming at determining the interventions and the costs needed to refurbish an existing office building, meeting the zero energy target;
- A set of strategies studied using Monte Carlo simulations for risk and sensitivity analysis;

The methods for the zero energy design and the Monte Carlo simulations, can be found in Greco et al. (2016).

The roundtable discussion was structured as follows:

- Introduction/brainstorming session on barriers for the zero energy refurbishment of commercial buildings;
- Presentation of the case study, model and strategies;
- Model inputs change, using **participants' suggestions**;
- Running of the improved Monte Carlo simulations;
- Discussion of new results;
- **Wrap-up expressing participants' vision on the future of zero energy refurbishment.**

2.2.1 Case study design

The case study presented to investors consisted of a single-tenant Office building from 1980, occupying a gross floor area of approximately 35,000 m². **For this, it was initially estimated a price of about 12 mln € to upgrade from energy label G to zero-energy, with a payback time of 18 years and a NPV equal to 3.27 mln €.**

2.2.2 Strategies

The deterministic analysis that brought to the results above mentioned was carrying a certain degree of uncertainties, related to volatility of the variables used as inputs. Therefore, a stochastic model was made, in order to take into account such uncertainties, allowing for a more objective discussion with investors.

The following strategies were proposed (further explanation follows below):

- Base Case
- Budget Allocation
- Increase of surface
- Combination

All the strategies describe a renovation consisting of the minimum interventions needed to reach zero energy with **a rent within the market range for that specific location. The base case represents today's common practice, where the owner pays for the renovation and the tenant for the energy bills.** In the budget allocation strategy the tenant pays a quota that is equal or smaller than the previous energy bill, which is added to the competitive market rent. The owner officially pays for energy, but with zero energy buildings the only energy to be paid is for backup system (lack of renewable energy supply) and grid connection. Should the tenant demand too much energy, he would need to pay for it. Such a measure seems to offer a win-win situation for tenant and owner solving the typical user-behavior problem of all-inclusive contracts and allowing the owner benefiting from renovation. The increase of surface strategy aims at increasing the rentable space with the renovation, allowing increasing the rent within market range. The combination strategy couples the two strategies above mentioned. Table 1 summarizes the assumptions made for each strategy, together with the probability for each strategy to provide a positive NPV and a payback period shorter than 15 years. Note that a 5% discount rate is used in the NPV calculation. It can be seen that the probability for the NPV to be positive goes from 32% with the base case strategy to 91% with the combination strategy.

	Increase of floor area	Owner does not pay for energy	Owner pays for energy	Probability NPV>0 (%)	Probability payback t < 15 years (%)
Base Case		✓		32	6
Budget allocation			✓	70	31
Increase of surface	✓	✓		65	28
Combination	✓		✓	91	61

Table 1: Description of the Four Strategies and the Related Probability

3. RESULTS

3.1 Subtitle

3.1.1 Investors

According to all the investors interviewed, one of the main drivers for any type of refurbishment is location. In real-estate evaluation, location is considered to be the most relevant factor. The minimum and maximum rental prices are related to location. The limit of rental increase given by location can be therefore determinant for the decision making of energy retrofitting.

The second top driver is considered to be the tenant. In particular: the number of tenants per building and the **tenants' prestige.**

In case of a single tenant who is asking for a building renovation, the owner is in a weak position when it comes to decision-making. If the tenant leaves, it would be more difficult to find a different tenant that suits the building

dimension. Changing tenant has also the risk of having to undertake the renovation again if required, under certain market conditions. On the other hand, multiple tenants are more difficult to manage and the owner would rather agree on renovating than losing a single tenant for a large building. When the tenant is prestigious, corporate image could be an important factor, as being located in sustainable buildings is more desirable. In addition, when the tenant is prestigious, it is more likely to have the financial possibility of moving to a different building, in case the current one does not satisfy his requirements.

Moving to the barriers, the most relevant is that the energy efficiency does not (yet) directly reflect in a pre-definable increased building value or revenue. A general remark is that investors are hesitant about the technical feasibility of zero energy renovation.

3.1.2 Designers

Designers follow their clients' requests concerning energy efficiency. Only when making an offer to the client, they might suggest different energy targets. Concerning energy efficiency, their primary role consists in providing clients with solutions for energy saving and an estimation of the actual savings they can "guarantee" when a certain measure is applied.

Designers see more challenges in refurbishment than in new buildings, independently of the energy target. However, for high standards of energy efficiency, the interventions are objectively more risky and complex.

3.1.3 Real estate experts

With real estate experts, the barriers and drivers identified were similar to the ones mentioned by the investors. Location, property value increase and vacancy rate are the most important drivers. The return of investment and the revenue coming from a renovation are expected to be the decision-making parameters for a building owner.

3.1.4 ESCOs

Energy Service Companies are concerned about the "de-centralization" of energy that follows from the application of renewable sources. In other terms energy production is coming from different sources (e.g. from a rooftop with solar panels) and not anymore from few dominant energy providers. ESCOs are trying to get a managing role in this new market. They are also starting to invest in energy renovation for commercial or public buildings, while they do not do it for houses (this is to invest on buildings that can provide a more safe return of investment). As far as zero energy is concerned, the general impression is that many technological and economical limitations do not allow for an actual implementation of high-energy efficiency measures. High initial costs with a too long payback periods are to be considered the main barrier in this context.

3.1.5 Tenants

The tenant interviewed affirmed that zero energy is not a target he would consider for his building. He also doubts whether a zero energy renovation would actually be possible. The tenant does care about energy savings and corporate image. The office is the working place for employees and meeting points with clients, what is therefore considered important is a degree of sustainability that can be seen and felt by clients and personnel working in the building.

3.2 Roundtable discussion

According to the investors invited to the roundtable discussion, the most important barriers for an attractive business case for the zero energy refurbishment are the capital investment required and the way such interventions are reflected in the final value of the refurbished building. Another problem already mentioned that brings doubts among investors is the difficulty to guarantee that a certain building performs as zero energy, taking the user behavior and the availability of renewable energy supply into account. The investors confirmed the hypothesis that the most important parameters to affect the zero energy refurbishment of commercial buildings are location and age of the building.



Figure 1: Roundtable discussion

When the location is central and the building needs to be renovated for additional reasons (e.g. it is old and needs upgrade or needs to be adapted to a different function), it is easier to create the business case. Changing the building function could help creating the business case depending on location. The more convenient building age for a zero energy renovation is 25-30 years old. This is a time when the building needs renovation anyway and it is therefore a good moment to add zero-energy as a goal of the renovation plan.

Generally, the investors found the model representative and considered that the strategies made are realistic and helping building the business case for the zero energy refurbishment. It was also suggested that risk and sensitivity analysis, are an excellent approach to evaluate business case opportunities.

4. DISCUSSION

Including the zero energy target as objective of a refurbishment is considered a time and resource consuming process by both investors and designers. To support this process, a screening checklist is proposed (see Figure 2). The checklist was based on the barriers identified and highlights the parameters that were considered important for the business case. Thus, it can speed up the decision making process and help predicting if the zero energy target can bring financial benefit, suggesting to explore this option with a preliminary design. If all the conditions stated in both a) and b) subsist (the ones in the darker area, excluding additional benefits), then meeting the zero energy target will most likely bring financial benefits to the owner who invests in the refurbishment and rents out **the building. The conditions under “additional benefits” are indeed extra and can only improve the business case;** alone, they are not sufficient to create it.

Business case screening checklist for zero energy refurbishment	
a) Building description	
The building is located in an area that is considered a good location for its specific function	<input type="checkbox"/>
The building is in need of major refurbishment because of one or more of the following reasons:	<input type="checkbox"/>
<ul style="list-style-type: none"> • It is between 25-30 years old and never had a major refurbishment • More than 25 years have passed since the last major refurbishment • The current tenant strictly demands deep energy retrofit • A new function has already been planned, which implies major architectural transformations • Other 	
Additional benefits if:	
The renovation gives opportunity for rentable floor area extension	<input type="checkbox"/>
Replacing of the building envelope gives opportunity for on-site energy production (e.g. PV panels installation on the façades)	<input type="checkbox"/>
b) Commercial conditions after renovation	
The building has an occupancy rate of at least 50%	<input type="checkbox"/>
It is possible to increase the total rent* (e.g. tenant changes; same tenant is willing to pay more; market, regulations and location allow it)	<input type="checkbox"/>
The building value increases	<input type="checkbox"/>
Additional benefits if:	
Contractual agreements allow allocating an energy budget to the tenant	<input type="checkbox"/>
*Total rent: surface x rent x occupancy rate	

Figure 2: Screening check list to support the evaluation of the financial attractiveness of energy neutral refurbishment

5. CONCLUSION

Zero energy refurbishment does not belong to regular practice, particularly in the commercial sector. The stakeholders interviewed agreed that zero energy refurbishment of let properties lack of financial attractiveness. This represents a great barrier for the so needed large-scale implementation of the energy neutral refurbishment. It can be concluded that the most important parameters that play a role in determining the business case are **location, building characteristics and tenants' requirements**.

Therefore, different strategies were proposed to a group of relevant real-estate investors to discuss the opportunities to improve the financial attractiveness of those interventions. Strategies such as increasing the building surface with the renovation and allocating an energy budget to the tenant, proved to improve the business case and were appreciated by investors. Increasing the rentable surface however, is neither always possible nor at all times convenient. Different is the case of the energy budget allocation strategy, which would provide a zero-cost solution for improving the business case. Further action by governmental entities would be needed to regulate and support such and similar strategies. This study shows that there are opportunities to improve the financial **attractiveness of zero energy refurbishment. Stakeholders' awareness about the opportunities of undertaking deep energy retrofit meeting the net-zero energy target, should increase strongly.** It is also crucial to consider the weight that real-estate investors give to certifications showing the need of warranty for zero-energy performance. The latter suggests that zero-energy will become more common as improved certification system will be introduced and a surplus value will be given to the energy performance of buildings in real-estate evaluation.

REFERENCES

- [1] Commission of the European Communities, 2008. Summary of the Impact Assessment accompanying the proposal for a recast of the Energy Performance of Buildings Directive (2002/91/EC).
- [2] Energy Performance of Building Directive, 2013. Assistance Documents for EU Member States in developing long term strategies for mobilizing investment in building energy renovation (per Energy Efficiency Directive Article 4). COMPOSITE DOCUMENT.
- [3] European Commission, 2010. Energy 2020: A strategy for competitive, sustainable and secure energy. Communication from the Commission to the European Parliament, the Council, the European Economic and Social Committee and the Committee of the Regions.
- [4] European Commission, 2015. Evaluation of the Energy Performance of Buildings Directive 2010/31/EU.
- [5] EUROSTAT, Housing Statistics [online]. Retrieved from <http://ec.europa.eu/eurostat/> [Retrieved on 12 September 2016].
- [6] Greco, A., Konstantinou, T., Schipper, H.R., Binnekamp, R., Gerritsen, E., de Graaf, R. and van den **Dobbelsteen, A., 2016. 'Business Case Study for the Zero Energy Refurbishment of Commercial Buildings'**, paper presented at the Sustainable Built Environment (SBE) Regional Conference, Zurich, 13-17 June.
- [7] Meijer, F., Itard, L. and Sunikka-Blank, M., 2009. Comparing European residential building stocks: performance, renovation and policy opportunities. *Building Research & Information*, 37(5-6), 533-551.
- [8] Rijksdienst voor het cultureel erfgoed, 2013. Kantoorgebouwen in Nederland 1945-2015. Cultuurhistorische en typologische QUICKSCAN.
- [9] Torcellini, P., Pless, S. and Deru, M., 2006. Zero Energy Buildings: A Critical Look at the Definition. U.S. Department of Energy. National Renewable Energy Laboratory Report.

How a Changing Socioeconomic Context Affects the Demand for High-performance Buildings

Clinton ANDREWS^a

^a Rutgers University, United States of America, cja1@rutgers.edu

ABSTRACT

Technological and design innovations are important drivers of change in the built environment, but they do not work alone. This paper examines a parallel set of demographic and economic trends that will shape future demand for high-performance buildings. It considers historical and projected human populations, since more people means more buildings. It examines changing age distributions, noting that people are living and working longer, older people are becoming a macroeconomic burden, and fewer children are entering the demographic pipeline. The paper also examines economic changes that are resulting in fewer hours worked and more leisure time, albeit with great disparities across countries and occupations, as well as increasing income inequality. It also investigates the role of urbanization which can generate benefits due to propinquity and mobility, as well as costs such as segregation and congestion. Finally, the paper considers the emergence of transhumanism, exemplified by the shift from an office in a building to a smartphone in your pocket, and eventually to implants under your skin. Each of these factors will influence the amount and qualities of shelter we will require, the home/workplace split, the functions required of future buildings, and the energy and environmental footprints of buildings. It relies on the latest historical data and projections by the United Nations, OECD, and other statistical agencies to quantify each of these trends and their implications for the high-performance building community.

Keywords: high-performance building, urban regeneration, green economics

1. INTRODUCTION

When researchers think about the future of high-performance buildings, many use a supply-side perspective that emphasizes emerging technological opportunities and policy objectives, such as smarter systems and carbon neutrality, respectively. This paper instead uses a demand-side perspective to ask how social and economic forces will shape the built environment. It discusses implications of several well established demographic trends as well as a set of more contingent social and economic trends that will affect the demand for high-performance buildings.

2. TRENDS

Several powerful forces will affect the demand for future high-performance buildings, but the trajectories vary from highly likely to highly speculative. This section introduces the most relevant of these trends. See Table 1 for details.

2.1 Established demographic trends

The human population is highly likely to continue growing in every region of the world, with the largest absolute and relative growth occurring in Asia, Africa, and to a lesser extent, Latin America and the Caribbean. The population growth rate represents a lower-bound estimate of the growth rate of demand for new buildings. Replacement of obsolete buildings will further add to demand, and may dominate in Europe, Northern America, and Oceania.

Variable	Year	World	Africa	Asia	Europe	Latin America & Caribbean	Northern America
Population (billions)	1950	2.53	0.23	1.39	0.55	0.17	0.17
	2000	6.13	0.81	3.71	0.73	0.53	0.31
	2050	9.73	2.48	5.27	0.71	0.78	0.43
Median Age (years)	1950	24	19	22	29	20	30
	2000	26	18	26	38	24	35
	2050	36	25	40	46	41	42
Urban Population (%)	1950	30	14	18	52	41	64
	2000	47	34	37	71	75	79
	2050	66	56	64	82	86	87

Table 1: Selected demographic variables by region: historical and projected

More interesting for the high-performance building sector is the expected aging of the human population. Median ages will increase in every region of the world, both because people are living longer and because they are having proportionally fewer children. The common measure of whether the aged population is becoming an economic burden is the old age dependency ratio (retired dependents/ working-age population), and it is expected to reach levels not experienced in the prior 50 years. This implies that many older people are likely to continue working past previously common retirement ages. They will demand affordances at home and at work to compensate for diminishing mobility, eyesight, hearing, and cognitive function. User-friendliness will gain importance as a metric for high-performance buildings.

Urbanization is a third relentless driver of demand for buildings. Every region of the world will experience an increase in the percentage of its population that lives in urban areas. The rural-to-urban migration that fuels urbanization implies, simultaneously, that there will be chronic urban housing shortages and underutilized rural housing.

The proportion of the urban population living in large cities will also increase all around the world. However, it is inappropriate to assume that this will lead to widespread adoption of Hong Kong-style, high-rise building designs. Instead it is important to note that the land areas of most major cities are growing faster than their populations, so that urban densities are diminishing. High-rise building will be a stylistic choice rather than a demographic necessity, and high-performance buildings will continue to come in varied shaped and sizes.

2.2 Plausible economic trends

Positive growth in aggregate and per capita income is likely in all regions of the world, although rates of growth may vary substantially. Differences between high- and low-growth scenarios will be due to the extent of economic openness, inter-country convergence, and growth in productivity. Annual growth in Gross Domestic Product (GDP) per capita globally is likely to be the range of 1% to 5% by 2030 and to diminish to 0% to 3% by 2050. GDP growth and building construction show strong correlations historically, so the construction industry may follow a similar trajectory.

Income inequality has also been increasing worldwide due to economic globalization, uneven education and skill levels across workers, principal-agent problems that allow some leaders to reap outsized financial rewards, and tax policies that concentrate wealth. If this trend continues, it will exacerbate the problem of unaffordable housing in high-growth locations, while continuing to fuel investment in luxury buildings in those same locations. High-performance building frequently targets luxury segments of local real estate markets, so it benefits from the income inequality trend. However, the greater human need will lie with innovative, affordable housing.

The number of hours worked per year by a typical worker has declined in many countries around the world due to improved total factor productivity, changing social norms, and labor-friendly public policies. However, the average trend masks three diverging patterns: (1) High earners are working more hours, (2) Lower earners are often working part time, and (3) More females are working. Residential buildings are therefore likely to enjoy continued intensive use, and commercial buildings will need to offer more flexibility regarding work activities, schedules, and gender affordances.

Advances in information and communication technology (ICT) are helping some workers become untethered from their desks because they can now work anywhere, making cafes and airports new foci for high-performance building. Many more workers, however, will remain tied to specific locations because they need to serve the public, use capital equipment, or engage in face-to-face collaborations.

Two aspects of the ongoing ICT revolution may be of greater interest. First, the human-building interface is changing, as sensor networks become available to monitor local environmental conditions and occupant activities. This movement toward smarter buildings has great potential to improve energy and water efficiency, as long as the systems accommodate the reasonable range of real occupant behaviors. Smart buildings need good user interfaces.

The second ICT trend depends on the relentless force of Moore's Law which has led to exponentially increasing computing capacity, exponentially decreasing computing costs, and dramatic miniaturization of equipment. If the previous decade supported a shift from an office (with a desk, telephone, and personal computer) to a mobile

phone that performs multiple functions anywhere, the next decade could see a shift to miniaturized, perhaps subdermal forms of human augmentation by technology. Buildings will have to adapt continually to serve the information infrastructure needs of these transhumans. Information flows may become as much of a design consideration as energy flows.

3. CONCLUSION

Longstanding demographic forces and less certain economic trends both will shape the demand for high-performance buildings. A growing population will support a growing demand for buildings, especially in Africa and Asia. An aging population will demand more user-friendly buildings with affordances. An urbanizing population will require more affordable housing and convenient workplaces, but not necessarily more high-rise buildings. Continued GDP growth will spur continued building construction, but income inequality may exacerbate affordable housing shortages in growing cities even as concentrated wealth supports high-performance building innovations. Working life may continue to change, with some working fewer hours and others more hours, with some workers becoming increasingly mobile even as others stay in place to provide service, use capital-intensive equipment, or perform in-person collaborations. Advances in ICT seem likely to change both buildings and their occupants, bringing high-performance aspirations to building systems and the technologically-augmented humans who use them. User-friendly interfaces, distributed sensor networks and computing power, and seamless information flows are likely to play more central roles in defining which structures are considered to be high performance buildings.

REFERENCES

- [1] **Andes, S., and Muro, M. Don't blame the robots for lost manufacturing jobs. Advanced Industrial Blog Series #64.** Washington, DC: Brookings Institution. Accessed on 30 May 2016 at <http://www.brookings.edu/blogs/the-avenue/posts/2015/04/29-robots-manufacturing-jobs-andes-muro>.
- [2] Andrews, C.J. The changing socioeconomic context of buildings. *Journal of Solar Energy Engineering*, 2016 special issue on buildings of the future.
- [3] **Andrews, C.J., Yi, D., Krogmann, U., Senick, J.A., and Wener, R. "Designing buildings for real occupants: An agent-based approach,"** *IEEE Transactions on Systems Man and Cybernetics A: Systems and Humans* 41(6) (November 2011): 1077-1091.
- [4] **Angel, S., Parent, J., Civco, D.L., Blei, A., and Potere, D. "The dimensions of global urban expansion: Estimates and projections for all countries, 2000–2050,"** *Progress in Planning* 75 (2011): 53–107. doi:10.1016/j.progress.2011.04.001.
- [5] Architecture 2030. 2030 Challenge. 2006. Accessed on July 29, 2016 at http://architecture2030.org/2030_challenges/2030-challenge/.
- [6] Architecture 2030. 2030 Palette. 2013. Accessed on July 29, 2016 at <http://www.2030palette.org>.
- [7] Dellink, R., Chateau, J., Lanzi, E., and Magné, B. Long-term economic growth projections in the Shared Socioeconomic Pathways. *Global Environ. Change* (2015), <http://dx.doi.org/10.1016/j.gloenvcha.2015.06.004>.
- [8] Dlamini, S., Relationship of construction sector to economic growth, pp. 213-224 in Proceedings of the Joint CIB International Symposium of W055, W065, W089, W118, TG76, TG78, TG81 and TG84. Montreal, 2012, International Congress on Construction Management Research.
- [9] DNV KEMA. Natural Gas Energy Efficiency in Buildings: Roadmap for Future Research. Report CEC-500-2014-036-D prepared for the California Energy Commission, March 2014. Accessed on July 29, 2016 at <http://www.energy.ca.gov/2014publications/CEC-500-2014-036/CEC-500-2014-036-D.pdf>.
- [10] ICCA (International Council of Chemical Associations). ICCA Building Technology Roadmap. August 2015. Accessed on July 29, 2016 at <https://www.icca-chem.org/resources>.
- [11] IEA (International Energy Agency). Technology Roadmap: Energy Efficient Building Envelopes. 2013. Accessed on July 29, 2016 at <https://www.iea.org/publications/freepublications/publication/TechnologyRoadmapEnergyEfficientBuildingEnvelopes.pdf>.
- [12] Kurzweil, R. *The Singularity is Near: When Humans Transcend Biology*. New York: Viking, 2005.
- [13] Lee, S., McCann, D., and Messenger, J.C. *Working Time Around the World: Trends in working hours, laws and policies in a global comparative perspective*. Abingdon, UK: Routledge, 2007, pp. 22-63.

- [14] Leimbach, M., Kriegler, E., Roming, N., and Schwanitz, J. Future growth patterns of world regions – A GDP scenario approach, *Global Environmental Change* (2015), <http://dx.doi.org/10.1016/j.gloenvcha.2015.02.005>.
- [15] Mitani, N. Long-Term Trends in Leisure and Work Hours Economic Theories and Realities, *The Japanese Economy* 39(4(Winter 2012–13): 79–108.
- [16] Olson, G.M., and Olson, J.S. Distance matters. *Human-Computer Interaction* 15 (2000): 139-178.
- [17] Organisation for Economic Cooperation and Development (OECD). (2016). OECD.stat/Labour/Labour Force Statistics/Average Annual Hours Actually Worked per Worker. Accessed on 30 May 2016 at <http://stats.oecd.org>.
- [18] Park, J. Projection of Long-Term Total Factor Productivity Growth for 12 Asian Economies. Working paper 227. Manila: Asian Development Bank, 2010.
- [19] Piketty, T. (2014/2013). *Capital in the Twenty-First Century*. Arthur Goldhammer, transl. Cambridge, MA: Harvard University Press.
- [20] Piketty, T., and Saez, E. (2007). Income and Wage Inequality in the United States 1913-2002; in Atkinson, A. B. and Piketty, T. (editors) *Top Incomes over the Twentieth Century. A Contrast Between Continental European and English-Speaking Countries*, Oxford University Press, chapter 5.
- [21] Senick, J.A. Why energy-saving measures in commercial office buildings fail. Ph.D. dissertation in planning and public policy, Rutgers University, New Brunswick, NJ, USA, 2015. <http://dx.doi.org/doi:10.7282/T3PK0JOS>.
- [22] Shackleton, R. Total Factor Productivity Growth in Historical Perspective. Working paper 2013-01. Washington, DC: Congressional Budget Office, 2013, pp. 1-19.
- [23] U.S. Department of Energy, Building Technologies Office. Multi-Year Program Plan Fiscal Years 2016-2020. Washington, DC, February 2016, pp. 21, 29-112.
- [24] United Nations (2015). Probabilistic Population Projections based on the World Population Prospects: The 2015 Revision. Median Case. Population Division, DESA. Accessed on 30 May 2016 at <http://esa.un.org/unpd/ppp/>
- [25] United Nations, Department of Economic and Social Affairs, Population Division (2015). World Population Prospects: The 2015 Revision, DVD Edition. File POP/5: Median age by major area, region and country, 1950-2100 (years), Medium Fertility Case. Population Division, DESA. Accessed on 30 May 2016 at <http://esa.un.org/unpd/wpp/>.
- [26] United Nations, Department of Economic and Social Affairs, Population Division (2014). World Urbanization Prospects: The 2014 Revision, CD-ROM Edition. File 2: Percentage of Population at Mid-Year Residing in Urban Areas by Major Area, Region and Country, 1950-2050. Accessed on 30 May 2016 at <http://esa.un.org/unpd/wup/>.
- [27] United Nations, Department of Economic and Social Affairs, Population Division (2015). World Population Prospects: The 2015 Revision, DVD Edition. File POP/13-A: Old-age dependency ratio 65+ (15-64) by major area, region and country, 1950-2100 (ratio of population 65+ per 100 population 15-64). Accessed on 30 May 2016 at <http://esa.un.org/unpd/wpp/>.
- [28] United Nations, Department of Economic and Social Affairs, Population Division (2014). World Urbanization Prospects: The 2014 Revision, CD-ROM Edition. File 17a: Urban Population, Number of Cities and Percentage of Urban Population by Size Class of Urban Settlement, Major Area, Region and Country, 1950-2030. Linear extrapolation by author from 2030-2050. Accessed on 30 May 2016 at <http://esa.un.org/unpd/wup/>.
- [29] WorldGBC (World Green Building Council). Advancing Net Zero. 2016. Accessed on July 29, 2016 at <http://www.worldgbc.org/activities/net-zero/>.
- [30] Zhang, S.-X., and Yao, L., A Study on Coordination Relationship of Construction Industry and Economic Growth in Shaanxi Province, Ch. 2 in E. Qi et al. (eds.), *The 19th International Conference on Industrial Engineering and Engineering Management*, Springer-Verlag Berlin Heidelberg 2013, DOI: 10.1007/978-3-642-38433-2_2.

Green Lease Insight – Integrated Approach

Tim SHEN^a

^a RICS, Hong Kong SAR, tim.shen@cbre.com

ABSTRACT

This paper uses three case studies to illustrate green lease program development best practices for the Hong Kong commercial market. In addressing common barriers to the adoption of green leases, it is hoped that green clauses can rapidly become an industry norm.

Keywords: green lease, climate change, industry insights

1. INTRODUCTION

Climate change is the most pressing long term environmental issue of our time. It's widely regarded that the real estate industry is responsible for around 40% of Greenhouse Gas ('GHG') emissions from end-use energy consumption, and in some markets such as Hong Kong, that number can be as high as 90%. In the commercial sector, the amount of energy used is a combination of tenant and landlord activities. Tenants can be responsible for up to 50% of energy consumption. Through the considered incorporation of green provisions in the lease process, tenants and landlords can work together to reduce energy consumption and associated GHG emissions and other negative environmental impacts, paving a path to mutual realisation of multiple business benefits.

Various publications have been released around the world to educate the real estate industry on the concepts behind green leases, outlining the potential benefits, and providing examples of clauses that landlords and tenants can consider implementing. These include the UK Better Buildings Partnership Green Lease Toolkit, Council of **Australian Government's Green Lease Handbook**, **Singapore Building and Construction Authority's Office Green Schedule**, and **Hong Kong Green Building Council's Green Tenancy Driver for Office Buildings**. However, despite these valuable resources, we have yet to see the mainstream adoption of green leases in most Asia markets, and are still far from it becoming business as usual.

This Insight Paper seeks to build on the existing body of green lease literature by looking directly at some practical issues that present an ongoing barrier to widespread adoption and seeing how industry leaders have overcome these. The aim of this document is to provide a flexible model for the creation and implementation of effective green lease clauses for a variety of asset classes, and by both landlords and tenants. To that end, the paper provides perspectives from both landlords and tenants, and practical advice for, different stakeholder groups including peers, their brokerage agents, legal representatives and property managers.

The Insight Paper will show how an integrated approach to engaging all stakeholders in the lease negotiation and transaction process can lead to more effective uptake of green lease clauses, and lead to tangible positive outcomes for landlord and tenant alike. The authors have endeavoured not to duplicate existing work, and have provided references to some of the excellent work already carried out in the industry to date, which readers are encouraged to explore.

2. GREEN LEASES IN THEORY

Although 'Green Lease' is now a common industry term, it is perhaps more useful to refer to 'green clauses' that are typically incorporated into an otherwise standard commercial lease document as being what most industry stakeholders would recognise as a green lease. There are a few examples of lease agreements which are more radical in nature, with commercial conditions being built from the ground up with environmental performance in mind, but these are very much still the exception, rather than the norm. These, so called, 'Dark Green Leases' include provisions to facilitate extreme levels of green building performance, such as committing tenants to a strict energy budget to ensure a building can meet its net-zero energy goals.

Green lease clauses can be introduced by both landlords and tenants, but usually in either case, organisations will **start out developing 'Light Green Leases' which seek to address environmental issues in basic terms**, and usually

allowing flexibility with regards to these are treated in the negotiation process. Often, environmental requirements are not directly embedded in the lease document itself, either because one or both parties have a valid reason for not wanting to make them legally binding, or because requirements may change during the tenancy and are better **placed in a separate Memorandum of Understanding ('MOU'), Service Level Agreement ('SLA'), or some other** kind of addenda that can be more readily reviewed and revised by the parties. Compliance with the green performance requirements in the addenda is then referenced in the lease. Light Green Leases will usually not include any form of penalty for defaulting on a green lease clause – the focus being on the landlord and tenant fostering a relationship of ongoing communication and collaboration, where transparency and teamwork help both sides achieve greater value from the tenancy. This is a key concept – a good green lease will benefit both signatories.

The types of issues typically covered by green lease clauses include dialogue, sharing of data, and actual performance on energy and water efficiency, and waste management. Often, green building issues will be addressed, such as landlord requirements for tenant green fit-outs, or tenant requirements for base building specifications, future upgrades, and property management practices to support green certified fit-outs and other programs such as certified Environmental Management Systems (e.g. ISO 14001). Most green lease clauses are focused on performance outcomes and are therefore ongoing in nature, needing to be translated into processes and procedures for property, facility, and office management personnel.

3. COMMON CHALLENGES TO ADOPTION

While the fundamentals of green lease clauses are relatively straight forward in principle, there are numerous practical challenges that prevent mainstream adoption. Some of these challenges relate to common real estate practices, such as the often-cited issue of split incentives between the parties, which can present very real obstacles during negotiations. Even quite pragmatic issues such as these can be overcome if a green lease program is established with the right foundation. Doing so also helps to address other roadblocks to green lease adoption, including:

- Lack of understanding or misunderstanding about what green leases are, and what they require.
- A perception that green lease clauses present an unnecessary risk – This can vary between stakeholders. To the tenant or landlord, it may be an obligatory risk or the concern over increased cost of fit-out, or operations, whereas to brokers, the issue may **be that negotiating additional requirements that aren't** considered essential, could present a risk to a deal getting signed.
- The sheer diversity within the real estate industry, when overlaid with the range of issues that green lease clauses could potentially cover, can be overwhelming – Leading to a lack of focus and trying to address too much in specific terms. The greater the scope, the more stakeholder issues are likely to come to bear.
- A lack of executive ownership, stakeholder accountability, and incentive for stakeholders to actively pursue green lease negotiation.

4. TOWARDS A PRACTICAL FRAMEWORK FOR GREEN LEASE ADOPTION

In reviewing common practices adopted by companies that have created successful green lease programs to date, several best practices are evident, that are strongly recommended for anyone wishing to start creating a green lease program.

- Before reviewing industry publications that advise on green lease concepts, first gather a group of stakeholders to discuss and agree why green lease clauses are needed, and what the performance goals for a green lease program should be.
- Review common clauses and work with legal advisors to adapt clauses that facilitate the achievement of the identified, but only develop clauses that are deemed necessary, and can clearly be explained to the other party in terms of necessity (e.g. achieving corporate goals, or supporting green building certification).
- Identify key stakeholders in the lease negotiation process and ensure they are well-versed on the green clauses, why they are important, the required outcomes, and how best to introduce and discuss them with the other party. Consider incentivising stakeholders through Key Performance Indicators.
- Integrate the green lease clauses into the real estate process – Particularly ensuring that teams involved in ongoing operations are involved in discussions early.

- Periodically review and revise clauses and their supporting strategies.

4.1 Case study – A landlord green lease

The management team of one prominent Hong Kong landlord wanted to explore how green leases could enhance the environmental performance of its portfolio to the benefit of tenants and the communities they support, but at the same time recognised that being a relatively new concept in Hong Kong, and determined that it would be more effective not to try to unilaterally develop a program.

Therefore, in order to better understand where the market was positioned with respect to considering green lease clauses, they convened a stakeholder workshop with other landlords in Hong Kong and a representative selection of tenants – including those that have a demonstrated commitment to green real estate, for example, having green building certified fit-outs of premises in Hong Kong. The purpose of the workshop was to learn from other **stakeholders' experiences and foster alignment to identify the most effective ways to move forward, and enable** the landlord to create a green lease program that also actively supported green tenants.

The team reviewed best practice from other countries, such as the UK, Australia, and Singapore, and distilled the best from each that fitted within the context of the Hong Kong market. Differences in how tenants are billed for utilities or how waste is managed were critical factors for adaption. The landlord focused on energy, water, and waste because of their universal nature and ease of discussion with tenants.

From their stakeholder engagement program, it became clear that for most tenants, there was a need to do much more work as an industry to raise awareness before green clauses could be formally adopted within legal documents.

The team is holding back from switching straight to a legally binding green contract. Instead, they have opted to take a phased approach to implementing green leases, starting with the incorporation of green aspects into their standard tenant handbook. This is now referenced in all formal lease agreement and all new tenants are thus now required to abide by the green requirements in the handbook. As leases are renewed through their natural cycles, actual green clauses will be gradually introduced throughout the portfolio.

In addition, as green clauses are directly incorporated into leases, the landlord plans to adopt a graduated approach with foundational, primary, intermediate, and advanced clauses being introduced. This is an acknowledgement of the reality that, while everyone has a general sense of environmental challenges that Hong Kong faces, as a landlord, the landlord has a very diverse tenant base, some of whom will want to negotiate very progressive environmental requirements into their lease, and some of whom will be more comfortable with basic elements.

Foundational clauses acknowledge fundamental issues such as energy, water, and waste and provide a platform for collaboration between landlord and tenants. Primary clause will advance this to an agreement to report on performance annually, whereas Intermediate clauses require monthly reporting. Advanced clauses are designed for tenants with their own green commitments - in addition to requiring intensity reporting, there will be a requirement to follow the Hong Kong Green Building Council guidelines such as BEAM Plus Interiors certification. Each level of green lease clause is designed to progressively build on the previous one, rather than represent a huge leap forward.

The program itself has presented challenges for the landlord too, such as how to standardise Greenhouse Gas emissions reporting with tenants. In preparation for this, the team has conducted a thorough review of their own sustainability policies and practices in preparation for the development of formal green lease clauses. The team has also started to organise green lease information sharing workshops through its Tenant Academy to gradually educate tenants and raise awareness of environmental challenges, and the benefits of green occupancy strategies and lease clauses.

The landlord's longer term goals are to see if a platform can be developed that creates a community between itself, green lease tenants, their employees, visitors and people who live around the portfolio. Ideally this would include collaboration with other Hong Kong landlords to ultimately develop standard green lease terms for the Hong Kong market.

4.2 Case study – A tenant green lease

Standard Chartered Bank ('SCB') has been running a tenant green lease program covering their entire global real estate portfolio for several years. Given that their corporate strategy is focused on providing banking services in emerging markets, this has required the development of a green lease platform that can successfully integrate clauses in markets where it will be a completely new concept to most landlords, and even green buildings are at a nascent stage of development. This has become a successful program, introducing green leases to many countries for the first time.

The development of the SCB green lease program has followed the best-practice approach outlined in this paper. **Initially the bank's corporate real estate team recognised that green lease clauses would be essential to meeting the company's aggressive operational energy and water intensity performance targets . In many emerging markets** there is an institutional lack of transparency for a tenant over their actual energy use, so simply having a clause to provide consumption data would be hugely enabling.

The team started by reviewing the sort of green lease advisory documents mentioned in the introduction, and focused down on those provisions that seemed most likely to help meet their corporate goals for energy and water across the portfolio. Through discussion between asset managers and facility managers, a list of six clauses was finally agreed upon.

Importantly, in drafting these clauses, the team took care to present obligations as being mutual, with the Bank and its landlord agreeing to share and collaborate where applicable. This makes a big difference in how green lease clauses are initially perceived by the other party, and facilitates consideration and increases the chance of adoption.

A negotiation strategy was created and disseminated through the asset managers to leasing advisors. While ideally, the Bank wanted all six leases to be incorporated into every lease document, the corporate real estate team **recognised that this wasn't going to be feasible from day one** – particularly in emerging markets. Therefore, while leasing agents were asked to present and negotiate all six clauses for each lease opportunity, they provided some flexibility with regard to adoption. The exception to this was the first clause, which was made mandatory for any space greater than 10,000 square feet.

When they outsourced their global asset and transaction management advisory in 2015, the Bank made a review and enhancement of the green lease program a priority for their service provider, attaching overall account Key Performance Indicators including an absolute increase in the rate of green lease clause adoption year-on-year. In addition, the appointed service provider was tasked with working with a competitor organisation providing outsourced facility management services to develop a plan to convert successfully negotiated green lease clauses into performance outcomes during the tenancy, where landlord cooperation could be tracked.

The service provider developed an enhanced green lease strategy for the bank, which integrated the FM provider, whereby they would be informed of which clauses were included in each new lease so they could follow up with the landlord during fit-out and occupancy. The facility managers are also invited to provide feedback to the leasing team on how the clauses actually perform to enable the whole program to be periodically reviewed and enhanced. Another key component of the new strategy was a comprehensive training program that was developed for the **service provider's account staff and leasing brokers to introduce them to the concept of green leases, the Bank's objectives, and advise on how to effectively introduce and discuss clauses with landlords, as well as properly track outcomes.** After the implementation of this program, the global green lease adoption rate increased by 68% in the first year. Significantly, now that they have far greater visibility on actual consumption data, they are in a much better position to start managing for performance to achieve their efficiency targets.

4.3 Case study –Working with tenant green leases

Increasingly, tenants have their own green requirements presented in lease clauses to landlords. If the landlord already has green lease clauses, this often makes the process easier for both parties to negotiate because they are approaching the discussion from a position where stakeholders are already familiar with the issues and common clauses. However, this can present a challenge if the landlord does not have experience with green leases, as was the case for one major Hong Kong landlord when it was leasing a new commercial property to two

new major tenants. Each tenant had different requirements and approaches to discussing green lease requirements.

The first started in a traditional way, with discussions around standard commercial terms. At the time, the building was still under construction, so the tenant wanted to look at potential base building features that could be adapted to meet their green building requirements, particularly with respect to optimising the performance of future operations. Because of the uncertainty surrounding what those operational needs would be, both parties realised that they could not be hardwired into the lease document itself because it would not be practical to repeatedly go back to the lease to update it as requirements evolved. Therefore it was agreed that the lease would reference a separate document that covered all operational issues, including environmental performance, which could be regularly updated.

A second tenant introduced their green requirements to the landlord prior to the discussions of commercial terms. They had an established green building program and rigorous performance targets, shared case studies and even invited the landlord to visit their green offices in other countries to better understand their expectations from a regional headquarters. They needed assurance from the landlord that they were willing and able to be flexible to accommodate their green needs even before commercial terms were considered. A detailed landlord selection Q&A session on operations planning was held, and the tenant gave active feedback on their expected standards **for energy performance, water treatment, and waste management. The landlord's agreement to meeting fundamental environmental commitments became a prerequisite to moving on to discuss numbers and starting the traditional lease negotiation process.** Because of the focus on performance, it was agreed between the parties to develop a Service Level Agreement that was formally incorporated into the lease, and includes the provision for not just an annual review, but also an improvement plan.

The leases for both tenants reference the agreement to setup and share a comprehensive environmental management plan that, in addition to covering the sharing of energy, water, and waste performance data, also commits the landlord to maintaining indoor air quality to international standards, and reducing environmental impact **to community and society. The leases also oblige the landlord to support the tenant's green fit-out certification goals.**

The experience with these tenants turned out to be the start of a valuable sustainability journey for the landlord. In seeking ongoing performance improvements, they have had to review standard property management practices at a very detailed level and evaluate how changes to standard protocols, such as raising common area temperature set points from 23.5°C to 25°C would be best managed – requiring asset managers to actively work on education and change management with their stakeholders, including staff and tenant, ensuring context and benefits were effectively communicated.

A critical difference promoted by the green lease process in this building, was the development of an unprecedented level of transparency and ongoing communication and collaboration between the landlord and its tenants. This not only included sharing landlord data on building energy use, but also pricing. The results of occupancy patterns and behaviours (such as elevator usage) are recorded and shared with the tenants so they can be disseminated with their employees. This has helped tenants to review their workplace strategies to drive ever greater efficiencies, particularly with respect to after-hours working arrangements.

In this case, the key to successfully meeting the green lease requirements of two large multinational tenants was for the landlord leasing team to engage with their property management colleagues and bring them into the discussions from the beginning. Having obtained their feedback and approval, the leasing team had the confidence to negotiate and agree to the **tenant's green lease requests.**

Both parties regularly follow up on the green lease program and the performance it was designed to facilitate. **While most of that work is now done by the landlord's property management team, the leasing team is still indirectly involved through management level tenant relationship discussions. The team's work has developed a market-leading reputation for the building, and the landlord, in terms of green performance, has shown that a carefully considered approach to environmental performance in the leasing process translates to real business benefits and has encouraged the landlord to actively consider its own program.**

5. CONCLUSION

The industry still has a long way to go before green lease clauses can be considered. Industry leaders with experience have already discovered that there are numerous benefits to investing time and resources to create a green lease platform and educate stakeholders to facilitate the change management process. Hong Kong is setting aggressive GHG intensity **reduction targets to meet obligations under the United Nations' COP 21 agreement** signed by China. Not making green leases, the new business as usual for the commercial real estate industry is missing a relatively easy and cost effective way to identify efficiencies and foster ever stronger relationships between tenants, landlords, agents and the community in general.

REFERENCES

- [1] Better Buildings Partnership, Green Lease Toolkit [online]. Retrieved from: http://www.betterbuildingspartnership.co.uk/sites/default/files/media/attachment/bbp-gltk-2013_0.pdf [Retrieved on 20th September 2016].
- [2] Council of Australian Governments (COAG), The Green Lease Handbook [online]. Retrieved from: https://www.gbca.org.au/gbc_scripts/js/tiny_mce/plugins/filemanager/Green-Lease-Handbook-20120907-PDF.pdf [Retrieved on 30th September 2016].
- [3] Hong Kong Government, Climate Change [Online]. Retrieved from: <http://www.gov.hk/en/residents/environment/global/climate.htm> [Retrieved on 30th September 2016].
- [4] Hong Kong Green Building Council Limited (HKGBC), Green Tenancy Driver for Office Buildings [online]. Retrieved from: <https://www.hkgbc.org.hk/eng/got.aspx> [Retrieved on 19th September 2016].
- [5] Singapore Building and Construction Authority, BCA Building Energy Benchmarking Report 2014 [online]. Retrieved from: https://www.bca.gov.sg/GreenMark/others/BCA_BEER_Abridged_FA.pdf [Retrieved on 30th September 2016].
- [6] Singapore Building and Construction Authority, BCA Green Lease Toolkit: Office Green Schedule 2014 [online]. Retrieved from: https://www.bca.gov.sg/GreenMark/others/Office_Green_Schedule.docx [Retrieved on 30th September 2016].
- [7] Standard Chartered, Environment [Online]. Retrieved from: <https://www.sc.com/en/sustainability/being-a-responsible-company/environment.html> [Retrieved on 30th September 2016].
- [8] Turner, W., 2010. Qualitative Interview Design: A practical guide for Novice Investigation. The Qualitative Report, 15(3), 754-760.

How Sustainable Planning Increases Real Estate Property Value The 3V Framework

Serge SALAT^a, Françoise LABBÉ^b

^a Urban Morphology and Complex Systems Institute, France, serge.salat@gmail.com

^b Urban Morphology and Complex Systems Institute, France, fr.labbe@gmail.com

ABSTRACT

Urban sustainability strategies – increasing transit connectivity across geographical scales, enhancing jobs accessibility, density, mixed-use, creating high urban quality – create density and accessibility dividends that increase land and property values. It is of interest for developers and long-term investors to adopt sustainable urban development strategies. Building on the 3Values Framework developed by the World Bank, on Value Capture Finance mechanisms, on case studies such as **King's Cross in London, and Hudson Yards in New York**, the paper presents sustainable planning and design principles, and innovative finance mechanisms. Property value is created by connectivity and urban quality. Their dynamic interplay has been conceptualized in the World Bank 3V Framework for TOD based on Node, Place and Market Values.

Node value is created by public investment in connectivity/accessibility: 3.6 billion US\$ public investment have **been spent in King's Cross in London, the first European interchange for international high speed, national, and local travel, and 2.87 billion US\$ to enhance connectivity in New York's Hudson Yards.**

Place value is created by sustainable planning with dense street patterns and small blocks, and by design qualities – such as place making, enclosure, human scale, layering of space, complexity, coherence, legibility, and linkage: three major New York parks converge in Hudson Yards with a total public investment of 660 US\$ million. Community socio-economic qualities - quality and proximity of education, health, culture, parks and other social amenities, and jobs opportunities - also contribute to place value.

Once node and place values are created by public investment, private sector investment realizes market value. Private and public sector may then capture value and recycle part of it in further connectivity and place improvement, thus initiating a positive feedback loop of Value Capture Finance increasing both real estate property values and sustainability.

Keywords: planning, transit-oriented development, real estate value

1. INTRODUCTION

This paper addresses the following question: what is the impact of sustainable planning and design such as Transit-Oriented Development on real estate market potential and market prices? Transit-Oriented Development (TOD) refers to an urban environment with high densities, mixed land uses, and quality public space within easy walking distance of a transit stop (Calthorpe 1993). Empirical studies have proven that TOD can effectively increase walking and biking, boost transit ridership, reduce car dependence, lower travel emissions, and enhance accessibility (Arrington and Cervero 2008, Transportation Research Board 2012, Ewing and Hamidi 2014).

Understanding the impact of TOD on real estate markets presents a strong interest for stakeholders. First, when high levels of value are created and realized, local governments can finance infrastructure provision, as well as social housing and social amenities, with value capture finance. These value increases along urban transit stations and corridors, are partially recaptured in cities like London, New York, Hong Kong, Tokyo, for financing further enhancements of infrastructures and of the public realm. This creates a positive feedback loop of development bringing money to governments and developers for financing urban growth. For example, Hong Kong Rail plus Property model allowed Hong Kong government to derive about HK\$140 billion gain (1980-2005) while unlocking land for 600,000 public housing units (Salat and Ollivier 2016). Second, understanding where and when high value potential is created, enables developers to make the right investment decisions on where and at which level to invest in anticipation of increases in transit connectivity, and to develop the right planning and design strategies to maximize economic value around transit stations.

In the first section, based on a literature review, we demonstrate the positive impact of TOD policies on real estate market. In the second section, we present an innovative framework for maximizing economic returns around transit stations developed by the World Bank with the Urban Morphology and Complex Systems Institute, the 3V Framework (Salat and Ollivier 2016). In the third section, we present case studies in London and New York illustrating how value is created and realized through the interplay of the 3 values.

2. THE POSITIVE IMPACT OF TRANSIT ORIENTED DEVELOPMENT ON REAL ESTATE VALUES

2.1 Pedestrian-and transit-friendly design features are capitalized in the purchase or rental price

The positive relationship between TOD characteristics and property value is well established in an international context. Empirical studies have proven that the market values pedestrian- and transit-oriented design, and that this valuation is reflected in the price people are willing to pay to live in well-designed places. In the words of the economist, pedestrian- and transit-friendly design features are capitalized in the purchase or rental price (Landis, Guhathakurta, Huang & Zhang 1995). Characteristics such as land use mix (Cao and Cory 1981, Song and Knaap 2004), street pattern (Guttery 2002), municipal amenities (Shultz and King 2001, Benson et al 1998), proximity to transit stations and commercial centers (Bowes and Ihlanfeldt 2001, Song and Knaap 2004), etc. have been shown to affect the value of residential properties located nearby.

In a very detailed review of the literature, Wardrip (2001) shows that there is a general consensus that accessibility to transit outweighs transit nuisance, and induces a premium on property prices and rental value. However, there is no clear agreement on the magnitude of the impact of transit accessibility on land value, as it also depends on a number of exogenous factors. For instance, the magnitude of this impact is likely to be greater in cities where transit provides clear benefits in terms of accessibility to economic opportunities, as for instance highly congested cities, or cities with very reliable and frequent transit systems (Agarwal 2011). The following table presents several case studies quantifying the impact of transit accessibility on land value.

Goetz et al. (2010)	Hiawatha Line in Minneapolis	\$5,229 premium for single-family homes within half mile radius catchment areas (4% premium in average). \$15,755 for multifamily properties (10% in average)
McMillen and McDonald (2004)	Midway transit line in Chicago	10% premium on single family homes on the long term
Knaap, Ding, and Hopkins (2001)	Portland light rail line	31% premium within half mile radius catchment areas, 10% within one mile radius catchment areas
Immergluck (2009)	Atlanta Beltline	15 to 30% increase in single family homes prices within 1 quarter mile of transit, compared to similar homes more than 2 miles from transit.
Dubé, Des Rosiers, and Thériault (2012).	Commuter Rail Transit in Montreal	1% to 1.5% for houses located less than 1.5 km from the station.

Table 1: Impact of transit accessibility on land value in four US cities and one Canadian city

2.2 The TOD index in the United States

The TOD index study (Renne 2014) in the United States has calculated the differences in property values between TODs and TADs. Transit-Oriented Developments (TODs) are defined as walkable, mixed- use and dense communities within a half-mile of a train station while Transit-Adjacent Developments (TADs) refer to station areas that are characterized by low-density, auto-oriented land uses. Research indicates that gross housing densities should be at least 4,000 households within an area radiating a half-mile from a train station) in order to support transit ridership. Walkscore.com rates communities with a 70 or greater (out of a possible 100 score) as **Very Walkable or a Walker's Paradise (above 90)**. The TOD Index provides a new benchmark to track both home and rental values in train station areas across the United States. The TOD Index includes stations categorized as TODs,

Hybrids and TADs. Each category is also benchmarked against the national Zillow Home Value Index (ZHVI) or the national Zillow Rent Index (ZRI). The study has analyzed 4000 passenger train stations across the United States, among which 1441 have been found to meet TOD criteria of density AND walkscore. 1180 have been categorized as hybrids meeting the criteria of density OR walkscore but not both. 1,775 stations across the US are categorized as TAD stations, which do not meet either criteria for a TOD or Hybrid.

The following charts show the combined impact of density, walkability of the public realm and proximity to urban amenities on the growth of property values. For two similar homes priced 100 in 1996, the home located in a TOD district is worth 400 in 2013, to be compared to 225 for a home located in a TAD district. This impact on rental value is also very significant. For two similar homes rented 100 in 2012, the increase in the rental value of the one located in a TOD district is of 18%, to be compared to 11% only for TAD districts.

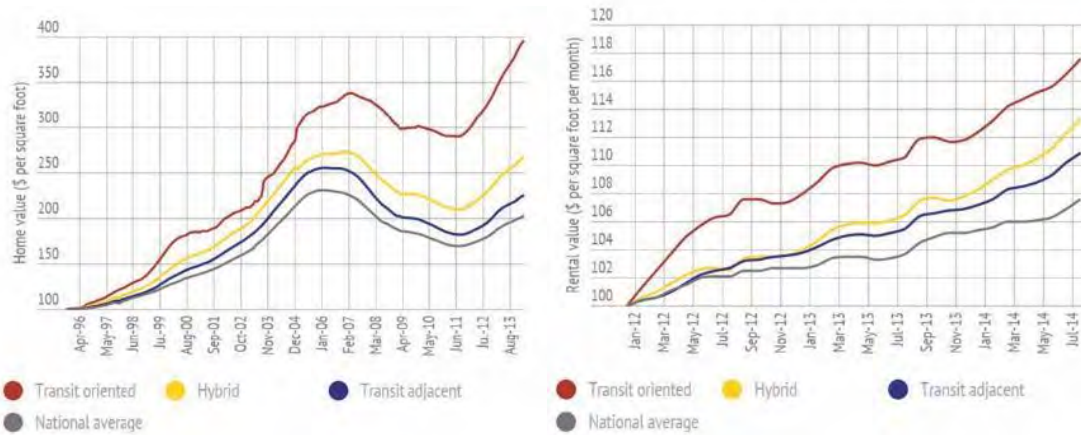

Figure 1: Left: Average home value in the United States in transit oriented, hybrid and transit adjacent areas, and national average, since 1996. Base 100 in April 1996. Source: Urban Morphology Institute. Data: Zillow and TOD index.

Figure 2: Right: Average rental value in the United States in transit oriented, hybrid and transit adjacent areas, and national average, since 1996. Base 100 in April 1996. Source: Urban Morphology Institute. Data: Zillow and TOD index.

2.3 Impact of TOD on housing prices in the Chinese context

These results have been confirmed in the Chinese context. Jiang 2016 has built a TOD score based on density (population density, job density, development compactness), diversity (land use mix, job housing imbalance), design (street network density, highway density, ground-floor retail density, number of parking facilities) and accessibility (distance to transport hub, distance to services, number of bus lines, number of bus stops). He found a positive correlation in Shanghai between the TOD index and housing prices.

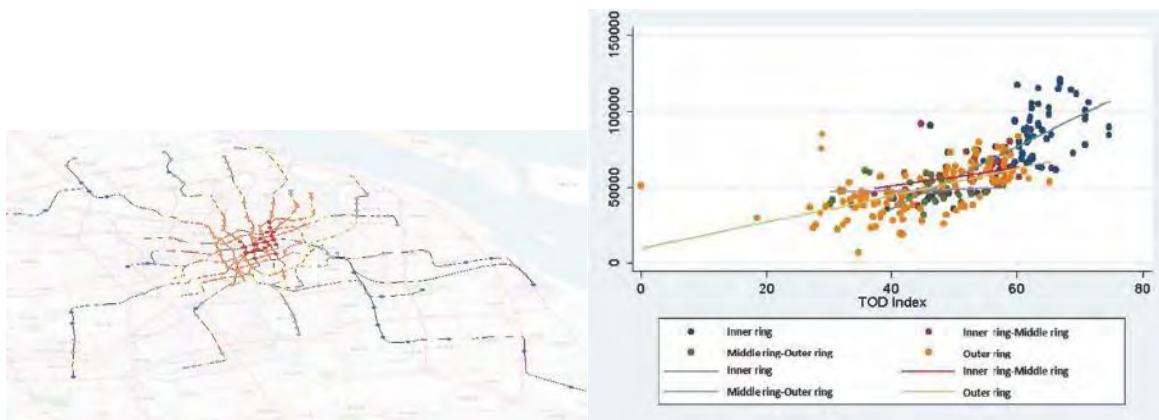

Figure 3: Left: Station TOD Score in Shanghai. Source: Jiang 2016.

Figure 4: Right: Station TOD Score vs. Housing Prices in Shanghai. On the x axis, TOD Index, on the Y axis, Housing price (RMB/sq.m). Source: Jiang 2016.

2.4 The synergy of TOD characteristics

TOD characteristics reinforce each other in a synergistic manner. According to Bartholomew and Ewing (2011), the combination of TOD features contributes to higher property value. Neighborhoods showing at the same time higher than average densities, mixed use, public and open space and interconnected street networks benefit from a higher willingness to pay from residents. According to Song and Knaap (2003), this premium is of US\$24,000 in the Portland Area.

2.5 TOD has different impacts on commercial and residential values

The impact of TOD is however different for residential and commercial land. The impact of stations on residential land values can generally be seen across a relatively wide geographic area with a radius of up to 2 to 4 km from transit station (Steer Davies Gleave 2011). On the other hand, the impact on commercial and business property value is more limited in space, with a radius of 500m to 1km (Steer Davies Gleave 2011). This difference in land value patterns around transit stations is shown in the following figures.

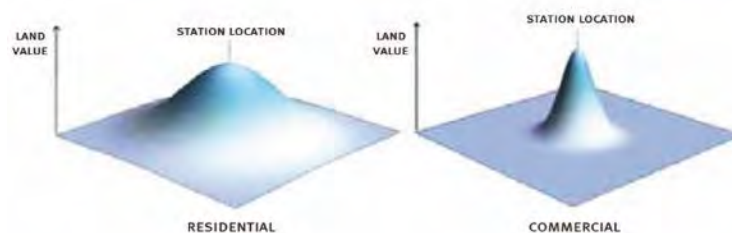

Figure 5: Residential and commercial land value patterns around transit stations (Steer Davies Gleave 2011)

3. HOW TO IDENTIFY “AREAS OF OPPORTUNITY”? THE 3 V FRAMEWORK

3.1 Understanding where, when, and how economic value can be created requires a typology

Understanding where, when, and how potential value can be created requires tools that help differentiate the opportunities offered by the diverse stations in a mass transit network. A TOD typology differentiates transit station areas according to their suitability to accommodate urban and economic growth. A TOD typology aims at creating an aspirational vision of future land uses, prioritizing stations for investment, providing guidelines and actions for implementation, and measuring performance on **a range of metrics**. **The methodology called the “3 Value Framework”, or “3V Framework”, has been elaborated by the World Bank to that end (Salat and Ollivier 2016).**

3.2 Maximizing economic opportunities through the interplay of 3 values

The 3V Framework generalizes previous international approaches based either on node/place model first introduced by Luca Bertolini (1999) or on a market/place model (typologies implemented in Portland and Baltimore) by identifying the three different values that can characterize **a transit station: “node value”, “place value”, and “market potential value”.**

- **“Node value” describes the importance of a station in the public transport network derived from its passenger traffic volume, inter-modality, and centrality within the network.**
- **“Place value” describes the urban quality of a place and its attractiveness to residents in terms of amenities, schools, and healthcare, of type of urban development, of local accessibility to daily needs by walking and biking, of quality of the urban fabric around the station, in particular its pedestrian accessibility, the small sizing of urban blocks, and the fine mesh of connected streets that create vibrant neighborhoods, and the mixed pattern of land use that creates diversity.**
- **“Market potential value” refers to the unrealized market value of station areas, derived through the practice of real estate market analysis. Real estate market analysis is the identification and study of demand and supply and it examines the market potential. Market potential value considers major drivers of demand including current and future human densities (that is resident + job densities), current and future number of**

jobs accessible within 30 minutes by transit, and major drivers of supply including amount of developable land, potential changes in zoning, such as increasing FARs, and market vibrancy. The approach looks forward rather than being only static or looking backward.

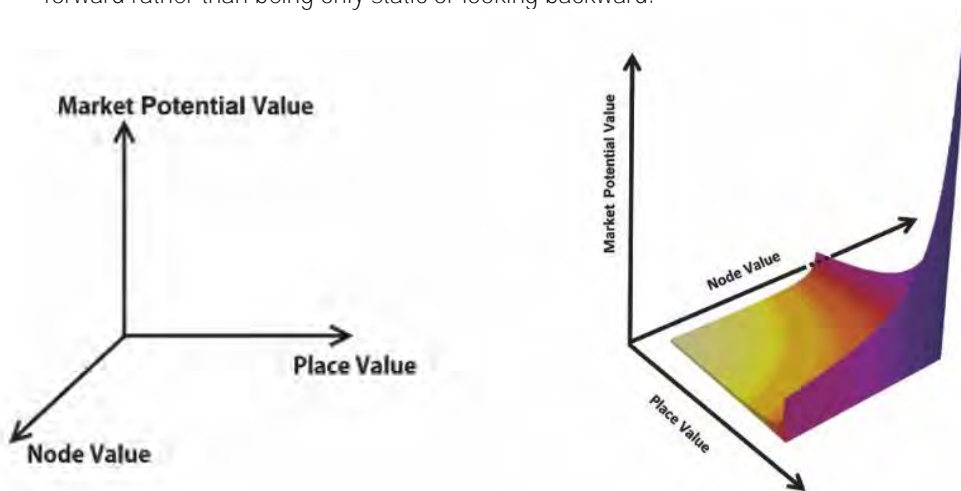

Figure 6: Left: 3V Framework.

Figure 7: Right: Synchronization of high peaks of node value (major connecting hubs) with high quality place making creates spikes of market potential value. An example is King's Cross in London or Hudson Yards in NYC. Source: Salat and Ollivier 2016.

The 3V Framework provides an analytical method to classify transit stations according to their potential to foster economic concentration and land value increases. It presents two main interests for policy makers:

- Building a typology of stations, which classifies the tens or hundreds of stations in a mass transit network into sub-groups for applying different development strategies.
- Determining the imbalances between connectivity, accessibility, place quality, and market potential values in a given station. Addressing these imbalances creates a high potential for economic value creation such as creating place value around an important connective node or bringing additional connectivity to a booming area.

Several levers increase node, place, and market potential value:

Node Value	Place Value	Market Potential Value
Increase number of hubs and number of lines/modes they connect to	Increase compactness (proximity to existing urban activity and short travel time to main destinations)	Increase residential density Increase job density
Interlink neighboring stations into clusters	Increase diversity of uses Increase concentration of commercial, cultural and education amenities	Increase human density Increase diversity of land parcels to create a vibrant land market
Increase accessibility within the network for all	Design neighborhood that promote walking and biking Create a vibrant public realm	Increase social diversity Allow for vertical separation of development rights Increase FARs

Table 2: Levers for increasing the 3 values. Source: Salat and Ollivier 2016.

4. HOW TO REALIZE MARKET VALUE?

Once areas of opportunities identified with the 3 values framework, this section explains how to create and realize market value. The 3V Framework typology allows identifying imbalances in local development and underutilized assets (either because an increase in connectivity linked to public investment in infrastructure calls for a redevelopment; or because high place value calls for investment in connectivity to create a positive feedback loop for market growth). The framework allows fine tuning public investment to market response potential in order to initiate these positive value capture feedback loops addressing the challenges of financing the infrastructure of fast-growing cities.

4.1 Value creation

Value creation strategies involve increases of the three values, each one supporting the others. In King's Cross in London and in Hudson Yards in New York, potential asset values have been created by public sector intervention increasing node value and place value. Public investment in area parks, mass transit and infrastructure will ensure these places become the most livable areas of their cities. Higher node value was supported in both cases through transport infrastructure provision. In King's Cross, it took the form of major investments in local transport infrastructure (up to now, £2.5 billion) turning King's Cross/St Pancras into the most significant interchange for local, national and international travel in London. Similarly, in Hudson Yards, it includes the extension of the No. 7 Subway west and south from its old terminus at Times Square adding a new station at West 34th Street and 11th Avenue as well as the renovation of Moynihan station (total subway extension estimated at US\$3 billion).

Higher place value was supported through environmental and social improvement and investments to enhance **urban quality and image of those sites. King's Cross development combined physical regeneration (e.g. developing sites, refurbishing buildings) with community regeneration (e.g. providing skills, training, community facilities).** In the Hudson Yards area, the public sector undertook the renovation of the Javits Center for US\$465 million. In both **King's Cross and in Hudson Yards**, a lot of attention has been given to the provision of high quality public space and iconic architecture. Three major New York parks (the third section of the High Line, Hudson River Park, and Hudson Park & Boulevard) converge in Hudson Yards supported by major public investment in the public space and parks (US\$630 million).

Higher market potential value was supported by allowing population increase and through land use changes using **planning and regulatory tools. In both Hudson Yards and King's Cross**, major increases in human density are planned for jobs and for residential purpose creating very dense mixed-use communities with human densities (people + jobs) of around 1,750 per ha. Land use changes have taken the form of rezoning at higher values. Zoning is the planning instrument of the physical city. It aims to promote an orderly pattern of development. The Zoning Resolution is a legal instrument to regulate and establish limits on the use of land and building size, shape, height, and setback. Rezoning FARs (Floor Area Ratio, that is the amount of permissible built floor space divided by the land area) at higher values is a planning intervention that creates market potential value in well-connected areas, centrally located, when there is a high demand at city scale. Margins of flexibility between base FAR and maximum FAR allow capturing part of this value creation.

4.2 Value realization

Potential increased asset values are realized by private sector investment. Asset values are tangibly increased and unlocked by private sector involvement and investment through direct investments, comprehensive master planning, and area promotion. For example, growth in New York New West Side can be attributed to the success of the High Line, which has spurred \$2 billion of private investment, 12,000 new jobs and 29 development projects **since opening in June 2009. In both Hudson Yards and King's Cross, innovative master plans, with high quality public space and local connectivity, have been designed by developers with, in London, high level of public participation, and in both cases dialogue between public and private actors. Finally, area promotion through enhanced destination branding and marketing enable new areas to emerge. King's Cross and the area surrounding Hudson Yards are in a process of transformation from derelict industrial rail yards' areas into beacons for creative professionals, a hub for fashion, design, communications and the arts. Both areas are in the process of becoming the home of Google and other fast-growing technology and digital media firms.**

5 CONCLUSION

Some cities have created and captured higher land values through strategic mechanisms coupled with supportive regulatory changes for sustainable urban finance and development. Hong Kong SAR, China, Tokyo, New York, and London have generated funds for their transit systems and promoted sustainable urban development. Once node and place values are created by public investment, private sector investment realizes market value. Private and public sector may then capture value and recycle part of it in further connectivity and place improvement, thus initiating a positive feedback loop of Value Capture Finance increasing both real estate property values and sustainability. The approach is not limited to developed cities and can be applied to fast growing cities. Nanchang, Delhi, and Hyderabad are adapting such an approach for their metro construction.

REFERENCES

- [1] Agarwal, Siddarth. 2011. "The State of Urban Health in India: Comparing the Poorest Quartile to the Rest of the Urban Population in Selected States and Cities." *Environment and Urbanization* 23 (1): 13–28.
- [2] Arrington, G.B., & Cervero, R. 2008. TCRP Report 128: Effects of TOD on Housing, Parking, and Travel. Transportation Research Board of the National Academies, Washington, D.C.
- [3] Bartholomew, K. & Ewing, R. 2011, 'Hedonic price effects of pedestrian- and transit-oriented development' *Journal of Planning Literature*, vol 26, no. 1, pp. 18-34. DOI: 10.1177/0885412210386540
- [4] Benson, Earl D. et al. 1998. "Pricing Residential Amenities: The Value of a View", *Journal of Real Estate Finance and Economics*, 16: 1, 55-73.
- [5] Bertolini, L. 1999. "Spatial development patterns and public transport: The application of an analytical model in the Netherlands". *Planning Practice and Research*, 14(2):199–210. doi: 10.1080/02697459915724).
- [6] Bowes, D.R. and K.R. Ihlanfeldt. 2001. "Identifying the Impacts of Rail Transit Stations on Residential Property Values", *Journal of Urban Economics* 50, 1: 1-25.
- [7] Calthorpe P. 1993. *The Next American Metropolis: Ecology, Community and the American Dream*. New York: Princeton Architectural Press.
- [8] Cao, T.V. and Cory, D. 1981. « Mixed Land uses, Land-use Externalities, and Residential Property Values: A Re-evaluation ». *Annals of Regional Science* 16, 1-24.
- [9] China Association of Urban Rail Transit 2016. 2015 Annual Statistics and Analysis Report of Urban Rail Transit, (In Chinese).
- [10] Dubé, J., Des Rosiers, F., and Thériault, M. 2012. "Impacts of commuter rail transit on property values - The Montreal North Shore case", *EconPapers*.
- [11] Ewing, R., & Hamidi, S. 2014. *Measuring Urban Sprawl and Validating Sprawl Measures*. Metropolitan Research Center at the University of Utah for the National Cancer Institute, the Brookings Institution and Smart Growth America.
- [12] Goetz et al. 2010, *The Hiawatha Line: Impacts on Land Use and Residential Housing Value*. Report #2 in the series *Transitway Impacts Research Program*, Center for Transportation Studies, University of Minnesota.
- [13] Guttery, R. S. 2002. "The Effects of Subdivision Design on Housing Values: The Case of Alleyways", *Journal of Planning Education and Research* 23, 3: 265-273.
- [14] Immergluck, D. 2009. "Large Redevelopment Initiatives, Housing Values and Gentrification: The Case of the Atlanta Beltline", *Urban Studies*, July 2009 vol. 46 no. 8 1723-1745.
- [15] Jiang, Y., Gu, Peiqin, Chen, F., Chen, Y., Zegras, C. 2016. "Measuring Transit-Oriented Development in Quantity and Quality: A Case of 24 Cities with Urban Rail Systems in China". *The 96th Annual Meeting of the Transportation Research Board*.
- [16] Jiang, Y. 2016. "Using open source data to establish indicators for transit oriented development in Chinese cities", *Presentation at Second Working Group Meeting, Global Platform for Sustainable Cities (GPSC), Indicators, Geospatial Tools and GPSC Urban Sustainability Framework*.
- [17] Knaap, G.J., Ding, C., & Hopkins, L.D. 2001. "Do Plans Matter? The Effects of Light Rail Plans on Land Values in Station Areas", *Journal of Planning Education and Research* 21(1):32-39 · September 2001. DOI: 10.1177/0739456X0102100103
- [18] Landis, J., Guhathakurta, S., Huang, W., Zhang, M. 1995. "Rail Transit Investments, Real Estate Values, and Land Use Change: A Comparative Analysis of Five California Rail Transit Systems". University of California.

- [19] McMillen, D. P., McDonald, J. 2004, "Reaction of House Prices to a New Rapid Transit Line: Chicago's Midway Line, 1983–1999", *Real Estate Economics*.
- [20] Renne J. 2014. TOD Index.
- [21] Salat, S.; and Ollivier, G. 2016. The 3V Framework: Maximizing Economic Opportunities in TOD Station Areas by Matching Place, Node, and Market Potential Values. World Bank, Washington, DC.
- [22] **Shultz, Steven D. and David A. King, 2001. "The Use of Census Data for Hedonic Price Estimates of Open-Space Amenities and Land Use", *Journal of Real Estate Finance and Economics* 22, 2: 239-252.**
- [23] Song, Y. & Knaap, G.-J. 2003. "New urbanism and housing values: a disaggregate assessment", *Journal of Urban Economics*, Volume 54, Issue 2, September 2003, Pages 218-238.
- [24] **Song, Y. and Knaap, G.J. 2004. "Measuring the Effects of Mixed Land Uses on Housing Values". *Regional Science and Urban Economics* 34: 663-680.**
- [25] **Steer Davies Gleave 2011. "The Value of Station Investment."**
- [26] Transportation Research Board 2012. SHRP 2 Capacity Project C16: The Effect of Smart Growth Policies on Travel Demand. Prepublication Draft - Not Edited, Transportation Research Board of the National Academies.
- [27] **Wardrip, Keith. 2001. "Public Transit's Impact on Housing Costs: A Review of the Literature." Center for Housing Policy.**

Responsible Investing in Green Buildings and Portfolios

Ruben Langbroek^a

^a Head of Asia Pacific, GRESB, Singapore, r.langbroek@gresb.com

Responsible Investing is getting more and more attention, while an increasing amount of investors are incorporating its principles into their investment process. But what exactly is Responsible Investing? According to the UN Principles for Responsible Investment (PRI), it is an investment approach that explicitly acknowledges the relevance to the investor of environmental, social and governance (ESG) factors, and the long-term health and stability of the market as a whole. The approach recognizes that the generation of long-term sustainable returns, depends on stable, well-functioning (and well governed) social, environmental and economic systems.

We (and the buildings we work and live in) consume natural resources faster than they can be replenished. While doing so, the emissions that are responsible for climate change just keep increasing. And besides these issues, there are other, unprecedented environmental and social issues such as food, water and energy security, air pollution, waste streams, urbanization, human rights, supply chain labour standards, etc. These are clearly major concerns, but why should institutional investors care about them? Because it is core to their (fiduciary) duty. Which is to act in the best interest of their clients and beneficiaries. Responsible Investing requires investors to take a wider view, acknowledging the full spectrum of the risks that are facing the society as a whole. By incorporating sustainability performance outcomes into their investment process, institutional investors can allocate capital in a manner that is aligned with the interests of their clients.

The aforementioned issues are not just environmental or social concerns. They are material, economic issues, and **that makes them relevant to investment risk and return. Investors' main concern is that sustainability**-related risks, as well as the policies that are put in place by governments around the world to avert those risks, will damage the companies and portfolios they invest in. Shareholder value is at stake.

And so, the question arises: can you invest in green portfolios and achieve stable financial returns? The short but clear answer to that question is: yes. A number of studies have shown that listed REITs and private property funds that performed well on sustainability have outperformed their peers in terms of financial returns. And even though the findings do not prove that these portfolios provided higher returns because of the fact that they are sustainable, it does illustrate that sustainability is compatible with good returns.

Further, an increasing amount of evidence, including research performed in Asian markets, shows that green buildings not only provide general benefits such as regulatory compliance, reduced environmental impact, and improved occupant health, well-being, and productivity. But importantly, they also provide financial benefits, including lower operating costs, higher rental level potential, lower vacancy levels, higher capital values, and increased asset liquidity. In short: green buildings provide clear green dividends for investors.

Moreover, green buildings do not have to cost more. We already have the knowledge and experience to develop net-zero buildings that are cheaper to light, heat and cool. Buildings that have reduced environmental impact, and that are resilient to climate change. And buildings that support improved occupant health and well-being.

However, in order to allocate their capital responsibly, investors need to know which property companies and fund managers are focusing on green buildings and portfolios. Further, those that want to go green, need to know where they stand (in absolute terms and relative to their peers), and how to improve their sustainability performance. As **Lord Kelvin already stated over a century ago: "If you can't measure it, you cannot improve it". So, more insight** into green performance (and green economics) of buildings and portfolios is needed in order to transform the built environment into an energy-efficient, low-carbon and climate-resilient one.

To conclude, today more than ever, green is the colour of money. Investors that are willing to invest responsibly, are key to driving change in sustainability approaches in the real estate sector. That change will be crucial, because in the end, more than just shareholder value is at stake.

Session 6.9: Transforming Green Market – Green Economics (2)

Economic and Sensitivity Analysis of Net Zero Energy Refurbishment of Terraced Houses

Angela GRECO^a, Tim JONATHAN^b, Andy VAN DEN DOBBELSTEEN^c

^a Delft University of Technology, The Netherlands, ar@angelagreco.name

^b Delft University of Technology, The Netherlands, tim_jonathan@hotmail.com

^c Delft University of Technology, The Netherlands, a.a.j.f.vandendobbelsteen@tudelft.nl

ABSTRACT

Post-war terraced houses, built en masse for the European middle-class, remain a major consumer of energy, significantly affecting the performance and quality of the residential stock. Prêt-à-Loger is a net zero energy refurbishment (NZER) concept addressing 1.4 million post-war Dutch terraced houses and possibly some other 30.6 million spread throughout North-Western Europe. By applying an integrated external renovation system (**called “the skin”**), **the house becomes energy neutral while at the same time the** living quality and the durability of the house are improved, and extra space is added. This non-invasive renovation project competed at the Solar Decathlon Europe 2014, winning five prizes, among which the first in sustainability. Despite the easy and fast applicability, the financial aspect still presents a serious barrier for large-scale implementation of this and other energy neutral renovation concepts.

The research summarised in this paper firstly identifies the economic factors that can boost the investment in energy neutral refurbishments, on the basis of interactions with public and local authorities, private companies, research institutes and end-users. Secondly, it studies the economic potential of the NZER and the relative importance of the identified factors with Monte Carlo simulations. Different cases are considered to address the situation of single homeowners as well as housing associations needing to refurbish multiple dwellings.

The increase of total rent after renovation for the housing association case and the energy prices for the homeowner case are the most influential factors together with the capital expenditures; the maintenance cost and increase of property value are also relevant elements that can be affected by the right design choices. For the Prêt-à-Loger solution, for instance, a higher increase of property value is registered in comparison to other energy neutral renovation concepts. These findings provide an important support and inspiration for designers and decision makers operating in the field of deep energy retrofit.

Keywords: net zero energy refurbishment, green economics, Monte Carlo simulations

1. INTRODUCTION

Energy use in buildings represents about 40% of Europe’s total energy consumption and CO2 emission (European Commission, 2008). About 70% of buildings are over 30 years old and about 35% are more than 50 years old (Poel et al., 2007), while less than 1% of new constructions is added in any given year. Given the fact that buildings are long-term assets, designed to function for at least 50 years, we can foresee that 75 - 90% of those standing today will remain in use in 2050. These same buildings will form the means to achieve the required 80% reduced energy consumption compared to the 2008 levels (European Commission, 2010). Aiming at high standards of energy efficiency is essential for residential buildings, since they account for 70% of the building floor space (Itard et al., 2008). Within the residential typologies, the post-war terraced houses remain a major consumer of energy, significantly affecting the performance and quality of the residential stock. Around a quarter of Dutch housing consists of terraced houses built between 1946 and 1975. They have a poor energy performance, experience moist and mould problems and offer too little living space by modern-day standards (van den Dobbelsteen et al., 2015).

Prêt-à-Loger is a net zero energy refurbishment (NZER) concept addressing 1.4 million post-war Dutch terraced houses and possibly some other 30.6 million spread throughout North-Western Europe (Bogers et al., 2014). By **applying an integrated external renovation system (called “the skin”)**, **the house becomes energy neutral while at**

the same time the living quality and the durability of the house are improved, and extra space is added. This non-invasive renovation project competed at the Solar Decathlon Europe 2014, winning five prizes, among which the first in sustainability. Despite the easy and fast applicability, the financial aspect still presents a serious barrier for large-scale implementation of this and others energy neutral renovation concepts.

Over the past few years, the government in The Netherlands has stimulated the development of so-called “Nul-op-de-meter” (“zero-on-the-meter”, i.e. net zero energy) renovation concepts for terraced houses. The organisation coordinating this initiative, the **Stroomversnelling**, proposed a target price for these renovations of €45,000 for the private sector, based on savings of energy costs. Because of subsidies related to this fixed target-price, cost benefits on energy savings are often taken as a main criterion by builders to decide which renovation measures will be taken. However, based on current construction methods, builders are still unable to create a renovation achieving both the energy reduction as well as the target price.

In this paper, all financial factors for energy neutral refurbishment of terraced houses are explored. The economic potentials of the NZER and the relative importance of the identified financial factors are then analysed with Monte Carlo simulations (MCS). These allow for a sensitivity analysis of the considered variables, showing the relative impact they have on the value of the refurbishment. Awareness of the relevance of the economic factors can support decision-making and the design phase, which will help create feasible renovations.

2. METHODOLOGY

This section summarises firstly the renovation type considered, then the approach used to identify the financial factors, and lastly, the methodology adopted to perform the MCS.

2.1 Renovation type

For this analysis, the Prêt-à-Loger solution is considered. This is because such a renovation differs from other concepts present on the market, which are not believed to be financially attractive yet. Prêt-à-Loger achieves a higher increase in post-renovation property value, key factor to determine the business case. The issues addressed by the Prêt-à-Loger solution are high energy bills, moisture problems and lack of living space. To preserve the original house, the renovation is designed as a non-invasive construction. An outer skin allows the inhabitants to live in the house during the renovation (hence the name Prêt-à-Loger: ready to inhabit). The skin integrates a number of measures to make the house energy neutral: roof, cavity wall and crawlspace insulation, mechanical ventilation system with heat recovery and phase changing materials (PCMs) in combination with a greenhouse.



Figure 1: Prêt-à-Loger climate design functioning in summer (left) and winter (right)

A smart domotic system controls all installations in the house and provides information about its performance to inhabitants. The insulation, heat recovery and green roof are meant to reduce energy losses through the skin, while the greenhouse harvests the energy from the sun, producing electricity, hot water, and warm air, while also collecting rainwater, and producing food. In spring and autumn the greenhouse can be used as living space, during winter as a rough-climate winter garden buffer zone, and in summer it becomes an open covered terrace connecting the garden and the living room.

2.2 Financial factors

The financial factors were identified by means of interaction with public and local authorities, private companies, research institutes and end-users. The conditions created today by local subsidies and regulations for investments to take place were also considered.

2.3 Monte Carlo simulation

Monte Carlo simulation is a method to solve complex problems by varying parameters within statistical constraints. Each variable is assigned a range rather than a specific value, which allows carrying out analyses when variables bear a certain degree of uncertainty. The Excel application called Oracle Crystal Ball was used to perform the simulations. By defining variable inputs in terms of realistic range of possible values, Crystal Ball performs thousands of calculations, each time using a different randomly selected value based on a specific probability distribution function. In this case, a beta-PERT distribution was chosen as it allows giving a minimum, a most likely and a maximum value. The input variables and the related ranges are given in Table 1 and described in section 3.1. The Net Present Value (NPV) is chosen as output variable, being the most commonly used discriminator for the business attractiveness of a project. A sensitivity analysis on the NPV was performed to study the weight of the variables used as inputs in the model.

2.3.1 Cases

For the simulations, four energy neutral renovation cases are considered:

- Privately owned house with and without greenhouse addition;
- Rented house with and without greenhouse addition.

For each case, two sets of simulations were performed: one assuming realistic variable inputs as shown in Table 1, the other altering the mid value by plus 5% (maximum value) and minus 5% (minimum value) to test the effective influence of each variable independently from its actual uncertainty. All variables shared across the two cases, such as renovation costs or maintenance costs, were kept constant. This is a conservative assumption because when a housing association decides to renovate or maintain part of their buildings, it is likely to do it in bulk, achieving lower renovation costs per housing unit with respect to a single homeowner.

To avoid repetition in the methodology and results sections, the most relevant input variables are explained in section 3.1.

3. RESULTS

3.1 Financial factors

The relevant financial factors identified in the first part of the research are explained in this section as input variables. These are part of the result but also of the methodology adopted for the MCS.

Renovation costs: The reference minimum value for the renovation costs is related to the one suggested by the Stroomversnelling, which takes into account **an average Dutch energy expense of €175 per month, expressed in a mortgage that adds up to €45,000 over a 30-year period**. Construction companies are striving to get close to this target, but still cannot achieve it. **A price of €80,000 was chosen as mid value for the renovation with greenhouse (€ 60,000 for the case without greenhouse) as this is the closest price for energy neutral renovation of terraced houses that construction companies have achieved so far.** This price, however, is still hardly available for private homeowners, while it can be accessible to housing corporations refurbishing more dwellings simultaneously. **€100,000 is about the price any (terraced house) household can find on the market, but it is considered not attractive enough.**

Property value: The appraised value depends on the type of renovation and the specific location of the house and is normally estimated using previous evaluations or by comparing it to similar interventions. Various aspects, such as floor area and aesthetics, drive this increase of value. For NZER the value increase will also originate in part from the energy savings and changed maintenance requirements, although incorporating any kind of energy

intervention in real estate evaluation is a practice still in its infancy. The increase of property value can potentially contribute to the initial capital to finance the renovation. Dutch banks are allowed to provide a loan to value (LTV) of 106% for NZER opposed to a 102% LTV for normal mortgages. A real-estate evaluation of the *Prêt-à-Loger* renovation done by ten different brokers estimated an increase in property value of €37,000 approximately (mainly because of the greenhouse in the backyard – circa 15 m² of additional surface), against the €5,000-10,000 estimated for the average energy neutral renovations that can be found on the market.

Mortgage: As mentioned before, banks can provide a mortgage with a loan to value up to 106% when the property undergoes a deep energy retrofit. Furthermore, Dutch legislation allows banks to provide an additional sum in the form of a mortgage potentially up to €27,000 for energy retrofit, on top of the loan to income. Finally, the Dutch government provides a partial refund on interest paid on housing mortgages (Belastingdienst, 2016).

Loan interest rate and duration: At present, Dutch banks require an interest rate of circa 2% for a fixed mortgage plan (Trading Economics, 2016). The values for the loan duration are chosen considering usual practice for loans (amount and years packages offered by banks) as well as the life span of installations needed for the NZER. The Dutch government refunds part of the interest paid on the mortgage for the first 30 years, and therefore a loan longer than 30 years would not be considered attractive for a house renovation. Thus this value is used as upper bound in the simulations.

Energy performance compensation: Under certain conditions, housing associations are allowed to charge residents with the so-called *Energie Prestatie Vergoeding* (EPV) (Energyling, 2016). This energy performance compensation is a monthly fee that may be charged by the landlord to the tenant if the property meets certain energy efficiency standards. The EPV is the (new) part charged in addition to the rent and service charges. For this analysis the three possible EPV values of 1.0, 1.2 and 1.4 €/m²/month are applied (Coen and Stutvoet, 2015).

Rent increase: Similarly to the property value, the rent could also be increased within market and legislation limits. It should be noted however that with regards to affordability of social housing a rental increase for housing corporations might not be applicable. If the EPV is applied, energy performance cannot influence the increase of rent (Coen and Stutvoet, 2015). The pre-renovation rent value is taken from AEDS (2016).

Maintenance difference: New installations like PV panels, heat exchangers and heat pumps will introduce new maintenance costs. Over the course of a 30-year mortgage, these installations have to be replaced at least once. On the other hand, the renovation itself makes up for overdue maintenance. Furthermore, a smart design in combination with the right choice of materials could potentially reduce the cost of general maintenance. Maintenance costs are taken from AEDS (2016).

Future value: For simplicity, the future value of the variables used in the simulations is calculated using an average inflation rate (EUROSTAT, 2016b). The discount rate is assumed to be zero because investments from homeowners and housing associations are more for savings and energy performance than for economic returns.

Tax implications: The property tax in the Netherlands oscillates approximately between 0.075% and 0.250% of the market value of the property itself (Cijfer Nieuws, 2015). An increase in property value implies an increase in the property tax.

Energy bills: The calculation of the energy cost is a combination of the average consumption rate (Milieucentraal, 2016) and the average energy prices (EUROSTAT, 2016a).

3.2 Sensitivities

Table 1 shows the range used as input for the MCS, while Figure 2 and 3 show the NPV sensitivities for each case. The sensitivity analysis for the NPV is shown from Figures 2 and 3 for the housing association and homeowner cases, respectively. For almost all cases, the biggest impact on the NPV (43 to 65%) is given by the renovation cost. The revenue sources of increase of total rent (including the EPV, which is de facto an increase of rent) for the housing associations (17 to 30%) and energy bills for the homeowners (17 to 53%) also play an important role. Other variables such as the increase of property value (1 to 12%), the increase of maintenance (2 to 11%) and the loan interest rate (1 to 6%) have limited but non-negligible influence on the NPV of the renovation.

Variable	Low	Mid	High	Unit
Renovation cost w/o greenhouse	40,000.00	60,000.00	80,000.00	€
Renovation cost w/ greenhouse	50,000.00	80,000.00	110,000.00	€
Loan interest rate	2.0	2.7	3.5	%/year
Loan duration	15	25	30	Year
Increase of m2 (only w/ greenhouse)	0	7	20	m ²
Increase of property value w/o greenhouse	0.00	7,000.00	14,000.00	€
Increase of property value w/ greenhouse	15,000.00	27,000.00	40,000.00	€
Increase of maintenance	200.00	500.00	800.00	€
Increase of rent	2.00	5.00	8.00	€/m ² /year
EPV	12.00	14.40	16.80	€/m ² /year
Electricity cost	500.00	800.00	1,200.00	€/year
Gas cost	800.00	1300.00	1,800.00	€/year
Tax refund on mortgage		50		%
Discount rate		0		%
Inflation rate		2		%
Improvement in occupancy rate		1		%
House m2		100		m ²
Property tax (WOZ-warde)		0.150		%
Initial rent per m2		60		€/m ² /year

Table 1: Variables and related ranges used for the Monte Carlo simulations.

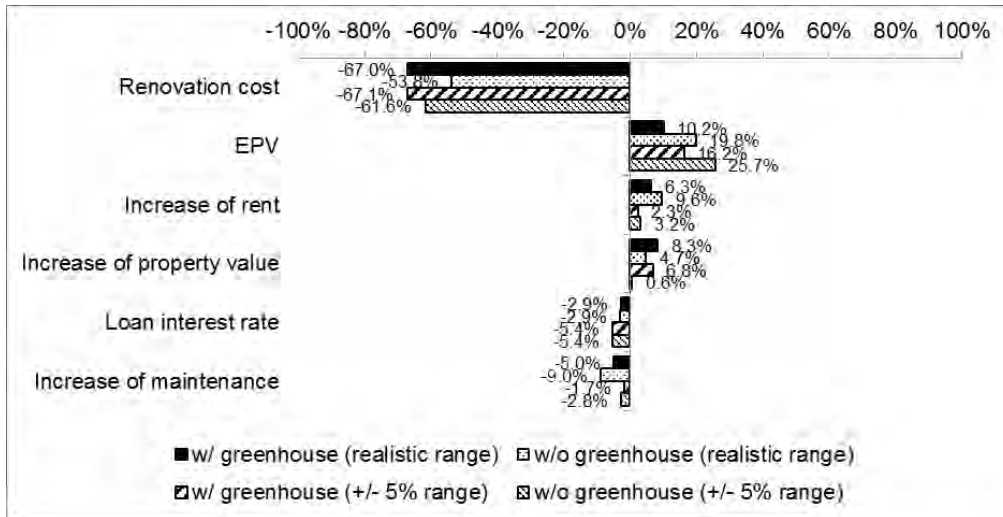

Figure 2: NPV sensitivity for the housing association case.

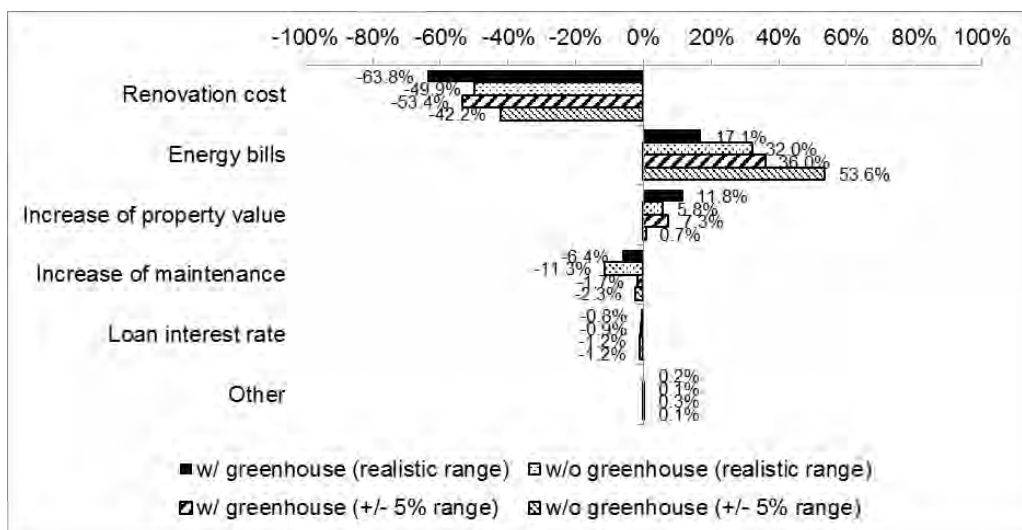

Figure 3: NPV sensitivity for the homeowner case.

4. CONCLUSION

Reducing the cost for energy neutral refurbishment is a relevant and well-understood problem among the involved parties. The sensitivity analyses performed in this study indeed suggest that the initial investment is the financial factor that influences the business case the most. Housing associations have higher chances of improving their business case by accessing to lower prices when refurbishing a large number of dwellings. Increase of rent for the housing associations and reduced energy bills for the homeowners are the most influential sources of revenue when evaluating the feasibility of the NZER. For private homeowners, it is also beneficial to address aspects such as increase of property value, reduced financial risk, and improved living quality.

The Prêt-à-Loger concept has resulted in a higher increase of post-renovation building value, which makes the renovation attractive and more feasible (e.g. due to the higher loan to value). Energy cost abatements and fluctuations in the energy prices strongly influence the return of investment. It follows that improving the living comfort, which affects the increase of property value, becomes even more important when performing energy related upgrades, as this could reduce the dependence of the renovation on the energy market.

REFERENCES

- [1] AEDES, Feiten & Cifers – Woning [online]. Retrieved from <https://www.aedes.nl> [Retrieved on 26 September 2016].
- [2] Belastingdienst, Rente van uw hypotheek of lening [online]. Retrieved from <http://www.belastingdienst.nl> [Retrieved on 26 September 2016].
- [3] **Bogers, B., van den Berg, D., Zijlstra, S. and de Jong, P., 2015. 'The influence of end user perception on the economic feasibility of sustainable building skin renovations', paper presented at the 10th ENERGY FORUM: Advanced Building Skins, Bern, 3-4 November.**
- [4] Cijfer Nieuws, OZB-tarieven 2015 [online]. Retrieved from <http://www.cijfernieuws.nl> [Retrieved on 20 September 2016].
- [5] Coen, M. and Stutvoet, E., Energiesprong 02: Wetgeving Energieprestatievergoeding – 455 [online]. Retrieved from: <http://www.sbrcurnet.nl> [Retrieved on 27 September 2016].
- [6] **van den Dobbelssteen, A., Jonathan, T. and Kruizinga, J., 2015. 'Prêt-à-Loger: Zero Energy Home with Maximum Living Quality Increase', paper presented at the Architecture and Resilience on the Human Scale (AR2015), Sheffield, 10-12 September.**
- [7] European Commission, 2010. Energy 2020: A strategy for competitive, sustainable and secure energy. Communication From The Commission To The European Parliament, The Council, The European Economic And Social Committee and the Committee of The Regions.
- [8] EUROSTAT, Energy price statistics [online]. Retrieved from <http://ec.europa.eu/eurostat/> [Retrieved on 23 September 2016].
- [9] EUROSTAT, HICP – inflation rate [online]. Retrieved from <http://ec.europa.eu/eurostat/> [Retrieved on 23 September 2016].
- [10] Itard, L. and Meijer, F., 2008. Towards a sustainable Northern European housing stock. The Netherlands, Amsterdam.
- [11] Meijer, F., Itard, L. and Sunikka-Blank, M., 2009. Comparing European residential building stocks: performance, renovation and policy opportunities. BUILDING RESEARCH & INFORMATION, 37(5-6), 533–551.
- [12] Milieuceentraal, Gemiddeld energieverbruik [online]. Retrieved from <https://www.milieuceentraal.nl/> [Retrieved on 23 September 2016].
- [13] Poel, B., Van Cruchten, G. and Balaras, C.A., 2007. Energy Performance Assessment of Existing Dwellings & Non Residential Buildings. Energy and Buildings, 39, 393–403.
- [14] Trading Economics, Netherlands Bank Lending Rate [online]. Retrieved from <http://www.tradingeconomics.com> [Retrieved on 28 September 2016].

Finding the Value in Deep Energy Retrofits

James Scott BREW^a

^a Nikken Sekkei, Japan, brew.james@nikken.jp

ABSTRACT

Using stories from two iconic international projects located in Germany and North America, this session will first outline why deep energy retrofits make financial sense to building owners and investors followed by how to approach them and achieve measurable results.

Globally, many Real Estate Investment Trusts, building owners and investors understand the value of “green” buildings. And they also know that simply being green is not enough. They understand that true value of deep energy retrofits lies not in the energy or carbon cost savings, which remain important, but in the asset value and human performance value post-retrofit.

Using pre- and post-occupancy data from real estate valuation, actual energy and water consumption, and human comfort surveys facilitates setting aggressive goals, validating designs using risk mitigation, and measuring performance against prior benchmarks. Applying the right steps in the right order, using a whole-systems or integrative approach, will be covered to demonstrate the important role these play in achieving super-efficiency.

Results from featured buildings and other case studies will show that deep energy retrofits can often save 30 to 50 percent or more in energy cost and carbon and much more in water and waste while improving human health, comfort and productivity.

The real economics of “future proofing” real estate assets in a carbon constrained world lie in the human performance value of our building occupants. Introduction to unlocking this potential will be discussed to encourage more research, application and results.

Keywords: deep building renovation, design process, green economics

1. INTRODUCTION

Around the world, the green building market is maturing. As it does, the strategies and approaches to achieving higher levels of sustainability have improved and become easier to achieve. For example, the number of projects achieving LEED certification at the certified (entry) level is declining while higher levels of certification, Gold and Platinum are increasing. The Gold certification level passed Silver in 2006. See Figure 1.

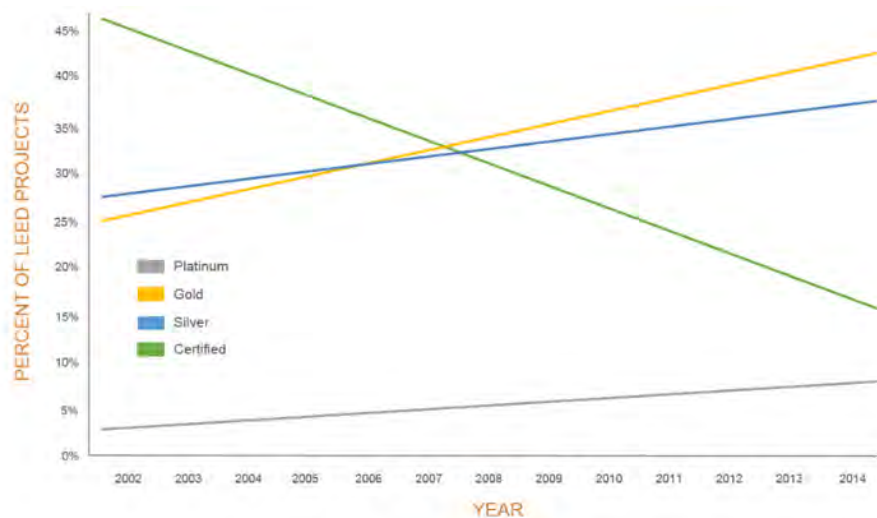

Figure 1: LEED certification trends (USGBC)

But one emerging area that is rapidly evolving is asset valuation. **In the past, the value of “green” was determined** by simply calculating the Return on Investment (ROI) for individual or collective strategies being applied to a building using either simple or Net Present Value (NPV) energy payback calculations. Today, the investors are more engaged and they are not interested in windows, insulation, or air conditioning systems. They are looking for real financial value.

1.1 What is the value of green?

For investors, the value of green is beyond energy savings and green building certification. It is all about the real estate asset value. This is not only projected earnings and Net Operating Income (NOI) but begins to apply increased tenant absorption and retention rates by using research comparing conventional buildings to green buildings in mature markets.

Today, Real Estate Investment Trusts (REITS) are required to have a strategy related to Corporate Sustainability Reporting (CSR) and the pressure to perform on the strategy is increasing. Whether they are driven by the urgency **of climate change or fear of a carbon tax or simply “future-proofing” their investments** — their engagement in the value of green will likely continue.

For building owners and occupants, whether in leased or owned space, the value of green is different. There is increasing evidence that human performance is not only affected by building design decisions, but that worker engagement, health and productivity can be improved by design.

A new standard, the WELL Building Standard®, is the first such green building related standard to focus exclusively **on human health and wellness. WELL is administered by the International WELL Building Institute™ and** certification is overseen by Green Business Certification Inc., which administers LEED certification and credentialing for the U.S. Green Building Council (USGBC).

This focus on human performance is likely to grow and become more sophisticated in the near-term as owners and researchers look for improved metrics and techniques to optimize human factors.

1.2 Two deep retrofit examples

The value for the investments in the deep energy retrofit of both the Empire State Building (New York City, USA) and Deutsche Bank Headquarters (Frankfurt, Germany) were largely based on energy and carbon savings. However, the value created and realized post-retrofit involved more than just energy.

The Empire State Building Company, LLC began their whole-building retrofit with energy and carbon savings as important, but certainly secondary to interior upgrades to finishes and furnishings to regain a Class A office building status. Original estimates of energy savings as compared to then current consumption were 17 percent. After expanding the design and construction team to include Rocky Mountain Institute, whole building energy simulation was utilized to optimize proposed strategies, and to bundle such strategies into packages of potential savings.

The end result was greater than 40 percent energy savings and a less than two-year simple payback. But the real asset value came from the attraction and retention of satisfied tenants post-retrofit. Figure 2 shows the primary strategies and avoided costs (from original investment intent).

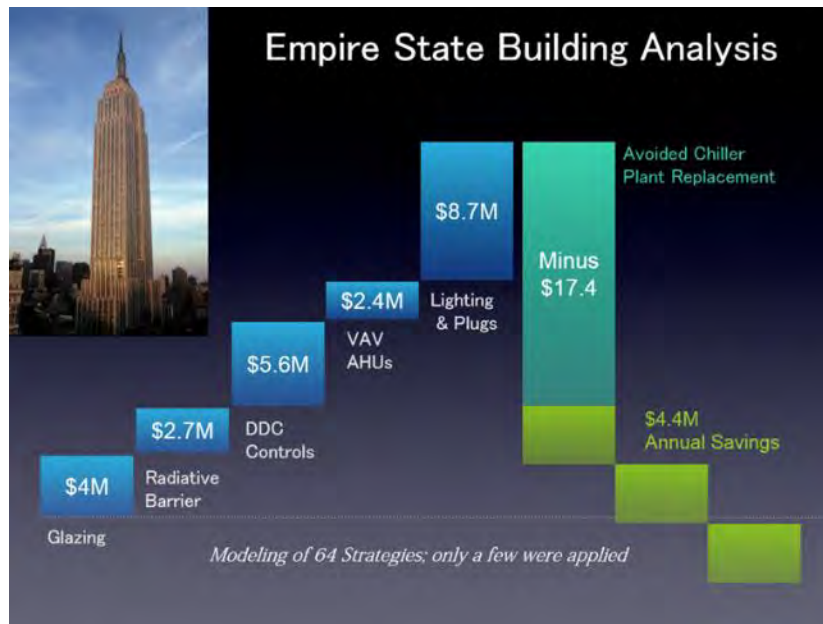

Figure 2: Empire state building savings

Deutsche Bank began their retrofit as a requirement due to a failed fire suppression system. With the building vacated for safety, the opportunity for a whole-building approach became apparent. The existing twin towers were **stripped to their original 1970's concrete shell both inside and outside and rebuilt using integrative design**, whole-building simulation, super-efficient Heating, Ventilating and Air Conditioning (HVAC) systems, operable windows. Figure 3 shows the actual investment cost (which was slightly above median for the scale and scope of the retrofit) in 2011 USD and JPY.



Figure 3: Deutsche Bank energy reductions and investment cost

However, the real value for Deutsche Bank came as a result of good architectural design. Because daylighting and operable windows were key design strategies, the architect removed the offices from the perimeter of the building on all floors, in each tower and moved them inward, using glass on at least one wall to harvest daylight. This allowed a more efficient office layout resulting in approximately 300 additional people being accommodated in each tower. The financial value of this strategy alone more than paid for the investment in green building and energy efficiency almost immediately.

2. APPROACH: MEASUREMENT MATTERS

If there is one word that sums up the optimal approach to **deep energy retrofits**, it's **comprehensive**. Said another way, an approach that uses whole-systems or an integrative design process will yield the best results. In any case, when dealing with an existing building asset, benchmarking is essential to developing a comprehensive strategy.

Benchmarking the historical energy, water and carbon use is relatively straight forward for most asset and facility managers. In North America, it is quite common to use **Energy Star's Portfolio Manager** to understand how an assets performance compares to similar assets, nationally (adjusted for climate, size and occupancy). Figure 4 shows an example comparing individual assets using Portfolio Manager.

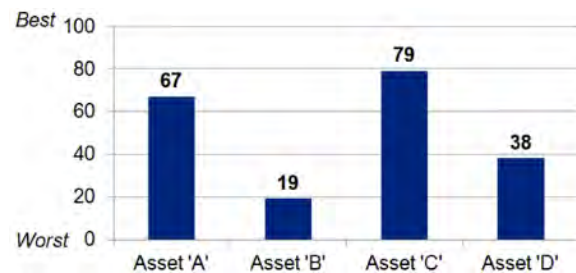

Figure 4: Benchmarking with Portfolio Manager

Benchmarking human performance is typically more subjective. While post-occupancy evaluations are routinely performed by engaged facilities professionals, PRE-occupancy or PRE-retrofit surveys are not common. Easily obtained measurable items include temperature (indoor/ outdoor), relative humidity, CO2 levels (indoor/ outdoor), lighting levels, ventilation rate (measured or calculated) and VOC levels. But the real value to such surveys is in the human perceptions. How people feel is generally closely related to their actual performance, engagement and wellness. In other words — perception is reality. Elements to be surveyed should include thermal, acoustic, and visual comfort, perceived productivity, satisfaction with various elements of the space (such as color, wayfinding, furnishings, etc.), and perceptions of air quality and other factors relevant to the property.

If there is some occupant dissatisfaction with specific elements of a building, prior to retrofit, these might be targeted or prioritized for investment and elements of high satisfaction might seek to be maintained or improved to meet new standards (such as ventilation rates or lighting levels).

3. RESULTS: YOUR MILEAGE MAY VARY

Calculating the real estate value of green appears to be more of an art than a science. While it is always about location and the specific market context, the assumptions used in determining that value are usually an investor or sellers professional opinion.

One way to visualize this value is using the following generic chart, developed by the author. See Figure 5. The 10 - 26 percent savings shown in Figure 5 comes from a comprehensive report by the World Green Building Council.



Figure 5: Relative value increase from green investment

In a detailed analysis by the author for a confidential new corporate office headquarters located in Tokyo, Japan, the value beyond energy savings was estimated using research, post-occupancy surveys and relevant studies on absenteeism, presenteeism and turnover rates from the Japanese market. The investment cost and energy savings, all shown to scale, are from actual figures. See Figure 6.

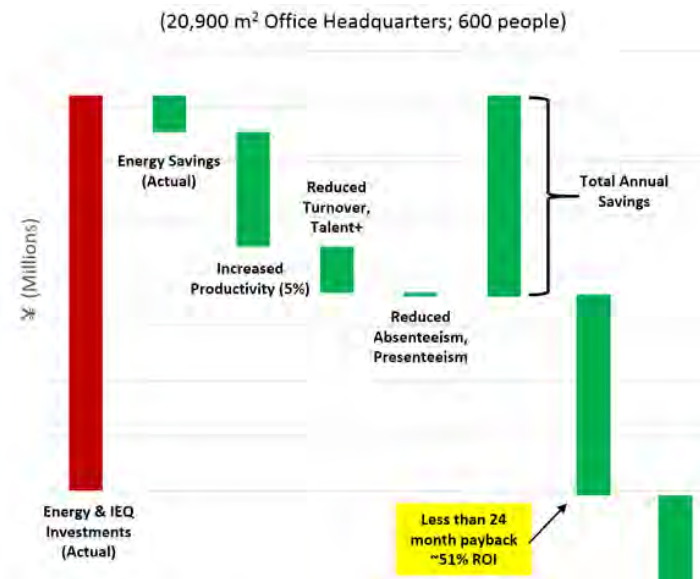

Figure 6: Value beyond energy savings

4. FUTURE-PROOFING: BEYOND THE BUILDING

The real value of deep energy retrofits lies far beyond the energy and carbon savings alone. Uncovering and measuring this value is not only important, but necessary for meeting the challenges we are facing in regards to climate change and facilitating the transition off fossil fuel to a renewable energy supply.

The business case for added financial value in real estate valuation exists in some markets. It is likely to continue to grow and spread to new markets with maturity.

The human value in health, wellness and productivity has been demonstrated to exist in several recent studies where cognitive function is used as a proxy for increased productivity and where specific controlled studies with **repetitive tasks are utilized**. Because a company's salary cost is 50 - 100 times that of energy and water utility costs even a small percentage increase in productivity or reduction in absenteeism can more than pay the energy cost for an entire year.

REFERENCES

- [15] Allen, J.G., MacNaughton, P., Satish, U., Santanam, S., Vallarino, J., Spengler, J.D., 2015. Associations of Cognitive Function Scores with Carbon Dioxide, Ventilation, and Volatile Organic Compound Exposures in Office Workers: A Controlled Exposure Study of Green and Conventional Office Environments
- [16] Rocky Mountain Institute, 2014. How to Calculate and Present Deep Retrofit Value
- [17] World Green Building Council, 2013. The Business Case for Green Building, a Review of the Costs and Benefits for Developers, Investors and Occupants.

Productive Green Roofs

Matthew PRYOR ^a

^a *The University of Hong Kong, Hong Kong SAR, matthew.pryor@hku.hk*

ABSTRACT

Although interest in productive gardening, as part of a healthy, high density city lifestyle, is growing rapidly, severe spatial constraints limit opportunities for ground-level community gardens and urban farms. Over the last ten years, community groups in cities around the world have begun to activate under-utilized building roof spaces for use as community-based urban rooftop farms (URF). These spontaneous projects offer valuable opportunities to address this situation by creating city-based venues for food production, social interaction, and active recreation, and have generated a sense of stewardship for the built environment. Additionally, URFs can have environmental and sustainable building benefits, such as improved building thermal performance, reduced urban heat island effect, increased sound insulation, and urban greening, similar to those of traditional green roofs systems.

This paper reports on an on-going research study to determine the potential for URFs in Hong Kong. All existing URF projects within the Territory were surveyed, to determine the building, environmental, operational and community conditions under which they occur. Analysis of building and land use across all urban districts revealed that some 594ha of existing roof space may be suitable for farming. Assessment of participation rates in open-to-public farms indicate that URFs could provide opportunities for active participation to more than 18,000 people. Given that existing farms are entirely community driven and receive no policy, technical or financial support from Government, potential participation could be much higher. This suggests considerable positive environmental and social benefits could be achieved at the city-scale if URFs were actively promoted and formally incorporated into urban land use planning and city decision making processes.

Keywords: urban rooftop gardening, community empowerment, healthy urban lifestyle.

1. INTRODUCTION

Increasing spatial congestion in high density cities have led to concerns over impoverished environments, unhealthy lifestyles, and low levels of physical activity and community interaction. Opportunities for productive gardening, in particular, are very limited. In Hong Kong, less than 0.1% of the population has access to a private **garden and, to date, only 22 ground level (government operated) 'community farms' have been established at the urban edges**, offering just 1,140 places for would-be gardeners.

In response, some high density urban communities have started to utilize their building roof decks for productive purposes. Since 2009, some 60 urban rooftop farms (URF) have been established on residential, commercial, industrial, and institutional buildings across the city (images 1 and 2). These are run either: by a specific interest community group e.g. a residential, corporate or educational community where participants are drawn from within the building or campus (restricted-access); by a community enterprise which rents roof space to members of the public (open-to-public); or (c) privately, as an entirely closed operation (private). Although the farms are distributed widely, there are notable concentrations within districts such as Kwun Tong, Central and Wanchai.

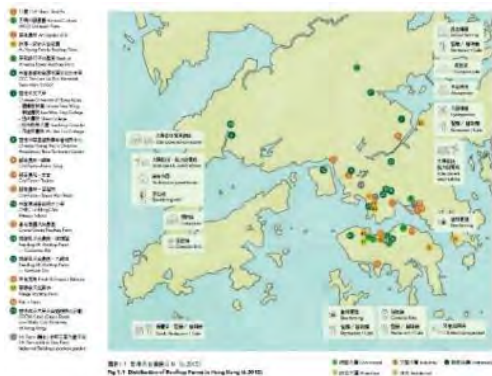

Figure 1: Urban rooftop farms in Hong Kong in 2014, (Pryor 2016)



Figure 2: Aerial photo of the rooftop farm on 38/f of Hysan Place, from Causeway Bay

URFs can be distinguished from ground level farms by their greater spatial limitations and operational complexities (Hui 2011; Thomaier 2015). They emphasise participation rather than production, i.e. involving many participants motivated by personal interest (Pourias et al 2014; da Silva 2016), but working within very small planted areas to produce small quantities of a wide variety of crops. Community benefits such as active stewardship of the urban landscape (Proksch 2014; Pryor 2015) and positive community engagement through place-making (Noori et al. 2016) have been identified as key motivations.

Studies have reported that, in impoverished urban environments, URF's can have similar benefits to green roof installations, e.g. lower solar heat gain and better insulation (Cerón-Palma et al. 2012); improved energy conservation, thermal performance and sound insulation; reduced urban heat island effect (Kitaya et al. 2009); improved air quality (Tong et al 2015); and increased urban biodiversity and positive contribution to urban greening (Borysiak et al. 2016). Specht et al. (2014) also highlighted community benefits of URFs, including higher levels of active recreation, healthier urban life-styles, and greater social interaction amongst participants.

To date, rooftop farming has not been successfully commercialized, but there is growing interest in the potential for large-sale food production on city rooftops (Donald, 2011), to address urban food security issues. Schemes demonstrating commercial potential have been established in Singapore (The Straits Times 2015), and Guangxi (China Daily, 2014), and researchers are now exploring the use of rooftop glasshouses (Cerón-Palma et al. 2012; Sanyé-Mengual et al. 2015); aquaponic and hydroponic systems (Taylor et al. 2012); and vertical growing structures (Banerjee and Adenaueer 2013), to increase production. Technical and economic aspects of commercial rooftop farming are being tested, such as: suitable crop species, growing media, growth performance and production capacity of different farming modes (Pfeiffer et al. 2015; Orsini et al. 2014); sustainability of food production and the influence of climate on potential production; and infrastructural requirements and building restrictions in different cities (Specht et al. 2014).

City authorities are actively looking to farming to make a positive contribution to the urban environment (Colding & Barthel 2013; Martin et al. 2014). The potential for URFs at the city-scale, however, has not been examined. A lack of clear definition or performance criteria have made it difficult for URFs to be formalized within urban land **use planning and decision making processes. For example, in Hong Kong, they are not recognized as 'green roofs'** under Sustainable Building Design Guidelines (Buildings Department 2011), so do not count towards green building coverage.

The objective of this research study has been to make a systematic evaluation of the potential for URFs within Hong Kong, quantifying both the total physical roof space that could be activated for farming, and the possible levels of civic participation in the farms, if established.

2. SURVEY OF EXISTING URBAN ROOF FARMS

The research team conducted a detailed survey of all existing urban rooftop farms and farming operations across the territory, recording the range of building, environmental and community conditions under which they occur. These limits were then mapped against existing land use, building records and census data to give an indication

of the possible number of buildings that could be utilized for URF operations, as well as the total area of farmable roof space, and the maximum number of participants that they could support.

Farms were identified from published articles, websites, and aerial photographs, together with reports from managers and participants of known farms. The research team visited each of them over a 4-month period in early 2016, to document the extent and material condition of the roof and the nature of the farm operations. The survey comprised a detailed physical inspection of the building and farm, interviews with farm managers / owners and survey questionnaires of farm participants. City-wide building and population data was compiled from HKSAR Government building records (Building Department), lands use plans (Lands Department) and census data (Census & Statistics Department).

Those that were private or had been in operation for less than two years were excluded. Amongst the remaining 48 farms, 6 (12.5%) were located on residential buildings (built between 1983-00), 11 (22.9%) on institutional buildings (1983-13), 18 (37.5%) on industrial Buildings (1970-03), and 13 (27.15%) being on commercial buildings (1978-13). **There were 19 'Open' farms (ave. 42 farmers, total farm area 7,315 m²) and 29 'Restricted' farms (ave. 22 farmers, total farm area 5,270 m²).**

In addition to building type and age, data collected to determine the environmental and building limits for URF operations, included: farm location (rooftop / podium deck); rooftop height; means of access (by stairs or lift); roof size and farmed area; other roof uses (e.g. emergency refuge); structural capacity of the roof deck; parapet edge conditions; services / structures; roof drainage; water proofing; water supply; and sunlight / wind exposure. Examples of farms on industrial buildings are shown in images 3 and 4.



Figure 3: Aerial Photo of Hong Kong's Oldest Rooftop Farm, in Quarry Bay



Figure 4: Aerial Photo of the Newly Established City Farm, in Tsuen Wan

During each visit the farm manager / owner was interviewed to understand the history of the farm; building and farm ownership; the funding model and operational structure; the number of participants in the farm and their origin (specific community group or the general public); planter type and typical crop species; soil material and estimated weight; and related activities (instruction sessions, crafts etc.). Managers / owners were further invited to share their experience of the operating limits of rooftop farming.

A questionnaire was distributed through the farm managers to farm participants to generate data on their age and gender; employment status; motivation for participation; frequency and timing of visits; time spent per visit; point of origin (home or work); distance travelled; and level of farming experience.

3. ASSESSMENT OF POTENTIAL FOR URBAN ROOFTOP FARMING IN HONG KONG

Two approaches were adopted to generate a preliminary indication of the potential for URF within Hong Kong, (a) an estimate of physical capacity i.e. the total roof area of all existing buildings capable of supporting URFs, and (b) an estimate of the participatory capacity i.e. applying rates of participation in existing farms (number of participants with respect to their catchment populations), at a city scale.

There are some 41,600 buildings within the territory, comprising residential / composite buildings (80.8% of total building stock); institutional buildings, (6.8%); office/ commercial buildings (6.2%); industrial buildings (4.2%) and others (5.0%). An assessment of the number of buildings on which URFs would be possible was made based on limiting factors.

Structural capacity of the roof deck was the primary limiting condition. All existing URFs are on buildings with flat concrete roof decks. With reference to the existing green roof constructions in Hong Kong, it was determined that only those roof decks that had been designed for emergency fire refuge should be included in the assessment, as these were the only ones that had sufficient structural capacity to support the farm, were accessible directly from the roof level or floor immediately below, and could be used safely. Buildings with long span, lightweight structure roofs (e.g. sports halls), and those with pitched roofs were not included. Buildings with secured uses, sensitive rooftop features or property rights issues that would preclude public access, were not included.

Environmental conditions on the roof were not found to be a limiting factor (as had been anticipated). All farm managers reported that growing conditions (sunlight, rain, shelter from winds, presence of insect pollinators) were favourable, due to the screening effects of parapet walls. As the two highest existing URFs were on 38/f and 39/f level, a cut off building height of 39 floors (approximated to +150m) was adopted in the assessment.

Planted area as a percentage of space covered by the farm was measured at between 14% for larger farms and 32% for the smallest, to an average of 24%. The minimum operable area required to sustain a community-based URF was estimated by farm managers at approx. 40 m² (with an equivalent planted area of 12.0 m²). This effectively excluded all individual, low rise residential buildings.

Farmable roof area was calculated by deducting the space required for rooftop infrastructure (elevator housings, AC units, water tanks etc.) and operational requirements (access to parapet edge for cleaning and inspection, emergency evacuation etc.), from the total building footprint area (measured from building and land survey plans). The typical building footprint area and proportions of roof space taken up by infrastructure and operational requirements was estimated (by building type and height), from building records and land survey plans, for all buildings within two sample urban sub-districts (one in a newer and one in an older urban area). These were cross-checked against aerial photographs.

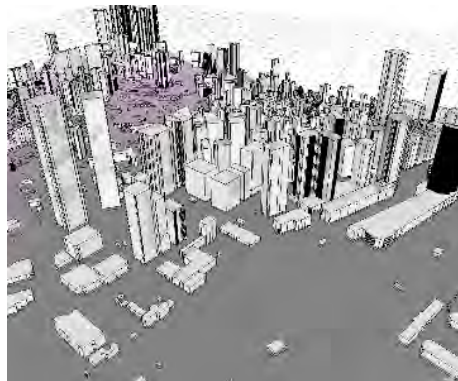

Figure 5: 3D Modelling of Buildings in Hong Kong based on Footprints and Heights, Used in the Estimation of Potential Farmable Roof Spaces

All existing buildings within urban areas were assessed against these building and operable area limits (image 5), to identify those that could be used for rooftop farming, and estimate the potential farmable space on them, (Table 1). This should be considered as only an estimate, based on measurements of two sub-districts. Going forward, the research team will systematically identify and measure each building.

Building type	Building height Low (0-4/floors) Medium (5-12/f) High rise (13-39/f)	No. useable buildings in HK (estimate no.)	Typical building footprint (m ²) (estimate no.)	Percentage of building footprint farmable (typical %)	Estimated Farmable area (m ²)
Residential	Low rise	0			0
	Medium rise	2,160	1,250	10%	270,000
	High rise	5,390	1,070	35%	2,018,555
Institutional	Low rise	320	1,820	65%	378,560
	Medium rise	1,220	1,480	50%	902,800
	High rise	80	920	45%	33,120

Commercial	Low rise	60	2,470	20%	29,640
	Medium rise	110	2,200	50%	121,000
	High rise	1,430	2,070	25%	740,025
Industrial	Low rise	540	1,510	75%	611,550
	Medium rise	930	1,360	65%	822,120
	High rise	60	940	45%	25,380
Total		12,300			5,952,750

Table 1: Preliminary estimate of total farmable rooftop space in Hong Kong

The second measure looked at the potential public demand for rooftop farming across the territory. Owners of open-to-public farms reported that the only limitation on their current operation was physical space. Uncertainty over legitimacy of rooftop farming as a permitted land use and the Government not yet having recognized URFs as countable green building coverage, were seen as principle capacitors on expansion. Owners noted that their farms were heavily oversubscribed and they had to restrict both membership and the extent of farm area worked by individual participants. This is corroborated by the multiple year waiting lists for similar ground level productive garden plots within community gardens (LCSD 2016).

In interviews, farm managers identified participants as either 'regular farmers', typically visiting the farm four or more times a week for a total of more than 3.5 hours, or 'occasional farmers' who visited only once or twice per week for less than 1.5 hours in total. There were many more occasional farmers than regular farmers in each farm, but farm operations were sustained in the long-term by the regular farmers, of whom, they felt, there needed to be at least three.

In open-to-public farms, regular farmers rented 2.0-2.4m² of planter space, but occasional farmers usually rented only some 0.5m². In restricted farms, space was usually less constrained and was not always subject to subscription. Dedicated regular farmers in these operations could manage planted areas of up to 10.0m², with occasional farmers managing 0.9-1.8m² planted area, on average. These figures are comparable to the standard plot size in ground level community gardens of 2.25m² (LCSD 2016), but small in comparison to individual plot sizes of 9.25m² rented out by weekend farms in the New Territories (outside the city) (Fedvmcs 2016), and very considerably below typical rented garden allotment sizes in Europe, of approx. 50m² (Bell et al 2016).

Questionnaire responses indicated that the key demographic groups amongst farmers were young professionals (18-25), middle age workers (35-55), and the recently retired (55-75). The elderly (65-85) were widely viewed as a group likely to become much more involved in future (as the density of farms in the city increased), due to their greater free time and interest in health issues.

Nearly all occasional farmers reported their level of experience as 'very little' or 'none', but regular farmers (who saw themselves as enthusiastic amateurs) reported their experience as 'somewhat competent' to 'competent'. Farm managers did not consider expertise to be a limiting factor in the development of rooftop farming as instruction and support was readily available, and because the key outcome for most participants was social rather than productive. Farmers reported their key motivations as: learning new things; pleasure in growing things; social interaction; and opportunity for outdoor recreation.

For open-to-public farms, questionnaire responses indicated that more than 64% of participants travelled less than 400m to the farm (<10 minutes) from their point of origin (home or work), with 96% having journeys of 800m (20 minutes) or less. 800m was taken to indicate the likely maximum distance a participant might be prepared to travel to get access to a farm. Based on census data for different urban districts in Hong Kong, the likely population within an 800m radius catchment area around of a given location in the city would be between 31,000 and 54,000 people (C&SD 2016).

Participation rates in existing open-to-public farms, i.e. percentage of the population within the 800m of the location of the farm that was involved with the farm, was estimated at between 0.19% and 0.32%. This is similar to the current participation rates for government run community gardens. Restricted URFs drew participants from much smaller catchments (450-27,500 persons), and had participation rates of between 0.38% and 4.4% of that

population. Participants in this type of farm travelled shorter distances (commonly less than 200m) from point of origin (i.e. within the institution or work place).

4. DISCUSSION

Urban rooftop farms have developed spontaneously in many urban districts across Hong Kong over the last few years, without any technical assistance or policy support, suggesting a broad based interest in the activity within the community. This is underpinned by questionnaire responses from existing farmers who cite their motivations for participation as being the desire for healthier lifestyles, social engagement and opportunities to participate in active, nature based recreation, rather than food production. Further, URFs have been established on very different types of building, indicating potential both in terms of the range of spaces that might be available for farms, and the nature of the communities that would be willing to support them.

The survey of current URF operations in Hong Kong, highlighted that the physical restrictions on the use of roof decks for farming were less than anticipated. Since 1970 most building roof decks in the city had been designed for some form of emergency fire escape, giving them the structural capacity to support the weight of rooftop farms, as well as providing suitable safety features and means of access. Only buildings with lightweight or complex roof construction, such as sports halls, did not have the physical capacity.

Aside from small low rise residences (mostly village houses), the roof decks of most buildings were large enough to support a community based farm. Commercial buildings (of all heights) appear to offer the greatest potential area for developing rooftop farms (ave. <2,000 m²), although low or medium rise industrial buildings had the greatest percentage of useable area (65-75%) due to their having least amount of rooftop installations and operational requirements.

The preliminary estimation of 595ha of farmable roof space on buildings in urban Hong Kong needs detailed verification, but when compared with the total area of existing URFs measured in the survey (1.25ha), suggests considerable potential for expansion of rooftop farming activities, if current capacitors can be addressed.

Further, considering that the area of land used for vegetable, flower, field crop, production in rural farms across the whole of Hong Kong was only 420ha at the end of 2015 (AFCD 2015) and is in steady decline due to continued urbanisation, farmable rooftop space offers a potentially valuable resource, if farming practices can be commercialised.

The number of rooftop farmers engaged in the surveyed URFs (total, 1,435), was similar to the number engaged **in the government's community farms, with both being restricted by available farms and farming space. Farm managers' response to the long waiting lists** of limiting plot sizes, has helped to maximize the number of participants within the space available, but with rooftop plot sizes much smaller than those for weekend farms in Hong Kong and only a small fraction of average overseas allotment garden plots, there could be strong demand for greater farm space just from current farmers.

Participants of open-to-public farms were drawn from the resident population immediately around the farm. Easy access to farms was reported by farmers as a key consideration in their participation, with the majority travelling less than 10 minutes to the farm. Participation rate in open-to-public farms, based on the population within a notional 800m catchment of a typical urban district, was estimated to be around 0.25%. Simply applying this to the total urban population suggests that territory wide participation in rooftop farming could exceed 18,000 people. With participation rates up to 4.4% in restricted farms, it is possible that total participation could be higher, particularly as more farms became available and travel distances were reduced, and if the initiative was supported by government and promoted centrally.

The study has indicated that there is already a strong demand and a sizeable potential for the development of **urban rooftop farming in Hong Kong. Although not yet a component of the Government's New Agricultural Policy** (FHB 2016), urban rooftop farms offer a better prospect than traditional urban farms because of the potentially greater farmable area on the **city's rooftops, and closer proximity to participant populations. Rooftop farming also** aligns directly with policies promoting healthier urban lifestyles; community engagement, and aging in place.

REFERENCES

- [1] Agriculture Fisheries and Conservation Department (AFCD), HKSAR Government. Annual reports. Accessed September 2016 from: https://www.afcd.gov.hk/english/agriculture/agr_hk/agr_hk.html
- [2] Banerjee, C., & Adenaueer, L., 2013. Up, Up and Away! The Economics of Vertical Farming. *Journal of Agricultural Studies*, 40-40
- [3] Bell, S., Fox-Kämper, R., Keshavarz, N., Benson, M., Caputo, S., Noori, S., & Voigt, A. (Eds.), 2016. *Urban Allotment Gardens in Europe*. Routledge.
- [4] Borysiak, J., Mizgajski, A., & Speak, A., 2016. Floral biodiversity of allotment gardens and its contribution to urban green infrastructure. *Urban Ecosystems*, pp.1-13.
- [5] Buildings Department, 2011. Practice Note for Authorized Persons etc. APP 152, Sustainable Building Design Guidelines. HKSAR Government. Accessed, October 2015 from <http://www.bd.gov.hk/english/documents/index_pnap.html >
- [6] Census and Statistics Department (C&SD), HKSAR Government. Hong Kong Population Statistics. Accessed September 2016 from <http://www.censtatd.gov.hk/hkstat/sub/so20.jsp>
- [7] Cerón-Palma, I., Sanyé-Mengual, E., Oliver-Solà, J., Montero, J. I., & Rieradevall, J., 2012. Barriers and opportunities regarding the implementation of rooftop eco. greenhouses (RTEG) in Mediterranean cities of Europe. *Journal of Urban Technology*, 19(4), pp.87-103
- [8] China Daily, 2014. Rooftop garden in Liuzhou (report dated 13 May 2014). Accessed, October 2015 from < http://www.chinadaily.com.cn/business/2014-05/13/content_17503183_2.htm#Contentp >
- [9] Colding, J., & Barthel, S., 2013. **The potential of 'Urban Green Commons' in the resilience building of cities.** *Ecological Economics*, 86, pp156-166.
- [10] da Silva, I. M., Fernandes, C. O., Castiglione, B., & Costa, L., 2016. Characteristics and motivations of potential users of urban allotment gardens: The case of Vila Nova de Gaia municipal network of urban allotment gardens. *Urban Forestry & Urban Greening*, 20, pp.56-64.
- [11] Donald, W. W. T., 2011. CTBUH Technical Paper. Case studies of the rooftop farms in Singapore. Accessed September 2016 from <http://ctbuh.org/Portals/0/Repository/Donald_2011_BeyondSkyriseGardens.5a75ebe1-a7f8-4aa3-a29c-3e870ed5d5af.pdf >
- [12] Federation of Vegetable Marketing Co-operative Societies (Fedvmcs 2016). Accessed September 2016 from: <http://www.fedvmcs.org/>
- [13] Food and Health Bureau, (FHB) HKSAR Government, 2014. New Agricultural Policy: Sustainable Agricultural Development in Hong Kong. Accessed September 2016 from: http://www.fhb.gov.hk/download/press_and_publications/consultation/141229_f_agricultural/e_consultation_document.pdf
- [14] Hui, S. C., 2011. Green roof urban farming for buildings in high-density urban cities. In Hainan China World Green Roof Conference 2011 (pp. 1-9).
- [15] Kitaya, Y., Yamamoto, M., Hirai, H., & Shibuya, T., 2009. Rooftop farming with sweet potato for reducing urban heat island effects and producing food and fuel materials. In Department of International Development Engineering 7th International conference on urban climate.
- [16] Leisure and Cultural Services Department, HKSAR Government, (LCSD). Community Garden programme. Accessed September 2016 from: <http://www.lcsd.gov.hk/en/green/garden/location.html>
- [17] Martin, G., Clift, R., Christie, I., & Druckman, A., 2014. The sustainability contributions of urban agriculture: Exploring a community garden and a community farm. *LCA Foods*.
- [18] Noori, S., Benson, M., Gawryszewska, B.J., Hardman, M., Kasemets, K., Partalidou, M., Pikner, T. and Willman, K., 2016. Urban allotment garden: a case for place-making.
- [19] Orsini, F., Gasperi, D., Marchetti, L., Piovene, C., Draghetti, S., Ramazzotti, S., Bazzocchi, G. and Gianquinto, G., 2014. Exploring the production capacity of rooftop gardens (RTGs) in urban agriculture: the potential impact on food and nutrition security, biodiversity and other ecosystem services in the city of Bologna. *Food Security*, 6(6), pp.781-792.
- [20] Pfeiffer, A., Silva, E. and Colquhoun, J., 2015. Innovation in urban agricultural practices: Responding to diverse production environments. *Renewable Agriculture and Food Systems*, 30(01), pp.79-91.
- [21] Pourias, J., Aenis, T., Knierim, A., Riecher, M.C., Ridder, R., Schobert, H. and Fischer, H., 2014, April. Growing food for self-consumption inside cities: lessons learnt from urban allotment gardens in Paris and Montreal. In 11th European IFSA Symposium, Farming Systems Facing Global Challenges: Capacities and

- Strategies, Proceedings, Berlin, Germany, 1-4 April 2014 (pp. 1681-1692). International Farming Systems Association (IFSA) Europe.
- [22] Proksch, G., 2014. Urban Rooftops as Productive Resources: Rooftop Farming versus Conventional Green Roofs. In ARCC Conference Repository.
- [23] Pryor, M., 2015. Productive green roofs. Yuan Lin, Journal of the Hong Kong Institute of Landscape Architects. 2015. Accessed, October 2015 from < <http://www.hkila.com/v2/file/news-pdf289.pdf> >
- [24] Pryor, M.,(2016). The edible roof: A guide to productive rooftop gardening. Hong Kong, MCCM Creations.
- [25] Sanyé-Mengual, E., Cerón-Palma, I., Oliver-Solà, J., Montero, J.I. and Rieradevall, J., 2015. Integrating horticulture into cities: A guide for assessing the implementation potential of Rooftop Greenhouses (RTGs) in industrial and logistics parks. Journal of Urban Technology, 22(1), pp.87-111.
- [26] Specht, K., Siebert, R., Hartmann, I., Freisinger, U.B., Sawicka, M., Werner, A., Thomaier, S., Henckel, D., Walk, H. and Dierich, A., 2014. Urban agriculture of the future: an overview of sustainability aspects of food production in and on buildings. Agriculture and Human Values, 31(1), pp.33-51.
- [27] Taylor, R.W., Carandang, J.S., Alexander, C. and Calleja, J.S., 2012. Making global cities sustainable: urban rooftop hydroponics for diversified agriculture in emerging economies. OIDA International Journal of Sustainable Development, 5(7), pp.11-28.
- [28] The Straits Times, 2015. Urban farms taking off all over Singapore (report 8 February 2015). Accessed, October 2015 from < <http://www.straitstimes.com/lifestyle/urban-farms-taking-off-all-over-singapore> >
- [29] Thomaier, S., Specht, K., Henckel, D., Dierich, A., Siebert, R., Freisinger, U.B. and Sawicka, M., 2015. Farming in and on urban buildings: Present practice and specific novelties of Zero-Acreage Farming (ZFarming). Renewable Agriculture and Food Systems, 30(01), pp.43-54.
- [30] Tong, Z., Whitlow, T.H., Landers, A. and Flanner, B., 2016. A case study of air quality above an urban rooftop vegetable farm. Environmental Pollution, 208, pp.256-260.

Sustainable Buildings – Impacts on Cash Flow and Business Case Analysis

Thomas LÜTZKENDORF^a, David LORENZ^b, Peter MICHL^c

^a Karlsruhe Institute of Technology (KIT), Germany, thomas.luetzkendorf@kit.edu

^b Karlsruhe Institute of Technology (KIT), Germany, david.lorenz@kit.edu

^c Karlsruhe Institute of Technology (KIT), Germany, peter.michl@kit.edu

ABSTRACT

Large parts of the real estate sector have realised that the consideration of the sustainability-related performance of single buildings as well as integration of sustainability aspects into the further development of building stocks are preconditions for the viability and future-proof development of housing and real estate companies. In this context, it can be observed that formerly purely image-driven approaches and corporate strategies with isolated assessments of sustainability aspects are now complemented and/or replaced by more integrated approaches; i.e. real estate sector organisations increasingly attempt to embed sustainability considerations into business routines. However, embedding sustainable development principles within decision making processes requires an integration of sustainability aspects into the methods and tools of such organisations; this includes, for examples, portfolio management, risk analyses, property valuations and economic efficiency calculations. In order to achieve such an integration, these methods and tools do not need to be replaced but specifically further developed. This specific further development of real estate sector business methods and tools is the subject of the present paper. By taking the Discounted Cash Flow (DCF) method as an example, the paper explains which information and data on sustainability-related characteristics and attributes of buildings can be directly and indirectly “translated” into cash flows and how this impacts on DCF-results. The paper will propose subtle adjustments to the traditional DCF method which are likely to result in both, increased transparency and an improved understanding of the various economic advantages of sustainable building features as a basis for decision making.

The paper also argues that any attempt to integrate sustainability considerations into the business routines also requires adjustments and extensions to traditional building descriptions and specifications; which in return, leads to new requirements for the design and planning stages as well as for the documentation of buildings and the facility management process.

Keywords: green economics, real estate companies, business case

1. INTRODUCTION

Within the current scientific debate concerning the description, assessment and interpretation of the economic performance of buildings two approaches can be distinguished: On the one hand, the consideration of the economic dimension is inseparably linked to any assessment of buildings contribution to sustainable development (see also: ISO [1]). In this regard, goals are the minimisation of life cycle costs as well as the preservation of economic capital. The core list of assessment indicators published by ISO [2] contains a reference to life cycle costs. The authors of this paper have already contributed to the development of proposals for an assessment of value and value stability within European standardisation activities (see: [3]). Currently, there is a need for the development of appropriate calculation rules for these economic indicators.

On the other hand, there is growing awareness within the construction, housing and real estate industry for the need to consider sustainability aspects right from the beginning of project developments and within investment decision making processes (see: [4]). Within many different working groups at European and international level, the implications for investment calculations and property valuations have been discussed. Notably for the integration of sustainability aspects into valuation theory and practice respective guidelines and basics for the further education of real estate professionals have already been developed.

Within this context, the possibility of taking sustainability considerations into account within discounted cash flow (DCF) analyses deserves particular attention since the DCF method combines aspects of life cycle costing with an **assessment of a building's future economic value at the end of the holding period.**

The DCF method and the approach of discounting have been and still are subjects of ongoing discussions. Particularly within the sustainable development discourse the argument is often made that by using the standard DCF approach with constant exponential discount rates to evaluate real estate investment decisions the longer-term implications (both benefits and adverse impacts) are simply discounted away. In order to overcome this problem, the application of declining discount rates would represent an alternative. However, while the underlying logic of declining discount rates appears convincing, from a real estate valuation perspective, this would not be a feasible option because within the context of market valuations, the applied discount rate needs to be market derived and the discounting approach needs to reflect the prevailing market conventions.

Therefore, this paper does not discuss possibilities for altering the DCF approach through alternative forms of discounting (since this would most likely not be taken into account by market participants and professional valuers) but focuses on subtle adjustments to the traditional DCF approach as it is currently widely applied in the real estate investment and valuation context.

2. DISCOUNTED CASH FLOW – A COMMON METHOD

The Discounted Cash Flow (DCF) method is among the most widely used property valuation approaches as well as a commonly accepted method for comparing/analysing competing investment alternatives. Within the scope of this paper the focus is placed on the DCF-method as a tool for estimating the value of single buildings only.

In principle, the DCF method can be used to estimate present value of a real estate asset or to extract a rate of return from comparable sale. In typical valuation work, the valuation professional begins by developing detailed spreadsheets containing itemized incomes, expenses and cash flows year by year (or occasionally month by month) over the presumed period of ownership (holding period) or any other study period. The cash flows – including the projected sale price (terminal value) – are then discounted at a particular rate (discount rate) to derive an indication of present value (see Figure 1). The selected rates shall reflect all the risks (and chances) associated with the subject property. For a more detailed explanation of the DCF method, see [7].

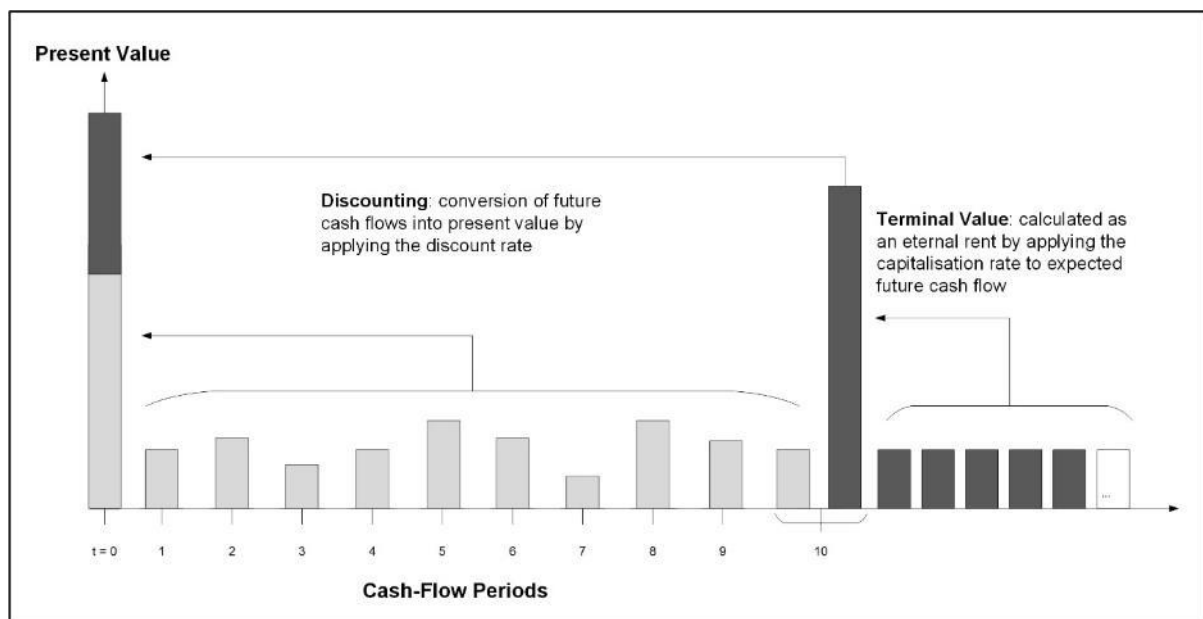

Figure 1: DCF scheme

The figure makes clear that:

- In theory, the DCF method can be very explicit/transparent during the study period since it requires for **detailed cash flow projections**. This is particularly true whenever the valuer's/analyst's assumptions are not "hidden" within the applied discount rate but made explicit through the modelling of the individual cash flows.
- The terminal value at the end of the holding period usually significantly impacts the DCF result. However, estimating this terminal value is associated with considerable uncertainties that need to be taken into account. In addition, longer-term aspects (like recyclability of the building, etc.) need to be taken into

account within the terminal value estimation. For both of these reasons, particular attention has to be paid when determining the capitalisation rate.

- There is a tension between the usually short-term oriented decision-making horizon of investors and longer-term impacts of sustainability-related qualities/performance aspects of the building.

Against this background the following section contains some critical reflections on the traditional DCF approach as it is currently widely applied in practice.

3. REFLECTIONS ON THE TRADITIONAL DCF APPROACH

From the authors point of view, the major criticism of the traditional DCF approach applied to real estate is its lack of transparency. This lack of transparency is mainly due to two circumstances:

First, within the real estate industry there is currently no uniform / generally accepted structure or format for DCF calculations and documentations. This means that varying structures of DCF calculations can be found in practice and benefits and risks associated with real estate assets are accounted for through different input parameters of the DCF calculation. For example, an above-average energy performance can feed into the DCF calculation either through a higher rental growth estimate or through a lower discount rate or through a combination of both.

Second, when applying and determining discount rates, real estate professionals do take into account a whole range of issues implicitly and often even do not make an attempt to explain what has been accounted for and why. Both circumstances hinder real estate market participants in understanding the analysts or valuers thought process **and how he or she derives at an estimate of a building's economic value and how sustainability related considerations might (or might not) have actually played a role and have affected this estimate of value.**

In addition, further problems arise from the current application of DCF calculations: On the one hand, market participants and property professionals typically apply a rather short holding/study period. In most of the cases, the holding/study period is between 5 and 10 years only. This contradicts with the desired consideration of the full building life cycle (e.g. within the scope of a life cycle cost analysis) and leads to the question how future impacts of certain building characteristics and attributes (such as flexibility and adaptability, recyclability, design for deconstruction, etc.) can be appropriately reflected and taken into account within the DCF calculation. On the other hand, there are currently only few published approaches on where and how to appropriately feed sustainability-related considerations into the traditional DCF approach.

In order to increase transparency of the traditional DCF approach it is therefore necessary to identify the typical information needed to determine the input parameters for performing a DCF calculation and to discuss how sustainability related considerations potentially impact on these parameters. This will be done next.

4. RECOMMENDATIONS FOR FURTHER DEVELOPING THE TRADITIONAL DCF APPROACH

4.1 Increasing the transparency of cash flow projections

As it was explained above, the starting point within the DCF approach is the determination/projection of expected cash flows. However, within the traditional DCF approach, usually only those cash flows are represented/covered which directly relate to the perspective of the decision-maker (i.e. in most cases investors). But this also means that some information will get lost.

For this reason, it is recommended to take the complete cash flow along the building life cycle as a basis and to present (or at least mention) all potential incomes and expenses. This should be contained in the DCF calculation as an additional information – comparable to a complete finance/budget plan – accompanying the actual DCF result.

Within the presentation of all incomes and expenses (usually in the form of a spreadsheet) this would result in two additional columns indicating which incomes and expenses have actually been considered for the calculation and which ones are presented as additional information only (see Table 1 for an example). This additional information can then serve as foundation for certain assumption within the actual DCF calculation. For example, low energy

costs (additional information/data) can justify the assumption of a higher rental income or rental growth rate (valuation-relevant information/data).

Incomes	DCF-calculation	Additional information
Rents	X	
Incomes from advertising, mobile communications antenna, etc.	X	
Energy supply to third parties	X	
Incomes from recycling of building materials/components		X
...		
Terminal value	X	
Expenses	DCF-calculation	Additional information
Energy		X
Water/Wastewater		X
Cleaning		X
Maintenance and repairs	X	
Replacement of equipment	X	
Modernisation	X	
Management	X	
Marketing (letting and sale)	X	
Insurances	X	
...		

Table 1: Example of an extended DCF spreadsheet

4.2 Allocation and integration of sustainability-related aspects

The authors take the view that an integration of sustainability-related aspects into property valuation and business case analysis does not require the development of new methods but a fine-tuning / further development of existing approaches. This view is shared in the literature (see, for example, [8], [9] and [10]). In this regard, the authors have contributed to a guideline for Austria, Germany and Switzerland on integrating sustainability aspects into property valuation practices (see [11]). As a result of a research initiative of the Green Building Alliance, recommendations for integrating sustainability aspects into DCF calculations are now also available. The following tables 2 and 3 represent some of these results which have been produced with the authors substantial participation.

Rental space information	Building management information	Market assumptions	Terminal value assumptions
For each lease: - Type of lease - Rental level - Area - Utilities payments (energy, water and waste bills) - % of utilities payment charged back to tenants	- Operation expenses and repairs - Capital expenses (modernisation and replacement)	- Market rent - Inflation - Discount rate - Capitalisation rate - Duration to let - Letting fee	- Market rent at exit date - Maintenance costs at exit date - Capitalisation rate at exit date - Utilities payments at exit date - % of utilities payment charged back to tenants at exit date

Table 2: Proposal of format for a generic DCF framework presentation to ensure accounting of sustainability related-information (see [12])

The most important variables which are influenced by sustainability issues and which influence the risk premium **and the composition and modelling of a property's cash-flow**, are the risk of losing the tenant(s), growth potential for rent and value, occupier costs, tenant retention and fluctuation, duration and costs of letting, and depreciation as well as refurbishment and maintenance costs. While these variables are considered implicitly to a large extent when using the standard investment valuation method where the property's net income is capitalised as an eternal rent, they can be made explicit when using the discounted cash-flow (DCF) method. For this reason, Muldavin and others have argued that the application of the DCF method is the only meaningful option for practitioners, as it

allows consideration of the full spectrum of sustainability-related revenues, chances and risks within the valuation process in a comprehensible and understandable manner.

For both the DCF and standard investment method, the applied discount and/or capitalisation rates are used to **transform future net income into the property's present monetary value. In doing so, the applied rates indicate the risk associated with the future income stream: the higher the risk, the higher the discount and/or capitalisation rate and the lower the assigned monetary value of the property.** When using the DCF method, a constant discount rate is generally applied for the entire period under consideration (usually five to ten years). However, this constant rate is essentially the average of an exponentially increasing rate because income streams at points further in the future are more risky (the same applies for the capitalisation rate when using the investment method, where a constant rate is applied in calculating the present value of an eternal rent). This explains why sustainability issues must be considered today whenever discount or capitalisation rates are determined for valuation purposes. Future risks can be considered lower for sustainable buildings, whereas the future income stream of conventional buildings is assigned a higher risk.

DCF Input Parameters	Key sustainability-related quality and performance characteristics
Market rent	<ul style="list-style-type: none"> - Comfort level - Building related services: serviceability - Aesthetic and cultural quality - Presence of certification schemes/labels (and associated brand image) - Energy performance level (based on EPC or other assessments) - Mandatory requirements and market standards as regards sustainability performance - Space efficiency - Accessibility
Current utilities	<ul style="list-style-type: none"> - Level of utilities costs attributable to the tenants and the owner - Source of energy (presence of renewable sources) - Energy costs trends
Operation expenses and repairs	<ul style="list-style-type: none"> - Durability and maintainability of components - Ease of cleaning (part of maintenance) - Cost of repairs - Reliability of technical installation (failure per hours of running time)
Capital expenses	<ul style="list-style-type: none"> - Modernisation expenses (energy efficiency retrofit, improvement of functionality, resources consumption, etc.) - Costs for adaptation to climate change and user needs - Dismantling, landfill and /or recycling of components
Duration to let	<ul style="list-style-type: none"> - Aesthetic and cultural quality - Flexibility and adaptability (easy to move in), - Compliance with ESG regulation of tenants - Presence of certification schemes/labels (and associated brand image) - Space efficiency - Accessibility
Discount rate	<ul style="list-style-type: none"> - Risk assessment of impact of climate change - Resilience against natural and climate hazard (e.g. flooding, etc.) - Structural safety
Capitalisation rate	<ul style="list-style-type: none"> - Durability and recyclability of the building - Future-proofness and degree of resistance against various forms of obsolescence - Compliance with foreseen regulations - Long-term aesthetic quality

Table 3: Proposal for the allocation of sustainability-related quality and performance characteristics into DCF input parameters (see [12])

At the minimum, it is recommended that within a DCF calculation a supporting document or explanation is being produced revealing which sustainability-related aspects have been taken into account through which input parameter. In addition, the respective source of information (e.g. planning documentation, building passport, consumption values) should also be disclosed.

5. CONCLUSION The recommended adjustments to the traditional DCF approach can contribute to an improved transparency and traceability of DCF results. They can also provide a basis for the development of a standardised/generic format and approach for DCF calculations and resulting documentations. In addition, they improve the ability of decision-makers to better fulfil their responsibilities towards the environment and society. Also, the consideration of sustainability-related aspect within the scope the estimating the terminal value of a building at the end of the holding period contributes to resolving the conflict between investors short-term oriented decision-making horizon and longer-term implications of certain sustainability-related performance aspects of a building. However, it needs to be acknowledged that the topic of terminal value estimation – particularly the issue of treating uncertainties – deserves further work and scientific debate.

REFERENCES

- [1] ISO (2008). ISO 15392, Sustainability in building construction: General principles. International Organization for Standardization, Geneva.
- [2] ISO (2011). ISO 21921-1, Sustainability in building construction: Sustainability indicators, Part 1: Framework for the development of indicators and a core set of indicators for buildings. International Organization for Standardization, Geneva.
- [3] CEN (2012). EN 15643-4, Sustainability of construction works - Assessment of buildings - Part 4: Framework for the assessment of economic performance. European Committee for Standardization, Brussels.
- [4] UNEP FI (2014). Sustainability Metrics – Translation and Impact on Property Investment and Management. United Nations Environment Programme Finance Initiative, Geneva.
- [5] RICS (2013). Sustainability and Commercial Property Valuation. RICS Guidance Note. Royal Institution of Chartered Surveyors, London.
- [6] Hartenberger, U., Lorenz, D. and Antink, R. (Eds) (2015). RenoValue. Drivers for Change: Strengthening the Role of Valuation Professionals in Market Transition. Brussels, available at: <http://renovalue.eu> (accessed 15 June 2016).
- [7] AI (2001). The Appraisal of Real Estate, 12th edition, The Appraisal Institute, Chicago.
- [8] Muldavin, S. (2010). Value Beyond Cost Savings: How to Underwrite Sustainable Properties. Green Building Finance Consortium, San Rafael, CA.
- [9] Christersson, M., Vimpari, J., & Junnila, S. (2015). Assessment of financial potential of real estate energy efficiency investments – a discounted cash flow approach. Sustainable Cities and Society, 18, 66-73.
- [10] Meins, E., & Sager, D. (2015). Sustainability and risk: Combining Monte Carlo simulation and DCF for Swiss residential buildings. Journal of European Real Estate Research, 8(1), 66-84.
- [11] Meins, E., Lützkendorf, T., Lorenz, D., Leopoldsberger, G., Frank, S., Burkhard, H.P., Stoy, C. and Bienert, S. (2011). Nachhaltigkeit und Wertermittlung von Immobilien. Leitfaden für Deutschland, Österreich und die Schweiz – NUWEL. Center for Corporate Responsibility and Sustainability, Universität Zürich, available at: www.nuwel.ch.
- [12] Kamelgarn, Y., Lützkendorf, T., Lorenz, D., Kajander, J.-H. and Hovorka, F. (2015). Sustainability thresholds generating value. Sustainable Building Alliance, Paris.
- [13] GBCA (2008). Valuing Green. How Green Buildings Affect Property Values and Getting the Valuation Method right. Green Building Council Australia.

Business for Sustainability: Market Incentives for the Better

Thomas SCHLUCK^a, Robert BÜHLER^b, Sabine SULZER^c, Matthias SULZER^d

^a Hochschule Luzern, Switzerland, thomas.schluck@hslu.ch

^b Hochschule Luzern, Switzerland, robert.buehler@expertadvisors.ch

^c Change38, Switzerland, sabine.sulzer@hslu.ch

^d Hochschule Luzern, Switzerland, matthias.sulzer@hslu.ch

ABSTRACT

An important cornerstone to reach the goals of the Swiss energy turnaround is the consecutive addition of renewable power sources. The integration of these sources into the existing electricity grid bears new challenges and requires an increased flexibility of the electrical grid since the power generation tends to be more decentralized and volatile in nature.

This development implies shifts in the daily power production and in consequence needs an adaption in load-management. A further aggravation is the planned liberalization of the Swiss electrical power market, which will force utilities and providers to search for new business models, which will cope with all of these developments.

Such a new business model is “Change38”, which focuses on renewable energy sources and establishes a common market for local producers and consumers. Its goal is to distribute the produced electricity among its participators in real-time and to set local incentives to drive and accelerate the further addition of power supply and storage systems.

The business models approach addresses the questions of load-management, dissemination of renewable energy sources and monetarization of further sources by a self-regulatory approach. It gives merely the necessary framework to produce and consume on the right, most valuable time.

The developed business model addresses the socio-economic trend of a share-economy as well as the socio-technical trend of industry 4.0.

In previous works a simulation framework was presented, which allowed calculating all monetary flows and physical balances for each participant based time-series for power production and power demand.

Here we will compare our findings with the first available live-data sets and present the latest developments and adaptations of the business model.

Keywords: distributed energy system, energy measurement and verification, renewable energy

1. INTRODUCTION

With the realignment of the Swiss energy policy in 2007 (Bundesamt für Energie, 2015) (Pito, 2014) (Bundesamt für Energie, 2016) it was decided that decentralized renewable energy sources (DES) shall become a major pillar of the Swiss energy supply. Since then the question how to integrate DES into the existing power grid stimulated research in this field (Farhangi, 2010). For the dissemination of a technology federal subsidies are an effective, but short term solution. For a sustainable realization and long-term preservation a technology must be profitable. This is a more and more crucial point such that new and effective business models (Tanaka 2011) (Facchinetti et al., 2016) (Facchinetti and Sulzer, 2016) are in need, which do not rely on any subsidies at all.

Business models following the socio-economical trend of sharing and the socio-technical trend of the industry 4.0 (Lasi et al., 2014) by matching demand and production (Palensky and Dietrich, 2011) are now emerging. An **instance of such a new model is the “Brooklyn microgrid” (Orsini, 2016), which intends to establish peer-to-peer trading based on the blockchain-technology (Swan, 2015). Another instance is the Swiss start-up company “Change38” (Bühler, 2016) which provides a self-developed platform for sharing that brings participants together and establishes incentives to produce and consume energy when it is needed, respectively available. In contrast to Brooklyn Microgrid Change38 is not only connecting providers with consumers, but it is part of the system. A**

detailed description of the underlying business model can be found in (Schluck et al., 2016). In this work the parameter space of the Change38-model was explored based on Monte-Carlo simulations such that the system had been characterized in terms of its profitability and physical behaviour. Since then the model has undergone some slight modifications, which will be mentioned and presented here later on. However, the fundamental relations between the participants did not change and the findings in regard to the physical performance indicators like the self-sufficiency, self-consumption, and the ratio of production and consumption of pooled participants still holds true.

In addition for about a year a pilot project is running in the village “Gachnang” to establish a better understand of this economic-physical system and among others develop the necessary hardware. The collected data helped to clarify some critical parameters and supports the findings of the before mentioned Monte-Carlos simulations. Here we will present some implications and give some illustrations of the collected data.

1.1 Working principle

The basis of Change38 is to cluster local producers and consumers and set incentives for matching their production and consumption within their cluster. The idea is that in the long term this should lead to participants trying to fill the supply gaps. To make this work all production and consumption must be monitored. Thus the participants will get an update to their standard electricity meter with a real-time measuring device. The data is then saved online and for each point in time the matching of production and consumption is calculated.

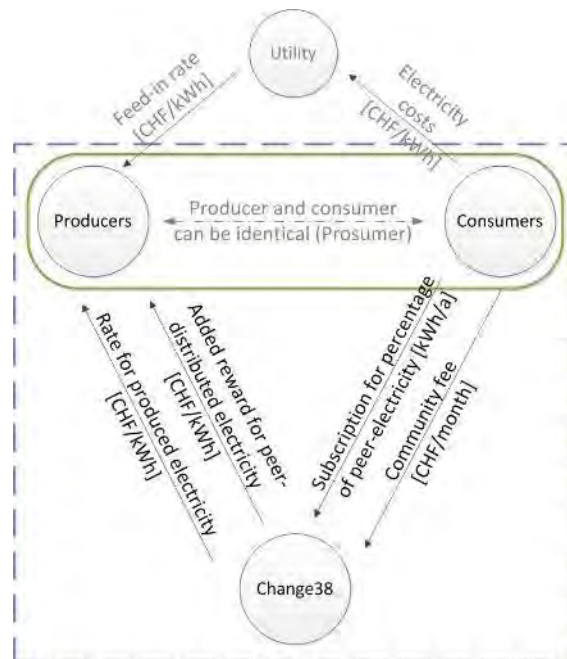

Figure 69: The actual business model of Change38. In the previous model the consumer was charged for the consumption of non-peer-electricity. Now the consumer subscribes for a guaranteed amount of peer-electricity.

2. THE MODEL AND ITS LATEST MODIFICATIONS

The system developed by Change38 can be separated into two aspects – namely the economic and the physical. Economically three kinds of participants are interacting: Change38, producers and consumers. For the producers and Change38 this venture should be profitable and consumers must get some added value to a reasonable price. Physically only two types of participants interact: the producer and the consumer. Among others their constellation, their technical equipment and their behaviour determine how their cluster performs, e.g. in regard to self-consumption, self-sufficiency (autarchy), or the production-to-consumption ratio.

Business Model: Figure 1 shows the business model in principle. Unchanged are the incentives given to participating producers. They will get two rates for their production: A base rate for each kilowatt-hour produced and a bonus rate for each produced kilowatt-hour that is consumed by peers. However the relation to consumers has been changed. In the previous model a consumer was charged for each kilowatt-hour he did not receive from

the pool and thereby giving him an incentive to a behavioural change. In the actual model a consumer now subscribes for a guaranteed percentage of delivered peer-electricity per year. This change was considered **necessary due to higher consumer's acceptance and acceptable due to the assessment that this costumer's** incentive would have only shown a small impact. As a consequence Change38 must manage cluster configurations to a certain degree.

Clustering and Pooling: Figure 2 shows the evolvement in the clustering process. In the previous system's set-up participants are clustered as outlined in 2A) and plainly taken together. The actual approach as shown in Figure 2B) is more centred on the consumer's view, which is now perceived as a costumer. The consumer can now not only decide whether or not he will join a cluster, but he can choose to a certain extend what producer shall provide him with electricity. This additional service for the consumer comes on the cost of simplicity. Consumers now see different constellations than producers do. The possibility of aggregation is therefore much lower compared to the previous model. In addition, it becomes necessary to draw a distinction between pools, which are the sum of all producers a consumer has booked (As shown in Figure 2B)) and clusters, which are now the aggregation of all consumers that a specific producer provides to.

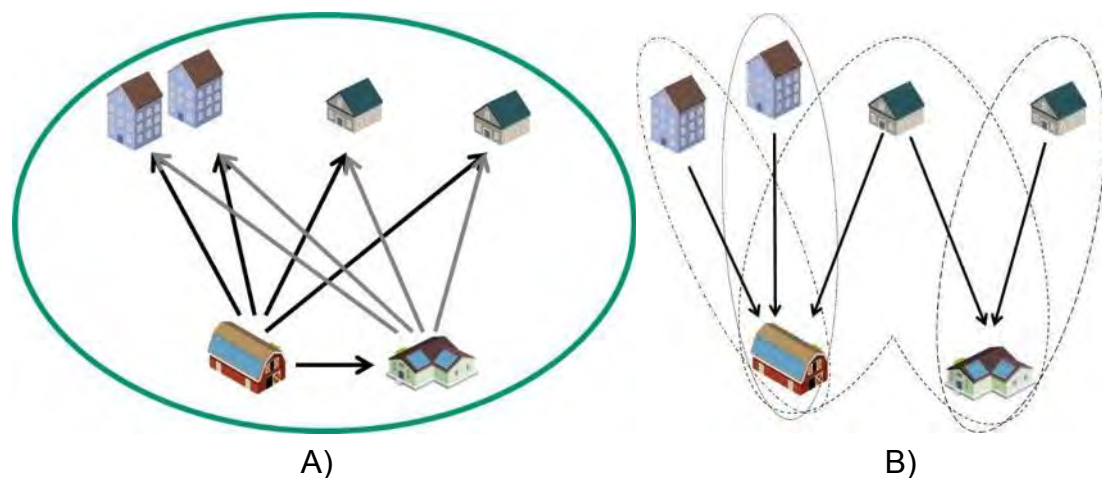

Figure 70: Clustering and pooling mechanisms. A) The clustering mechanism as it has been used in the previous model. Consumers and producers were aggregated in local clusters for matching their production and demand. B) In the latest mechanism the consumer books different producers and thereby creates his individual pool (Consumer's view), which in turn leads to clusters of one producer with his inscribed consumers.

Distribution: Matching production and demand and establish a mechanism for the distribution of the electricity is at the core of the model and did also change slightly. Previously producers have been granted a privileged allocation based on their seniority. The main idea was to reward early adaptors and risk-takers and give incentives to the latecomers to concentrate on the mismatching in a cluster. This funded on the precondition that a cluster contains several producers that must share the peer-electricity. Due to the more sophisticated clustering and pooling approach this concept was rendered unsubstantial, such that production and demand is now distributed evenly within a cluster.

Introducing options based on a more costumer centric view refined the model without abandoning its basic mechanics, which is in particular the cluster. While previously a cluster would normally contain more than one producer, a cluster will now be rendered by one producer alone. However, a cluster will still be assessed based on the same principles and performance indicators, which are:

- The percentage of self-consumption, i.e. what share of peer-electricity is consumed in the cluster.
- The percentage of self-sufficiency or autarchy, i.e. what share of the totally consumed electricity is covered by peer-electricity.
- The ratio of production to consumption.

These indicators were already used successfully to characterize and assess clusters that were simulated based on a Monte-Carlo approach (Schluck et al., 2016).

3. LIVE DATA FROM THE PILOT REGION

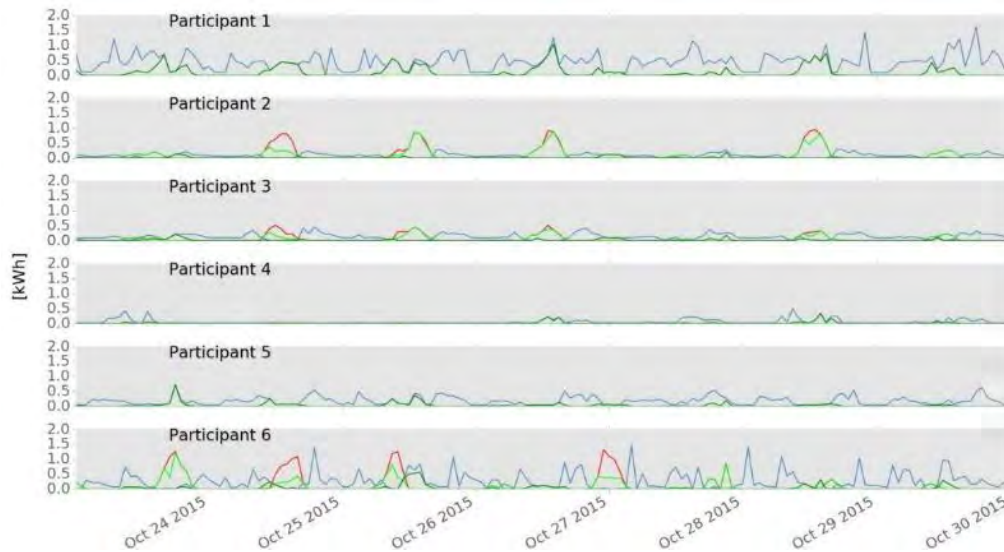

Figure 3: A week clipped from the live data set gathered in Gachnang. participant 1, 4 and 5 are pure consumers while 2, 3 and 6 are prosumers. In red each prosumers production is given, in steel-blue each participants consumption. A prosumer's production distributed among its peers is shown separately and coloured in lime, while consumption that is covered by peer-electricity is depicted by a green line.

Figure 3 shows the consumption and production of the participants during a week. The production that is consumed by the peers of a prosumer and the consumption that is covered by peer-electricity is separately shown. The constituents of this pilot project were three prosumers and three consumers in the village Gachnang. All production came from photovoltaic plants. The goals of this small pilot were to develop and test the necessary infrastructure, run a proof-of-concept for the clustering approach and determine some performance indicators of the cluster. The economics however have not been implemented at this stage.

So far the hard- and software has been developed and the clustering of the participants rendered successfully. To characterize the cluster based on the collected data the before mentioned performance indicators were evaluated. Although the underlying data set was carefully processed and aligned some data was missing due to the failure of some premature monitoring devices. Therefore the indicators were established for the entire time frame of one year and a single, but complete week. The results are shown in Table 1, which gives all indicators for the pilot region and from the latest Monte-Carlo simulations in comparison.

			Simulations		
			Self-cons	Self-suff	Prod-cons-ratio
Live data whole year	Self-cons	40.4	-	24.5±2	60±2
	Self-suff	14.1	76.5±2	-	18±2
	Prod-cons-ratio	34.9	57.5±2	19.5±2	-
Live data one week	Self-cons	72.0	-	15±2	21±2
	Self-suff	16.8	69.5±2	-	25±2
	Prod-cons-ratio	24.2	68.5±2	16.5±2	-

Table 1: Performance indicators for the cluster of the pilot project in comparison to the computed indicators evaluated using Monte-Carlo simulations (Schluck et al., 2016). For better comparison (based on the production-consumption-ratio) the indicators of the live data and the corresponding indicators from the simulations are highlighted. (self-cons: self-consumption, self-suff: self-sufficiency, prod-cons-ratio: ratio of production to consumption: values in [%])

3.1 Comparison and implications

In (Schluck et al., 2016) cluster constellations were simulated based on the assumption that all production was covered by photovoltaic plants. For these cluster types a hyperbolic relation between the production-to-

consumption-ratio and the self-consumption (correlation of -0.84) was found, as well as between the production-to-consumption-ratio and the self-sufficiency (correlation of 0.87).

Comparing the indicator values found in Gachnang with the by simulation evaluated indicators a general correspondence can be determined. All indicators lie within the same order of magnitude although. The indicators for the clipped data of one week can be arguably considered coherent with the computed indicators while the indicators of the whole year falls back in comparison.

As mentioned before the pilot was also conducted to test and develop the infrastructure in a sandbox like environment, such that a failure in data acquirement did occur frequently. This has certainly introduced a bias that led to the observed incoherence.

4. ANALYSIS OF CURRENT STATUS AND PROPOSED IMPROVEMENTS

Over the course of the last months Change38 refined and sharpened its model and introduced some further options for consumers. As a consequence, most consumers will become members of several clusters due to their booking (compare to Figure 2B)). This raises the issue of how to handle the distribution of energy between clusters. The simplest, but not most efficient, approach is the distribution by a previously defined, fixed rate. Other solutions make use of more sophisticated algorithms, but have not been developed yet.

A further question also associated with this issue is how many consumers effectively can be connected to a producer as this was identified to be an essential factor. The production-to-consumption-ratio is the corresponding performance indicator and was shown to be highly related to the profitability of Change38. Although this correlation **was explored on the previous and less sophisticated model this should still hold true as the liable system's** mechanics are still in place. The production-to-consumption-ratio is thus an important operative indicator. It is of special significance that it is highly correlated to the self-consumption and self-sufficiency, which are important **indicators for a cluster's efficiency, independence and ecological footprint. These interrelations give an impression of the business model's systemic character.**

The hitherto collected and analysed data supports these findings and backs up the latest simulations and thus the underlying modeling framework.

5. CONCLUSION

This work presents the latest developments of Change38 – a start-up that created a platform and business model for locally matching and distributing electricity. Here, the latest modifications of the business model are featured and their implications discussed. Furthermore, live-data from the cluster of the pilot project in Gachnang is **presented, which is running since mid of 2015. To characterize the pilot's cluster the performance indicators “self-consumption”, “self-sufficiency” and “production-to-consumption-ratio” have been calculated and drawn in** comparison to the findings of a previous work. In this work clusters were simulated at random in a Monte-Carlo approach and characterized by the same indicators. The comparison of the indicators of the computed clusters with the indicators of the pilot supports the simulation approach and underlying modelling framework.

Next steps will be the further exploration of the latest business model by means of simulation and further in-depth analysis of existing and additional data.

ACKNOWLEDGMENTS

We would like to thank the Swiss Commission for Technology and Innovation (CTI) that partially funded this work within the research framework of the SCCER FEEB&D. Our gratitude also goes to Change38 for the inspiring and thriving cooperation.

REFERENCES

- [1] Bühler, R. (2016), 'Change38'. <https://change38.ch/>
- [2] Energie (2015), 'Energierstrategie 2050 des Bundes'. <http://www.bfe.admin.ch/themen/00526/00527/index.html?lang=de>

- [3] Bundesamt für Energie (2016), 'Was ist die Energiestrategie 2050?'. <http://www.bfe.admin.ch/energiestrategie2050/06445/index.html?lang=de#>
- [4] Facchinetti, E., Eid, C., Bollinger, A. & Sulzer, S. (2016), 'Business Model Innovation for Local Energy Management: A Perspective from Swiss Utilities', *Frontiers in Energy Research* 4, pp. 31.
- [5] Facchinetti, E. and Sulzer, S. (2016), 'General business model patterns for local energy management concepts', *Frontiers in Energy Research* 4, pp. 7.
- [6] Farhangi, H. (2010), 'The path of the Smart grid', *IEEE Power and Energy Magazine* 8(1), 18–28.
- [7] Lasi, H., Fettke, P., Kemper, H.-G., Feld, T. and Hoffmann, M. (2014), 'Industry 4.0', *Business & Information Systems Engineering* 6(4), pp. 239 – 242.
- [8] Orsini, L. (2016), 'Brooklyn Microgrid'. <http://brooklynmicrogrid.com/>
- [9] Palensky, P. and Dietrich, D. (2011), 'Demand side management: Demand Response, Intelligent Energy Systems, and Smart Loads', *IEEE Transactions on Industrial Informatics* 7(3), pp. 381–388.
- [10] Piot, M. (2014), *Energiestrategie 2050 der Schweiz*, in '13. Symp. Energieinnovation', pp. 28.
- [11] Schluck, T., Bühler, T., Sulzer, S. and Sulzer, M. (2016), Matching Renewable Energy Production and Consumption by Market Regulated Demand Site Management (DMS), paper presented at Sustainable Built Regional Conference Zürich, Zürich, 13.-17. June
- [12] Swan, M. (2015), *Blockchain: Blueprint for a New Economy*, O'Reilly Media, New York.
- [13] Tanaka, N. (2011), 'Harnessing Variable Renewables: A Guide to the Balancing Challenge', Int. Energy Agency, Technol. Rep.

Session 7.1: Education and Training for Transforming SBE

Private Public Partnership Energy Efficiency Assessment Program at Hong Kong Aircraft Engineering Company, Xiamen facility, China

Samuel KWONG^a, Matthew TANG^b

^a John Swire & Sons HK Ltd, Hong Kong SAR, samuelkwong@jsshk.com

^b Hong Kong Aircraft Engineering Company, matthewt@haeco.com

ABSTRACT

Hong Kong Aircraft Engineering Company (HAECO) invited a group of students from Tsinghua University Beijing to conduct an energy assessment of one of its facilities in Xiamen in July 2015. The study was done on two of the 6 maintenance hangars and has identified a total of RMB 2M per year of savings with zero to low capital expenditure investment. This amounts to approximately 10% of the annual electricity consumption of the whole facility. Most of the findings can be applied to the other hangars resulting in a higher potential savings. There are also further savings if improvements with longer payback are taken into account for example replacing air-cooled chiller system with water-cooled model. Some of the key sources of inefficiency identified are: oversized design and improper operating control; improper design & installation usually resulting in pressure drop; blockage and malfunction especially on piping and valves; and mismatch of supply and demand. The study team comprised of undergraduates and research students and was led by two professors.

The study is a part of the summer programme for Tsinghua University. It allows students of building services and facility management studies to apply and compare what they have learnt in studies to real situations and at the same time identifying energy saving opportunities for the host company. During the exercise, new topics for further researching and investigation may also be generated for the university. Further to the success of this study, the holding company of HAECO, Swire Pacific, has reinforced the partnership with Tsinghua University by offering up to RMB 4M per annum for 2015-2018 in funding for building energy efficiency and sustainability researches for the private sector. Subsequently, several energy efficiency studies have been conducted. The possibility of applying the learning from the initial study model is being explored in other business operations and new development under the company.

Keywords: energy efficiency, private public partnership, energy assessment

1. PRIVATE PUBLIC PARTNERSHIP

The partnership was between HAECO Xiamen and Tsinghua University. Students from the Faculty of Architecture Building Environment and Services, Building Energy Research Centre (BERC) were invited to carry out an energy assessment at the aircraft maintenance facilities in HAECO Xiamen during July and August 2015. The main objectives are to identify the energy management opportunities at HAECO Xiamen and to provide training ground for students to practise their studies in real situations. The Tsinghua team was led by two professors and comprised of three research students and six undergraduates.

Tsinghua has been providing the energy assessment summer projects to private and public sectors since 1995. It has been widely welcomed by students, the university and hosting organisations. This was the first time that such project was carried out on an industry facility focusing on aircraft engineering.

1.1 HAECO Xiamen

HAECO, established in Hong Kong in 1950, is one of the world's leading independent aircraft engineering and maintenance groups. It is one of the largest maintenance, repair and overhaul service providers in terms of capacity. HAECO offers a full spectrum of services including airframe services, line services, component services, engine services, inventory technical management, fleet technical management, cabin solutions, private jet solutions, freighter conversion, parts manufacturing and technical training through its 19 subsidiaries and joint venture companies around the world.

HAECO Xiamen is one of the subsidiaries of HAECO located at the Xiamen Gaoqi International Airport. With six double-bay maintenance hangars capable of accommodating ten fully docked wide-bodied aircraft, HAECO **Xiamen is one of the world's largest airframe maintenance facilities. Supporting its overhaul services are a wide range of in-house backshops and fabrication facilities, as well as testing and calibration laboratories.**

1.2 Tsinghua University Building Energy Efficiency Research Centre

Tsinghua University has 14 schools and 56 departments with faculties in science, engineering, humanities, law, medicine, history, philosophy, economics, management, education and art. The University has now over 25,900 **students, including 13,100 undergraduates and 12,800 graduate students. As one of China's most renowned universities, Tsinghua has become an important institution for fostering talent and scientific research.**

Tsinghua University's BEREC is a leader in the field of building energy conservation in China, and has a responsibility to promote energy saving and emission reduction in the architecture field. BEREC's main work includes: national conditions and development strategy research of building energy conservation; building energy efficiency technology research; policy, regulation and standards making; engineering consultancy for major projects; propagandizing and popularizing the research achievements, and cultivation of professional talents, etc.

2. ENERGY ASSESSMENT FINDINGS

2.1 Energy consumption analysis

HAECO Xiamen has six maintenance hangars in which the majority of operations are conducted and energy is consumed. The hangars comprise of two main components: bay area and annex building. Both have separate air conditioning system, lighting and electricity supply.

The average annual energy consumption of HAECO Xiamen was 20M kWh between 2012 and 2014, of which approximately 66% was used in the annex buildings and 34% was used in the bay areas. Energy used in air conditioning comprised 38% of the total energy consumption (10% for bay area; 28% for annex building) and 23% for lighting (13% for bay area and 10% for annex building).

Based on the total energy consumptions and energy intensities of the hangars, Hanger 3 and Hanger 6 were selected for detailed assessments because of the high consumption and potential for improvement.

2.2 Air conditioning— bay area

Air conditioning in the bay area is provided by chilled air delivered to the aircraft and work areas by flexible tubes. Chilled air is generated by fixed central air conditioning units and mobile air conditioning vehicles. The measured coefficients of performance (COP) of the fixed and mobile units were 2.9-3.2 and 5.3, respectively. The monitoring results showed that only 30-40% of chilled air was effectively delivered. Much was wasted during delivery due to pipe leakage and uncontrolled outlets. The efficiency of chilled air delivery fan units was low and the delivery power was larger than demand resulting in localised temperature discomfort.

The suggested improvements include increasing the proportion of mobile air conditioning supply because of the higher COP, retrofitting the fan units with variable speed model or several small fans, strengthening wind tube valve control and switching off chiller units when not in use. The suggested control measures are expected to save 1.08 million kWh of electricity per year with zero to very low capital investment cost.



Figure 2.2a: Chilled air supply at Bay area



Figure 2.2b: Mobile air conditioning vehicle

2.3 Air conditioning – Annex building

Air conditioning is provided by water cooled system to the Annex Buildings being studied (i.e. Hanger 3 and Hanger 6). Each has four chilling units and two sets of five cooling water and chilling water pumps. At the time of the measurement, two chilling units were running at COPs of 3.58 and 4.54, significantly lower than the designed COP rating of 5.45. The efficiencies of four of the running pumps were measured. They were all running at lower efficiencies (46-60%) than the designed one at 79%. This suggests that both the chilling units and the pumps are oversized and not properly operated.

The water pressure along the cooling water system was measured. A significant pressure drop of approximately 25m was found at one section of the pipeline located on the roof top, suggesting a potential air stuck in the pipeline and the condenser, resulting in high energy consumption and low heat transfer capacity.

At the time of the measurement, only three of a set of four connected cooling towers was running. The switched off tower created an air flow shortcut wasting 25% of the total air flow through the towers.

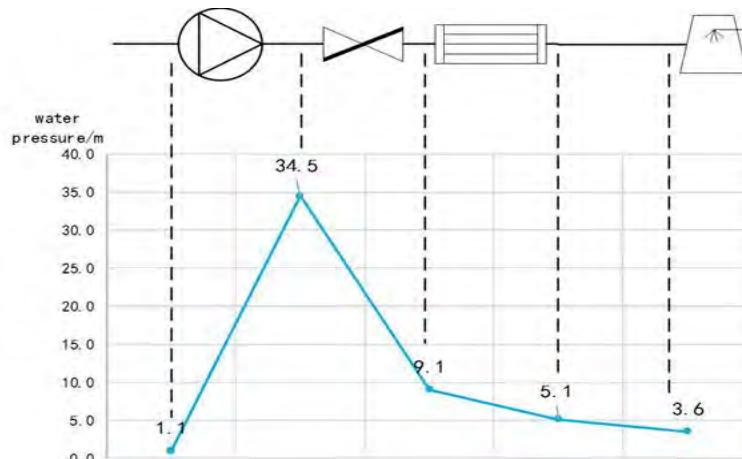

Figure 2.3a: Cooling water pressure measurement

Some preliminary improvements were made onsite including: shutting down one set of chiller and pump unit to increase the loading capacity to 90%; installing vent valves at local high points and allowing air trapped inside the system to be released; and switching all fan units in the cooling towers on. Both system COP and the energy efficiency have improved significantly after the improvements. It is estimated that approximately 154,000 kWh of electricity per year can be saved (27% increase in energy efficiency).

Further improvements could be made by installing variable speed drives at the cooling towers, lowering the chilled water set point (e.g. to 7°C), and changing the oversized pumps with the appropriate capacities. With these additional improvements, it is estimated that the energy efficiency of the system could be improved by approximately 34%, saving 200,000 kWh of electricity per year.



Figure 2.3b: Vent valves installed

	Before Improvement	After Improvement
Chiller COP	4.11	4.82
Cooling Water Efficiency	54%	72%
Chilled Water Efficiency	51%	57%
WTF Load	20.0	35.5
WTF Source	19.1	29.6
Total Power (kW)	338.7	246.9
Energy Efficiency Ratio	2.76	3.37

Table 2.3: Performance before and after improvements

2.4 Lighting

Lighting amounts to 23% of the overall energy consumption of HAECO Xiamen, of which 75% (i.e. 1.3M kWh/year) is for high bay and 25% for general use. Lighting intensity at the bay area was found to be in compliance with the China Civil Aviation Standard MH3145.86-2001 of 500 Lux at daytime when the door of the bay was opened. Some areas would require illumination when the door was closed. It is therefore suggested that natural lighting be improved and sensors be installed for the highbay lighting at the bay areas. The saving from this improvement is estimated to be approximately 816,000 kWh/year.

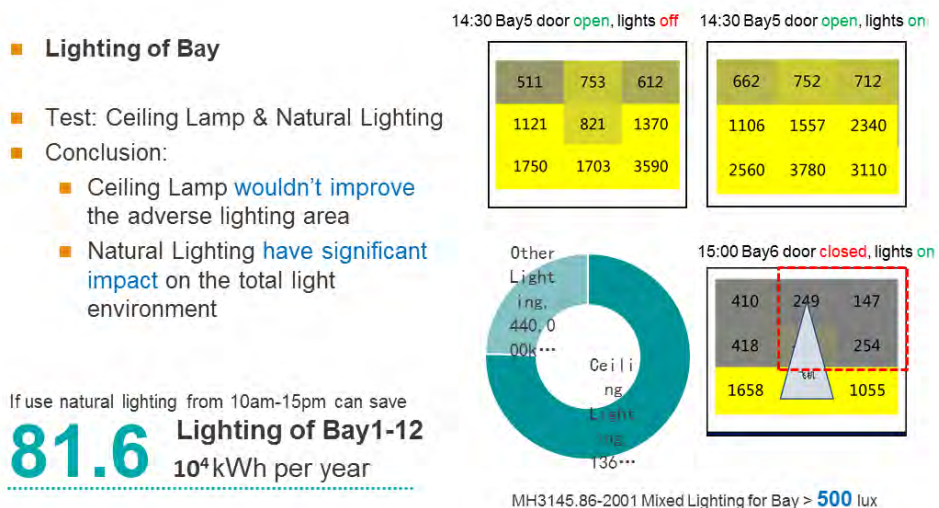

Figure 2.4: Lighting intensity measurement at bay area

2.5 Ventilation - Central warehouse

The central warehouse uses 200,000 kWh of electricity per month i.e. 12% of the total consumption of the HAECO Xiamen, of which the majority (~76%) is from air conditioning. Occupancy by the operators and warehouse staff is concentrated but fresh air is provided to the whole space via the central air conditioning system with ventilation

at the ceiling of the warehouse approximately 10m aboveground. Installing specific air conditioning for the office areas, adjusting the fresh air return and switching off the highbay lights when not in use could result in an estimated saving of 280,000 kWh/year with nominal to zero investment cost.



Figure 2.5: Central Warehouse Layout

3. NEXT STEP FORWARD

The partnership provided an opportunity for students to apply what they have learnt in real situations and for the University to identify new topics for further researching and investigation. The host company was benefited from the technical advices from Tsinghua and getting access to the latest technologies and management approaches on energy efficiency.

Further to the success of this pilot, the holding company of HAECO, Swire Pacific, has reinforced the partnership with Tsinghua University by offering up to RMB 4M per annum for 2015-2018 in funding for building energy efficiency and sustainability researches for the private sector. Subsequently, several energy efficiency studies have been conducted. The possibility of applying the learning from the initial study model is being explored in other business operations and new developments under the company.

REFERENCES

- [1] 60+ years of excellence aircraft services. Retrieved from: <http://www.haeco.com> (Retrieved on 1 September 2016)
- [2] General Information Above Tsinghua. Retrieved from: <http://www.tsinghua.edu.cn> (Retrieved on 1 September 2016)

Leveraging the Power of Story to Achieve Greater Sustainability

James Scott BREW^a

^a Nikken Sekkei, Japan, brew.james@nikken.jp

ABSTRACT

If you google “storytelling for business” you will quickly learn that this is not a fad. And Chief Storyteller is not just a creative title for cool companies. Storytelling has always inspired humans to think differently, act on change or just make more informed decisions. This paper will focus on how and why storytelling works — using research from psychology and brain science, introduce story types and structures, and conclude with a true story from a large scale project for a major multi-national corporation.

Scientists, academia, and even research journals are only now discovering the power of storytelling in getting their message to be not only better understood, but also remembered. We have learned more about the human brain in the past 10-15 years than in all of human history before. Using sophisticated brain wave and brain chemical reactions, we are now able to measure the impact and memory triggers of a carefully structured story as compared to the same information, presented as mere data or facts.

To maximize impact, it is important to understand story structure and story types as well as how to develop story **and logic models. This “process” helps frame a compelling story into one that will be understood and remembered.**

Keywords: education and training, green economics, storytelling

1. INTRODUCTION

Too often, on climate change and sustainability fronts, we are challenged in making convincing arguments for greater investment or why needed change is urgent. There is a tool that we use every day, and it is more powerful than a life cycle cost assessment or a simple payback calculation — it is called storytelling. Storytelling can also be thought of as presentation. And great presentations, with or without PowerPoint, are commonly designed and presented in the form of a story.

While we all tell stories quite often — daily for most people, the way in which we tell them can be very effective or not effective at all. The more we understand about story purpose, story types, story structure, and story logic — the better our storytelling becomes.

Storytelling usually requires an audience — a listener or listeners. And while story listening is also an important skill, knowing your audience is the first step to effective storytelling. The more you know about them, the more likely your story will be structured and framed to resonate with them.

Before you embark on writing or telling a story, it is also good advice to understand your story’s purpose. What is it you want from your audience? A decision? Are you trying to inform them of something they need to know? Perhaps you are hoping to persuade them to believe something they might not believe at the beginning of your talk. In any case, it is a good idea to know what it is you want from your audience before you write or tell an important story.

2. WHY STORIES WORK

There are many scientific and psychological reasons that stories work for humans. But the most basic of these reasons is primal. We are hard-wired for story — in fact, storytelling is how we survived as a species. An example often used is this:

Imagine you are a caveman or woman — living in a subtropical climate, ten thousand years ago. And one day as dusk approaches, you watch as three of your fellow cavemen walk away from the cave into the distance to hunt for food. Later, only one of your friends returns. What happened, you wonder. When your surviving friend tells everyone how a large toothed cat hunted them and how it killed their two friends as they tried to fight it off, you

listen very intently--**because you don't want to die like that. It's that simple. And the same was true for injury, disease, or death from water, fire, weather, shelter, and so on.**

2.1 Story types and structure

There are a variety of story types in the world. Most of us have heard of at least some of them: comedy, tragedy, **the hero's journey, and so on.** We are not limited in the types of stories we might tell in our professional work, it is **very situation dependent.** **The hero's journey is used in over half of all Hollywood movies and nearly all of the most watched TED talks.**

In the sustainability world, we may often be telling vision stories (of a future where we overcame climate change) **or a values or teaching or learning story, where there is a lesson such as if we do 'this', then 'that' will happen.** Another story type that might apply to fighting climate change is battling and beating the monster or dragon. Becoming familiar with some of these types is useful in understanding and becoming a better storyteller.

Story structure is generally quite straight forward. While there are variations and simplifications, most stories follow a fairly common structure, as shown in Figure 1.

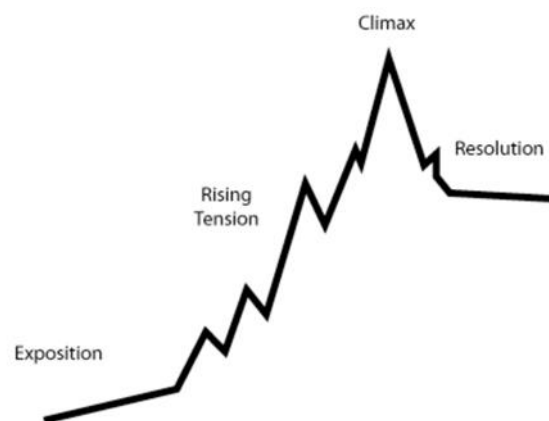

Figure 1: Story structure

The exposition can be thought of as the context or “where are we?” as the story begins. Rising tension is the presence of a problem or challenge that the character(s) must overcome. Research has shown that this rising tension is critical to maintaining an audience’s attention and gaining their empathy. The climax can also be thought of as the turning point. Finally, the resolution is the conclusion. It is very often preceded by tension in the form of a small setback or potential failure.

A much simpler way to think of story structure is in three basic parts. 1. A Trigger: The problem or challenge to be overcome; 2. Transformation: The turning point or climax; and 3. Life Lesson: What the character or listener has learned from the experience or story.

Storytelling is not just for oral delivery. This structure or logic flow of narrative can be used for business communications, marketing and even dropped into reports to help reinforce more complicated information.

2.2 Story Science

Many sustainability and business professionals understand the compelling nature of stories. Recent scientific research is able to more clearly identify how stories can change our attitudes, beliefs and behaviours.

Humans rely on other humans for survival and happiness. When we show kindness to others — even basic **kindness to strangers, the neurochemical oxytocin is produced. Oxytocin is like the body’s natural “empathy drug”.** Empathy is important for humans so that we can predict how we might react to similar situations and for getting along with others — for example co-workers or customers.

Stories with character-driven content and emotional content not only build empathy and attention — they are also remembered longer than those without it. Sometimes our presentation or speech is about something emotionless like a technology or piece of mechanical equipment. In these cases, the author uses the opening of the presentation as an opportunity **to tell a “related” story (no matter how distant) that perhaps brings home a simple point like making the right decision or right-timing or lost opportunity.**

The human brain is designed to recognize patterns. This is useful so that we can predict what might happen next. But it is not just visual patterns, like the face of someone you met before, but also oral patterns. And this is one of the reasons the brain loves stories — we recognized them. Narrative structure is the most elegant form that has been honed over thousands of years to help us learn, remember and change.

There are two main areas of our brain that light up when we are presented with information or data—**Wernicke’s and Broca’s [see Figure 2]. These two areas process language and speech. And given that many sustainability professionals speak using technical terms, acronyms, and engineering language — the brain can easily be overwhelmed.**

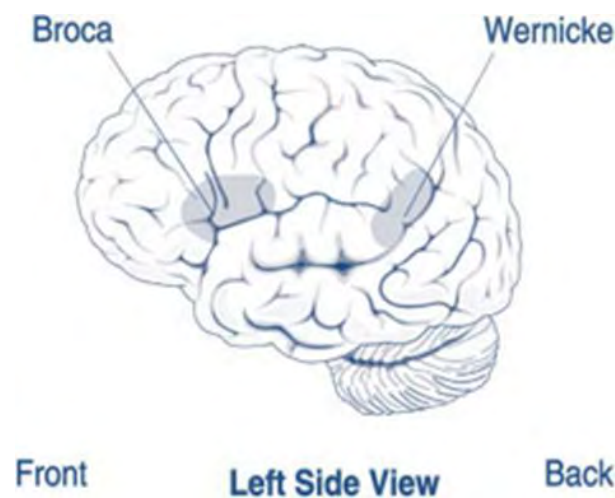

Figure 2: Wernicke’s and Broca’s brain areas

When we are presented with a narrative that includes sensory descriptions — **even if it’s about the information or data, multiple brain regions are activated. Here’s a very simplified example:**

Informational: The office air conditioning system uses radiant cooling panels with small fans delivering air flow at the rate of 0.2 to 0.3 m/s.

Narrative: The office cooling system is designed to give you the same feeling you get when you enjoy a slight breeze while sitting beneath the shade of a tree on a hot day.

We are a sceptical species. When we are presented information in the form of statistics, percentages and facts, we switch to an analytical mode and immediately question or even doubt the data we are hearing. Research by Jennifer Edson Escales, Marketing Researcher at Vanderbilt University, found that a test audience had more positive reactions to advertisements that were told as narratives than those which simply used facts and arguments. Compelling facts are best delivered in story form with sensory or human elements that bring them to life.

Other research has demonstrated how, when someone tells you an engaging story of something that happened to them, the very same chemicals are triggered in your brain as were triggered in the storytellers brain, when it **happened to them. This is further evidence to support why story’s capture our hearts and quite literally, our minds.**

3. A TRUE STORY

The following story is a real example of leveraging story to achieve greater sustainability — but it starts with better listening. It ends with a powerful framing of the opportunity, which essentially set the project up for success when it appeared to be doomed. See if you can recognize all of the elements of story structure as you read it.

3.1 Is sustainability expensive?

About 6 years ago, the non-profit sustainability consulting firm I worked for, was retained by a global mining corporation in Australia to help them design 500 new, super-efficient homes for their workers--essentially a new small town.

At the time, their existing town housing was using about seven times more energy per square meter than a typical Australian home. They were also experiencing problems with mold in some of their housing units. As we embarked on the research and design solutions for climate responsive, super-efficient housing, it seemed quite apparent that this project was, to put it simply, a low-energy housing design exercise similar to those we had done before, except this one was at a larger scale. Or so we thought.

A few days into our work on the ground in Australia, we attended a mining workshop mostly just to understand the mining business and to meet some of the senior managers. It was on the first day of that two-day workshop that we learned that an entire town's energy use--even at the very high current levels, was but a mere fraction of the mining operations energy use and therefore we suddenly realized that our sustainability efforts may not get senior management support. This is because every project has a budget and we were going to certainly be asking for increased investment in the housing (for things such as more and better insulation, double glazed windows, healthy building materials, etc.). We felt defeated that day.

One evening, my colleagues and I were at our client's home for a BBQ with some of the client team when the discussion turned to their company and some of the challenges their industry is facing. They mentioned the high turnover rate in the mining industry and how disconnected mining workers and their families feel living in the remote Australian regions. We also learned later that week about how worker fatigue contributes to safety failures (critical injuries--even death) costing the corporation millions (USD) annually.

By listening carefully to the real issues affecting the company, a story and logic model was developed around how healthy housing can contribute to reducing worker fatigue, improving safety, and how creating better community-focused neighborhood designs could contribute to improving worker retention, and how more efficient housing can reduce infrastructure, maintenance and peak energy loads that, in total, with relatively modest attribution rates, could potentially save the company nearly \$1B USD annually. We now had a powerful story that would resonate with senior management. And it had very little to do with energy, climate change or sustainability as the lead story.

4. CONCLUSION

Storytelling works. Science has proven this. In facing and overcoming the challenges we are dealing with around climate change and natural resource constraints, we need more storytellers. Great communicators understand that business is about emotion and emotion revealed in the form of story can inspire their customers and employees. We all have stories. And many of our stories can be used to support a more technical presentation or speech **where you might be asking for an important decision related to achieving greater sustainability. It's all in the telling.**

REFERENCES

- [1] Duarte, N., 2010. Resonate: Present Visual Stories that Transform Audiences. New Jersey, Hoboken.
- [2] Gallo, C., 2016. The Storytellers Secret: From TED Speakers to Business Legends, Why Some Ideas Catch on and Others Don't. New York.

Embedding Sustainability in Higher Education Course Content: An Industry and Education Perspective

Lloyd Martin SCOTT^a, Sushimita BHATTACHARJEE^b

^a Dublin Institute of Technology, Ireland, lloyd.scott@dit.ie

^b University of Oklahoma, United States of America, suchi@ou.edu

ABSTRACT

Large amount of environmental resources are utilized towards the construction, renovation, operation and maintenance of buildings. Though buildings enhance the standard of living, it accounts for a large portion of non-renewable energy depletion, greenhouse gas emissions, raw materials use, waste generation, and freshwater consumption. Sustainable design and construction practices can substantially reduce or eliminate negative environmental impacts through high-performance design, construction, and operations practices. With most of the top design and construction firms in the globe implementing sustainable design and construction practices, there is a huge responsibility on Architecture, Engineering and Construction (AEC) professionals to be knowledgeable in sustainable design and construction practices. Although many higher education institutions have begun to provide sustainability related courses, there is a lack of consensus on what constitute the body of knowledge on sustainability and knowledge expectations from the recent graduates when they join the workforce. The purpose of the research study is to identify the industry expectations of sustainability knowledge of recent graduates and how that is delivered through course curricula.

The research methods adopted for the study will be three folds, starting with an initial literature review on sustainability and how it is addressed by AEC as well as non-AEC course curricula, followed by a survey of AEC **industry professionals (listed in Engineering News Record's top 100 list) to identify the sustainability knowledge expected from recent graduates. Further, using content analysis, the AEC educators' interview data and the course descriptions** will be analyzed to identify how well the industry expectations are delivered through the course curriculum.

The findings of the study will provide important feedback for AEC educators to revise and evaluate their course curricula to address the important sustainability knowledge identified by the industry professionals.

Keywords: green construction technology, sustainable neighbourhood, design process

1. INTRODUCTION

There is a growing consensus that appropriate strategies and actions are needed to develop sustainable built environments and construction activity and the role and the role of education in this pursuit so the future leaders of the Architecture, Engineering and Construction (AEC) sector will need to be technically advanced, highly adaptable, collaborative, good communicators and lifelong learners (Scott, 2015). Progress toward sustainable built environment and construction activity must build on robust knowledge about the interaction between, and consequences of, the built environment and construction activity and the natural environment. This need is recognized, and "... environmental issues are now becoming a **critical edge in construction research**" (reference to be added)

Sustainability in the context of sustainable development is defined by the World Commission on Environment and Development (1987) as **'forms of progress that meet the needs of the present without compromising the ability of future generations to meet their needs'**. This broad definition emphasises the aspect of future orientation as a basic element of sustainability. This care for the future implies, among other things, a wise use of natural resources and **other aspects regarding the environmental footprint. The 'green' aspect of sustainability is recognised in many other definitions of sustainability.**

The International Institute for Sustainable Development (2010) elaborates on the generic definitions in a definition **more focused on sustainable management of organisations: 'Adopting business strategies and activities that meet the needs of the enterprise and its stakeholders today while protecting, sustaining and enhancing the human and**

natural resources that will be needed in the future.’ Important in this definition is the mentioning of the ‘needs of the enterprise and its stakeholders today’. Construction has been accused of causing environmental problems ranging from excessive consumption of global resources both in terms of construction and building operation to the pollution of the surrounding environment, and research on green building design and using building materials to minimize environmental impact is already underway.

The widespread acceptance of sustainability was initiated by the report published by the Brundtland Commission in 1987 titled “Our Common Future”. In that report, sustainable development was defined as “development that meets the needs of the current generation without undermining the ability of future generations to meet their own needs.” The report emphasized the importance of sustainable development at a level more than its intrinsic value to ensure there is enough resources to meet the requirement of the future generations. A plethora of attempts have been made to define sustainability since then emphasizing its importance. Today, sustainability is most popularly defined in terms of the three associated dimensions: social, economic, and environmental (Robert, Parris, & Leiserowitz, 2005; Tracey & Anne, 2008). This concept of the three dimensions of sustainability is embodied in the definition of sustainability adopted under United Nation’s “Agenda for Development” which states “Development is a multidimensional undertaking to achieve a higher quality of life for all people. Economic development, social development, and environmental protection are interdependent and mutually reinforcing components of sustainable development” (UN, 2007). The popular means of conceptualizing sustainability in terms of social, economic, and environmental dimensions originated from Elkington’s (1994) Triple Bottom Line concept. Opoku and Ahmed have advance the concept of sustainability, particularly in the context of AEC and offer the following definition “the adjustment of human behavior to address the needs of the present, without compromising the ability of future generations to meet their own needs” (2013:141). There are many researchers who advocate imminent actions to change the way in which young people become educated in matters about the environment (Cotgrove and Kokkarinen, 2013).

2. SUSTAINABILITY IN HIGHER EDUCATION

The concerns about sustainability indicate that the current way of producing, organising, consuming, living, etc. may have many negative effects on the future. In short, the current way of ‘doing things’ is not very sustainable. Therefore, some ‘matters’ have to change. Because of change in organisations, whether it is a new production plant, a new product, a new business process or a new resource, is in many cases organised as projects (Silvius and Batenburg 2009), it can be deduced that a (more) sustainable society requires projects. In fact, this connection between sustainability and projects was already established by the World Commission on Environment and Development (1987).

When discussing the implications of sustainability for AEC professionals, it is of eminent importance to have a clear understanding of the elements of sustainability outlined above. This may be a challenging exercise as the elements are conceptual, rather than practical (Moneva et al. 2006; Pope et al. 2004) is how and to what extent they are included in the education of the AEC professional. The concept of sustainability is understood intuitively, but is not easily expressed in concrete operational terms (Briassoulis 2001). The relationship between sustainability and its position in the AEC sector is still an emerging field of study.

Sustainable and environmental education in built environment needs to be provided to students to imbue them with the concepts of environmental stewardship, sustainable design and application. More importantly, it is their responsibility to ensure that their decisions and actions are taken in the interest of environmental preservation. The demands of various interested parties need to be met, including those of traders concerned with the design of a cost-effective and superior solution; consumers who need an easy, comfortable and safe solution; and the government, which requires economic, social and advanced technologies without a negative impact on the environment.

3. RESEARCH METHODOLOGY AND METHODS

The methodology applied was determined on the basis of relevance to the focus of this research enquiry but also on the basis of pragmatic positioning. This was the case as a different methodological stance would not have allowed the research to be completed within the constraints applicable. Creswell (2009) stated that research methodology is the systemic approach that a **research adopts to accomplish the research's aim and with that in mind an explorative interpretivist position has been adopted**. In relation to the purpose of the research: it is concluded that the theoretical argument developed for the enquiry has the potential, by using an explorative perspective, to reveal new insights and a better understanding of stakeholder perceptions and awareness of sustainability and whether there is some alignment of those positions.

3.1 Research aim and objectives

The aim of the study was to compare industry expectations about essential sustainability knowledge with **academics' perceptions of requisite knowledge about sustainability to work efficiently in the AEC industry**. The specific objectives were as follows:

- To determine the expectations of the AEC firms regarding essential knowledge on sustainability of recent graduates entering the workforce.
- To determine the perceptions of the academics in design and construction programs regarding the required sustainability knowledge necessary to work efficiently in the industry.
- **To compare the industry's expectations and the academics' perceptions.**

The objectives were achieved by conducting surveys among the design and construction firms as well as academics teaching on construction programs. The survey questionnaire for the construction firms was divided into three sub-sections to accomplish the main objectives, which included: (1) Capturing the background information of each firm; (2) Understanding the sustainability practices adopted by the firms and their perceptions; and (3) Examining the essential sustainability knowledge expected from recent graduates. Similarly, the survey questionnaire for the academics was divided into three sub-sections including: (1) Understanding the background of individual respondents; (2) Examining the importance of sustainability practices as perceived by the respondents; and (3) Examining the essential sustainability knowledge required to work efficiently in the industry as perceived by the respondent.

The overall research process of the study involved the following steps:

- Selecting sample firms working in the design and construction industry and academics teaching on AEC programs;
- Developing the survey instruments;
- Performing cognitive interviews for instrument validation;
- Distributing the survey questionnaire to selected samples;
- **Collecting data to examine the industry's expectations and academics' perceptions; and**
- Analyzing the collected data.

3.2 Survey instrument development

The individual survey questionnaires were composed of two types of questions: (1) Close-ended questions with ordered choices; and (2) Five point Likert-type scale questions. The survey instrument development process is summarized in figure 1 and described in this section.

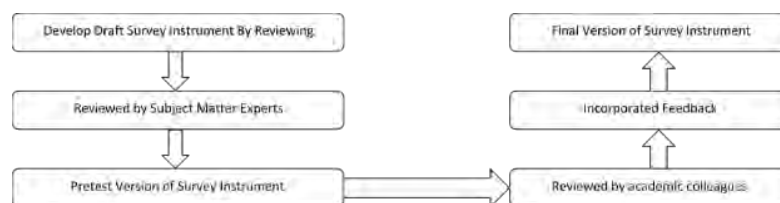

Figure 1: Survey instrument development process

4 DATA ANALYSIS

As mentioned previously, the survey questionnaires were divided into three sub-sections. The first section in the questionnaires was meant to understand the background of educational programs. The second section contained items to determine the perceptions about sustainable design practices. The third section contained items to determine the topics that were included in the sustainability courses in the education program.

Survey data were analyzed using Simple Relative Index (RI) and Spearman Rank Correlation Coefficient (SRCC) techniques to identify the level of importance and degree of association between the responses of the firms and the educators. An ordinal scale was used for the measurement of each survey item, each respondent being asked to assign a level of importance from 1 to 5, where 1 = most important and 5 = least important. From this, the magnitude of the RI for each item was calculated. All the numerical scores of each item on the questionnaire were transformed to relative indices to decide the rank orders. The RI was calculated using the following formula:

$$\frac{\sum w}{Wn}, (0 \leq RI \leq 1)$$

Equation 1

Where,

w = Weighing given to each item by the respondents ranging from minimum of 1 (denoting least important item) to a maximum of 5 (denoting most important item);

W = The maximum weighting (which was 5 in the study);

n = Total number of respondents.

This was followed by rank ordering of the items based on the RI, where the highest RI = highest rank and vice versa. For items with equal RI, they were ranked in accordance with the percentage of respondents assigning 5 to the item. The ranked variables gave insight as to the essential sustainability knowledge expected by the industry and sustainability knowledge provided to the students to work efficiently and effectively in the industry.

4.1 Background information on the program or institution of responding educators

All the respondents (N = 54) were educators of construction program. For accurate analysis only the perspective of the construction firms was used to compare the essential sustainability knowledge with the actual topics covered through sustainability courses. 67% of the total respondents were from US, followed by 13% from EU, 11% from the continent of Africa, 5 from Australia and 2 from Hong Kong and Turkey respectively. The number of students in the program of the responding educators were used to identify the size of the program. The number of students ranged from less than 50 students per program to greater than 400 students in a program. Though there was a fair distribution of program size among the respondents, yet the major respondent group with respect to program size was 100 – 200 and 200 – 300 students per program as shown in Figure 3 below. It has been noted that the average program sizes in EU and Australia are larger than in US.

Respondents indicated that sustainability is taught both as standalone course and integrated with other courses. Results indicate a wide variation in the number of courses where different topics related to sustainability are addressed. The distribution of the number of courses addressing sustainability among the different construction programs across the globe were captured. It has been noticed that programs in Australia and Ireland has more number of courses addressing sustainability than average program in US or UK. Further the results indicate that sustainability is being addressed at all levels during the course of the study. As shown in Figure 2 only 12.77% of the programs indicated that they have specific courses addressing sustainability in their graduate program. Maximum number of institutions indicated that sustainability is being addressed at the Year 3.

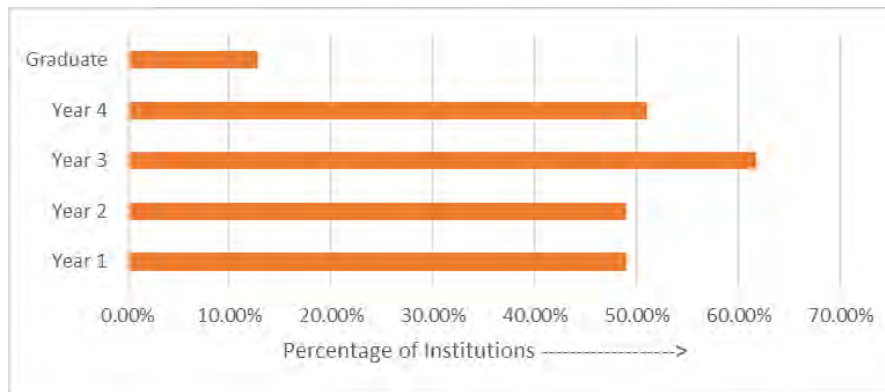

Figure 2: Total number of courses per institution addressing sustainability

4.2 Respondents perception about importance of sustainability knowledge

When asked about the importance of sustainable knowledge and practices for students, approximately 69% of the respondents indicated it to be important. This is very much in congruence with the response received from the design and construction firms, where 66.1% of the responding firms indicated that their firm has implemented sustainable design or construction practices in the past of which 2% of the firms have sustainable components integrated with all their design or construction projects (Figure 3). Further, 42.4% of the responding firms indicated that they either encourage or require their employees to attend trainings or workshops on sustainable design and construction practices.

When asked about the importance of knowledge about team building and goal setting for green building design and construction for professional success, approximately 70% of both group of respondents (industry practitioners and educators) indicated it as extremely or very important.

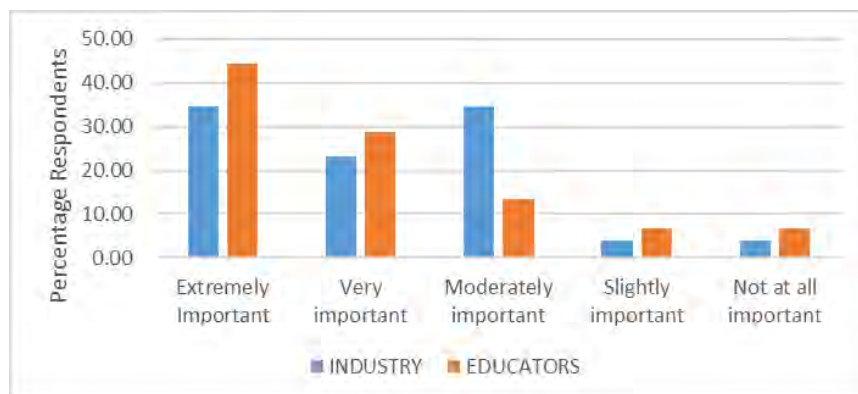

Figure 71: Comparison of industry perception versus educators about the importance of team building and goal setting knowledge for green building design and construction

In order to compare the industry expectations about essential sustainability knowledge with the actual topics covered in sustainability education, educators were asked to indicate the level of inclusion of nine specific topics related to sustainable design and construction as identified from literature. The educators' responses were compared with the responses of the industry practitioners.

Based on the two sets of response from the educators and industry practitioners, the RIs for each of the items were calculated followed by rank ordering of the survey items. A summary of the derived RIs and ranks for all the topics are given in Table 1. In the next step, SRCC test was performed on the pair of ranks. Negative correlation between the ranks of the various sustainability knowledge items was found amongst the educator and the industry practitioners ($r = -0.28$, $p > 0.05$ [two tailed], $df = 7$). In other words, there is absolutely no agreement between the expectation of the industry practitioners about the required sustainability knowledge to work efficiently in the industry and the actual topics covered as part of sustainability education. One such example was the topic of **'Biomimicry'** which is barely introduced to the students through sustainability courses, but the industry practitioners have listed that as a required knowledge for student success.

Essential Sustainability Knowledge	Industry Expectations		Actual Inclusion in Education		Diff. in Ranks
	RI	Rank	RI	Rank	
Biomimicry	0.569	1	0.934	9	8
Green building construction means and methods	0.624	2	0.568	4	1
Climate change	0.635	3	0.8	8	5
Green buildings products and materials	0.635	4*	0.55	3	1
Life cycle cost analysis of green buildings	0.647	5	0.645	5	0
Principles of green building construction	0.651	6	0.514	1	5
Green building rating systems	0.667	7	0.526	2	5
Building codes related to green technology	0.671	8	0.696	7	1
Green building design process	0.671	9*	0.65	6	3

* Equal RI; ranked in accordance with the percentage of respondents assigning 5 to the item

Spearman's Rank Correlation Coefficient, $r = -0.28$ $p > 0.05$ (two tailed), $df = 7$

Table 1: Summary of derived risk of essential sustainability knowledge

A summary of the derived RIs and ranks for all the rating systems are given in Table 2. Upon performing SRCC test on the pair of ranks, significant positive correlation was found amongst the responses of the educators and industry practitioners ($r = 0.73$, $p > 0.05$ [two tailed], $df = 7$). In other words, significant agreement was identified between the required knowledge of rating system as indicated by the industry practitioners and actual information about rating systems included in sustainability education. Similar to before the rating systems were rank order based on the importance as indicated by the industry practitioners and implemented in current sustainability education. LEED and BREEAM has been rated as by far the most important rating system adopted in US and UK respectively. This could be due to the significant importance given to the rating systems in the text books as well as in literature coming out of professional organizations.

Rating Systems	Industry Feedback		Actual Implementation in Education		Diff. in Ranks
	Freq.	Rank	Freq.	Rank	
LEED	70%	1	88%	1	0
BREEAM	31%	2	30%	3	1
Green Globes	2%	3	13%	4	1
Living Building Challenge	2%	3	10%	5	2
Energy Star	<1%	4	33%	2	2
NAHB Green Rating System	<1%	4	10%	5	1
CASBEE	<1%	4	2.5%	6	2

Spearman's Rank Correlation Coefficient, $r = 0.73$ $p > 0.05$ (two tailed), $df = 7$

Table 2: Comparison of knowledge requirement about rating system and assessment tools

5. CONCLUSION AND FUTURE RESEARCH

This study developed an understanding of the current status of sustainable design and construction knowledge perceptions and requirements among academics and industry practitioners. The study had access to a random pool of respondents and reflected on the perception of the broad diverse population sample of design and construction industry practitioner and academics around the globe. From the findings, it can be concluded that though there continues to be a gap between what academics and industry practitioners consider and reflect about their perception on the essential sustainability knowledge, yet there is significant agreement between them about the importance of the need to expose the future professionals and leaders of the AEC to the principles and knowledge areas with respect to sustainability.

There is a depth of agreement in the need for the graduate professionals to have a sound and well developed understanding of the current knowledge and best practices that are required within the AEC to embed sustainability as a matter of routine practice. The students perceive that they must embrace them and include sustainable approaches in the daily protocols of built environment processes. The industry practitioners believe and have confirmed that graduates need be fully equipped with the knowledge and competences of sustainable strategies so that their futures employers can be informed by and benefit from their knowledge. Langford (2008) refers to embracing and encouraging the new construction professional on graduation as, while they lack experience, they will bring the innovation and creativity that those who are more established will lack. Looking to this research the construction professionals survey indicated that sentiment and the importance of the AEC industry being open to the supporting those new recruits.

As the AEC industry strives forward in the modern technological world it is the current student AEC body that will be the leaders in the next 10 to 15 years and their current educators have a responsibility to challenge and equip them to take on this role. Being sustainable will be part of that as recognized by those who have researched in the area but also those who have had an input into this research enquiry. Their message is clear, create significant learning opportunities that embed the necessary competences, understanding, skills and knowledge of sustainability so that society will be enhanced and sustainable. The potential to explore further research in this important area are boundless and this research group propose to achieve a deeper understanding through more interpretive qualitative methods of the participants.

It is clear from analyses in the paper that there is still much to do to improve the embedding of sustainability focused AEC curricula for the undergraduate. Key to the success of this process is taking students [and academics] deliberately out of the institutionalized frameworks that bind them - frameworks that often, ironically, hinder innovation and success. To succeed in an inter-professional, intercultural collaboration requires improvisation, both in mind-set and in design technique, and requires a willingness to operate with uncertainty whilst embracing risk, and risking failure.

The study confirms that AEC enterprises have the opportunity to offer powerful jobs in the industry. However, there is a lack of connection in order to increase and fully impact on real development as there is little commitment to invest in the education of the AEC future professionals. There is a huge gap between education and industry in **terms of a commitment to investing in the future needs of the industry. There is as one respondent put it" a boom to bust attitude in the industry and so companies are reluctant to invest in education. This is one of the largest inhibitors to moving forward on the education front.**

Sustainability and knowledge of our evolving technological driven society, are key skills in a world of rapid change and unpredictable unknowns. The professional roles in the built environment sector are rapidly evolving, and new formats of processes and transactions developing at an unprecedented rate. Successfully navigating this environment requires graduates with essential inter - professional skills, effectively acquired through collaborative inter-disciplinary projects that embed the principles of sustainability. Going forward this study propose that sustainability be embedded in as many forms of collaborative professional education as possible.

REFERENCES

- [1] Briassoulis, H. (2001) Sustainable Development and its Indicators: Through a (Planner's) Glass Darkly in the Journal of Environmental Planning and Management Vol. 44 , Iss. 3,
- [2] Cotgrave, A.; Kokkarinen, N.(2013) Developing a model promoting sustainability literacy through construction curriculum design in Structural Survey Vol. 28 Iss: 4, pp.266 – 280.
- [3] Creswell, J. W. (2009). Editorial: Mapping the field of mixed methods research. Journal of Mixed Methods Research, 3(2), 95-108.
- [4] Elkington, J. (1994). Towards the sustainable corporation: Win-win-win business strategies for sustainable development California Management Review, 36(2), 90.
- [5] Langford D. and Hughes W. (eds) (2008), Building a Discipline; the story of construction management, ARCOM, ISBN-10: 0- 9552390-3-6
- [6] Moneva, J M; Archel, P; Correa, C. 2006. 'GRI and the camouflaging of corporate sustainability'. Accounting Forum 30: 121–137.
- [7] Opoku, A., & Ahmed, V. (2013). Understanding sustainability: a view from intra-organizational leadership within UK construction organizations. Int J Archit Eng Constr, 2(2), 133-143.
- [8] Pope, J; Annandale, D; Morris-Saunders, A. 2004. 'Conceptualizing sustainable assessment'. Environmental Impact Assessment Review 24: 595–616.
- [9] Robert, K. W., Parris, T. M., & Leiserowitz, A. A. (2005). What is sustainable development? Goals, indicators, values, and practice. Environment: science and policy for sustainable development, 47(3), 8-21.
- [10] Scott, L. (2015) The Changing Landscape of Construction Higher Education. International Journal of Construction Education And Research Vol. 11 , Iss. 2.
- [11] **Silvius, A J G; Batenburg, R. (2009) 'Future development of project management competences'. Paper presented at the 42nd Hawaii International Conference on Systems Science (HICSS), Waikoloa HI.**
- [12] Tracey, S., & Anne, B. (2008). OECD Insights Sustainable Development Linking Economy, Society, Environment: Linking Economy, Society, Environment: OECD Publishing.
- [13] World Commission on Environment and Development (1987) From One Earth to One World: An Overview. Oxford: Oxford University Press.

Importance of Built Heritage for World Sustainable Built Environment

Shahid Ahmad RAJPUT^a

^a COMSATS Institute of Information Technology (CIIT), Pakistan, sarajput@comsats.edu.pk

ABSTRACT

It is observed that our young generation of architects is solely dependent and inclined to take inspiration from shiny and tall buildings of the west to satisfy their quest in the field of architecture.

Some Professors including this author at the Department Architecture have been propagating over the years to seek inspiration from their own society and environment where there are plenty of examples of sustainable built architecture in form of Heritage. The plan of heritage buildings, selection of site, the design and the material used in respective heritage buildings has plenty to offer for ideas on sustainability of the built environment.

The main proposed of this paper is to highlight the features associated with the sustainable built architecture created by our ancestors, which is available in the neighbourhood to take inspiration from. This presentation will include slides of the project of heritage building made of locally available building materials and its impact on the sustainable built environment. It is hoped that my presentation will open new avenues for the young architects interested in the sustainable built environment.

Keywords: energy saving, heritage, sustainable neighbourhood

1. INTRODUCTION

For support of this belief and argument we have several examples of heritage buildings but this presentation will confine to one examples only.

The building chosen for this paper is a 16th Century Mughal Garden which is well known to the author from his early childhood and later in collaboration with the Dept. of Archaeology and Museums, Government of Pakistan he undertook a project for completing its architectural and hydraulic studies. The project was completed in two years 1993 and 1994. Based upon the discovery of its hydraulic system and first hand knowledge of the engineering involved in the construction of the building of this garden and developing the hydraulic system for running the fountains as well as water supply both hot and cold to the hammam (Turkish bath) two solid examples are worth quoting for the sustainable architecture found in this heritage building. We shall see all pictures and drawings in the presentation.

2. HISTORY

About two kilometres east of Hassan Abdal is a 16th century Mughal garden initially called Bagh-i-Hassan Abdal now popularly known as Wah Garden. Due to its historical and architectural importance, Wah Garden was acquired by the Government and was handed over to the Department of Pakistan Archaeology for its excavation, restorations and maintenance. (Figure 1)



Figure 1: Wah gardens as it stands today

This paper deals exclusively with the examples found during the excavation relating to the world's sustainable built environment. Wah Garden was not pre-planned; it evolved over a number of years, growing according to the instructions of the Emperor who used it at different occasions.

The excavations began in March 1993 with the initial purpose to study the architectural and hydraulic features of the gardens. A number of important discoveries were made, e.g. a large water tank on the eastern end of Wah Garden, three water channels running parallel with the length of the garden and fifteen fountains in the central water channel with water inlets situated in the upper terrace. There is also a Hammam attached to the southern wing of the *Baradari* (Pavilion). The excavation report was published in a monograph by the Smithsonian Institution **Washington DC in 1996. The main focus of this paper, however, is relating to the world's sustainable built environment that has never been published before.**

The area where the Garden is located was given the name "Hassan Abdal" after Hassan, a famous saint of Qandahar, as he is in Pakistan. Abda was his title. He died and was buried in Qandahar. It is written on his tombstone that Mirza Shah Rukh (1406-1447) met him in Qandahar with due respect in 1417 AD. The Saint died during the life of Mirza Shah Rukh, between 1417 and 1447.

Near Hassan Abdal, even before the time of Akbar, there was a pond in the middle of which Raja Man Singh built a small building (pavilion), as recorded by Jahangir in 1607 during his first visit to Hassan Abdal . In 1581, when Akbar laid the foundation stone of Attock Fort, he appointed Raja Man Singh to protect the frontiers. Raja Man Singh stayed in Hassan Abdal from 1581 to 1586, during which time he might have built that small building. Emperor Jahangir visited Hassan Abdal six times between 1607 and 1626. On his first visit in 1607 he stayed here for three days and busied himself catching fish.

Four years later an English traveller, William Finch, although he never went to Hassan Abdal, repeated this story and attributed the anecdote to Akbar .

Subsequent writers (the European travellers) confused the historic chronology, however, later in October of the same year, i.e. 1607, on his way back from Kabul, Jahangir stayed at Hassan Abdal to hunt. Jahangir took an interest in the development of Hassan Abdal. Thus he sent large amount of money for the construction of a building in Hassan Abdal .

The Shahjahani historians, visited Hassan Abdal with Shahjahan in April 1639, and recorded Hassan Abdal as the most beautiful and gratifying garden between Delhi and Kabul. According to these chroniclers Shahjahan visited Hassan Abdal nine times during his reign, between 1639 and 1652. During his third visit, on his way back from **Kabul in Oct.1646, the stay of Shahjahan in Hassan Abdal is recorded to have been in a garden called "Bagh-i-Bahisht "Ain" or Heavenly garden. Two years later, in 1649, when Kanboh came to Hassan Abdal with Shahjahan, he recorded Hassan Abdal as "Gulistan-i-Irum" or Paradise garden.**

Finally Aurangzeb Alamgir stayed here for one and a half years between July 6, 1674 and January 2, 1676. His historians refer to this place as Bagh-i-Hassan Abdal.

2.1 Origin of name

The name “Wah” does not occur in any of the historical references. How then did this garden of Hassan Abdal acquire the name of Wah Garden? There is a gap in the history of Hassan Abdal after Aurangzeb, till 1815 when Elphinstone came to Hassan Abdal as a traveller and recorded his observations and the name of the garden as Hassan Abdal .

Then another English traveller, Moorcroft in 1823, visited the garden. In his travelogue he recorded a false anecdote that Akbar admired this garden and said “Wah Bagh” (what a beautiful garden!). Hence the garden was so named and it is known as Wah Garden to this day.

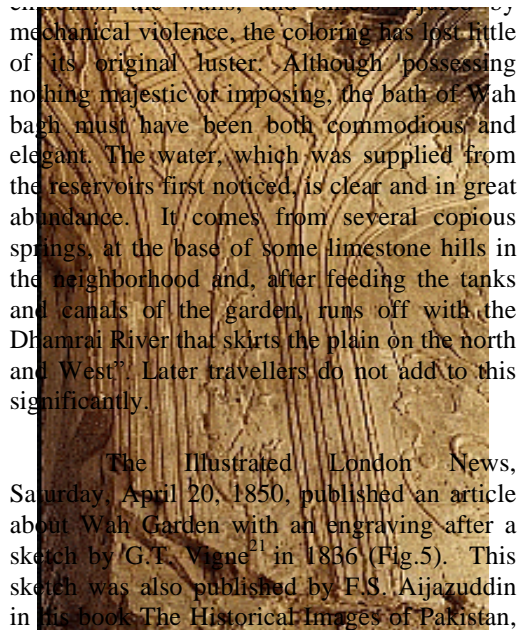

The Illustrated London News, Saturday, April 20, 1850, published an article about Wah Garden with an engraving after a sketch by G.T. Vigne¹¹ in 1836 (Fig.5). This sketch was also published by F.S. Aijazuddin in his book The Historical Images of Pakistan,

Figure 2: Stucco tracery on the inside of baradari.

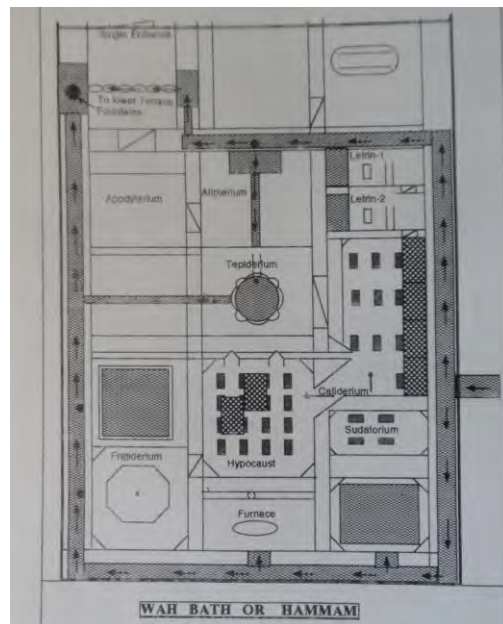

Figure 3: plan of the Hammam or turkish bath at Wah gardens

The description of Moorcroft about the gardens, however, is worth reading: “Advancing across the low ridge of the hills, we came to a plain in which stood the village of Wah, and an extensive garden, constructed by the order of Emperor Akbar, the beauty of which drew from the monarch the exclamation of “Wah!” whence the name of the new pleasure-ground originated. It covers a space about a quarter of a mile in length and half that in breadth, enclosed by walls partly in ruins. The gateways and turrets that were constructed along the boundary wall are also mostly in a ruinous condition. The eastern extremity is occupied by two large stonewalled tanks; the western by parterres, and they are divided by a building which served as a pleasure-house to the Emperor and his household. The interior of the whole is stuccoed, and in the smaller apartments the walls are decorated with flowers, foliage, vases, and inscriptions in which, notwithstanding the neglected state of the building and its antiquity, the lines of the stuccoed work are as fresh as if they had but just been completed, indicating a very superior quality in the stucco of the East over the West (Figure 2). The chambers in the southern front of the western wing, and other continued beyond it, constitute a suite of baths, including cold, hot, and medicated baths and apartments for servants, for dressing, and reposing, heating rooms and reservoirs (Figure 3) the floors of the whole have been paved with a yellow breccia, and each chamber is surmounted by a low dome with a central sky-light.

3. THE SUSTAIBALE BUILT ENVIRONMENT AT WAH GARDEN

The following lines will describe the sustainable built environment and the Hydraulic Engineering of the garden and then shall be summarised in the conclusion:

a) Hydraulic System, and b) Hammam (Turkish Bath)

3.1 The hydraulic system

Our excavations have discovered a large water tank on its eastern end, fifteen fountains in the central water channel and their water inlets, three water channels, a Paien Bagh/Zanana, (garden for ladies) a few architectural **ornamental objects in stone, and the Hammam or Turkish Bath. Our excavations confirm much of Moorcroft's** descriptions of Wah Gardens. Our discussion shall be limited to the following two examples only for sake of limiting our discussion to the sustainable architecture:

3.1.1 Central channel

From the middle of the western wall of the main tank in the upper terrace, starts the main or the central channel **which is 10'.4" wide & 11.3" deep. This channel passes through the Baradari down in the lower terrace, making a cascade. Water follows into the central channel when the main tank is filled to the height of 5'.6". There is a stone bridge on this channel at the distance of 91' from the main tank. Hitherto, only four fountains were known between this bridge and the main tank, but during our present project eight more fountains were discovered in the same area at regular intervals i.e, 7'.6"each. These fountains are connected by a terracotta pipe embedded in thick masonry, which is 40" deep. The drawing in (Figure 4) depicts the depth and width of the central channel and the details of how the fountains were connected with terracotta pipe and how the water was supplied to these fountains. This is the best example of sustainability for the architects to take inspiration from.**

3.1.2 The Hammam or Turkish bath

Adjacent to the southern end of the Baradari there is a Hammam (Figure 4). Here an independent aqueduct running beside the eastern wall of the main water tank supplied the water. This aqueduct supplying water to is nine inches wide and one foot deep. Fortunately the Hammam is still in a good state of preservation, showing almost all the necessary architectural features in situ of which we can identify the water supply, the heating room, the hypocaust and latrines. Some important and interesting aspects of this bath are: it has a single entrance through the western wing of the Baradari; it has a complex arrangement of rooms and halls as was seen and recorded by Moorcroft ; its walls are extra-thick (40-55 cm) to maintain the inside temperature; it has hollow pavements and the provision for a hypocaust, for circulating hot air and steam in the Hammam and for boiling water for a hot bath, there is a furnace which is connected with the hypocaust. The furnace has an entrance from the out side of the Hammam; there is also an excellent arrangement of running water and the provision of pools for hot, cold and medicated water; it has an effective drainage system still in operation; initially it had special ventilators in the ceiling of the rooms and its walls on the inside were once embellished with cut plaster painting and floors with mosaic as recorded and published by Moorcroft in 1823. Traces of painting on the wall and mosaic in the floor are still to be seen intact. Moorcroft saw and recorded in his descriptions that all the chambers of the bath were surmounted by low domes with central skylight. But when this Hammam was excavated not only its low domed ceiling but also its walls were badly damaged and the whole suite of baths was buried under a mound of earth. Some functional and more important architectural features or elements of this Hammam are as follows: Apodyterium- where the bather undressed and left his clothes, measuring 7.4X7.8 feet; Alipterium- where oil was anointed, measuring 12X12 feet; Calidarium- hot room, it has two wings, measuring 14X14 feet and 14.10X9.4 feet; Sudatorium- steam room, measuring 12X10 feet; Tepidarium- warm room, measuring 14X14 feet. Tepidarium generally is a large hall with a beautiful pool in the middle, such as found at Wah Garden, and it was used as a special meeting room; Frigidarium-cold bath, measuring 12.10X10.6 feet. It has an octagonal pool, measuring 4.4X4.4 feet, with a fountain in the middle. These are the most important features of all the known Mughal Hammams or Turkish Baths. All these features provide beautiful examples of sustainability for the architects to copy in their present day architecture right in their neighbourhood rather than copying the western world which is alien for the local community.

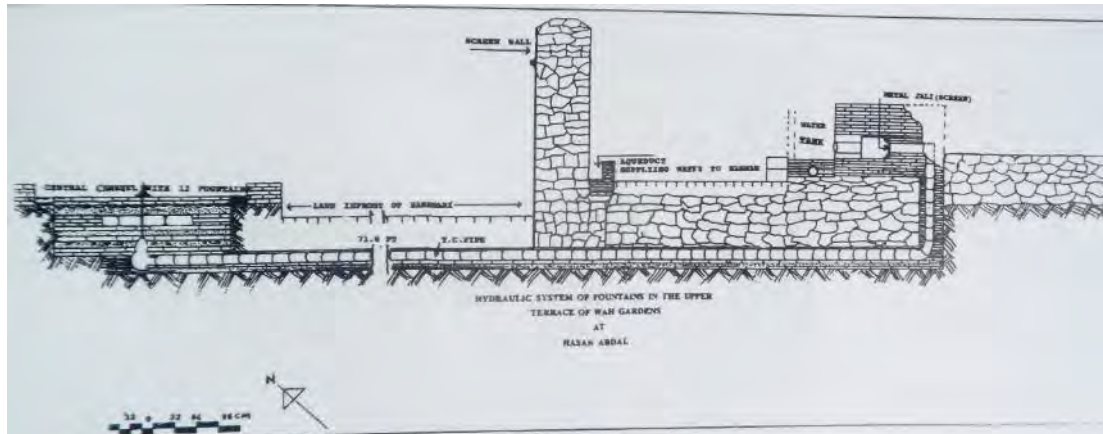

Figure 4: Cross section drawing of the hydraulic engineering / water supply to the fountains at Wah garden. Discovered and drawn by the author

4. CONCLUSION

This is the only garden in which a complete hydraulic system of Mughal period is discovered which represents a marvel of Hydraulic engineering of the 16th Century. The hydraulic engineering involved in this garden is based on the gravity and thus very simple but amazingly perfect and continuously running fountains were connected by Terra-Cotta pipe to a supplying reservoir whose base was approximately four feet higher than the fountain heads. This height through gravity kept the fountains running round the clock. The main purpose of paper is to draw the attention of the young architects to understand this simple but sustainable hydraulic system of the unique garden **and to replicate it in today's architecture. There is no rocket science involved in it according to the original plan.** It is very simple, main thing here is of understanding or get help from those who understand it and are willing to contribute for its authentic and original or near original replication elsewhere. This paper also provides a platform to benefit from and the author shall be available for consultation in case the young team requires assistance in understanding the hydraulic system. The author has first hand knowledge of all the architectural and archaeological features of these gardens and his excavation report was published in 1996. Since the excavation of Wah Gardens in 1993-94, the author has been involved in the research and teaching of Art and Architecture. He has been delivering the lectures on international forums and on Islamic Art and Architecture and has published number of papers and books on the subject. His recent published works such as a) History of Islamic Art; b) Significance of al-Mansurah ; c) Origin of Blue and white ; and d) Hydraulic Engineering of Wah Gardens; e) Principal source of Arabic Calligraphy are few examples of his commitment on the subject.

This heritage building has the best features of sustainable built environment for the students of architecture to take inspiration from. We hope and look forward to restore the garden once again according to the original pattern for the benefit of posterity interested in the sustainable built environment.

REFERENCES

- [1] Abul Fazl. (1881) Ain-i-Akbari, Munshi Nol -Kashor, Calcutta.
- [2] Aijazuddin, F.S. (1992) The Historical Images of Pakistan, Lahore.
- [3] **Bahadar, M. (1988) "Mughal Garden Wah", Journal of Central Asia, Vol. XI, No. 2.**
- [4] Baron Charles Hugel. (1845) Travels in Kashmir and the Punjab, London.
- [5] Beverage, H. (1939) Ain-i-Akbari and Akbar Nama, Culcatta,
- [6] District Gazetteer of Attock, (1865)
- [7] Elphinstone, M. (1815) An Account of the Kingdom of Caubul, London.
- [8] **Kanboh. (1927) 'Amal-i-Saleh', Calcutta.**
- [9] Lahori. (1868) Badshah Nama, Calcutta,
- [10] **Maclagan, E.D. (N.D) "The Earliest English Visitors to the Punjab, 1585-1628**
- [11] Mohan Lal. (1946) Travels in the Punjab, Afghanistan, and Turkistan, London.
- [12] Nadiem, Ihsan H. (1986) **"The Hydraulics of Shalamar Garden", Journal of the Pakistan Historical Society, Vol. xxxiv, part 1, pp.1-13**
- [13] Nath, R. (1976) Some Aspects of Mughal Architecture, Delhi.

- [14] **Rajput, S. A. (1996) "The Mughal Garden 'Wah' Near Hassan Abdal: "Report of Excavations of 1993-94 and New Discoveries" Based on Collaborative Study Sponsored by Smithsonian Institution, Washington, DC & Dept. of Archaeology, Lahore, The Mughal Garden: Interpretation, Conservation and Implications, 73-87**
- [15] -----History of Islamic Art, Sang-i-Meel, Lahore, 2008
- [16] -----Significance of al-Mansurah in the Context of Arab's and Muslim's History of Science, ELK Asia Pacific Journal of Social Sciences, 2015.
- [17] -----The Origin of Blue and White and its development during the 15th-16th century, Frontier Archaeology, 2014
- [18] -----The Principal Sources of Arabic Calligraphy in the Muslim World, Pakistan Heritage, 2013
- [19] Rogers, A. (1909) Tuzuk, RAS London.
- [20] Siddiqi, M.H, (1977) Tarikh -i- Hassan Abdal, Lahore.
- [21] Akbar Nama, (1883) Kanpur,
- [22] Sir Sayyed A. K. 1963 Tuzuk-i-Jahangiri, Ghazipur.

Developing a Conceptual Framework for Integrating Project Risk Management and Sustainability Objectives

Georgia Dodge GOSSE^a, Cheryl Julia Kiran DESHA^b, Timothy ROSE^c

^a Queensland University of Technology, Australia, georgia.gosse@hdr.qut.edu.au

^b Griffith University, Australia, c.desha@griffith.edu.au

^c Queensland University of Technology, Australia, tm.rose@qut.edu.au

ABSTRACT

It has been more than thirty years following the 1987 Brundtland report on sustainable development and professional project management standards have not fully integrated sustainability performance requirements. Acknowledging that while sustainable development is a critical topic area in the built environment sector, industry accepted project management processes still do not explicitly state how to embed sustainability throughout the life of a project. While some work has been done to determine how to integrate sustainability into some project management processes, the use of risk management to achieve sustainability outcomes is still absent. The challenge for both sustainability and risk management is the need to predict the future – either the future potential consequences of a risk or for sustainability the needs of the future generation.

Recognising this deficit, the authors draw on existing literature and precedents internationally to propose an innovative sustainability risk framework based on knowledge management to provide more intelligence to predict future impacts and needs and integrate within the risk management processes to transform project sustainability performance outcomes. The sustainability risk framework draws on a desk-based study that will subsequently be confirmed through interview and survey methods.

Risk management plays a critical role in project delivery and there are opportunities to harness existing knowledge management application to transform the risk management process to deliver on project sustainability objectives. The implications for industry are significant, providing a potential cost-saving mechanism for managing built environment projects, through process innovation and providing project managers with the power to influence and achieve sustainability outcomes on projects.

Keywords: project sustainability, project risk management, education and training

1. INTRODUCTION

Projects play a fundamental role in achieving the strategic sustainable development agenda for any country and it is imperative that projects include objectives that address sustainability. All 17 sustainable development goals set by the UN require projects at local, regional and national levels to achieve the ambitious targets (UN, 2016). In Australia, rating tools such as the Infrastructure Sustainability (IS) rating scheme and the Green Star rating system have been developed to help projects and their activities achieve sustainability. Although both the Infrastructure Sustainability Council of Australia (ISCA) and The Green Building Council of Australia (GBCA), recognise the influence of project sustainability objectives on the achievement of local, regional and national strategic sustainability objectives, sustainability is still predominately seen as a separate project management consideration outside time, cost and quality objectives and is usually only considered if the project sponsor has clearly articulated sustainability objectives. Even though there is clear evidence as describe above, that projects significantly contribute to the local, regional and nation achievement of sustainability objectives, the conceptual base of models and methodologies for project management has remained fairly static (Svejvig and Andersen, 2015).

In this paper, the authors review a typical project management framework, discussing its ability to support the achievement of sustainability objectives *and* manage associated risks. While there may seem to be conflict between traditional risk considerations/ objectives (time, cost and quality) and sustainability objectives they are inherently linked through their common objective to minimise negative project impacts to future generations (Krysiak, 2009). With this in mind, this paper focuses on the relationship between risk management and sustainability and reviews how risk and sustainability knowledge can move risk management from a compliance

exercise to a decision support tool that promotes the establishment and achievement of sustainable objectives on projects.

1.1 Definitions

Both project risk management and sustainability can be interpreted in a variety of different ways, depending on context. Project risk management is a proactive management process designed to exploit opportunities and treat **risks to secure a project's agreed, defined and disseminated objectives** (Chapman, 2013). This widely accepted best practice definition connects both risk and opportunities to project objectives.

The most globally accepted definition of sustainability was established by the World Commission on Environment and Development (WCED, 1987) which defined sustainable development as: 'development that meets the needs of the present without compromising the ability of future generations to meet their own needs, integrating social, economic and environmental goals to mutually reinforce each other'.

These definitions form the basis of this review.

1.2 Aim and objectives

The question remains, '*how can project management be adapted to ensure that sustainability objectives are achieved on projects?*' **Project sustainability objectives, where articulated**, impact project management processes and so demands an evolution of the traditional project management approach to address these impacts.

Risk management is critical to the success of a project and whether actively or not, all project managers manage risks. However, it is the empowering of a project manager with the tools and knowledge to achieve sustainability objectives, using risk management that is the aim of this paper. As such, this paper will focus on the relationship between risk management and sustainability and review how the process and culture of active risk management can support and promote the establishment and achievement of sustainable objectives on projects.

2. METHODOLOGY

Peer reviewed, academic journal articles published 2000 onwards were retrieved from the following databases and search engines; Google scholar, Science Direct, Web of Science, and Emerald. The following three strings of key words were used in the search: sustainability and project management, risk management and project management and risk management and sustainability, which returned 514 results.

The breadth of both the fields of sustainability and risk management resulted in the need for a manual high level assessment to be undertaken to set boundaries and focus the research. Following a topic search, content analysis was used to ensure that the articles addressed the central research topics.

In order to make the final selection, articles had to have a 'Quartile 1 Q1' score from Scimago or be considered reputable conference proceedings (i.e. published proceedings with a formal peer-review process). Five books by reputable authors were also included, where the authors were well-referenced researchers in the field. As this paper focuses on the relationship between sustainability and risk management, articles specific to risk modelling, risk software, enterprise risk management or corporate sustainability were subsequently excluded. Based on these parameters 79 papers were considered relevant to the research aim and were used for the subsequent detailed review.

Search String	No. of Articles	No. of Articles in Q1/Q2 Journals*	No. of Articles in Conferences	Other**
Sustainability and project management	45	24	13	8
Risk management and project management	26	16	3	7
Sustainability and risk management	8	4	0	4
Total	79	44	16	19

*Table 1: Literature review categorisation
Scimago <http://www.scimagojr.com/>
Other includes Q3/ Q4 publications and books*

The next section presents a review of key articles defined by the initial literature categorisation, followed by the presentation of a conceptual framework demonstrating the relationships between sustainability and risk management as established from the review.

3. CRITICAL REVIEW OF PREVIOUS STUDIES

Substantial work has been conducted on defining sustainable projects and assessing sustainability risks at project level, along with defining sustainability broadly and in the context of infrastructure is acknowledge, as is the use of risk modelling techniques to priorities and weight sustainability indicators. However, there is an acknowledged need to move from the high level objective level down to a delivery level which provides project managers with an avenue to address sustainability, throughout the life of a project, using methods they are already familiar with.

3.1 Sustainability and project management

Much work has been done to define sustainability from different perspectives and make it more tangible (Miah et al., 2014, Bell and Morse, 1999). Additionally, work has been undertaken on how to assess whether a project is sustainable, or not, at a planning and decision making level which addresses the initial question of whether or not **the project is an inherently 'sustainable project'** (Haavaldsen et al., 2014), **through the use of 'sustainability indicators'**. **Some literature alludes to the potential increase in up-front costs associated with delivering a more sustainable project, such as additional design costs for 'eco-design', or the development of a cradle to cradle waste management plan, or even a more inclusive stakeholder process** (Ugwu et al., 2006) and while many organisations can see the benefits of establishing and achieving sustainability objectives and outcomes, the largest barrier is measuring investment returns (Yang et al., 2015), which means research has tried to demonstrate that pursuing sustainability objectives can lead to better projects with minimal or no additional construction cost or effort (Anderson, 2012).

Further, significant work has been conducted to incorporate sustainability considerations into project management methodologies and provide high level guidance on what project management processes should consider in terms of sustainability (Silvius et al., 2012). In addition, there is a growing recognition that 'further development of the project management profession requires project managers to take responsibility for sustainability' (McKinlay, 2008), though the question of how it can be effectively incorporated remains unanswered?

3.2 Risk management and project management

Much of the project management literature recognises the role proactive risk management plays in the success of projects (de Wit, 1988, Cooke-Davies, 2002, Sanchez et al., 2009). However, many risk management methodologies primarily focus on the process of risk management and analysing risks against quantifiable criteria such as time, quality and cost (Taroun, 2014, Zhang, 2011). Recognising that projects are increasing in complexity and uncertainty, recent literature acknowledges the limits of traditional methods of prediction and planning and stresses the need to have multiple ways to anticipate and adjust to changes and disruptions caused by known and unknown risks (Shiroyama et al., 2012). An additional theme identified in the literature is the cultural and behavioural aspects of risk management and the recognition that to manage risk successfully it needs to be seen

as more than a process, but a cultural mindset to seeing risk management as a tool for decision making and addressing knowledge gaps (Regev et al., 2006). There is potential to move away from the application of a risk management process and generic standards towards an informed and dynamic practice that empowers project management to make decisions.

3.3 Sustainability and risk management on projects

There is a growing body of literature focusing on the importance of identifying, mitigating and managing sustainability risks (Pojasek, 2011, Lenssen et al., 2014, Giannakis and Papadopoulos, 2015), predominantly at a corporate level that usually defined risks with environmental and social impacts. It is clear from the literature available, that assessing project risks against sustainability objectives has generally not been part of the process.

Project risk management is a very well-known and accepted area of practice, in which the risk management process is vital and fundamentally influences the likelihood of success for any project (Stackpole, 2013). Sustainability in terms of risk management needs more than identifying sustainability risks and needs to consider against all project objectives as well as the different viewpoints of all project stakeholders (Silvius and Schipper, 2014). Currently the literature lacks sufficient research on assessing risk impact on qualitative project objectives (Taroun, 2014) and while recent studies have focused on providing project managers with adaptations to current project management processes to address sustainability risks, there is little information available for assessing risks in terms of impacts to sustainability objectives (Maltzman and Shirley, 2011, Silvius et al., 2012). Such information would provide project managers the opportunity to look at project risks through a sustainability lens in addition to standard, time, cost, quality objectives and people/ resources lenses as advocated by the Prince2 methodology (Bentley, 2009) or PMBOK methodology (Project Management, 2013).

4. DISCUSSION

There is conflict between traditional risk considerations/ objectives (time, cost and quality) and sustainability objectives and risk management is a tool to more effectively establish and achieve sustainability objectives. Sustainability and risk management are inherently linked; firstly at the core of the sustainability definition is the desire to meet the needs of the future generations, while risk management assesses the consequences of a risk that might eventuate in the future. Predicting the needs of future generations creates uncertainty and a propensity for change, and risk management can be the tool to manage the future consequences of this uncertainty and change. Secondly, both sustainability and risk are ambiguous terms and mean different things to different people, projects and organisations based on personal values, perceptions and experiences. This means on a project that views, interests and preconceived concepts need to be coordinated and aligned to achieve common objectives. Finally, sustainability objectives seek to promote a set of outcomes on a project which are robust and able to still deliver their intended outcome even with the unpredictability of future situations and risk management is a tool which can be used to develop effective mitigation strategies for future situation. (Gray and Wiedemann, 1999).

The above discussion suggests that decision makers and contributors to the risk management process need to have more tailored information regarding future scenarios and risk consequences to make informed choices. Knowledge management can help address both future planning and any ambiguity challenges of sustainability and risk management as knowledge management is a systematic approach in which information is turned into actionable knowledge and made available in a usable form to the people who can apply it (Dalkir, 2005). With greater knowledge regarding both risks from previous projects and future scenarios, the risk management process becomes a dynamic and iterative activity that provides valuable information to decision makers and **proactively addressed risks that could impact the establishment and achievement of any project's sustainability objectives.**

A new approach for project sustainability and risk management could address the complexities and ambiguity associated with both defining and measuring sustainability and risk. A move away from the traditional risk management process towards a knowledge based project risk management framework is the proposed approach. It differs from traditional project risk management which is based on a process and introduces the analysis of previous project knowledge and experience regarding risks and the impacts risks have had on project outcomes to develop a culture that continually reviews risks considering the sustainability objectives and the potential impact of the project on future generations.

The conceptual knowledge management framework in

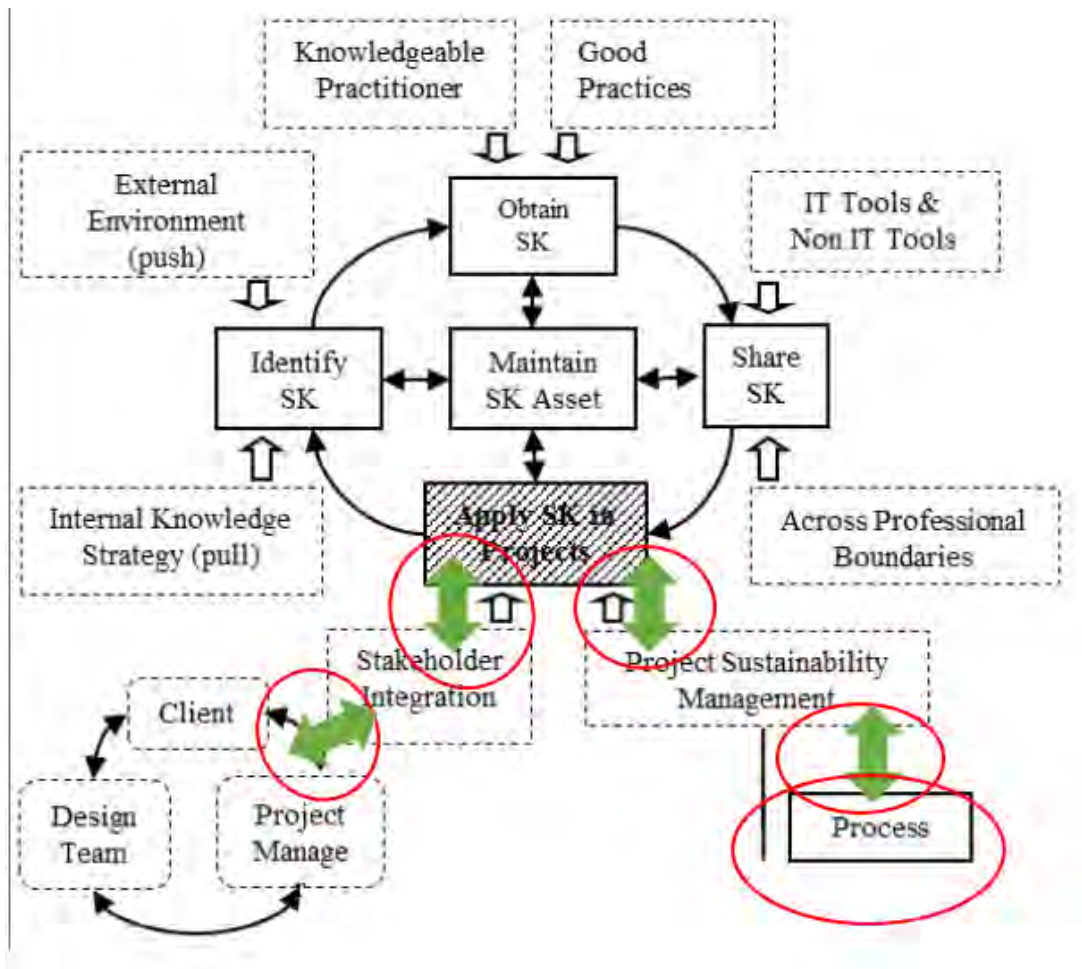

Figure 72 (Yang et al., 2015) has been adapted to reflect the interconnectivity of the stakeholder integration, and project sustainability management with the rest of the diagram.

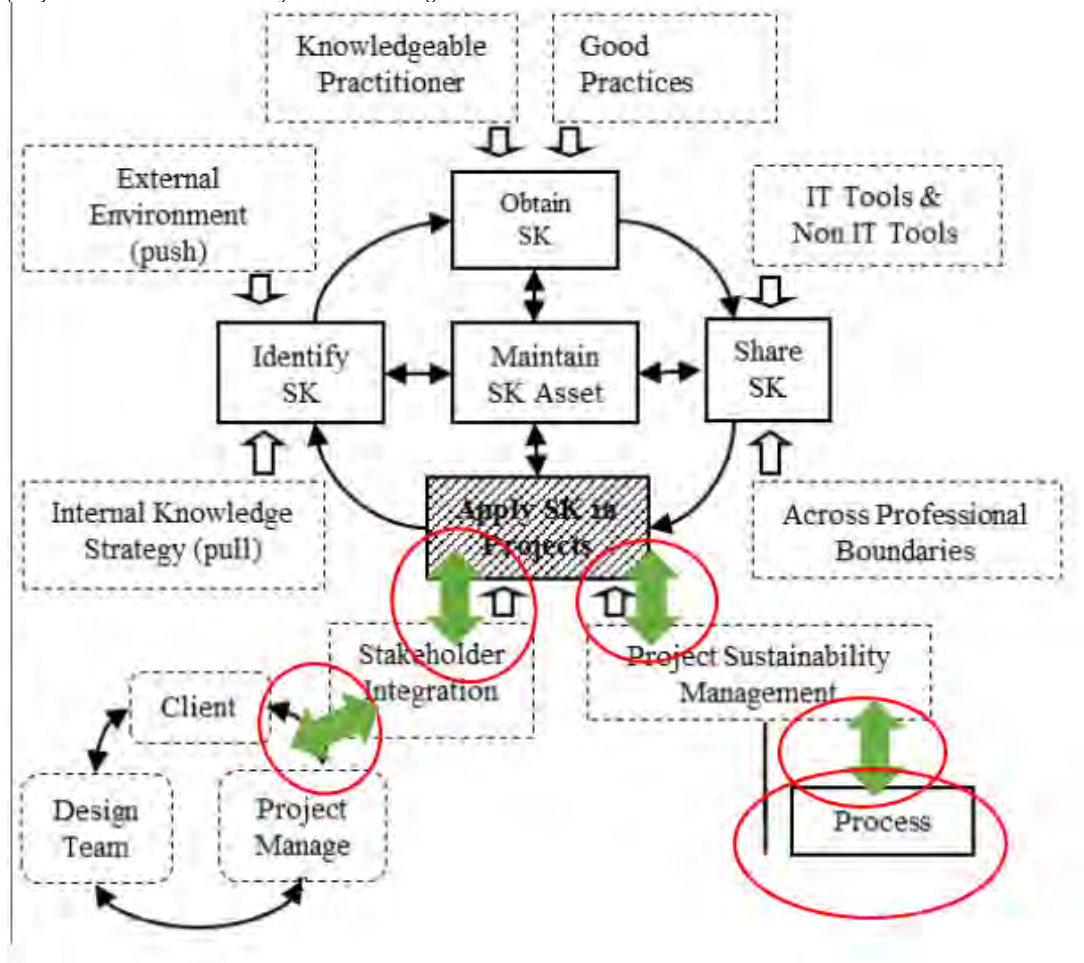

Figure 72 now recognises the need for a reiterative process as there needs to be a flow of information both downwards and upwards. Both stakeholder integration and project sustainability management contribute to sustainability knowledge (SK) on a project but sustainability knowledge from previous projects and project team members needs to contribute to the development of the stakeholder integration process and the project sustainability management process.

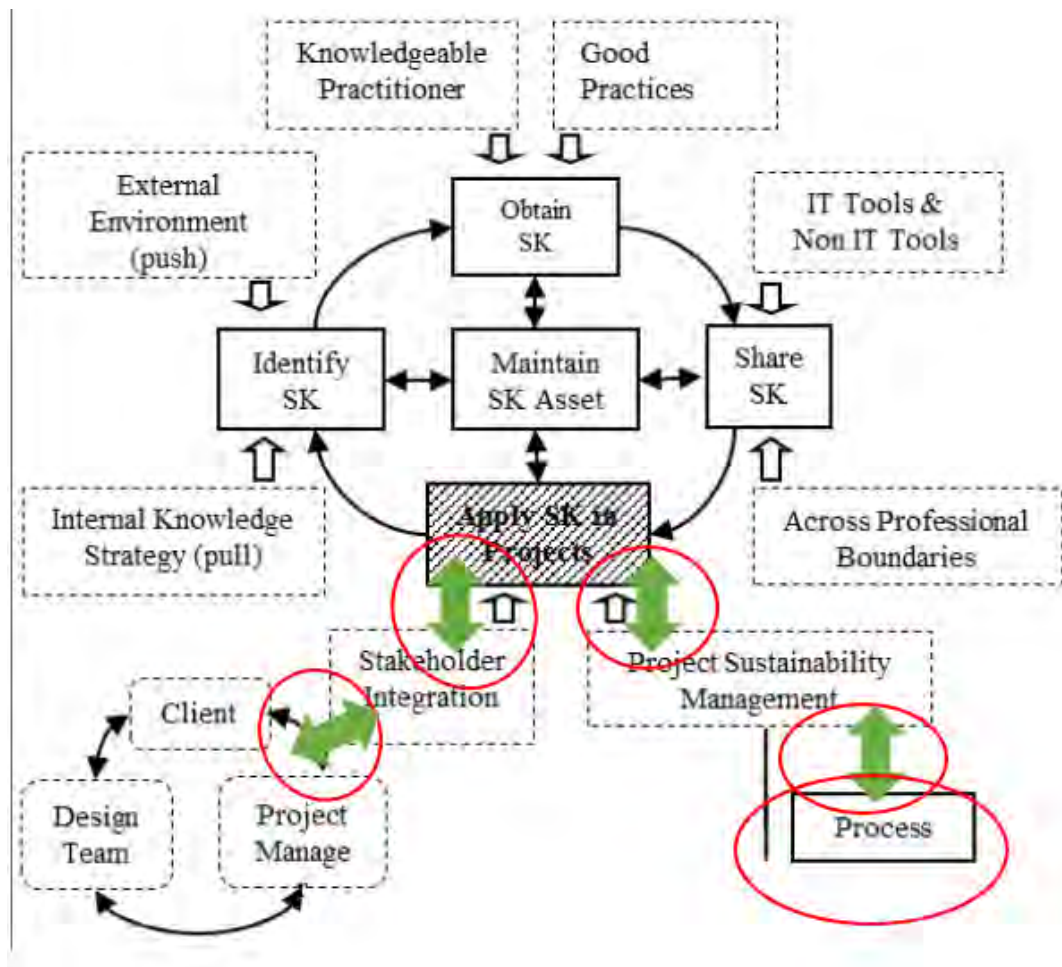

Figure 72: A conceptual KM framework (Yang et al., 2015)

Figure 73 further develops the project sustainability management and process aspects of the KM framework. The adaption reflects that the project sustainability management is missing an opportunity to be enriched if sustainability knowledge from previous projects and team members is not used. Using pre-existing knowledge can improve project outcomes as the decisions that project managers make will be supported by practical and factual information. This is important as it provides the project managers with a greater level of confidence in their ability to make the right decisions and justify these decisions based on existing knowledge, not instinct or pre-conceived biases.

In addition previous project knowledge initiates conversations regarding innovation, risk management, and lessons learnt. The project risk management process is greatly improved by the addition of previous project sustainability knowledge. Risks are better defined, where the assessment of the risk is grounded in actuals instead of predictions and the mitigation actions are informed by actions that have been both successful and unsuccessful in the past. In addition it provides critical information for more accurately quantifying risks which contribute to the budget contingency. This creates a risk management process that provides the project manager with greater confidence that risks on the project are applicable, comprehensive, and manageable and that the contingency applied to the project is realistic.



Figure 73: Sustainability and risk management conceptual framework

5. CONCLUSION

The link between sustainability and risk management is important. The recognition that assessing risks based on possible future scenarios and previous project knowledge means project managers are addressing sustainability, whether or not the project sponsor has clearly defined sustainability objectives. This means a shift away from project sponsor mandated sustainability objectives and towards a best practice embedded approach to establishing and achieving sustainability objectives on projects. Capitalising on previous project sustainability knowledge and using information as the new baseline for a similar project, forces continual sustainable improvement on projects. In addition, enriching the risk management process with sustainability knowledge increases the transparency and confidence regarding associated costs and improves strategic decision making, using evidence based on considerations of past incidents and actual issues addressed. Providing a framework for project managers to access and implement sustainability knowledge on a project will strengthen the delivery capability of project managers and drive the successful achievement of sustainability objectives on projects.

REFERENCES

- [1] ANDERSON, J. L. 2012. Measuring sustainability in civil engineering: development, testing and implementation of the Greenroads(TM) Rating System. Ph.D., University of Washington.
- [2] BELL, S. & MORSE, S. 1999. Sustainability indicators: measuring the immeasurable?, London, Earthscan Publications.
- [3] BENTLEY, C. 2009. PRINCE2: A Practical Handbook (3rd Edition), Burlington, MA, USA, Routledge.
- [4] CHAPMAN, R. J. 2013. The Rules of Project Risk Management, Routledge.
- [5] COOKE-DAVIES, T. 2002. The "real" success factors on projects. *International Journal of Project Management*, 20, 185-190.
- [6] DALKIR, K. 2005. Knowledge management in theory and practice, Amsterdam; Boston; Elsevier/Butterworth Heinemann.
- [7] DE WIT, A. 1988. Measurement of project success. *International Journal of Project Management*, 6, 164-170.

- [8] GIANNAKIS, M. & PAPADOPOULOS, T. 2015. Supply chain sustainability: A risk management approach. *International Journal of Production Economics*, 32.
- [9] GILB, T. 2002. Risk Management: A practical toolkit for identifying, analyzing and coping with project risks. *International Symposia of the International Council On Systems Engineering (INCOSE)*. Las Vegas.
- [10] GRAY, P. C. R. & WIEDEMANN, P. M. 1999. Risk management and sustainable development: mutual lessons from approaches to the use of indicators. *Journal of Risk Research*, 2, 201-218.
- [11] HAAVALDSEN, T., LÆDRE, O., VOLDEN, G. H. & LOHNE, J. 2014. On the concept of sustainability – assessing the sustainability of large public infrastructure investment projects. *International Journal of Sustainable Engineering*, 7, 2-12.
- [12] KRYSIAK, F. C. 2009. Risk Management as a Tool for Sustainability. *Journal of Business Ethics*, 85, 483-492.
- [13] LENSSEN, G., NIJHOF, A., ROGER, L., KIEVIT, H., LENSSEN, J.-J., A. DENTCHEV, N. & ROGER, L. 2014. Sustainability, risk management and governance: towards an integrative approach. *Corporate Governance: The international journal of business in society*, 14, 670-684.
- [14] MALTZMAN, R. & SHIRLEY, D. 2011. *Green Project Management*, United States of America, CRC Press Taylor and Francis Group.
- [15] MCKINLAY, M. Opening Address - A Call to Action. *World Congress of the International Project Management Association 2008*.
- [16] MIAH, A. H. S., WATTS, G. R. & OLTEAN-DUMBRAVA, C. 2014. **“Top-Down-Bottom-Up” Methodology as a Common Approach to Defining Bespoke Sets of Sustainability Assessment Criteria for the Built Environment.** *Journal of Management in Engineering*, 30, 19-31.
- [17] POJASEK, R. B. 2011. Linking sustainability to risk management. *Environmental Quality Management*, 21, 85-96.
- [18] PROJECT MANAGEMENT, I. 2013. *A Guide to the Project Management Body of Knowledge (PMBOK Guide)*, Newtown Square, Pa, Project Management Institute.
- [19] REGEV, S., SHTUB, A. & BEN-HAIM, Y. 2006. MANAGING PROJECT RISKS AS KNOWLEDGE GAPS. *Project Management Journal*, 37, 17-25.
- [20] SANCHEZ, H., ROBERT, B., BOURGAULT, M. & PELLERIN, R. 2009. Risk management applied to projects, programs, and portfolios. *International Journal of Managing Projects in Business*, 2, 14-35.
- [21] SHIROYAMA, H., YARIME, M., MATSUO, M., SCHROEDER, H., SCHOLZ, R. & ULRICH, A. E. 2012. Governance for sustainability: knowledge integration and multi-actor dimensions in risk management. *Sustainability science*, 7, 45-55.
- [22] SILVIUS, A. J. G. & SCHIPPER, R. P. J. 2014. Sustainability in project management: A literature review and impact analysis. *Social Business*, 4, 63-96.
- [23] SILVIUS, A. J. G., SCHIPPER, R. P. J., PLANKO, J., VAN DEN BRINK, J. & KOHLER, A. 2012. *Incorporating Sustainability into Project Management. Sustainability in Project Management.* United Kingdom: Gower Publishing Limited.
- [24] STACKPOLE, C. 2013. *A user's manual to the PMBOK guide -- fifth edition*, Hoboken, N.J, Wiley.
- [25] SVEJVIG, P. & ANDERSEN, P. 2015. Rethinking project management: A structured literature review with a critical look at the brave new world. *International Journal of Project Management*, 33, 278-290.
- [26] TAROUN, A. 2014. Towards a better modelling and assessment of construction risk: Insights from a literature review. *International Journal of Project Management*, 32, 101-115.
- [27] UGWU, O. O., KUMARASWAMY, M. M., WONG, A. & NG, S. T. 2006. Sustainability appraisal in infrastructure projects (SUSAIP): Part 1. Development of indicators and computational methods. *Automation in Construction*, 15, 239-251.
- [28] UN. 2016. Development Goals [Online]. Available: <http://www.un.org/sustainabledevelopment/sustainable-development-goals/> [Accessed September 28].
- [29] WCED 1987. *Our Common Future*, Oxford, England, Oxford University Press.
- [30] YANG, J., YUAN, M., YIGITCANLAR, T., NEWMAN, P. & SCHULTMANN, F. 2015. Managing Knowledge to Promote Sustainability in Australian Transport Infrastructure Projects. *SUSTAINABILITY*, 7, 8132-8150.
- [31] ZHANG, H. 2011. Two schools of risk analysis: A review of past research on project risk. *Project Management Journal*, 42, 5-18.

Session 7.9: Transforming Green Market – Supply Chain

New Visitors? Small European Companies Entering the Chinese Sustainable Building Market

Christian KOCH^a, LI Haixi^b, ZHAO Yimin^c, Anders LUTTEMAN^d

^a Chalmers University of Technology, Sweden, kochch@chalmers.se

^b Chalmers University of Technology, Sweden, haixi@student.chalmers.se

^c Chalmers University of Technology, Sweden, zymin@student.chalmers.se

^d Chalmers University of Technology, Sweden, anders.lutterman@chalmers.se

ABSTRACT

The market for sustainable buildings in China is steadily growing. Also small and medium-sized European companies are able to internationalise and enter this market. Internationalisation is often initiated through participation in or even initiation of building projects. In particular Swedish building companies have a potential competitive advantage in the booming market for sustainable building, energy efficiency and energy renovation.

The main aim is to study how cultural aspect influence in a selected energy efficiency building project involving Swedish and Chinese partners.

The framework of understanding draws on small international business, supply chain and organization theory but focus especially on organizational culture.

The method rely on two case studies of Chinese sustainable building projects where a small Swedish consultancy company participate. Interviews was carried out with representatives from Swedish and Chinese companies active in two Chinese projects. One project is selected to study it is a green hotel project. Both projects obtains an EU green building certificate. The projects follow each other in time and can be seen as steps towards a niche for the Swedish company in China. Thus transforming them from visitors to permanent contributors to sustainable buildings in China.

The results in particular highlight that cultural differences in the Chinese supply chain of companies are more important than national distinctions Sweden-China. The cultural pattern is thus more of a multiple configuration than a dual culture. Nation, region, company and sector cultures interact and certain culturally based interpretations by the participants serves to confirm existing understanding of sustainable building projects. Small companies in particular are dependent of their cultural resources due to limited other resources. Through their network opportunities and dependencies they continually have to decide and act upon situational judgment informed by their cultures.

Keywords: energy efficiency, china, culture

1. INTRODUCTION

Sustainable buildings is a global trend due to a number of dynamics: building material suppliers globalise, methods and technologies do etc. Also the Chinese market for sustainable buildings are part of this development (Dodge 2016). Prognoses for China anticipates considerable growth in the sectors of new commercial and high-rise residential (Dodge 2016). Clearly this market will be occupied, penetrated by large players. However the growth, fragmentation and differentiations of the market also implies that there are large opportunities for smaller players (EU SME Centre 2013). Small companies are to an increasing degree internationalising, yet it is a prevalent concern that they might run into many of the same barriers large multinationals have previously experienced. One important is cultural differences (Lewis 2006).

The main aim is to therefore to study how cultural aspects influence in a selected energy efficiency building projects involving Swedish and Chinese partners?

It is important to study small companies contribution to sustainable building. Small companies can be agile carriers of innovative transformation in direction of more climate accountable solutions. When they operate small companies in particular are dependent of their cultural resources due to limited other resources. Through their network opportunities and dependencies they continually have to decide and act upon situational judgment informed by their cultures. And this naturally impact on their ability to create sustainable buildings.

The paper is structured in a traditional way. Starting with the method, followed by the theoretical understanding of culture. Then the case description and analysis.

2. METHOD

The paper built on research carried out by (author references). This research included several aspect of two energy renovation project in china involving a Chinese Swedish collaboration. For this paper we selected the cultural aspect for a more focused scrutiny.

The framework of understanding initially drew on small international business, supply chain and organization theory of culture. In this paper the focus is on cultures in multinational construction project and the theoretical framework combines several culture conceptualisation (Coffey 2010, Gesteland 2013, Lewis 2006) tied together by Alvesson (2003) multiple constellations of culture framework.

For the empirical material we selected one of two cases studied in (author reference), because the cultural aspect of this case was particularly interesting. We use the other case as background and contribution to our analytical framing, although we do posit that the case is a single qualitative insight in a particular constellation of cultures (Alvesson 2003).

Data collection was carried out by two of the authors. Initially pre-research and interviews was carried out to make the research question more accurate. Further, different relevant scientific data are used in the research as fundamental literature resources to support the empirical research. Interviews were designed based on the project materials and the literature resource to conduct better understanding of the project process. However, it was not possible to interview all the people involved in the project due to the time limit and other reasons, but the main actors from both Swedish and Chinese side are interviewed. The interviews are made in face to face and other possible ways. The case analysis is based on literature review, study of the case project material and the interviews. Discussion and Conclusion are built upon the previous research process.

3. THEORETICAL FRAMEWORK

In a construction section a number of culture producers are prevalent. The projects. Companies, sectors, regions and nations are some of them (Alvesson 2002, Coffey 2010).

Alvesson argue that cultures can be analysed in a integration, differentiation and ambiguity perspectives (Alvesson 2002)

Focusing in on cultural differences, they are often referred to as the most common issue in the current international projects (Zhang & Liu 2006). It impact on how people behave in their work and also many other parts of the international projects. Thus, it is important to notice and understand the culture difference enable to work together well. **According to Gesteland (2013), there exists five divides of people's common behaving all over the world** depending on the place they come from.

- Deal-focused vs. Relationship-focused
- Direct (low-context) vs. Indirect (high-context) Communication
- Informal (egalitarian) vs. formal (hierarchical) Business behaviour
- Rigid-Time (monochromic) vs. Fluid-Time (polychromic)
- Emotionally Expressive vs. Emotionally Reserved Business behaviour

The following part will explain what they are and what need to consider when cooperate the people that from these areas. However, culture is complex it includes too many thing that need to take into consideration. The aim of this part is to provide the readers a general guide of the culture difference and awareness.

The *deal-focused* culture built on believing in that trading unites people, whereas *relationship-focused* people are the people who often avoiding doing business with strangers, they prefer to choose the people from their personal network of contacts to get things done, such as Latin America, Asia/ The Pacific region, most of Africa and the Arab world. Deal-focused people are the people who found the cooperators based on the competences, and is a natural thing to work with strangers. Including Europe, North America, Australia and New Zealand. The problem regarding to this categorization is how to make initial contact with the business partner. The formal introduction is not needed in a deal-focused country, while usually started with "cold calls". However, in relationship-focused countries, introduction is usually necessary. Gesteland (2013) also advised to apply an indirect approach to build up the relationship of business in the relationship-focused countries. The indirect approach refers to finding a third party to work as a recommender between the two business potential partners, preferably a high-status person. After the introduction part in relationship-focused countries, it is necessary to spend time establishing the business relationship. This is the reason that why it usually takes a longer time for the negotiations in relationship-focused countries than it in deal-focused countries. Except that, the face-to-face meeting is recommended in the communication with relationship-focused countries, since they always feel it is not polite to discuss important issues in writing or phone calls (Gesteland, 2013).

The direct versus indirect communication part is discussed the different communication manners of the relationship-focused and deal-focused people. It is one of the greatest causes of the misunderstandings. Deal-focused people usually say what they mean without any implicit meaning, while the relationship-focused people **always have some implicit meaning by using the word "maybe" or "perhaps"**. Therefore, it should be carefully when two people coming from two different kinds of countries (Gesteland, 2013).

With other words the *informal vs. formal business behaviour* distinction is the distinction between hierarchical and egalitarian cultures. Hierarchical countries take most part of the world. In these countries, showing respects and addressing people formality is significant important, such as some Europe countries, Asia, Arab World and Latin America. By contrary, the egalitarian countries including Nordic countries, Australia, New Zealand, USA, Canada and The Netherlands. Therefore, when egalitarian countries need to have business with hierarchical countries and aware of this phenomenon is necessary.

In the two kinds of cultures, *rigid-time vs. fluid-time* they have different awareness about time. The schedules are usually fixed and highly valued punctuality in rigid-time cultures. Germany, Northern Europe, North America, Czech Republic, Hungary and Japan are included. On the other side, it is much less strict on schedule and time in fluid-time cultures, such as Africa, the Arab World, Latin America, South and Southeast Asia. Besides, there also exist some countries that belong to the part that between the rigid-time and fluid-time cultures, which are Australia, New Zealand, China, and Russia, most of East-Central Europe, Southern Europe, Singapore and South Korea.

Emotionally expressive vs. emotionally reserved cultures are expressed verbal paraverbal and nonverbal. Apart from verbal language, body language also plays a crucial role in how people communicate. Paraverbal is relates to how loud the talking and the meaning of silence. The paraverbal and nonverbal part are often have large distinctions in two kinds of cultures. There exists a possible problem when an expressive businessman communicating with a reserved non-expressive cultural person. In the latter person's perspective, the attitude of expressive may be seen as a hostile attitude. Therefore, the negotiations in reserved cultures usually spend a longer time since they are not in the same context of attitude with the emotionally cultures, and the negotiators may take turns in talking. It is only a little connection with verbal language, but have much more responses to paraverbal and nonverbal parts. Further, there are four elements that need to consider when talking about the nonverbal language, which are personal distances, touch behavior, eye contact and gestures. Overall, when a negotiation or a project communication occurs in an international project, it is not enough to just concern what the words that going to say, or if the counterparts could understand. It is also crucial to think about something that out of words, such as paraverbal and nonverbal parts. It is significant to ensure that all of the people involved in the project team are satisfied.

3.1 Lewis model: cultures in conflict

Lewis (2006) assumes that cultural conflicts are the main challenge for international management. According to Lewis (2006)'s conceptualisation, there exist three types of cultures globally, which are Linear-active, Multi-active

and Reactive. He categorized the culture in order to avoid the unnecessary offend caused by cultural distinction and also to predict **different people's behaviors**.

3.2 Alvesson model: multiple cultures in constellation

Alvesson proposes a multiple configuration as concept for this copresence of cultures. He argues that cultural similarities, differences and ambiguities exists in complex patterns, and that these are contextually specific, thus departing from Lewis (2006) preconditioning of cultural conflict. We therefore use the combined understanding of these culture scholars to inspire the case work in a relative open manner ex ante and even through revisiting the culture theory after having done a first round of analysis.

4. CASE: HANG XING PROJECT PLAYERS

DELTAte is a small Swedish consultancy company. BCKJ is a small architectural design firm in China. DELTAte was participating in a Chinese energy efficiency building project to provide the indoor climate system design solution with BCKJ. This energy efficiency building project is called Hangxing Technology Center. Hangxing Technology Center is defined as a new office building, and the owner of Hangxing Technology Center is **Hangxing Machinery Manufacturing Company. BCKJ is responsible for the building's architectural and HAVC system design.** Hang Xing Technology Center located in Beijing which has a surface of 33.500 m² is the first project to obtain an EU green building certificate in China.

The project organization consists of project Management(Sweden) 2 persons (Swedish). Consultants three persons, one Chinese. Project Manager(China) one chinese- and a chinese HVAC engineer.

Players in Sweden:

- DELTAte (service provider)

Players in China:

- Hangxing Machinery Manufacturing Company (client)
- BCKJ (service provider)
- Construction Contractor (contractor)
- Construction Site Workers
- HVAC Engineers (supplier)
- Nokia (building user)
- IBM (building user)
- Beijing Planning and Construction Bureau (regulation agency)
- Beijing Architect Design Institute (regulation agency)

Other Players:

- European green building council (regulation agency)

5. HANG XING TECHNOLOGY CENTER PROJECT PROCESS

Below the overall process is first presented in three steps before going more in detail: The first step was a design and construction phase. Here suppliers applied for European Green Building certification to European Commission and related consulting works for this building. BCKJ is in charge of the primary material preparation and explanation. **DELTAte is in charge of Hangxing office building's application, translation, and related consulting works.** The second step was an adjustment phase on the completed building. Here consulting provided services on energy controlling, adjustment and optimizing ventilation, heating and cooling systems of Hangxing Technology Center. The third step is an operation phase. Here power management by remote controlling of ventilation, heating, and cooling systems. DELTAte specified solutions to particular problems of Hangxing Technology Center. More in detail Hangxing project started with a workshop for about one week in Sweden, Dongmei (the China project manager), a colleague of her, and two HVAC engineers came to Sweden for a study visit trip. They discussed the climate and how to design the natural ventilation system and also fan ventilation system for Hangxing Technology

Center. Because the Swedish consultancy did not know the Chinese regulation, Dongmei as the design manager with HVAC engineers came from China were responsible for translate the design fit the Chinese quality standard. After the workshop, they were working separately in Sweden and China each their part of the project. Most of the project communication is through emails between the two sides of the project team from Sweden and China. There is one Chinese consultant named Liu who can speak both Chinese and Swedish, that worked in the Swedish team and was responsible for help with the communication in between. Sometimes online meetings and phone calls were also used as the communication tool. Based on the interviews, the communication through email works well and as intended. But both teams did not have a possibility for communicating with the site workers which is a significant issue since the Chinese site workers are not able to read the drawing and they made some mistakes during the building. Not much culture differences between Swedish and Chinese partners appeared during the project. Further, the one major challenge was to maintain and qualify the design to comply with Chinese regulation. Dongmei as the design manager for the Chinese side took most of the responsibility to work with this issue and explained the design for the related administration department since Hangxing at the time was the first building to apply the European green building certification. However, the biggest challenge for the Hangxing project was to **negotiate with the building's** user because of the insufficient communication between the building owner and its future user(s). The end user of the building refused to accept the indoor climate system designed for the building. They did not trust the system and wanted to change back to the old indoor climate system. In the end, the designer refused to change anything that was designed previously, a position which made the building owner unsatisfied with this action. After the construction, the building owner refused to do the project follow up work. Thus, the design team cannot do the project follow up even if the building has been successfully certified with the European green building certification.

6. DISCUSSION

This section contains three parts, which will show what are the similar, different and ambiguous cultural characteristics and behaviours between Swedish and Chinese. By analyzing the case and interviews with two project managers, the cultural characteristics of players, Chinese and Swedish, could be concluded and categorized based on Alvesson (2002), Lewis model (2006) and Gesteland (2013).

6.1 Similar cultural behaviors

In an integration perspective one can note that the consultants, engineers and architects appear to draw on shared meaning on a common building design collaboration. This culture cuts across the national differences, Moreover although Swedish and Chinese are from different continents, they still have some similar cultural practices, based on the feedbacks from case and interviews. Nowadays, when either Chinese or Swedish seeking for the co-operators, both of them are focusing on two sides, which are the relationship and working abilities. Therefore, on this aspects, they have similar features.

6.2 Different cultural behaviors

In a differentiation perspective one can first, refer to the table of the cultural behaviors comparison between two national cultures shown below.

Chinese culture	Swedish culture
Relationship-focused & Deal-focused	Deal-focused & Relationship-focused
Indirect communication	Direct communication
Formal business behavior	Informal business behavior
Rigid-time	Rigid-time
Emotionally reserved	Emotionally reserved & expressive

Figure 1: Comparison between Chinese cultural and Swedish cultural behaviors in Lewis dimensions

As people of different nations, there exist some differentiations on personal characteristics between Chinese and Swedish. According to Lewis model (2006), Chinese belong to the reactive culture, which means that Chinese people have the features like quiet, introvert, patient and respectful. However, as Swedish are more tend to be the linear-active culture, which has the characteristics like strictly and having flatter organization. On the view of cultural behaviors aspect. Chinese are used to use implicit words or direct communication during the conversation, while

Swedish prefer to communicate in a direct way. Further, as hierarchical cultural people, Chinese people regard using formal business behaviors as important during the cooperation, while Swedish prefer informal business behaviors since they belong to a flatter culture. What proved to be a larger cultural challenges was the differences between the various Chinese players involved in the project. Collaboration between client and his end-user, with construction workers and more showed some typical fragmented culture elements for Chinese construction (Gao and Low 2014) and even comparable to other countries cultural fragmentation (Coffey 2010).

6.3 Ambiguous cultural behaviors

Except for the similar parts and different parts that discussed before, there also was some cultural behaviours or personal characteristics that were ambiguous and hard to be clearly categorized. On the attitude about the time, Swedish are significant more strict in this project context. Chinese also have a rigid time attitude. But unlike Swedish, there can exist some flexible changes on their schedule, which can hardly accepted by the Swedish in this project. This contradict however how Swedes in other building project might operate considerable time flexibility. In the project both parties experienced difficulties expressing direct refusing proposals. Saying no was difficult, yet for different reasons. Furthermore, Chinese usually hide their emotions during the communication, while most Swedish like to show their feelings and emotions. However, based on the interview feedback, interviewees mentioned that Swedish also start to hide their feelings in the meeting. So it is such ambiguity to define if they are different or not.

7. CONCLUSION

The main aim of this paper was to study how cultural aspects influence in a selected energy efficiency building project involving Swedish and Chinese partners in the Beijing region. The theoretical framework juxtaposed several culture conceptualisation using a notion of multiple constellation of cultures as umbrella. The results in particular highlight that cultural differences in the Chinese supply chain of companies are more important than national distinctions Sweden-China. The cultural pattern is thus more of a multiple configuration than a dual culture. Nation, region, company and sector cultures interact and certain culturally based interpretations by the participants serves to confirm existing understanding of sustainable building projects. Small companies in particular are dependent of their cultural resources due to limited resources. Through their network opportunities and dependencies they continually have to decide and act upon situational judgment informed by their cultures. The small Swedish company emerge into more projects in China. The authors studied two of them. The two green projects followed each other in time and can be seen as steps towards a niche for the Swedish company in China. Thus transforming them from visitors to permanent contributors to sustainable buildings in China. As this paper have shown they can draw on their understanding of fragmentation in construction even in China.

REFERENCES

- [1] Alvesson, M. 2003. *Understanding Organizational Culture*. Sage, London.
- [2] Coffey V. 2010. *Understanding Organisational Culture in the Construction Industry*. Spon Research, New York.
- [3] Dodge Research and Analytics 2016. World Green Building Trends 2016. SmartMarket Report. Accessed on the web april 2016. <http://analyticsstore.construction.com/smartmarket-reports/2016WorldGreen.html>
- [4] EU SME Centre 2013. *The green building sector in China*. EU SME Centre, Beijing.
- [5] Gao S. and Low L.P. 2014. *Lean Construction management – The Toyota way*. Springer Singapore.
- [6] Gesteland, R.R. 2012. *Cross-cultural business behaviour: a guide for global management*. 5th edition, Copenhagen Business School Press, Copenhagen.
- [7] Lewis, Richard D. 2006. *When Cultures Collide: Leading Across Cultures*, Third Edition. Nicholas Brealey Publishing, Boston.
- [8] Zhang S.B. & Liu A.M.M. 2006. Organisational culture profiles of construction enterprises in China, *Construction Management and Economics*, 24(8), 817-828.

Sustainable Electrical and Mechanical Services – Vision with Action

CHEUNG Kwok-fai^a, Arthur WONG Kam-hay^b, CHAN Ming-yee^c

^a *Electrical and Mechanical Services Department, Government of the HKSAR, Hong Kong SAR, kfcheung@emsd.gov.hk*

^b *Electrical and Mechanical Services Department, Government of the HKSAR, Hong Kong SAR, akhwong@emsd.gov.hk*

^c *Electrical and Mechanical Services Department, Government of the HKSAR, Hong Kong SAR, chanmy@emsd.gov.hk*

ABSTRACT

By a resolution of the Legislative Council in accordance with the Trading Funds Ordinance (Cap. 430), the Electrical and Mechanical Services Trading Fund (EMSTF) is established under the Electrical and Mechanical Services Department (EMSD) in 1996, with a view to improving the quality and cost-effectiveness of its engineering services through the pressure from quasi-commercial operation and market competition. Besides maintaining the **government's vehicle fleets**, EMSTF also provides operation, maintenance, project management, and technical consultancy services in relation to electrical, mechanical, electronic and building services systems and equipment at public facilities. Since its establishment, EMSTF has been growing steadily. In 2015/16, EMSTF recorded a business revenue of HK\$5,764M and a rate of return on revenue at 4.8%.

To demonstrate the commitment to delivering sustainable and quality services for clients, EMSTF has been making extensive efforts in enhancing its management systems. EMSTF is the first government department to obtain corporate certification in ISO-9001 Quality Management System and ISO-14001 Environmental Management System during the turn of the century. In 2002, EMSTF became the first government department to obtain corporate certification for its Integrated Management System in quality, environment, and occupational health and safety. Moreover, EMSTF was also the first government department to receive the Total Quality Management Gold Award presented by the Hong Kong Management Association in 2006. Other certifications acquired included ISO 27001 Information Security System and ISO 50001 Energy Management System. Furthermore, to inspire by example, the EMSD Headquarters in Kowloon Bay is the first existing government building awarded a Platinum Rating in BEAM Plus assessment scheme run by the Hong Kong Green Building Council.

With the corporate goal of “**creating public value for the community betterment through partnership with our clients**”, EMSTF set up its first Five-Year Strategic Plan (the Plan) in 2013. The Plan consists of five corporate strategies, namely 1) deliver excellent service, 2) become a trade model, 3) build capacity and caring culture, 4) enhance knowledge management and 5) sustain green operation. With our strategic plan translates into actions, EMSTF will advance in multiple fronts such as enhance customer services; apply new technologies to enhance reliability, performance and serviceability of E&M assets; build up staff competence and capability and sustain green operation with smart and low carbon solutions.

Keywords: E&M services, 5-year strategic plan, urban regeneration

1. INTRODUCTION

The Electrical and Mechanical Services Department (EMSD) is a works department under the Development Bureau (DEVB) of the HKSAR Government. The Department consists of two arms, namely the Regulatory Services and the Trading Services, to provide electrical and mechanical (E&M) services for enhancing the safety and quality of life of Hong Kong. By a resolution of the Legislative Council in accordance with the Trading Funds Ordinance (Cap. 430), the Electrical and Mechanical Services Trading Fund (EMSTF) is established under the Electrical and Mechanical Services Department (EMSD) in 1996. EMSTF was obliged to provide more flexible, cost-effective and customer-oriented services under a self-financed trading fund business model for enhancing the quality of living of the general public through services to a wide range of public facilities.

In the 20 years of journey, EMSTF achieved productivity enhancement, doubled its business volume and joined hands with clients to make substantial achievements in Hong Kong such as enhance engineering service to fight against SARS in 2003; provide specialist IT support to the World Trade Organization Meeting in Hong Kong in 2005; provide various engineering service for 2008 Olympic Equestrian Event; and 2009 East Asian Game. In addition, EMSTF has been investing substantially in the applications of new IT and E&M technologies to enhance the engineering performance of public facilities as well as the services quality to clients.

The corporate goal of EMSTF is **“Create Public Value for the Community Betterment through Partnership with our Clients”**. To achieve the corporate goal, a Five-year Strategic Plan (2012/13 to 2017/18) (the Plan) including five corporate strategies and eighteen initiatives was devised in 2013. The Plan aims to deliver the best engineering services to the public in Hong Kong, through implementation of innovative and integrative E&M works in the public facilities, advancement of engineering practices and effective management of knowledge. The five corporate strategies are: delivering excellent service, becoming a trade model, building capacity and caring culture, enhancing knowledge management, and sustaining green operation.

2. DEVELOPMENT OF ELECTRICAL AND MECHANICAL TRADING FUND

In 1996 the Electrical and Mechanical Trading Fund (EMSTF) was established to respond to the Public Sector Reform initiatives. The trading fund concept was introduced in Hong Kong with the intention that an institutional change would provide the appropriate means and nurture a new working culture to improve services in terms of quality and cost-effectiveness.

Since its inauguration in 1996, EMSTF commits to becoming a responsive, customer-focused organization, providing better value-for-money services for the clients which cover more than one hundred Government Bureaux/ Departments and public organizations. In addition, EMSTF undertakes different business development initiatives to enhance its competitive edges, such as implementation of reorganisation and regionalisation (R&R) of operations, development of complaints management system and corporate computer system (CCS). EMSTF also overhauls E&M engineering services delivery to the general public and re-shapes the mind-set and work culture of the Department.

In pursuit of quality services to the clients, EMSTF was the first Government department to obtain the ISO-9001 Quality Management System, ISO-14001 Environmental Management System and OHSAS-18001 Occupational Health and Safety System certifications in 1999, 2000 and 2001 respectively. EMSTF was also the first public **body to win the Hong Kong Management Association’s Total Quality Management Gold Award** in 2006. In addition, EMSTF continues to excel its quality of services in different areas such as information security management and energy management. EMSTF obtained ISO27001 Information Security Management System and ISO 50001 Energy Management System in 2011 and 2015 respectively.

Under the leadership of the Executive Board and the management team of EMSTF, it operates in a well financial position. In 2015/16, the return on revenue (ROR) was 4.8% with total revenue of HK\$5,764 M. In view of the community demand on public services and the limited public resources of the clients, EMSTF commits to operating in a slim-profit model so that the clients can have more resources to better serve the community.

3. PUBLIC VALUE

EMSTF is a caring organization whereby people are the top priority. EMSTF cares about its clients, staff, and community. EMSTF always keeps in mind that the very reason for everything it does is to give people safe and pleasant experiences that contribute to **high quality of life. This is “creating public value”**.

To implement our public value, EMSTF and its staff work wholeheartedly to translate the service values into actions in fulfilling public expectations on the reliability and safety provisions of E&M facilities in public services such as hospitals, museums, and law enforcement operations etc. EMSTF also commits to safeguard the public E&M assets in supporting the high quality of living and prosperity of Hong Kong.

4. PARTNERSHIP WITH CLIENTS

EMSTF **always welcomes clients’ comments and invites them to participate in EMSTF’s activities e.g. seminars, knowledge sharing forums, new technologies briefings, etc.** EMSTF endeavours to operate and maintain clients’ electrical and mechanical assets at its optimized conditions.

EMSTF has been conducting biennially Customer Opinion Survey (COS) since 1996. The COS aims to measure **clients’ satisfaction on EMSTF’s services and more importantly to identify the area for improvement to strike for services excellence.** To ensure impartiality of the survey, EMSTF commissions Consultants to conduct **independently the COS as to measure customer feedback on EMSTF’s services and to identify areas for**

improvement. The results of the Customer Satisfaction Index (CSI) calculated from the COS (1996 to 2016) show continuous uplift in score from 60% in 1996 to 80% in 2016. Also, the CSI is significantly higher in the years from 2012 to 2016 than that in the years before 2012. The rising CSI indicates that the five strategies of the Five-Year Strategic Plan are on the right direction to create the public value for the community betterment through partnership with clients.

5. THE FIVE-YEAR STRATEGIC PLAN

The Plan consists of five corporate strategies and eighteen innovative strategic initiatives as follows:

5.1 Delivering excellent service

Under this strategy, there are five strategic initiatives: enhancing customer service; applying new technologies; strengthening asset management; enhancing outsourcing with contract management; and enhancing quality management.

To enhance customer services, EMSTF has been carrying out different client focused initiatives since its establishment in 1996 such as reorganization and regionalization (R&R) of the operations, development of central complaint registry system and implementation of client opinion survey etc.. In order to further enhance its customer services, EMSTF is going to implement a Customer Centric e-Platform (CCeP) system by phases to enhance its customer services that integrating new IT technologies and innovation E&M systems and to set up a new Customer Services Centre (CSC). The first phase of CCeP implementation focuses on maintenance job management to provide integrated real-time job related information for sharing with stakeholders using mobile devices while the new CSC will be operated with the support by CCeP and various new systems such as the Geographic Information System (GIS) and Integrated Building Management System (IBMS), etc.. The CSC and CCeP will be put in operation in 2017/18.

The business portfolio of EMSTF covers about 8,000 government buildings and facilities being serviced in Hong Kong. Some of these buildings and facilities have been commissioned to serve the community since 1970s. EMSTF has been taking actions to apply new technologies and innovation ideas to the buildings and facilities for optimising the reliability, serviceability and energy performance of E&M plants. Taking the airfield ground lighting (AGL) system in the Hong Kong International Airport as an example, in order to effectively and efficiently test and calibrate the lighting power supply equipment, EMSTF and Airport Authority have designed a testing platform to facilitate the maintenance works in indoor environment such that the working time on the busy runway and taxiways can be minimized. With its innovative, creative and practical nature, this testing platform has been patented in November 2013.

In pursuit of higher operating efficiency and optimized service conditions of E&M plant, a number of new technologies have been identified and implementing in selected venues, for example: optimization control of building cooling system; electronically commutated fans; electromagnetic induction descaling devices; and maintenance practices for aspiration smoke detection system and automatic fire suppression system etc.

In serving our clients with care and innovation, EMSTF adopts a self-developed IT application using mobile devices **to monitor work progress of outsourced maintenance works contracts i.e. "Performance Monitoring System for Maintenance Contract (PMSMC)". The PMSMC has become a contract requirement since 2013. With the adoption** of PMSMC, corrective maintenance notifications can be disseminated to contractors in real time for timely follow-up actions. Latest job status is updated via mobile devices. EMSTF supervisors can monitor the corrective and preventative maintenance jobs performed by contractors, with supporting documents and photographs taken on the premises. PMSMC is considered a cornerstone for improving the quality of records and monitoring of work progress.

Decreased operating efficiency and increased risk of breakdown frequency are common phenomenon of aging equipment which brings undesirable interruption to E&M services. To prioritize the actions on aging plant/equipment, EMSTF customizes an asset database and obtained the ISO 55001 Asset Management System certificates for a number of major E&M equipment such as airfield ground lighting system in the Hong Kong International Airport and Ambulance Fleet of Fire Services Department, etc. In the coming years, EMSTF will continue to upkeep the asset database and to maintain the asset management.

5.2 Becoming a trade model

Under this strategy, there are three strategic initiatives: developing best practices; enhancing safety; and promoting E&M trade.

To enhance service standard and to deliver reliable E&M engineering services to the community, EMSTF works jointly with all practitioners to set up a framework of recognized works practices to handle a vast variety of E&M installations. Also, EMSTF is developing general specifications for operation and maintenance of major E&M engineering service in consultation with trade associations.

EMSTF has completed the consultation with trade associations on the revamp of the safety manual about E&M engineering works. This enables both EMSTF's staff and contractors to carry out E&M works following the same practices stipulated in the manual.

With concerted efforts with trade associations and Vocational Training Council, EMSTF participates in the Hong Kong E&M Trade Promotion Working Group to promote the image of E&M trade for attracting new bloods to the E&M trade. By attracting more young people to join the trade, EMSTF contributes to the provision of new bloods to meet the needs of the local profession and poses as a trade model to the industry.

In addition, to sustain the labour resources of the E&M trade in facing aging workforce, EMSTF also invests substantially in technician trainee training programme to attract new bloods to join E&M trade. From 2016 onwards for five years, EMSTF will invest over \$600 Million on training to meet its business needs as well as the local E&M trade needs for the long term development in Hong Kong.

5.3 Building capacity and caring culture

Under this strategy, there are four strategic initiatives: building up staff competence; attracting young talent; **establishing "centre of excellence"; and strengthening caring culture.**

With technology advancement and high E&M engineering service demand, EMSTF has strong commitment to strengthen the knowledge and capacity of the workforce for building up staff competence to tackle the challenges ahead. In addition, EMSTF has been actively supporting the tertiary institutions funding application to Innovation and Technology Fund and study on new technologies.

EMSTF puts efforts on attracting more young people to pursue their career in E&M engineering through promotion activities. In the past three years (i.e. 2012/13 – 2015/16), the applications for our 3-year technician trainee training scheme and 2-year engineering graduate training scheme were increased for 14% and 65% respectively. In light of the increasing number of younger generation participation in the E&M trade through various training schemes, EMSTF will continue support the revitalization on E&M trade.

Selected EMSTF's venues have been set up as the centre of excellence (CoE) to enrich staff knowledge through practices and various training. In 2015, a total of forty-seven CoE were established to showcase the competitive edges of EMSTF on its application of new technology and innovation practices in delivering of E&M services.

Under EMSTF's caring culture, staff opinions are always taken into consideration in formulating policies. All tiers of workforce i.e. frontline, middle management and top management are invited to participate in management activities e.g. annual workshop for developing the strategic initiatives, annual communication forum. In addition, self-operated engineering programmes with **Qualification Framework (QF) recognition are offering to EMSTF's technician trainees and the workforce.** Staff can develop their skills in a systematic way which aligned with the industry standard.

5.4 Building capacity and caring culture

Under this strategy, there are three strategic initiatives: enhancing knowledge communities; enhancing knowledge management-platform; and updating policy manual.

It is necessary to develop learning and knowledge sharing culture. EMSTF is committed to sharing knowledge with trades and clients through seminars, conferences and meetings. Knowledge transfer will enrich knowledge management of stakeholders which will eventually enhance the E&M engineering service providing to the community. In 2016/17, EMSTF arranged 14 knowledge sharing events and forums under different engineering themes, attracted over 2,000 attendees. The various knowledge management interest groups also planned to conduct about 50 sharing sessions with an estimated turn up rate of 1,000 attendees.

Knowledge management system supporting knowledge capture, retention, sharing and re-use is important for improving productivity, efficiency and cost effectiveness of E&M services. These strategic initiatives involve the cultural change on managing knowledge and the behaviour change on sharing expert knowledge within EMSD. We also integrated knowledge management activities in our critical business processes and reference document e.g. policy manual, enabling staff to acquire the needed knowledge in a more effective and efficient way than before thus shortening the time to competency.

Knowledge management is vital to capacity building as well as quality and productivity improvements. It also helps us document and share knowledge, enabling us to make the right decisions and stay at the forefront of the fields of engineering and management. EMSTF shall continue to improve and promote various knowledge management tools. In addition, EMSTF shares new and emerging technology with trade practitioners through technical seminars, forums and meetings so that the E&M trade as a whole will benefit from the actions on knowledge transfer.

5.5 Sustaining green operation

Under this strategy, there are three strategic initiatives: adopting green measure; promoting good practices; and supporting green building.

To combat climate change, EMSTF focuses on developing Hong Kong to become a smart and low carbon city. Energy savings through green measures is the priority of EMSTF. Control of energy consumption by buildings, optimizing E&M plant operation and adopting energy saving technologies are core elements for the smart and low carbon city development.

In collaboration with universities and the E&M trades, EMSTF has carried out pilot projects on green engineering measures such as adopting retro-commissioning practices, and developing control algorithms on the operation of major E&M plants of selected government buildings to optimize energy performance. The skills and engineering practices learnt from the pilot projects have developed good practices on green operation for sustainable development of the community.

Taking the lead by example, EMSTF supports the sustainable operation and maintenance of existing buildings. To strive for sustainable development, EMSTF adopts various green technologies in EMSD Headquarters, which was **the first Government building awarded the Platinum Rating of the HK BEAM Plus on “Existing Building” and “Neighbourhood” presented by the Green Building Council in 2016. The EMSD Headquarters demonstrated the potential contributions of existing buildings in Hong Kong towards the development of low carbon and sustainable city such as energy saving, water saving and waste reduction.**

6. CONCLUSION

EMSTF has been growing steadily and serving the clients with care and innovation. The five year strategic plan set out in 2013 provides a high level directive to strive for service excellence to clients with care and innovation.

With the vision of “Create Public Value for the Community Betterment through Partnership with our Clients”, EMSTF works collaboratively with E&M trades and universities in implementing the Five-year Strategic Plan, including the five corporate strategies and the eighteen strategic initiatives.

The results of the customer opinion surveys conducted from 1996 to 2016 shows that the clients are satisfied with EMSTF services with increasing trend of score with the highest score in 2016. It indicates that the five corporate strategies are on the right direction to deliver excellent services to the clients.

With the implementation of various strategic initiatives, EMSTF will become more customer focused, advancement in adoption of new technology and innovation practices and capable to combat climate change in supporting the low carbon and smart city development.

APPENDIX



Graphic presentation on the results of customer opinion survey 1996 to 2016

REFERENCES

- [1] Information in EMSD Website on 20th Anniversary for EMSTF (<http://www.emsd.gov.hk/en/20Anniversary/>), Electrical and Mechanical Services Department, HK SAR Government

Project Manager's Role in Sustainable Building Projects: A Case Study in Canada

Ricardo Ferreira LEOTO^a, Gonzalo LIZARRALDE^b

^a Faculté de l'Aménagement, Université de Montréal, Canada, ricardo.ferreira.leoto@umontreal.ca

^b Faculté de l'Aménagement, Université de Montréal, Canada, gonzalo.lizarralde@umontreal.ca

ABSTRACT

It is estimated that the building sector, and its significantly fragmented industry, is responsible for 25% of waste generation, 40% of energy consumption, and 30% of greenhouse gas emissions. Not surprisingly, increasing attention toward sustainability and the reduction of fragmentation has led building sector stakeholders to implement alternative design methods and tools such as Integrated Design (ID). There remains, however, a disconnect between the often-ambitious objectives identified in the early phase of sustainable projects and the actual results achieved in the operation phase. This paper explores the role of project managers in ensuring that project and process fragmentation are reduced and that the sustainability goals set by the design team are effectively achieved.

The case study of a Canadian project (certified LEED-Platinum) helps us examine the success factors, optimization potentials, and shortcomings of project managers' role in the sustainable building process. The empirical data, which includes extensive documentation of the design, build and operation phases, LCA analyses and interviews, help us analyze the processes and stakeholders' interest and expectations. The results show that adopting ID in the design phase alone is not able to reduce fragmentation in following phases (notably without changes in the role of the project manager). From a theoretical point of view, these results highlight the importance of project management practices in integrating stakeholders, information, and knowledge in the age of sustainable development. From a practical point of view, they reveal opportunities to strengthening project managers' role in sustainable projects.

Keywords: green building management, integrated design process, sustainable buildings.

1. INTRODUCTION

The importance, socially and economically, of the construction industry in Canada, is significant: it represents 6% of Canada's gross domestic product (GDP) and 7.3% of employment. By contrast, environmentally, the sector is responsible for 25% of waste generation, 40% of energy consumption, and 30% greenhouse gas (GHG) emissions (StatCan, 2013). Both theory and practice show us that the traditional silo-type, linear, and fragmented design process are a significant barrier to the implementation of improvements in the built environment (Leoto et al., 2014; Magent, 2005).

However, the increasing focus on sustainable development leads clients and construction industry professionals to find new modes of operation to answer the new society's aspirations (Bonham, 2013). Green building certifications emerged in the 1990's as a methodological framework to diminish the negative impacts of the built environment on nature and human health (Ding, 2008; Berardi, 2012). These certifications propose, for example, alternative design methods such as Integrated Design (ID) to improve the environmental performance of buildings.

There remains, however, significant gaps between the sustainable building expectations at the design stage and the actual, subsequent performance. Regarding energy consumption, research shows that almost 90% are not able to reach the goals, and among them, 35% use more energy than their conventional counterparts (Newsham et al., 2009). The gap can also be verified in aspects such as comfort, overheating, cold spots, high levels of air movement, acoustics, material durability, indoor air quality and water consumption (Bartlett et al., 2014; Goodhew, 2016).

The objective of this paper is to explore the role of project managers in ensuring that project and process fragmentation are reduced and that the sustainability goals set by the design team are effectively achieved. The main challenges, as well as important opportunities for improvement in sustainable projects, are identified. A review of the literature on the fragmented nature of the construction industry and Integrated Design (ID) are presented in

the first section. In the second section, the case study is presented by highlighting the qualitative results obtained from the analysis of documents and interviews. Finally, the discussion section presents the practical and theoretical implications of the findings, their transferability, and their limits.

1.1 Fragmented nature of the construction industry

The process of designing, constructing, and managing buildings is fragmented. The construction industry still **applies the “over-the-wall” approach (Evbuomwan and Anumba, 1998) involving many participants interacting in complex ways over a prolonged period of time (Kalay et al., 1998)**. This process leads to a conflict between the expected and the actual project quality, which then results in buildings that operate below their optimum potential (Jayasena and Senevirathna, 2012).

In the design phase, for example, sequential communication among the participants is the norm: structural design does not begin until completion of architectural drawings with both needing to be completed before mechanical systems design begin, and subsequently for the other professionals (Kalay et al., 1998). In this context, meetings can occur but, in fact, they are only for coordinating purposes (Cole et al., 2008). The design deliverables of each specialty are separately prepared by each professional or firm and assembled at an advanced stage of the process.

In the following project phases, members of the project teams often change, thus increasing fragmentation in the process. Four different types of fragmentation occur during the construction process: (i) design project fragmentation; (ii) procurement fragmentation, (iii) construction industry fragmentation, and (iv) labour fragmentation at construction sites (see Table 1).

Design project fragmentation	The disjointed and sequential character of traditional design practice as well as the increasing specialization of roles lead to sub-optimal solutions, poor constructability, and operability. (Huovila et al., 1997).
Procurement fragmentation	Conventional procurement methods and contracts create adversarial relationships between parties reinforcing socio-cognitive barriers that hinder team efficiency and collective search for new ideas (Forgues and Koskela, 2008; Mossman et al., 2010).
Construction industry (CI) fragmentation	Construction industry is largely composed of a vast number of small and medium enterprises that work together for only short periods of time (Mossman et al., 2010). Also, we can verify strong division of labour, poor coordination among project participants, and significant amounts of subcontracted work (Van Nederveen et al., 2010; Gottlieb and Haugbølle, 2013).
Labor fragmentation at construction site	Accreditation for workers in construction (Canada since 1969) has fragmented the workforce by trade, sector, and geographic area. High-specialized labour with growing numbers of trades (152 different required skills in total) delay the process and increase the price of construction (Globe-Advisors, 2013; Lizarralde, 2008). In Quebec, 23 trades are recognized and regulated.

Table 1. Forms of fragmentation in the construction sector.

1.1 Integrated design (ID)

ID emerges in the 2000's as an alternative to design high performance buildings (Roundtable, 2007). ID proposes a simultaneous participatory process that brings together interdisciplinary experts and stakeholders (professionals, builders, experts, users, and owners) through intensive work sessions (dubbed design “charrettes”) during the early phases of project design (Ghassemi and Becerik-Gerber, 2011). Green building certifications foster ID adoption in believing that decisions taken collectively can reduce fragmentation and enhance industry efficiency to deliver sustainable projects (Forgues and Koskela, 2009).

ID involves a holistic approach that relies upon every member of the project team working collaboratively to implement sustainability goals. The team is called to consider, for example, the whole life cycle of the building, not just the initial capital investment in construction (Rekola et al., 2012). By developing and sharing new knowledge, all stakeholders generate added value in the process and to the final product (Jayasena and Senevirathna, 2012).

1.2 Project management challenges in sustainable building

The adoption of sustainable goals and ID process increasingly challenges project managers (PM). Firstly, they now join the team since the early stages of the project and not only in the pre-construction phase (as per the norm)

when the design project is already defined (see Table 2). **Secondly, the PM's role is enhanced, called to collaborate** in the integration of design and construction, thus helping to improve constructability and the implementation of sustainable goals (Tatum, 1987). Whereas previously PM goals focused on cost, schedule, and quality, sustainable **design introduces low energy consumption, users' health, waste and pollution reduction**, and environmental protection among other objectives (Vanegas et al., 1995; Bonham, 2013).

The PM in a sustainable project is now invited to participate in all "charrettes", being not only responsible for defining goals with the team but also insuring that targets will be met, for example, by selecting materials and systems according to the performance criteria by insuring that the final building design has lower impacts than a reference building. Besides that, certifications normally focus on rating systems and green targets, obliging PM to pay more attention to technically related issues during the construction phase to reach the green goals that include energy efficiency, site management, waste management and using environmentally friendly materials (Delnavaz, 2012; PMI, 2004; Herazo and Lizarralde, 2015).

Key work stages	Planning		Design		Procurement			Construction			Operation	
Traditional project management					←————→							
Detailed work stages	Appraisal	Design Brief	Concept	Design Development	Technical Design	Contractual documents	Tender Documentation	Tender Action	Site preparation	Construction to completion	Documentation commissioning	Post-practical completion and operation
Project management in sustainable buildings	←————→											
Key phases in sustainable building	Sustainable building design				(Integrated Design)			Sustainable construction			Sustainable Building operation	

Table 2. Comparing project management role in a building process (adapted from Delnavaz (2012)).

2. RESEARCH METHODS

We adopted a qualitative research approach, more specifically a case study approach "that investigates a contemporary phenomenon within its real-life context" as suggested by Yin (2003, p. 13). The case study of the Centre for Sustainable Development (CSD) was chosen because it fulfils the requirements previously identified: a) adoption of a green building certification (LEED®), b) a project that aims at being a social and environmental innovation hub, c) a project that adopted ID, LCA, and BIM, and d) full access to data, reports, and stakeholders.

We collected and analyzed primary data, including 13 integrated design reports, 23 emails, two contractual documents, construction schedules, photos, the web page of the CSD, two conference videos, LCA reports, energy simulations, and six press releases. The second step included more than ten visits to the project site during its construction and operation phases as well as nine semi-structured interviews with professionals, clients, and stakeholders involved in all project phases of ID.

3. RESEARCH RESULTS

Stakeholders' collective engagement with common values: The ID process needs a "champion" to coordinate efforts to successfully explore innovation potentials (Nam and Tatum, 1997; Lizarralde et al., 2012). In this project, the "green champion" chosen was one of the client's representatives who also acted as a facilitator during the project "charrettes". The champion's legitimacy, however, was not recognised by other stakeholders. Given increased tensions, the client decided to fire him. It is only at this moment, and after the sixth meeting, that the client finally decided to hire a PM to join the team and to ensure the role of facilitator in ID charrettes. In practice, documents show it was actually the architects who took the facilitating role instead of the PM, and meetings became rather conventional.

Increase in task complexity: CSD involved all stakeholders in ID “charrettes” since the early phases of the project, including the design team, contractor, PM, experts, client and users. Green certifications imply an increase of task for all professionals, including PM. All decisions now need not only be decided based on cost but its impact on the environment and energy consumption. Some tools used in CSD project to support designer’s decisions are: (i) ATHENA® Impact Estimator for Buildings v5.10102 for materials impacts, and (ii) EE4v1.7-2 for energy consumption calculation. We notice that, because the client was an environmental NGO organisation, decision making was even more complex due to the fact that its goal was not just to obtain green certification but to “do the right thing”, that is to give an example for others.

Increase in time required in the designing phase: in 2006, when this ID process took place, no consensus existed on how to operationalize “charrettes”. The stakeholders participated to 14 charrettes, where only seven were planned in the initial schedule. In fact, documents show, and the interviews confirm, that waste in the design process hid both innovation and collaboration. One architect contends that “the meetings were too long (some lasted more than 8 hours), and without a break between them to give us time to work on the data”. The client reveals a possible reason for this problem: “[even though] the level of participation was significant, the preparation and organization of meetings and work during the session’s ID could be pushed a little further”.

The operation is a key phase: In green buildings, the documentation and the commissioning phase are vital for optimizing the building’s overall energy performance and to ensure that the building is operating as designed. Normally the PM’s and the design team collaborate in the commissioning process, one requirement to obtain green certifications. However, actual data from building and operation problems show that design teams fail to transfer their knowledge to the building’s new stewards (owner, occupants, and operation staff). Because the goal of green buildings is to reduce construction impact over their entire life cycle, this study compares targets defined during ID charrettes with actual data measured over four years’.

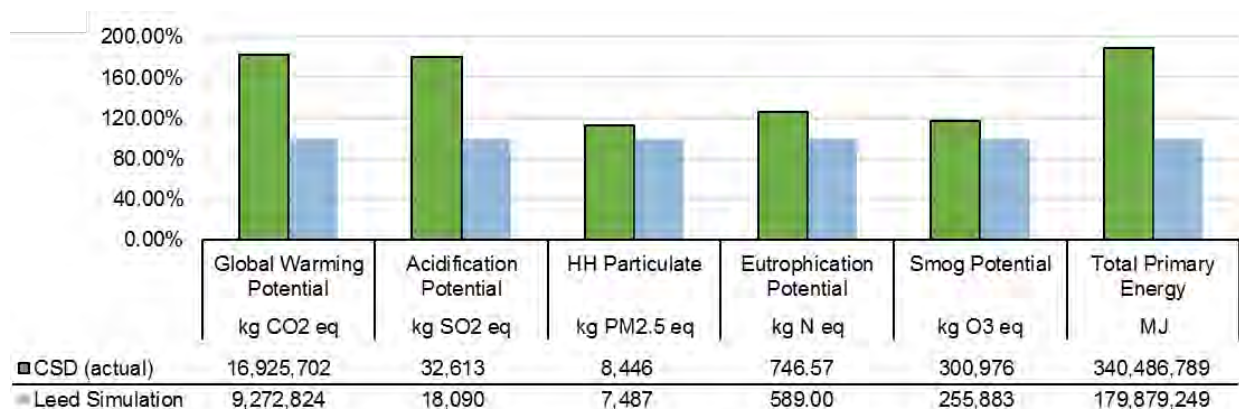

Figure 74: impact scores for LEED simulation and actual consumption in CSD

The LCA tool called ATHENA® Impact Estimator for Buildings was used to compare CSD actual consumption (electricity and gas), between estimated values defined during the design phase and LEED energy simulation document (see Figure 1). Results indicate that CSD has a bigger impact on the environment than expected. Moreover, Table 3 shows that even if CSD used less energy (four years’ measurements) compared to Reference Building, it never achieved the project goal defined in the LEED energy simulation document.

	Reference Building	LEED simulation	2012	2013	2014	2015
Electricity (Kwh)	1,121,928	721,954	1,390,333	1,391,386	1,512,092	1,323,251
Gas (m3)	113,645	4,206	10,644	29,046	25,223	3,084

Table 3. Comparative between LEED Energy simulation and real consumption in the last four years.

4. DISCUSSION AND CONCLUSIONS

This paper explored the role of project managers in sustainable buildings and summarized a comprehensive case study in Canada. ID, commonly used in sustainable projects, promises to reduce fragmentation in the design and

consecutives phases. While this paper identified several project manager's challenges and opportunities in sustainable buildings, we recognize that other factors can also be relevant and deserve to be thoroughly studied. Further research can explore how new tools can assist the PM, for example, building energy simulation, BIM, and communications software.

Results show that, even if fragmentation in the design phase is reduced, it still occurs during the construction process and the operation phase. Nevertheless, this case study identified main challenges, as well as significant opportunities, for PM's to reduce fragmentation and to improve the sustainable performance in buildings. Firstly, the PM and the key members of the project team need to be hired early **in the project's feasibility stage. The PM** has the responsibility for building teamwork by the same values. The early development of a sense of common goal can increase the willingness of the parties to collaborate and achieve sustainability goals. Being the first professional to be hired and the last to leave the project gives the PM an opportunity to build links between phases and professionals.

Secondly, the PM needs to assist the client by organizing project design "charrettes" and the proper use of new tools and techniques related to sustainable goals. New tools include, for example, Life Cycle Analysis (LCA) to measure the impacts of design approaches, technical solutions, and materials. To better guide his/ her decisions, the PM needs to be better prepared to the new challenges and complexity facing sustainable buildings projects. Furthermore, improving ID design "charrettes" can improve the design process and diminish the team members' impression that they were "wasting their time."

Finally, the project team led by PM needs to follow the operation phase of the building. This case study indicates that, even if all the team participated in the documentation and the commissioning phases, it was not enabled to successfully transfer project knowledge, or either unable to anticipate future issues. In this case, the PM can collaborate in overcoming this weakness by extending its participation in the project during the operation of the building (see Table 2) during at least the first four years. In this sense, the PM cannot only ensure transfer knowledge but can also support new stewards with possible issues or optimizations. By reducing the four levels of fragmentation identified above, construction projects can have a more positive impact on society and the environment. This is a major task for the construction sector, in which project managers can play a significant role **that goes beyond the implementation of technical solutions, and which requires social and "soft" skills.**

ACKNOWLEDGMENTS: The Authors would like to acknowledge the financial support of the Canadian MITACS-Accelerate Ph.D. Fellowship Program

REFERENCES

- [1] Bartlett, K., Brown, C., Chu, A.-M., Ebrahimi, G., Gorgolewski, M., Hodgson, M., Issa, M., Mallory-Hill, S., Ouf, M., Scannell, L. & Turcato, A. 2014. Do our green buildings perform as intended? [Online].
- [2] Berardi, U. 2012. Sustainability assessment in the construction sector: rating systems and rated buildings. *Sustainable Development*, 20, 411-424.
- [3] Bonham, M. B. 2013. Leading by example: new professionalism and the government client. *Building Research & Information*, 41, 77-94.
- [4] Cole, R. J., Robinson, J., Brown, Z. & O'Shea, M. 2008. Re-contextualizing the notion of comfort. *Building Research & Information*, 36, 323-336.
- [5] **Delnavaz, M. 2012. Project Managers' Role in Sustainable Building Process. master, Chalmers University of technology**
- [6] Ding, G. K. C. 2008. Sustainable construction: The role of environmental assessment tools. *Journal of Environmental Management*, 86, 451-464.
- [7] Evbuomwan, N. F. O. & Anumba, C. J. 1998. An integrated framework for concurrent life-cycle design and construction. *Advances in Engineering Software*, 29, 587-597.
- [8] Forgues, D. & Koskela, L. J. 2008. Can procurement affect design performance? *Journal of Construction Procurement*, 14, 130-141.
- [9] Forgues, D. & Koskela, L. J. 2009. The influence of a collaborative procurement approach using integrated design in construction on project team performance. *International Journal of Managing Projects in Business*, 2, 370-385.

- [10] Ghassemi, R. & Becerik-Gerber, B. 2011. Transitioning to Integrated Project Delivery: Potential barriers and lessons learned. *Lean construction journal*, 2011, 32-52.
- [11] Globe-Advisors 2013. *BC Residential Construction Industry Profile Study Vancouver, BC*, Globe Advisors.
- [12] Goodhew, S. 2016. *Behaviour, sustainable construction, and the performance gap. Sustainable Construction Processes*. John Wiley & Sons, Ltd.
- [13] Gottlieb, S. C. & Haugbølle, K. 2013. Contradictions and collaboration: partnering in-between systems of production, values and interests. *Construction Management and Economics*, 31, 119-134.
- [14] Herazo, B. & Lizarralde, G. 2015. The influence of green building certifications in collaboration and innovation processes. *Construction Management and Economics*, 33, 279-298.
- [15] Huovila, P., Koskela, L. & Lautanala, M. 1997. Fast or concurrent: the art of getting construction improved. *Lean construction*, 143-159.
- [16] Jayasena, H. S. & Senevirathna, N. S. 2012. Adaptability of Integrated Project Delivery in a Construction Industry. *World Construction Conference 2012, Global Challenges in Construction Industry*.
- [17] Kalay, Y. E., Khemlani, L. & Choi, J. W. 1998. An integrated model to support distributed collaborative design of buildings. *Automation in Construction*, 7, 177-188.
- [18] Leoto, R., Herazo, B. & Lizarralde, G. Limits and scope of innovation and collaboration in integrated design practices. *UIA 2014, August 3-7 2014 Durban, South Africa*.
- [19] Lizarralde, G. 2008. Building abroad procurement of construction and reconstruction projects in the international context : colloque-atelier, 25-28 octobre 2008.
- [20] Lizarralde, G., Viel, L., Bourgault, M. & Drouin, N. Who collaborates and innovates in architecture and urban design projects? *Engineering, Technology and Innovation (ICE), 2012 18th International ICE Conference on, 2012. IEEE*, 1-11.
- [21] Magent, C. S. 2005. *A process and competency-based approach to high performance building design*. Ph.D. Philosophy, The Pennsylvania State University.
- [22] Mossman, A., Ballard, G. & Pasquire, C. 2010. Lean project delivery: Innovation in integrated design & delivery. *Architectural Engineering and Design Management, Special issue on integrated design & development systems*.
- [23] Nam, C. H. & Tatum, C. B. 1997. Leaders and champions for construction innovation. *Construction Management and Economics*, 15, 259-270.
- [24] Newsham, G. R., Mancini, S. & Birt, B. J. 2009. Do LEED-certified buildings save energy? **Yes, but....** *Energy and Buildings*, 41, 897-905.
- [25] PMI 2004. *A Guide to the Project Management Body of Knowledge*, Newtown Square, PA, Project Management Institute.
- [26] Rekola, M., Mäkeläinen, T. & Häkkinen, T. 2012. The role of design management in the sustainable building process. *Architectural Engineering and Design Management*, 8, 78-89.
- [27] Roundtable, B. G. B. 2007. *Roadmap for the Integrated Design Process Part One: Summary Guide*. BC Green Building Roundtable, Vancouver, BC, Canada.
- [28] Tatum, C. B. The Project Manager's Role In Integrating Design And Construction. In: Institute, P. M., ed. *Proceedings of the 19th annual seminar/symposium, 1987 Milwaukee, Wisconsin U.S.A.* Drexel Hill. Project Management Institute.
- [29] Van Nederveen, S., Beheshti, R. & de Ridder, H. 2010. Supplier-Driven Integrated Design. *Architectural Engineering and Design Management*, 6, 241-253.
- [30] Vanegas, J. A., DuBose, J. R. & Pearce, A. R. Sustainable technologies for the building construction industry. *Proceedings, Symposium on Design for the Global Environment, 1995*.
- [31] Yin, R. K. 2003. *Case study research: Design and methods*, Sage.

A Study on Green Industry Project Construction Experience

ZHANG Wei^a, WANG Hui^b

^a Bulter (Shanghai) Inc., Mainland China, wayne.zhang@bluescopesteel.com

^b BlueScope Building System (Xi'an) Co., Ltd., Mainland China, lisa.wang2@bluescope.com

ABSTRACT

China is faced with a heavy pollution issue while industrialization process. Millions of manufacture factories had been built every year discharging waste water, exhaust gas and useless solid material. Construction industry as one major polluted source was focused by China government more and more. Green building solution was encouraged to use for all types of building in last five years. But finally only 1% manufacture plant had been built following green label standard due to less of incentive policy and self-motivation. Most plant owners who are facing severe competition and survive pressure in China market do not willing to spend money and time for environment protection.

This paper summarizes a case study on an industrial project in China. Buildings in this project obtained both China 3 stars Green Building Label and US LEED Platinum (office) & Gold (factory) Certificate. The author involved in whole practice wishes to share experience from planning, design, construction, commissioning to operation process. Base on characteristics of factory building, an appropriate green building developed strategy is evidently helpful for green practice to balance performance, investment and payback period.

Keywords: integrative process, portfolio, commissioning

1. PROJECT INTRODUCTION

China now becomes a real world manufacture centre with huge capacity on multiple products. Year by year, millions of manufacture factories had been built all around country (550M SQM factory was built in 2015). Meanwhile, the pollution during the production process heavily influenced human living environment and sustainable development of the industry. Since 2015, the green development had been affirmed as one of five main strategies by China government and construction industry as one major polluted source was quite focused. The green building concept had been adopted broadly and the number of projects rapidly increased in the last 5 years. By the end of year 2016, 4221 projects got Green Label certificate but only 44 of them were industrial projects. The reason is not only because less of incentive policy but also complicate production environment in different industrial sectors.

Located in Xi'an High-tech Industry Development Zone (XHTZ) with a total construction area of 50,000 square meters occupying 190 Mu of land, **BlueScope Buildings (Xi'an) Co. Ltd.** consist of Admin office, manufacture plant, ancillary office, and raw material warehouse that all were built of steel structure was under construction from May 2012 to June 2013 then fully operated since July in the year. The project was successfully achieved all construction targets especially on green feature. It achieved LEED Platinum certification for Admin office and LEED Gold certification for the workshop. Meanwhile it became first 3 stars green design label in China and green demonstration project by Ministry of House and Urban-Rural **Development of the People's Republic of China** (MOHURD). Furthermore the project certified as Green Construction demonstration project in 2013 and Green innovation award in 2015 by MOHURD again.

The project has very outstanding feature to realize entire green process which can rarely find among most green projects. It needs set a green target in pre-design stage, executed through design and construction, enhance commissioning by third party, operated with data collection and monitor system. With around RMB 10M incremental green cost, more than twenty green techniques selecting by owner, consultant and design institute was implemented. As calculation, the incremental investment can be returned back within six years. The below content in this article will give you full penetration of this project case.

1.1 Economic target

As a manufacture company, it is priority to control the investment tightly to achieve lower cost base for future factory operation. Even consider to achieving higher green level, the project team chose every technique carefully **above bottom line which its return period should be less than eight years. Meanwhile one “Cost and Benefits”** model was used to help on decision making, e.g. see Figure 1. It identifies right sequence from bottom to top visually which should use passive technology as priority, then active technology. And the renewable energy should be used rarely because big investment and relative small return. For instance, improving building envelope performance which belongs to passive technology only cost little money but can get quite huge improvement on energy saving.

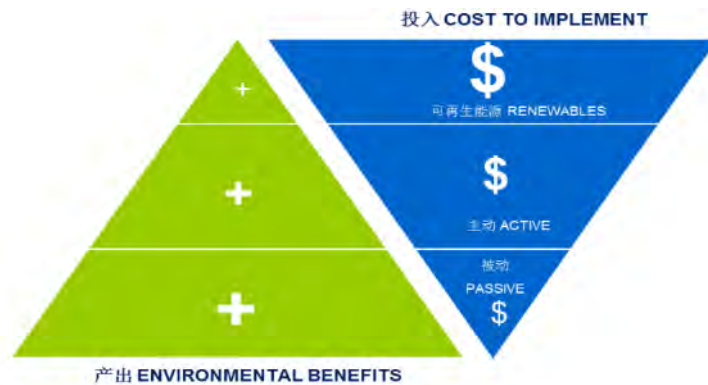

Figure 1: Environmental benefit vs. Cost to implement

1.2 Environmental protection

Minimum environment influence from production process is a basic requirement for green plant. The project team needs to identify any small pollution possibility caused by solid waste, water discharge, and exhaust gas emission. In this case, the solid waste such as steel scrap was stored in a special shed which far from production area and **sold to third party for recycle purpose. The waste water only comes from worker's shower room was collected,** filtrated and disinfection in a set of containers. The recycle rate was calculated as 42% yearly. The exhaust gas causing by welding and painting process was gathered and burnt in a special container to achieve national gas discharge standard. Any environment incident will be reported monthly to senior leader team of the company.

1.3 Social commitment

To realize sustainable development, corporate social responsibility will be final measured by social community. A big residential community just locates cross the road of this project. The equipment noise could heavily influence **people's life as well. So the project team had to identified the noise source and put it as far as possible from** inhabitant at schematic design stage. Then the master plan can be laid out properly even the gate of factory **can't** face to residential building. Internally, the noise can also hurt the hearing ability of the workers in the long period. Certain noise reduction action had been taken such as perforated panel on the ceiling and rubber padding block under the equipment.

2. INTEGRATIVE PROCESS

Integrative planning involves group people who expert in different aspects can maximum opportunity for cost effective adoption of green design and construction strategy, emphasizing human health as a fundamental evaluative criterion. Conclusion from this practice, any project should identify the main resource consumption in production activity and the local characteristics include weather condition, local plant and material resource, etc. The diversity of the team members did support to discover more synergy strategies and review carefully on trade-off strategies. Thus the negative impact was eliminated from whole green portfolio. For instance, good day lighting design will cause more indoor heat and glare.

2.1 Water efficiency

Rain water collection and bath water recycle techniques are both used in this project. Rain water is free and clean **resource can generate from factory's roof which is large enough normally. The bath water is more stable source** relatively to fill in the tank. In the design, two kinds of water are collected separately but come together used for irrigation and some cleaning purpose. As synergy strategy, rain water collection can help to reduce runoff volume and make water balance on site. The water collected from bathroom need be purified with recycle facility cost little but reducing the waste water discharge to environment. Meanwhile all water used for landscape, irrigation, and cleaning purpose can contribute on cost saving, more important to save precious natural water. The whole water collection system in the factory with recycle concept can be described as below picture, e.g. see Figure 2.

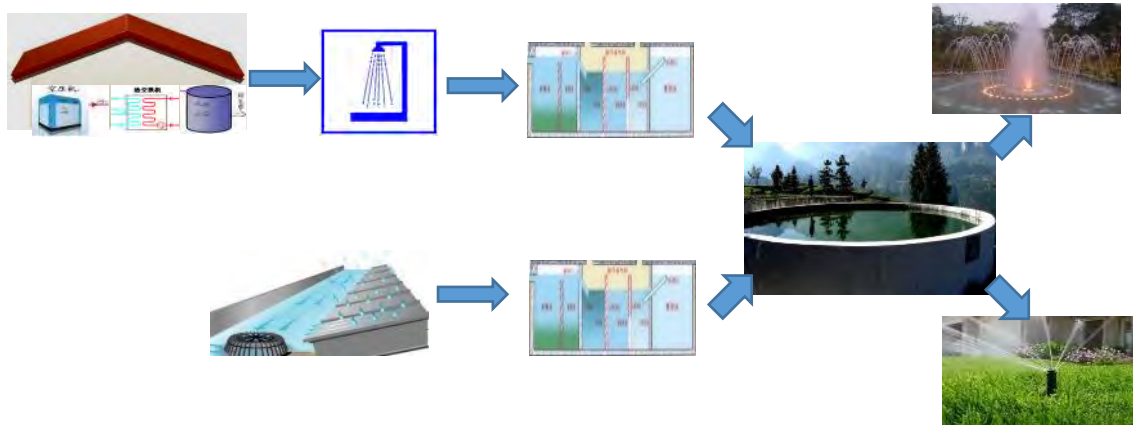

Figure 2: Water recycle process

The Figure also shows the shower water is heated by waste heat generated from equipment during the manufacture process. There is a good synergy to reduce both energy consumption on heating and heat emission to the atmosphere at same time.

2.2 Air-condition system

Ground source heat pump system had been selected based on good test result of the site soil. The struggle issue is what kind of air-condition system should be fitted for admin office around 6000 SQM. Variable Air Volume system was suggested by consultant company as new popular solution for energy saving. VAV system could adjust the supply air volume automatically according to the indoor heating and cooling load that can save AHU power consumption during partial load time and to control the temperature of each zone separately. The main weakness is also very obviously for this system include system noise, less of fresh air and bigger initial investment on equipment. Fan Coil Unit is another choice as traditional way design for office which can be controlled by occupant with different comfortable sensation. The problem is higher maintenance cost on complicate FCU system and condensation at air outlet. The expert group, owner and design institute had strong debate on these two systems. Finally FCU plus fresh air system was chosen consider the office is an open space without big heating or cooling load variation at working time since office staff usually start and end working at same time. Furthermore FCU system can save initial investment tremendously, easy to find maintain resource in a manufacture factory and condensation can be avoided if package the insulation well on the pipe system.

2.3 Energy saving portfolio

Air condition optimization is main part in energy saving pie in most projects. The other energy saving strategy, however, should not be neglected in green building design. Up to 40% energy saving target was made in this project, thus the project team needs define contribution from building envelope, glass of windows, exterior and interior lighting, day light control, variable frequency drive pump, heat recovery and solar water heating system. Some strategy even only counts less than 1% but still used to accumulate to big proportion, e.g. see Figure 3. The energy simulation model was built in Designbuilder software indicating the separate saving percentage of heating, cooling, lighting, and power system. In practice, the designer and consultant always prefer to choose new technology, product and material. The owner especially for manufacture industry, need balance on additional cost with the real benefit output.



Figure 3: Energy saving contribution by green strategy

3 CONSTRUCTION AND COMMISSIONING

Construction to realize all design intent is not easy especially for green technique. That's why only around 5% projects will get green operation label award after got design certification. Generally it is many and miscellaneous trifles job and could lead to even schedule delay. In this case, a small green construction office had been established on site to focus on daily green job. Most construction supervisors were trained several times on relative green knowledge before construction commenced.

Commissioning classified as fundamental and enhanced commissioning stages. Normally the fundamental commissioning will be done right after construction but enhanced commissioning need invite third party to complete by experienced people. An enhanced commissioning contract was signed which covered air-condition, electricity, pipe system, pump, envelope, training, etc. It allows the commissioning authority can involve in design and construction stage to deep understood project requirement.

3.1 Environmental site assessment

Many construction sites may contain contaminants that could harm the health and well-being of future occupants. It even will damage company reputation and devalue the land when the factory needs to be sold to others with unexplained contaminants issues. The soil and underground water was sampled and sent to certified laboratory in Shanghai for testing. Unfortunately the hexavalent chromium was detected at that time in the underground water at South-west corner of project land. Meanwhile approximately 6 m² oil stain area was found at North-east portion. Then the phase II environmental assessment needs to be implemented with 12 wells to pick more soil and water sample in different portion of the land. The purpose is to identify the distribution map of heavy metal.

The treatment process last about 3 months to fill clean water through the wells to dilute the concentration of the contaminant. The monitor data shows the chromium concentration was dropped but rebound again after stop water filling. The project team decide to leave this corner out of the boundary and keep monitor well for future action. The oil contaminated soil around 4 meters deep was evacuated and treated by a licensed hazardous waste treatment vendor.

3.2 Construction management

The construction activity not only produces light pollution and noise to neighbouring property but also make soil erosion, waterway sedimentation and airborne dust on site itself. The green construction plan has been made in advance by green construction office and many new initiatives were created during brainstorming meeting among owners, construction team, design institute and consultant. For example, the site discharge pipe system used to be laid down at last. Now it becomes first step of construction to ensure it can used for site rainwater and domestic sewage management during construction period; the temporary landscape and waterway can better control raising dust, e.g. see Figure 4; the waste material was gather by different category, e.g. see Figure 5; the proper boundary

wall and buffer zone were set up to control the mud fluid. Especially the construction road was built as same standard as formal factory road without surface course. The road surface will be final paved after most construction activity completed. The new method reduces solid waste when the temporary construction road is demolished as traditional way. With same methodology, the temporary construction office right locates on storage yard of the factory. The ground of the office had been built according to heavy load storage standard at beginning to avoid reconstruction. Moreover the construction team can save cost both on abolish temporary road and waste material recycle.



Figure 4: Temporary plant and waterway



Figure 5: Waste material collection

4. OPERATION MANAGEMENT

At operation stage equipments need to be well maintained to keep running well to generate return to owner. A small green facility group is responsible for observing parameter and recording the daily data in this project. They can monitor any problem happen tracking by a data collection system covering every meter which can transfer data automatically. On the other hand, occupants training for behaviour change will become headache and long term job by this group. In real case, people open the windows as while as using the air-condition system; use electrical lighting when it is sunshine. So the actual performance results of green building maybe far behind the **design objective if don't focus on daily operation management in detail.**

4.1 Indoor environment

Like most factory air-condition was not installed in the manufacture workshop. To avoid high temperature in summer and too cold in winter, the envelope design becomes very important part. The project team use reflection painting on the roof to reflect sunlight and also use 150mm thick fibreglass insulation to reduce heat penetration at day time. Hard thermal block was used at everywhere when insulation was compressed due to fixing on structural components. The windows and a small piece of curtain wall was tested to meet coefficient of heat transfer lower than 1.8. Actually natural lighting skylight on the roof was used for interior day lighting instead of setting more windows on sidewall.

Two temperature meters were installed both inside and outside factory to measure the actual temperature difference. The statistic shows the highest indoor temperature was 32.5 degree while outdoor is above 42.7 degree **in summer, e.g. see Figure 6. It's quite successful result since 33 degree is critical point that people will be sweaty and influences their working efficiency as while.** To provide comfortable indoor working environment was another basic task for green industrial building.

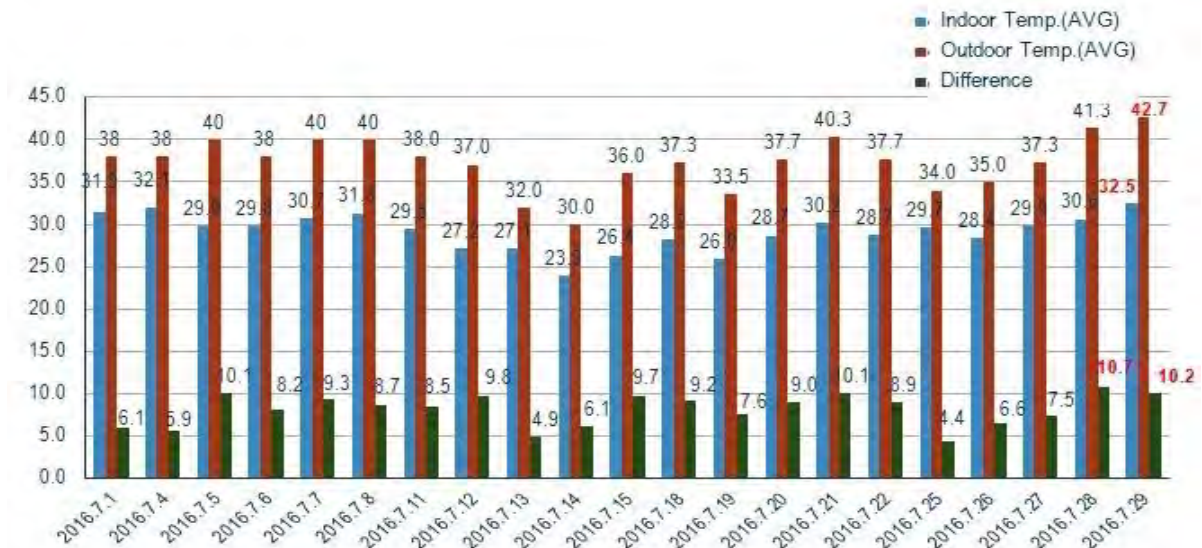

Figure 6: Indoor and outdoor temperature difference

4.2 Data collection and analysis

Both building-level and system-level metering system was constructed and working continuously to collect operation data in this project. All data was sent to specified computers and synchronously show on monitor screen. The system can also generate daily, monthly and annual report as required. Any leakage or damage issues will be identified quickly by facility maintenance team base on abnormal data. It also provides possibility for the team to find system bottleneck and opportunity to improve performance continuously. For instance, the team member found the difference in temperature of supply and return water of air-condition is not as big as design. It lead to indoor **temperature can't drop quickly in hot weather. Then the issue was delivered to maintenance team and supplier to figure out solution.**

5. CONCLUSION

Life cycle concept of green building runs through design, construction, commissioning, operation, and demolish stage. This project case introduced here had experienced entire journey to realize high standard green industry factory sample in China. The initial building investment increase around 9% but owner will get quick return and tremendous potential benefits during the building life cycle such as people with good feeling of working environment will be more innovative and efficient on their job. Meanwhile it can sufficiently prove the corporate social responsibility and support for sustainable development in near future.

Green building practice is not difficult but need consider in every detail. The success for this project is mainly by two reasons: The project team set green target at very beginning and interactive each other to choose suitable strategy and technology to approach cost-effective and better performance green building; green vision and strong executive ability of project members is another engine that make all conception in design drawing comes true.

REFERENCES

- [1] Wang, J. Q. and Gao X.F. etc. 2016. China Green Building Development Situation in 2015, Tianjin Branch of China Academy of Building Research.
- [2] U.S. Green Building Council, 2013. LEED References Guide for Building Design And Construction, 2101 L Street, NW, Suite 500, Washington, DC 20037.

The Economic Cost-benefit Analysis of Green Building Based on the Low-carbon Economic Policy

WAN Shiyu^a, LIU Yisheng^b, LAI Ming^c

^a School of Economics and Management, Beijing Jiaotong University, Mainland China, fishwansy@163.com

^b School of Economics and Management, Beijing Jiaotong University, Mainland China, yshliu1@bjtu.edu.cn

^c The Central Committee of the JIU SAN(SEPT.3RD) SOCIETY, Mainland China, kjslm@msn.com

ABSTRACT

The main policy in a city to deal with climate change is to promote energy saving, the reduction of carbon emission, and the construction of green building, which is also a kind of governance mechanism within the legal city planning and construction management system. However, in some areas, a lot of local governments and urban construction enterprises are still misunderstanding the concept of green building, especially in the application of low carbon technologies which may make some impact on the economic cost. At present, in this field, the discussion of the policy making is mainly aiming at the problem of technology application. As a decision maker or investor, it is essential to know the real meaning of green building and its economic efficiency. This paper makes an analysis on the current policy of green buildings and establishes the cost-benefit analysis method of green building based on the theory of property rights from a macro perspective, then points out that it is necessary to design a set of operational analysis tools in the project level, and should put the benefits of green building construction in a macro economy level. Green building with incremental costs will bring additional incremental investment, which will lead an additional increase in industrial output during the economic system, and thus will have a macro impact on the overall economy in turn.

Keywords: green economics, cost-benefit analysis, green building policy

1. INTRODUCTION

Climate change is the biggest and most controversial environmental issue of our times. For its profound impact on the existence and development of mankind and as a major challenge faced by all countries, the world now mostly agrees that something needs to be done about global warming and climate change. On 12, December, 2015, Le Bourget, Paris, the historic Paris agreement on climate change is finally adopted with no objection at the COP21. After signed the Paris Agreement, China is energetically exploring for low-carbon development pathways. The main policy in a city to deal with climate change is to promote energy saving, the reduction of carbon emission, and the construction of green building, which is also a kind of governance mechanism within the legal city planning and construction management system. In building industry, how to promote green building has become a central issue (Yudelson J., 2009, Miller N, 2009).

With the promotion of building energy-saving and the establishment of certification system in green building standards, the extra cost and benefits in the process of green building design and construction has been concerned with (YIP Stanley et al., 2011, Morris P. et al., 2007). An analysis of 33 buildings in California's green building economic indicators pioneered the trend of analysing the United States of green building cost (Kats et al., 2003). After that, the United States Federal General Services Administration (GSA, 2009) conducted a survey and made an analysis about the additional cost needed to be paid if the newly built or rebuilt project could achieve LEED certification (Steven Winter Associate, 2004, Miller N et al., 2008, Urban Green Council, 2009). Green Building Council of Australia firstly published the economic analysis of green building, which made a comprehensive description about business model of green building and market considerations (GBCA, 2006). In 2010, they suggested that the government should establish a perfect financial incentive and all the commercial buildings should offer their energy consumption efficiency (GBCA, 2010). For the government of United Kingdom, green building cost analysis of market impact is main policy basis of continuous promotion of standards of green buildings (DGLC, 2011). In China, the economic evaluation method of construction project was mainly divided into "financial evaluation" method and "economic evaluation" method (YANG Yan et al., 2007), which does not highlight the characteristics of cost and benefit of green building. Some researches put forward the principle of increment cost of green building (LI Ju et al., 2008) and also cited the concept of green GDP (ZHUANG Yunhua et al., 2010), which put forward the use of the method of difference comparison to evaluate the index which was divided into the

cost incremental index and benefit incremental index, thereby reducing the cost of green building and promoting the implementation of green buildings.

From the above researches, we can see the development and some achievements on the economic efficiency of green building construction policies and relevant technical standards. However, the existing research still has some weaknesses: they are mainly concerned with the content of the specific economic data analysis, focusing on the technical level of discussion, but are lack of economic efficiency from the basic economic theory to understand the green building policy. Green building policy is a part of low-carbon urban planning and construction system, so we need to analyse how to understand the efficiency of the policy from the perspective of economic theory. Moreover, as a decision maker or investor, it is essential to know the real meaning of low-carbon green building and its economic efficiency.

2. THE ANALYSIS OF CURRENT CHINA'S ENERGY CONSERVATION POLICY ON GREEN BUILDING

2.1 The government restriction policy system of China's building energy conservation

The government restriction method intervenes directly in the allocation of market resources or changes indirectly the supply-demand relationship between producer and consumer through law and administrative regulation. At national level, there are five gradation of legal system, including law, administration regulation, ministry rules, policy oriented document, standard specification and technical directives, which is to develop a legal basement for related policies and strategies. At present, the technical content included in regulation has been arranged widely and contains almost all kinds of techniques for energy conservation and renewable resource generation. However, the related economic bodies have no choice but to engage in specific service to achieve the government's stated goals, otherwise, it will be subject to legal or administrative sanctions.

In order to make the implement effectively, regulation must follow these three principles: the provision of energy conservation content should be clear, which will allow the influenced economic bodies understand the concrete demand; for energy conservation on green building, it is important to composite the macro goal into definite technical specifications for industry and implementation; the efficiency supervisory control method should be developed, for example, promoting related laws and strategies on energy consumption standards of green building.

2.2 The economic policy system of China's building energy conservation

The economic policy method no matter whether it belongs to punishment or incentive is the governmental intervening method based on the theory of classical economics and welfare economics in order to change the marginal cost of benefit subject (DAI Xuezhi, 2007). In China, the economic policy system includes main three parts, economic incentive policy, energy price, and energy conservation label and green building label certification.

In the first part of economic incentive, it contains four main methods: financial subsidy, revenue from tax, lending money to the enterprise and reward. All of those make a few contribution to the five subjects: consumer, which includes the terminal consumer both of individual and company who are all concentrated on the downstream of green building construction; capital construction organization, such as the first class developer who is responsible for preparation of land; development organization, such as the second class developer, owner, estate investor; equipment producer; government.

While in the use of financial subsidy and tax revenue, most of the policy is offered for the development organization, consumers obtain less who would receive more compensation in the second part of economic incentive of energy price policy, especially in the area of renovation of heat metering in north China. However, the conflict between the different economic subjects and the unclear setting of energy price ratio make it urgent to establish a more marketable and efficiency resource allocation.

So in this condition, in order to meet the demand of energy conservation of buildings in the new economy environment, the government in China has developed energy label certification institution to measure the energy usage efficiency of building and offer energy efficiency information for the market, which now not only contains the **energy conservation label certification but green building evaluation standard. What's more, another important complement in the guiding policy is the Voluntary Emission Reduction Plan.**

2.3 The comment of China's energy conservation policy from the aspect of economic efficiency

According to the above analysis, the current China's building energy conservation policies is summarized as following Figure 1, and a further analysis from the aspect of economic efficiency will be made in the next.

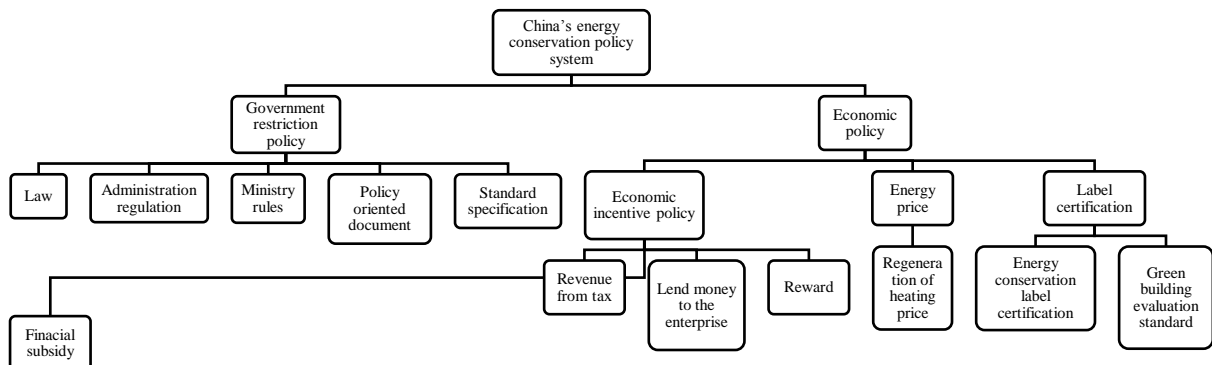

Figure 1: The framework of current China's building energy conservation policy system

2.3.1 The government restriction policy

Theoretically speaking, "order and control" method (government restriction policy) can control carbon dioxide emission of building by a clear and specific standard. While in reality, the standards and related regulations of energy saving may not be assessed by social and economic efficiency, so a suitable emission reduction level of building for the overall social benefit is difficult to be determined. Meanwhile, different developers have different production costs and in the same market there is also concentrating different producing bodies with different marginal costs of energy saving, so "order and control" method which asks for the same level of energy saving measures is not the preferred plan for the whole social economy efficiency.

2.3.2 The economy incentives policy

All the economy incentives in China are equal to a subsidy which transfers the public resource to private part in order to reduce the social influence of externalities. The beneficial parties will give up their originally owned economic property which in fact is the pollution right for producer in the current market mechanism, and in the area of green building construction which is the right of carbon dioxide emission of buildings. Whether the usage of social resource under economy incentives is optimized, it depends on cost of payment by the government (the cost of economy incentives). If the government wants to make use of the economy methods to encourage the property reallocation to reach the destination of mitigation of carbon emission of building, it should take the cost and benefit of the implement of policy and regulation into consideration, which will be discussed in the following part.

3. THE ANALYSIS OF COST-BENEFIT METHOD OF GREEN BUILDING

3.1 The concept of cost-benefit method of green building

Benefit means the increase of human welfare and cost means the decrease of human welfare. So focusing on a policy of green building, it means that the social benefit should be higher than the social cost. There are three basic concepts to further explain the cost-benefit method of green building:

- The impact of environmental damage and pollution caused by the construction of ordinary buildings can be assessed by economic loss and be calculated by economic price;
- In order to avoid the environmental damage and pollution, society will take measures on green building construction which will increase more incremental cost both in the technological application, trading cost, policy cost and all kinds of cost of capital and asset investment;

- The main theory of cost-benefit method is to solve the problem of externality, which is to try to measure the performance of all the costs and benefits by economic price. From the point of view of economy, the value of the cost-benefit method shows the preference of economic subjects, and also shows their willingness to pay.
- Cost-benefit method can give the policy maker a reference on what affects that different subjects impact on the environment and can be easily used in the comparison of policy option on different policy objectives;
- Cost-benefit method brings in the concept of time using the rate of discount to avoid the effect of different cost and benefit level in different time.

As it mentioned before, in order to solve the problem of policy efficiency, it is essential to develop a method to make an analysis on the cost and benefit brought by the policy, which should make the general concept of property theory as its basement and follow the principle of micro economic analysis combining the particularities of problems to establish a full set of operational, suitable and effective principles of property right allocation as concrete means to implement macro goals, which means to apply the cost-benefit analysis method of micro economics to the policy system analysis of the construction of green building and then offer a more objective policy assessment tool.

3.2 The theoretical basis of using cost-benefit method for analysis on economic efficiency of green building policy

Cost-benefit method is widely used in theoretical and practical analysis for climate change and environmental problems based on the following reasons:

- The basic principle of cost-benefit method guides the allocation of resources by measuring the economic benefit, which has wide applicability for policy in current environment with scarce resources;
- The process of cost-benefit method requires all participants outline their cost factor and benefit outcome, which can be formed as a list for reference of policy;
- Cost-benefit method combines the environmental impact with economic and financial effect as a unified way (economic price) to make comparison on every direct and indirect factor;

3.3 The basic model of cost-benefit method of green building

3.3.1 Economic model

Based on the cost-benefit analysis, this part will build a basic calculation model for green building following the three principles: marginal cost and benefit, Present Value and Net Present Value, decision rules.

- Marginal cost and benefit

Under the requirement of economic optimization, it needs to make the marginal cost equal to the marginal benefit, which can lead to an optimized equilibrium point of carbon emission of green building. While in reality government cannot find this point easily due to the policy cost and related particularity of using this method which will be explained in the following part.

- Present Value and Net Present Value

In order to calculate different green building construction means and the same green building construction mean in their different points of a whole life cycle, this part will use Present Value (PV) and Net Present Value (NPV) to calculate different periods of cost-benefit of green building.

The basic Present Value calculation equation is

$$PVC = \sum_{t=1}^n \frac{C_t}{(1+r)^t}$$

Equation 1

$$PV_B = \sum_{t=1}^n \frac{B_t}{(1+r)^t}$$

Equation 2

Where PV_C = Present Value of total cost of green building, PV_B = Present Value of total benefit of green building, C_t = the cost for the number t years, B_t = the benefit for number t years, r = discount rate, and t = time (year).

The basic net present value calculation equation is

$$NPV = \sum_t^n (B_{jt} - C_{jt} + B_{et} - C_{et})(1+r)^{-t}$$

Where NPV = Net Present Value of low-carbon green building, B_{jt} = basic building benefit for the number t years, C_{jt} = basic building cost for the number t years, B_{et} = basic green building benefit for the number t years, C_{et} = basic green building cost for the number t years, r = discount rate, and t = time (year).

Equation 3

- Decision rules

There are three decision rules for evaluating cost and benefit of green building:

- Present value of total benefit should be higher than present value of total cost:

$$PV_B > PV_C$$

Equation 4

$$NPV > 0$$

Equation 5

$$NPV = PV_B - PV_C$$

Equation 6

- Benefit-cost ratio :

$$PV_B / PV_C > 1$$

Equation 7

- Internal Rate of Return (IRR) can be used to make an analysis on economic returns of different economic bodies and to make an assessment on an overall cost-benefit returns influenced of different economic bodies on a policy. Calculate net present value of all kinds of cost and benefit and compare IRR of different policies or projects under the condition of $NPV=0$, and then choose the policy or project with higher IRR. The equation is:

$$B_0 - C_0 + \frac{B_1 - C_1}{(1+i)} + \frac{B_2 - C_2}{(1+i)^2} + \dots + \frac{B_t - C_t}{(1+i)^t} = 0$$

Where B_t = the benefit of carbon reduction in number t years, C_t = the cost of carbon reduction in number t years, t = time (year), i = Internal Rate of Return (IRR) of low-carbon green building policy

Equation 8

3.3.2 The cost and benefit factors of policy construction of green building

Under the green building construction policy, the economic bodies should undertake extra cost for carbon reduction caused by non-statutory requirements such as incentives, promotion, education, on the basis of statutory regulatory requirements. Meanwhile, all kinds of bodies can obtain corresponding policy benefit. The concrete cost and benefit that each group (the government, which stands for the overall society; organization, developer and investor including the first and second class developer; consumer and user) are facing under extra cost and corresponding benefit are listed on the Table 1:

	Cost	Benefit
Government	Promotion cost of green building construction	Investment reduction of conventional energy resources
	Management cost of policy implementation	Incremental GDP caused by construction of green buildings
	Financial incentive cost	Incremental job opportunities by construction of green buildings
	Subsidy of new energy of industry	
Organization/ Developer/ Investor	Low-carbon technologies and facilities	Government financial incentives by adopting low-carbon development model
	Green building design, certification and examination	Rise in selling price and renting price
		Company brand value
Consumer/ User	Maintenance and operation management of new energy facilities	Reduction of energy usage
	Extra cost of buying low-carbon green building	Government financial incentives
	Government financial method (the price of heat supply and power supply)	

Table1: The cost and benefit factors for each economic body

3.3.3 The particularity of cost-benefit method of green building

When making a cost-benefit analysis, regulation producer should offer a minimum baseline protection as a rigidity index to guarantee the carbon emission of buildings that is under a safety level to prevent all kinds of groups from irreversibility and maintain basic survival and social interest level. In the analysis of cost-benefit of green building construction, it is necessary to bring in the rigidity index and define the relevant rigid emission index as a constant, and then calculate the highest economic cost of this indicator. In recent international researches, all kinds of Integrated Assessment Model (IAM) are used in cost calculation of carbon emission, by which a pathway of change of optimized carbon emission can be simulated in marginal cost and benefit analysis. These can help policy makers know about the highest level of carbon reduction cost when a policy implement is according to a quantitative carbon reduction index and promote optimization of social resource allocation.

4. CONCLUSION

The current system environment in our country is transforming from the planned economy system to the market economy system, and the function of the market economy is increasingly perfect in the allocation of social resources. The economic means to promote public policy, especially in the face of "public goods" problem of the building energy conservation will be an important direction. The future development of the policy system should follow the dynamic market mechanism and optimize policy system, which must be established on the overall cost-benefit economic efficiency framework. It is necessary to take trading cost of governmental regulation into consideration scientifically and promote the economic incentives to consumer terminal, leading the terminal market demand driven supply.

Meanwhile, it is essential to design a set of operational analysis tools in the project level, and should put the benefits of low-carbon green building construction in a macro economy level from different aspects of economic bodies. More or less, there is an urgent need to establish unified marginal cost (carbon reduction benefit) data guidelines and methods for green building construction policy in China to make the cost-benefit method as the basic policy evaluation method, promote the assessment work of policy means, and develop a basis for estimating social cost of building carbon emissions for the local government. What's more, green building with incremental costs will bring additional incremental investment, which will lead an additional increase in industrial output during the economic system, and thus will have a macro impact on the overall economy in turn.

REFERENCES

- [1] DAI Xuezhi, He Weida, DI Yanqiang, 2007. Study on Multi-index Comprehensive Evaluation Systems for Economic Incentive Policies of Building Energy Efficiency. *Building Science*, 2007(02), 54-60.
- [2] GSA LEED Cost Study, Steven Winter Associate. Retrieved from: www.wbdg.org. [Retrieved on 2009-11-12].
- [3] Green Building Council of Australia, 2010. *The Road to Green Property*. GBCA.
- [4] Green Building Council of Australia, 2006. *The Dollar and Sense of Green Buildings 2006*. GBCA.
- [5] Kats G, et al., *The Cost and Financial Benefit of Green Buildings*. Retrieved from: www.cap-e.com. [Retrieved on 2009-11-12].
- [6] LI Ju, SUN Daming, 2008. Statistics and Analysis on Incremental Cost of Green Ecological Technology of Residential Building. *Housing Science*, 2008(8), 16-19.
- [7] Miller N, Pogue D, Gough Q D, Davis S M., 2009. Green Buildings and Productivity. *Journal of Sustainable Real Estate*, 2009(1):65-89
- [8] Miller N, Spivey J, Florence A., 2008. *Does Green Pay Off?*, University of San Diego Working Paper.
- [9] Morris P., 2007. *What Does Green Really Cost?*. *PREA Quarterly*, 2007(Summer), 55-60.
- [10] UK Department for Communities and Local Government, 2011. *Cost of Building to the Code for Sustainable Homes*. DCLG.
- [11] Urban Green Council, 2009. *Cost of Green in NYC*, New York: USGBC.
- [12] YANG Yan, YANG Hua, 2007. The New Edition of the Economic Evaluation Methods and Parameter Summary About Construction Projects. *Food and Fermentation Sciences & Technology*. 2007(02), 14-18.
- [13] YIP Stanley C T et al., 2011. Study on the Economics of Green Building in China: a Cost-benefit Analysis. *Eco-city and green building*, 2(4), 28-33.
- [14] Yudelson J., 2009. *Green Building through Integrated Design*. New York: McGraw Hill.
- [15] ZHANG Yunhua, ZHANG Jinwei, 2010. An Economic Evaluation on the Life Cycle Cost of Ecological Energy Saving Buildings. *Ecological Economy*, 2010(8), 75-78.

Poster Session

Study on Consumers' Willingness to Pay for Products with a Green Building Material Label in Taiwan

TSAY Yaw-shyan^a, CHANG Yi-hsuan^b

^a National Cheng-Kung University, Taiwan, tsayys@mail.ncku.edu.tw

^b National Cheng-Kung University, Taiwan, sunny811104@yahoo.com.tw

ABSTRACT

Taiwan's government implemented the Green Building Material (GBM) Labelling policy in 2004, and 1,448 labels of 10,114 products had already been certified by December 2015. Since 2010, the building code has enforced the mandatory usage of 45% GBM products in the interiors and 10% in the exteriors of public buildings. The reputation of GBML products has been improving recently, and many consumers are requesting the use of GBM products in private buildings as well. Although some industrial investigation studies have been carried out to determine the economic effect of green business in relation to GBM policy, few studies have focused on the value of GBM for consumers.

In this study, we used the contingent valuation method (CVM) to perform a survey of consumers, in which the willingness to pay (WTP) and willingness to accept (WTA) of GBM were calculated. According to the results, the WTP for building material products with GBM was 13.6%, products of a famous brand was 12.2%, and products with both GBM and a famous brand was 15.9%, suggesting that the value of GBM is superior to that of a famous brand and that the label is highly regarded by consumers. On the other hand, the WTA of products without a GBM was 18.5%, without a famous brand was 18.8%, and products without either was 22.8%, thus indicating a positive tendency toward green consumption.

Finally, we performed Spearman's correlation analysis and found that the WTP of GBM was correlated to consumers' education and residence ($p \leq 0.05$), while the WTP of famous brands was positively correlated to household income ($p \leq 0.01$). A correlation between the WTA of famous brand and education was also found ($p \leq 0.05$) in this study. These results can serve as a reference for building material industries that participate in green business.

Keywords: green economics, contingent valuation method, famous brand

1. INTRODUCTION

1.1. Taiwan's green building material labelling system

Before the promotion of green building evaluation and labelling, Taiwan's Architecture and Building Research Institute (ABRI) proposed the Green Building Material (GBM) Labelling system in 2003 and officially launched it in 2004. The goal of the system was to promote a sustainable built environment for the earth and a healthier quality of life for human beings. Taiwan's GBM evaluation system systematically comprises four categories, including health, ecology, recycling, and high-performance, as shown in Table 1. Its assessment generally adopts the life cycle assessment approach to cover the four stages of a building's life cycle: resource exploitation, production, usage, and disposal and recycling (Ho et al., 2008).

According to the Building Technical Regulations, since 2006, GBM must be used for interior furnishings and flooring of a public building and must constitute at least 5% of all decorating materials. In 2009, the utilization percentage was increased to 30%. Since 2010, the building code has enforced the mandatory usage of 45% GBM products in the interiors and 10% in the exteriors of public buildings (Tsay et al., 2015). Thanks to the leading of the policy, despite the economic downturn of recent years, GBM certification has increased significantly over the past ten years, as shown in Figure 1. As of the end of December 2015, 1,448 labels of 10,114 products had been certified.

1.2. The value of GBM for consumers

The reputation of GBM products has been improving recently, and many consumers are requesting that GBM products be used in private buildings as well. While previous industrial investigation studies have aimed to determine the economic effect of green business in relation to the GBM policy, few studies have addressed the value of GBM for consumers.

Category	Definition
Healthy	A GBM is not harmful for human health and features such characteristics as low emission, low-pollution, low odor, and low physical harm
Recycling	A GBM focuses on the regeneration of recyclable building materials through proper remanufacturing processes to achieve the goal of Reduce, Reuse, and Recycle (3R).
Ecological	A GBM is a natural material that requires less processing and energy consumption, can be easily decomposed, and grows rapidly. Conforming to the local industry is also considered.
High-Performance	Regarding sound insulation, a GBM can effectively prevent noise. Regarding permeability, a GBM can promote water infiltration and retention through its high permeability.

Table 1: GBM categories in Taiwan

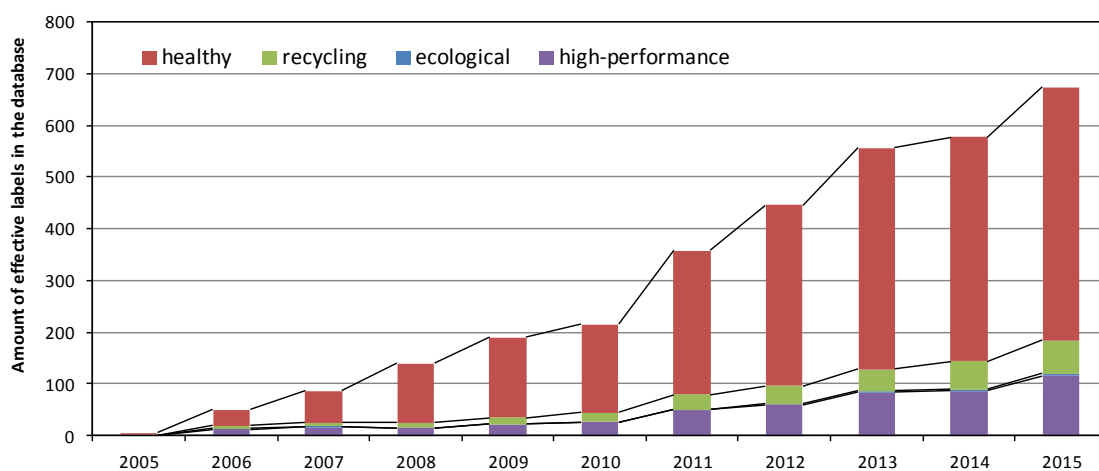

Figure 1: Amount of effective labels in the database

2. CONTINGENT VALUATION SURVEYS

In this study, we used the contingent valuation method (CVM) to survey consumers, in which the willingness to pay (WTP) and willingness to accept (WTA) GBM were calculated. In economics, WTA is the minimum amount of **money that a person is willing to accept to abandon** a good or to put up with something negative, such as pollution. On the other hand, WTP is the maximum amount an individual is willing to sacrifice in order to procure a good or avoid something undesirable. The price of any goods transaction will thus be any point between a buyer's willingness to pay and a seller's willingness to accept. The net difference between WTP and WTA is the social surplus created by the trading of goods.

WTP is frequently used as a measurement for environmental protection to evaluate natural resource valuations (Kopp & Smith, 2013). Many studies have also used CVM to evaluate the value of products with safety or sustainability certification. Basu and Hicks (2008) studied the WTP of Fair Trade coffee and identified the threshold

property of performance-based labels. Furthermore Enneking (2004) performed a CVM survey for the WTP of the Q&S label in Germany and compared it with German premium brands for evaluation.

A CVM survey can be categorized into several methods, including the open-ended method, sequential bids method, dichotomous choice method, and payment card method. To start our empirical research on green building materials, the sequential bids method was applied in this study, using the WTP question “How much percentage extra are you willing to pay for this product?”

The survey was carried out at the 2015 Taipei International Building, Construction & Decoration Exhibition, which is **Taiwan’s** largest exhibition of building materials. We passed out 104 questionnaires and received 102 effective questionnaires for analysis. The questionnaire was divided into two parts, including demographic information and WTP/WTA for GBM products, famous brand products, and both.

The price range of building materials is extremely large so we selected the following seven range options: 0-5%, 6~10%, 11~15%, 16~20%, 21~25%, 26~30% and above 31%. SPSS 2.0 was used for statistical analysis, including descriptive statistics, T-test, and **Spearman’s correlation coefficient**.

3. RESULTS AND DISCUSSION

The results of the survey are shown in Figure 2 and Table 2. Of the respondents, 55.9% are female, and 44.1% are male; the majority are under the age of 30, followed by the 31~40 age group; 57.8% of respondents had a college education, and 30.4% have a master’s or PhD; a household income below 0.5 million NTD/year and 0.5~1 million NTD/year are each 33.3% in the survey. Most respondents choose the WTP (extra cost) of 6~10%, 11~15%, and 16~20%, and mostly selected the WTA exceeding 11%.

WTP/WTA (%)	WTP _{GBM}		WTP _{FB}		WTP _{both}		WTA _{GBM}		WTA _{FB}		WTA _{both}	
	N	P(%)	N	P(%)	N	P(%)	N	P(%)	N	P(%)	N	P(%)
0-5	11	10.8	23	22.5	6	5.9	8	7.8	6	5.9	6	5.9
6-10	30	29.4	24	23.5	23	22.5	15	14.7	12	11.8	4	3.9
11-15	24	23.5	22	21.6	25	24.5	15	14.7	17	16.7	9	8.8
16-20	21	20.6	20	19.6	22	21.6	21	20.6	25	24.5	18	17.6
21-25	7	6.9	6	5.9	10	9.8	13	12.7	15	14.7	11	10.8
26-30	1	1.0	1	1.0	6	5.9	11	10.8	11	10.8	20	19.6
≥ 31	8	7.8	6	5.9	10	9.8	19	18.6	16	15.7	34	33.3

N: Number; P: Percentage

Subscript: GBM: green building material; FB: famous brand; both: products of both GBM and FB

Table 2: Summary of WTP/WTA in the survey

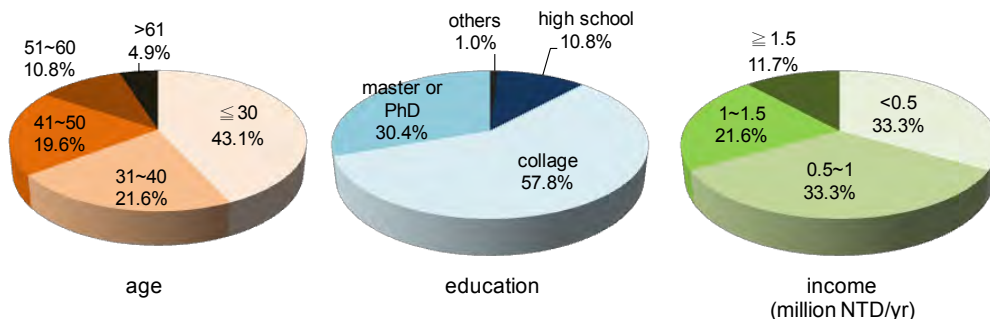

Figure 2: Demographic information of the survey

Figure 3 shows the average WTP and WTA. According to the results, the WTP of building material products with GBM was 13.6%, products of a famous brand was 12.2%, and products with both GBM and a famous brand was 15.9%, indicating that the value of GBM is superior to that of a famous brand, as well as that consumers highly

regard the label. On the other hand, the WTA of products without a GBM was 18.5%, without a famous brand was 18.8%, and products without either was 22.8%, suggesting a positive tendency toward green consumption.

Finally, we performed Spearman's correlation analysis, the results of which are shown in Table 3. In the survey, the WTP of GBM was correlated to consumers' education and residence ($p \leq 0.05$), while the WTP of famous brands was positively correlated to household income ($p \leq 0.01$). A correlation between the WTA of famous brand and education was also found ($p \leq 0.05$) in this study.

Furthermore, the WTA/WTP ratios of 1.36, 1.54, and 1.43 for GBM, FB, and both, respectively, are found in the survey, thus demonstrating that the respondents are conservative (rational) consumers. Note that a higher WTA/WTP ratio shows that the product's characteristics are less likely to compensate. These results can serve as a reference for building material industries that participate in green business.

	Sex	CHD	EDU	Age	Job	Income	Living Area	Know GBM	Ever buy
WTP _{GBM}	.022	-.122	-.199*	.146	-.081	.060	-.221*	-.103	-.100
WTP _{FB}	-.089	-.021	-.159	-.027	-.093	.271**	-.151	-.038	-.145
WTP _{both}	.041	.011	-.148	-.030	-.001	.100	-.194	-.092	-.075
WTA _{GBM}	.154	-.028	-.142	.057	-.030	-.074	-.040	.006	-.038
WTA _{FB}	-.002	-.050	-.232*	.008	.014	.050	.036	.018	-.128
WTA _{both}	.154	.086	-.153	-.112	.043	-.023	.073	-.035	.035

*: $p \leq 0.05$; **: $p \leq 0.01$

CHD: have children in the family; EDU: education

Table 3: Results of Spearman's correlation analysis

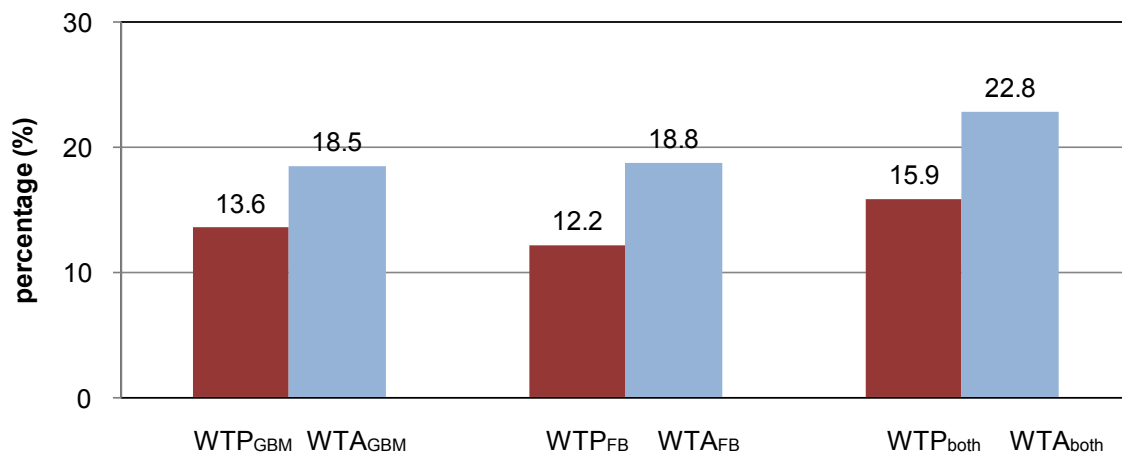

Figure 3: Results of average WTP/WTA

4. CONCLUSIONS

In this study, we carried out a survey based on CVM and calculated the WTP and WTA of building material products with GBM, famous brand, and both in order to evaluate the effect of GBM policy on the market and consumers. The results show that the WTP of GBM is 13.6% (extra pay), which is superior to famous brand products. The WTA values range from 18.5–22.8%, which are higher than the WTP in all categories.

In the survey, the results demonstrate a positive tendency toward green consumption and can be used as a reference for building material industries that participate in green business.

5. ACKNOWLEDGEMENT

The authors would like to thank the Taiwan Architecture and Building Center for providing data related to GBM certification. Part of this research was financially supported by the Architecture and Building Research Institute (ABRI) of Taiwan.

REFERENCES

- [1] Ho, M.C., Chen, J.L., Chiang, C.M., Chiu, C.Y., Yau, J.T. & Hsieh T.T. (2008). Taiwan green building material labelling system and its applications to sustainable building in subtropical zone. In: Proceedings of the Conference on Sustainable Building SB08 Melbourne, 435-440.
- [2] Tsay, Y.S. et al. (2015). Evaluation Manual for Green Building Material. 2015 edition. Taipei: Architecture and Building Research Institute.
- [3] Kopp, R.J., & Smith, V.K. (2013). Valuing natural assets: the economics of natural resource damage assessment. Routledge.
- [4] Basu, A. K., & Hicks, R. L. (2008). Label performance and the willingness to pay for Fair Trade coffee: a cross-national perspective. *International Journal of Consumer Studies*, 32(5), 470-478.
- [5] Enneking, U. (2004). Willingness-to-pay for safety improvements in the German meat sector: the case of the Q&S label. *European Review of Agricultural Economics*, 31(2), 205-223.

Improving the Relationship between Eco-Design and Environmental Education – A Case Study of Elementary Schools in Taiwan

HUANG Wei-chih^a, TSAY Yaw-shyan^b, HO Shin-jia^c, HO Yen-yi^d

^a National Cheng Kung University, Taiwan, bboring1030@gmail.com

^b National Cheng Kung University, Taiwan, tsayys@mail.ncku.edu.tw

^c Center for General Education, National Taichung University of Science and Technology, Taiwan, shinjia@gmail.com

^d Department of Interior Design, Shu-Te University, Taiwan, hamalee@stu.edu.tw

ABSTRACT

For more than 10 years, Taiwan has promoted environmental education in its schools and has even incorporated it into the curriculum guidelines for compulsory education of grades 1-9. Previous studies on the theory of education have suggested that by treating school campuses as a three-dimensional textbook, architects' designs can potentially provide many benefits for environmental education activities. The education provided in elementary schools is crucial for developing both children's personalities and their physical bodies. Teachers can use a variety of methods to provide environmental education and can even integrate the campus facilities/ space to improve the effectiveness of children's learning, thus influencing the practice of environmental education. Therefore, determining how to implement environmental education concepts in campus design is vital for architects.

In this study, we propose an assessment framework for elementary schools based on a reference review, which includes green campus design principles, children's learning development, and Taiwan's eco-school reform project indicators. We then used the resulting framework to assess the facilities/ space of 13 existing campuses designed by famous architects or that had received funding from eco-school projects. The results showed that the architects' design strategies for eco-schools may not be appropriate for environmental education, and this study's proposed framework can provide a better thought process for relevant architects.

Keywords: assessment framework, design principles, field investigation

1. INTRODUCTION

In 1972, the United Nations published the Belgrade Charter, which defines the implications of environmental education in both formal and non-formal settings. Elementary and secondary education are undoubtedly the basis of formal education, so Taiwan began promoting environmental education in schools 10 years ago and, in 2008, even incorporated it into the grade 1-9 curriculum guidelines for compulsory education. Furthermore, in order to follow the "green campus" trend that has been promoted for years, Taiwan's Ministry of Education has established the "Sustainable School Project," which not only embodies the concepts of sustainable development but is also imbued with meaning for Environmental Education.

A school building is a teaching field established to achieve educational goals. Higgs and McMillan (2006) proposed that campus architecture as a "three-dimensional teaching material" can aid both teaching and learning. Many scholars have aimed to connect architecture and EE by designing physical environments as a Three-Dimensional (3-D) Textbook (Orr, 1993; Taylor and Enggass, 2009). Therefore, all on-campus facilities are part of overall campus planning, and the designers should consider education significance and determine the possibility of using it as a teaching aid.

The environment is an essential element of human living. In particular, the environment around children can significantly influence their development. Campus space facilities are a part of campus planning and are related to children's physical and mental development. Working on children's environments, Clare Cooper Marcus (cited in Loebach, 2004) explains that "children are more deeply affected by the environment than any other age group". Furthermore, according to Havighurst's (1972) theory, the learning development task of children between the ages of 6 and 12 years old can be divided into five major categories, which are physical development, cognitive development, moral development, social development, and emotional development.

Kong, Rao, Abdul-Rahman, and Wang (2014) focused on Bali's Green School as their research object to determine the relationship between campus and environmental education. After collecting data and interviewing experts and

scholars, they proposed four attractive spatial characteristics for children, which are transparency, nature, creativity and imagination, and active learning. In this study, according to the results of our analysis, we determined the key characteristics and expanded them into a broader framework as a reference for campus architects.

These studies have shown that an elementary school has the opportunity to become a 3-D Textbook campus. If the architects that design schools incorporate EE, learning, and child development from the beginning, schools have the chance to become better learning fields. In this study, we proposed an assessment framework that we hope will help both architects and teachers.

2. METHODS AND PROCESS

2.1 Creating the assessment framework

This study aims to propose evaluation indicators to serve as references for architects. After a review of the literature, the study verified indicators, comparisons among indicators, and confirmation of actual cases. Then, according to these indicators, we proposed a design program. Based on the results of the literature review and our analyses, we developed a school building and space with environmental education concepts that not only meet the spatial needs of the campus but also have broader connotations of both complying with environmental education conceptual principles (Kong et al., 2014) and child learning and development (Toronto District School Board, 2013). Among the learning and development of children, the contents of both affective development and cognitive development are similar and can be integrated with nature-inspired and activated facilities; furthermore, we added the two indicators of science and technology and health and safety to this study, as shown in Table 1.

Main perspective	Secondary perspective	Evaluation factors
Design principles of sustainable environmental education	Obvious cue	a1. Exposure of natural building materials
		a2. Exposure of green construction equipment
		a3. Explorable ecology or procedures
	Nature-inspired (affective development)	b1. Indoor and outdoor natural relationships
		b2. Learning in an outdoor natural environment
		b3. Local characteristics of natural resources
	Innovative problem solving	c1. Aesthetic and creative facilities
		c2. Creative reuse of recycled wastes
c3. Operating spaces for experiments		
Activated facility (cognitive development)	d1. Operable buildings and facilities	
	d2. Open multipurpose spaces	
	d3. Thematic space (such as animal farms or tree houses)	
Science and technology	e. An application of electronic equipment for transformation into easier concepts for perception.	
Health and safety	f. Focus on safety, health, and hygiene	
A learning and development framework for children	Social development	g. Facilities as outdoor learning classrooms for two to three groups of children to undergo static or dynamic activities
	Physical development	h. Facilities that allow children to partake in physical activities

Table 1: Assessment framework for the environmental education functions of campus facilities

2.2 Comparison of indicators for a sustainable campus

One of the purposes of a sustainable campus is to develop a learner-friendly community environmental education center. Chen (2007) proposed the essence of environmental assessment indicators for sustainable campuses in elementary schools. We compare the assessment indicators proposed by Chen (2007) with the environmental education indicators for campus facilities found in this study with the goal of determining differences in order to explain the insufficient and improvable indicators for a sustainable campus in this study. Figure 1 shows the results of analyses after comparison.

From our comparison, we first found that the indicators for sustainable campus lack the spirit of children's development and learning. In children's growth stage, the essential activity space for playing games and

conducting social activities is not mentioned. Second, children in this stage need a variety of functional spaces to inspire their creativity as one kind of learning, but the sustainable campus indicators do not mention such an item. Third, the indicators for sustainable campus do not reflect the needs of elementary school students. From a **“campus as three-dimensional teaching materials” perspective, if the design of a campus cannot vary with students** of different ages, it would not effectively be in line with the educational spirit of implementing different teaching methods for students of different ages. Therefore, environmental education indicators in campus facilities have to cover two perspectives: the sustainable campus and the learning and development of **children. Children’s learning** and development can reflect the learning needs of children in this stage, which could better reflect the design spirit of an elementary school campus.

2.3 Field study for verification

This step is to verify the indicators proposed in this study in an actual environment. Using the facilities in elementary school campuses as objects, this study covers the following three types of schools: the supporting targets of a sustainable campus, the 921 new school movement, and excellent design cases. These three types have individual reference values. Using regional distribution, we selected 13 elementary school campuses to serve as the preliminary research objects. With prevalent investigations (observations, photo taking, and interviews), we carried out evaluations according to the constructions (Table 1) previously proposed to research the relevance between facilities in campus spaces and environmental education.

3. RESULTS AND DISCUSSION

In this study, we divided common outdoor facilities on campus into the following four categories: games facilities, green building machinery, ecological facilities, and independent functional facilities. Table 2 shows the verifications of these four categories of outdoor facilities according to the corresponding evaluation indicators. We selected three cases in this study to determine the feasibility of the optimized designs, which are shown in Table 3 ~ Table 5.

After evaluation using the case-by-case evaluation indicators, we summarized our results into the four items described below. First, Table 3 shows the common ecological facilities. For these facilities, relevant people need to pay more attention to whether they are in line with environmental issues from an ethical perspective. If local ecological characteristics can be shown on the edge of campus, school students have the opportunity to observe them when they go to and leave school, which allows the campus to highlight the idea of sustainable development in a community environmental education center. Second, the natural environment is the best playground. Integrating games facilities with the natural environment encourages children to combine games with cognitive development, which is more closely in line with the concepts of learning from games, as shown in Table 4. Third, some campus facilities do not meet the requirements of environmental education indicators. For example, the green building machinery (Table 5) in DaFu Elementary School (no.7) applied grills that obstructed the outer spaces, which is not in line with the design principle of obvious cues and creates disadvantages when teaching. Instead, the school could remove the grills to make it more convenient to observe the teaching situation. Furthermore, the school could improve the construction of facilities to enhance quantification and visualization (Kasai & Araki, 2015), which will help teachers provide lessons related to environmental education or natural science (materials). Fourth, the independent functional facilities on campus should consider how to combine the characteristics of spaces with the surrounding environment. For example, the integration of the natural landscape (nature-inspired) or other facilities (such as leaves for composting) makes the space a work zone for mutual learning (social development).

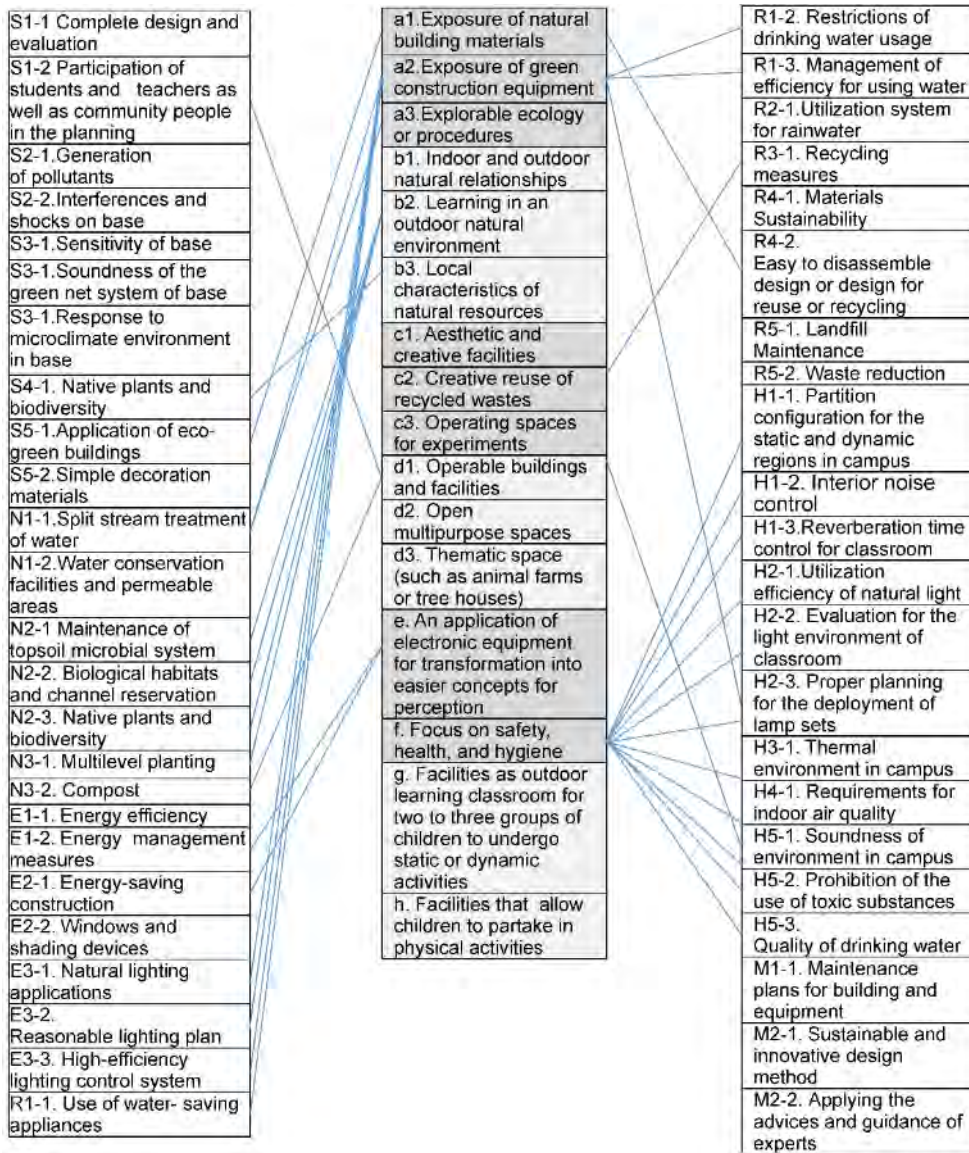



Figure 1: Assessment framework for the environmental education functions of campus facilities

Games facilities on campus	Games facilities under trees and platform 	Game facilities in the woods. 	Games facilities in the atrium 	Game bunker 
	School no.1 ■ Nature-inspired ■ Physical development	School no.2 ■ Nature-inspired ■ Physical development	School no.3 ■ Physical development ■ Health and safety	School no.4 ■ Physical development ■ Health and safety (Clean white sand)
(Green) Building machinery on campus	Rainwater recycling 	Energy revealing facilities 	Energy revealing facilities 	Wind and lighting pumping system 
	School no.5 None	School no.6 ■ Science and technology	School no.7 ■ Science and technology	School no.4 ■ Obvious cue ■ Nature-inspired









Ecological facilities on campus	Ecological corridors for crabs  School no.5	Natural farm  School no.2	Waterwheel in paddy  School no.8	Garden next to classroom  School no.9
	■Obvious cue	■Nature-inspired ■Activated facility	■Obvious cue	■Nature-inspired ■Activated facility
Functional space facilities on campus	Semi-outdoor workshop  School no.2	Recycling area  School no.2	Recycling area  School no.6	Outdoor ladder theater  School no.10
	■Nature-inspired ■Activated facility	■Nature-inspired ■Activated facility ■Social development	■Activated facility	■Social development

Table 2: Classification and evaluation of spaces and facilities of campus





School no.5: Ecological corridors for crabs	
	<p>→Field Observation: Since crabs live in the neighboring waterfront near campus, the ecological restoration corridor was established. However, information obtained from an interview indicated that fry in a nearby fish farm would fall prey to the crabs. Therefore, this corridor has already been abolished in response to protests from fishermen.</p> <p>→Matched item: None (not in line with the application according to local conditions from the perspective of nature-inspired principles)</p>
Direction of optimal designs : ■Nature-inspired	
<p>■Nature-inspired :</p> <p>_ Learning in an outdoor natural environment(b2)</p> <p>_ Local characteristics of natural resources(b3)</p> <p>Explanation: In addition to ecological ethical considerations, ecological corridors could be established alongside the paths that students walk by on the way to school or on the way home every day. By doing so, path learning concepts are in line with the idea of learning in the natural environment.</p>	  <p>Portland Green Street</p> <p>NTUT ecological fences</p>

Table 3: Ecological facilities on campus (Eco-design suggestions)

School no.3: Games facilities in atrium	
	<p>→Field Observation: Games facilities with soft cushion on the ground are uncommon in elementary schools, but they allow the facilities to be incorporated with the natural environment and elevate affective development, as well as enhance the shading effects.</p> <p>→Matched items: ■Physical development ■Health and safety</p>
Direction of optimal designs: ■Nature-inspired ■Innovative problem solving	

<p>Direction 1: ■Nature-inspired _ Learning in an outdoor natural environment (b2) Explanation: Alter the relationship with nature and work with nature to incorporate the natural environment into the playground.</p> 	<p>Direction 2: ■Innovative problem solving _ Aesthetic and creative facilities (c1) Explanation: Alter the relationship and combine with small trees and glass houses to turn the games facilities into castles.</p> 	<p>Direction 3 : ■Innovative problem solving _ Aesthetic and creative facilities(c1) Explanation: Alter the structure and use natural elements.</p> 
---	--	--

Table 4: Games facilities in the atrium (Suggestion of eco-designs)





<p>School no 5: Recycle facilities for rainwater</p>		
	<p>→Field Observation: The recycling facilities for rainwater in DaFu Elementary School (no.7) are surrounded by rainwater recycling bins, which makes students less likely to take the initiative to observe and contact them. →Matched item: None (already better than those that are completely sheltered)</p>	
<p>Direction of optimal designs : ■Obvious cue ■Innovative problem solving</p>		
<p>Direction 1: ■Obvious cue: _ Exposure of green construction equipment(a2) Explanation: Removing the grills to expose building facilities, which makes it easier for teachers to teach and students to contact and learn.</p> 	<p>Direction 2: ■Obvious cue: _ Exposure of green construction equipment(a2) Explanation: Explanation: Combined with the building, the transparent floor makes the graduations on it visible, thus making it convenient for students to learn.</p> 	<p>Direction 3: ■Innovative problem solving _ Aesthetic and creative facilities(c1) Explanation: Alter the materials to make them transparent and quantifiable, thus allowing the students to more easily contact the information related to the measurements.</p> 

Table 5: Recycling facilities for rainwater (Eco-design suggestions)

Category	Space name	Priority of evaluation indicators for review	Implications of incorporating environmental education
Games facilities on campus	Games facilities in the atrium, games facilities under trees, tree houses, platforms, and bunker	<ul style="list-style-type: none"> •Innovative problem solving (can incorporate waste reuse into their life) •Nature-inspired (Use local natural materials in manufacturing) •Physical development •Health and safety 	This category of facilities is functional and emphasizes the physical development of children. Furthermore, using local natural materials in manufacturing can reduce the carbon emissions, thus complying with the spirit of sustainable development. Combining the planting of flowers and grass with different games, the facilities can better reflect the idea of learning through games.
(Green) Building machinery on campus	Rainwater recycling facilities, energy revealing facilities, and integrated wind and lighting pumping system	<ul style="list-style-type: none"> •Obvious cue (Expose construction equipment) 	This category of facilities focuses on obvious and exposed cues. The designer should pay more attention to visualization and quantification perspectives, which allow for connections with teachers' instruction and allow students to observe and record naturally.

Ecological facilities on campus	Waterwheel in paddy, ecological corridors, natural farm, flower garden next to the classroom	• Nature -inspired (In line with application according to local conditions and natural characteristics/ learning in the natural environment)	This category of facilities emphasizes applications according to local conditions. Each base should take proper advantage of natural resources and take notice of location characteristics while designing. The locations should clearly arouse the spontaneous exploration and learning of children and thus provide better benefits.
Functional space facilities on campus	Recycling area, Semi-outdoor workshop , outdoor ladder theater	• Activated facility (Allows students to alter, take care of, and operate) • Nature -inspired (Near nature) • Social development (Form a working zone)	This category of facilities has independent functions. When combined with other facilities with similar characteristics, a working zone can be created to increase the opportunities for communications and learning among children, and teachers can design organizational environmental education lessons (such as resource flow cycle).

Table 6: Results of evaluation

4. CONCLUSION AND DISCUSSION

This study is a preliminary investigation for campus building and environmental education. We selected 13 elementary schools to evaluate and verify. As shown in Table 6, the operational procedures of space facilities in campus design are initially qualitative and quantitative developing processes and cannot provide standard answers. This study has summarized the theories about environmental education from previous articles and carried out confirmation in order to provide architects with a set of referable indicators during their design procedures. Architects should maintain the core values of innovative inspiration in their building designs. However, with these verified standards and software teaching materials, they can better implement environmental education in campuses.

REFERENCES

- [1] **Chen, X.H. (2007). A Study on Assessment of Sustainable Campus's** Physical Environment for Cycle Assessment, Japan 11(4), pp. 337-347. Elementary Schools in Taiwan. PhD. Cheng Kung University.
- [2] Havighurst, R.J. (1972). Developmental tasks and education. NY: David McKay Company.
- [3] Higgs, A.L. and McMillan, V.M. (2006). **Teaching through modeling: Four schools' experiences in sustainability education.** The Journal of Environmental Education, 38(1), pp. 39–53.
- [4] Kasai, T. and Araki, F. (2015). Implementation of an Environmental Education Program Based on
- [5] Kong, S.Y. , Rao, S.P. , Abdul-Rahman, H. and Wang, C. (2014). S. The Asia-Pacific Education Life Cycle Thinking in an Elementary School: Green Wall Cultivation Using Rainwater. Journal of Life
- [6] Loebach, J. (2004). Designing learning environments for children: An affordance-based approach to
- [7] Orr, D. (1993). Architecture as pedagogy. Conservation Biology, 7(2) ,pp. 226–228. providing developmentally appropriate settings. Master. Dalhousie University. Researcher, 23(1) , pp. 1-15.
- [8] Taylor, A. and Enggass, K. (2009). Linking architecture and education: Sustainable design for learning environments. Albuquerque: University of New Mexico Press.
- [9] Toronto district school board, (2013). Landscape and Child development: A Design Guide for Early Years–Kindergarten Play-Learning Environments . 2nd ed . [PDF] Toronto : Evergreen. Available at: <https://www.evergreen.ca/downloads/pdfs/Landscape-Child-Development.pdf> [Accessed 28 Apr. 2016] .

Benefits of and Barriers to Green Building Implementation in Hong Kong

HUO Xiaosen^a, Ann TW YU^b

^a The Hong Kong Polytechnic University, Hong Kong SAR, xiaosen.huo@connect.polyu.hk

^b The Hong Kong Polytechnic University, Hong Kong SAR, ann.yu@polyu.edu.hk

ABSTRACT

Green building is an essential component of sustainable development, but the benefits of and barriers to green building implementation in Hong Kong are unclear. A literature review and in-depth interviews were conducted to address this gap in our knowledge. The literature review results suggest that green building implementation leads to a reduction in lifecycle costs, occupant health and efficiency improvements, greater energy savings and efficiency, fewer environmental effects, and tax and market benefits. The barriers to such implementation include high initial costs, a lack of awareness and knowledge, a lack of financial incentives and government support, stakeholder conflicts, uncertainty and risks, and possible project delays. To address the impediments and promote green building implementation in Hong Kong, four interviews with green building specialists in Hong Kong were conducted, with attention paid to the distinct characteristics. The results suggest that the joint efforts of the Hong Kong Green Building Council and the government have led to some green building achievements in Hong Kong, although significant barriers remain, including high initial costs, insufficient market transformation, knowledge gaps, a lack of incentives for existing buildings and the public, and uncertainties and risks. Solutions to these urgent problems are proposed from the perspective of practitioners in green building. Market transformation can be driven based on the establishment of related policies and regulations by the government. The public mind-set and behaviours can be changed through education initiatives. More incentives should be issued to promote developers to turn traditional buildings into green ones. Besides, communication platform among stakeholders should be developed including project-specific platform and industry-wide one. It is also recommended that future research may focus on how to make existing buildings more efficient or on the development of business models for effective upgrades to such buildings.

Keywords: green building management, benefits and barriers, Hong Kong

1. INTRODUCTION

As part of the larger concept of sustainable building, green building is specifically defined as “the implementation of a sustainable design” (Montoya, 2010; Sillah, 2011). The design and construction of green buildings are based on the principle of sustainable development. To implement green building is to incorporate energy-saving features, water conservation, waste minimisation, pollution prevention, resource efficiency and indoor environmental quality enhancement in the building lifecycle, from siting to design, construction, operation, maintenance, renovation and deconstruction (Tam et al., 2012; Barnes, 2012). Most green building studies focus on the site, water, energy, material and indoor environment perspectives (Montoya, 2010). Sillah (2011) pointed out that in site layout and use for green construction, one goal is to reduce disturbance to the site to protect the surrounding habitat and environment. With regard to construction waste management, the employment of a waste management company and on-site waste sorting are effective ways to minimise construction waste (Glavinich, 2008). During the green building operation and maintenance phase, a post-occupancy evaluation can be made to test indoor air quality and energy use (Newsham et al., 2013). Zuo et al. (2014) conducted case study which shows that although green buildings have higher initial costs, residents’ long-term energy bills are significantly reduced. Kim et al. (2014) built a linear regression model to predict the lifecycle energy-saving trends of green buildings. Their lifecycle cost analysis demonstrated that the initial investment is recouped, with a profit earned over the entire lifecycle.

Hong Kong, one of the world's most recognisable cities, is characterised by a high-rise, high-density urban environment, which makes energy reduction more of a challenge than in many European and North American cities. At the same time, space and natural resource limitations mean that waste recycling and reuse are matters of urgency. According to a recent Hong Kong report published by Construction Industry Council and Hong Kong Green Building Council in 2014, almost 90 per cent of electricity in Hong Kong is consumed by buildings, which also account for 60 per cent of greenhouse gas emissions. Green building implementation is thus important to balance development and environmental concerns. However, there is a lack of quantitative and comprehensive

research focusing on the advantages of and obstacles to green building development in Hong Kong. Identifying the hurdles that are impeding such development is an urgent objective in the construction industry.

The aim of this paper is to elucidate the benefits of and obstacles to green building implementation in Hong Kong and to promote corresponding solutions. Content analysis and face-to-face interviews were used in the study reported herein to investigate the current green building development situation, laying the foundation for a further study on green building construction.

2. LITERATURE REVIEW

2.1 Benefits of green building

Green building is an environmentally friendly practice that is also conducive to social values (Tam et al., 2012). Its advantages are thus economic, social and environmental. The literature review identified several of the benefits of green building, which are listed as follows.

- Reduction in lifecycle cost. Yudelson (2008) pointed out that although the initial cost of a green building is 1 or 2 per cent higher than that of a non-green building, it offers long-term savings and a shorter payback period. Investment in green materials and technologies and the advance identification of potential problems with building operation make it easier to operate and maintain green buildings (Mathieson et al., 2008).
- Improving the health and efficiency of occupants. As Sillah (2011) and Ajilian (2014) state, green buildings offer a better indoor environment, including better indoor air quality, thermal comfort, clean water, effective lighting and a comfortable noise level, which brings health benefits to those who live and work in them. Working and living in a comfortable environment also promotes greater efficiency.
- Greater energy savings and efficiency. Studies suggest that many green buildings are designed to use 30-50 per cent less energy than traditional buildings, leading to significant energy efficiency improvements (Yudelson, 2008). Moreover, the energy-saving strategies adopted in green building design, such as green roof systems, active walls, Low-E glass, efficient HVAC and cooling systems, and light-emitting diodes, not only meet the requirements of users, but also save on limited energy resources (Kubba, 2010; Sillah, 2011).
- Lower environmental impact and preservation of ecosystem. As green buildings are designed and constructed in an environmentally friendly manner, a balance between building and ecosystem is sought throughout the building lifecycle. Such green strategies as renewable energy use and waste management can reduce energy consumption and the exhaust gas emitted into the environment, thereby protecting the ecosystem (Mathieson et al., 2008; Ajilian, 2014).
- Tax benefits and incentives. To create enthusiasm for green building development, many governments offer tax benefits and incentives in the form of cheaper land prices and green materials (Kubba, 2010; Zhang et al., 2011). Yudelson (2008) reported that, in the US state of Nevada, green buildings that achieve Leadership in Energy and Environmental Design (LEED) silver certification are eligible for tax abatement, and the state government also provides a sales tax rebate on green materials used in LEED silver-certified buildings.
- Market benefits. Many private and public developers and owners gain marketing benefits from constructing LEED-certified green buildings (Yudelson, 2008). For instance, green buildings promote product differentiation in the construction market and garner positive free press coverage (Sillah, 2011).

2.2 Barriers to green building

Although green building offers the numerous benefits outlined above, there are still obstacles to its implementation, such as higher transport, material and design costs relative to conventional buildings (Tam et al., 2012). The major barriers collected from the comprehensive literature review are listed as follows.

- Higher initial investments and costs. The initial cost of a green building is higher than that of a traditional building because of green requirements. Tam et al. (2012) pointed out that the larger initial investment needed results from the adoption of green and new technologies and the top-down construction method. Green building practices also need more time for implementation, which also increases costs (Richardson and Lynes, 2007; Sillah, 2011).

- Lack of public awareness and knowledge of green principles and technology. Although the number of green buildings has grown steadily in the past few years, green building remains a relatively new field, and green knowledge and technologies are still in the early stages of development (Sillah, 2011). Insufficient professional knowledge of and expertise in green technologies and methods lead to a vague understanding of the green building concept and a lack of awareness of the green tools and materials available, which hinders the implementation of green strategies.
- Lack of financial incentives and government support. The lukewarm attitude towards green building exhibited by the senior management of many development firms may directly or indirectly reduce the efficiency of green building practices (Lam et al., 2009). This lack of management support further deprives contractors of incentives to achieve green building goals. At the same time, insufficient government support often hinders green developers from accessing low-risk and affordable financial resources (Samari et al., 2013).
- Interest conflicts amongst stakeholders. As the initial cost of green buildings is higher than that of traditional buildings, the initial investment required of developers is also higher, whilst the benefits, e.g. a better indoor environment and reduced energy consumption, accrue primarily to tenants, resulting in an unequal distribution of benefits (Williams and Dair, 2007; Zhang et al., 2011; Hwang and Tan, 2012).
- Uncertainty and risks in investment and materials. Uncertainty and risks are greater in green buildings than in conventional buildings because they involve different contract types, methods of project delivery, and on-site practices and behaviour. Furthermore, when green buildings are completed, there is the risk of not obtaining green building certification (Glavinich, 2008).
- Lack of credible research and case studies on green building performance. There is inadequate information on green products and sustainable building systems to inform green building implementation (Hwang and Tan, 2012), as well as an insufficient number of case studies showing that green buildings have lower operating costs and greater environmental efficiency. Hence, the mainstream market does not realise the superior performance that green buildings offer (Sillah, 2011).
- Possible delays due to green requirements. As there are green material and green technology requirements in green construction, green buildings take longer to realise (Lam et al., 2009). In addition, unfamiliarity with green technologies can also result in delays in green design and construction (Zhang et al., 2011).
- Insufficient technologies strategies and time to drive green building. If there is not enough time and funding to support green building implementation, designers and constructors also have limited time to apply new green building technologies and strategies.

3. RESEARCH METHODOLOGY

The literature review carried out for this research identified six benefits of and eight barriers to green building implementation. To explore those benefits and barriers in the context of Hong Kong green building practices, four specialists in the green building construction sector were invited to participate in face-to-face interviews. They are all experienced BEAM professionals involved in Hong Kong green building development. Target specialists were contacted to determine whether they would be willing to be interviewed, and an interview guide introducing the research and giving details of the proposed interview was also provided for their reference. Each interview lasted about 30 minutes, and the questions focused on the current status of green building development in Hong Kong and the performance-related issues and barriers encountered in green building implementation.

According to the research conducted by Zuo et al., (2014), content analysis is a common approach for qualitative data analysis in built environment-related studies. In this research, qualitative content analysis was used to analyse the interview data. For qualitative content analysis, the emphasis is to determine the meaning of the data. So words or phrases which have similar meanings were noted in the analysis.

Coding is a process of segmenting and labelling text to form descriptions and board themes in the data. Coding was also conducted in this research to analyse the interview data. To conduct coding conveniently, the authors designed three columns one page, the interview record was shown in the middle column, codes that describing the text segment were written in the left column, and corresponding themes were in the right one.

4. RESEARCH FINDINGS AND DISCUSSIONS

4.3 Benefits of green building development in Hong Kong

Reducing energy consumption. Hong Kong has limited space and few natural resources, and green building developments, plans and actions have been formulated to reduce energy use. Examples include the establishment of the Buildings Energy Efficiency Ordinance and the Energy Audit Code.

Improving environment protection. Green building is an effective way of resolving pressing environmental issues such as global warming and climate change. By using green materials, technologies and strategies such as passive design, rainwater recycle systems, green roofs and green walls, buildings can reduce their impact on the environment and ecosystem.

Strengthening waste management. Hong Kong also has limited landfill space, and three-quarters of its land area is undeveloped or designated as country parkland. **A recent Hong Kong report showed the city's daily per capita domestic waste generation to be higher than that of other Asian cities, with construction waste accounting for nearly 25% of solid waste. Waste management can be improved through green building development and the wider application of "reduce, reuse, recycle" principles.**

Improving building liveability and occupant health. Green buildings improve the well-being of their occupants. When developing a green building, a green built environment is also involved, and when public space is designed in accordance with green standards, the entire district benefits.

Financial and market benefits. As noted, the government implemented a policy to promote green building development in 2011, i.e. the offering of GFA concessions to buildings that participate in BEAM PLUS, which has boosted the number of such buildings significantly. Developers that wish to participate in the system must undergo a BEAM PLUS assessment if they want to gain the concession.

4.4 Barriers to green building development in Hong Kong

Higher initial costs. The greatest obstacle to green building development in Hong Kong is the high initial cost. Developers must invest more in buildings that incorporate certain green features. Although green buildings may produce cost-savings over the entire building lifecycle, developers involved in speculative building are generally more interested in obtaining a quick return on their investment.

Insufficient market transformation. When looking to buy a property in Hong Kong, most members of the public are more interested in the proximity of public transport options, building materials and the appearance of the building than with green features, which are not seen as directly related to health and well-being. Hence, a green building market transformation needs to take place before green building implementation will become widespread.

Knowledge gaps. There are still a number of knowledge gaps concerning green building in the construction industry. Even when industry participants pursue the concept, they may be unaware of the best way to manage green building design, development or construction. Furthermore, the public does not yet value green features, which directly discourages developers from developing green buildings.

Lack of incentives for existing buildings. Unlike the GFA concessions available for new buildings, there are no direct incentives to implement green features in existing buildings in Hong Kong. Hence, few owners of existing buildings are willing to participate in assessments to obtain a green building rating. In fact, fewer than 10 existing buildings participate in BEAM PLUS.

Lack of incentives for the public. As electricity and water remain relatively cheap in Hong Kong, the general public has few incentives to pursue energy or water-saving measures. In addition, few people in Hong Kong relate global warming to their own lives or understand the effects it is likely to have on them or their children, and thus do not treat green features as an important factor in choosing a building in which to live.

Uncertainties and risks. Those applying for a green rating are often unsure about the rating they will attain, as there are numerous green projects and assessors with different assessment criteria. Moreover, it takes a considerable amount of time to obtain a very high rating, which can delay projects and increase costs.

4.5 Suggestions for green building development in Hong Kong

As there are many problems to be solved in Hong Kong, different parties have different priorities for resolving them. According to the interviewees, the most urgent challenges preventing more widespread green building implementation are the need for market transformation, a mind-set change and more promotion from the government.

Driving market transformation. Hong Kong enjoys a high level of technological advancement, which should make **it easier to drive market change. One of the interviewees' key suggestions for promoting green building in Hong Kong is to drive market transformation by supporting the government's establishment of related policies and regulations.**

Changing the public mind-set and behaviour. Key to changing the public mind-set is for the government to set a benchmark for general facilities. The government should also develop a way for owners to submit building data. If certain features fall below a certain standard, the government can then require that renovations be carried out. **Tenants' behaviour can be changed through education initiatives than convince them that green** behaviour and green building practices are beneficial to their quality of life and reducing costs.

More government incentives. The government and related organisations need to invest in more green promotion efforts targeting developers and the general public. The HKGBC has launched a number of marketing promotions, but more needs to be done. Existing buildings in particular are in urgent need of incentives for green feature implementation. Finding a way to incentivise developers to turn traditional buildings into green ones remains a challenge, although the HKGBC is currently in talks with the government to develop incentives for existing buildings.

Developing a platform for feedback. Developing an effective platform for feedback between end-users and the government or industry participants requires effective communication amongst those parties. It is very important to build both project-specific platforms and an industry-wide platform. For the former, post-occupancy evaluations are essential, as they allow the identification and notification of weaknesses. For the industry-wide platform, it is important that green building rating tools be improved to upgrade the assessment system.

5. CONCLUSIONS

Green building is an effective way of building a sustainable built environment. In the research reported herein, semi-structured interviews were conducted in Hong Kong to review the green building development process and related benefits, problems and solutions in conjunction with a review of the literature. The research findings suggest that the major problems with green building practice include higher initial costs than traditional buildings, insufficient market transformation, knowledge gaps, a lack of incentives for existing buildings and the general public, and uncertainties and risks (Lam et al., 2009; Zhang et al., 2011; Samari et al., 2013). To resolve these problems, the practitioners interviewed suggested that it is important to drive market transformation, change the mind-set and behaviour of the general public, implement more government incentives or regulations, and develop project- and industry-level platforms for communication. The interviewees further indicated that existing buildings constitute a major area for improvement to further green building development in Hong Kong. It is recommended that future research focus on how to make existing buildings more efficient or on the development of business models for effective upgrades to such buildings.

REFERENCES

- [1] Ajllian, H., 2014. Review of factors affecting sustainability in the universities. Thesis (Master), Michigan Technological University.
- [2] Glavinich, T. E., 2008. **Contractor's guide to green building construction: management, project delivery, documentation, and risk reduction.** John Wiley & Sons.
- [3] Hwang, B. G., Tan, J. S., 2012. Green building project management: obstacles and solutions for sustainable development. *Sustainable Development*, 20(5), 335-349.

- [4] Kim, J. L., Greene, M., Kim, S., 2014. Economic impact of new green building code on residential project development from energy consumption perspectives. *Journal of Green Building*, 9(4), 105-123.
- [5] Krippendorff, K., 2012. *Content analysis: An introduction to its methodology*. Sage.
- [6] Kubba, S., 2010. *Green construction project management and cost oversight*. Butterworth-Heinemann.
- [7] Lam, P. T., Chan, E. H., Chau, C. K., Poon, C. S., Chun, K. P., 2009. Integrating green specifications in construction and overcoming barriers in their use. *Journal of Professional Issues in Engineering Education and Practice*, 135(4), 142-152.
- [8] Mathieson, L., Morison, J., Connellan, G., 2008. Irrigation of urban green spaces: a review of the environmental, social and economic benefits. Cooperative Research Centre for Irrigation Futures.
- [9] Montoya, M., 2010. *Green building fundamentals*. Prentice Hall.
- [10] Newsham, G. R., Birt, B. J., Arsenault, C., Thompson, A. J., Veitch, J. A., Mancini, S., Galasiu, A. D., Gover, **B. N.**, **Macdonald, I. A.**, **Burns, G. J.**, 2013. Do 'green' buildings have better indoor environments? New evidence. *Building Research & Information*, 41(4), 415-434.
- [11] Richardson, G. R., Lynes, J. K., 2007. Institutional motivations and barriers to the construction of green buildings on campus: a case study of the University of Waterloo, Ontario. *International Journal of Sustainability in Higher Education*, 8(3), 339-354.
- [12] Samari, M., Ghodrati, N., Esmailifar, R., Olfat, P., Shafiei, M. W. M., 2013. The investigation of the barriers in developing green building in Malaysia. *Modern Applied Science*, 7(2), 1.
- [13] Sillah, A. (Ed.). 2011. *Green building: project planning and cost estimating*. Wiley.
- [14] Tam, V. W., Hao, J. L., Zeng, S. X., 2012. What affects implementation of green buildings? An empirical study in Hong Kong. *International Journal of Strategic Property Management*, 16(2), 115-125.
- [15] Williams, K., Dair, C., 2007. What is stopping sustainable building in England? Barriers experienced by stakeholders in delivering sustainable developments. *Sustainable Development*, 15(3), 135-147.
- [16] Yudelson, J., 2008. *Green building through integrated design (GreenSource eBook)*. McGraw Hill Professional.
- [17] Zhang, X., Shen, L., Wu, Y., 2011. Green strategy for gaining competitive advantage in housing development: a China study. *Journal of Cleaner Production*, 19(2), 157-167.
- [18] Zuo, J., Xia, B., Barker, J., Skitmore, M., 2014. Green buildings for greying people: a case study of a retirement village in Australia. *Facilities*, 32(7/8), 365-381.

Research on Development of a Guide for Environmental Study Classes Using Environment-conscious: Technologies of School Facilities

Go MIYAZAKI^a, Yusuke NAKAJIMA^b

^a Kogakuin University, Japan, dm16058@ns.kogakuin.ac.jp

^b Kogakuin University, Japan, yusuke@cc.kogakuin.ac.jp

ABSTRACT

In late years the introduction of the environment-conscious technologies such as photovoltaic power generation is increasing in school facilities. Environment-conscious technologies are demanded to be used by environmental education. However, it is the present conditions that the mechanism of the environment-conscious technologies is **out of teacher domain, so these technologies aren't used for environmental education.**

In a previous study, development of "the environment-conscious technologies guidebook" and its environmental learning contents were carried out. However, for the lack of the method of teaching and correspondence with a unit list, it was difficult for teachers to use it.

In this study, "the environment-conscious technologies guide" which incorporates an annual unit list of textbooks compliant with the environment-conscious technologies and example method of teaching was developed. The example method of teaching has time schedule and main point of teaching with some photographs and illustrations. Therefore, teachers are easy to understand the flow of the class. Using this example method of teaching, teachers can perform environmental study class by their own effort. As the result of trial classes using the guide, it was found that teachers could make documents for classes and explain them by their own effort.

Keywords: education and training, environment-conscious technologies, schools

1. INTRODUCTION

In school architecture in recent years, environment-conscious technologies such as photovoltaic power generation have been increasingly adopted not only at environment-conscious schools built to achieve building energy conservation and promote environmental education, but also at ordinary elementary schools. Since environment-conscious technologies are located in the student's immediate environment, there are expectations this will improve awareness of environmental problems, and thus there is a need to use these technologies in environmental education. However, for teachers, knowledge of the mechanisms of environment-conscious technologies is outside their specialization, and therefore at present even the environment-conscious technologies at environment-conscious schools are not adequately used for environmental education.

In past research, a proposal has been made to teach classes by producing an "environment-conscious technologies guidebook" to help teachers giving the class. However, it was found that the approach was inadequate to allow classes to be given by teachers alone because the explanations in the guidebook were still too difficult, and there was no correspondence with units.

Thus the purpose of this study was to develop a guide for environmental study classes incorporating an annual list of units bringing environment-conscious technologies into correspondence with the units in actually used textbooks, and a detailed example of how to proceed with the class.

2. ACTUAL SITUATION OF ENVIRONMENT-CONSCIOUS SCHOOLS AND ENVIRONMENTAL STUDY CLASSES ACCORDING TO PREVIOUS RESEARCH

Many environmental study classes in recent years have used social problems as a theme, and as part that, class formats are frequently based on observation, field trips and experiences in the area of coexistence with nature and garbage problems. However, with regard to global warming and energy conservation, classes do not often have an experience-based format using the environment-conscious technologies adopted in elementary schools.

On the other hand, in certifying environment-conscious schools, the Ministry of Education, Culture, Sports, Science and Technology asks each certified school to conduct environmental study classes using adopted environment-conscious technologies. A questionnaire survey regarding environment-conscious technologies and environmental study classes was administered to environment-conscious schools by our laboratory in 2013. According to this survey, current conditions are such that schools which actually hold classes are extremely few in number, about 70% of the schools for which questionnaires were returned. As problems, respondents frequently mentioned struggling with how to use environment-conscious technologies in class, i.e., **“It is difficult to think of class content,” and “I don’t know how to make use of adopted technologies.”** For this reason, there is thought to be a strong need for a guidebook on environment-conscious technologies.

3. ENVIRONMENT-CONSCIOUS TECHNOLOGIES GUIDEBOOK, PROPOSAL AND ISSUES

In drafting an environment-conscious technologies guidebook, existing instructional materials for environmental study from all over Japan were investigated, with a focus on determining whether they include material on environment-conscious technologies and energy problems. In the results, there were almost no instructional materials or guidebooks with content relating to environment-conscious technologies or energy problems.

Therefore in 2014, our laboratory drafted an environment-conscious technologies guidebook, and environmental study classes for elementary school students were conducted based on the environment-conscious technologies guidebook. In addition, an interview survey was conducted with teachers who used the environment-conscious technologies guidebook. The teachers’ opinions included: **“environment-conscious technologies are difficult because that content is not in the textbook,” “I don’t know which is the corresponding unit in the textbook,” and “it is easier to devise the structure of the class if there is guidance plan or something similar.”**

The above results indicate a need to draft materials so that the environment-conscious technologies guidebook includes an annual unit list for each school year, showing the correspondence with environment-conscious technologies, and a guidance plan matched to the structure of the environmental study class. In addition, teachers have only limited time to prepare the structure of an environmental study class, and thus there will likely be a need to make the materials easy to understand, by simplifying explanation of environment-conscious technologies, and adding illustrations and text.

4. DEVELOPMENT OF GUIDE FOR ENVIRONMENTAL STUDY CLASSES

5.1 Composition of the guide for environmental study classes and composition of each technology

In this study, it was decided to use the name **“guide for environmental study classes”** (indicated as the **“class guide”** below) for materials incorporating an annual unit list brought into correspondence with environment-conscious technologies for each school year, and a guidance plan suited to the structure of environmental study classes, into the previous environment-conscious technologies guidebook. This class guide was then developed.

Figure 1 shows the composition of the class guide. **“Chapter 1: Introduction”** incorporates the background behind preparation of the guide for environmental study classes, and an annual unit list corresponding to environment-conscious technologies. **“Chapter 2: Environmental problems (Global warming)”** describes the environmental problems which serve as the lead-in in environmental study classes, and the reserve-production ratios for fossil fuels. **“Chapter 3: Environment-conscious technologies adopted in schools and their use in classes”** describes examples of use for each technology to serve as a reference for environmental study classes. **“Chapter 4: Conclusion”** provides requests for the class guide user and a questionnaire to be filled out after use. In addition, the **“Materials section”** includes PowerPoint files for classes at schools which actually assisted with preparation of the guide, and worksheets that can be used as is in class.

Figure 2 shows a conceptual illustration of an environmental study class using the guide for environmental study classes. Having teachers conduct classes using the class guide improves awareness of environmental problems among teachers, children and parents/guardians, and may also be effective for conserving energy at school and home due to implementation of energy conservation activities.

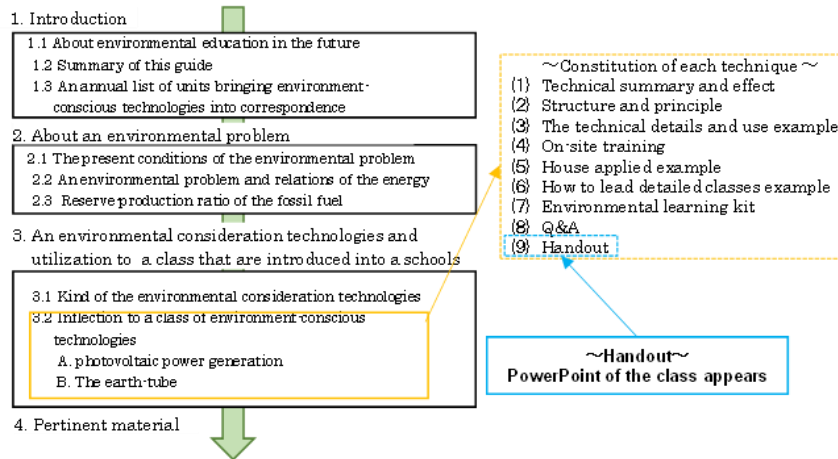

Figure 1: The composition of the class guide

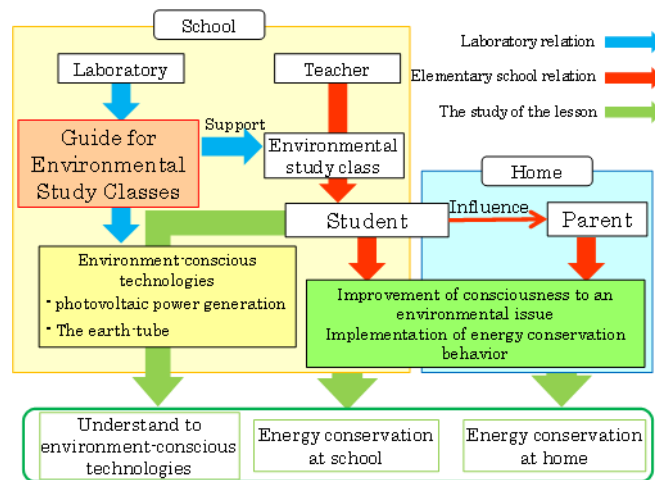

Figure 2: A conceptual illustration of an environmental study class using the guide for environmental study classes.

5.2 Selection of the types of environment-conscious technologies

Table 1 shows project types, nature of technology, and number of schools with renewable energy equipment installed (systems installed at 10 or more schools). There are many cases where photovoltaic power generation has been adopted, and thus this study examines this type of photovoltaic technology.

	The kind	Evaluation (The number of installation)
①	Photovoltaic power generation type	Photovoltaic power generation (7371)
②	The solar heat use type	Solar water heater (144)
③	Other new energy types	Wind power generation (610) Biomass generation of electricity (122) Earth thermal use (61) etc.
④	The wood use type	Use of an area wood
⑤	Energy saving and the resource-saving type	Drainage recycling etc.
⑥	The resource saving recycling type	Recycling building material Garbage disposer
⑦	The natural symbiosis type	Roof planting trees Building planting trees
⑧	Other	Natural lighting Natural ventilation

Table 1: Project types, nature of technology, and number of schools

5.3 Guidance plan on environment-conscious technologies (Example class)

Figure 3 shows an example of photovoltaic power generation for the “Composition of each technology ‘(6) Example of how to proceed with the class’” in Figure 1. Efforts were made to ensure that teachers can conduct classes easily by following the materials. This was achieved by simplifying the explanatory text, using plenty of illustrations and photos, and indicating guidelines for time allocation.

Figure 3: An example of photovoltaic power generation

5.4 Correspondence with curriculum and unit list in existing textbook

In bringing environment-conscious technologies into correspondence with the unit list in the textbook, the subjects were narrowed down to science, which can be easily brought into correspondence with environment-conscious technologies, and a publishing company was selected. The number of publishers established by the Ministry of Education, Culture, Sports, Science and Technology is 6 companies for elementary schools, and five companies for junior high schools.

In this study, as shown in Figure 4, three companies were selected which are frequently used in both elementary schools and junior high schools, and a correspondence was established with the unit list. Also, the content of environment-conscious technologies is difficult for students in the early years of elementary school. Thus it is likely best to provide this class for fourth-graders and above.

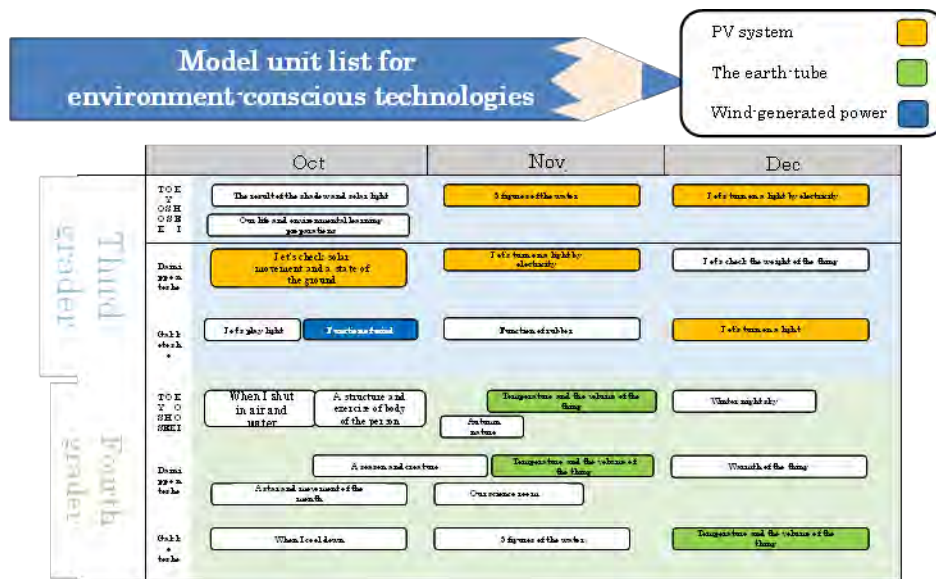

Figure 4: An example of an annual list of units

5. CONDUCTING CLASSES USING THE GUIDE FOR ENVIRONMENTAL STUDY CLASSES

5.1 Environmental study class using photovoltaic power generation

An environmental study class was held at elementary school A in Shinagawa Ward. The class was for fourth-graders in elementary school. Photovoltaic power generation was used as the content.

Figure 4 shows an example of a class using photovoltaic power generation. Four teachers were asked to carry out everything from preparation to actual classes by using class examples. Our laboratory provided support such as preparing equipment. Also, photovoltaic power generation is installed on the rooftop, and students cannot enter that area, so experience-based learning was carried out via a live link using video communication. In some cases, **classes by teachers proceeded in accordance with “the example of how to proceed with the class” in the class guide.** They were able to conduct classes without any major problems, and student reaction and degree of understanding were good.

5.2 Questionnaire for students after environmental study class

A questionnaire survey was administered to students after the environmental study class. Figures 5–8 show the survey results.

Figure 5 shows the items which generated the most interest in the class. The responses included: “Learning about the mechanism of solar power generation,” and “Putting a cloth (blackout curtain) on the solar panel.” It is evident that students have an interest in the mechanisms used to realize environment-conscious technologies.

Figure 6 shows responses regarding the ease of understanding a photovoltaic panel via a live link. Most students responded that they “understood” or “understood a little.” This shows they likely gained an adequate knowledge of the type of environment-conscious technologies installed at their own school.

Figure 7 shows the question of whether the students would like to know in more detail about the mechanism of **photovoltaic power generation.** **Of the answers, 90% were “I would like to” or “I would like to a little.” This was a class which used environment-conscious technologies not appearing in ordinary classes, and thus it can be said that students showed strong interest/concern.**

Figure 8 shows the question of whether the students would like to take an environmental study class again, led by the supervising teacher. Over 90% of the students responded: “I would like to” or “I would like to a little.”

Based on these results, it seems that teachers in charge were capable of providing adequately effective environmental classes.

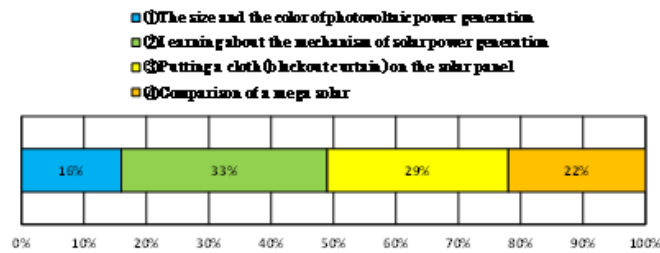

Figure 5: The items which generated the most interest in the class.

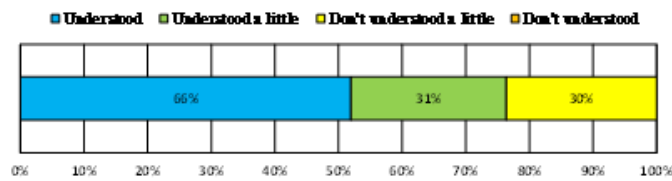

Figure 6: Responses regarding the ease of understanding a photovoltaic panel via a live link

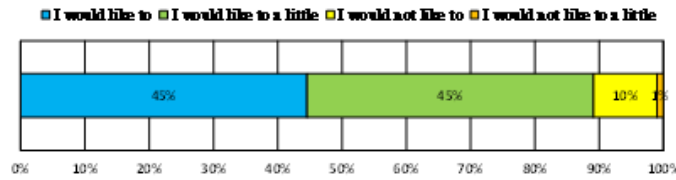

Figure 7: The question of whether the students would like to know in more detail about the mechanism of photovoltaic power generation.

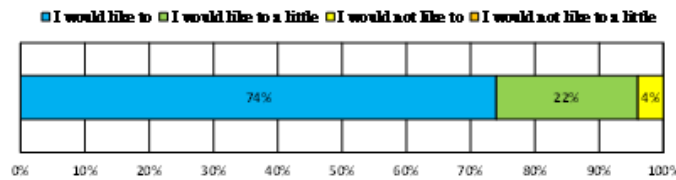

Figure 8: The question of whether the students would like to take an environmental study class again.

5.3 Questionnaire for teachers and consideration of plans for improving class guide

Elementary school teachers are in charge of many subjects, and thus the opinion was that it would be easier to prepare a class plan if there were a list of units corresponding to environment-conscious technologies. The view was also expressed, regarding the unit list and class example, that the layout and design are easy to understand.

For the PowerPoint presentation used in the class, on the other hand, materials were prepared comparing power consumption with other schools in the same ward in order to generate interest among the students. However, it is very difficult for teachers themselves to inquire with government offices and receive data. Therefore, the opinion was expressed that if data can be easily downloaded from a source such as the Internet, it will be possible for teachers to create class materials on their own.

6. CONCLUSION

In this study, class materials were prepared using the class example in the guide for environmental study classes, classes were conducted. By interviewing teachers, it was confirmed that teachers working alone are capable of preparing class materials and explaining the material to students by using the guide for environmental study classes.

As issues for the future, it will likely be necessary to create class plans which can be conducted by teachers in charge working on their own, and propose experience-based learning and experimental learning plans using only

the equipment available at schools. Also, when conducting environmental study classes on photovoltaic power generation, it will likely be necessary to call on the local government because it will be easier to conduct environmental study classes if communication equipment for live links is installed.

REFERENCES

- [1] Ryo Osone, Research on the environmental study utilizing method for the energy conservation measures in consideration of the living environment of the school, AIJ Kanto 2013
- [2] Syuzo Morita, Study on the environment consideration technologies and environmental study class in Eco-school, AIJ Kanto 2014

Track 7: Innovative Practices for Transforming SBE

Session 1.10: Green Infrastructure in SBE - Hong Kong Cases

Implementing the Beautification and Sustainable Designs for the Harbour Area Treatment Scheme (HATS) Stage 2A

Fergal WHYTE^a, David PICKLES^b, Mathew BAMM^c, Andrew LAI^d, WANG Shanshan^e, CHAU Kwok-ming^f, Anthony TSANG Kwok-leung^g

^a Arup, Hong Kong SAR, fergal.whyte@arup.com

^b Arup, United Kingdom, david.pickles@arup.com

^c Arup, United States of America, mathew.bamm@arup.com

^d Arup, Hong Kong SAR, andrew.lai@hats2a-arup.com

^e Arup, Hong Kong SAR, shan-shan.wang@arup.com

^f Drainage Services Department, Government of the HKSAR, Hong Kong SAR, henrykmchau@dspd.gov.hk

^g Drainage Services Department, Government of the HKSAR, Hong Kong SAR, kltsang@dspd.gov.hk

ABSTRACT

Drainage Services Department (DSD) and the Consultant collaborated on the conceptual design and implementation for beautifying Stonecutters Island Sewage Treatment Works (SCISTW) and demonstrated various sustainable features under Harbour Area Treatment Scheme (HATS) Stage 2A project. Such designs echo the policy initiatives in promoting sustainable built environments for Government facilities.

Upgrading works in expanding the treatment capacity at SCISTW include architectural and aesthetic designs of buildings and treatment facilities, both for existing and new ones. These include building facade with elevational treatment, grasscrete and porous paving, green roofs, as well as boundary and landscape planting. Beautification features specifically for future visitors at SCISTW include:

- Careful planning of visitor path with landscape enhancement works to balance visitor safety and experience in showcasing the basics of SCISTW operation, while minimising operation disturbance;
- Greeting visitors by water wall at sedimentation tank area, facing the main entrance. The water is replenished with recycled rainwater, a real-life application of rainwater harvesting; and
- Adopting sustainable materials including recycled glass-paving blocks and grasscretes at the new Main Pumping Station (MPS2) building.

Sustainable features include sustainable urban drainage systems (SUDS), for which multiple locations have been studied for pilot-testing. These include vegetated bioswales, permeable pavements, rain gardens, bioretention planters and rainwater harvesting. These SUDS will be evaluated with reference to overseas (USA and Singapore) SUDS experiences and manuals. Permeable pavers, one bioswale and one rain garden are currently undergoing test trial at the SCISTW and Chamber 15 sites. Localised design performance in reducing stormwater peak flow, runoff volume and pollutant loading will be evaluated through these installations.

Project-specific beautification design and detailed evaluation methodology and on-site performances of these sustainable designs in HATS Stage 2A project, and recommendations on their possible implementation in other similar built environments, will be presented in the full paper.

Keywords: green infrastructure, water management

1. INTRODUCTION

Since 2004, Drainage Services Department (DSD) of the Government of the Hong Kong Special Administrative Region has incorporated “integrating sustainability considerations into the design, construction and operation of our facilities” into their environmental policy. (Drainage Services Department of the Government of the Hong Kong Special Administrative Region, 2004). In the Hong Kong Climate Change Report 2015, the Government further

prioritized the exploration for blue-green infrastructures as a major mitigation measure to climate change. In a congested city like Hong Kong, however, implementing such sustainable features has always been a challenge, and such challenge becomes more prominent when the development is not a greenfield site. In consideration of the beautification and sustainable designs at the Stonecutters Island Sewage Treatment Works (SCISTW) under the Harbour Area Treatment Scheme (HATS) Stage 2A project, a good balance has been strived among the user convenience, site constraints and sustainability.

2. CONCEPT DESIGN CONSIDERATIONS

2.1 Planning principles

The introduction of beautification and sustainable urban drainage systems (SUDS) to HATS was first inspired by the Active, Beautiful, Clean Waters Programme implemented in Singapore starting from 2006, which aims to seamlessly integrate the environment, water bodies, as well as the community to create new community spaces and to encourage lifestyle activities to flourish in and around the waters (Public Utilities Board, Singapore, 2014). As the climate in Singapore is different from that in Hong Kong, localisation of the experience was crucial to the success. Three fundamental principles were derived to assess the design options for HATS, namely:

- During the construction stage, sustainable materials shall be selected to minimise the carbon footprint;
- During the operation stage, water and energy saving shall be achieved to enhance operation efficiency; and
- The sustainable features shall be hospitable towards visitors so as to establish a case to promote sustainability.

With these principles in mind, as well as the knowledge for the best practice both locally and internationally, the concept for water feature wall, landscaping visitor route, and SUDS to HATS has been proposed.

2.2 Design concept of water feature wall

To echo the client's identity and to grab the visitor's attention on arrival, a water wall of recycled rainwater will be positioned outside the chemically enhanced primary treatment (CEPT) tank facing the site entrance. Renewable energy installations such as solar panels and wind turbines would also be explored, in order to enhance the eco-friendliness of the water wall as well as to reduce the operation cost. As the first feature to greet the visitors, the running water and the sustainable thoughts behind it shall inspire the visitor's thoughts about the use of recycled water.



Figure 1: Water feature wall (Photomontage)



Figure 2: Flow-through planter (Photomontage)

2.3 Design concept of landscaping visitor route

The visitor route is designed such that the interference of visitors with daily operations of the plant is minimised while the places of interests can be seen along the designated visitor route. This arrangement provides a safe route for visitors. Exhibition boards could also be displayed alongside the route to fulfil the needs of visitors who

may have interests for more technical information. Along the route, the use of sustainable materials will also be demonstrated, such as the recycled glass-paving blocks and grasscrettes at the new Main Pumping Station (MPS2) building. Sub-routes are also developed to cater for visitors with different backgrounds, appealing to both the general public and professionals.

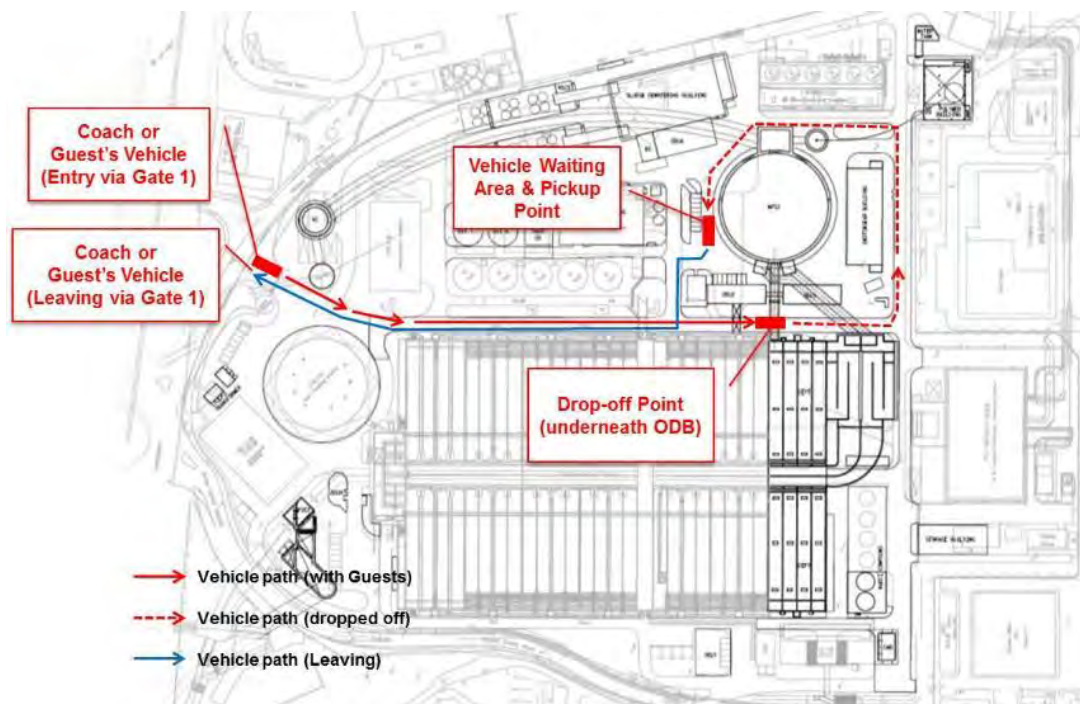

Figure 3: Visitor route for HATS: Vehicle circulation

2.4 Design concept of SUDS

SUDS refers to any stormwater greening technique, measure or device designed to retain and treat stormwater near the source of rainfall, thereby reducing the rate and volume of runoff discharged from the site and preventing pollutants from entering the drainage network and downstream water bodies. The reduced runoff could be further harvested to offset demands on the potable grid. Common SUDS measures include:

- Bioswale: A bioswale is a vegetated open channel used to treat and convey stormwater flows. Treatment action occurs along the surface of the swale by filtration through dense vegetation as well as by infiltration through the soil matrix and into the native soil.
- Rain garden: A rain garden is a shallow vegetated impoundment used to store and infiltrate stormwater runoff. Treatment occurs by infiltration through the soil matrix where pollutants are filtered out. Treated stormwater would infiltrate into the native soil or discharged via perforated subdrain.
- Flow-through planter: A flow-through planter is similar to rain gardens except it is contained within a walled container either as a raised planter box or in the ground. As with rain gardens, runoff is directed into an impoundment within the planter, stored and slowly infiltrated through the soil.
- Permeable pavement: Permeable pavement is a load-bearing surface used to allow infiltration of runoff through the pavement surface and into the soil below. Permeable pavements come in many forms including permeable “block” pavers, porous asphalt, porous concrete and grasscrete.

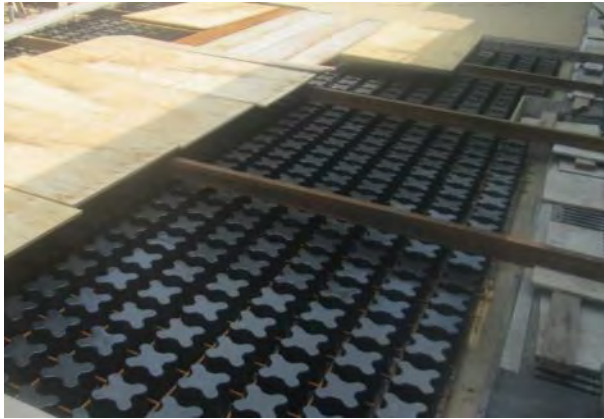

Figure 4: Grasscrete under Construction (1)



Figure 5: Grasscrete under Construction (2)

- Rain harvesting: Rain harvesting is a stormwater management technique that diverts stormwater from relatively clean surfaces such as roof and pedestrian paved areas into a temporary storage tank for reuse.

These options have been evaluated against several criteria as detailed in Table 1. It was concluded that the rain garden and the bioswale are most suitable for HATS, as they generally carry smaller footprints, have lower installation and maintenance costs, and are expected to improve the local biodiversity with the appropriate selection of plants.

SUDS Measures	Aesthetic Value	Maintenance Requirement	Installation Cost	Required Footprint	Ability to Improve Biodiversity	Qualitative Score (Max 45)
Priority Weighting	5	4	3	2	1	
Rain Garden	3	1	3	1	3	33
Bioswale	3	1	3	1	3	33
Flow-Through Planter	3	1	2	2	2	31
Rainwater Harvesting	1	2	1	1	0	18
Permeable Pavements	2	0	0	3	0	16

Performance Indicators:	Aesthetic Value	Maintenance Requirement	Installation Cost	Required Footprint	Ability to Improve Biodiversity	Score
	OK	Significant	Significant	Significant	Minimal	0
	Good	Moderate	Moderate	Moderate	Good	1
	Better	Minimal	Minimal	Minimal	Better	2
	Best	No Impact	No Impact	No Impact	Best	3

Table 1: Qualitative evaluation of SUDS options

3. DESIGN WITH SITE CONSTRAINTS AND NEW CONCEPTS

As HATS is not a greenfield development and the operation efficiency of the sewage treatment cannot be compromised, the implementation of the designed features faced challenges from unknown ground utilities, congested on-site traffic and the need for by-stage constructions to accommodate the critical construction activities. For SUDS, in particular, challenges also arose as there had been no previous use of such measures in Hong Kong. It therefore calls for by-stage constructions for better localisation of the SUDS design. Details of individual challenges are elaborated as below and illustrated how they are factored into the concept design.

3.1 Unknown ground utilities

Underground utilities are always key constraints to works at an existing development. Apart from the common utilities, such as stormwater drainage, sewerage, power cables and water supply system, there are numerous utilities that are specific for sewage treatment process, such as the centrate system, sewage culvert, signal cables, chemical pipe, etc.

Such constraints would impact on the design of the water feature wall, as its grey water recycling system needed to fit with the existing utilities. Surface runoff and roof drainage would be diverted to an underground grey water storage tank for screening and disinfection. The tentative alignment of the connection pipeworks has to avoid the conflicts with the existing utilities.

3.2 Congested on-site traffic

SCISTW is a centralised sewage treatment works for the CEPT treatment of the sewage generated from 17 preliminary treatment works. The frequency of the operational vehicles, such as chemical dosing trucks, sludge container trucks and other maintenance vehicles, are particular high. Coordination with the plant operator was required to obtain a thorough understanding of the logistics. Such understanding is necessary to avoid intrusion into the operating space and ensure that the maintenance requirement can be reasonably satisfied.

For example, one of the options for the visitor route proposed at an early stage was to make use of the road between sludge tanks with additional pot planters at the sides. Having learnt that the road would need to be cleared for occasional major maintenance, it was concluded that pot planters would be inconvenient during those occasions and the routing was reconsidered.

3.3 Need for by-stage construction

As a number of contracts were concurrently carried out at the SCISTW for achieving the full operation of the facilities of HATS Stage 2A, the construction of the planned beautification and SUDS works shall not affect the progress of the main works. To minimise the interface required, the construction of beautification works would be scheduled towards the end of the project, together with other landscaping works. SUDS was agreed to be implemented by stages, starting from a site trial at a nearby ancillary site called Chamber 15A. The by-stage construction also helped accrue knowledge and experience on the construction and performance of SUDS, as it is their first application in Hong Kong.

Since the rain garden and bioswale have been considered most suitable for the HATS project, they were selected to be the first ones for the site trial and were scheduled for construction in late 2016. It is anticipated that testing results will be published in early 2018 after the 12-month monitoring phase. The success of the site trial relied on the following aspects:

- Suitability of the selected location: The ideal locations of the site trial should not only minimise their impacts to the main works, but also be able to receive sufficient runoffs for meaningful test results. Careful studies on the contractor programme, site topography and utilities alignments were needed before deciding on the locations.
- Ease of sample taking: As water samples need to be collected over months, easy access to the samples should be planned at the design stage. Inspection manholes have been added to both inlets and outlets of the proposed rain garden and bioswale to facilitate the sample taking.

- Reliability of the test results: A detailed testing monitoring manual was issued to the Contractor to ensure the quality of sampling works. The manual has specified the requirement for regular maintenance, frequency of the sampling works, lists of equipment needed and the standard procedures. The pollutants proposed for testing included pH, temperature, conductivity, total dissolved solids, total suspended solids, nitrates/ nitrites, phosphorous, biological oxygen demand, chemical oxygen demand, copper, lead, zinc, oil/ grease, and faecal coliform.

4. VISION FOR FUTURE SUSTAINABLE DESIGNS

The experience gained from the design process would be beneficial to future sustainable designs in Hong Kong, as it represented the common challenges in most of the Hong Kong projects.

For the application of SUDS, in particular, the test results from the site trial would provide quantitative information for future cost-benefit analysis of similar facilities. At this moment without those test results, it is natural for clients and the public to view SUDS as white elephants since they are apparently considered more expensive with the need for frequent maintenance. In the case of the rain garden and bioswale, for example, monthly inspection and maintenance shall be carried out to clear the debris, prune and weed the vegetation, ensure the functioning of irrigation system, as well as to eliminate areas of stagnant water. However, the benefits of these facilities to the reduction of peak flows and pollutants into the municipal drainage systems are not intuitive. The site trials of SUDS carried out in HATS would bridge this gap for the clients and the public, allowing them to make more informed decisions for adopting sustainable designs in the future.

5. CONCLUSIONS

The design and implementation of beautification and sustainable initiatives in the HATS Stage 2A project face challenges common to most of the other Hong Kong projects. They would not have been solved without advanced knowledge of design requirements, thorough understanding of site constraints, and sufficient communications among stakeholders. The scientific data from the SUDS site trials as well as the project management experience would be beneficial to future sustainable developments in Hong Kong.

REFERENCES

- [1] Drainage Services Department of the Government of the Hong Kong Special Administrative Region, 2004. Environmental Performance Report 2004. [Online] Available at: <http://www.dsd.gov.hk/Documents/EPR/EPR2004/EN/2.htm> [Accessed 15 August 2016].
- [2] Environment Bureau in collaboration with Development Bureau, Transport & Housing Bureau, Commerce & Economic Development Bureau, Food & Health Bureau, Security Bureau of the Government of the Hong Kong Special Administrative Region, 2015. Hong Kong Climate Change Report 2015. [Online] Available at: <http://www.enb.gov.hk/sites/default/files/pdf/ClimateChangeEng.pdf> [Accessed 4 January 2017].
- [3] Public Utilities Board, Singapore, 2014. ABC Waters Design Guidelines. [Online] Available at: https://www.pub.gov.sg/abcwaters/Documents/ABC_DG_2014.pdf [Accessed 2016 September 12].
- [4] San Francisco Public Utilities Commission, 2016. San Francisco Stormwater Management Requirements and Design Guidelines. [Online] Available at: <http://sfwater.org/modules/showdocument.aspx?documentid=9026> [Accessed 12 September 2016].

Building Water Resilience in Sustainable Neighbourhoods: A Progressive Shift in Hong Kong

Edmond WF LIU^a

^a Water Supplies Department, Government of the HKSAR, Hong Kong SAR, edmond_wf_liu@wsd.gov.hk

ABSTRACT

Hong Kong lacks fresh water resources. In the past, the government coped with the increasing water demand due to population and economic growth by a 3-pronged water supply, viz. local yield, seawater for flushing and imported raw water from Dongjiang in Mainland China. In the face of climate change challenges in the city and Pearl River Delta region in southern Mainland China, a progressive shift on the water resources management has been underway in the city since the promulgation of Total Water Management Strategy for Hong Kong in 2008. A number of initiatives are being implemented at both the city and neighbourhood scales to strike an optimal balance between the demand and supply of water resources.

This paper introduces the holistic approach and adaptive actions taken in Hong Kong in driving for sustainable use of water resources against the vulnerabilities under the climate change. The paper focuses on the inter-connected initiatives and opportunities at the neighbourhood level in Hong Kong which help strengthen resilience by transforming the water-related infrastructures into beneficial assets for sustainable built environment and a better living. Examples on water reclamation, greywater recycling and the smart water supplies network management system at a district level will be discussed with highlights on their roles, synergies and co-benefits towards sustainable neighbourhoods. The paper indicates that the water management measures at the neighbourhood level will continue to be crucial elements for integration into the overall water management strategy in building towards resilience to accommodate the densely populated metropolitan city as a sustainable habitat for generations to come.

Keywords: sustainable neighbourhood, climate change, total water management strategy, water reuse, water loss management

1. INTRODUCTION

Hong Kong is one of the world's metropolis, with a total area of about 1,100 km² and over 7 million population.

Providing an adequate water supply for Hong Kong has always been a challenge because there are no natural lakes, rivers or substantial groundwater resources. Our rainfall is abundant with an average of about 2,400 mm each year but it fluctuates from heavy rainfall up to 400 mm per month during the summer to minimal rainfall during the dry winter months. Although about one-third of Hong Kong's land has been gazetted as water gathering grounds where surface runoff is collected for potable use, local yield is insufficient to meet the increasing demand of potable water to support the economic and population growth, which amounts to 973 million m³ (mcm) in 2015. Besides, the yield is unstable varying from 103 to 336 mcm/ year in the past 20 years.

Despite the inadequate natural water resources, Hong Kong has been enjoying reliable round-the-clock supply in the last thirty years. Over the years, Hong Kong has attained water security through innovative solutions including, (i) using seawater for flushing since 1957, (ii) importing freshwater from Dongjiang (DJ) in Guangdong province since 1965, and (iii) building impounding reservoirs including the two reservoirs built in the sea namely the Plover Cove and High Island Reservoirs in the 1960s and 1970s. At present, DJ water caters for 70 to 80% of the freshwater consumption in Hong Kong. There has been no water rationing since 1982. Yet, Hong Kong is facing challenges in the years ahead.

2. TOTAL WATER MANAGEMENT STRATEGY

Uncertainties due to climate change increase the risk of drought, not only in Hong Kong but also the Pearl River Delta (PRD) region. Although Hong Kong has adequate supply of DJ water even in drought condition, as a good partner to other PRD municipalities, we play a part in tackling this global challenge, and have developed and

implemented the Total Water Management (TWM) strategy for sustainable use of water resources since 2008. The strategy was initially formulated up to 2030 and is currently under review for period beyond 2030 in adapting to climate changes impacts.

The TWM strategy adopts a holistic and forward looking approach at both the city and neighbourhood scales emphasizing on an optimal balance by curbing water demand growth through conservation while strengthening water supplies management. On the demand side, the multi-pronged, community-wide water conservation measures in collaboration with stakeholders and the public and territory-wide water loss management programmes are being implemented. As for supply management, Hong Kong has been expanding its seawater flushing system and has increased its coverage from 80% to 85% of the population to save freshwater. Apart from the existing 3 water sources, viz. local yield, seawater for flushing and imported DJ water, Hong Kong has been actively exploiting 3 additional sources, viz. reclaimed water, recycled grey water/ rainwater harvesting and desalinated water, thus enhancing the supply from 3 to 6 prongs in the 2020s. Further, the TWM strategy achieves water conservation via multi-faceted soft and hard measures by encouraging active participation, commitment and cross-sectoral **collaboration from government, stakeholders and the public. These include establishment of a “Water Resources Education Centre”, launching of the “Cherish Water Campus” for primary school students, and “Let’s Save 10L Water” campaign as well as a 5-day Water Conservation Week held in November 2016 where government, green groups, schools, trades and the public join hands to promote water conservation.**

3. BUILDING WATER RESILIENCE AT NEIGHBOURHOOD LEVEL

Under the TWM strategy, opportunities have been identified from the demand and supply perspectives for implementation of inter-connected initiatives at the neighbourhood level for the quest of sustainable use of water resources in Hong Kong. It is achieved by the transformation of water-related infrastructures into beneficial assets to build and strengthen water resilience for sustainable built environment and a better living. The success of the transformation requires the timely planning and implementation of the relevant schemes under the respective initiatives, viz. (a) water reclamation in north-eastern part of the New Territories (NENT), (b) pilot scheme for greywater recycling at Anderson Quarry Development (AQR) development, and (c) smart water supplies network.

3.1. Water reclamation in north-eastern part of New Territories

In Hong Kong, the use of seawater for flushing has been a cost-effective solution to save precious fresh water resources. However, for those areas that are far from the sea, such as North-eastern part of the New Territories including Sheung Shui and Fanling (SSF), the cost of installing seawater supply networks for toilet flushing is high. With a view to supporting the development of NENT New Development areas (NDA), the government needs to expand Shek Wu Hui Sewage Treatment Works and upgrade its treatment technology to tertiary level to ensure that the additional effluent from the sewage treatment works will not increase the loading to the Deep Bay.

The government makes use of this opportunity to produce reclaimed water that could be used for toilet flushing and other non-potable uses as appropriate by further upgrading the quality of the tertiary treated effluent from the Shek Wu Hui Sewage Treatment Works to an acceptable water quality standard. The upgrading of the water quality could be achieved by an additional simple process of chlorination with sodium hypochlorite solution. The reclaimed water would then be pumped to the reclaimed water service reservoir for distribution to customers.

The use of reclaimed water in NENT, for the replacement of freshwater for toilet flushing and other non-potable uses, can save precious freshwater resources and alleviate the loading of existing water treatment works and fresh water supplies system. It also helps minimize the discharge of treated sewage effluent, and the associated stress and impact to the environment. It can also save the substantial capital investment for the infrastructures for sewage effluent discharge.

The government is currently taking forward the initiative to supply reclaimed water for toilet flushing and other non-potable use in NENT starting with SSF in phases from 2022 onwards. Planning and design of the different phases of the associated infrastructures are in progress and the construction works will commence in stages from 2017. In addition, the study on the financial and legal framework for supply of reclaimed water is also being undertaken.

At the ultimate stage, the reclaimed water supply will serve about half a million of population in the NENT, and by then the seawater and reclaimed water networks in the city will altogether provide flushing water to about 90% of

the population. The use of reclaimed water in the neighbourhood level in NENT will save a corresponding amount of fresh water consumption. The government will continue to study the feasibility of supplying reclaimed water in other areas without seawater for flushing at neighbourhood scale.

All in all, the water reclamation initiative at the neighbourhood level brings synergies and environmental benefits, in terms of reduced water pollution loading as well as achieving water conservation. It enhances the overall water security and hence the adaptation to the challenge of climate change.

3.2. Pilot scheme of greywater recycling at Anderson Road Quarry project

The exploration of grey water recycling (and rainwater harvesting) as an alternative water resource is another initiative under TWM. The government has begun planning a pilot scheme to supply recycled grey water for flushing purposes in the Anderson Road Quarry (ARQ) development project. The 40-hectare ARQ site used to be a quarry for the supply of aggregate, asphalt and concrete in supporting the construction works in Hong Kong since 1950s, and has been planned for residential development with 25,000 target population.

The grey water recycling facilities to be operated by the government centrally in the development, alongside with other planned smart water initiatives such as an artificial flood attenuation lake cum park, an underground stormwater storage tank, rainwater harvesting system, bioretention system, and porous pavement, are being explored and proposed in the ARQ development site. These green initiatives aim to facilitate sustainable use of water resources, and alleviate flooding with benefits of creating a healthy and harmonious environment in the ARQ development which also have beneficial effects to the revitalisation of Tsui Ping River downstream and its neighbour areas.

The geographical location of ARQ at the elevated platform of approximately +200mPD provides an invaluable opportunity to launch the pilot scheme of the public grey water recycling system for toilet flushing as an alternative to the conventional flushing supply of seawater. Grey water from wash basins, baths, showers, dishwashers, laundry machines and kitchen sinks etc. in blocks of residential buildings at the neighbourhood scale, in the ARQ development, would be collected via a separate collection pipework system for treatment in the grey water recycling plant in the development. Membrane BioReactors (MBRs) plus disinfection could be adopted for treatment of the collected grey water for flushing purpose. The recycled grey water, will be pumped to the recycled grey water service reservoir before distributing to the customers for toilet flushing in the ARQ development.

The grey water recycling system helps manage the water entering and leaving the AQR development at the neighbourhood level. It provides an efficient short circuit between disposal of the greywater and supply of flushing water via interflows which would otherwise need to be dealt with in the water loop at the territory level. Such territory-wide water loop would entail (i) the transport of the concerned grey water with other sewage via the sewerage system to the Stonecutters Island Sewage Treatment Works, at more than 10 km from the AQR development site, for further treatment before disposing of to the sea, and (ii) the intake of seawater via a pumping system for the provision of flushing water to the ARQ development which is about 3 km from the sea.

The grey water recycling does not only save the pumping energy required to lift the seawater for flushing to the elevated platform at 200m height but also reduces the overall lengths and hence the maintenance/ repair costs of the flushing water supply lines as well as the social disruption and complaints that may arise from leaks and bursts of the watermains operating at high pressure. Last but not least, the grey water recycling system reduces the impacts to the water quality of the receiving water body through reduction of effluent discharge.

The government will continue to work on the scheme layout for the grey water recycling system in the AQR development and will take it forward to the investigation and detailed design stage as well as resolving issues related to the grey water recycling such as amendment of existing legislation, incorporation of new land lease conditions and implementation of separate grey water collection systems both within the buildings and in the development.

Separately, the government is also taking the lead in implementing grey water reuse and rainwater harvesting in government projects through the promulgation of the joint technical circular of the Development Bureau and Environment Bureau. The government has been working with the Hong Kong Green Building Council to promote wider adoption of water recycling in private buildings through the Building Environmental Assessment Method

(BEAM) Plus scheme. Water recycling proposals adopted in the design of a building will be eligible for credits under BEAM. In so doing private developers are encouraged to implement water recycling systems both in new developments and renovation projects as well as in existing buildings.

3.3. Smart water supplies network for water loss management

With the substantial completion of the 15-year territory-wide replacement and rehabilitation programme of about 3,000km of aged water mains in end 2015, the condition of the water distribution network in Hong Kong has been returned to a healthy state. Both the number of bursts and leakage rate have been significantly improved.

Water loss management has been one of the key elements under the TWM. With the significant improvement in the healthiness of the water supplies network, the government switches the strategy from large-scale replacement and rehabilitation programme to a smart network management for maintaining the healthiness of the network in a cost effective way. Riding on the development of the advanced technology and with reference to overseas experience, the government plans to establish progressively the Water Intelligence Network (WIN), through the division of the water distribution network in the territory into some 2,000 District Metering Areas (DMAs)/ pressure Management Areas (PMAs) at the neighbourhood scale.

The DMA is defined as a discrete area of water distribution network established by the closure of boundary valve(s), and the water supply into the area is metered and monitored. The DMA can also be established as PMA to reduce the excessive pressure in the watermains within the area whilst adequate supply pressure to customers is maintained. DMAs and PMAs are equipped with monitoring and sensing equipment to collect network operation data, such as time-series flow into the area in particular the night flow, pressure data and other associated network data, for analysis of the water loss of the area.

The set-up of DMAs/ PMAs in a water distribution network at the neighbourhood level for water loss management, has a number of advantages. It has been very difficult to locate problematic locations in a large distribution network. Active leakage control as well as detection of unauthorized consumption in the smaller DMAs are more efficient, and leaks in the underground watermains could be identified by means of minimum night flow monitoring. Furthermore, pressure optimization can be implemented in the DMA to make it a PMA as well.

The set-up of DMAs under WIN at neighbourhood/ district levels help monitor the conditions of the water supply networks in individual DMAs continuously. Real-time monitoring can also be carried out when necessary. WIN will enable the determination of the most cost-effective network management measures or a combination of measures for the individual DMAs from the 4 pillars of actions, viz. (i) active leakage detection and control, (ii) pressure management, (iii) speedy and quality repair, and (iv) asset management by rehabilitation/ replacement of aged watermains which are beyond economic repair. In gist, it will enable timely preventive actions to be taken to ensure network healthiness, and thereby minimises water main bursts, leakage and inconvenience to the public and associated complaints in individual neighbourhoods. WIN can also prioritise the DMAs for action.

WIN strengthens the water loss management of the water distribution network at the neighbourhood level and enhances the water demand management contributing to the water resilience of the city.

4. CONCLUSION

The government has been planning for implementing various total water management initiatives at the neighbourhood level, including water reclamation at NENT, pilot scheme for grey water recycling at AQR development and smart water supplies network for water loss management. These initiatives are crucial elements for the individual neighbourhoods and also for integration into the overall TWM strategy. They will contribute and showcase the creation of efficient, integrated and resilient neighbourhood water infrastructures. The water resilience built by these infrastructures is of paramount importance to the growth of this metropolitan city.

It is expected that more sustainable water management developments would be continuously planned and built at both the neighbourhood and city scales to make Hong Kong a sustainable habitat for generations to come.

REFERENCES

- [1] Development Bureau & Environment Bureau, April 2015, Development Bureau Technical Circular No. 2/2015 & Environment Bureau Circular Memorandum No. 3/2015
- [2] Hermanowicz, S., and Asano, T., 1999, Abel Wolman's "**The Metabolism of Cities**" Revisited: A case for Water Recycling and Reuse, *Water Science Technology* Vol. 40, No. 4-5, pp. 29-36.
- [3] Judd, S., 2011, *The MBR Book - Principles and Applications of Membrane Bioreactors for Water and Wastewater Treatment*, 2nd Edition, Elsevier, Oxford (UK).
- [4] Metcalf & Eddy, Inc. an AECOM Company, Asano, T., Burton, F., Leverentz, H., Tsuchihashi, R., and Tchobanoglous, G., 2007, *Water Reuse: Issues, Technologies, and Applications*, Metcalf & Eddy, New York.
- [5] Water Supplies Department, 2008, *Total Water Management in Hong Kong*
- [6] Water Supplies Department, <http://www.wsd.gov.hk> [Retrieved on 30 September 2016]
- [7] Water Supplies Department, May 2015, *Technical Specifications on Grey Water Reuse and Rainwater Harvesting*
- [8] Wong, W. M., September 2016, Adoption of Smart and Green Initiatives in Development of Anderson Road Quarry Site, HKIS Annual Conference 2016.

Integrating Water Management Facilities into The Built Environment – A Smart Green Resilient Approach

Kenneth KWOK^a, LAU Wing-kam^b, CHUI Wai-lok^c, YAU Ka-tai^d, Katy FUNG^e, Peter CHAN^f

^a Arup, Hong Kong SAR, kenneth.kwok@arup.com

^b Civil Engineering and Development Department, Government of the HKSAR, Hong Kong SAR, wklau@cedd.gov.hk

^c Civil Engineering and Development Department, Government of the HKSAR, Hong Kong SAR, wlchui@cedd.gov.hk

^d Planning Department, Government of the HKSAR, Hong Kong SAR, ktyau@pland.gov.hk

^e Planning Department, Government of the HKSAR, Hong Kong SAR, kcwfung@pland.gov.hk

^f Arup, Hong Kong SAR, peter-ly.chan@arup.com

ABSTRACT

The Planning and Engineering Study for Housing Sites in Yuen Long South (YLS) has addressed critical issues relating to flood risk, water supply and wastewater treatment by adopting a Smart Green Resilient approach and integrating water management cycle at the heart of the sustainable planning, design and delivery process.

Throughout the planning and design to optimise the development potential of the degraded brownfield land in YLS **for accommodating about 85,000 population, “water” has been used as a powerful “integrator” that delivers multiple benefits** in supporting the development needs.

Examples of “water” strategies formulated in the YLS development include:

- Smart use of existing combined 3.5km long of concrete-lined drainage channel dissecting various parts of the YLS development for enhancing pedestrian connectivity and traffic safety by partially decking parts of the channels whilst creating scenic open space for enjoyment by local and future residents by revitalising the channels through various hard and soft landscaping treatment.
- Green and sustainable use of treated sewage effluent (TSE) produced by the proposed on-site tertiary sewage treatment works for non-potable water supply including toilet flushing and irrigation. Further polishing of the TSE will be provided in a created reedbed, for environmental enhancement and public enjoyment.
- Resilience built in through introduction of stormwater retention facilities that encompass a 1km long hillside river and provision of a retention lake to attenuate the increase in runoff from YLS in order to mitigate the drainage impacts to the downstream drainage system in the urban area of Yuen Long New Town. Footpaths and cycle tracks will be incorporated into the design of the hillside river and the retention lake to integrate functional facilities.

Keywords: smart, green, resilient

1. INTRODUCTION

1.1. Project background

The Yuen Long South (YLS) area has suffered from proliferated spread of open storage yards, warehouses and industrial workshops, resulting in degradation of its originally rural environment and setting. With growing pressure on land for housing supply and public aspiration of better use of degraded brownfield land for development, the Planning Department and the Civil Engineering and Development Department of the Government of the Hong Kong Special Administrative Region (HKSAR Government) have jointly commissioned the Planning and Engineering Study for Housing Sites in Yuen Long South (the Study), to examine the future land use, optimise the development potential, and ascertain the feasibility for public and private housing developments in the YLS area.

Taking into account territorial development needs as well as local characters and community aspirations, the Study has developed a vision of creating a sustainable, green and liveable community in YLS through provision of essential infrastructure to cater for the future development needs and improving the existing rural environment. The planning and urban design principles for YLS are outlined below:

- Creating an urban to rural experience

The YLS development will integrate with its settings by designating higher density developments in the north near Yuen Long New Town transitioning to medium and low-density development in the south to blend in with the rural setting and the Tai Lam Country Park. A network of bicycle paths, including a scenic cycle track along the hillside river corridor will be provided and active agricultural land retained, to connect urban neighbourhood and the surrounding rural area.

- View corridors and breezeways

The gradation of development intensity and stepping building heights allow developments to optimise views to the mountainous backdrop of the Tai Lam Country Park, which also help wind deflection and avoid air stagnation.

- Creating open space and green network

Open space of various scale and functions together with the preserved active agricultural land, secondary woodland, natural streams as well as revitalised nullahs will form a comprehensive open space and landscape network to meet leisure and recreational needs while creating identity and character for YLS.

- Providing major focal points and key activity spine

A key activity node with public transport interchange will be provided at each residential community providing commercial, community, recreational and public transport facilities with comprehensive pedestrian and cycling network connection. Walkable communities with good provision of public transport will be created in YLS.

- Revitalisation of Nullahs

The existing nullahs in YLS are valued as key assets. They will be revitalised to reach their full potential as an attractive public realm, and functions as part of the sustainable drainage system for YLS to cope with climate change. The revitalised nullahs will provide a natural feel in the urban context and act as key north-south connectivity corridors. In line with the advocate of integrated blue-green infrastructure system and aspiration to improve aesthetics and ecological value of the land, a green and eco-hydraulics approach will be applied to improve aesthetic whilst maintain and compensate for the hydraulic performance of the channel.

In order to promote public ownership of the outcome and build community consensus for the YLS development, the Study has gone through a comprehensive and well-designed community engagement programme to present and seek views from the public on its plans and proposals.

1.2. Study area

The YLS area is located in proximity to Yuen Long, Tuen Mun and Tin Shui Wai New Towns, and the proposed new development area in Hung Shui Kiu. It is also surrounded by and integrated with various valuable landscape and ecologically important features, including woodland, Tai Lam Country Park, streams discharging to the existing nullahs, an abandoned egretry at Tai Tong and an active egretry at Pak Sha Tsuen.

The area is generally rural in character but occupied by a mixture of brownfield uses, including open storage yards, warehouses, workshops, industrial operations, with villages and residential settlements, agricultural land and unused land scattered in between.

The YLS development on completion can be broadly defined into five planning areas, consisting of three distinct residential communities, a Green Zone and an Employment Belt as illustrated in Figure 1.

The Study Area encompasses a combined 3.5km long of concrete-lined drainage channel dissecting various parts of the YLS development. Opportunity to transform these grey concrete nullahs into potentially attractive blue-green infrastructure system to improve its aesthetic and the environment is a key part of the Study objectives.



Figure 1: Proposed Yuen Long south development

1.3. Key challenges on water management

This Study will formulate stormwater drainage; sewerage conveyance, treatment and disposal; and water supply strategies and infrastructure proposals to support the housing development in YLS. The integrated water management planning and design needs to overcome the following key challenges:

- Conflicting traffic and flood protection requirements

There are existing drainage channels that run through the Study Area. Whilst they serve the important function of providing land drainage and flood protection for the immediate and upstream catchments, their alignment dissect the local community and affect the traffic circulation. Their concrete-lined surfaces are not appealing to the public as illustrated by the photos in Figure 2. There have been strong requests from some public to deck the drainage channels to provide space for improving the existing road network.



Figure 2: Photos of existing Yuen Long Nullah

- Potential adverse drainage impacts

The 183 ha of development area will increase paved surface and runoff discharge to the downstream existing drainage system in Yuen Long and Tin Shui Wai town centre, which has limited conveyance capacity to handle additional flows. The impact will be exacerbated with climate change with higher rainfalls and sea levels are anticipated in the future. The associated drainage impact needs to be mitigated to avoid increase in flood risk to the existing Yuen Long town centre.

- Inadequate existing sewerage infrastructure

The proposed development will generate some additional 23,000m³ per day of sewage flows. Although some of the existing sewerage conveyance, treatment and disposal infrastructure are being upgraded currently to support the rapid development of the existing sewage catchment, their expanded capacities are still inadequate to serve the increase in sewage flows. Further extensive upgrading works or new on-site sewage treatment facilities will be required.

- Requirement of Sewage Effluent Discharge to Receiving Water Body

The treated sewage effluent (TSE) from the proposed development will discharge to Deep Bay, which is a “stressed” water body in terms of water quality. To protect the water quality in Deep Bay, there is a stringent requirement that there should be no “net increase” in pollution loading due to the proposed development, meaning that the TSE still cannot be discharged to the downstream Deep Bay. Either effluent reuse or export scheme will be needed for the development.

2. SMART GREEN RESILIENT APPROACH TO WATER MANAGEMENT

2.1 General approach

The 2015 Policy Address proposed to adopt the concept of revitalising water bodies in the planning of drainage networks for new development areas of Hong Kong to build a better environment for the public (HKSAR Government, 2015). It aims to integrate environmental and ecological considerations in the design of drainage **infrastructure to create a better living place. The HKSAR Government is also promoting the application of “blue-green infrastructure” to improve the sustainability and resilience of Hong Kong’s drainage system to meet the contemporary public aspiration in respect of the natural environment and protection of the local culture and rural lifestyle (Drainage Services Department, 2015).**

The Study has fully adopted these intentions into the heart of its planning and design principles. In addressing critical issues relating to flood risk, water supply and wastewater treatment, the Study has used an integrated water management approach by adopting a Smart Green Resilient concept (Lau et. al., 2016) and integrating holistic water cycle management into the sustainable planning, design and delivery process. The proposed strategies will achieve wider benefits beyond their primary functions, as defined in Figure 3.

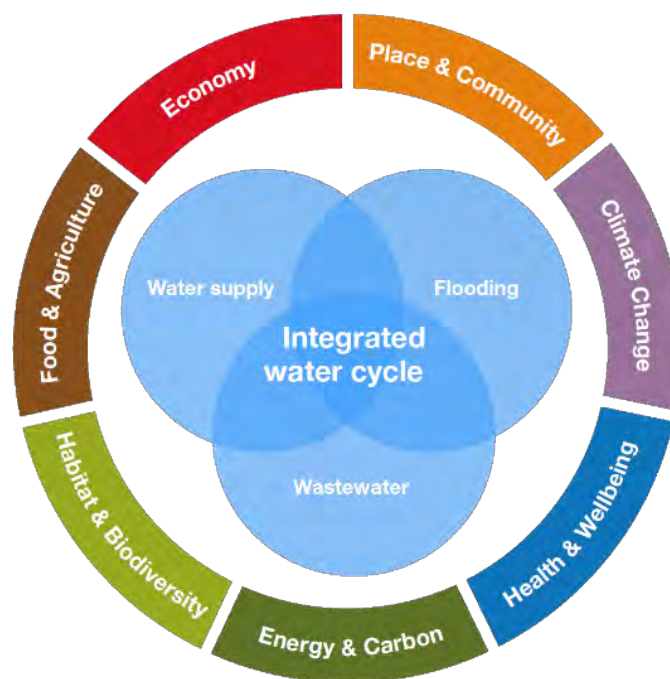

Figure 3: Placing an integrated water cycle at the centre of design to deliver multiple wider benefits (Arup, 2013)

Below are some examples of integrated water management strategies that have been applied to YLS, to deliver multiple benefits to the development based on a smart green resilient approach.

2.2 Smart use of existing combined 3.5km long concrete-lined nullah

To address current road safety concerns and meet future traffic needs after YLS development, decking of the existing Yuen Long Nullah will be required to create space along some sections of the Kung Um Road and Kiu Hing Road for road improvement works. Instead of investing in otherwise traditional large underground concrete structure for drainage with tarmac on top for road, we have adopted a partial decking design and proposed to revitalise the existing concrete-lined trapezoidal Yuen Long Nullah to form an aesthetically pleasant viewing corridor with integrated soft and hard landscaping themes. To compensate for the reduction in the hydraulic capacity due to the partial decking and revitalisation of the existing nullah, new box culverts are proposed that will run parallel with the existing nullah to increase its conveyance capacity.

There have been many successful international examples of regeneration of urban drainage channels, e.g. Cheonggyecheon in Seoul. Various hard and soft landscaping treatments and features will be applied to improve aesthetics, e.g. softscaped treatment of the bottom and the sides of the nullah to allow enhancement of biodiversity and visual integration, involving the use of low-maintenance planting at various levels.

To enhance pedestrian connectivity both internally and externally, it is also proposed to create the pedestrian spine along the sides of the revitalised Yuen Long Nullah. The pedestrian corridor with decent landscaping, comprising those planned along the proposed roads and improvements to existing ones, are highly visible and will link up major destinations. In terms of external connectivity, it is intended for the pedestrian network to tie in with the existing footpath in Yuen Long New Town. A cycle track is also proposed along the southern part of Yuen Long Nullah for public enjoyment and more importantly, for connecting the scenic cycle track to the woodland, natural stream as well as the proposed hillside corridor and reedbed, forming part of the recreational network for visitors and residents to enjoy the ambience of the green environment.

The partial decking design would also provide the opportunity to widen and upgrade the existing roads leading to Yuen Long New Town to facilitate traffic flow and improve the existing congested traffic condition.

Key Activity Nodes which serve the residents by providing living necessities, retail and leisure opportunities will be located along side the revitalised Yuen Long Nullah. The integration of multi-functional facilities through smart and adaptive design creates a synergetic and sustainable environment for the benefit of the community, and serves as a focal point of the YLS development.



Figure 4: Photomontage of the revitalised Yuen Long Nullah

2.3 Green and Sustainable Use of TSE from on-site Tertiary Sewage Treatment Works for Non-potable Water Supply

The existing sewerage infrastructure and its expansion has no spare capacity to convey, treat and dispose the sewage flow generated from YLS development. It is proposed to provide a designated new sewerage system to serve YLS development together with the adjacent village developments. The new sewerage system will comprise sewers, sewage pumping stations, rising mains and a sewage treatment works (STW).

The new STW will be designed to provide tertiary sewage treatment to produce high quality TSE that is suitable for reuse as non-potable water supply. As an alternative water supply source, the TSE is being considered to be reused locally for toilet flushing, landscape irrigation and make-up for water features within YLS development. A new TSE supply system, including TSE pumping station, service reservoir, transmission and distribution network will be provided for YLS development. This is an important green and sustainable measure to make use of **“wastewater” as a valuable source of water supply and will** help to preserve fresh water for potable consumption only.

The provision of tertiary sewage treatment and recycling of the TSE as non-potable water supply will also support **the compliance of the stringent requirement of no “net increase” in pollutant loading** for Deep Bay. The YLS development is expected to consume some of the total TSE generated from the STW. To ensure no TSE is discharged to the Deep Bay, opportunities will be explored to export the remaining or surplus TSE to other new development areas or existing urban areas in the vicinity for similar non-potable uses.

To further enhance the quality of the TSE, it is proposed to develop the 3.8 hectare site adjoining the STW into a reedbed wetland to further enhance the quality of the TSE for reuse. The TSE will discharge first to the reedbed wetland, where the residual pollutants will be further uptake by the plants therefore reducing the TSE residual pollution loading. The design of the reedbed wetland will also incorporate facilities for the public such as, walkway, cycle tracks and sitting out areas for public enjoyment.

2.4 Building Resilience with Storm Water Retention Facilities including Hillside River and Retention Lake

The existing Yuen Long Nullah and Tin Shui Wai Main Drainage Channel systems downstream of YLS has no spare capacity to accommodate the additional flow discharges from YLS development. Flood retention facilities are proposed for attenuation of the increase in peak runoff, such that there will be no increase in the 50 year peak flow discharge after YLS development to the downstream existing drainage systems in Yuen Long and Tin Shui Wai. Stormwater runoff will discharge into the retention facilities for temporary storage. The retention facilities will be provided with control outlets that limit discharges to pre-development level.

The proposed retention facilities will encompass of a 1km long hillside river and a 0.6 hectare of retention lake. The hillside river is located in between the mountain backdrop and the new developments of YLS development. The hillside river forms a protective barrier for the future developments downstream, collecting stormwater runoff from the slopes while providing an attractive leisure environment. Nearby, a created reedbed is proposed for further water polishing of the TSE, whilst providing an attractive wetland area, allows an enhanced ecological footprint and in combination with the adjacent recreational grounds a large scale natural area in biodiversity.

To build better resilience for climate change impacts, the design of the hillside river and retention lake has also considered impacts of increased rainfall intensities, which will generate additional surface runoff from YLS development and the existing drainage catchment. Areas have therefore been reserved adjacent to the retention lake. In the future, the retention lake can be further enlarged to provide additional storage volume.



Figure 5: Photomontage of the riverside channel and retention lake

3. CONCLUSION

The planning of YLS development aims to create a sustainable, green and liveable community for accommodating about 85,000 population. It will provide infrastructure to cater for the future development whilst improving the existing rural environment. The blue-green infrastructure system comprising the enlivened and new watercourses/ the preserved natural streams, the Green Zone and hillside landscape enrich the character of YLS development and promote urban, rural and nature integration attracting both residents and visitors.

The concept of revitalising water bodies in the planning of drainage network has been fully considered and applied in the development area by the smart use of the existing concrete-lined channel. Coupling with the provision of cycle track and pedestrian walkway network, it promotes walkability and sustainability which are essential for new development for the future generation. With the stringent requirements on no net increase in pollution loading for Deep Bay, a great challenge has to be overcome and the beneficial use of the treated sewage effluence would be explored for various non-potable uses.

ACKNOWLEDGEMENT

The authors would like to acknowledge the Director of Civil Engineering and Development and Director of Planning for permission to publish this article.

REFERENCES

- [1] The Hong Kong SAR Government (2015), The 2015 Policy Address
- [2] Drainage Services Department (2015), Sustainability Report 2014-2015, http://www.dsd.gov.hk/EN/Publicity_and_Publications/Publicity/DSD_Sustainability_Reports/index.html
- [3] Lau, W.; Romanos, C.; Chong, B.; (2016) Smart Green Resilient.
- [4] Arup (2013) Design with Water, [Online Community Document] Retrieved from: <http://www.arup.com> [Retrieved on 13 September 2016]

Driving Innovations for Green Infrastructure Components

Irene CHENG^a, Stephen YIM^b, Nicholas AU^c, Christine AU^d

^a Hong Kong Housing Authority, Government of the HKSAR, Hong Kong SAR, irene.cheng@housingauthority.gov.hk

^b Hong Kong Housing Authority, Government of the HKSAR, Hong Kong SAR, stephen.yim@housingauthority.gov.hk

^c Hong Kong Housing Authority, Government of the HKSAR, Hong Kong SAR, nicholas.au@housingauthority.gov.hk

^d Hong Kong Housing Authority, Government of the HKSAR, Hong Kong SAR, fy.au@housingauthority.gov.hk

ABSTRACT

Hong Kong Housing Authority is responsible for producing and managing one of the world's largest public rental housing programmes, helping low-income families gain access to adequate and affordable quality housing. Over the decades, we have been planning, designing and building to drive and deliver a long term green and sustainable development for public housing in Hong Kong.

To drive innovations for green infrastructure components, we focused our research effort on maximizing greening opportunities and water conservation in landscape irrigation. This Paper focuses on the following research topics:

- Sustainable planting system for roof greening
- Cost effective vertical greening system
- Rain water harvesting system with bio-retention mechanism
- Root zone irrigation system for ground cover and shrubs
- Zero irrigation system (ZIS) for ground cover, shrubs and small trees

We have put on trial the above research topics in some pilot projects with encouraging results, particularly for ZIS, which is a self-sustained and passive design to deliver water to the vegetation and minimize topsoil evaporation through capillary action. It aims at harvesting the rainwater directly underneath the planting areas for irrigating purpose. It also provides a sustainable urban drainage system by reducing and deferring the volume of storm water entering the sewer system and to restore the natural hydrologic cycle. ZIS is also found more efficient in water conservation and less mechanical part for maintenance when compared with Rainwater Harvesting System or Root Zone Irrigation System. In the trial project, the water consumption of planter with ZIS was monitored over 24 months and no potable manual watering was required.

With the fruitful and promising research result in hand, our ultimate goal is to share the knowledge for the benefit of the society so as to achieve a sustainable green infrastructure, improve living environment, enhance human comfort and contribute to management of natural resources.

Keywords: water conservation, zero irrigation system, affordable quality housing

1. INTRODUCTION

Hong Kong Housing Authority aims at providing affordable quality housing in a proactive and caring manner, by using public resources effectively. Over the decades, we have been planning, designing and building to drive and deliver a long term green and sustainable development for public housing in Hong Kong.

To drive innovations for green infrastructure components (Greening, Landscape & Tree Management Section, Development Bureau, 2016), we pioneer in **conducting studies on "Green Infrastructure Components" since 2008**. We have been working on different greening studies to achieve a more sustainable and cost effective ways for maintenance of green roofs and vertical greening systems.

Besides our greening efforts, as fresh and clean water is a limited and precious resource in the world, we also launched initiatives for water conservation by reusing or recycling water where possible. In recent years, we focused our research effort on water conservation in landscape irrigation. These include rainwater harvest system, root zone irrigation system and Zero Irrigation System (ZIS).

Researches conducting for various green infrastructure components include the followings (Yim, 2015):

- Sustainable planting system for roof greening
- Cost effective vertical greening system
- Rain water harvesting system with bio-retention mechanism
- Root zone irrigation system for ground cover and shrubs
- Zero irrigation system (ZIS) for ground cover, shrubs and small trees

2. SUSTAINABLE PLANTING SYSTEM FOR ROOF GREENING

Research was carried out to study the performance of different plants species on green roof in order to establish a low maintenance green roof. We aim to compare the growth performance of two commonly used plant species (Sedum mexicanum and Arachis pintoii) and to test the performance of the system.

The results showed that the growth performance of Arachis pintoii is better than Sedum mexicanum. Arachis pintoii is a fast growing species which is able to provide greening impact quickly. It also has higher Nitrogen-fixing capability and is relatively free from pests and diseases. Therefore, it is easier to maintain. Moreover, it is observed to have a better heat reduction impact compared to Sedum mexicanum (Figure 1). (Hong Kong Housing Authority and C.Y. JIM, 2013)

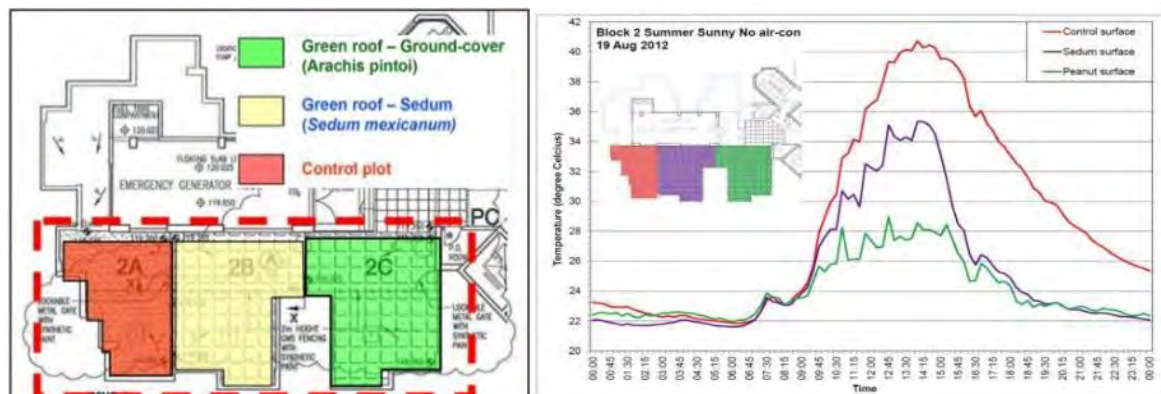

Figure 1: Roof temperature graph

3. COST EFFECTIVE VERTICAL GREENING SYSTEM

In 2010, we carried out a research on heat reduction capacity of vertical greening system and a cost effective way to maintain vertical greening system. The vertical greening system applied in the study is a green panel system. A maximum of 16°C temperature reduction was recorded for a vegetated wall surface.

Research results indicated that the substrate moisture content should be maintained at between 25% to 35% and liquid fertilizers should be applied regularly for duration of six weeks each year, preferably at spring time. From the research, we also found that seven out of nine species tested are suitable for vertical planting. They include Zoysia japonica, Alternanthera versicolor, Axonopus compressus, Cynodon dactylon, Arachis duranensis and Sansevieria trifasciata.

4. RAINWATER HARVESTING SYSTEM WITH BIO-RETENTION MECHANISM

We also studied various landscape irrigation systems for reduction in water consumption. The rainwater harvesting system is developed to collect rainwater and treat rainwater to an acceptable quality for landscape irrigation. Bio-retention treatment measures were selected for water treatment. Bio-retention acts as a self-sufficient system which provides both physical (sedimentation and filtration) and biological (pollutant degradation) treatment. The illustration of bio-retention treatment pond is at Figure 2.

A study was carried out at public housing estate at Shui Cheun O. Five species of plants, namely Pennisetum alopecuroides, Cyperus papyrus, Miscanthus sinensis, Tradescantia albiflora and Pteris ensiformis were identified to be suitable for bio-retention. (AECOM, 2014)

Rainwater collected passing through the bio-filtration and physical filtration. The quality of filtered rainwater generally complied with the standard stipulated by the Hong Kong Water Services Department (WSD) except the results on turbidity and colour. The results in the mock up (Figure 3) also indicated that E.coli removal rate was above 97%. Further study would be pursued.

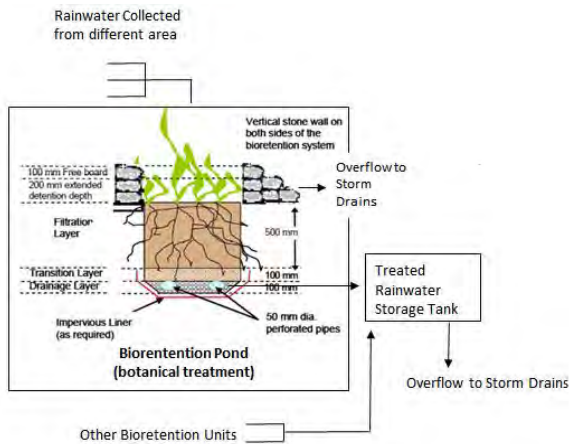

Figure 2: Bio-retention pond



Figure 3: The mock up system

5. ROOT ZONE IRRIGATION SYSTEM FOR GROUND COVER AND SHRUBS

Root zone irrigation system is one of the water conservation irrigation methods we studied recently. Based the pilot scheme of a public housing project in Kai Tak area, this system is able to achieve water saving up to 38% .

The root zone irrigation system consists of polyethylene dripping tubes wrapped with specially designed fleece, which is sewed into two further layers of non-woven fabric to form the Root Zone Irrigation Mat.

The function of the mat is to secure an even distribution of water as well as to prevent sand and other materials from clogging the drip pipes. Irrigation is then performed by the water saturation effect of the mat and resulting capillary action, guiding the water towards the drier part of the soil. The roots of most plants can grow through the mats without changing the irrigation performance of the mat. The irrigation mats are usually installed about 100 to 200 mm below soil surface and can irrigate lawn areas, flower beds and small shrubs.

5.1 The trial study at public housing estate at Kai Tak

A trial system was set up at Kai Tak public housing site to compare the performance of conventional irrigation method (sprinkler system) with that of the root zone irrigation system in terms of water consumption and the growth performance of the plants in 2011.

Two planters of similar sizes were constructed. Six types of vegetation which were commonly adopted in HA's projects were planted. The conditions of the two planters at around the beginning and end of the study are shown in Figure 4 respectively. Planter no. 1 (on left side) was irrigated by the root zone system while planter no. 2 (on right side) served as the control was irrigated manually via a sprinkler system.



Figure 4: Photo of mock up planters taken on 2 Feb 2011 and 5 Jun 2012

Water consumption of the two irrigation methods were logged on a weekly basis from March 2011 to March 2012. The health condition of the plant species was also checked on monthly basis by comparing the conditions of the root growth of the plants in the two planters.

5.2 Findings

5.2.1 Performance of plants growth

A comparison of water consumption and the performance of the plant species were recorded as in Figure 5. No significant difference is observed regarding the performance of the plant species in both planters.

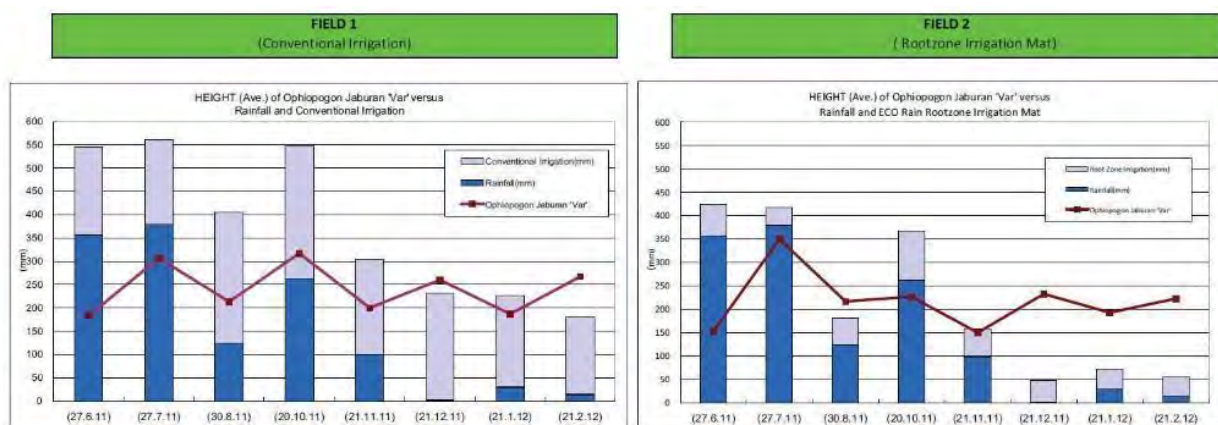

Figure 5: Plant growth monitoring graph

5.2.2 Irrigation water consumption

The average water consumption rates of the planters from 12 May 2011 to 31 March 2012 were 1.54 and 5.7 litre/m²/day respectively. By **comparing with HKHA's latest standard manual irrigation rate of 2.5 litre/m²/day**, root zone irrigation system can maintain the plant growth to the same extent with a water saving potential of approximately 38%.

6. ZERO IRRIGATION SYSTEM (ZIS) FOR GROUND COVER, SHRUBS AND SMALL TREES

Another pioneering study on sub-irrigation method is the Zero Irrigation System (ZIS). There are two design objectives of ZIS. First, it aims to harvest the rainwater directly underneath the planting areas for irrigating purpose so as to minimize the manual irrigation operation and maintenance cost. Second, as it uptakes the storm water, it reduces the storm water run-off and groundwater recharge.

The ultimate goal of ZIS is to achieve zero portable water consumption for irrigation. ZIS offers great potentials for water conservation in landscape irrigation. We have therefore conducted pioneering studies on ZIS with a view to fully realizing such potentials in our new public housing estates. The pioneering studies comprise two separate

trials on ZIS, conducted at the public housing estates at Tuen Mun Area 18 in 2013 and Homantin site in 2014 respectively.

6.1 Components of zero irrigation system (ZIS)

ZIS is a sub-irrigation method that water is delivered to the plant root zone from below the soil surface and absorbed upwards through capillary action.

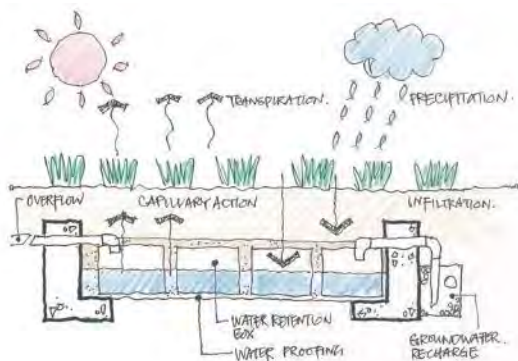

Figure 6: Illustration of zero irrigation system (ZIS)



Figure 7: Construction of ZIS at trial planter

The illustration in Figure 6 indicates how ZIS functions in practice. After rain falls, water is then absorbed into the soil; any excess is collected in special retention boxes under the ground. When the soil above becomes dry, capillary action draws up water from the retention boxes to irrigate the plants in a self-sustaining cycle. In general, as ZIS has less mechanical parts, it operates at lower capital and management costs than other sub-irrigation systems, and can collect and re-use storm water without any hygiene concerns.

6.2 The trial study of ZIS at public housing estate at Tuen Mun Area 18

The objectives of the trial study were focused on the performance of plants growth, the effectiveness of capillary action and water consumption of ZIS. After installation, the trial system was monitored for 24 months since November 2013. The construction of ZIS was illustrated in Figure 7.

6.2.1 Findings

6.2.1.1 Plant growth condition

During the monitoring period, only general horticultural maintenance was carried out; no manual watering was applied. Six types of shrubs which are commonly adopted in HA's project were planted in the trial and they were found well established. No die-back or replacement was recorded.

6.2.1.2 Irrigation water consumption

After an initial infill of water to the system, no further manual watering was applied since 11/2013. The average water consumption was 2.2 litre/m²/day. The system collected, stored rainwater and delivered the water by itself. The lowest water depth during the driest period was about half of the maximum holding capacity. The record of water level in ZIS planter was in Figure 8.



Figure 8: Records of water level of ZIS at Tuen Mun Area 18

6.3 The trial study at Homantin Site

With the success of the trial study at Tuen Mun Area 18, the system is further refined to support tree planting. Another trial ZIS planter with tree planting pit was constructed at Homantin Site. Two tree pits were constructed inside the ZIS planter. The trial system was then monitored for around 21 months since November 2014. The construction of ZIS with tree pits was illustrated in Figure 9.



Figure 9: Construction of ZIS at trial planter at Homantin Site

6.3.1 Findings

6.3.1.1 Plant growth condition

Same as the trial at Tuen Mun Area 18, no manual watering was applied after initial infill. However, one tree was found wilting after 8 months and needed replacement. This may be caused by planting the trees during winter dry season. We also considered that the tree roots required more time for establishment to take up water from the ZIS. Therefore, we recommended planting the tree during wet season and providing first month manual irrigation for the tree roots to establish.

6.3.1.2 Irrigation water consumption

In the trial study, the water consumption was 1.4 litre/m²/day. Same as the trial at Tuen Mun Area 18, the lowest water depth during the driest period maintained at half of the maximum holding capacity (Figure 10).



Figure 10: Records of water level of ZIS at Homantin Site

6.4 Benefits and limitations

ZIS is an effective, self-sustained sub-irrigation planting system. The evaporation rate of irrigation water is greatly reduced. No manual watering is required to supplement the water stored in the retention cells. The system also serves as an effective system in reducing storm water run-off. The water consumption records indicated the system performed satisfactorily under both wet and dry seasons.

However, the ZIS system is not suitable for planters on slopes or with complicated underground utilities as the retention boxes should be laid at same level for water storage.

7. CONCLUSION

The ultimate goal of this paper is to share our knowledge and experience in applying the innovations or initiatives on green infrastructure components for the benefit of the society so as to achieve sustainable green infrastructure, provide better living environment, enhance human comfort and contribute to management of natural resources. All these promising results of the pilot studies on green and water management provide a firm keystone for us to plan the green infrastructure and to provide a better and a more sustainable green environment.

Among the various innovative studies, the Zero Irrigation System is the most effective sub-irrigation system for water saving and storm water management. We have been very encouraged by the result of the ZIS trial, which has proved effective both in saving water and reducing the manpower resources required for maintenance. ZIS has great potential for extensive application in new estates, and we are now conducting further research study with the aim of refining the design and reducing construction time and costs through modularisation.

REFERENCES

- [1] AECOM, 2014. Mock-up of bio-retention Rainwater Harvesting System in Shui Chuen O Phase 1– Summary report for Hong Kong Housing Authority. Hong Kong.
- [2] Greening, Landscape & Tree Management Section, Development Bureau, Green Infrastructure. [online] Retrieved from: http://www.greening.gov.hk/en/new_trend/green_infrastructure.html [Retrieved on 14 Sep. 2016].
- [3] Hong Kong Housing Authority and C.Y. JIM, 2013, Evaluating the Environmental Benefits of Green Roofs in a Public Housing Estate. Hong Kong.
- [4] Yim, Stephen Y.C., 2015. Driving Innovation on Green Infrastructure Components for Sustainable Public Housing in Hong Kong. In: The 11th China Urban Housing Conference. Hong Kong.

Sustainable Engineering Practices in Landslip Prevention and Mitigation Works in Hong Kong

Harris LAM Wai-kei^a, Patrick HO Ho-man^b

^a Civil Engineering and Development Department, Government of the HKSAR, Hong Kong SAR, hwklam@cedd.gov.hk

^b Civil Engineering and Development Department, Government of the HKSAR, Hong Kong SAR, patrickho@cedd.gov.hk

ABSTRACT

Over the last few decades, Hong Kong has made tremendous progress in managing the landslide risk through a comprehensive slope safety management system developed by Geotechnical Engineering Office (GEO) of Civil Engineering and Development Department. One of the key components of the system is the implementation of slope retrofitting and landslide hazard mitigation works under the Landslip Prevention and Mitigation (LPMit) Programme. While the primary objective of the LPMit Programme is to contain the landslide risk, the GEO strives to attain and promote sustainability when carrying out the LPMit works. The GEO integrates the concepts of sustainability in the works implementation process. The GEO also embraces new technologies and makes continuous improvements in slope engineering and landscaping practices through applied research and development work.

This paper presents the continuous efforts made by the GEO to strive for green and sustainable engineering practices in LPMit works in Hong Kong. Recent initiatives that have made notable contributions to more sustainable practices under the LPMit Programme would be highlighted in the paper, including slope greening and ecological enhancement, carbon footprint assessments of slope works, and adoption of sustainable construction practices.

Keywords: slope greening, carbon footprint, green construction technology

1. BACKGROUND

Hong Kong has a population of over 7 million but only a small land area of about 1,100 km², much of which comprises steeply sloping terrain. Development pressure resulting from population growth and economic **expansion since the 1950's led to intensive urbanization of the lower portions of hillsides in many parts of Hong Kong**. The dense urban development, coupled with hilly terrains and high seasonal rainfall, renders the landslide problems in Hong Kong particularly acute.

In the aftermath of several serious landslides with multiple fatalities in the 1970s, the Landslip Preventive Measures Programme was launched in 1977 by the Geotechnical Control Office (renamed Geotechnical Engineering Office (GEO) in 1991) to deal with substandard man-made slopes that pose a significant safety risk to the community. In 2010, the Landslip Preventive Measures Programme was successfully completed and dovetailed by a long-term Landslip Prevention and Mitigation (LPMit) Programme, the scope of which has been extended to cover both upgrading of substandard man-made slopes and landslide hazard mitigation works on vulnerable natural terrain. The annual expenditure under the LPMit Programme is about HK\$1,000 million.

While the primary objective of the LPMit Programme is to contain landslide risk, the GEO strives to attain and promote sustainability when carrying out the LPMit works. Sustainability is regarded as a necessary and attainable goal under the LPMit Programme, through process improvement, innovation and promotion of shared learning. Recent initiatives that have made notable contributions to more sustainable practices under the LPMit Programme are highlighted in the paper, including slope greening and ecological enhancement, carbon footprint assessment of slope works, adoption of sustainable construction practices, enhancement of biodiversity, etc.

2. SLOPE GREENING AND ECOLOGICAL ENHANCEMENT

Slopes are found almost everywhere in Hong Kong, with a substantial portion of urban developments being located **near to hillsides or formed slopes**. It is **Government's policy to make slopes look as natural as possible, with a view to achieving the overall aim of creating a visually acceptable and ecologically sustainable slope environment (Figure 1)**. With the growing awareness of sustainability and greater demand for a better living environment by the public, landscape treatment of slopes has become an integral part of LPMit works. Input by professional landscape

architects is provided at the early stage of the design process to ensure that landscaping input is fully integrated with geotechnical input.



Figure 1: Slope greening above Bowen Road before (left photo) and after (right photo) works

Under the LPMit Programme, existing vegetation, including trees and shrubs, is preserved wherever practicable. As for man-made slopes, vegetation is used as surface cover wherever possible. The finished slope profile is designed to be suitable for hydroseeding as far as practicable. Any use of hard surface cover, which could generate undue heat island effect, is under stringent control. If hard surfacing is found unavoidable e.g. on slope safety grounds, visual impact mitigation measures such as planter holes, screen planting at the toe and decorative facing are provided wherever practicable. As regards natural terrain mitigation works, landscape treatments such as vertical greening, screen planting and toe planters are provided to minimize the visual impact of mitigation works and blend them with their surrounding environment (Figure 2). With the concerted efforts by the local geotechnical professionals, more than 300,000 nos. of shrubs are planted annually as part of the LPMit works, and that largely enhance the appearance of the city as well as contribute to providing a greater carbon sink to remove carbon dioxide in the atmosphere.



Figure 2: Vertical greening at a rigid barrier above Yu Tung Road, Lantau

The GEO has been establishing and advancing the best practice of landscape treatment on slopes through applied research and development work. In the early 2000s, the GEO worked with the Kadoorie Farm and Botanic Garden to conduct a planting trial of native small tree and shrub species on steep slopes. Later on, further studies on the application of various vegetation species for slope greening helped to develop various planting methods and suitable vegetation species for landscape use on slopes (Choi et al., 2009). Studies were also undertaken to assess the performance of different greening techniques, such as mulching systems and cellular systems, and to identify vegetation species that can successfully establish and self-sustain on steep slopes (Lui & Shui, 2006). In the mid-2000s, the GEO completed a study of old masonry walls with trees in order to develop a methodology for assessing the effects of trees on the stability of masonry walls. In addition, GEO proposed various methods for preserving the constituent wall trees and the wall fabric when upgrading a substandard masonry wall (CM Wong, 2011).

In recent years, GEO carried out studies on the use of solar panels for automatic irrigation systems for slope planting works (Lui, 2006), use of bio-engineering techniques that involved direct planting, live fascines and cribwalls, etc. to repair large landslides scars (Campbell, 2007), enhanced detailing of tree rings and improved

specifications for erosion control mats on slope surface. The key findings of these studies, together with the latest **best practice on slope landscaping, have been promulgated in the “Technical Guidelines on Landscape Treatment on Slopes”** (GEO, 2011), which largely promotes shared learning across the industry.

Apart from slope greening, the GEO explores ways of enhancing the ecology while implementing the slope works. In particular, the GEO promotes the use of native plant species in landscaping of slopes, in view that native vegetation species can provide habitats for birds and insects, which in turn will enhance biodiversity and natural succession. The goal is to provide a bio-diversified vegetation cover, which is ecologically stable and hence more sustainable.

The GEO's efforts in enhancing local ecology were showcased by a project which involved upgrading a group of 24 slopes along South Lantau Road in Lantau Island. The project replaced the hard surface covers on these slopes by vegetation with suitable native plant species. Based on detailed ecological surveys conducted at different stages of the project, a gradual increase in the various species of plants and animals, such as birds, insects and reptiles, was recorded at the slopes after completion of the upgrading works, with signs of regeneration of local plant species (Figure 3).



Figure 3: Enhanced ecology and biodiversity at South Lantau Road, Lantau

The GEO is particularly mindful of any possible adverse ecological impact arising from the LPMit works. For slope works affecting environmentally sensitive areas such as Country Parks or Sites of Special Scientific Interest, ecological experts are engaged to conduct ecological surveys. Where there is presence of rare plant or animal species e.g. wild orchids, egrets, etc. that could be affected by the slope works, appropriate special measures, such as transplanting, or in-situ protection before the works and close monitoring during construction, would be adopted to abate such adverse impact. In one recent LPMit project near Tai Po Market Egretty, which was the fourth largest colony in Hong Kong for egrets, the GEO has adopted a pragmatic approach and properly programmed the LPMit works in order to minimize the possible impacts or disturbances to the breeding of special bird species, with close monitoring to verify that the proposed strategy has worked well in practice.

3. CARBON AUDIT AND ASSESSMENT OF GEOTECHNICAL WORKS

There has been a growing demand to improve practice in the construction industry to help combat the problems of global warming and climate change. Various studies have been initiated by GEO in recent years with a view to reducing the carbon footprint in the implementation of LPMit works.

In the early 2010s, the GEO arranged for a detailed carbon audit of the implementation of LPMit works. The carbon audit was carried out at 54 selected sites, covering a range of typical LPMit works including soil nailing, reinforced concrete construction, slope cutting, filling and compaction works, rock slope treatment works, construction of steel flexible barriers, etc. The scope of the audit included direct greenhouse gas emission and removal, such as combustion of fuels in stationary sources and mobile sources, as well as indirect greenhouse gas emission such as electricity assumption, staff travel and embodied carbon in raw materials. The carbon audit provided valuable data to GEO for carbon management in respect of LPMit works.

The GEO attempted to further improve the LPMit design practice by incorporating the evaluation of carbon emissions of different design options in the option assessment stage. In this regard, a simple calculation tool, which allows quantification of the carbon emission of typical LPMit works, has been developed. The scope of the present carbon assessment focuses primarily on the carbon emission during the construction phase of LPMit projects, covering the following sources of carbon emission:

- Embodied carbon content of the construction materials (i.e. cradle to site approach) due to extraction, processing and transportation involved during the production of the materials;
- Carbon emission arising from the transportation of materials and construction plant, both within and outside the territory of Hong Kong;
- Carbon emission arising from the fuel consumption of the construction plant or machinery;
- Carbon emission arising from waste treatment; and
- Carbon impact due to felling of mature trees.

Assumptions on carbon emissions are mainly based on published data (EPD & EMSD, 2010, Hammond & Jones, 2011, Leung et al., 2010) as well as other reliable and locally surveyed data. These assumptions are subject to refinement when more reliable and updated data become available, and flexibility is allowed in the tool for such updating in future.

The tool allows local geotechnical practitioners to better appraise the carbon emission of various design options in a consistent and transparent, albeit simplified, manner, and the decisions made can be communicated more readily to the public or other stakeholders. It also provides useful insight on where potential carbon reductions can be made. For example, in soil nailing works, which is a common type of slope treatment works in Hong Kong, the main carbon emission would be the embodied carbon emission of materials (Figure 4). A study was therefore initiated to look into the possibility of reducing the embodied carbon emission of materials for soil nailing by partly replacing the cement in grout by ground granulated blast furnace slag (GGBS).

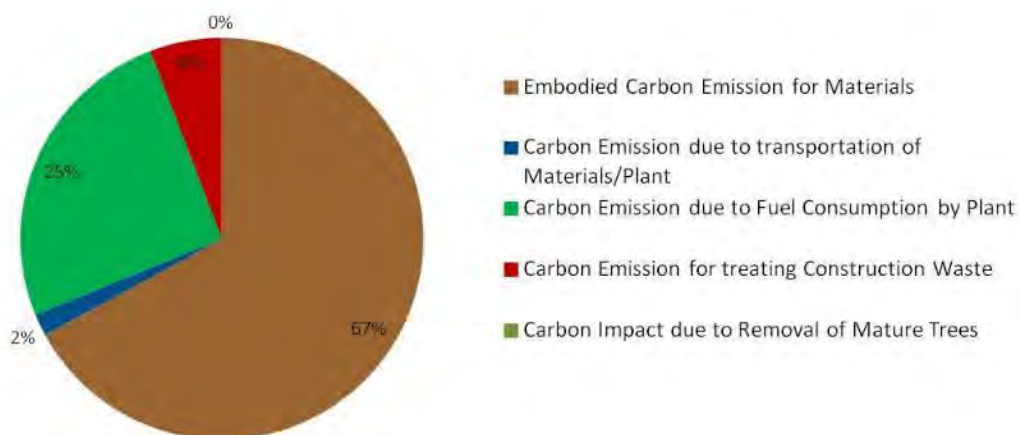

Figure 4: Example of carbon assessment of soil nailing works

4. SUSTAINABLE CONSTRUCTION PRACTICES

The GEO makes every endeavour to minimize the environmental impacts arising from the construction of LPMit works. A comprehensive site supervision system has been established to audit the workmanship and hence the reliability of the completed LPMit works. The works are closely monitored for strict compliance with the contractual and statutory environmental requirements and agreed mitigation measures. Surface runoff from the LPMit works sites is treated by adequately designed silt-removal facilities before discharging into stormwater drains (Figure 5). The area of exposed earth surfaces is kept to a minimum, and is covered with properly secured tarpaulins sheets for dust suppression (Figure 5). Caring site visits are regularly conducted by the directorate officers of GEO to ensure that the LPMit works are carried out in a safe, green and sustainable manner.



Figure 5: Water pollution control measures (left photo) and air pollution control measures (right photo) for the LPMit works

The GEO adopts green construction practices whenever applicable. As the combustion of fuel is one of the major sources of carbon emission during the construction of LPMit works, the contractors are encouraged to connect to the power grid as far as possible, instead of employing site generators, in order to reduce fuel combustion. B5 diesel (i.e. 5% biodiesel blended with 95% Euro V diesel) has to be used in all non-road based construction machinery, such as air compressors, excavators and compaction plant, for all LPMit works contracts. The use of electric vehicles with no carbon emission is also supported by the GEO, with active participation in their trial use and the incorporation of suitable provisions in the LPMit works contracts.

It is one of GEO's goals to reduce construction wastes generated by the LPMit works. The contractors are encouraged to adopt the 3R principles (i.e. Reduce, Reuse and Recycle) as far as practicable on site. For example, a tree shredding machine has been used in one of the LPMit works sites for chipping felled trees into wood chips that can be reused as mulch. Rubbish bins are provided in pairs at each LPMit works site, one for aluminum cans, one for plastic bottles and one for general refuse, in order to encourage recycling of workers' wastes. Re-usable construction materials, such as steel moulds for surface channels and steel accessories for temporary access, are adopted on site to reduce wastes. The excavated materials are reused on site for backfilling or as top soil for landscaping wherever possible. The contractors are also encouraged to use their best endeavours in identifying recycling facilities or other suitable construction sites where the construction and demolition (C&D) materials can be used in a beneficial manner.

Green site offices with various sustainable designs and features have been adopted in LPMit works contracts since 2015. These sustainable designs and features include measures to allow natural light and ventilation as much as possible, and the use of reusable materials, modular accommodation units, energy and water saving devices. Re-use of site offices, which can minimize waste generation due to the demolition and construction of office, is encouraged by the incorporation of suitable provisions in the LPMit works contracts. In addition, GEO pays particular attention to the aesthetics of site hoarding. In this regard, decorative panels for reducing visual impact of site hoardings are adopted (Figure 6). These decorative panels are durable and reusable, as well as aesthetically pleasing to the public.



Figure 6: Decorative panels on LPMit site hoardings

The GEO embraces and adopts green construction technologies that help to reduce carbon emissions. The trial use of GGBS concrete in the construction of check dams has been initiated, noting that the carbon emission of GGBS concrete is up to 40% lower than normal OPC concrete. A number of other studies, such as green procurement, lean construction and Building Information Modelling, are ongoing with a view to further enhancing the sustainability of LPMit works.

5. CONCLUSION

The GEO is implementing a long-term LPMit Programme to contain landslide risks in Hong Kong to within an As Low As Reasonably Practicable (ALARP) level. Sustainable landscaping, engineering and construction practices have been adopted by the GEO in the implementation of LPMit works, in order to contribute to a green and safe living environment in Hong Kong. The GEO is dedicated to seeking continuous improvement for the enhancement of sustainability in the delivery of LPMit projects.

6. ACKNOWLEDGEMENT

This paper is published with the permission of the Head of the Geotechnical Engineering Office and the Director of Civil Engineering and Development, Government of the Hong Kong Special Administrative Region.

REFERENCES

- [1] Campbell, S.D.G., Shaw, R., Sewell, R.J. & Wong, J.C.F., 2008. Guidelines for Soil Bioengineering Applications on Natural Terrain Landslide Scars. GEO Report No. 227, Geotechnical Engineering Office, Hong Kong, 162 p.
- [2] Choi, K.C., Chau, R.Y.H. & Halcrow China Limited, 2009. Planting Trial at Yuen Tun and Performance Assessment of Vegetation Species on 44 Man-Made Slopes. GEO Report No. 248, Geotechnical Engineering Office, Hong Kong, 148 p.
- [3] CM Wong & Associates Limited, 2011. Study on Masonry Walls with Trees. GEO Report No. 257, Geotechnical Engineering Office, Hong Kong, 154 p.
- [4] EPD & EMSD, 2010. Guidelines to Account for and Report on Greenhouse Gas Emissions and Removals for Buildings (Commercials, Residential or Institutional Purposes in Hong Kong). Environmental Protection Department and Electrical and Mechanical Services Department, Hong Kong, 46 p.
- [5] GEO, 2011. Technical Guidelines on Landscape Treatment on Slopes. GEO Publication No. 1/2011, Geotechnical Engineering Office, Hong Kong, 217 p.
- [6] Hammond, G. & Jones, C., 2011. Inventory of Carbon & Energy. University of Bath, UK, 128 p.
- [7] Leung, M.K.H., Leung, D.Y.C., Chan, A.H.S., Cheng, M., Shek, T., Lam, G.C.K., Cheng, S.W.K., Koo, B.C.P. & Yun, D., 2010. Carbon Audit Toolkit for Small and Medium Enterprises in Hong Kong. The University of Hong Kong, 45 p.
- [8] Lui, B.L.S., 2006. Trial Use of Solar Power Automatic Irrigation System. GEO Report No. 194, Geotechnical Engineering Office, Hong Kong, 34 p.
- [9] Lui, B.L.S. & Shiu, Y.K., 2006. Performance Assessment of Greening Techniques on Slopes. GEO Report No. 183, Geotechnical Engineering Office, Hong Kong, 201

Session 2.10: Transforming SBE Practices – Energy Management (1)

Development of an Integrated Energy Simulation Tool for Buildings and MEP Systems, the BEST: A Pilot Study on Simulation of Demand Response with Cogeneration Systems

Ryota KUZUKI^a, Makoto SATOH^b, Norie TSUJIMARU^c, Shuzo MURAKAMI^d, Takashi AKIMOTO^e, Hisaya ISHINO^f, Fumio NOHARA^g, Hiroshi NINOMIYA^h, Kenichi SASAJIMAⁱ, Tatsuo FUJII^j

^a Tokyo Gas Co., Ltd., Japan, kuzuki@tokyo-gas.co.jp

^b Satoh Energy Research Co. Ltd., Japan

^c Satoh Energy Research Co. Ltd., Japan

^d Institute for Building Environment and Energy Conservation, Japan

^e Shibaura Institute of Technology, Japan

^f Tokyo Metropolitan University, Japan

^g Nikken Sekkei Research Institute Co., Ltd., Japan

^h Nikken Sekkei Co., Ltd., Japan

ⁱ Nikken Sekkei Co., Ltd., Japan

^j Hitachi Ltd., Japan

ABSTRACT

Based on the experience of East Japan Earthquake in 2011, demand response is expected to be one of the effective measures to deal with tight supply-demand balance by motivating consumers to contribute peak cutting of electric power demand.

Cogeneration systems are one of the well-known major options for efficient energy use for demand side. Currently cogeneration systems have been adopted in buildings for the purpose of increasing self-sufficiency of power supply. In addition, they are expected to play a role to contribute demand response (DR) in the electric power market to reduce fluctuation within power grid caused by certain amount of renewable energy in the future.

This study is a pilot study of simulation by use of The Building Energy Simulation Tool (BEST). BEST has been developed under the initiative of Ministry of Land, Infrastructure, Transportation and Tourism, which handles housings and facilities in an integrated manner in order to assess the energy performance of buildings as a whole.

Focusing on DR periods and incentives, several DR controller models for the BEST has been developed which operate equipment modules depending on some conditions such as outside temperature, grid power demand, etc. to be considered to determine DR signals. This paper shows some examples of cases of a variety of demand-side options such as cogenerations, heaters and chillers by use of the BEST program. In this study, as a pilot case, assuming automatic demand response (ADR), five-steps of DR signals are available to simulate several situations and evaluation of effectiveness of some incentive options.

Key findings is that the BEST simulation adapting to DR, trade-offs between cases are clarified, such as that DR control using CGS contributing to provide economic incentives by alternating grid power in DR period, keeping the thermal environment for office workers.

Keywords: demand response, cogeneration system, building energy simulation

1. INTRODUCTION

Japan experienced serious restrictions on the electric supply capacity after the Great East Japan Earthquake in 2011, which played an important role in changing nation-wide electric power supply systems and influenced the Electricity Business Act to be amended for the first time in 60 years. As part of the amendment, measures are being sought to effectively supply electric power throughout the country. The government expects that by making use of the capabilities of companies and individuals through use of surplus electric power (negawatts) generated by power saving and energy saving, reduction of electric power demand according to the tight balance between

supply and demand (Demand Response: DR) and so forth, the supply cost can be reduced while the stable supply of the system power can be secured.

When DR is implemented and power usage is restricted, the need to avoid inconveniences in economic activities and daily life due to excessive power saving would arise on the consumer side. It is considered that effective measures are to use self-supporting power supply systems (cogeneration, solar power generation, and so forth), to use heat-driven chillers and heaters in addition to electrically powered chillers and heaters and to have power storage or heat storage functions on the consumer side.

In this study, on the assumption that DR would be implemented, the BEST (Building Energy Simulation Tool) is proposed to be used as a simulation tool for appropriate system configuration or operation planning in the case of the introduction of a cogeneration systems. The BEST has been developed under the initiative of Ministry of Land, Infrastructure, Transportation and Tourism, which handles building envelopes and building facilities in a coupled mode and which calculates load and energy consumption by minutes in order to accurately assess the energy performance of a building as a whole. This study is a pilot study applying BEST simulation to deal with DR on the building facilities and be used in estimation of peak-cut effects brought about by implementation of DR and verification of incentives.

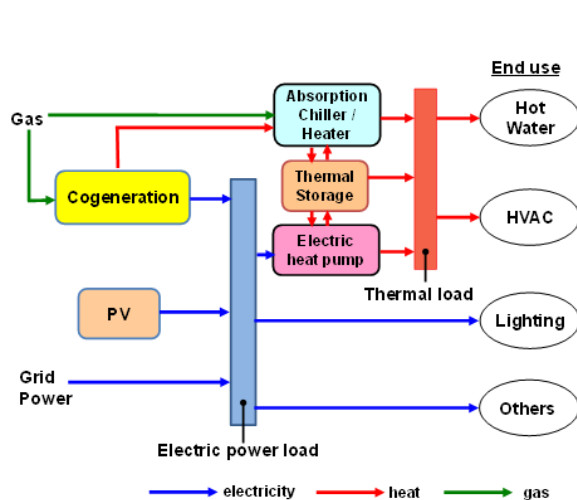

Figure1: Example of demand side energy system adaptable to DR control

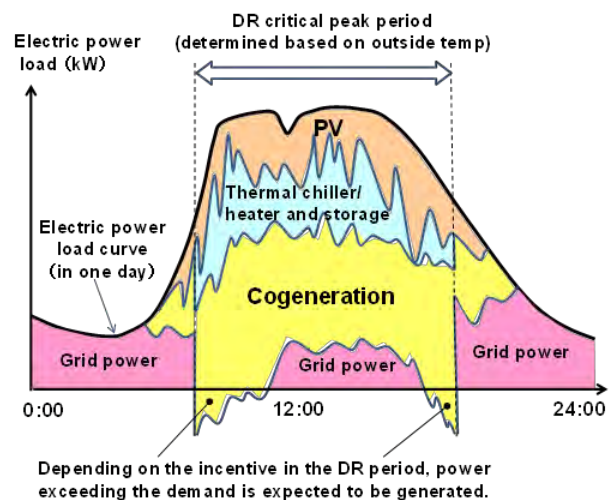

Figure 2: Image of power supply on the demand side in one day

2. BASIC CONCEPT

In the U.S., various methods already exist. Here, the following measures are focused on as the consumers' efforts:

- Change to power supply from the grid power using self-supporting power supply systems (Cogeneration, solar power generation, and so forth) on the consumer side
- Shift from electrically driven chillers and heaters to those of heat-driven for air conditioning system

It is considered that for a building where a cogeneration system is planned to be introduced, it is necessary to select the power source and heat source with an appropriate capacity and to make a plan so that the system can be flexibly operated with consideration given to the following items assuming that DR is implemented in the future:

- Avoidance of restrictions on business operations and daily life while DR request is made
- Continuity of energy saving while DR request is made
- Economic incentives for those who have the DR adaptive equipment

To verify the above requirements in the planning stage, the BSET program which has already developed in consideration of the characteristics of cogeneration system can be used. As a pilot study, operation simulation for some cases including cogeneration is conducted by use of the BEST program assuming that the DR request is effective. Specific case studies are described below.

3. CASE STUDIES

3.1. Case studies

For the case study, a provisional office building located in Tokyo that has 14 stories above ground and one story below and has a gross floor area of 20588.88m². is selected. Depending on the presence or absence of a cogeneration system and the presence or absence of DR control, several cases are assumed. The assumptions of the cases are shown in Table 1, in which a cogeneration system (CGS) is comprised of two gas engines (370 kW) and heat source equipment consisting of an exhaust heat input-type absorption water cooling/heating machine and a heat exchanger for heating.

Building type: office Gross floor area : 20588.88m² 14 stories + 1GL Location: Tokyo

	Equipment		DR control method in demand side
	Power Generation	Chiller / Heater	
Case 1 CGS + DR control	Gas engine 370kW x2 Generation efficiency: 41% (LHV)	Waste heat absorption chiller / heater 400kW	When the DR request is issued, the equipped CGS is operated with the maximum power generation output so that it is adapted to the air conditioning/power loads without deteriorating the thermal environment in the office and further, surplus electric power is provided outside of the premises.
Case 2 CGS <i>Without DR control</i>			As a comparative case with Case 1, regardless of the presence or absence of the DR request, the operation of CGS following the power load curve in the premises is assumed.
Case 3 Non CGS DR control	(non CGS)	Electric Heat Pump (Air cooling) 750kW x2 COP=4.45	When the DR request is issued, the set temperature for the air conditioning equipment is changed to reduce the load of the electricity driven chillers and heaters and the load processing is partially restricted by power saving. To compensate for this, the thermal environment in the office deteriorates, forcing office workers to endure such conditions during DR control.
Case 4 Non CGS <i>Without DR control</i>			Even if the DR request is issued, the set temperature is not changed. The indoor environment is maintained through purchase of expensive peak period electric power. In this case, a trade-off between performance and cost can be evaluated.

Table 1: Overview of the case description

Depending on the outside air temperature, the DR request signal is issued, and the gas engines and the chillers and heaters are controlled. In this study, when the outside air temperature is 30°C, 31°C or 32°C, the DR control level is changed in three stages: Level 1, 2 and 3. When the DR request is issued, the assumed control menus are as follows:

- The gas engine operation are changed to the maximum power generation output.
- The heat source outlet temperature is changed to 7°C, 8°C and 9°C, in that order.
- The set room temperature for the air conditioning equipment is changed to 27°C, 28°C, 29°C, in that order.

3.2. Control methods to deal with DR request

Table 2 shows control methods to deal with DR request issuing conditions assumed in this study. For the outside air temperature exceeding 30°C, three levels are set. The outside air temperature was assumed using data for Nerima Ward in Tokyo in August 1995. In 1995, the average temperature in the same area in August was the highest in 25 years, and the number of days when the daily maximum temperature of 35°C or higher was recorded was relatively large.

For this pilot study, a DR controller for the BEST program has been developed which includes levels 1 to 5. The gap (differential) between operations for making the control stable can also be set arbitrarily.

Category	Devices to be controlled	Control method for DR critical peak period
Power generation	Gas engines	The power generation control is changed to "maximum power generation output". The power generation output is changed.
Air conditioning (Secondary side)	Rooms	The set room temperature is moderated.
	Air handling units	The air blowing temperature is moderated. The intake amount of outside air is limited. Air conditioner is stopped (intermittent operation).
Air conditioning (Primary side)	Heat source units	The heat source outlet temperature is moderated. The chilled water supply temperature is moderated. The electric heat source is stopped.
	Heat storage tanks	Heat is dissipated during the DR time period. Surplus heat is stored.
Lighting	Lighting	Thinned-out lighting
Storage battery	Storage batteries	Electric discharge is operated during the DR time period.

Table 2: DR control methods in the demand side

3.3. Results and considerations

The examples of the results of the simulations for three months (July to September) in the summer season are shown in Figure 3 and Figure 4.

3.3.1 Operation status of the system

Figure 3 describes some of the results in Case 1. In Case 1, for the DR control, CGS was operated at the maximum capacity, and the exhaust heat was used for cooling as much as possible, and the surplus electric power was flowed in reverse to the grid power and contributed as supply capacity to the system

3.3.2 PMV frequency distribution

Figure 4 shows the PMV frequency distribution for three months in summer season in Case 1 (with CGS and absorption chiller) and Case 3 (electric HP). In both cases, the frequencies were counted only in the time frame when air conditioning was operating. In Case 1, PMV was maintained at around 0.5, while in Case 3 where office workers are forced to endure the conditions, PMV became around 1.5 in the time frame when the DR request was issued, which shows that the conditions worsened and people in the room were forced to endure such conditions.

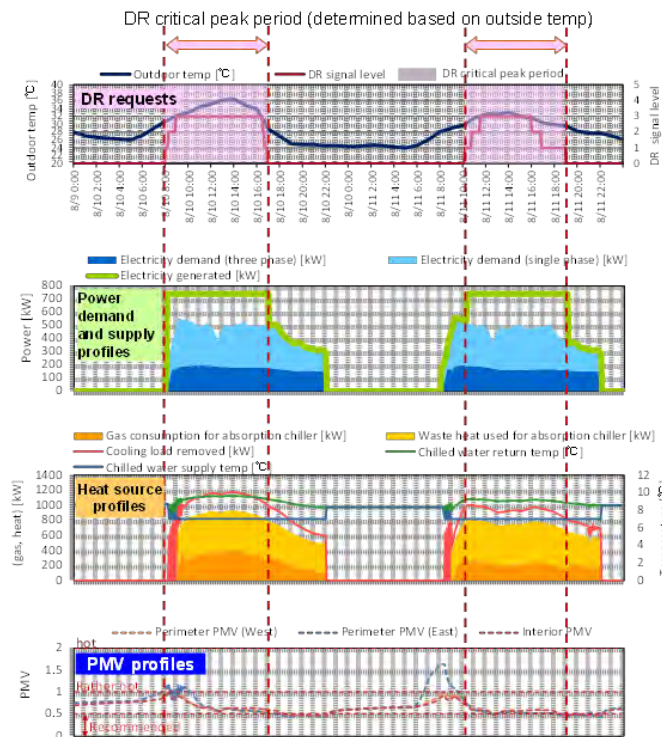

Figure 3: Example of simulation results (Case 1: CGS with DR control; Aug 10-11)

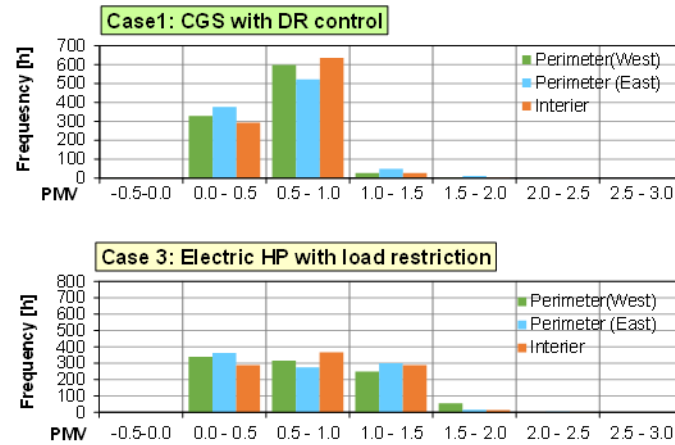

Figure 4: PMV frequency distribution (Case 1 and Case 3)

3.3.3 Primary energy consumption

Figure 5 shows the comparison result of the primary energy consumptions, with the evaluation of the peak time period added, for three months (July to September) in the summer season in the Tokyo area. Some of the generated power is provided to outside of the site, and at the same time, the operating rate of the exhaust heat input-type absorption refrigerator is increased by use of exhaust heat from power generation. Further, according to the guideline concerning levelling of electricity demand newly incorporated into the Energy Conservation Act amended in 2013, when 1kWh of the system electric power consumption in the specific time zone (8:00 - 22:00) is reduced, it will translate as 1.3kWh of the consumption being reduced (energy saving bonus). As such, it is considered that as a result, the net primary energy is saved and the energy saving performance is maintained.

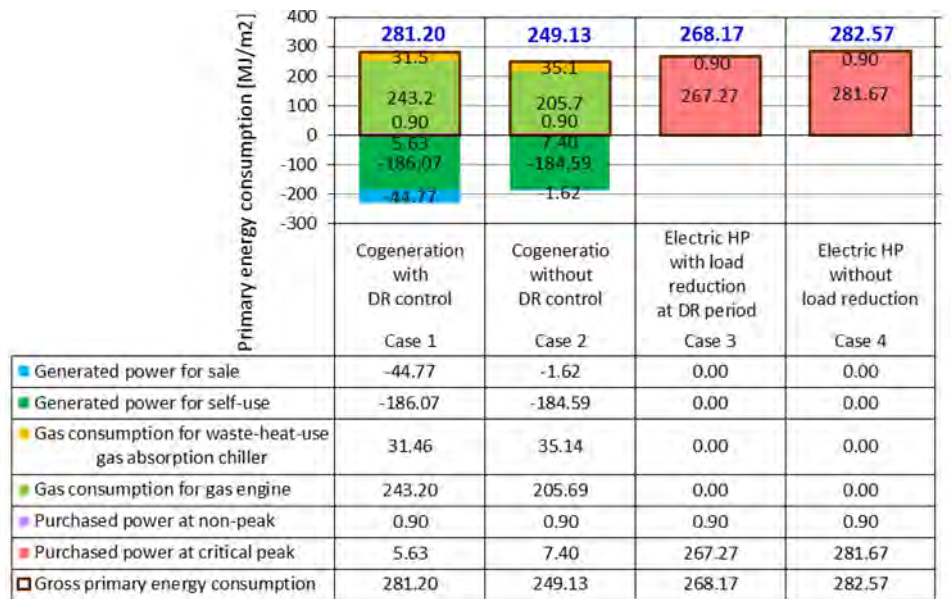

Figure 5: Primary energy consumption by cases

3.3.4 Additional financial incentive for cogeneration owner

In some of the DR cases in the U.S., the demonstration experiment in Kitakyushu City and so forth, incentives 6 to 10 times higher than the normal electric power charge for 1 kWh electricity during DR control were provided. In this pilot study, referring to past research (Yokohama Smart City Project (YSCP), the result of the demonstration in summer 2014 (preliminary) in the building sector in Yokohama City (October 28, 2015)), the incentives were estimated as 15 to 30 yen/kWh.

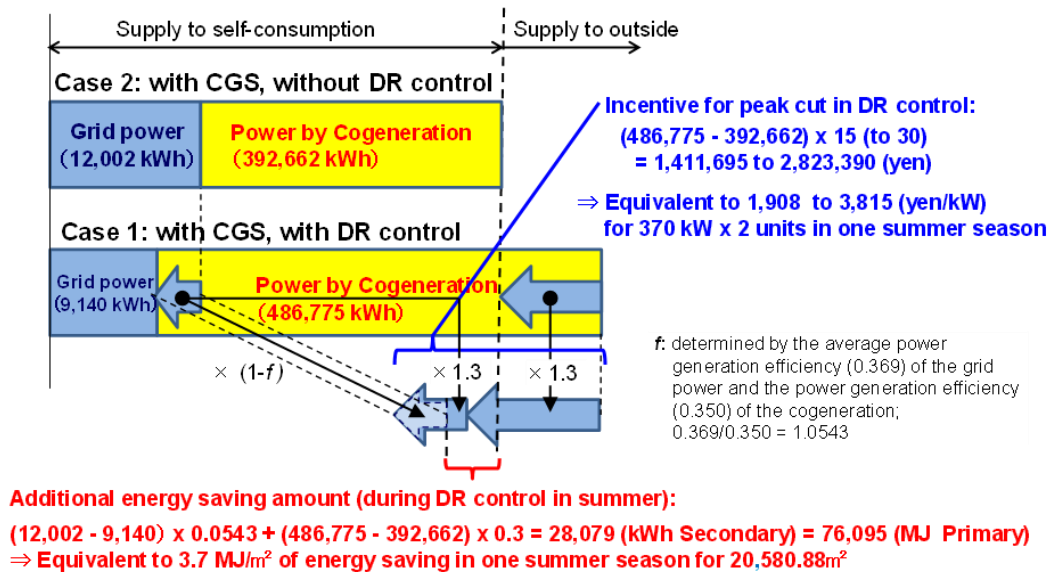

Figure 6: Estimated additional financial incentive to cogeneration with DR control

According to this estimation, in this case, the incentives by DR peak cut became 1.4 to 2.8 million yen and about 1.9 to 3.8 thousand yen for 1 kW of the capacity of the introduced cogeneration power.

3.3.5 Overall evaluation

According to the results (Figure 4, Figure 5 and Figure 6), in Case 3, without CGS, office workers are forced to endure the conditions. Alternatively, in Case 4, without CGS, they are forced to pay additional cost as peak price. But in Case 1 with DR control using CGS, although the energy consumption increased by about 5%, the values as a regulated power supply that contributes to the grid power were provided. In addition, PMV is maintained, that is, deterioration of the thermal environment is avoided and the quality of business operations and daily life is maintained. Through the BEST simulation to adaptation to DR, a trade-off relationship is clarified.

4. CONCLUSION

In this study, as one of the methods of dealing with DR on the building side, using the BEST simulation is proposed to determine system configuration or operation plan in the case of use of cogeneration power. In this study, pilot case study is conducted to simulate DR control in several assumed cases including the case where relatively large-sized gas engine cogeneration is introduced in an office building of about 20,000m².

The comparison of the net primary energy consumptions between the cases showed that in the case of DR control using CGS, the energy consumption increased by about 5% compared to the case where office workers were forced to endure the conditions, but the values as a regulated power supply that contributes to the grid power were provided, and in addition, PMV was maintained, that is, deterioration of the thermal comfort was avoided and the quality of business operations and life was maintained. A trial calculation of this economic value is also made and clarified the trade-off relationship. When such a value trading market is formed, it can be expected that projects are undertaken with consideration given to added financial values created by cogeneration capacity and prosumers positively participate in the market.

In this study, the DR control level according to the temperature was set. In view of the increasing tendency of electric power originating from renewable energy, however, it is also necessary to conduct simulations for DR based on the conditions of sunshine, wind and so on that are not always based on temperature. With the regional weather data such as sunshine and wind conditions with which BEST is provided, further simulations of DR control in which the behaviour of various component devices (heat storage, electricity storage and lighting) is also reproducible.

ACKNOWLEDGEMENT

This paper is one outcome of the work of the Cogeneration Study SWG (led by Professor Takashi Akimoto of the Shibaura Institute of Technology) of the BEST Development Promotion Forum (chaired by Shuzo Murakami, President of the Institute of Building Environment and Energy Conservation), which was established by the government, representatives of industry, and academia in the Japan Sustainable Building Consortium. The authors are greatly acknowledging the support of everyone involved.

REFERENCES

- [1] About BEST Program -Contrasting the capabilities of building energy performance simulation programs, The Institute for Building Environment and Energy Conservation, Retrieved from: <http://www.ibec.or.jp/best/english/index.html> [Retrieved on 10 September 2016]
- [2] Agency for Natural Resources and Energy: Overview of demand response – A new form of energy saving - October 2014
- [3] Kuzuki, et. al; Integrated Energy Simulation for Building and MEP Systems in Consideration of the Characteristics of Thermal Energy Media for Thermal Cascading Systems, J. Environ, Eng., Architectural Institute Japan, Vol. 76 No. 662, 401-409, Apr., 2011
- [4] Ministry of Economy, Trade and Industry (METI); Guideline concerning measures to be taken by companies for levelling of electric demand, December 2013
- [5] Yokohama Smart City Project (YSCP); The Result of the demonstration in summer 2014 (preliminary) – building sector, City of Yokohama, October 2015

Driving Ultimate Building Performance Through Smart E&M Systems for Sustainable Built Environment

TAI Tak-him^a, Edmond CHEONG Siu-hung^b, CHAN Yiu-hon^c, Jovian CHEUNG Man-chit^d

^a Electrical and Mechanical Services Department, Government of the HKSAR, Hong Kong SAR, thtai@emsd.gov.hk

^b Electrical and Mechanical Services Department, Government of the HKSAR, Hong Kong SAR, shcheong@emsd.gov.hk

^c Electrical and Mechanical Services Department, Government of the HKSAR, Hong Kong SAR, yhchan@emsd.gov.hk

^d Electrical and Mechanical Services Department, Government of the HKSAR, Hong Kong SAR, joviancheung@emsd.gov.hk

ABSTRACT

Buildings are major components in a city and they account for more than 40 percent of global energy usage. Together with the long life-cycle of buildings, their performance has significant impact to the sustainable built environment. The building performance relies heavily on electrical and mechanical (E&M) systems and services. The E&M systems in modern high rise buildings have become more comprehensive and sophisticated. This paper will discuss the technological changes for building performance indicators, including availability, maintainability and reliability (AMR), and energy efficiency. Emerging data and information and communications technologies (ICT) bring in new concept and development of smart E&M system and services for driving ultimate building performance and sustainable building environment.

Keywords: sustainability, built environment, energy efficiency, availability, maintainability, reliability, data, information and communications technologies, driver, E&M systems

1. INTRODUCTION

The built environment refers to everything manmade to modify the spaces in which we live and work, including buildings of all types, roads, parks, and landscaping, etc. It has a broad spectrum of impacts on our lives. For a built environment to be sustainable, it shall meet the needs of present without compromising the ability of future generations to meet their own needs (“Our Common Future”, 1987). It must also be flexible and adaptable to future uses, has low carbon emission and be resilient to cope with imminent threats of climate change. With the continuous world population growth, the rate of urbanization is increased and the built environment in cities is affected, e.g. constructing roads, utility and transportation facilities, as well as commercial and residential buildings. Buildings are major components in a city. They account for more than 40 percent of global energy usage and as much as one third of global greenhouse gas emissions which is the major cause of global climate change. In Hong Kong, the residential and commercial buildings consume around 51 percent of total energy use in which around 90% are used in electrical and mechanical (E&M) systems, e.g. air-conditioning, lift and escalator, fire services, lighting, etc. Performance of building depends largely on the E&M system design and service performance, and it **is an essential element for sustainable built environment. Buildings’ expected life span** can reach 50 years or more while the lifecycle of typical E&M systems is about 15-25 years. How the E&M systems and services performance can sustain within the expected lifecycle and what will be the optimal time to replace them will affect the building performance. Conventionally, managing the availability, maintainability and reliability (AMR) and energy efficiency of E&M systems and services is crucial to building performance. With the advancement of data and information and communication technologies (ICT), E&M system performance will have substantial changes. This paper will discuss the challenge on some performance indicators of E&M systems from such technological change. The data and ICT will bring in the smart building concept and development which drive ultimate building performance and sustainable built environment. Sustainable built environment for buildings will include smart data technology on top of energy efficient, green and low carbon.

2. SMARTER E&M SYSTEMS DRIVING BETTER BUILDING PERFORMANCE

In large scale and high rise buildings, the demand of E&M systems and services for meeting the needs of users are increased and the requirements for managing them are complicated. Interruption of the E&M systems will cause inconvenience or even disastrous consequences, resulting in unacceptable building performance. Therefore, enhancing AMR on E&M systems is important for preventing service interruption. Apart from this, as E&M systems consume 90% of energy used in buildings, inefficient use of energy in them will decrease the energy

performance and also lead to high electricity bill. As energy performance of E&M systems will affect building performance, managing their use is very important. Therefore, AMR and energy efficiency are considered as the major performance indicators for building performance.

With the fast advancement of data and ICT, it brings in the new concept of smart building and development on smart E&M systems and services. It enables more automatic, intelligent, remote monitoring and control features to be built in E&M systems. This will drastically change the mode of operation and maintenance of E&M systems with increase in intelligence but less manpower resources. This will become the key driver in raising the capability of E&M systems for enhancing the AMR, energy efficiency and ultimately the smart building performance. AMR, energy efficiency, and data and ICT will be further discussed in the following sections.

2.1 Availability, maintainability and reliability

2.1.1 Availability

Availability of E&M systems is an important indicator to measure the operational effectiveness of the building. It is the probability of a system to operate and perform its intended function over its expected life-cycle. In modern financial cities and densely populated areas, the operation of both commercial and residential buildings, in particular the high rise ones, relies heavily on the availability of various E&M systems. Inability to access to service of an E&M system, e.g. lift, fire services installations, etc., will cause inconvenience or even safety impact to the building performance. Availability is inter-related with maintainability and reliability.

2.1.2 Maintainability and reliability

Maintainability refers to the ease and rapidity of restoring a system back to operational status. Conventional maintenance approaches on E&M systems are basically to carry out regular preventive maintenance to prevent failure and corrective maintenance after failure occurrence. Regular preventive maintenance is carried out through inspection, scheduled servicing or even overhaul so as to maintain the performance and prevent the occurrence of failure. Since this approach does not consider asset condition, excessive maintenance and provision of extra manpower resources. For corrective maintenance, it is essential to respond to unpredictable service interruption. However, neither of these approaches is desirable for sustainable built environment as they involve excessive resources and unpredicted failure, i.e. system not available.

The rapid advancement of technology on sensors and IoT, condition monitoring and data analytic has permeated into E&M industry and leading to a paradigm shift in maintenance approach. The techniques and manpower resources for maintaining E&M systems will become smarter. Through connecting sensors, controlling and monitoring equipment and software, E&M system data can be collected for analysis to enhance the maintainability. For example, various remote monitoring and self-diagnosis systems for lift installations have been put into operation. The operating data of lift, including travelling speed, lift car vibration spectrum, door opening and closing speeds, hoisting rope condition, etc. can be collected remotely for central monitoring and trend analysis. Through continuous condition monitoring and automatic self-diagnosis functions, the frequency of on-site inspection, the maintenance costs and manpower can be reduced. The pre-mature fault can also be detected for early rectification before a real fault occurrence. In case of failure, the fault attendance time can also be shortened since maintenance staff will be alerted instantly. Trouble-shooting and system downtime will also be reduced because maintenance staff can realize the cause of failure before arriving the site. This has changed the traditional work process in maintenance, repair and service, and enhanced their maintainability as well as availability.

In addition, advanced technology also brings in new challenges to maintainability of E&M systems. Nowadays, electronic or software control are widely used in E&M systems as more advanced and sophisticated functions are built in. Since electronic control is an integral part of the E&M systems and the core component of controlling their operation, its failure can cause complete malfunction of the system. Comparing with conventional E&M components, electronic parts are more vulnerable and have a shorter lifecycle as they are tightly coupled with the fast pace of technology advancement. These bring challenges to the maintenance of this kind of E&M systems because of replacement or repair of the electronic control or software will have obsolete or incompatibility issues after several years of service. Stocking more spare parts may alleviate the situation but the challenge to the maintainability as well as lifecycle asset management of these E&M systems still exist.

Reliability is the chance of a failure occurring over a specified time interval. In practice, components faults or aging issue will affect the reliability of the E&M systems. Typical approach to increase the reliability of E&M systems is to set up redundancy in the design which will automatically cut in to provide service in case of failure of the duty unit.

In order to reduce unpredicted interruption to E&M systems, innovative condition monitoring technology and smart sensors will come into play. These technologies can be used for keeping consistent system performance by monitoring deviation of various operating parameters such as vibration of compressor, component temperature and current, etc., so that building managers can timely examine and make necessary adjustment to the system. By integration of various E&M systems and deployment of an integrated Building Management System (iBMS) – aggregating and analyzing E&M systems and services information in a building or cluster of buildings, building managers can use remote monitor system and be fully aware of the condition of each system under a single platform. This system can facilitate building managers to take early action on potential problem in a well-planned manner and minimize the interruption to achieve a better reliability of the E&M systems and services.

2.2 Energy efficiency

Apart from AMR, effective use of energy in building is another key indicator for building performance. Buildings can be considered as energy-intensive system through their whole life-cycle. Knowing the current energy performance of a building is important to building managers. The commonly used metrics of building energy performance is Energy Use Intensity (EUI), which is presented as annual building energy use per building area. This unit is adopted for designing E&M systems in new green buildings and assessing the energy use in the existing **buildings. Building managers can use the EUI to benchmark their buildings' energy performance and look for improvement on energy efficiency.**

Energy audit is widely used to examine E&M systems' energy performance of a building. Through the process of energy consumption checks, energy management opportunities (EMOs) are identified for energy saving. The EMOs will then be realized through developing new operation and maintenance strategy, retrofitting of existing systems and thus bringing in higher energy efficiency system to improve building energy performance. The Hong Kong government led by example had carried out energy audits in 120 existing government buildings and achieved around 16% of reduction in electricity consumption in 9 years since 2003 through the implementation of energy efficiency measures. In 2015, another round of energy audits for around 340 existing government buildings has been rolled out targeting for further 5% electricity saving in the coming 5 years with 2014 as the baseline.

The traditional energy management approach by monitoring annual building energy use and auditing energy used is time-consuming, labor intensive and costly. Recent technology advances of sensors, meters, and Building Energy Management System (BEMS) allow the building manager to visualize real-time energy consumption of E&M systems. With energy usage data in real time, building energy profile and energy consumption in different zones of the building will be automatically available for monitoring and managing E&M systems. Having online BEMS, the building manager can monitor the energy usage and engage occupants on energy efficiency. The building managers can use those data analysis tools to set energy saving targets and to control the E&M systems to optimize energy performance of the building.

Throughout the long life span of a building, changes to the existing building due to alternation and addition works, different occupants, different landlords or usage are not uncommon. The original settings in various E&M systems during commissioning, in particular air-conditioning system, may not optimize energy efficiency in the changed building environment. Retro-commissioning has been introduced recently which enables the E&M systems to adapt to changes and demand for services. It applies smart sensors, uses data mining and implements control algorithms such that the E&M system can respond to changes in building dynamically and to determine the optimal operation mode. In a research study, it is revealed that 15% of saving on energy use can be achieved by retro-commissioning.

2.3 Data and Information and Communications Technologies

Over the past decades, technological progress, building deployment, and falling prices have brought data and ICT, such as IoT, big data, cloud computing, analytic tool, smart sensor, etc. to be widely used in E&M systems and services. The smart E&M systems described above have substantially improved the AMR and energy efficiency to result in enhancing building performance. In the context of smart cities, E&M systems and services in buildings are no longer standalone. E&M systems are connected in the building and interacting with people, environment, and city activities to deliver a better built environment. Modern data and ICT therefore become the key driver for ultimate building performance for sustainable built environment.

Buildings are full of data, information and assets from design, construction to operation phase. The inability to centralize building information and manage E&M assets are the challenges to sustainable built environment. Recently, Building Information Modelling (BIM) has made a revolutionary change in the construction industry which enables building and E&M system design and construction works to be more efficient. The information of building and E&M systems in BIM can be easily searched, accessed and updated. However, such 3D application has not reached the building operation phase yet. Being the largest E&M maintenance agency for the public sector in Hong Kong, the Electrical and Mechanical Services Department (EMSD) has developed a novel architecture for exploiting BIM in asset management (AM) and realised the concept in an integrated BIM-AM system featuring multiple operation and maintenance systems and tools in a single platform. Results of the pilot project demonstrated that BIM-AM is a highly visual operation and maintenance system and asset management tool can enhance the maintainability and availability of E&M systems, especially in fault location and service restoration. The integrated platform has proved effective in streamlining workflow, facilitating incident response, and AM. It is envisaged that the emerging BIM-AM system can improve the building performance and leading building industry to attune to smart E&M systems.

3. OTHER AREAS FOR BUILDING PERFORMANCE

There are other areas that should be considered for building performance. Safety is an issue affecting the building performance in built environment. Fire services and security systems are the E&M systems for protecting the safety of a building. In high rise and commercial buildings, the fire services and security systems are becoming sophisticated and they are no exemption in the trend of smarter technology and data driven system. Building management and security guards shall better utilize these systems to increase the building performance in safety aspect.

Resilience of E&M systems in building is another issue that should be considered when designing a sustainable built environment. Design for resilient E&M system to cope with impacts of extreme weather conditions arising from global climate change and minimizing the damages to buildings is a new challenge.

4. CONCLUSIONS

The aim of enhancement of building performance is to create a better and a more sustainable living and business environment for the purpose of meeting needs of the built environment. The building performance depends heavily on the design, operation and maintenance of E&M systems and services. The smart and data technology has brought smart concept in E&M system in driving ultimate building performance.

While the advancement of E&M systems is to enhance the building performance, designers, building managers, engineers and technicians are facing challenges of maintenance strategies for buildings. Smart and data technology has brought drastic change of AMR from traditional preventive maintenance and post-fault rectification to predictive maintenance and pre-fault rectification. The iBMS enables the building managers to monitor and control the availability of the E&M systems and services. To ride on the smart meters and big data analytics, building energy performance can be visualized in real-time, energy used data can be audited automatically, and energy usage can be optimized continuously. To implement the smart E&M technology in buildings, the emerging technology BIM-AM provides a single platform to centralize building information and to manage E&M assets effectively.

With the collaboration of all building stakeholders, including designers, the construction industry, operation and maintenance and facility management personnel who are acquainted with smart data technology and capability, delivery of smart E&M solutions will be the trend to make sustainable built environment a success. Let us stay connected, join hands and make every possible effort to drive ultimate building performance for sustainable built environment.

REFERENCES

- [1] NASA Technical Memorandum 107398 IEEE-155NO897-550, Design for Maintainability and System Availability
- [2] The Cost-effectiveness of Commercial – Buildings Commissioning a Meta-Analysis of energy and non-energy impacts in existing buildings and new construction in the United States
[\[http://evanmills.lbl.gov/pubs/pdf/cx-costs-benefits.pdf\]](http://evanmills.lbl.gov/pubs/pdf/cx-costs-benefits.pdf)

A Case Study to Automate Demand Response on a University Campus

Thomas Mark LAWRENCE^a, Rick WATSON^b, Javad MOHAMMADPOUR^c, Marie-claude BOURDREAU^d, Sama AGHNIAEY^e, Justin HILL^f

^a University of Georgia, United States of America, lawrence@engr.uga.edu

^b University of Georgia, United States of America, rwatson@uga.edu

^c University of Georgia, United States of America, javadm@uga.edu

^d University of Georgia, United States of America, mcboudre@uga.edu

^e University of Georgia, United States of America, sama.agh@uga.edu

^f Southern Company Services, United States of America, jhill@southernco.com

ABSTRACT

There is a growing need for developing buildings and a built environment capable of interacting with the smart grid. One smart grid benefit for buildings includes potential participation in demand response programs. This capability is more readily implemented with new construction or renovations, but is a considerable challenge with older, legacy systems. This paper outlines work being done to identify strategies for implementation of demand response on one university campus in the United States with nearly 300 buildings located on over 300 hectares. The building and campus control systems range from modern controls that could fairly easily be incorporated into a smart grid down to older legacy systems incapable of adapting without significant upgrade and capital investment.

This campus is on a real-time price tariff for electricity and thus can benefit immediately from any improved methods for demand response. We have focused our study to date on the various chilled water distribution networks that provide comfort cooling to campus buildings. We have tested strategies for taking advantage of the inherent ability of the distribution piping to store thermal energy ('coldness') combined with modifications to building HVAC control set points. We are studying thermal comfort perceptions of occupants in real (non-laboratory) settings to help optimize the changes. Initial tests show a minimum reduction in peak electrical demand of 10-15% in these chilled water networks which has the potential for hundreds if not thousands of US dollar cost savings per day for the campus during periods with relatively high real-time prices. Strategies are also being tested to achieve this peak demand reduction while also decreasing (or at least not increasing) total energy consumption through the day. The study is also identifying technical, economic and operational barriers to retrofitting existing campus facilities with the capability to participate in demand response systems.

Keywords: demand response, smart grid, thermal comfort perception

1. INTRODUCTION

The potential for automated demand response (ADR) is one of the key benefits of a smart grid connected with smart buildings. Many of the prior studies have focused on the technical aspects for peak energy savings and reduced (or at least not increased) total energy consumption. This paper outlines work on one university campus in the United States to identify strategies for implementation of demand response. This is being done within the context of a campus energy system that has a wide range of control system capabilities. We are also including human factor considerations in these studies, such as thermal comfort perceptions within these real world settings.

1.1. Overview of the smart grid and automated demand response (ADR)

The smart grid and smart buildings are relatively new and evolving terms used in various contexts, and there have been many studies on the interactions between a smart grid and smart buildings, for example Georgievski et al., (2012). These terms are generally used to define a building system that has advanced control systems and technologies that allow for interconnected operability giving the capability to operate efficiently in response to external and internal communications. Smart buildings and their associated controls and equipment are capable of responding to demand response requests from the utility or system operator to manage peak demand. The request for demand response implementation could be done directly via a signal from the grid operator or indirectly using real-time electrical pricing signals. When the request and response are done automatically, this is referred to as "**Automated Demand Response**" or ADR. **The need for demand response can arise when: (a) peak demand is high compared to baseload conditions; (b) a relatively high percentage of the electricity supply comes from**

intermittent renewable energy sources, such as wind or solar, requiring flexibility in electricity use (as is the case in Germany now and becoming more so in California); or (c) when trying to manage for lower carbon energy production and avoid the use of inefficient fossil fuel based generation.

Demand response can be run under manual control and operation, but that is not as efficient and can be labor intensive. The interconnectivity that is rapidly developing (the Internet of Things, or IoT) is allowing for the development of ADR. Lawrence, et. al. (2016) provide answers to ten basic questions in the area of how smart buildings will connect to a smart grid.

1.2. Implementation of ADR

Implementation of ADR is being driven by several mechanisms. Capacity driven models ensure that sufficient capacity is available in terms of a built-in reserve margin and use of various mechanisms to curtail peak loads. Market-based programs focus on economic benefits gained by participating customers; e.g., with real-time pricing or incentive based programs. Utilities and system operators may use other ancillary methods to maintain grid operations such as energy storage. Participation in ADR programs may also be required by regulations, for example with the International Green Construction Code or IgCC (ICC, 2015), by market solutions, or voluntary **incentives like the U.S. Green Building Council's LEED rating system.**

The methods chosen for ADR vary based on the energy loads and system types. For example, a university campus or office building will primarily look at the demand for cooling, heating or lighting, etc., within its various buildings **whereas an industrial user's response may be heavily weighted toward process loads.** The evolution toward automated demand response (ADR) identifies the need for standardized method(s) for communication between electric utilities and agents on the demand side of the meter about grid status, etc. There are a number of developments needed to make ADR work, ranging from policy to economic measures to technology needs. For example, a control protocol is needed to allow equipment and systems from various manufacturers to communicate in a standardized way with each other and with the grid; this is the purpose of OpenADR (OpenADR Alliance, 2015). In addition, a new standard was recently released (ASHRAE, 2016a) that defines an object-oriented information model to enable management of electrical loads and generation sources in response to communication with the smart grid.

Developing methods and algorithms to coordinate building operations in a manner that adequately serves customers and building occupants, factoring in the capabilities of the existing control systems, while improving electric grid efficiency and renewable resource utilization, is also needed. Approaches have often explored top-down strategies where lower-level devices are directed by higher-level coordinating entities.

1.3. Challenges with existing facilities

Depending on the age and degree of sophistication with the existing building automation and control systems, ADR may be fairly readily implementable or pose extreme challenges. This situation is magnified in a typical university campus, such as the one discussed in this study, because the building control systems likely vary widely in terms of complexity, vintage, capabilities, and achieved performance. Moreover, individual buildings may have evolved and hybridized organically. This presents a significant barrier to the rapid and full-scale market penetration of smart buildings in such settings. Another key barrier to the transition of legacy buildings is the cost of upgrading building control system(s). Few small to medium sized buildings are equipped with a centralized Building Energy Management Systems (BEMS), impeding smart grid functionality. Instead, for those legacy buildings, smart grid control features are increasingly offered at the component and subsystem level. One new technology can allow for legacy pneumatic thermostats to be wirelessly connected to building control systems, thus giving control functionality similar to modern direct digital control.

The remainder of this article provides more detail about methods to implement ADR and human factors considerations. In addition, results from initial studies and testing on one university campus in the United States are also presented.

2. METHODS FOR IMPLEMENTATION OF DEMAND RESPONSE IN BUILDINGS

Control systems for building HVACs have evolved from simple on-off switching. For much of the 20th century, pneumatic controls were the dominant technology. They offered adapting proportional, integrative and derivative (PID) control logic and remained popular until the 1990s. They provide reliable and steady control functions but have limited flexibility and are reliant on a steady supply of compressed air, which requires energy. Direct digital control (DDC) development began in the 1960s, but it took time for DDC systems to replace pneumatic control. The development of DDC and the higher level building energy management systems, along with communication protocols between buildings, their equipment and the grid, paved the way for buildings to participate in demand response. Within buildings, the best potential for temporarily adjusting energy demand is with the HVAC, lighting systems, and in some situations other services such as water heating and plug loads.

2.1. Heating, ventilation and air conditioning (HVAC) systems

Zone temperature set points can be adjusted to reduce cooling or heating demand, but there are concerns with **occupants' thermal comfort perceptions and humidity control. Supply air temperatures and flow rates can also be** adjusted. Temporary adjustments can be made in the chilled and hot water or variable refrigerant flow systems. In all cases, there is a need to coordinate actions to achieve the desired reduction in electrical demand. Also, the timing for any changes and transitions needs to be set to avoid problems such as a rebound effect when the demand response event is over and system control reverts to normal operations.

Although each building has a unique set of circumstances regarding usage type, climate, utility demand response programs, regional expectations for occupant acceptance of temperature (and humidity) changes, and occupancy diversity, etc., there can be some generalizations made as to how far HVAC system operations can be temporarily adjusted to reduce demand without adversely affecting equipment operation, occupant thermal comfort, or indoor air quality. Other guidance for the degree of changes that should be acceptable can be found from building codes or standards that relate to demand response. Along these lines, the IgCC requires that HVAC systems with DDC shall have a capability to remotely change the operating temperature set points by 2.2°C (4°F) or more (upward in cooling mode, downward in heating mode) in all non-critical zones given a signal from a centralized contact, such as a building energy management control system (ICC, 2015). This code also requires that the ADR strategy include logic to prevent a rebound peak energy demand. A discussion on thermal comfort perception and demand response is given later in Section 3 of this paper.

Other HVAC system adjustments can be made upstream of the occupied zones, such as setting upper limits on supply fan speeds, changes in supply air, chilled water or hot water temperatures. Any demand response strategy must still provide adequate ventilation rates to maintain acceptable indoor air quality as well as not lead to too high humidity levels in the space. ANSI/ASHRAE Standard 62.1-2016 (ASHRAE, 2016b) requires that relative humidity levels not exceed 65% (unless higher levels are dictated by the space usage type) and also specifies the required ventilation rates to occupied spaces based on occupancy type.

2.2. Lighting

It could be argued that in a perfect world, lighting controls would be in place to provide the minimum amount of lighting needed in a space based on the expected occupancy type and occupancy patterns, and that daylighting control would actually be part of that strategy. However, if we were in the perfect world within the built environment then there would be no need for papers such as this. In spaces where daylight responsive controls are not installed and the installed lighting power density is at or exceeds the levels set by relevant energy codes, the ADR strategy could include temporary reductions in the total lighting power in the range of 10-15%. Lighting power density is defined as the total connecting lighting power (Watts) divided by the conditioned floor space, for a resulting W/m² metric. This requires luminaires that are dimmable or electrical circuitry to adjust lighting fixtures separately or in small groups. The best options for this exist in business offices, retail stores and educational facilities. Decisions as to exactly what spaces and luminaires to adjust require some thought and engineering analysis, and the lighting power reduction must be set up to ensure that it would not endanger occupant safety or security.

2.3. Thermal energy storage

Thermal energy storage is a common way to shift HVAC demand, particularly for cooling loads. The dominant method probably is through the use of ice or cold water storage systems, although other technologies such as phase change materials are becoming more common. Besides equipment purposely designed and installed to store thermal energy, passive thermal energy storage can be incorporated by methods such as pre-cooling of buildings using mechanical systems or cooler ambient air during evening when possible. Another more novel technique that has been tested at our campus is the pre-cooling of large chilled water distribution networks and **then using that stored “coolth” to help reduce cooling load during peak demand periods.**

2.4. Other measures

Another argument that can be made concerning demand response is that the building operations should ensure maximum overall energy efficiency as a first step. This reduction in energy consumption naturally carries over into peak demand periods and in many situations may be the most economical method. However, the definition of **‘demand response’ set by the local utility or electrical system operator may be based on the peak demand expected for the “as-built” condition** of this building or even just the current demand in real-time.

Additional demand response measures that could be considered include turning off plug loads when not absolutely needed, reducing temperatures of domestic hot water in storage tanks, or encouraging work from home on a particular day when ADR is anticipated (although that may not reduce overall grid demand if the home HVAC systems are then used more).

3. INDOOR ENVIRONMENTAL QUALITY AND OCCUPANT THERMAL COMFORT PERCEPTION

Fanger proposed the **concept of the Predicted Mean Vote (PMV) in the 1960's and this has since served as the basis** for many of the thermal comfort guidelines and standards. The adaptive principal (Bedford, 1936) is based on the concept that if people are in thermal discomfort, they will react in ways that tend to restore their comfort and thus they are not passive recipients of their thermal environment. The range of comfort temperature in field studies has proven to be wider than that of the rational approach that is used by ASHRAE (2016c) and ISO 7730 (ISO 2005). Nicol and Humphreys (2002) reported that the optimum temperature of comfort strongly correlates with the mean temperature that people have recently experienced, and the predicted mean vote (PMV) is only weakly correlated with the indoor temperature. They relate this discrepancy to the adaptive behavior of subjects as the result of feedback between personal comfort and behavior. Some researchers have also proposed that the range of neutral temperature was too wide to be specified through the PMV equation (Hoyt, et al., 2009). However, the actual thermal comfort experienced by occupants depends greatly on a wide range of factors such as **demographics, context, environmental interaction, and cognition as well as the occupant's** past thermal history and time of exposure at this the current temperature. When we consider individuals as active agents that go through a series of behavioral, psychological, and physiological adaptations, it should be possible to account for human **adaptive capability when implementing ADR programs. Based on the adaptive thermal comfort model “there is no absolute reference point or threshold on comfort continuum” (de Dear and White, 2008). As a result, occupants with repeatedly exposed to increased indoor temperatures eventually increase their tolerance to warmer indoor temperatures as they “re-acclimatize” or get accustomed to those temperatures.**

Therefore, making adjustment to the building's HVAC zone temperature set points has significant potential for inclusion in ADR measures. However, the actual level of change needs to factor in a number of parameters. Thus, it is more complicated than just specifying a set temperature change value. The next section briefly describes some of the testing that has been done at one large university in the south-eastern region of the United States.

4. TESTING AND RESULTS TO DATE

To date, most research about the real-world testing of demand response measures has focused on the energy savings alone; indeed, very few studies include an analysis of any corresponding thermal comfort impact. It is, however, impossible to optimize the energy saving potential for ADR without understanding its impact on occupants. Our research group has been investigating methods for implementing ADR and the effects on building occupants

in a “real world” setting, i.e., a major research university in the United States. Cooling for most of the campus’s buildings is provided using a chilled water distribution network, which is itself a potential source of thermal energy storage due to the thousands of meters of relatively large pipes needed to transport chilled water to buildings. Tests were run on several buildings investigating coordinated changes in the HVAC systems, such as zone set point changes, supply air flow and temperatures and chilled water supply temperatures. Only relatively small changes have been made to date in the coordinated peak demand reduction studies, for example supply air and zone air temperature set points were increased by 1.7°C (3° F). The tests also involved a scheduled pre-cooling of the chilled water supply during the off-peak hours in the morning followed by allowing the chilled water temperatures to gradually rise in the network during the peak cooling hours, thus effectively tapping into the thermal energy storage capacity built into the network.

Figure 1 below depicts sample results for energy saving at one of the central chilled water plants from a test run in August 2015. The results revealed that a decrease of 11.1% in total energy consumption and 11.5% in peak demand compared to a baseline day (the next day) that had nearly identical weather conditions, and this is significant because changes were only made in a portion of the just a couple of buildings connected to this particular chilled water network. A thermal comfort survey of building occupants during the test date and a baseline date the following day indicated no real difference in thermal comfort perceptions (Figure 2), thus indicating that additional energy savings should be possible without compromising thermal comfort.

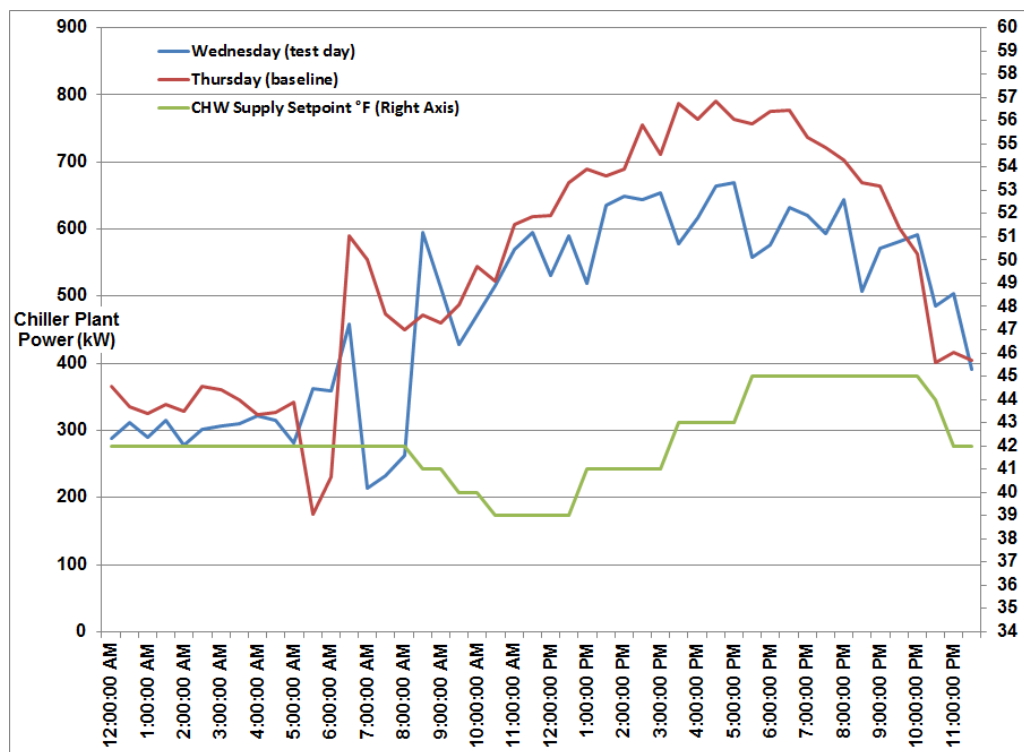

Figure 1: District energy chiller plant power and water temperatures for test day vs. baseline

Thermal Comfort Survey Summary									PPD
Location	Response Summary			Breakdown				Average	% People
	Cold	OK	Hot	Student	Faculty	Male	Female	PMV Calc	Dissatisfied
Baseline									
Tate (8/25)	5	29	3	32	5	16	21	-0.1621622	5.5%
Test Date									
Tate (8/26)	18	144	21	167	16	80	103	0.0491803	5.1%

Figure 2: Occupant thermal comfort survey results for test day vs. baseline

Another study that started in the summer of 2016 is focusing more on human factors and occupant thermal comfort associated with ADR. Several classrooms, offices, lobbies, and one dining hall were investigated with various zone temperature set points of up to 23.3°C without informing the occupants that testing was ongoing. The results revealed that not only was thermal comfort not compromised, but also the PMV value was marginally improved in

some cases. While temperature level may seem still low compared to values used in other regions of the world, it should be considered in context of the current level of expectations for this population and in this region. The next phases of this study will try to reveal more about thermal comfort thresholds in real world for buildings with different applications, enabling a better optimization between energy consumption and occupant thermal comfort.

REFERENCES

- [1] ASHRAE. (2013). ANSI/ASHRAE Standard 55-2013 Thermal Environmental Conditions for Human Occupancy. American Society of Heating, Refrigeration and Air Conditioning Engineers, Atlanta, Georgia.
- [2] ASHRAE. (2016a). ANSI/ASHRAE/NEMA Standard 201-2016 Facility Smart Grid Information Model. American Society of Heating, Refrigeration and Air Conditioning Engineers, Atlanta, Georgia.
- [3] ASHRAE. (2016b). ANSI/ASHRAE Standard 62.1-2016 Ventilation for Acceptable Indoor Air Quality. American Society of Heating, Refrigeration and Air Conditioning Engineers, Atlanta, Georgia.
- [4] Bedford, T. (1936). The Warmth Factor in Comfort at Work, MRC Industrial Health Board Report, No. 76.
- [5] de Dear, R., and White, S., (2008). Residential air conditioning, thermal comfort and peak electricity demand management. Proceedings of Air Conditioning and the Low Carbon Cooling Challenge, Cumberland Lodge, Windsor, UK, pp. 27-29.
- [6] Fanger P.O. (1972). Thermal comfort: analysis and applications in environmental engineering. McGraw-Hill, New York, New York.
- [7] Georgievski, I., Degeler, V., Pagani, G.A., Nguyen, T.A., Lazovik, A & Aiello, M. (2012). Optimizing Energy Costs for Offices Connected to the Smart Grid. IEEE Transactions on Smart Grid. 3(4). p. 2273-2285.
- [8] Hoyt, T., Lee, K. H., Zhang, H., Arens, E., & Webster, T. (2005, August). Energy savings from extended air temperature set points and reductions in room air mixing. In International Conference on Environmental Ergonomics 2009.
- [9] International Code Council. (2015). International Green Construction Code. IgCC 2015. Washington, DC. <http://www.iccsafe.org/codes-tech-support/codes/2015-i-codes/igcc/>
- [10] ISO. (2005). ISO 7730:2005 Ergonomics of the thermal environment – Analytical determination and interpretation of thermal comfort using calculation of the PMV and PPD indices and local thermal comfort criteria. International Standards Organization, Geneva, Switzerland.
- [11] Lawrence, T.M., Boudreau, M-C, Helsen, L, Henze, G., Mohammadpour, J., Noonan, D., Patteeuw, D., Pless, S. and Watson, R.T. (2016). Ten Questions Concerning Integrating Smart Buildings into the Smart Grid, Buildings and Environment. Invited paper, in press. <http://dx.doi.org/10.1016/j.buildenv.2016.08.022>
- [12] Nicol, F. and Humphreys, M. (2002). Adaptive Thermal Comfort and Sustainable Thermal Standards for Buildings. Energy and Buildings. 34(6):556-572.
- [13] OpenADR Alliance. (2015). OpenADR 2.0 Profile Specification. Document Number 2012091201. Updated 11-17-2015. <http://www.openadr.org/specification-download>
- [14] U.S. Green Building Council. (2016). LEED v4 for Building Design and Construction. Washington, D.C. Updated April 5, 2016. http://www.usgbc.org/sites/default/files/LEED%20v4%20BDC_04.05.16_current.pdf

Short-term Load Forecasting Model with Predicted Weather Data

ZHU Guangya^a, CHOW Tin-tai^b, Norman TSE^c

^a City university of Hong Kong, Hong Kong SAR, zhuguangya828@yahoo.com

^b City university of Hong Kong, Hong Kong SAR, bsttchow@cityu.edu.hk

^c City university of Hong Kong, Hong Kong SAR, bsnorman@cityu.edu.hk

ABSTRACT

Introduced in this paper are our recommended weather forecasting model and the associated prediction procedure. These facilitate the formulation of a convenient and accurate short term energy consumption forecasting method. We started with an overview of the building related energy forecasting. A simplified weather model was then proposed for the output of key weather data, including dry-bulb temperature, relative humidity and global solar radiation. On top of this, a framework of energy-use forecasting technique is introduced, which brings in the data filtering and raw data set regrouping methods. Our result comparisons show that the predictions of the Mean Absolute Percentage Error (MAPE) from the weather data on record, or from the model-generated data set, differ very little. Illustrating examples via a university building case are discussed. The above indicate that our proposed weather prediction model is convenient and suitable for the mentioned purposes. Comparisons among the different input data sets also demonstrate that the forecasting accuracy has been enhanced through input data filtering and regrouping.

Keywords: weather prediction, energy consumption forecasting, energy saving

1. INTRODUCTION

Global warming and fossil fuel depletion lead to international protocols formulation, that in turn drive the building owners, operators and customers to improve the overall system energy efficiency and to search for new technologies with better saving potential. Along this direction, an accurate short-term load prediction tool is mostly in need. It is crucial for the operation plan of the utility systems and for the smart micro-grid applications as well, to allow the utility to take action, or to balance the supply and demand side(s) in principle, or to reduce the overall energy consumption.

Generally speaking, energy consumption forecasting methods can be grouped into three categories based on their time-horizon [Gonzalez-Romera E, 2006], i.e. long-term forecasts of more than one year, medium-term load forecasts from one week ahead to one-year ahead, and short-term load forecasts (STLF) used for predicting the load from a few hours up to weeks ahead. Among these, STLF with the time-horizon of 24-hour ahead is often focused on [Borges CE et al., 2013]. Accurate STLF of the micro-grid can enhance the system ability to use renewable energy resources and to improve the system efficiency and economics in response to the electricity markets [Massana J et al., 2015]. This will enable the utility provider to take action to control the balance between the supply and demand sides. However, there are many influential factors like the weather conditions of tomorrow that affect the building operation and make the building electricity load more difficult to predict. Many researchers worked on the sensitivity of these factors and introduced various black-box or grey-box forecasting models [Chitsaz H et al., 2015 and Chae YT et al., 2016]. Many external factors employed were actually the weather data on record of the following hours instead of truly acquired from weather forecast. In view of this, some researchers [Friedrich L et al., 2015, Roldan-Blay C et al., 2013 and Lazos D et al., 2015] propose to use the weather forecast data from third party institutions, or using a forecasting model to generate the unknown weather data. However, this kind of data is not always available and often has cost implication. It becomes worthwhile to develop new weather forecast methodology for acquiring the unknown weather data set (or the next day 24-hour weather profile) for STLF applications.

2. WEATHER FORECAST MODEL

The new weather forecasting model here introduced serves to generate predicted weather data of tomorrow simply based on the publicly available weather forecast information, like those from internet. A generated sample of the discrete 24-hour dry-bulb temperature and relative humidity are shown in Figure1(a), and the predicted horizontal global solar radiation curve is in Figure1(b).

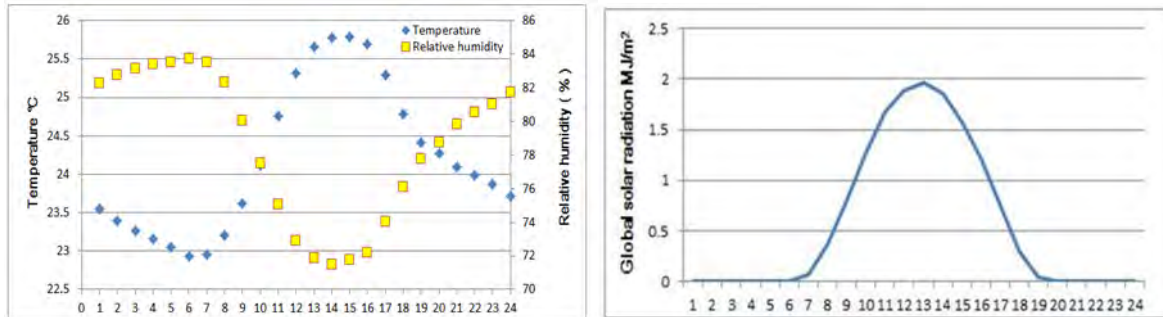

Figure 1: Generation of predicted weather data for the next day 24-hour profile

2.1 Dry-bulb temperature prediction

The dry-bulb temperature profile across the day embraces the range between its maximum and minimum values, T_{max} and T_{min} . It disseminates regular pattern geographically that can be approximated by the use of a daily range of multipliers, each of which provides the deviation ratio between T_{max} and that of the given hour $T_{current}$. Hence,

$$T_{current} = T_{max} - \beta_{Multiplier} \times (T_{max} - T_{min})$$

Equation 1

The range of multiplier values $\beta_{Multiplier}$ can be generated from the historical weather record. For example, based on the Hong Kong Observatory weather data record from 2012 to 2015, the average daily temperature profiles are shown in Figure 2(a), and the multiplier values generated are shown in Figure 2(b). It can be seen that the multiplier values across the day are more or less the same for these 4 years although 2015 was actually much warmer than the other 3 years.

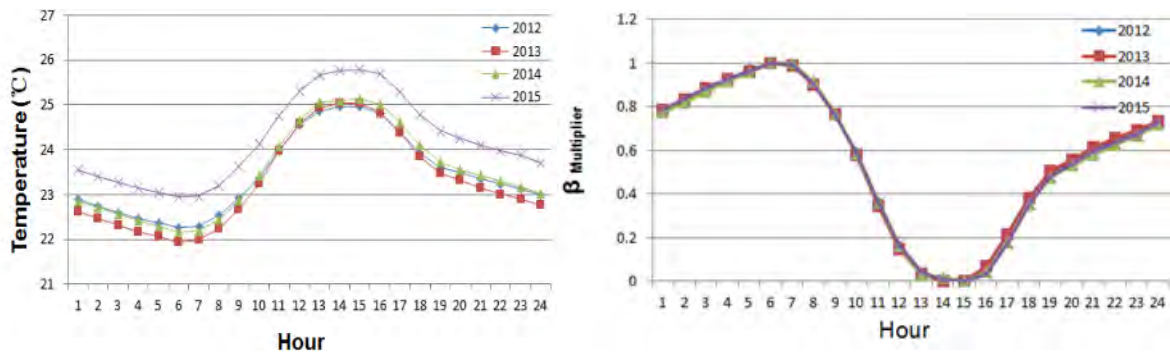

(a) Average daily temperature profile

(b) Multiplier value profile

Figure 2: Averaged hourly weather data profiles: (a) Daily temperature, and (b) Multiplier value

2.2 Relative humidity prediction

Based on the predicted temperature value and its relationship with the water vapour saturation pressure, the **relative humidity (RH or ϕ) can be determined.**

Step 1: Calculate water vapour saturation pressure

$$p_{qb} = 610 \times 10^{\frac{7.45T}{235+T}}$$

Equation 2

where p_{qb} is the water vapour saturation pressure and T is the temperature.

Step 2: Generate reference water vapour pressure P_c

The RH of the daytime and night-time can be acquired from local weather forecasting report. Since Hong Kong is a coastal city, P_c is relatively stable within a day. Then the constant value of P_c can be taken as the average of the daytime and night-time RH.

Step 3: Calculate relative humidity (RH)

$$\phi = \frac{P_c}{p_{qb}} \times 100\%$$

Equation 3

2.3 Global solar radiation prediction

In order to predict the global solar radiation for the next day 24 hours, the sunrise time (t_{sr}) and the sunset time (t_{ss}) on the day of prediction are first calculated [Roldan-Blay C et al., 2013]. d_n denotes the day number of the year from 1 to 365, taking February 29 the same as February 28. Thus, the daily angle θ is calculated as:

$$\theta = \frac{2\pi}{365} (d_n - 1)$$

Equation 4

The equation of time (et) denotes the difference between the true solar time and the mean solar time, in that

$$et = (0.000075 + 0.001868 \cos(\theta) + 0.032077 \sin(\theta) - 0.014615 \cos(2\theta) - 0.04089 \sin(2\theta))229.18$$

Equation 5

Solar declination δ is the angle in radians between the equatorial plane and the line connecting the centre of the sun and the earth. It can be shown that:

$$\delta = 23.45 \cos\left(2\pi \frac{d_n - 173}{365}\right) \frac{\pi}{180}$$

Equation 6

The solar angular hour (h) is calculated as:

$$h = \cos^{-1} \left(\frac{\sin\left(\frac{-0.833\pi}{180}\right) \sin(\delta)}{\cos(\phi) \cos(\delta)} \right)$$

Equation 7

The number of hours of daylight (n_d) is a function of h , in that

$$n_d = \frac{h}{7.5} \frac{180}{\pi}$$

Equation 8

Then the sunrise (t_{sr}) and sunset time (t_{ss}) are:

$$t_{sr} = 12 - \frac{nd}{2} - \frac{et}{60}$$

Equation 9

$$t_{ss} = 12 + \frac{nd}{2} - \frac{et}{60}$$

Equation 10

Finally, the solar radiation model can be based on the simple sky model [Iqbal, M 1983], which is characterised by the parameters of the peak solar irradiance (I_{max}), the sunrise time (t_{sr}) and the sunset time (t_{ss}).

2.4 Results of weather prediction

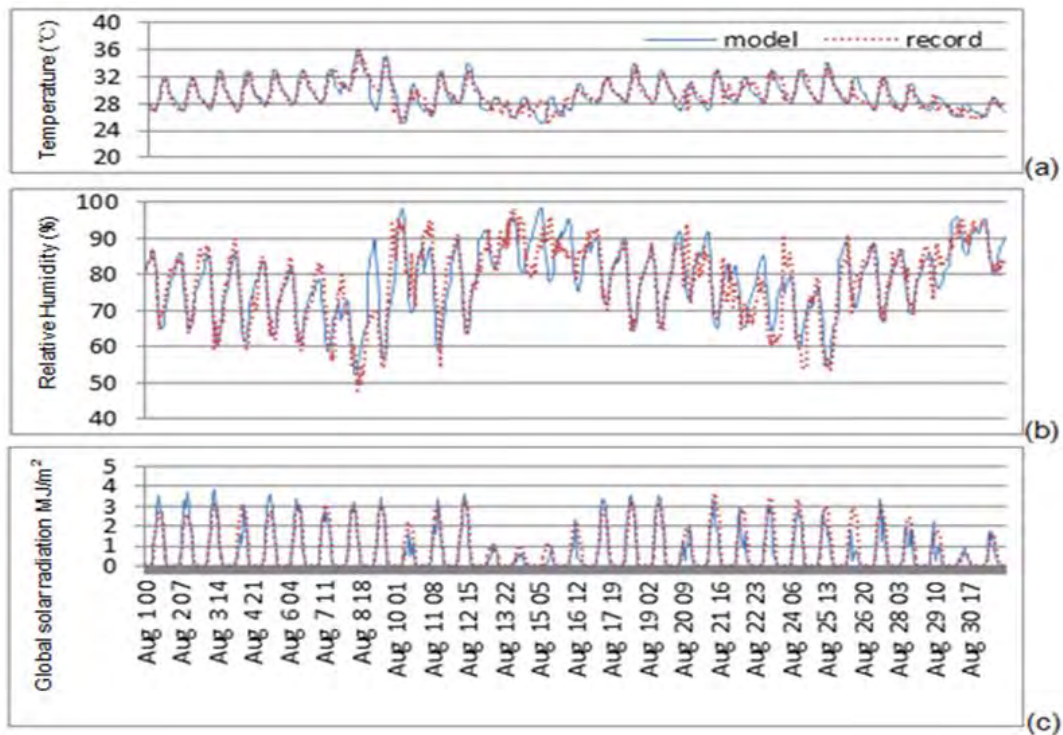

Figure 3: Results comparisons: (a) Dry-bulb temperature (b) Relative Humidity, and (c) Horizontal global solar radiation

The deviations of weather data between our proposed model and the record data from 2013 were determined. The comparison results of temperature, relative humidity and global solar radiation in January are shown in Figure 3 (a) to (c). The overall forecasting mean absolute percentage error (MAPE) of dry-bulb temperature, relative humidity and global solar radiation are 3.2245, 5.6978 and 11.3064 respectively. This indicates that the proposed model is able to give predictions with good accuracy.

3. FORECASTING METHODOLOGY

In the forecasting framework, the raw data is first prepared. Then the influence factors are ranked by their importance, and the less important factors will be filtered. Then the remaining input data are regrouped based on their building energy consumption characteristics. Once the filtering and regrouping processes are completed, the forecasting model structure is subject to optimization. The following shows its application to an illustrating case.

3.1. The study case

The presented case is a university building having an overall floor area of 70,000 m² and is a two northwest-oriented blocks each with seven floors. The daily operation hours are from 07:00 - 23:00 on workdays and 07:00 - 18:00 during weekend. Space cooling is required throughout the year. ANN is adopted as the forecasting model, with the LSSVM applied as a reference model [Hyun Chul Jung et al., 2015]. These two models program was developed in MATLAB 2015a version, running on the computer with 32G memory and 2.67GHz process. The test period was from July to September 2014. The rest of data was used as the training sample.

3.2. Data preparation and filtering

The 2013- 2014 weather data, historical energy consumption record, and building operation schedule were used as input parameters to predict the next day 24-hour energy consumption. The weather data include dry-bulb temperature, relative humidity, global solar radiation, rainfall, clearness of sky, cloud condition and wind speed. The historical energy consumption record was from the building management system. The operation schedule information was based on the day types, hours of the day and the periods of the whole academic year. These include the semester, student revision period, examination period, and semester break - all are in the university academic calendar.

The input data were filtered before loading into the forecasting model. The test was by means of the mutual information (MI) criterion, in that the influence factors were collected with the MI value calculated, and then their importance were ranked [Keynia F, 2012 and Esmaili S et al., 2014].

3.3. Data regrouping

Figure4 shows the energy consumption contour of this building, through which the overall daily profile and weekly trend can be readily visualized. The X-axis shows the dates in August and the Y-axis is the 24-hour across the day. It can be seen that from 00:00 AM to 8:00 AM, the energy consumption is low. Then after 8:00 AM, the energy consumption is increasing rapidly. The peak load occurs between 14:00 PM and 17:00 PM. After 20:00 PM, the energy consumption is decreasing. On the other hand, the daily consumption during weekday is relatively stable. Those during weekend are comparatively low. But there are exceptions. For instance, because of the typhoon on August 14, the consumption was low throughout this weekday. In our model, the energy consumption forecasting on holidays or under special circumstances were handled separately. Accordingly, the input data are divided into two parts. One part includes only the normal working day information, as data set 1. The rest consists of the holidays, weekends and days with emergency; the information are referred as data set 2.

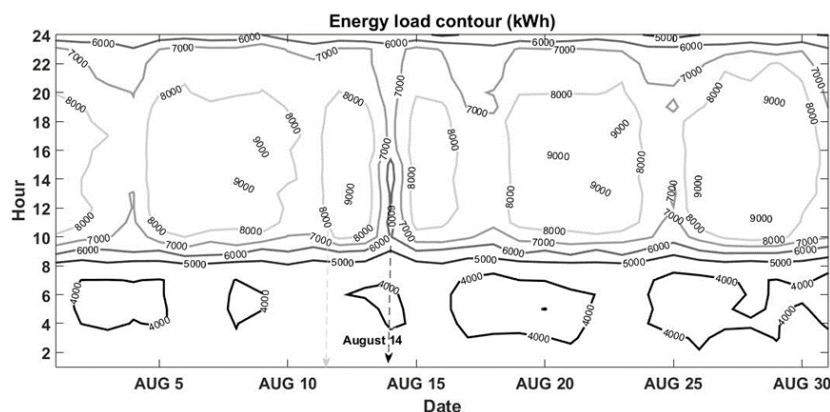

Figure 4: Hourly energy consumption contour

4. FORECASTING RESULTS

The details of forecasting accuracy can be found in Tables 1 to 3. The accuracy criteria adopted are the Mean Absolute Percentage Error (MAPE), Daily Peak MAPE, Coefficient of Variance of the Root Mean Squared Error (CVRMSE) under 95% confidence limits.

The results of forecasting are found agreeing well with the real consumption load. The overall MAPE values are found similar by using either the record weather data or the proposed weather forecast data. The simulation results are also compared with different input data sets, such as those without filtering or regrouping. The results indicate that filtering and regrouping are the effective ways to improve the forecasting accuracy. Figure 5 is the energy consumption profile comparison between the two different forecasting models and the actual load curve. The black solid line represents the real electrical consumption, while the red and blue broken lines represent the ANN and LSSVM forecasting energy profiles respectively. The comparison confirms that the forecasting results agree well with the real consumption load. The overall MAPE are no more than 6.1% and 5.5% for the ANN model and the LSSVM model respectively.

Model	record weather data			modelled weather data		
	MAPE	Daily peak MAPE	CVRMSE	MAPE	Daily peak MAPE	CVRMSE
ANN	5.9775	4.9217	7.9112	6.0245	5.2247	8.1223
LSSVM	5.2496	4.1713	8.0707	5.4432	4.5712	8.3210

Table 1: Comparison of forecasting errors between real and modelled weather data

ANN	Filter			No filter		
	MAPE	Daily peak MAPE	CVRMSE	MAPE	Daily peak MAPE	CVRMSE
Data set1	4.9695	3.8383	4.1505	5.3045	4.0335	7.3465
Data set2	7.0423	6.0807	9.4196	7.4061	6.7266	9.8304

Table 2: Forecasting errors with input data filtered and without filter (ANN vs real data)

Model	regroup			no regroup		
	MAPE	Daily peak MAPE	CVRMSE	MAPE	Daily peak MAPE	CVRMSE
ANN	5.9775	4.9217	7.9112	6.8615	6.6017	9.4473
LSSVM	5.2496	4.1713	8.0707	5.7847	4.2815	8.3282

Table 3: Overall forecasting errors between input data with and without regrouping (Real weather data)

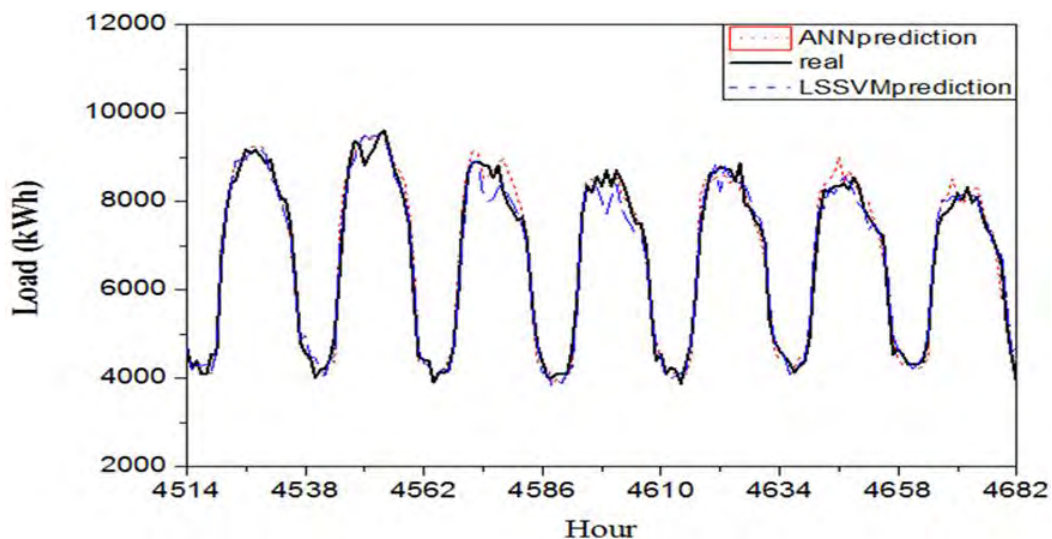

Figure 5: Forecasting results vs. real energy consumption in the case study

5. CONCLUSION

A new method is proposed to generate weather data by prediction based on information publicly available. Data of influence factors were carefully collected. The importance of different input data was analysed with the application of mutual information in a study case. The proposed method has been shown able to achieve good forecasting results for the next day 24-hours energy consumption. The comparison of forecasting results shows that by regrouping and filtering the input data, the forecasting accuracy can be improved. It is also confirmed that the weather prediction model here proposed is convenient, and suitable for short-term load forecasts of buildings.

ACKNOWLEDGEMENT

The work described in this article was financially supported by the Contract Research Grants of the City University of Hong Kong (Project no. 9231136).

REFERENCES

- [1] **Borges C.E., Peña Y.K., Fernández I., Prieto J. and Bretos O. (2013) "Assessing tolerance-based robust short-term load forecasting in buildings" *Energies* 6(4): 2110-2129.**
- [2] Chae Y.T., et al. (2016) "Artificial neural network model for forecasting sub-hourly electricity usage in commercial buildings" *Energy and Buildings* 111: 184-194.
- [3] Chitsaz H., et al. (2015) "Short-term electricity load forecasting of buildings in micro grids" *Energy and Buildings* 99: 50-60.
- [4] Esmaeili, S., et al. (2014) "Development of a thermal and electrical energy management in residential building micro-grid." *Journal of Renewable and Sustainable Energy*, online publication 1-Jan-2014.
- [5] Friedrich L. and Afshari A. (2015) "Short-term forecasting of the Abu Dhabi electricity load using multiple weather variables" *Energy Procedia (ICAE 2015)* 75: 3014-3026.
- [6] Gonzalez-Romera E., Jaramillo-Moran M.A. and Carmona-Fernandez D. (2006) "Monthly electric energy demand forecasting based on trend extraction" *IEEE Transactions on Power Systems* 21(4): 1946-1953.
- [7] **Hyun Chul Jung, Jin Sung Kim, Hoon Heo. (2015) "Prediction of building energy consumption using an improved real coded genetic algorithm based least squares support vector machine approach" *Energy and Buildings* 90: 76-84.**
- [8] Iqbal M. (1983) *An Introduction to Solar Radiation*; Elsevier: New York, NY, USA.
- [9] Keynia, F. (2012) "A new feature selection algorithm and composite neural network for electricity price forecasting" *Engineering Applications of Artificial Intelligence* 25(8): 1687-1697.
- [10] Lazos, D., et al. (2015) "Development of hybrid numerical and statistical short term horizon weather prediction models for building energy management optimisation" *Building and Environment* 90: 82-95.
- [11] Massana J., et al. (2015) "Short-term load forecasting in a non-residential building contrasting models and attributes" *Energy and Buildings* 92: 322-330.
- [12] Roldan-Blay, C., et al. (2013). "Upgrade of an artificial neural network prediction method for electrical consumption forecasting using an hourly temperature curve model" *Energy and Buildings* 60: 38-46.

Session 3.10: Transforming SBE Practices – Energy Management (2)

Dynamic CO₂ and Occupancy Modelling for Predictive Control

Alexandros PANTAZARAS^a, Mat SANTAMOURIS^b, LEE Siew-eang^c

^a National University of Singapore, Singapore, a.pantazaras@u.nus.edu

^b University of New South Wales, Australia, m.santamouris@unsw.edu.au

^c National University of Singapore, Singapore, bdgleese@nus.edu.sg

ABSTRACT

CO₂ is one of the primary indicators for the regulation of Demand Control Ventilation systems, as it is directly linked to occupancy. CO₂ can also serve as a surrogate indicator of indoor air quality and a proxy to other occupant generated pollutants. Although the use of CO₂ in control strategies has been fairly common in the industry for several years, there is still very little research to evaluate model predictive control incorporating future CO₂ levels. In essence, model predictive control is created around a model, or a set of models, which provides an estimation of the evolution of a process or system over time, subject to the effects of disturbances. It provides information of the system response under various control inputs and, ultimately, it decides on the optimal combination of controls. The more accurate the model, the better the performance of the controller. For accurate CO₂ prediction, it is important to know how the occupancy varies on a daily basis. Standardised occupancy schedules are not able to provide this level of resolution, since they are more of an averaged pattern. For building energy consumption this may be enough to produce accurate annual, monthly or even daily predictions, but for CO₂ levels an “average” pattern is likely to be flawed more often than not. In this study, highly granular predictive CO₂ models are developed through the combination of CO₂ measurements and an EnergyPlus model. A finely calibrated EP model acts as a data generator for a model identification procedure, which can lead to robust CO₂ concentration models of selected spaces.

Keywords: CO₂ prediction, occupancy estimation, energy us

1. INTRODUCTION

Globally buildings are responsible for 20-40% of total final energy consumption and in developed countries this figure is increasing annually at a rate of 0.5-5%, while the building sector accounts for 33% of global CO₂ emissions (Pérez-Lombard et al., 2008). In the USA alone 41% of primary energy use is attributed to buildings, excluding industrial facilities (DOE, 2011). Typically the main components of building energy consumption are the Heating, Ventilation and Air Conditioning (HVAC), as well as the lighting systems, so improvements in the respective technologies and operational efficiency of these systems are of great interest to researchers and industry alike (Hochstein et al., 2012), since significant environmental and economic benefits can be achieved. One particular strategy that is applied in HVAC systems is demand-controlled ventilation (DCV). DCV is meant to provide appropriate ventilation rates to cater for changing occupancy conditions, thus unlocking potential energy minimisation opportunities. Therefore it is most suitable and beneficial for spaces that experience frequent and irregular occupancy variations, such as restaurants, auditoria and institutional spaces like lecture theatres (Brandemuehl and Braun, 1999). Proper ventilation is considered as being able to supply enough fresh air in a space to maintain a healthy and comfortable environment, both in thermal and indoor air quality terms. In DCV systems carbon dioxide (CO₂) is typically used as an indicator of human occupancy (Yang et al., 2015) due to its link to respiration and the ventilation rate is adjusted accordingly to maintain the indoor CO₂ levels under a predefined set point. Occupancy detection on the whole is of great interest since knowing the current and historical occupancy patterns can assist in building control decisions. As such, the measurement of CO₂ concentration in buildings is becoming increasingly important, especially as cheap and robust CO₂ sensors are becoming more common and smart buildings supported by connected and wireless sensor networks. The energy saving potential of CO₂ based ventilation control has been intensively investigated and a thorough review of the literature that includes field studies, simulations and sensor location evaluation has been conducted by Emmerich and Persily (2001). Currently, most Building Energy Management Systems (BEMS) equipped with automated control systems are reactive and adaptive to changing climatic conditions and operational parameters. The inclusion of predictive control in a BEMS permits the calculation of optimum control strategies for various steps into the future (Clarke et

al., 2004). Thus, while an adaptive online control scheme can only react to changing building conditions (Doukas et al., 2007), a model-based predictive control works by evaluating different control scenarios based on predefined objective functions and select those that offer optimum predicted performance (Kolokotsa et al., 2009). Given that most DCV systems currently try to maintain CO₂ within certain levels, it is worth investigating how moving this control decision from a reactive to a predictive protocol may affect the energy consumption of the HVAC system.

In this paper we show that it is possible to develop accurate predictive CO₂ models for a university lecture theatre using a simple array of a few CO₂ sensors. Furthermore, the same setup can be used as a current occupancy estimation system to a reasonable degree of accuracy, thus avoiding the privacy issues emerging from other occupancy detection systems such as cameras. First the experimental setup will be described, followed by a description of the method used to develop the predictive model for CO₂. Finally, it is shown how a reverse model can estimate occupancy and a comparison is made to the ground truth.

2. MODEL DEVELOPMENT

2.1 CO₂ prediction

A general model that can be considered for depicting the change in CO₂ concentration, C , in a room or zone with volume V is the following:

$$V \frac{dC}{dt} = Q_{ven}(C - C_{out}) + G_{CO_2}$$

Equation 1

where G_{CO_2} is the generation rate of CO₂ in the room, which depends on the number of occupants and type of occupant activity. The ventilation rate term Q_{ven} only refers to the outside air entering the zone and can be considered as the sum of mechanically supplied ventilation and infiltration. From Equation 1, and assuming a standard level of activity, the discretised form of this relationship can be expressed as:

$$C_{t+1} = f(C_t, N_t, Q_{ven,t}, C_{out,t})$$

Equation 2

which is a relationship with parameters specific to the conditions of the room where CO₂ is measured. Of these quantities, in this study the zone concentration of CO₂ is the only that is available through measurements. Ambient CO₂, C_{out} , is taken as a constant 400 ppm due to lack of historical ambient data. In order to complete the data set for model identification, the number of occupants and the ventilation rate are needed. These are made available with the use of an EnergyPlus (DOE, 2016) model of the lecture theatre. EnergyPlus has a carbon dioxide estimator, and this function is used to calibrate the number of occupants at various times. The ventilation and infiltration rates are known from the HVAC system properties and a previous energy audit of the university. Thus, the data set is complete and can be used for model identification.

The MATLAB (MathWorks, 2000) System Identification Toolbox is used for this task. The toolbox offers several structures for identifying a system, and we have chosen the discrete time state space representation:

$$x(t+1) = Ax(t) + Bu(t) + Ke(t)$$

$$y(t) = Cx(t) + Du(t) + e(t)$$

Equation 3

where x is the state vector, u is the input vector, y is the output vector, e is a generalised disturbance and A , B , C , D and K are matrices with estimable parameters. The dimension of the matrices corresponds to the model order. The focus of the identification procedure is set to prediction, meaning emphasis is placed in minimising the error for next step prediction assuming the output (i.e. CO₂) is known up to the present. Prediction can be made for a certain prediction horizon that can be several steps ahead. In each case, the output (CO₂) at present time is a measured value and the future outputs are predicted based on assumed inputs (occupancy and ventilation).

2.2 Occupancy estimation

By reversing the model of Equation 1 it is possible to express the number of occupants as a function of CO₂ concentration and ventilation. In this case however, we are not interested in predicting the future number of occupants, which is meaningless in this context, but rather estimating the current number. Again the MATLAB System Identification Toolbox is used in the structure of Equation 3, however this time the focus of the identification procedure is set to simulation, meaning emphasis is placed in minimising the error for a model computed using input data (in this case, CO₂ and ventilation rate) and initial conditions.

3. EXPERIMENTAL SETUP

3.6 Sensor deployment

Three CO₂ sensors have been placed in the lecture theatre, one at the lecturer desk low in the room, the other on a side wall at the middle row and the third one at the final, highest row, as can be seen in Figure 1. The placement of different sensors at varying heights has been done to ameliorate the potential effects on the measurements of both an uneven student distribution and the tendency of warmer air to rise higher, by taking the average of the three sensors as the lecture theatre average.

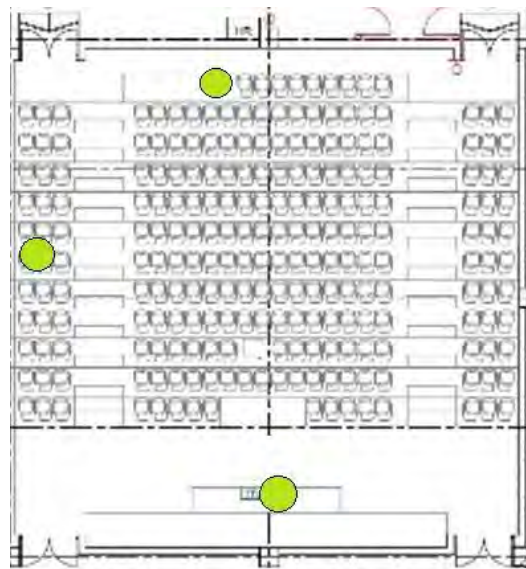

Figure 75: Placement of CO₂ sensors in the lecture theatre

The CO₂ sensors have an accuracy of 30 parts per million (ppm) plus 3% of the reading. The sensors are connected wirelessly via the university network to a server and transmit their measurements at one minute intervals. These measurements are updated and saved in the server so they can be viewed either as historical or current data and can be downloaded for further processing.

Apart from the CO₂ sensors, a camera placed on the ceiling was able to capture an image of all the occupants in the theatre at five minute intervals and log it for further use. This camera was not used in the estimation of the CO₂ prediction model but was used to provide validating data for the occupancy estimation mode

3.7 Data collection

Data was collected for a period of five days during which the lecture theatre was fully active and experienced great fluctuation in occupancy. The CO₂ measurements were taken at a one minute frequency but were grouped in five minute averages for use in the calibration of the EnergyPlus simulation. The result was a set of 1440 data points that were used in the model identification procedure. Of these, 288 (20%) were used to train the models and the rest were used to validate them. The EnergyPlus simulation was run accordingly for a period of five days on a five minute time step and a corresponding reporting frequency. As mentioned previously, this makes available the data for occupancy and ventilation rate.

4. RESULTS

4.1 CO₂ model

The performance of the best estimated model can be seen in Table 1 and Figure 2. On the whole, the model is able to accurately predict the CO₂ concentration even at the furthest prediction horizon that was tested, which corresponds to 20 time steps or 100 minutes. There is however a notable performance drop after the third and especially after the fifth step. Even so, the model is performing very well for predictions between 5 and 25 minutes, which are time periods that are highly relevant for HVAC control actions.

Prediction horizon	R ²	RMSE (ppm)
1	0.9982	11
2	0.9925	21
3	0.9817	33
5	0.9510	55
10	0.8973	82
20	0.8918	85

Table 14: Coefficient of determination (R²) and Root Mean Square Error (RMSE) for different prediction horizons

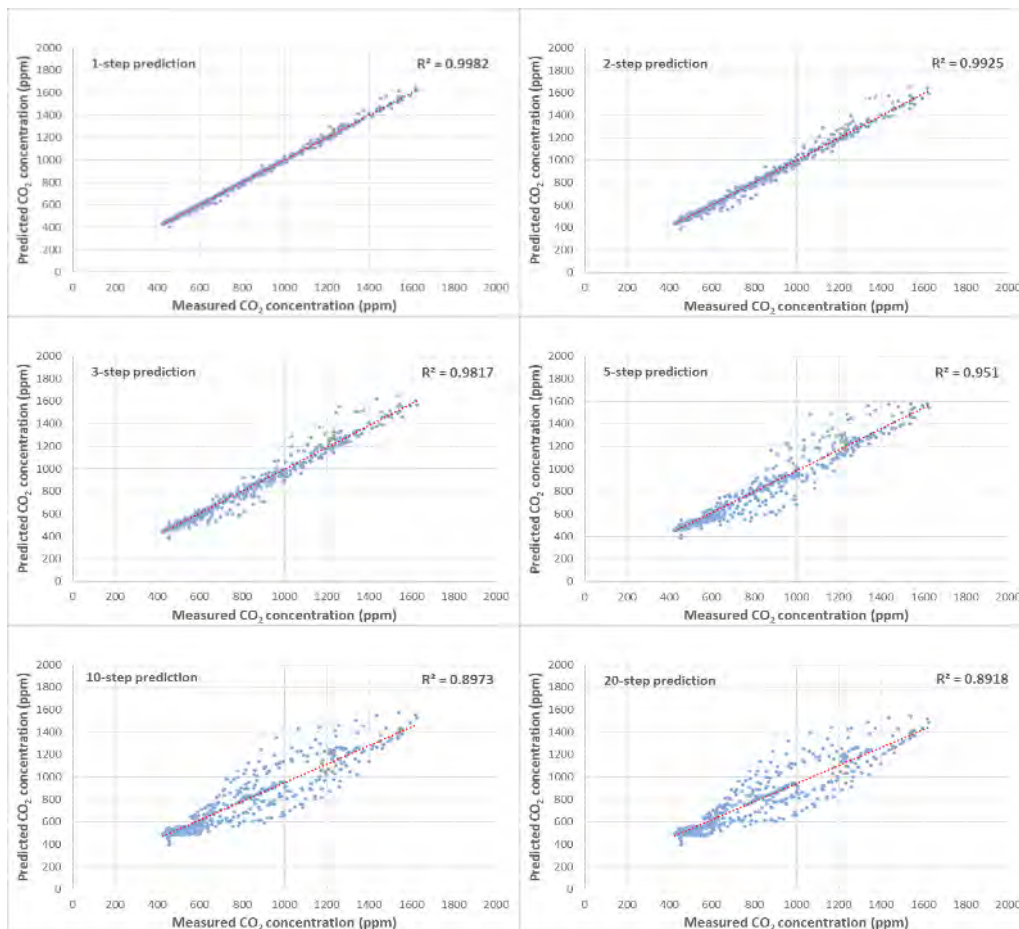

Figure 76: Measured vs predicted CO₂ concentration for different prediction horizons

4.2 Occupancy model

The performance of the best estimated model can be seen in Figure 3, with its associated R^2 and RMSE (in number of occupants). Although the model performs well on average, it generally overestimates the number of occupants, especially when the occupant number is low.

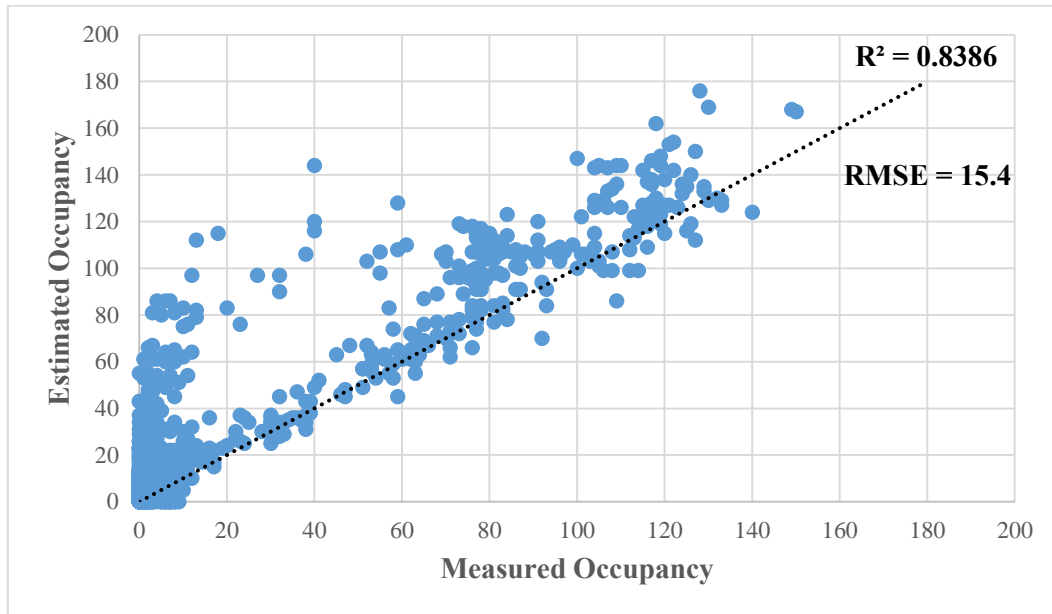

Figure 77: Measured vs estimated occupancy

Most of the larger differences between estimation and actual occupancy occur at transitional periods at the end of classes, which may explain the much bigger discrepancy at low occupancies. For example, at the end of class the students empty the theatre very quickly, while the CO_2 sensors are still picking up high values. The opposite effect **doesn't happen as often, since the increase in CO_2** upon student arrival is much sharper than the decay during their departure.

5. CONCLUSIONS

This study has shown that it is possible to create an accurate predictive model of CO_2 for a selected space using only a few commercially available CO_2 sensors. The model performs very well within the prediction horizon that is relevant in HVAC control adjustments and thus is promising for use in the calculation of a CO_2 related performance parameter in model predictive control systems. Using the same easy and non-intrusive setup, this study has shown that it is also possible to have an estimation of the current number of occupants, although to a lower degree of accuracy, due to the fact that the transitional periods at the end of classes introduce a large degree of error. However, it is beyond the scope of the current study to investigate this issue further.

REFERENCES

- [1] Brandemuehl, M. J. and Braun, J. E. (1999) The Impact of Demand-Controlled and Economizer Ventilation Strategies on Energy Use in Buildings. *ASHRAE Transactions*, 105(2), pp. 39-50.
- [2] Clarke, J. A., Conner, S., Fujii, G., Geros, V., Jóhannesson, G., Johnstone, C. M., Karatasou, S., Kim, J., Santamouris, M. and Strachan, P. A. (2004) The role of simulation in support of Internet-based energy services. *Energy and Buildings*, 36(8), pp. 837-846.
- [3] DOE, U. S. (2011) Buildings Energy Databook, U.S. DOE [online], available: http://buildingsdatabook.eren.doe.gov/docs/DataBooks/2011_BEDB.pdf [accessed 23/11/2016].
- [4] DOE, U.S. (2016) EnergyPlus 8.6.0 <https://energyplus.net/>

- [5] Doukas, H., Patlitzianas, K. D., Iatropoulos, K. and Psarras, J. (2007) Intelligent building energy management system using rule sets. *Building and Environment*, 42(10), pp. 3562-3569.
- [6] Emmerich, S. J. and Persily, A. K. (2001) State-of-the-art review of CO2 demand controlled ventilation technology and application No. NISTIR 6729: National Institute of Standards and Technology.
- [7] Hochstein, A., Tat Leung, Y. and Denesuk, M. (2012) Optimal Control of HVAC Operations Based on Sensor Data. in *IEEE International Conference on Service Operations and Logistics and Informatics: IEEE*. pp. 123-128.
- [8] Kolokotsa, D., Pouliezios, A., Stavrakakis, G. and Lazos, C. (2009) Predictive control techniques for energy and indoor environmental quality management in buildings. *Building and Environment*, 44(9), pp. 1850-1863.
- [9] MathWorks (2000) MATLAB <https://www.mathworks.com/products/matlab/>
- [10] Pérez-Lombard, L., Ortiz, J. and Pout, C. (2008) A review on buildings energy consumption information. *Energy and Buildings*, 40(3), pp. 394-398.
- [11] Yang, J., Santamouris, M. and Lee, S. E. (2015) Review of occupancy sensing systems and occupancy modeling methodologies for the application in institutional buildings. *Energy and Buildings*, 121, pp. 344-349.

Retro-commissioning Practice and In-depth Analysis Leading to Efficiency Optimization on HVAC Systems: Case Study on A Retail Mall in China

LI Wenpeng^a, ZHANG Ye^b, Raymond YAU^c, YS SO^d, KONG Wen-ping^e, Jean QIN^f

^a School of Architecture, Tsinghua University, Mainland China, liwenpeng8701@163.com

^b School of Architecture, Tsinghua University, Mainland China, zhangye02@tsinghua.edu.cn

^c Swire Properties Ltd., Hong Kong SAR, raymondyau@swireproperties.com

^d Swire Properties Ltd., Hong Kong SAR, ysso@swireproperties.com

^e Swire Properties Ltd., Hong Kong SAR, kongwenping@soltklcd.com

^f Swire Properties Ltd., Hong Kong SAR, jeanqin@swireproperties.com

ABSTRACT

This paper presents a case study of a large-scaled retail mall air-conditioning system testing and commissioning (T&C) as well as retro-commissioning during the whole process from the construction stage to the 2-year operation stage. The system efficiency was improved significantly by cooling tower air flow distribution study, chilled water system and condensing water system balance, major equipment fine-tuning, etc.

The T&C works started with the system design review and site instruments provision survey. The sufficient and accurate measurement data are the important part to evaluate the equipment and system performance. Further in-depth analysis of the system resistance, hydraulic balance as well as the plant overall efficiency, during the retro-commissioning stage, revealed the common problems and the root causes.

The Building Management System (BMS) provides great potential and capacity for the automatic commissioning, preventive maintenance and intelligent control. Early ready of the BMS could play a very important role for the T&C. However, the BMS is always behind the schedule for the handover. Sensor soft errors are another common problem in the system, which affects the application of the control strategies.

In this paper, the challenges and the corresponding technologies of the performance tests and the improvement measures are summarized for sharing with the building industry.

Keywords: retail mall, retro-commissioning, energy saving

1. BACKGROUND

There have always been many challenges during the commissioning (Cx) of the heating, ventilation and air-conditioning (HVAC) systems. Cx has become an important process to guarantee the building energy efficiency in developed countries such as America. Quantities of research works and engineering practices at this aspect have been conducted by ASHRAE, NEBB and US General Services Administration, and completed criteria and standards have been formulated. In Japan, the performance tests for the major energy consumption components of HVAC systems are compulsory. The introduction of the methodology for HVAC system Cx started in China during the 1990s. The local research institutions began to conduct many studies and practical works in order to promote the Cx implementation. However, Cx is still at developing stage in China, to which the building industry does not pay enough attention. The Cx procedure and quality control methodology are still not well developed.

For HVAC systems operation, the annual energy consumption increases due to lack of the detailed commissioning in many projects. Moreover, the hidden problems cannot be found and solved by the operators because the numerous equipment and complicated systems are involved. Therefore, the in-depth analysis for the Cx works and the retro-commissioning (Retro-Cx) exercise are especially important.

To solve the above problems, this paper discusses the methods, experience and challenges of the Retro-Cx comprehensively from three levels, which are equipment performance commissioning, system performance commissioning and annual operation commissioning. This text also presents a case study of a large-scaled retail mall air-conditioning system in Chengdu to evaluate the practical applicability of the Retro-Cx method.

2. THREE LEVELS OF RETRO-COMMISSIONING APPROACH

Retro-Cx is a process which involves detailed diagnose and improvement for each system. It can solve the existing problems, reduce the energy consumption and enhance the performance of the whole building through the conventional but effective measures. The Retro-Cx had been classified into three levels. Figure 1 shows the key points of the Retro-Cx at each level.

As shown in Figure 1, the performance of the main equipment would be measured through Level 1 exercise of the Cx. By means of Level 2, the procedure can ensure the system performance and the hydraulic balance. Furthermore, through Level 3, the process can ensure higher efficiency for the long-term operation. For the three levels of Retro-cx, specific commissioning methods and results will be discussed in detail, with the reference to the practical cases.

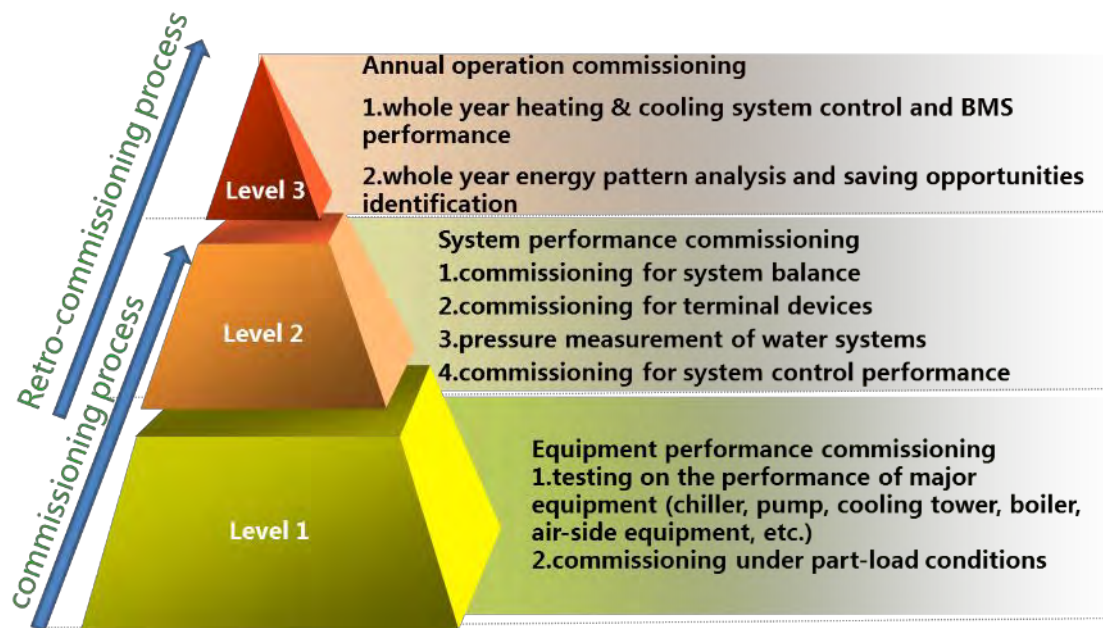

Figure 1: Commissioning and retro-commissioning

3. CASE STUDY ON A RETAIL MALL

3.1. Building Information

This case study is a large-scale retail mall in Chengdu, which is the low rise development with lanes, alleys, courtyards, streets and squares (Figure 2). The total area is about 220,000 m². The cooling source of the HVAC system comprises three centrifugal chillers and three screw chillers, with the primary variable chilled water system for cooling energy transmission. During winter and transitional seasons, free cooling plate heat exchangers will be used for the cooling. The heating source adopts five oil & gas boilers.



Figure 2: Retail mall panorama

3.2. Level 1: equipment performance commissioning

T&C Stage	Testing object	Testing Parameters and evaluation index
Equipment performance commissioning	COP of chiller, capacity and efficiency of boiler, efficiency of cooling tower	Measure the COP of the chiller at the rated flow , rated supply/return water temperature. Measure boiler gas consumption, water flow, supply/return water temperature. Evaluate the output and efficiency of the boiler. Measure the supply/return water temperature, flow of water and air, operation power of the cooling tower, etc. Evaluate the efficiency of the cooling Tower.
	Performance of pump (CHW pump, condensing water pump, hot water pump)	Measure the pump head, power under different flow rate, calculate the efficiency of the pump, make the flow-efficiency, flow-presure, flow-power curve of the pump.
	Efficiency of plate heat exchanger (hot water and free-cooling)	Measure flow rate and supply/return water temperature of plate heat exchanger, evaluate the efficiency of plate heat exchanger.
	Performance of air-side equipment (primary air unit, air handling unit, fan)	Measure air flow, air pressure, operation power, supply air temperature, evaluate the performance of air-side equipment .

Figure 3: Key points of equipment performance commissioning at Level 1

As shown, Figure 3 summarizes the Cx key points of Level 1. The case study for cooling towers of the retail mall would be presented in detail.

3.2.1. Case study of cooling towers

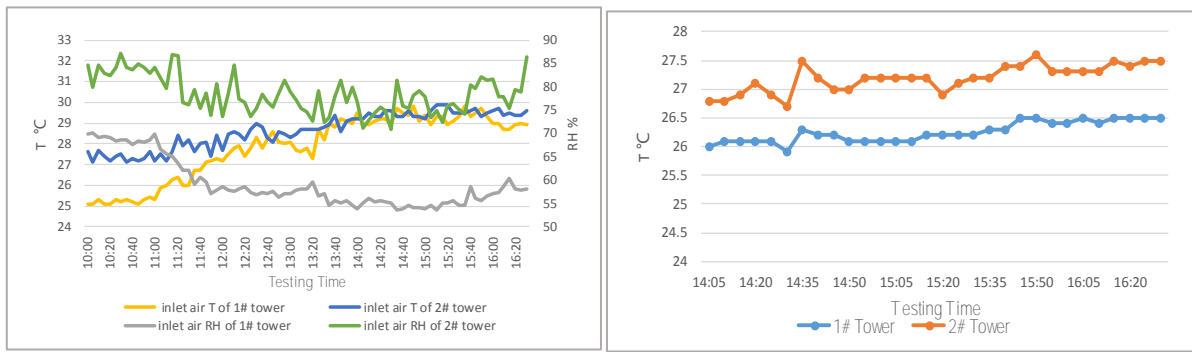

Figure 4: Inlet air parameters of the cooling towers before improvement

Figure 5: Outlet water temperature of the cooling towers before improvement

In this project, the cooling towers are located on the roof of the eight-storey hotel beside the mall. One side of the roof is enclosed with the curtain wall, while the other side is provided by the louvers. During the efficiency tests of the cooling towers, it was discovered that the big difference of the inlet air temperature and relative humidity between the two adjacent cooling towers (Figure 4).

After the site investigation, the big temperature and relative humidity difference of the inlet air for the cooling towers on the curtain wall-side and on the louver-side were found. The discharged air of the cooling towers is blocked by the roof structure. The short circuit led to the increased temperature of the cooling tower outlet water (Figure 5).

The power consumption of the chillers increases by about 3% as the temperature of the cooling tower outlet water increases by 1°C. During the peak summer, the potential risk of chiller shut-down was also seriously considered if the cooling towers' performance could not be improved.

According to the measurement data and the simulation results, the retrofitting was conducted to improvement the overall performance by adding the exhaust ducts (Figure 6). The temperature and the relative humidity of the inlet air had been measured again after the retrofitting and the comparison results showed that the inlet air parameters were much more reasonable (Figure 7).



Figure 6: Cooling tower exhaust before and after retrofitting

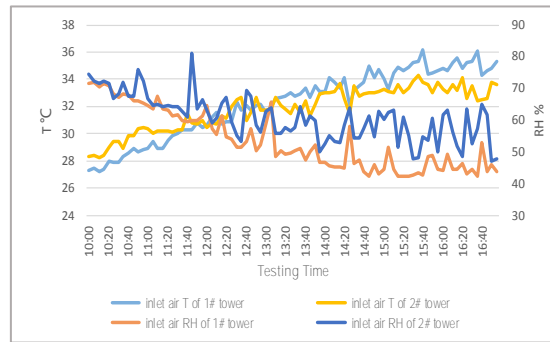

Figure 7: Inlet air parameters of the cooling towers after improvement

Site investigation on many other projects demonstrated that affected by the façade design and the location of the cooling towers, the outlet-inlet air short circuit is common. Consequently, the adequate louver areas and the better airflow design need to be addressed during the design stage. Measurements are recommended to be taken to verify the heat rejection efficiency.

3.3. Level 2: System performance commissioning

Figure 8 summarizes the key points of Level 2. The case study for chilled water system pressure drop measurement would be introduced in detail.

3.3.1. Chilled water system pressure drop measurement

The pressure drop analysis of the chilled water system is described to introduce the specific methods of system performance commissioning.

After measuring the pressure at the critical points of the chilled water system, it was discovered that the pressure drop between the chilled water pump outlet and the strainer inlet reached 0.2MPa. The excessive pressure drop indicated the potential problem(s) in chilled water system. The provisions of the chilled water system are illustrated in Figure 9.

T&C Stage	Testing object	Testing Parameters and evaluation index
System performance commissioning	Hydraulic balance testing for main equipment of the heating & cooling system	Measure the flow rate of each equipment and adjust the pumps to the reasonable flow.
	Pump commissioning under operating conditions	Adjust the group of pumps in parallel to the operating conditions by the valve adjustment or the control of VSD.
	Water system pressure measurement	Measure the pressure of the critical points of the system, discover unreasonable resistance.
	Balancing valve commissioning	Balancing all water loops by operating the balance valve.
	Air balance	Balancing the branches by adjusting the dampers provided. Each air diffuser needs to be measured to obtain the required air flow.

Figure 8: Key points of system performance commissioning at level 2

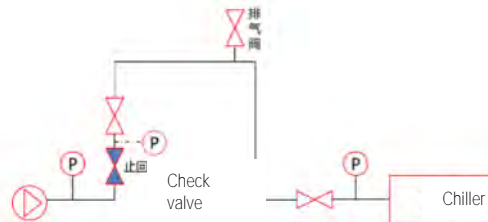

Figure 9: Pipes and fittings between chilled water pumps and chillers

There are two butterfly valves and one check valve between the two pressure gauges, one at the chilled water pump outlet and the other one at the inlet of the chiller. In order to check the problems, the air vent at the top was initially opened to discharge air. To study on the cause(s), a pressure gauge was installed after the check valve, which showed that the pressure drop of the check valve reached 0.15MPa, while the pump operating at the rated frequency (Figure 10). In this way, it was confirmed that the check valve was the reason for the unnecessary pressure drop. A check valve of new type was chosen to replace the existing valve, and the pressure drop was reduced to 0.03MPa. This could reduce the pump head by 12mH₂O (around 0.12MPa). The promising energy saving could be about 130,000 kWh/year.

At the project design stage, all the relevant parties would pay more attention to the performance parameters of the major equipment. However, the selection of valves and fittings is also important for the system efficiency. The detailed specifications for both the major equipment and the relevant fittings are strongly recommended.

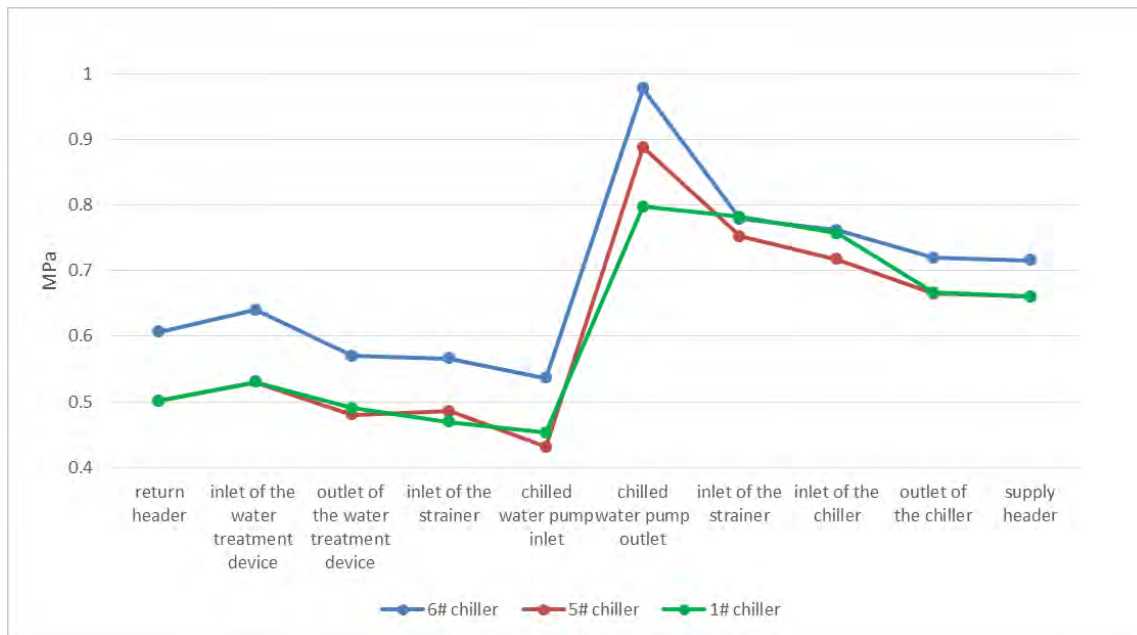

Figure 10: Pressure measurement of chilled water system

3.4. Level 3: Dynamic Operation Commissioning

Figure 11 summarizes the Cx key points of level 3, which is much more focusing on the Retro-Cx about system optimization. The case studies for plant sequencing control and BMS function for the control valves are presented.

3.4.1. Case1: Strategy optimization for plant sequencing control

In this case, the cooling source of the HVAC system comprises three large centrifugal chillers and three small screw chillers. The original control strategy was provided by the manufacturer. The strategy for adding/subtracting chillers, is based on a certain percentage of chiller load. However, the combination of the chillers with different rated capacities was not considered. The original strategy would lead the large chilled to inefficient operation and the small chillers are always switched off during the operation.

For the problem mentioned, the strategy of adding/subtracting chillers was reviewed considering the combination of large/small chillers. The criteria of adding/subtracting chillers are based on the different percentage of the chiller output, which was determined with the reference to the chiller performance curves. Table 1 demonstrates the criteria of subtracting the chillers.

According to the above criteria, if the plant is under the operation mode of two large chillers and two small chillers, once the part load percentage of any of the chillers is lower than 83% for 15 minutes (the specific period could be reset according to the different situations), the system would switch off one small chiller and shift to the next mode (2 large + 1 small).

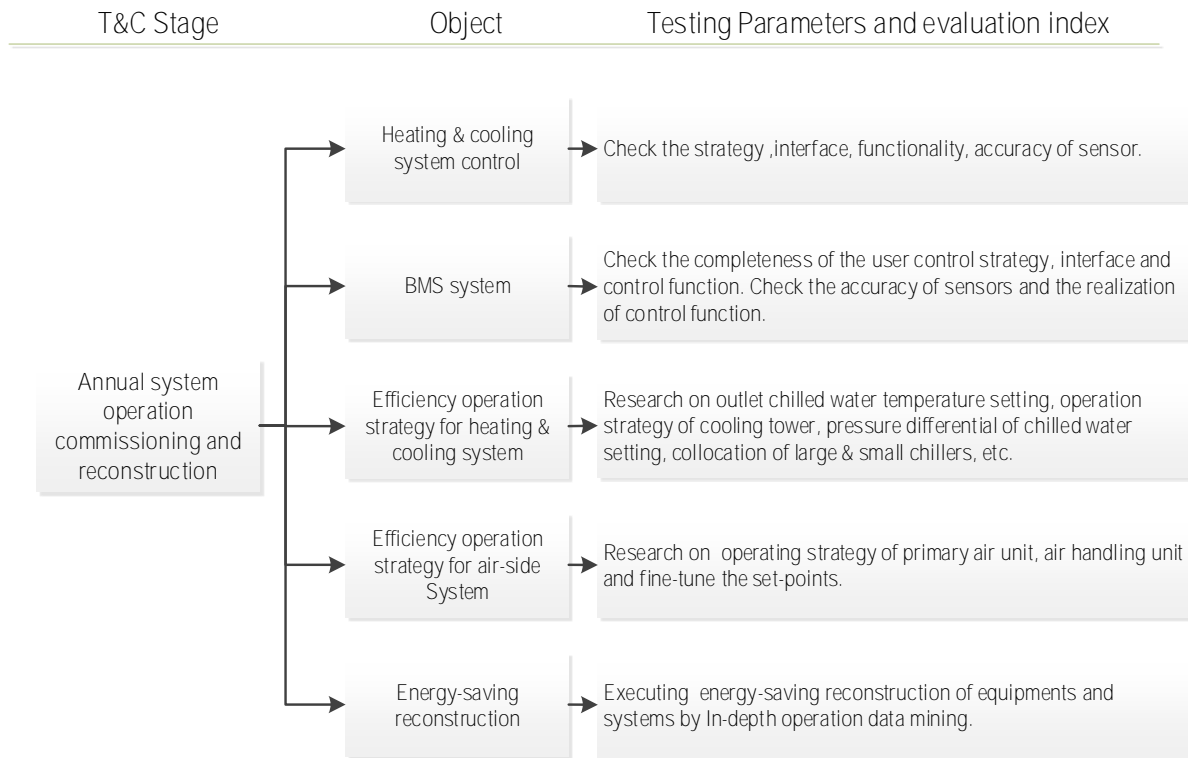

Figure 11: Key points of system dynamic operation commissioning at level 3

	→subtracting in order→									
The order of subtracting	2 large +3 small	2 large +2 small	2 large +1 small	2 large	1 large +3 small	1 large +2 small	1 large +1 small	1 large	3 small	2 small
Part load %	83%	83%	82%	80%	79%	77%	75%	53%	60%	45%

Table 1: The criteria of subtracting the chillers

Remarks:

- This table only presents the operation modes of chillers for this special project.
- Under the operation mode of large/small chillers combination, first subtract the small one, then the large one.

The manufacturers usually slightly modify the general control logics and apply for different projects. The characteristics of each project are not well studied. Thus the strategies provided by the manufacturers may not suit the practical chiller combination and cooling load patterns. More detailed requirements of the control strategy are recommended to be added into the tendering documents during the tendering stage.

3.4.2. Case 2: BMS function of control valves

The BMS control system affects the service quality for the users and the energy efficiency of the systems. Usually, the BMS control is not ready to use until more than one year operation. During this period, some of the control devices are not ready to realize the control ability.

For the retail mall, the chilled water system is serving a large number of tenants. Due to the special requirements of additional chilled water supply after the normal air-conditioning supply period (10:00 - 22:00) from some tenants, the plant is most likely under the operation from 6:30 to 1:00 of the next day. There are six branches of the chilled water system. According to the records, the tenants requesting the additional chilled water supply are served by some of the branches. However, the flow rate percentage of each branch maintains the similar level during the

normal operation period and the additional air-conditioning supply period (Figure 12). The measurement of the **chilled water supply and return difference showed that the ΔT of some branches are very small, which indicated the chilled water by-pass of those branches.**

A control valve is provided for each tenant for two functions. One is the on/off control for the chilled water supply according to the pre-set schedule. The other one is to control the supply return temperature difference of each tenant by modulating during the operation. However, the above measurement data revealed that the control ability of the valves was not properly commissioned yet. The defect caused the increase of the pumping energy consumption.

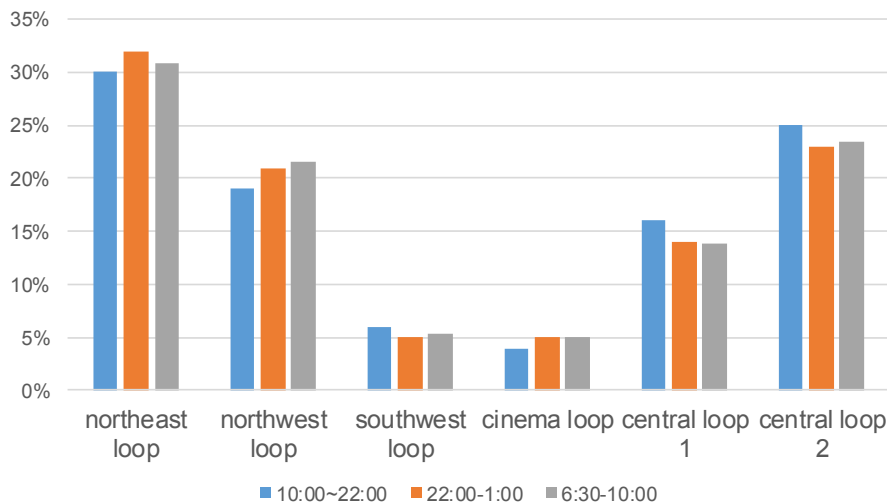

Figure 12: Flow rate percentage of each chilled water system branch in a typical day

During the process of the analysis for the control ability of the valves, it can be discovered that the BMS control functions were not ready after a certain period of operation. The systems are operated manually without some of the terminal control functions, which may lead to significant energy waste. Therefore, the reasonable plan of control system commission is necessary. The particular attention should be paid to the sensor soft errors which are always neglected by the contractors.

4. CONCLUSION

The paper introduces three main levels of the Retro-Cx in detail with the real engineering practices presented. Through the whole process, the full set of data about the equipment and system performance can be obtained, the problems can be discovered and figured out, and the equipment and system can be controlled to good operation efficiency, so that the both comfortable environment and energy conservation operation can be ensured.

The realization of the design intention needs to be guaranteed by proper Cx works assisted by the sufficient provision of the measurement devices. The Cx and Retro-Cx works for the case of the said retail mall would achieve about 900,000 kWh/year energy saving. Further control optimization is targeted to save the energy consumption of 500,000 kWh/year.

5. ACKNOWLEDGMENTS

The research works presented in this paper were under Tsinghua University – Swire Properties Joint Research Center for Building Energy Efficiency and Sustainability. The retail mall is Sino-ocean Taikoo Li, Chengdu.

REFERENCES

- [1] ASHRAE. Guideline 1.1 -2007 HVAC & R-technical Requirements for the Commissioning Process [S]. ASHRAE, 2007
- [2] US Green Building Council LEED-EB for Existing Buildings Reference Guide[S], 2005

- [3] Eakin D, Matta C. What Level of Commissioning[R]. Commissioning, US General Services Administration, 2002
- [4] Nakahara N, et al. Study on On-going Commissioning Process for Actual HVAC System of an Existing Building, Part 1: On-going Commissioning Outline and Effort for HVAC Optimal Operation[C]. II Proceedings of SHASE Academic Lecture Meeting. Japan, 2004:807810
- [5] Wang Fulin, Yoshida H, Goto K. Model-based Commissioning Method for Fin-plate Energy Recovery Unit in Building Ventilation System[C]//Proceedings: Indoor Air,2005:1132-1137
- [6] Qingpeng Wei, Commissioning in Buildings and Systems in China for Energy Efficiency[C]//Proceedings of ICEBO, 2014 [7] Xia Chunhai, et al. Application of Commissioning to a VAV System Renovation Project[J]. HV&AC, 2006, 36(11), 92-98
- [7] Cao Yong, et al. Progress and Status in Research of Commissioning Technology at Home and Abroad[J]. HV&AC,2013, 43(4),18-28
- [8] Aleisha Khan, Amanda Potter. Retro-commissioning of Two Long-Term Care Facilities in California, ACEEE Summer Study 2002
- [9] ZHENG Hui-ming, ZOU Lei. Discussion on Influence of Evaporating Temperature and Condensing Temperature on Refrigeration Efficiency[J].PowerGeneration & Air Condition, 2013, 34(150), 32-33

Study of Chiller Part Load Values for Hong Kong and Subtropical Climate

LI Tao^a, Christy CHOW^b, LEUNG Wai-ho^c, Alvin LO^d, Raymond YAU^e

^a Arup, Hong Kong SAR, tao.li@arup.com

^b Arup, Hong Kong SAR, christy.chow@arup.com

^c Arup, Hong Kong SAR, wai-ho.leung@arup.com

^d Arup, Hong Kong SAR, alvin.lo@arup.com

^e Swire Properties Limited, Hong Kong SAR, raymondyau@swireproperties.com

ABSTRACT

16% of total energy or 30% of total electricity was consumed by space conditioning, primarily cooling, in Hong Kong. **Hence, chiller efficiency is key to achieve Hong Kong's low carbon vision. Hong Kong's Building Energy Code** has regulated chiller efficiency through rated COP. However, chillers rarely operate under rated condition in real case operation. IPLV and NPLV were first introduced in ARI 550/590-98 as a numerical rating tool to create a metric of part-load/ reduced ambient efficiency to provide a useful means for regulatory bodies to specify minimum chiller efficiency levels and Engineering firms to compare chillers of like technology. However, IPLV/NPLV formula were derived primarily based on US climate and US building energy code, and ideally for single chiller plant use only.

The objective of this paper is to describe the derivation of a preliminary Hong Kong (or alike cities) specific PLV equitation through several projects undertook by our building sustainability group in Hong Kong. The process involves energy simulation as well as real building data analysis.

Keywords: chiller selection, COP, EER, IPLV, NPLV, part load value, building energy code, building energy, efficiency

1. INTRODUCTION

The HVAC industry has struggled to find easier ways to quickly evaluate the performance of central chiller plants. In addition, the increase use of variable speed drive chillers and the increase in energy cost has resulted in an escalating pressure on the development of accurate chiller energy evaluation tool. A simple and accurate evaluation method to analyse chiller plant performance will accelerate the roll out of high performance chillers. IPLV (integrated part load value) as a substitute for executing a complete hour-by-hour modelling analysis were created.

PLV limitations

IPLV was created by the Air Conditioning, Heating, and Refrigeration Institute (AHRI) and frequently promoted by manufacturers as the method to analyse chiller performance. However, AHRI acknowledged that IPLV and NPLV (non-standard part load value) **does not accurately represent a chiller plant's operating characteristics.**

The following limitations of the standard IPLV is listed below:

- The climate data of which IPLV is derived is an weighted average climate of 29 cities across the United States
- IPLV evaluates a single chiller application only. Appendix D, D2.1 of AHRI Standard **550/590 states: "The [IPLV] equation was derived to provide a representation of the average part-load efficiency for a single chiller only." It is not applicable for multiple-chiller installations**

Despite that a non-standard PLV (NPLV) was also introduced to allow user to change test conditions, chiller plant design practitioners in Hong Kong still rely heavily on rated chiller COP for design and specification due to the limitations listed above.

Thus, the aim of this paper is to adjust the IPLV using conditions specific to Hong Kong and to explore the possibilities of using an improved single number chiller performance indicator to improve the accuracy of chiller energy performance evaluation.

$$IPLV = \frac{1}{\frac{0.01}{A} + \frac{0.42}{B} + \frac{0.45}{C} + \frac{0.12}{D}}$$

A = kW/ton_R@ 100% Load and 85°F ECWT or 95°F EDB
B = kW/ton_R@ 75% Load and 75°F ECWT or 80°F EDB
C = kW/ton_R@ 50% Load and 65°F ECWT or 65°F EDB
D = kW/ton_R@ 25% Load and 65°F ECWT or 55°F EDB

Figure 1: IPLV equation

2. PLV EQUATIONS FOR HONG KONG

2.1 Standard and guidelines

Due to the limitations listed in earlier, design standards and guidelines in Hong Kong have never adopted IPLV. Hong Kong Code of Practice for Energy Efficiency of Building Services Installations (BEC) used the Rated COP of chillers to regulate chiller performance in the 2007 version and 2012 version. In 2015, BEC has introduced an additional control points for VSD chillers which regulate the chiller performance at 75% load condition and 24 °C ECWT (Entering Condenser Water Temperature). This is a right step forward but 24 °C ECWT is considered to be too low for Hong Kong climate.

2.2 Hot and humid climate

IPLV were derived based on the weighted weather average of 29 cities across the U.S.A, specifically targeted because they represented areas where 80% of all chiller sales occurred over a 25 year period (1967-1992).

Hong Kong is located in the hot and humid subtropical climate with high wet bulb temperature. Figure2 shows that the ECWT of chillers of a real office building is above 24 °C in more than 85% of time. On the other hand, based on the standard IPLV conditions, 3 out of four reporting points were below 24 °C. As the result, designer using IPLV to evaluate chiller performance in Hong Kong can be misled. Subsequent studies will show that the optimised reporting condition for Hong Kong chillers are 18-23.8 °C, 24.6-27.2 °C, 29.6-30°C, 30.8-32.3 °C, for 25%, 50%, 75% and 94% respectively.

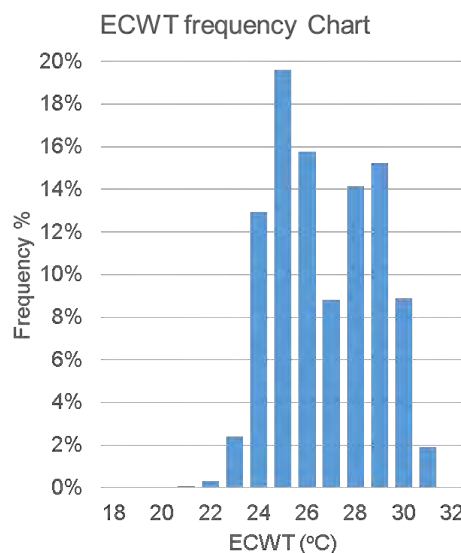

Figure 2: Entering condensing water temperature of chillers measured in an office building in Hong Kong

Apart from the reporting conditions, the hot and humid climate also affect the load profile and operation weightings of chiller plant. Figure 3 shows that chiller plant in Hong Kong climate could have a very different operation weightings compare to the standard IPLV.

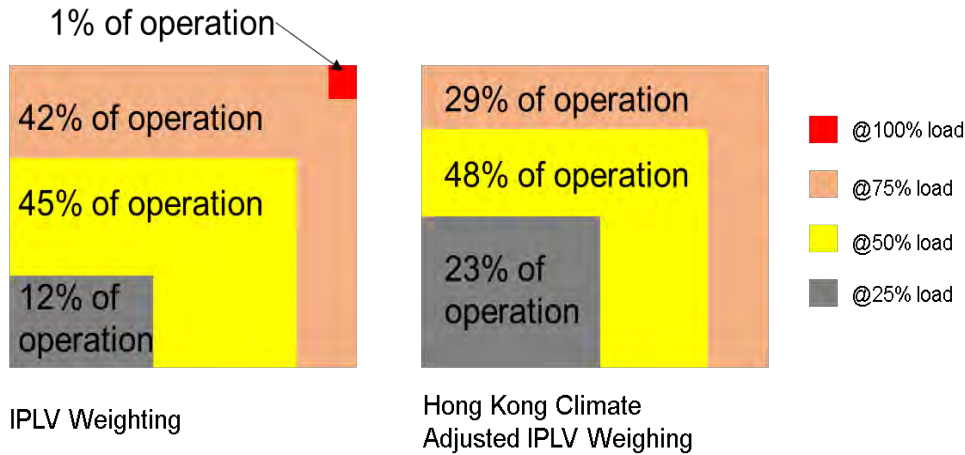

Figure 3: Operation weightings of chiller plant

2.3 Multiple chiller plant

IPLV is only suitable for evaluating a single chiller system. AHRI Standard 550/590 states that “The IPLV equation was derived to provide a representation of the average part-load efficiency for a single chiller only.” On the other hand, it is estimated that almost all central water-cooled chiller plants in Hong Kong are multiple-chiller installations, and most of them have 2 to 5 chillers. The number of chillers has a significant impact in the weightings. The previous section showed that chiller rarely operate in 100% loading conditions and it’s often argued that chillers simply do not operate at 100% load under good control, the performance at 100% load is therefore not very useful. A 94% part load condition is included to reflect the chillers performance for chiller perform above the 75% load range.

Figure 4 shows the chiller PLV weighting and average ECWT temperature for plants with different number of chillers. The increasing number of chillers result in a decreasing trend in weightings under 25% load condition and an increasing trend under 94% load condition.

According to the figure, Chiller Plant with more than 3 chillers shows that the chiller performance at 75% load is the most important factor for evaluating chiller performance in Hong Kong, this is in line with BEC 2015’s requirement. However, this figure showed that the reporting condition should be at ECWT of 29.4-30 °C instead of 24 °C.

Our experience suggests that the PLV table for 4 chillers above representative most cases for buildings in Hong Kong. However, further study looking into the most common number of chillers in a chiller plant in Hong Kong could be conducted to construct a more representative weighting equation.

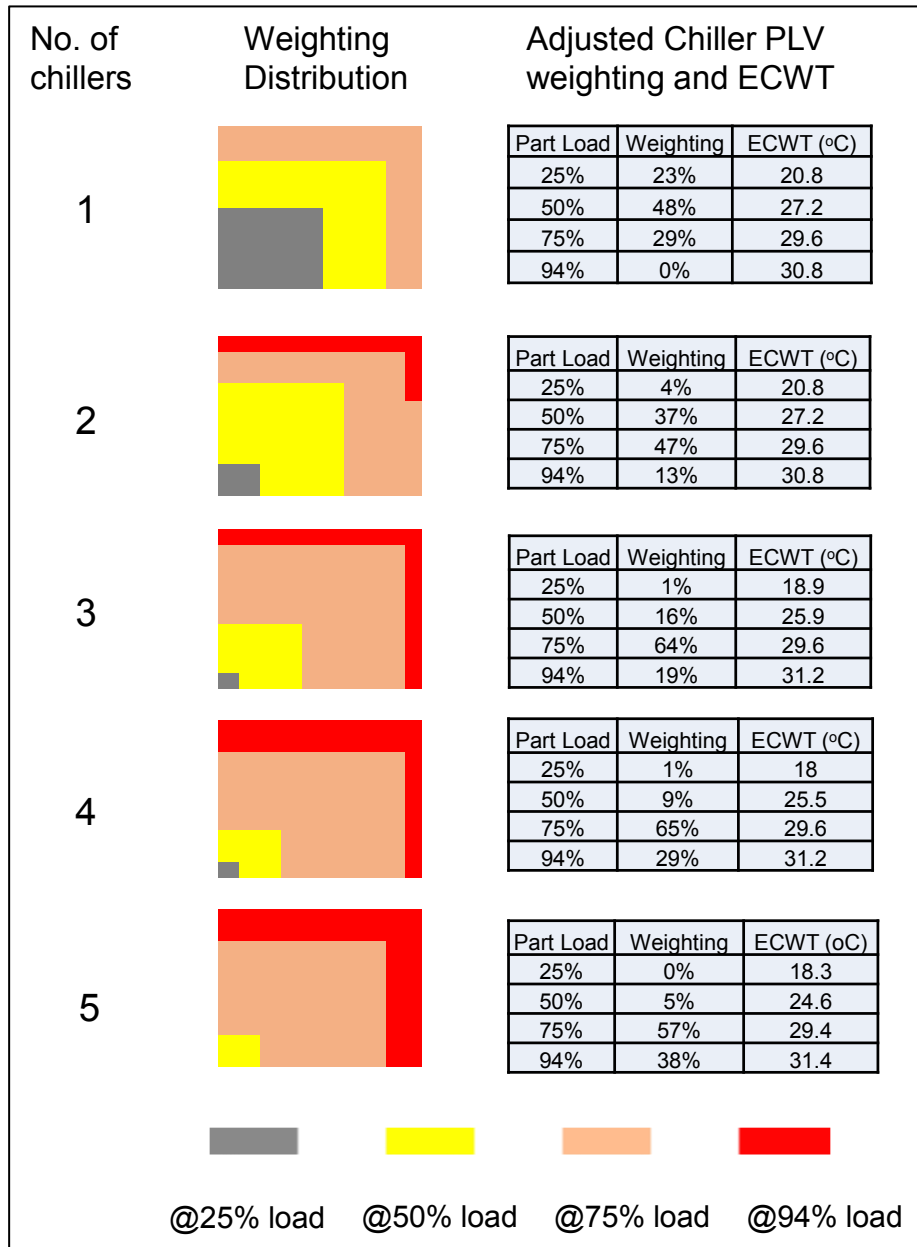

Figure 4: No. of Chillers and PLV weighting for an Office building in Hong Kong (result obtained through simulation using energy plus)

2.4 Office and multi-usage composite buildings

Apart from climate factors and number of chillers, the building usage also plays an important role. Among buildings with central cooling plant, a majority of them are office buildings and composite buildings.

Figure 5 describes the chiller operation weightings for an office building and a composite building (54% office, 31% retail, 15% others). It shows that for the same no. of chillers, composite building's chillers tend to operate in a lower range of the part load. This is due to the higher diversity factor of the composite building. The higher diversity factor is caused by the diverse load pattern from different building usage and it can often lead to an over sizing of chiller plant.

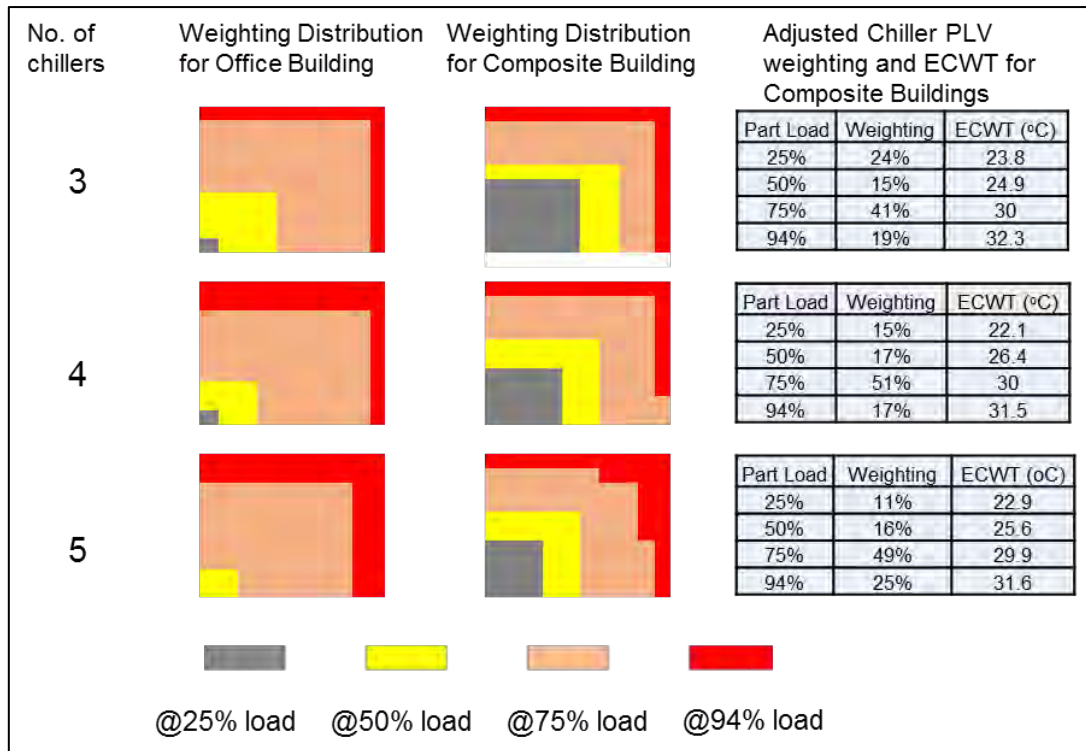

Figure 5: Office vs composite buildings

In these paper, office and composite buildings are studied to illustrate the different chiller part load weightings, however, more study could be conducted to cover more building types such as pure retail buildings and hotels.

2.5 PLV equations for Hong Kong

Despite that using a single equation to evaluate chiller performances has many shortcomings, the use of a single equation PLV is desired due to the accelerating pressure to increase design productivity without sacrificing the accuracy of energy performance evaluation.

Therefore, based on the study outlined above, preliminary PLV equations adjusted to represent Hong Kong buildings could be derived. The following equations are proposed:

Hong Kong PLV for Office Buildings:

$$HKPLV = \frac{1}{\frac{19\%}{A} + \frac{64\%}{B} + \frac{16\%}{C} + \frac{1\%}{D}}$$

Where: A = COP @ 94% load and 31.2 °C ECWT

B = COP @ 75% load and 29.6 °C ECWT

C = COP @ 50% load and 25.9 °C ECWT

D = COP @ 25% load and 18.9 °C ECWT

This equation is based on a three-equal-chiller water cooled plant configuration. The decision to use this configuration is based on our database and design experiences.

Hong Kong PLV for Composite Buildings:

$$HKPLV = \frac{1}{\frac{17\%}{A} + \frac{51\%}{B} + \frac{17\%}{C} + \frac{15\%}{D}}$$

Where: A = COP @ 94% load and 31.5 °C ECWT

B = COP @ 75% load and 30 °C ECWT

C = COP @ 50% load and 26.4 °C ECWT

D = COP @ 25% load and 22.1 °C ECWT

This equation is based on a four-equal-chiller water cooled plant configuration. The decision to use this configuration is based on our database and design experiences.

These equations are not intended to produce the most precious chiller performance results, but to provide better benchmarks than the rated COP commonly used in Hong Kong HVAC industry.

3. WAY FORWARD

Due to the limitation of our database and experiences, further review of different building types, combinations and building scale could be evaluated to further improve the PLV equation. The PLV equations outlined in this paper could be used as a starting point for establishing a Hong Kong specific PLV equation to evaluate and compare chiller efficiency in a cost effective manner. The intention of this paper is to inspire similar investigations into **Hong Kong's or other similar built environments' HVAC design practice to promote energy efficient design in a large scale.**

Other than a single equation outlined in the section above, advanced chiller performance study could be conducted in order to produce a near optimised design solution. Designer should follow the 8 steps listed in (Taylor, 2012) to conduct any chiller design if resources allowed.

In our group, energy modelling and in-house developed chiller annual COP calculator are used to determine the performance for specific building design and operation to ensure the most energy efficient chillers will be selected.

ACKNOWLEDGMENT

This research is inspired by the chiller design study conducted during the design of One Taikoo Place and supported by Swire Properties, especially its Technical Services and Sustainability Department and Projects Department. The authors wish to thank them for their supports and assistances in this project.

REFERENCES

- [1] ANSI/AHR, Performance Rating Of Water-Chilling and Heat Pump Water-Heating Packages Using the Vapor Compression Cycle, 2011
- [2] Hong Kong EMSD, Code of Practice for Energy Efficiency of Building Services Installations, 2015
- [3] Steven T. Taylor, Optimising Design & Control of Chilled Water Plants, ASHREA Journal July 2011
- [4] W. Ryan Geister, Mike Thompson, A Closer Look At Chiller Ratings, ASHREA Journal, December 2009

HVAC System Design and Operation Performance of a Low-Carbon High-Rise Tenant Office Building Located in Tokyo

Yuichi TAKEMASA^a, Eikichi ONO^b, Shinichi HIROMOTO^c, Jun OWADA^d, Hideharu KOMODA^e, Masaya HIRAOKA^f

^a *Kajima Technical Research Institute Singapore, Singapore, y.takemasa@kajima.com.sg*

^b *Kajima Technical Research Institute, Japan, onoe@kajima.com*

^c *Kajima Design, Kajima Corporation, Japan, hiromoto@kajima.com*

^d *Kajima Design, Kajima Corporation, Japan, ohwada@kajima.com*

^e *Kajima Design, Kajima Corporation, Japan, komodah@kajima.com*

^f *Kajima Design, Kajima Corporation, Japan, hiraokam@kajima.com*

ABSTRACT

Recently, redevelopment projects which arrange densely buildings with large floor area are moving ahead in Tokyo. Tenant office business particularly requires not only high-standard office space but also resilient and environmentally friendly design. A building described in this paper is a 30-story complex building composed of tenant office, rented housing and retail, and designed for realization of safety, functionality and environmental performance that are required of next-generation high-rise buildings. In facade design, building envelope heat load was reduced by 35% compared to office baseline using precast outer frame structure with ultra-high strength concrete and original high-performance glazing. In heat source system design, high-efficiency inverter centrifugal chillers and temperature-stratified-type thermal storage tanks with variable capacity were introduced and the high efficiency was verified in actual operation around the year. Air-conditioning system with separation of sensible and latent heat was selected and unique control, which stops VAV air-handling unit automatically in low load operation, was implemented. By these energy-saving technologies, annual primary energy consumption for the whole building was 1,266 MJ/m² and reduced by 40% compared to the averaged actual performance value for office buildings in Tokyo. An example of HVAC system design in high-rise tenant office buildings can be produced for actual practice of low-carbon when high functionality and redundancy are required in condition of uncertain users.

Keywords: energy saving, high-rise tenant office building, HVAC system design

1. INTRODUCTION

Japanese government provides grant-in-aid for promoting energy saving, utilization of renewable energy and smart community, and promotes nation building for low carbon, safety and security (METI, 2016). Recently, redevelopment projects that arrange densely buildings with large floor area are moving ahead in Tokyo, Japan. Tenant office business particularly requires not only high-standard office space but also resilient and environmentally friendly design. For HVAC system design of tenant office buildings, redundancy is required because it is designed when tenants are not determined and human behaviour of users is uncertain. A building described in this paper is a 30-story complex building composed of tenant office, rented housing and retail. We received the grant-in-aid for promoting low-carbon building from MLIT (The Ministry of Land, Infrastructure, Transport and Tourism) and aimed for realization of safety, functionality and environmental performance which are required of next-generation high-rise buildings. This paper describes the outlines of the systems employed in this building and analyses the measured performance of these systems in detail.

2. OVERVIEW OF BUILDING

The building discussed in this paper is a 30-story high-rise building complex containing lease offices, lease apartments and retail stores. It has been designed to provide the safety, functionality and environmental performance needed for a next-generation ultra-high rise building. The building has a total floor area of 47,982 m² for offices and 5,795 m² for apartments. Figure 1 shows an exterior view of the building. The facade plan integrates the building and equipment functions to achieve a simple exterior that offers high heat insulating performance. The facade is made up of a precast outer frame structure (Figure 2) with an eaves effect that can be expected to cut annual direct solar radiation by 75%, and proprietary ultra-high performance Low-e glazing that achieves a solar shading coefficient of 0.29 for the glass alone. Combining this facade with automatically controlled blinds results in a 35% reduction in outer skin load as compared to the standard value for offices, and this system has been confirmed to provide performance equal to or better than airflow windows. Cold draft intake ports have also been

provided at the base of the windows to improve the upper and lower temperature distribution near the window in winter (Figure 3).



Figure 1: Exterior view of the building

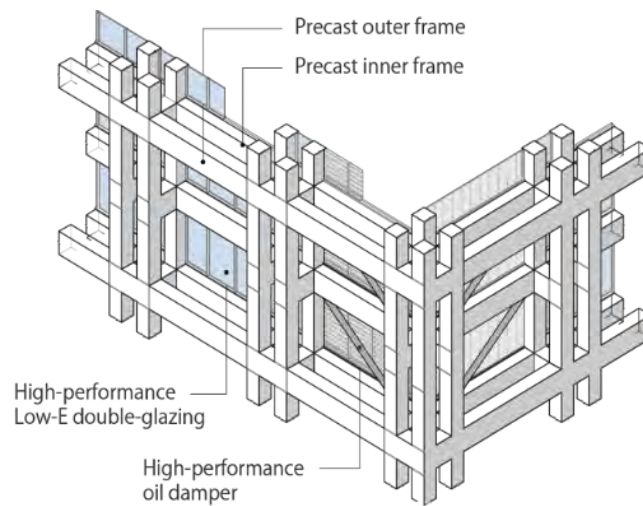

Figure 2: Precast outer frame structure

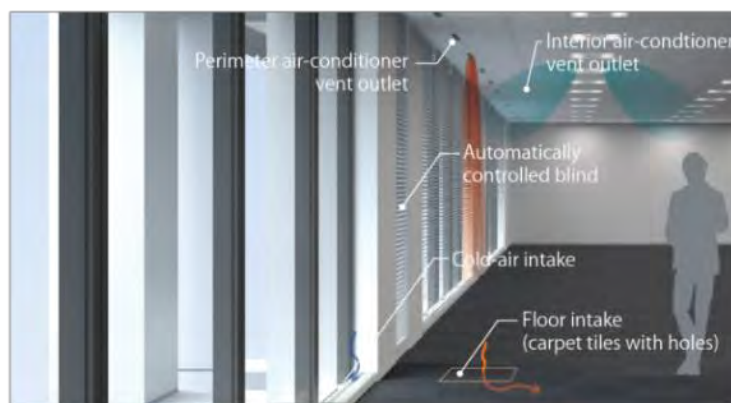

Figure 3: Perimeter design in office

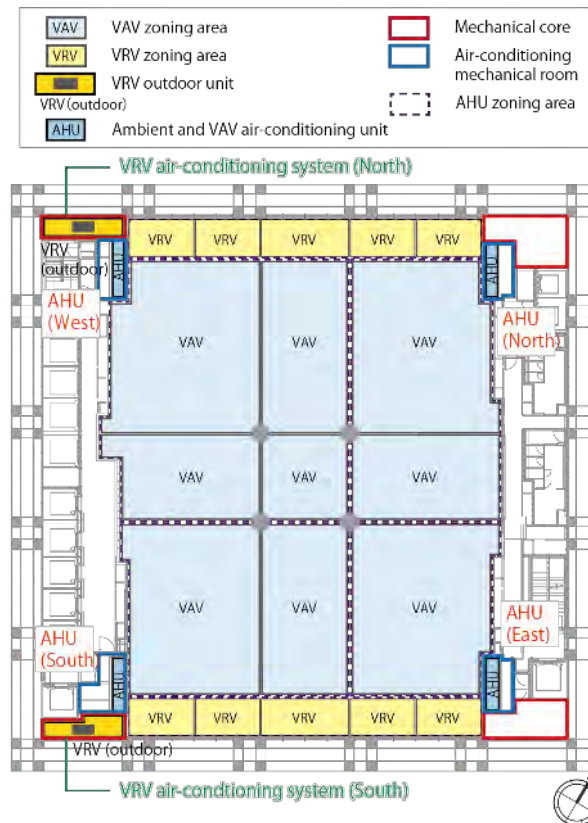

Figure 4: Zoning of air conditioning

3. OVERVIEW OF AIR-CONDITIONING SYSTEM

A single duct variable air volume (VAV) air-handling system has been adopted as the basic air-handling system for the building, out of consideration for the need to track changes in partitioning of the tenant building. Up to four tenants per standard floor can be accommodated, and operation and control can be designed in accordance with partitioning needs, with nine zones for the interior VAV and 10 zones for the indoor unit zoning for the perimeter individual distributed type HP (Heat pump) variable refrigerant flow (VRF) air conditioning units (Figure 4). In addition, an active effort has been made to reduce transport power consumption through integrated control of air-handling system units. The air-handling systems on standard floors are a combination of centralized and independent systems, with ambient outdoor air-handling units, VAV air-handling units and a VRF air conditioning system for the perimeter. The ambient outdoor air-handling units bring in fresh air from outside and regulate the humidity environment. The VAV air-handling units are treated as task air-handling units that track the increase and decrease in internally generated heat and regulate the room temperature. The VRF air-conditioning system in the perimeter controls the thermal load near windows and is designed to accommodate room partitioning. Since the nature of tenant use has not yet been determined, this air-handling system is designed to enable high-efficiency operation under a variety of conditions. This is accomplished by switching the three air-handling systems to the following modes in accordance with the load status and outside air conditions (Figure 5).

- High-load mode (cooling)

This is the so-called normal rated cooling operation in which the ambient outdoor air-handling units, VAV air-handling units and perimeter VRF air conditioning system are operated simultaneously.

- Medium-load mode (cooling)

When the cooling load decreases, the ambient outdoor air-handling units are operated on a priority basis to handle the cooling load. The VAV air-handling units are switched to start-stop control status (Suzuki et al., 2012) when tracking is determined to be unnecessary. The perimeter VRF air-conditioning system is controlled when the cooling medium evaporation temperature rises in response to the load.

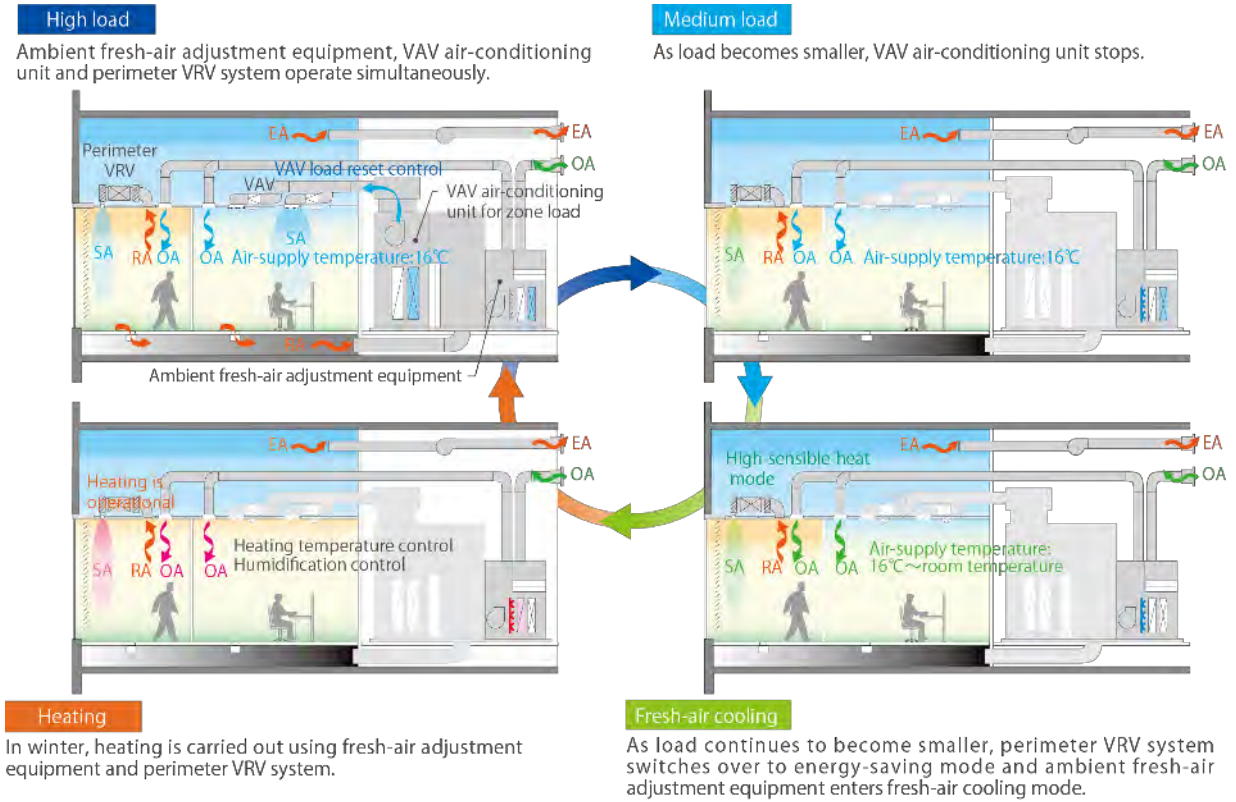

Figure 5: Four operation modes of air-conditioning system

- Outside air cooling mode:

When the load decreases further, the VAV air-handling units remain off and the ambient outdoor air-handling units switch to outside air cooling mode.

- Heating mode:

Heating is conducted using the ambient outdoor air-handling units and perimeter VRF air-conditioning system only.

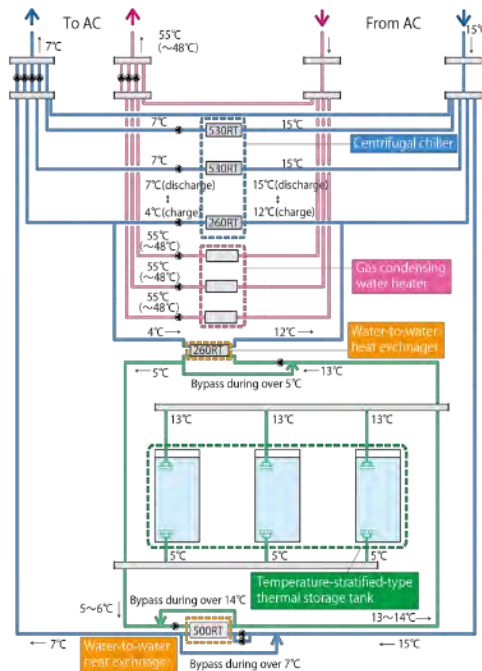

Figure 6 System diagram of heat source

4. OVERVIEW OF HEAT SOURCE SYSTEM

High-efficiency heat source equipment makes a major contribution to reducing the overall energy consumption of the building. The chilled water is provided by two high-efficiency inverter centrifugal 530 RT chillers and one 260 RT chiller (for heat storage), and the skeleton pit houses a variable capacity temperature-stratified-type thermal storage tank (2000 RT/h) (tank capacity 800 m³, inlet/outlet temperature differential 8°C). The heating water is provided directly by three latent-heat-recovery-type water heaters (655 kW x 3) and the thermal storage tank is not used. Figure 6 shows a system diagram of the heat source. In addition to the stand-alone heat source units, the temperature-stratified-type thermal storage tank was split into three tanks to enable control of the number of storage tanks being operated according to the daily cumulative load for the season, in order to increase the overall efficiency of the entire heat source system. In addition, the chilled water inlet and outlet temperature differential **was increased ($\Delta t = 8^{\circ}\text{C}$)**, and variable flow control was used for all cooling water and heating and chilled water pumps. In this way, the heat source system also provides high-efficiency operation under a variety of load conditions. In order to equalize the power load during cooling in summer, top priority is given to the discharge operation of the thermal storage tank during the 1:00 - 4:00 p. m. time period. During the daytime in winter when not only the heating load but also the cooling load arises, the chilled water is generally provided exclusively by means of discharge operation.

5. ASSESSMENT OF THERMAL ENVIRONMENT NEAR WINDOWS

Measurements were made to assess the thermal environment of the area near the windows in the 3rd floor (oriented toward the southeast) in summer and winter.

Figure 7 shows the results of measurements on a typical summer day (September 7, 2012). The room temperature was approximately 29°C before air conditioning was initiated. When air conditioning was initiated at 8:30 a.m., the temperature began to drop, and at around 10:00 a.m. it was 25 - 26°C. At around 1:00 p.m. and thereafter, the temperature was controlled to around 26°C. During the daytime, even the maximum globe temperature was around 27°C (an increase from room temperature of 1.1°C at most). Thus the radiant thermal environment was good, with not much sensation of warmth coming from the window. The predicted mean vote (PMV) in perimeter areas was held to around 0.4 - 0.6 when air conditioning was conducted. The combination of the reduction in direct solar radiation during the day by the outer frame and the high shading performance of the window glazing was confirmed to create a good indoor thermal environment near the window.

Figure 8 shows the results of measurements on a typical winter day (February 13, 2013). The room temperature was approximately 15°C before air conditioning was initiated. When air conditioning was initiated at 8:00 a.m., the temperature began to rise, and it was 22°C at around 9:00 a.m. Thereafter the temperature was maintained at around 22 - 25°C. The globe temperature was approximately the same as the room temperature. The PMV was held to around 0.3 - -0.5 during the time period when air conditioning was conducted, forming a good indoor thermal environment.

6. VERIFICATION OF START-STOP CONTROL

When the system determines that the air-conditioning load of the VAV air-handling units is low, start-stop control is initiated to stop the intake fan for a certain period of time to reduce fan power consumption. Normally, air-handling units continue to operate the fan even when the load is low. As this increases transport power consumption and reduces efficiency during low-load operation, there was thought to be room for improvement. The specific control logic is that the fan is stopped when the cold water valve of the target VAV air-handling unit continues to be open 40% or less for 10 minutes and the VAV control mode is not cooling request mode. The fan is restarted when, after a period of 30 minutes has elapsed since start-stop control was initiated, the average divergence between the set temperature and the measured temperature is 2°C or more.

Figure 9 shows the measurement data of the AHU that is installed in the south area of the 20th floor on a typical day (October 15, 2015) in medium-load mode during the core time (8:30 a.m. - 6:30 p.m.). The AHU was in start-stop control status up until 1:00 p.m., and subsequently the cold water valve opening was controlled to 40% or greater, so the system was operated continuously. In intermediate seasons, the VAV units are stopped for a long

period of time, so a certain degree of improvement in transport efficiency can be anticipated. There was concern that start-stop control might deteriorate the thermal environment, but the measurement data revealed that there was no change in room temperature regardless of whether start-stop control was conducted.

A simulation of cooling operation was conducted for the AHU in the south area of the 20th floor for six months, from April through September, and this simulation confirmed the effectiveness of start-stop control in reducing energy consumption. The simulation tool was a proprietary Energy Network Simulation Tool (ENe-ST) (Mihara et al., 2015). The ENe-ST is based on the MATLAB programming environment and is used to perform energy and control simulations that combine models for air-handling, water heater, electricity and renewable energy equipment (Figure 10). Figure 11 shows the results of calculations of fan power derived from the simulations. There was a total reduction of 35.8% in energy consumption for the six-month period. Start-stop control was performed for 70 - 150 hours each month, representing 28.0% of the cumulative air-conditioning time for the six-month period.

Based on these results, it was confirmed that start-stop control was effective in reducing energy consumption when the thermal load is low.

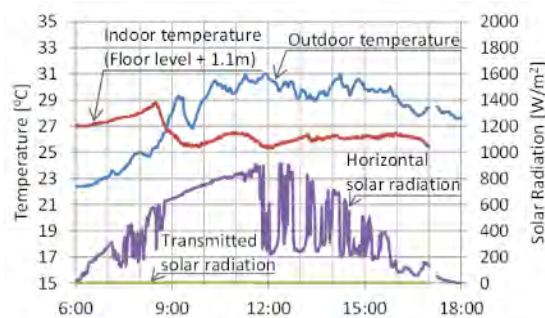

Figure 7: Measurement results in summer

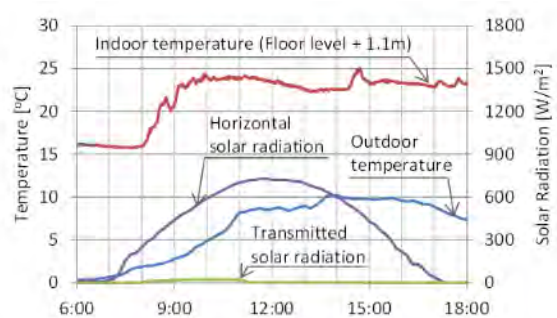

Figure 8: Measurement results in winter

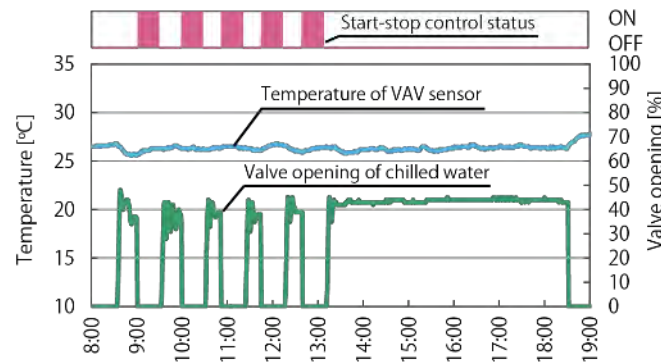

Figure 9: Status of start-stop control

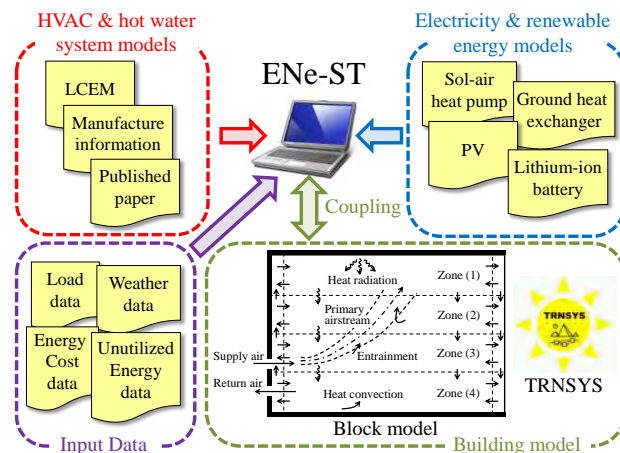

Figure 10: Outline of ENe-ST

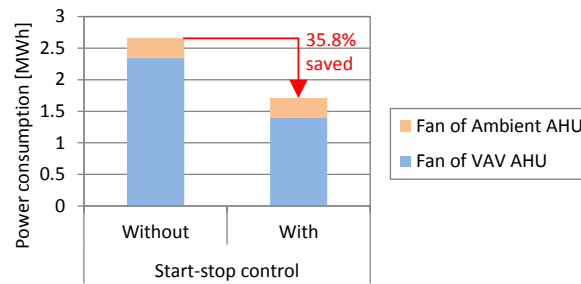

Figure 11: Energy saving by start-stop control

7. RESULTS OF HEAT SOURCE SYSTEM OPERATION

Figure 12 shows the quantity of heat produced by the hot and cold heat sources in FY 2014. Figure 13 shows the results of an assessment of the primary energy consumption for each month. The quantity of cold produced each year was 8.25 TJ/year, and the quantity of heat produced was 5.00 TJ/year. The primary energy consumption for cold and heat was 4.39 TJ/year and 6.51 TJ/year, respectively. Cold energy consumption was less than heat energy consumption despite the fact that more cold than heat was produced. This is because the coefficient of performance (COP) for the cold source system is maintained at an extremely high level. Figure 14 shows the system COP for the cold water heat source, the system COP for the hot water heat source and the COP for the heat source systems overall for primary energy each month. The annual average system COP for the cold source is 1.59, while in summer the value is high at 1.6 - 1.7. In winter, the value is approximately 1.0 - 1.3 due to the low load. The annual average COP for the hot water system was 0.78, while the annual average system COP for heat sources overall was 1.10. The annual cumulative transport efficiency (Water Transportation Factor or WTF) for the secondary pump was high at 135 for the cold water system and 115 for the hot water system. Figure 15 shows a graph of the thermal storage tank efficiency (= heat discharge / heat storage), assessed annually and monthly. Annual performance of 93.6% was achieved through appropriate operation of the thermal storage tanks (which had been split into three tanks), temperature control of the surroundings of the thermal storage tank and so on. A comparison of the heat quantity with Figure 12 reveals that, even at the height of summer, 30% or more of the produced heat and cold was provided by the thermal storage tanks.

8. ASSESSMENT OF ANNUAL ENERGY CONSUMPTION

As the building is a combined office and apartment complex, the sections for apartment use needed to be excluded in order to make a comparative assessment of the basic units for energy consumption as an office building. Figure 16 shows the primary energy consumption and percentage for each type of use for FY 2014. The average value for primary energy consumption for office buildings in Japan with a floor area of 10,000 m² or greater is 2,067 MJ/m² per year. In contrast, the value for this building for FY 2014 was 1,266 MJ/m² per year, demonstrating that a high level of overall energy-saving performance had been achieved despite the fact that the building is a high-rise tenant building. In addition, the total percentage of energy consumption for lighting, electrical outlets and air conditioning for standard office floors was 49%. Furthermore, based on the FY 2014 results, estimates were performed for the case in which the grid ceiling lights in the offices on standard floors were changed from the current Hf fluorescent lights to the LED lights coming into general use (Figure 17). When the building was planned, fluorescent lights were the type of lighting most commonly used, and brightness sensors + movement sensors are used for dimming control in this building. When the effect of switching the lighting in offices to LEDs was calculated based on the same average illumination as the current operation (700 lux), the result was 1,136 MJ/m² per year, meaning that a further reduction in primary energy consumption of around 6% could be anticipated.

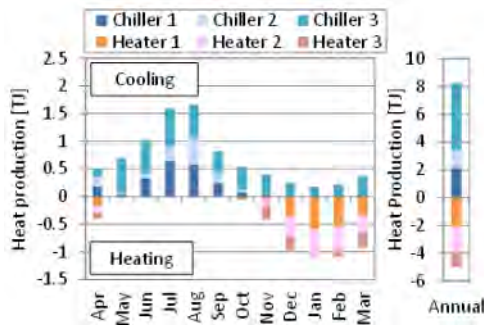

Figure 12: Heat Production of Heat Source

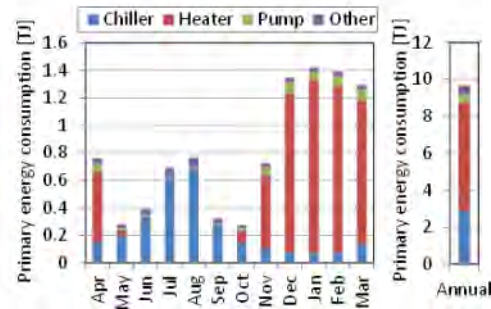

Figure 13: Energy Consumption of Heat Source

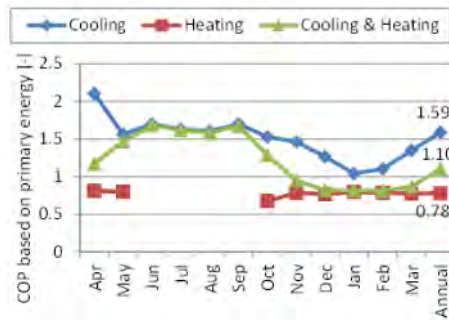

Figure 14: COP of Heat Source System

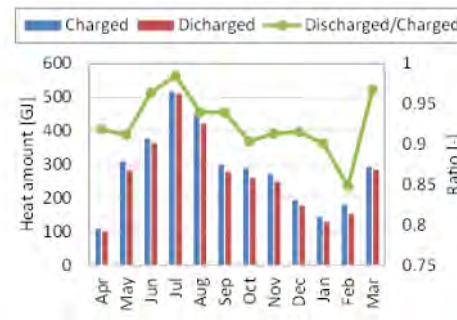

Figure 15: Charged and Discharged Heat

9. CONCLUSION

This paper presents an example of an air-conditioning system plan that takes into account the uncertain use situation of tenant users in a high-rise tenant office building. In the facade plan, a precast outer frame structure using ultra-high strength concrete and original ultra-high performance glazing achieve a 35% reduction in outer skin load as compared to the standard office buildings in Japan. The measurements confirmed that a comfortable thermal environment has been achieved in both summer and winter. The heat source system, which uses high-efficiency inverter centrifugal chillers and variable capacity temperature-stratified-type thermal storage tanks, was confirmed to have achieved a high system COP throughout the year. The air-conditioning system uses a stand-alone tank configuration, and control system has been introduced to stop the operation of the VAV air-handling units when the load is low, reducing transport power consumption. The use of such energy-saving technologies achieved a value of 1,266 MJ/(m²·year) for the annual primary energy consumption for the whole building — a 40% reduction as compared to the average office buildings in Japan. Ultra-high rise buildings whose main goal is business viability emphasize high performance and require redundancy. This proposal is offered as one example of an equipment plan that is designed to achieve a low carbon footprint in a way that is unobtrusive to building users.

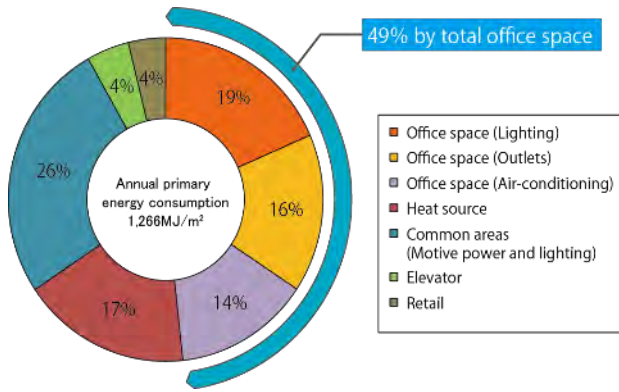

Figure 17: Breakdown of energy consumption

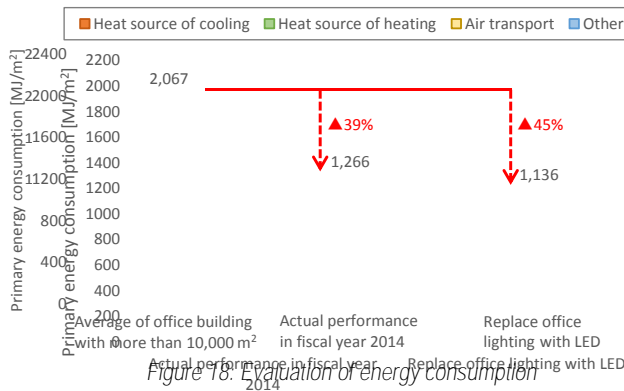

Figure 18: Evaluation of energy consumption

10. ACKNOWLEDGMENT

This research was partially supported by the grant-in-aid for promoting low-carbon building from MLIT (the Ministry of Land, Infrastructure, Transport and Tourism of Japan). The authors would like to express their gratitude to Dr. Yoshinobu Arai of Kajima Technical Research Institute, who provided valuable advice during this research.

REFERENCES

- [1] Ministry of Economy, Trade and Industry (METI), Agency for Natural Resources and Energy, 2016. Outline of the FY 2015 Annual Report on Energy (Energy White Paper 2016).
- [2] Mihara, K., Arai, Y. and Ono, E., 2015. 'Peak Shaving and Economy for Load Leveling using Energy Network Simulation Tool', *Proceedings of BS2015 (14th Conference of International Building Performance Simulation Association)*, Hyderabad, India, 7-9 December.
- [3] Suzuki, Y., Ono, E., Komoda, H., Hiraoka, M., Hiromoto, S. and Ohwada, J., 2012. 'Cooperative Control of Multi-split Type Air-conditioning System with AHU Part 1: Numerical Analysis of Energy Consumption and Environment in Office Spaces', *Technical Papers of the Annual Meeting, SHASE (The Society of Heating, Air-conditioning and Sanitary Engineers of Japan)*, Sapporo, Japan, 5-7 September (in Japanese).

Optimizing Energy Efficiency for a High Rise Office Tower in Tropics

TANG Chee-khoay^a, Aida ELYANA^b, NG Yong-kong^c

^a CK@Work Sdn Bhd, Malaysia, ck@ckatwork.com

^b Veritas Environment Sdn Bhd, Malaysia, aida.elyana@veritas.com.my

^c NYK Engineering and Trading Sdn Bhd, Malaysia, ngyongkong@gmail.com

ABSTRACT

A detailed building energy simulation study showed that it is possible for a building owner in a proposed multi-tenanted high rise office tower to reduce up to 73% energy consumption as the operator of the building. This energy reduction reduces the energy running cost for the building owner from a baseline of RM 2 million per year to a running cost of RM 500,000 per year. The building energy intensity of the building (including tenant energy consumption) reduces from 212 kWh/(m².year) down to 82 kWh/(m².year)

A holistic energy efficiency approach was proposed to achieve such high efficiency gain. Approximately 50 passive and active energy efficiency features were tested for this building. Many of the efficiency gains are in the region of 1~2% energy reduction per design improvement. In addition, the peak cooling load of the building was reduced by 34% due to these design improvements, allowing a smaller air-conditioning system to be implemented for this building.

The energy efficiency passive and active design features that will be implemented in this building is largely considered conventional design practises. However, by making small improvements at every design opportunity, the building can be made very efficient at minimal additional cost to the building. In addition, due to the smaller air-conditioning system, there is a cost reduction that would help to finance the design improvements proposed.

Keywords: building energy simulation, high-performance building, energy saving

1. INTRODUCTION

Johorland Tower is a proposed multi-tenanted office tower to be located on the podium of Komtar JBCC building. The building is located in the heart of Johor Bahru city, just north of Malaysia-Singapore boundary, approximately **5 minutes' drive from the immigration check point.**

The construction of the building started in December 2014 and it is scheduled to complete mid of 2017. It is constructed above an 8-storey podium block and has 27 storeys of office levels as shown in Figure 1. The building will be owned and operated by owner, JohorLand, with the office space leased out to tenants as a multi-tenanted building.

The façade of the building has a curtain wall design (Figure 1) with an average of window to wall ratio of 63%. Large windows give opportunity for good internal daylight but also increases solar heat.



Figure 1: Architectural perspective of JohorLand Tower

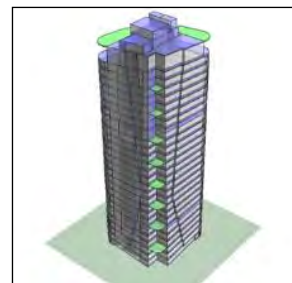

Figure 2: 3D energy model of Johorland Tower

The building will be completed with full mechanical and electrical (M&E) services, providing the design team total control over M&E equipment design and specification.

A range of simulation studies were made to assess the improvements of 47 design enhancements, to reduce the energy consumption of JohorLand Tower. Each simulation case is an incremental step improving the building energy performance.

The energy consumption for this building is reported as Building Energy Intensity (BEI) with units in kWh/(m².year). The BEI is a **methodology of calculating a building's energy that is used by all major Green Building Rating System** in Malaysia, i.e. the Malaysian Green Building Index and GreenRE. In simple terms, the BEI is the total energy consumed per year over the gross floor area of the building.

2. METHODOLOGY

A base case building is initially modelled with a building energy modelling software, using conventional building construction parameters. Design improvement is then incrementally applied to the building. The energy consumption and peak cooling load is then tabled as the output for each scenario.

Such a methodology allows the computed energy consumption and peak cooling load due to each case to be compared to the previous case. In addition, the combined effect of previous improvements made to the building will be accounted at all time.

Dynamic building energy simulation software IES<VE> was used to accurately simulate the building geometry (Figure 2), weather, heat gain and systems of the building. A detailed air-conditioning system of the air-handling unit and chiller plant was also modelled using the HVAC module of the software.

3. WEATHER DATA

Malaysia is located in the hub of a tropical climatic zone. It is summer all year long, with fairly consistent daily air temperature, relative humidity and solar radiation. The average air temperature ranges from a low of 24°C to a high of 31°C with a fairly consistent hourly moisture content of 18 g/kg day and night.

The simulation hourly weather data was based on a Test Reference Year (TRY) developed in University Teknologi Mara (UiTM) under DANCED (Danish International Assistant) project for Energy Simulations for Buildings in Malaysia. The TRY is based on 21 years (1975 to 1995) of weather data from a Malaysian Meteorological Station.

4. BASE BUILDING

The base case building was modelled with conventional building design practises in Malaysia. It complies with the minimum requirement of Malaysian Standard (MS) 1525 for Energy Efficiency in Non-Residential building on all Mechanical and Electrical requirements. Base building represents Case 1 of the study with simulation results of BEI = 212.08 kWh/(m².year) and peak cooling load of 7,394 kW

5. PASSIVE STRATEGIES

Passive strategies of daylight harvesting, envelope insulation, glazing properties and building air-tightness were assessed from Case 2 to 12. The results are shown in Table 1 below.

Cases	Descriptions	BEI (kWh/(m ² .year))	Peak Cooling Load (kW)
1	Base Case	212.08	7,394
2	Daylight 3m depth	200.63	7,260
3	Daylight 4m depth	197.24	7,220
4	Daylight 5m depth	194.28	7,182
5	Roof Insulation 50mm	193.44	7,153
6	Roof Insulation 100mm	193.00	7,149
7	Wall Insulation 25mm	191.46	7,012
8	Single Glazing Low-E	178.55	6,240
9	Partial Double Glazing Low-E	176.13	6,141

10	Full Double Glazing Low-E	172.51	5,924
11	Infiltration 0.25 ach	167.96	5,714
12	Infiltration 0.10 ach	165.12	5,584

Table 1: BEI and peak cooling load result for case 2 to 12

Table 1 showed that the implementation of passive features reduces the BEI down to 165 kWh/(m².year), while the peak cooling load reduces by 24%.

- Daylight Implementation

Cases 2 to 4, simulated a scenario of daylight harvesting. Malaysian climate has consistent daylight from the hours of 9am to 5pm daily, which is perfect for an office building. A daylight harvesting strategy was proposed with inclusion of daylight sensors at the office perimeter on each floor, and a window design to draw daylight deeper into the office area while preventing glare.

The window design consists of horizontal venetian blinds, light shelf and a sloped false ceiling as shown in Figure 4. Quantity of natural indoor daylight is measured by Daylight Factor (DF) as shown in Figure 5. An acceptable DF values for an office building in Malaysia are in the range of 1% to 3.5%. The final daylight simulation showed that usable daylight exceeds 5m providing 47% office areas daylight.

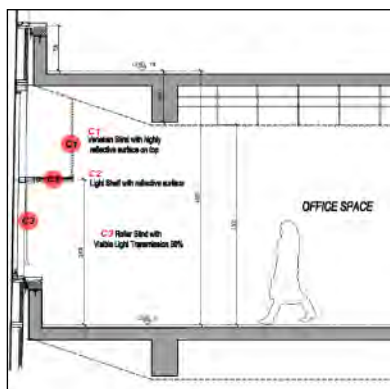

Figure 4: Section view of blinds and light shelf system.

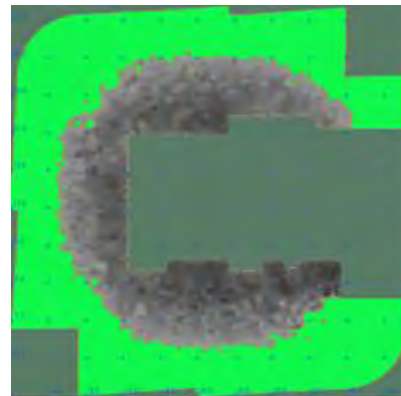

Figure 5: Plan View of DF in the range of 1%-3.5% coloured in green

- Roof and Wall Insulation

Base building was modelled with uninsulated concrete roof. Polystyrene roof insulation of 50mm (U-value 0.5228 W/m²K) and 100mm (U-value 0.2794 W/m²K) thickness was applied to Case 5 and 6. The BEI improves marginally from 50mm to 100mm, indicating that 50mm insulation is sufficient insulation on the roof. 25mm thick Rockwool insulation were then applied to all external walls in Case 7, reducing the wall insulated U-value to 0.8037 W/m²K from an uninsulated scenario of 1.79 W/m²K.

- Glazing Properties

The building consists of 2 types of glazing with different tint as an architectural feature. Case 8 replaces standard glazing (both dark green and light green) with low-E properties. Case 8 reduces the average glazing SHGC to 0.27 from 0.43 and U-value to 3.8 from 4.8 W/m²K. Case 9 replaces the light green glazing as double glazed low-E with SHGC = 0.39 and U-value = 1.95 W/m²K with dark green glazing remaining as single glazed low-E. Case 10 is then simulated with all glazing specified as double glazed low-E. SHGC for the dark green double glazing is 0.23 and U-value = 1.95 W/m²K. Glazing performance was found to have a significant impact with a reduced BEI of 10% and cooling load by 15%.

- Air tightness

The average infiltration rate in office buildings in Malaysia was measured to be 0.5 air change per hour (ach). Improvements to the air tightness details and specification will be made on all external doors, windows and wall finishes. An assumption of infiltration rate reduced to 0.25 ach for Case 11 and 0.10 ach for Case 12 were made. BEI reduces by 1.3% and peak cooling load by 4.5%.

6. LIGHTING STRATEGIES

The lighting improvement strategies were largely based on selection of efficient luminaires to reduce the lighting power density (LPD) and controls to switch off the lights when the space is not used. The results of implementing lighting strategies are presented in Table 2 below.

Cases	Descriptions	BEI (kWh/(m ² .year))	Peak Cooling Load (kW)
12	Base Case for Case 13	165.12	5,584
13	Office LPD 15 to 9 W/m ²	156.89	5,479
14	Office LPD 9 to 7 W/m ²	154.23	5,459
15	Walkway/Lift Lobby LPD 20 to 9 W/m ²	144.51	5,300
16	Walkway/Lift Lobby LPD 9 to 7 W/m ²	141.72	5,267
17	Walkway/Lift Lobby LPD Night 50% to 33% on	140.83	5,248
18	Toilet LPD 10 to 7 W/m ²	140.61	5,248
19	Toilet Occupancy Sensor (50% off)	140.33	5,244
20	Fire Escape Stairwells LPD 15 to 3 W/m ²	135.67	5,168

Table 2: BEI and peak cooling load result for case 13 to 20

The implementation of all the lighting improvement strategies will further reduce the building BEI down to 136 kWh/(m².year). In addition, the peak cooling load of the building is reduced down by 30% from the base case.

- Office LPD

The MS1525 guideline states that the maximum allowable office LPD is 15 W/m². Case 13 and 14 improves the LPD down to 9 W/m² and 7 W/m² respectively. Significant savings are achieved by addressing these items (Table 2).

- Walkway/ lift lobby LPD

Case 15 and 16 showed that the LPD for Walkway and Lift Lobby has a significant influence in the building efficiency. While the MS 1525 allowed such spaced to have a LPD of 20 W/m², the JohorLand Tower is proposed to have a lighting power density of 9 W/m² for Case 15 and 7 W/m² for Case 16. Results in Table 2 showed that BEI reduce by 5.9% and cooling load by 2.6%.

- Walkway/ lift lobby night light

Case 17 proposed that the night lights be reduced from 50% to 33% (i.e. 1/3 of the lights remains on, instead of half), through strategic placement of light fittings adequate to give a sense of safety and security.

- Toilet lighting power density

Case 18 optimizes lighting power at the toilets from 10 W/m² to 7 W/m². Results in Table 2, showed marginal change, indicating that this feature is not a significant contributor to energy efficiency.

- Toilet occupancy sensor

Case 19 introduces an occupancy sensor for all the toilets. An assumption is made that 50% of the time, the lights are switched off. This is modelled by reducing toilet LPD from 7.0 to 3.5 W/m². Results showed marginal reduction.

- Fire escape stairwells LPD

Case 20 improve these fire escape stairwells LPD from the MS1525 standard of 15 W/m² to 3 W/m². Staircase lux lighting levels is optimized to provide just enough light for access and as an escape route.

7. AIR-CONDITIONING STRATEGIES

There are many opportunities to optimise energy efficiency in an air-conditioning system. These are listed from case 21 to 47 as shown in Table 4 below.

Cases	Descriptions	BEI (kWh/(m ² .year))	Peak Cooling Load (kW)
20	Base Case for Case 21	135.67	5,168
21	CAV to VAV	127.09	5,179
22	Duct Static 900 to 500 Pa	120.20	5,165
23	Duct Static 500 to 250 Pa	116.22	5,140
24	Air Filter Static 150 to 80 Pa	115.11	5,135.27
25	Air Filter Static 80 Pa to 50 Pa	114.64	5,130.60
26	Fan Eff. Backward curved to airfoil blade	113.54	5,128.65
27	Fan High efficiency motor used	113.38	5,127.10
28	CO ₂ Controlled Fresh Air Intake	110.56	4,973.87
29	Heat Recovery	108.16	4,924.63
30	Chilled Water ΔT 6.67°C-13.34°C to 5.56°C-14.44°C	107.09	4,864.44
31	Chilled Water ΔT 6.67°C-15.56°C	106.75	4,880.72
32	Chilled Water Pump Head 40m to 30m	105.60	4,875.36
33	Chilled Water Pump Head 30m to 20m	104.46	4,869.99
34	Chilled Water Pump Eff. 70% to 80%	104.18	4,868.64
35	Chilled Water Pump High Efficiency Motor	104.12	4,868.33
36	Variable Chilled Water Pump	102.64	4,866.38
37	Chiller Efficiency COP 5.5 to 6.2	98.69	4,837.72
38	Chiller Efficiency COP 5.5 to 6.6	96.81	4,807.00
39	VSD Chiller	91.28	4,772.84
40	Condenser Water ΔT 5.56°C to 6.67°C	89.62	4,772.78
41	Condenser Pump Head 40m to 30m	87.46	4,772.78
42	Condenser Pump Head 30m to 20m	85.30	4,772.78
43	Condenser Pump Eff. 70% to 80%	84.76	4,772.76
44	Condenser Pump High Efficiency Motor	84.64	4,772.77
45	Cooling Tower High Efficiency Fan	82.59	4,772.77
46	Variable Speed Cooling Tower	81.17	4,772.77
47	Upsized Cooling Tower	80.83	4,772.77

Table 4: BEI and peak cooling load result for case 21 to 47

The implementation of all the air-conditioning system improvement reduces the building BEI down to 80 kWh/(m².year). In addition, the peak cooling load of the building is reduced down by 35.5% from the original base case.

- Variable air volume

A constant air volume (CAV) system is typically installed for office buildings in Malaysia. Case 21 improves the system by implementing a variable air volume (VAV) system. Supply air flow will be regulated according to the cooling needs, reducing fan energy consumption. Table 4 showed that BEI reduces by 4%.

- Duct static pressure

Larger duct with less bends reduces the fan static pressure. Case 22 reduces the duct static pressure from 900 to 500 Pa and Case 23 further reduced it to 250 Pa. By optimizing duct design BEI reduces by 8.5% and cooling load by 0.7%.

- AHU air filter

Case 24 and 25 further improves the AHU static pressure by using improved filters. Case 24 specifies a low efficiency air filter which reduces total static pressure to 580 Pa. Case 25 specifies an electronic air filter which further reduces total static pressure to 550 Pa.

- Fan efficiency

The conventional fan selection for AHU is based on backward curve blades. Case 26 implements an airfoil type fan blades to improve the fan total efficiency to 70.2% from 61%. Case 27 uses a higher efficiency IE3 fan motor to improve total fan efficiency to 71.8%.

- CO₂ sensor

CO₂ sensors are introduced in Case 28 to regulate the fresh air intake system. This sensor allows the fresh air supply to be reduced when occupancy is low or when there is adequate fresh air in the building due to infiltration.

- Heat recovery system

A heat recovery system was introduced in Case 29 to recover energy rejected by the toilet exhaust system and transfer it to the outdoor air intake system located on the roof. The heat recovery system was specified with 50% efficiency for latent and sensible load.

- Chilled water delta-t

A high delta-T chilled water system reduces the flow rate, thus chilled water pumps is smaller reducing energy consumption. Both Case 30 and Case 31 assumes a delta T of 16 °F. Case 30 has supply and return temperature of 42 °F and 58 °F respectively. While Case 31 has supply and return temperature of 44 °F and 60°F respectively. The results indicate that given the same delta-T, higher supply / return temperature gives a better BEI value.

- Chilled water pump pressure:

Chilled water pump pressure is reduced by optimizing pipe size, reduce bends, tees, and transitions Case 32 simulates results for a pump pressure of 30m while Case 33; 20m. Results are shown in Table 4.

- Chilled water pump efficiency:

Case 34 improves total pump efficiency from 63% to 72% and then further improve efficiency to 74.4% by specifying an IE3 motor instead of an IE2 motor for Case 35.

- Variable primary chilled water pump:

Case 36 upgrades the chilled water pump from a constant flow to a variable flow pump. The pumps are able to vary flow rate according to demand and heat load, hence have better performance at part load.

- Chiller Coefficient of Performance (COP)

The chiller is the biggest energy consumer in the air conditioning system. Standard chiller COP in the market currently ranges from 5.5 to 6.0. Case 37 and Case 38 simulates results for higher efficiency chillers, with COP at 6.2 and 6.6 respectively. A COP of 6.6 can be achieved by many high efficiency chillers in the market today. The results shown in Table 4, a chiller COP of 6.6 reduces BEI by 5.7%.

- Variable Speed Drive (VSD) chiller

To further improve the chiller performance, a variable speed drive was specified on the chiller and simulated in Case 39. VSD chillers have a variable speed compressor hence have better part load efficiency. BEI reduces by a further 5.7%.

- Condenser water delta-t

Case 40 increases condenser water delta-T from 10 °F to 12 °F. As a result, condenser water pump flow rate decreases, thus reducing pump power. BEI reduces by 1.8%. The efficiency of the chiller was simulated to drop marginally. The resulting pump power reduction provided an overall higher energy reduction.

- Condenser pump pressure

Decrease condenser water pump pressure by optimizing pipe size, reduce bends, tees, transitions and any others that will add to the pump pressure. Case 41 simulates results for a pump pressure of 30m while Case 42; 20m.

- Condenser pump efficiency

Case 43 improves total pump efficiency from 63% to 72% by using a higher efficiency pump. And Case 44 further improves total efficiency to 74.4% by specifying an IE3 motor.

- Cooling tower efficiency

Case 45 improve cooling tower efficiency to 0.0275 kW/HRT by specifying a more efficient fan motor.

- Variable speed cooling tower

Case 46 assess a variable speed fan on the cooling tower. Results show BEI reduces by 1.7%.

- Oversized cooling tower

Case 47 oversize the cooling tower by designing the return temperature from 29.4 °C to 28.5 °C.

8. SUMMARY OF RESULTS

The results of the simulation are summarized on two levels:

- Energy efficiency

Overall, BEI reduces by 62% from base building to Case 47. Passive systems contribute to a reduction of 22%, lighting 14% and air conditioning 25%. Each case give a reduction of about 1 to 2%. Large reduction are provided by daylight implementation, glazing performance, office lighting and chiller performance. Total energy consumed per year by the building reduces by 5,041 MWh. With energy cost in Malaysia rated at RM0.51 per kWh, this is a savings of RM2.57 million (USD 600,000) per year. Since Johorland Tower is a multi-tenanted building, energy consumed by the owner can be estimated by deducting electrical energy for lighting & small power for all office spaces from Total Energy per Year. In which reduction energy cost per year by owner is RM1.49 million.

- Peak cooling load

Overall peak cooling load reduces by 2,622 kW which is a reduction of 35.5%. Figure 9 shows cooling load reduction. The Passive design strategies contributed to more than 68% of the peak load reduction. Peak cooling load does not show much decrease after Case 30 because these cases improves air conditioning equipment performance and does not have significant impact on the cooling load. The reduction in peak cooling load means all air conditioning equipment capacities can be reduced thus reducing capital cost.

9. CONCLUSION

Simulation software allowed a possibility to track each improvement case and know its effectiveness in reducing overall energy consumption and air conditioning load. Each individual case brings small contributions to overall energy savings. However, when all these small contributions are added up, a substantial overall energy saving is achievable.

REFERENCES

- [1] Tang CK; Chin N, Building Energy Efficiency Technical Guideline for Passive Design. Malaysia Building Sector Energy Efficiency Project (BSEEP), 2013.
- [2] Green Building Index, BEI computation, <http://www.greenbuildingindex.org/FAQs-9.html> , 2015.
- [3] GreenRE, <http://www.greenre.org>, 2015.
- [4] MS 1525, Malaysian Standard for Energy Efficiency in Non-Residential Buildings. 2014.

- [5] Pusat Tenaga Malaysia (PTM), Energy Efficiency and Conservation Guidelines for Malaysian Industries (PTM), 2007.
- [6] Reimann, G. Energy Simulations for Buildings in Malaysia, Test Reference Year Weather Data, 18-25, 2000.
- [7] Ezzuddin Ab Razad, CK Tang, Control Of Moisture & Infiltration For Advanced Energy Efficient Buildings In The Tropics, Conference on Sustainable Building South East Asia, 4-6th May 2010, Malaysia

Session 4.10: Transforming SBE Practices – Energy Management (3)

Energy Data Transparency Benefits To Drive Down Of Energy Consumption Of A Commercial Hotel

Conrad TC WONG^a, Antonio CM CHAN^b, Carmen YS WONG^c, Andrew NING^d, Albert TP SO^e

^a Yau Lee Holdings Ltd., Hong Kong SAR, conradwong@yaulee.com

^b REC Engineering Co., Ltd., Hong Kong SAR, antoniochan@rec-eng.com

^c REC Green Technologies Co., Ltd., Hong Kong SAR, carmenwong@rec-eng.com

^d Yau Lee Holdings Ltd., Hong Kong SAR, andrewning@yaulee.com

^e Asian Institute of Built Environment, Hong Kong SAR, albertso@aibe-edu.org

ABSTRACT

Good decisions are based on the high-quality and timely information. Meaningful information comes from meaningful data. Data transparency encourages more transformational knowledge creation. The presented software solution (PowerBox) offers the analysis and monitoring of energy usage in buildings. Such system enables **users to analyze the power usage from various components. Compare different building's energy data in the same category** is an effective way to understand the building performance. It gives more efficient use of energy potentials and provides building owner for identifying energy management opportunities. Beyond increasing awareness in energy consumption, the energy management solution provides analyses that reveal patterns and trends, compare outlets, and identify maintenance issues and retrofitting necessary to prevent the failure of major building equipment. The building owners/engineers can craft more realistic energy reduction targets that coincide with current energy consumption data and strive to reduce energy consumption as low as possible without affecting the function of the building. Its graphical user interfaces allow simple visualization of current readings from the installed sub-systems, and dashboards are available for the analysis of the building performance over a specific time period. The presented case reveals the hotel engineers leverage the actionable insights to optimize their energy use and reduce consumption throughout the modification works of chiller plant control optimization and integrated heat pump system to the existing Heating, Ventilation, and Air Conditioning (HVAC) system.

Keywords: energy saving, retro-commission, building performance monitoring

1. INTRODUCTION

This paper presents a case study of a commercial hotel, which focuses on enhancing data transparency, thus helping building owner to reduce energy consumption and to drive down energy costs, increase energy efficiencies and optimize processes. PowerBox can be regarded as a real-time building performance monitoring solution, which provides a platform to store, analyze and display building energy data. Time-series data from building-device sensors and electricity meters are used to perform analyses such as HVAC device profiling and benchmarking. Figure 1 describes the basic system infrastructure of PowerBox solution and its web-based graphical interfaces.



Figure 1: PowerBox - Basic System Infrastructure and its web-based graphical interfaces

Mills (2009) reported that the actual building performances rarely meet the expected one during design stages. Diamond (2011) and Göçer et al. (2015) also came with the same concluding remark. Both indicated that the most frequently cited barrier was down to lack of information to evaluate building energy performance. Nativi et al. (2015) published the qualitative benefits with enhanced data transparency. Li et al. (2013) emphasized the importance to enhance data transparency in energy consumption, thus influencing building occupants and residents to change their day-to-day behavior or to invest in efficiency measures. Petersen et al. (2007) demonstrated how an enhancement in data transparency can stimulate resource conservation for dormitory residents. His report concluded that, with greater data transparency, combined with education and an incentive, could achieve a 32 percent reduction in electricity consumption (amounting to savings of 68,300 kWh).

Apart from data transparency issue, the analysis of energy performance data is also essential to improve building efficiency. Keyvanfar (2014) conducted interviews with building operators and energy managers in order to measure the benefits through the analysis of building energy data. Case investigations conducted by Granderson et al (2011) indicated that most common energy savings came from rectification of inefficient operations and scheduling errors of building devices. Aman (2013) reviewed the essential monitoring and analytic features for web-based building control systems. Technologies and features embedded in PowerBox are well aligned with the modern requirements for building performance monitoring solution.

2. CASE STUDY

A commercial hotel was selected, namely the Holiday Inn Express SoHo, located in 83 Jevious Street in Sheung Wan, Hong Kong. The hotel was opened in September 2012 with 274 rooms and 36 storey high. The HVAC system of the hotel consists of two chillers with twin compressors, two cooling towers, one air handling unit and three primary air units and the other necessary chilled water and condensing water pump, as stated in Figure 2.

Holiday Inn Express Hotel SoHo, 83 Jevious Street, Sheung Wan, Hong Kong



The hotel HVAC system consists:

Air-side	Water-side
One AHU Three PAUs	Two chillers with twin compressors Two cooling towers Two chilled water pumps Two condenser water pumps

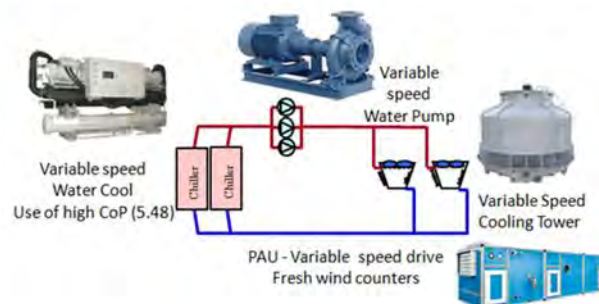

Figure 2: Appearance of commercial hotel and description of major HVAC system devices

Energy Management Opportunities (EMO) were considered in the design stage of the hotel. It was equipped with many sensors in order to monitor the building performance and provide data to the Building Management System (BMS) and Power Quality Monitoring (PQM) System. The energy consumption data recorded by BMS and PQM is stored in the PowerBox database while the operators can review the past building energy performance based on any required time range. The selected data can be displayed in tables, trend lines as well as customized design report for the energy audit submission.

Figure 3 describes the general PowerBox functionalities, which illustrates the typical information exchange between BMS & PQM and the power meters on the field via Ethernet. The electricity data can be used to analyze the energy usage pattern, allocate the energy cost, and develop Energy Utilization Index (EUI) and Energy Performance Index. PowerBox solution can display the real-time energy information generated by BMS and PQM System in interactive versatile formats including graph, trend, spreadsheet and report. Moreover, PowerBox solution has the ability to display those diagrams, trend, spreadsheet, and reports, which may consist of both real-time and historical data, via a standard web browser interface. This allows operators and management staff can access the system through the workstation, smartphones or tablets as long as internet connection is available. Thus, energy management can be monitored at anywhere and anytime through PowerBox solution.

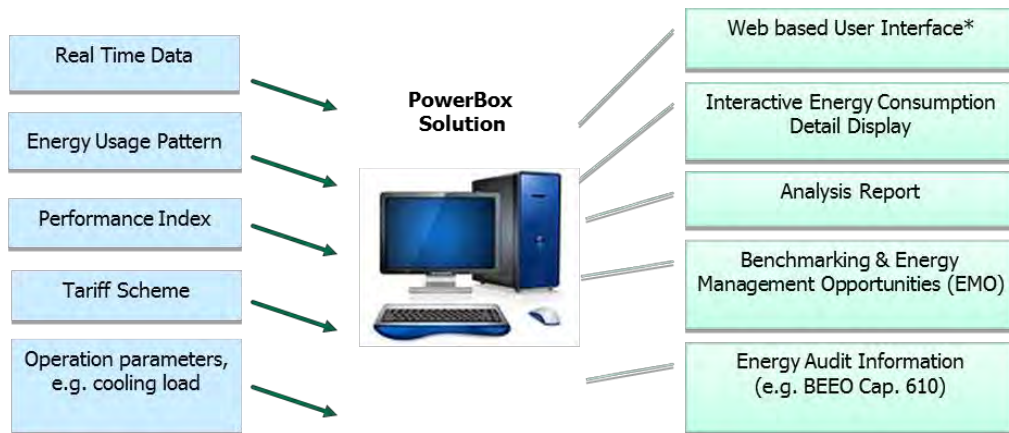

Figure3: PowerBox System Functionalities

a) Energy management opportunity – hot water circuit

The PowerBox solution was implemented since the turn of 2013. In early August 2013, hotel engineers noticed the frequently switch-on and off of the 3000L Calorifier (Figure 4), which was used to maintain the high temperature of hot water system. Such observation was not normal in the summer time. After detail investigation, heat loss was observed during hot water re-circulation, despite very little hot water usage.

After ruling out deterioration of the insulation in the hot water system, hotel engineers had concluded that a modification of hot water circuit was a possible solution. Consequently, a heat pump was re-assigned to the hot water supply to minimize electric heater operation (Figure 5). Moreover, a hot water recirculation return pipe was installed to ensure heat pump heat generation to compensate the heat loss induced during hot water re-circulation regardless to the actual hot water usage (Figure 6). After modification, the energy consumption was reduced by 95% (Figure 7).

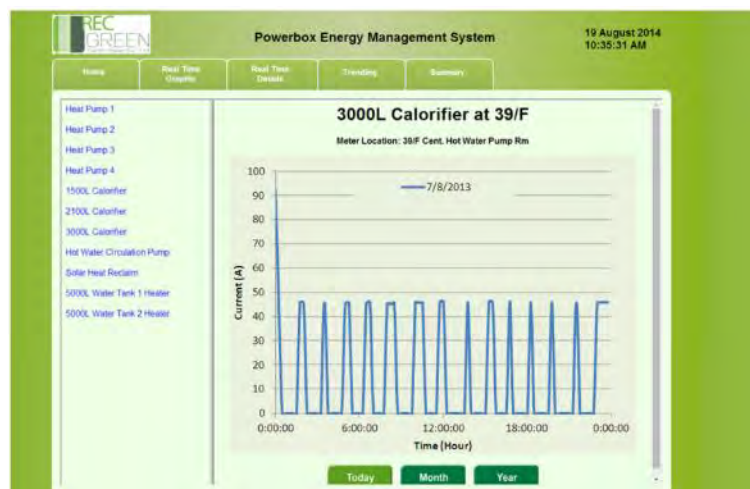
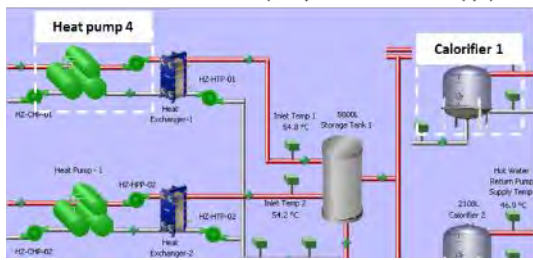

Figure 4: High energy consumption by 3000L Calorifier operation in August 2013

Before modification:
No connection between heat pump and hot water supply



After modification:
A heat pump was re-assigned to hot water supply

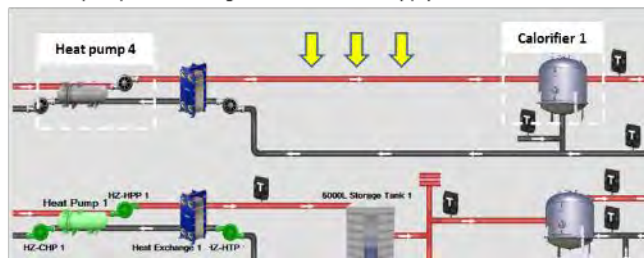
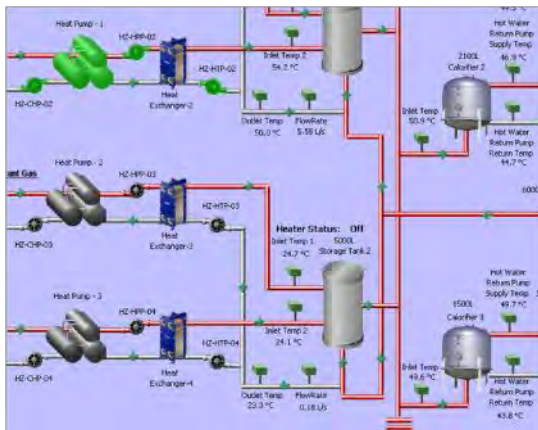

Figure 5: Re-assign heat pump to hot water supply

Before modification:
No hot water re-circulation design



After modification:
A hot water recirculation return pipe was installed

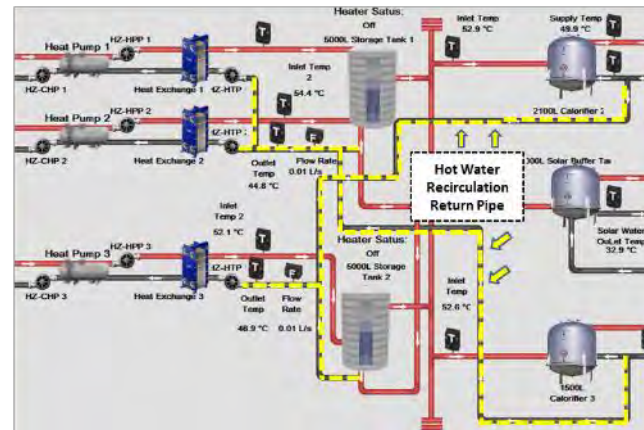

Figure 6: Installation of hot water recirculation return pipe

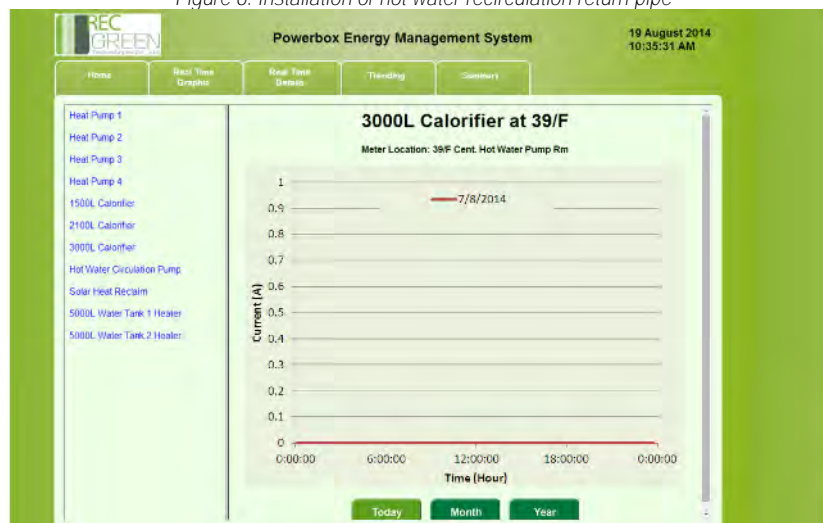

Figure 7: Low energy consumption by 3000L Calorifier Operation in August 2014

b) Energy management opportunity – central chiller system

After the completion of the hot water circuit modification, hotel engineers had noticed frequent switching of chiller during low ambient temperature season. Although the chilled water generated from heat-pump operation benefited the chilled water return temperature, it resulted in more frequent chiller switching. In view of this, cooling towers and condensing pumps continued to run in order to keep the chiller in a standby condition even at a very cool ambient environment, thus leading unnecessary energy consumption.

The hotel engineers concluded that an EMO could be achieved through conducting an optimization of chiller plant control. A chilled water recycling mode was introduced for low ambient temperature operation. Such mode had included the switching off of chillers, cooling towers, and condenser pumps, as well as the directing of chilled water source (generated from heat pump operations) as a primary support for thermal comfort (Figure 8).

Before modification:

No connection between chiller section and heat pump section

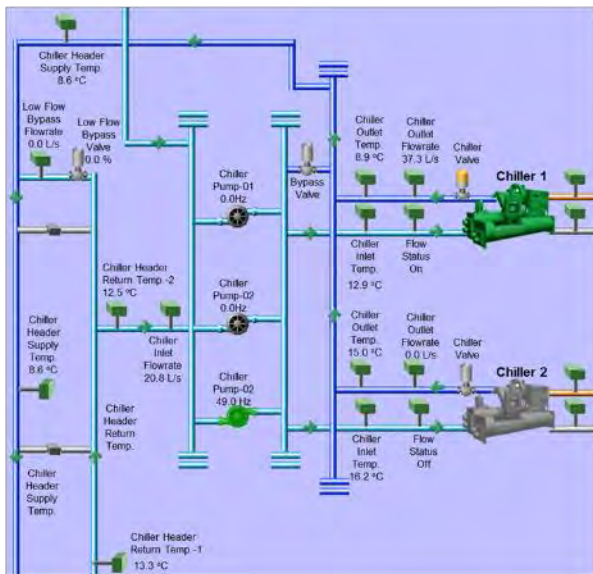

After modification:

Installation of chilled water recirculation pipe

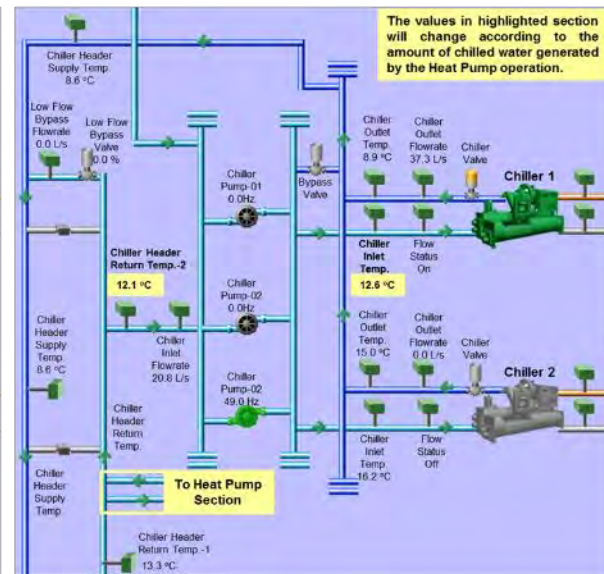

Figure 8: Installation of chilled water recycling pipe

The Chiller Plant modification, which included implementation of control strategies for chillers, chiller pumps, cooling towers and cooling tower pumps, was completed in February 2015. Table 1 described the energy consumption of Chiller Plant between [i] January 2015 and January 2016; [ii] February 2015 and February 2016. Energy consumption in January 2016 decreased by 14 per cent compared to January 2015, while the one in February 2016 decreased by 42 per cent compared to February 2015.

Chiller Plant	2015	2016	Difference
January	17417 (kWh)	14955 (kWh)	↓↓ 2462 (kWh) / 14%
February	17517 (kWh)	10134 (kWh)	↓↓ 7383 (kWh) / 42%

Table 1: Comparison of energy consumption between [i] January 2015 and January 2016; [ii] February 2015 and February 2016 for Chiller Plant

c) Abnormal energy consumption – cooling tower system

At the end of February 2015, hotel engineers noticed the non-stop running of cooling towers throughout the entire month. It was an abnormal observation because cooling towers were kept operating for every minute during whole February, as shown in Table 2. Even if the cooling tower was required at that frequency, often a tower-switch pattern should be observed, as shown in Figure 9. However, as shown in Figure 10, only Cooling Tower 2 was in operation throughout February. After detail investigation, hotel engineers identified the malfunction of the water level sensor in the cooling tower tank. After replacement of the device, no abnormal pattern was observed further.

Cooling Tower	2014-February	2015- February	Difference
Runtime	16187 (mins)	40320 (mins)	↑↑ 24133 (mins) / 149%
Energy Consumption	572 (kWh)	1886 (kWh)	↑↑ 1314 (kWh) / 230%

Table 2: Comparison of runtime and energy consumption between February 2014 and February 2015 for Cooling Towers.

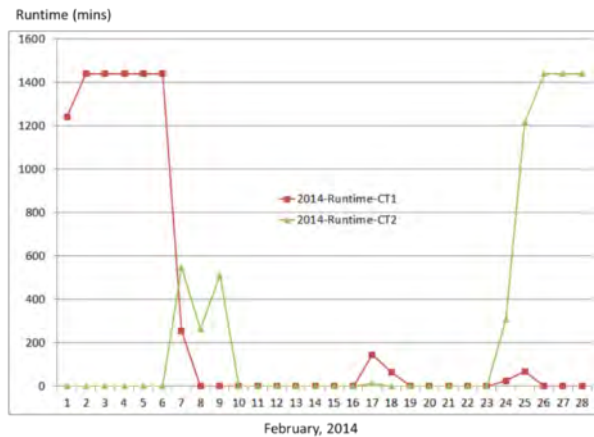

Figure 9: Runtime of Cooling Tower 1 and 2 in February 2014

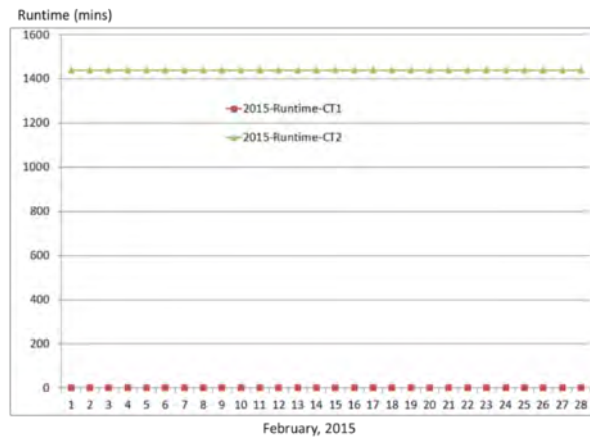

Figure 10: Runtime of Cooling Tower 1 and 2 in February 2015 (with malfunction of the water-level sensor)

3. DISCUSSION

The secret to implementing a successful EMO is not only about software, but the human inputs. Fresh data insights only truly matter if engineers can use them to identify and solve problems. Based on the hot water circuit case, the PowerBox platform can notify hotel engineers for early maintenance and conduct optimization. As shown in both the hot water circuit and cooling tower cases, such platform allowed hotel engineers to facilitate the understanding of the energy consumption pattern and to identify inefficient consumption among the building facilities. As for the central chiller plant case, the embedded analytical features can assist hotel engineers to conduct energy optimization, as well as to avoid wastage and unwarranted capacity expansion. With sufficient data being collected and the evolvement of artificial intelligent technologies, hotel engineers can use the PowerBox platform to develop advanced decision support tools to reflect abnormal patterns and to identify more energy management opportunities.

4. CONCLUSION

With the advancement in sensor and sensing technologies, many building owners and engineers are overwhelmed by data and feeling lost in these complex situations. This paper highlighted the power of data transparency and demonstrated how a platform to turn data into usable information, then allow building owners and engineers to identify EMO. Based on the presented cases, enhancing data transparency led to value creation in two key areas. Firstly, hotel engineers can make use of the analytical tools for better resources allocation, thus driving down energy consumption. Secondly, the implementation of PowerBox has created a platform where hotel engineers can use building energy data to conduct analytics and optimization tasks. Encouraging them to identify EMO and provide smart solutions that can yield a positive and lasting energy savings.

REFERENCES

- [1] Aman, S., Simmhan, Y., & Prasanna, V. K. 2013. Energy management systems: state of the art and emerging trends. *IEEE Communications Magazine*, 51(1), 114-119.
- [2] Diamond, R. 2011. Evaluating the energy performance of the first generation of LEED-certified commercial buildings. Lawrence Berkeley National Laboratory.
- [3] Göçer, Ö., Hua, Y., & Göçer, K. 2015. Completing the missing link in building design process: Enhancing post-occupancy evaluation method for effective feedback for building performance. *Building and Environment*, 89, 14-27.
- [4] Granderson, J., Piette, M. A., & Ghatikar, G. 2011. Building energy information systems: User case studies. *Energy Efficiency*, 4(1), 17-30.
- [5] Keyvanfar, A., Shafaghat, A., Majid, M. Z. A., Lamit, H. B., Hussin, M. W., Ali, K. N. B., & Saad, A. D. 2014. User satisfaction adaptive behaviors for assessing energy efficient building indoor cooling and lighting environment. *Renewable and Sustainable Energy Reviews*, 39, 277-295.
- [6] Li, D. H., Yang, L., & Lam, J. C. 2013. Zero energy buildings and sustainable development implications—A review. *Energy*, 54, 1-10.

- [7] Mills, E. 2009. Monitoring-Based Commissioning: Benchmarking Analysis of 24 UC/CSU/IOU Projects. Lawrence Berkeley National Laboratory.
- [8] Nativi, S., Mazzetti, P., Santoro, M., Papeschi, F., Craglia, M., & Ochiai, O. 2015. Big data challenges in building the global earth observation system of systems. *Environmental Modelling & Software*, 68, 1-26.
- [9] Petersen, J. E., Shunturov, V., Janda, K., Platt, G., & Weinberger, K. 2007. Dormitory residents reduce electricity consumption when exposed to real-time visual feedback and incentives. *International Journal of Sustainability in Higher Education*, 8(1), 16-33.

ACT-Shop – A Retro-commissioning Scheme for Existing Buildings in Hong Kong

Cary CHAN^a, Karen CHEUNG^b, Paul SAT^c

^a Hong Kong Green Building Council Ltd., Hong Kong SAR, cary.chan@hkgbc.org.hk

^b Hong Kong Green Building Council Ltd., Hong Kong SAR, karen.cheung@hkgbc.org.hk

^c Hong Kong Green Building Council Ltd., Hong Kong SAR, paul.sat@hkgbc.org.hk

ABSTRACT

Improving the energy efficiency of existing buildings is recognised worldwide, as one of the priorities in combating **climate change**. The HKSAR Government launched the “Energy Saving Plan for Hong Kong’s Built Environment 2015~2025+” in 2015. The plan aims to achieve an energy intensity reduction of 40% by 2025. One of the key strategies to achieve the above target is to drive the existing building stocks to carry out retro-commissioning and retrofitting.

Retro-commissioning is complicated, highly specific to individual buildings and cannot just follow guidebooks as **with new designs**. “**Knowledge-based**” approach enables informed decisions to be made based on information generated through the analysis of operating data and application of engineering theories.

Two major barriers in adopting this approach by the industry include:

- The lack of adequate hardware for data collection and storage in buildings
- The lack of qualified engineers with knowledge-based retro-commissioning experiences

In order to tackle these barriers and discover potential challenges, the HKGBC is engaging different building **practitioners to join the “ACT-Shop” Programme to implement knowledge-based** energy management and retro-commissioning practices. The objectives of this Programme are: 1) to provide a collaborative platform for a group of participating companies to work step-by-step with experienced facilitators to carry out retro-commissioning for their buildings; 2) to work as peers to develop standardised methodologies for achieving comprehensive data collection and analysis, with the help of metering systems. Last but not the least, this Programme aims to build up their in-house competence on re-commissioning practices so as to plan for major retrofits and make ready for the next mandatory energy audit in the near future.

This paper reviews the process of the “ACT-Shop” Programme, the benefits to participating building owners, the effectiveness of the outcome in building capacities and driving changes to the industry.

Keywords: retro-commissioning, existing building, energy performance

1. INTRODUCTION

Experience-based operations are the main stream practices adopted by the Operation and Maintenance (O&M) practitioners in Hong Kong. Chiller plants are normally operated manually based on operators experience. Reliability is usually their key consideration in determining the operation strategies of their HVAC plants. Reference is usually made with the design parameters when the building is designed rather than based on the actual load profile and performance characteristics of their plant. Most buildings lack adequate provisions for the collecting and storage of operating data. Plant operators often lack the skills and knowledge in analysing and making good use of operating data to facilitate them in optimising the efficiency of their plants.

In recent years, with the advancements in Building Management Systems (BMS), operating data and information is becoming more accessible for plant operators. The industry is gradually recognising the value of retro-commissioning, i.e. the process of fine tuning the operating strategies of their plants and equipment based on actual load profile and plant performance characteristics. Significant savings in the order of 8 to 15 percent can be achieved with relatively short payback period of between 0 to 3 years.

While more appropriate hardware is becoming available, the industry is now facing the challenge in building up the capacity of operational professionals to be **able to adopt a “knowledge-based” approach in energy management** and retro-commissioning. Unlike designing new systems, training up professionals to do retro-commissioning by using guidelines, handbooks and training classes are not effective.

2. THE ACT-SHOP PROGRAMME

2.1. Features of the programme

In view of this, the Hong Kong Green Building Council (HKGBC) initiated an “ACT-Shop” Programme with the aim to build up the capacity of the industry on adopting “knowledge-based” approach retro-commissioning practices for central air-conditioning systems.

Under the Programme, the HKGBC will provide a platform where participants of up to five buildings with their technical representatives will go through a retro-commissioning process together.

The Programme is facilitated **by experts with the knowledge and experiences on “knowledge-based” energy management and retro-commissioning.**

The key features of the ACT-Shop Programme are:

- Using real buildings as living laboratory;
- Working together with the technical staff of those buildings instead of doing the study for them in order to build up their competence;
- Emphasising on the use of operating data to provide the necessary information for the process;
- Participants will be expected to carry out the improvement measures and verify the savings together; and
- Building up the necessary energy management system so that their technical staff can implement an on-going knowledge-based energy management system after participating the Programme.

2.2. Objectives of the programme

The key objectives of participants participating the ACT-Shop Programme are:

- **Actively supporting Hong Kong Government’s Energy Saving Plan;**
- Building up the competence for the industry on retro-commissioning through:
 - Developing a data/knowledge base;
 - Developing a systematic approach for retro-commissioning;
 - Demonstrating the value of retro-commissioning;
 - Transferring knowledge and skills to the industry; and
 - Establishing a practical operation and management system;
- Promoting the adoption of best practices to the industry.

The benefits of ACT-Shop to various stakeholders and how it can build up the competence of the industry is illustrated in Figure 1 below.

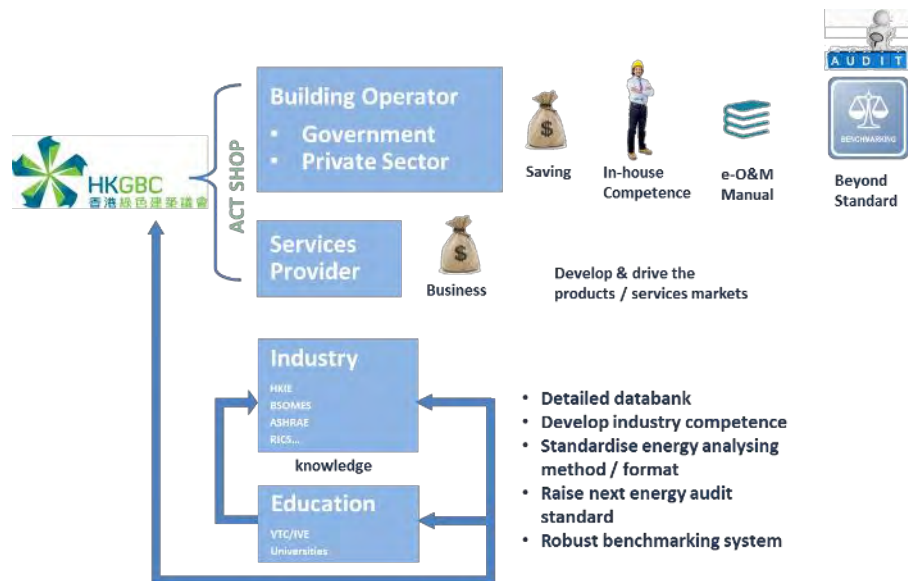

Figure 1: The idea of ACT-Shop to establish a knowledge sharing platform.

3. PILOT STUDY FOR 5 BUILDINGS

Five buildings were selected as pilot cases. The buildings were specifically selected with different design, usage and age.

3.1 Methodology of the programme

The programme includes on-site evaluation and progress review meetings. These can provide a general understanding on the design and conditions of the Heating, Ventilation Air Conditioning (HVAC) plant. Participants will be asked to provide the following data and information for the preliminary analysis, discussions among participants and exploring system optimisation opportunities.

- Log sheets
- Equipment Schedule
- BMS Data
- Availability of metres and sensors
- Conditions of equipment
- Schematics of HVAC Systems
- Service Reports

Through the process of ACT-Shop, some common problems regarding data collection were observed from the pilot buildings, for example: 1) lack of BMS database, 2) incomplete log data in certain time, 3) incomplete equipment schedules, 4) limited provisions of in-situ metres, and 5) limited knowledge of energy management in building operations.

Although the quality of information available is not ideal, it is still possible to identify the issues of the chiller plants based on limited data through data analysis. The Programme has proven that the readily available data is sufficient to carry out retro-commissioning process.

3.2 Data analysis

Based on the data and information collected, a number of Key Performance Indicators (KPI), such as Full Load Current (FLA), Differential Temperature of Chilled Water (Delta T), are plotted against Cooling Load to determine operating conditions of the chiller plants (ASHRAE, 2002). These charts are used to identify current operation practices and potential to improve the chiller plant performance. By fine-tuning the control setting, the performance of chiller plant will be enhanced progressively (Xiao, F., & Wang, S., 2009).

4 FINDINGS FROM THE PILOT CASES

4.1 Analysis results of operating data

Restricted by the length of the paper, only two issues observed are discussed in this paper as illustration.

Chiller operation problems were found by analysing the data provided by the participants. Chart 2a shows the FLA of each chiller against the percentage of part load of the chiller plant for one of the pilot buildings. The green line is the reference line, representing the theoretical FLA of individual chillers at different chiller combinations. For this pilot building, the chiller plant consists of four 190-ton air-cooled chillers. The blue dots indicate the FLA for three individual chillers in operation whilst the orange dots represent those for two chillers in operation.

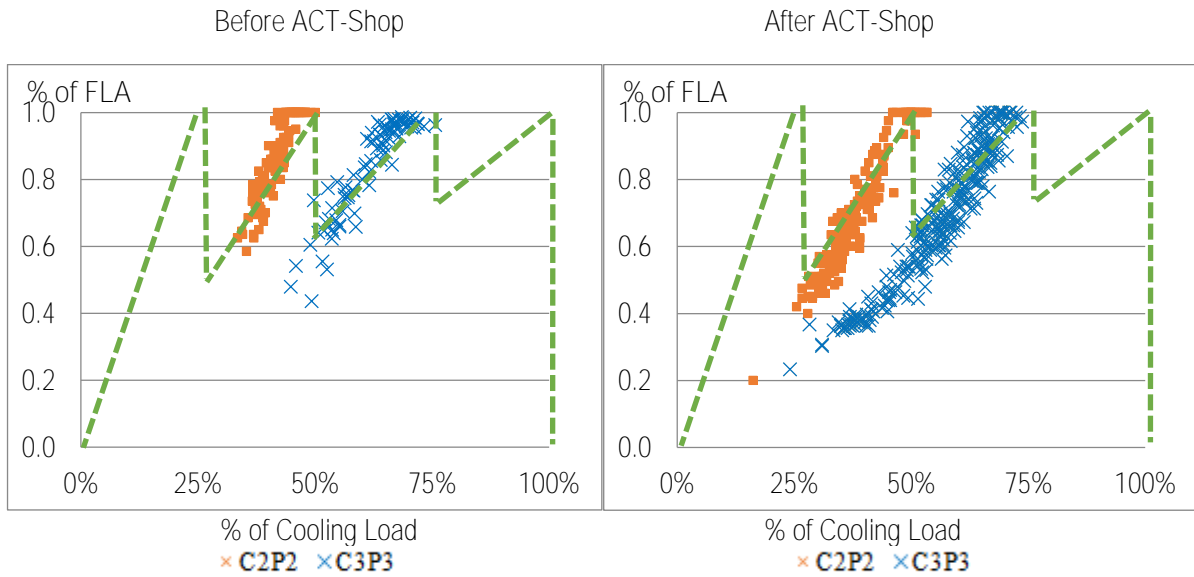

Chart 2a (left) and 2b (right): Sequencing profile - percentage of full load ampere versus cooling load before and after ACT-Shop

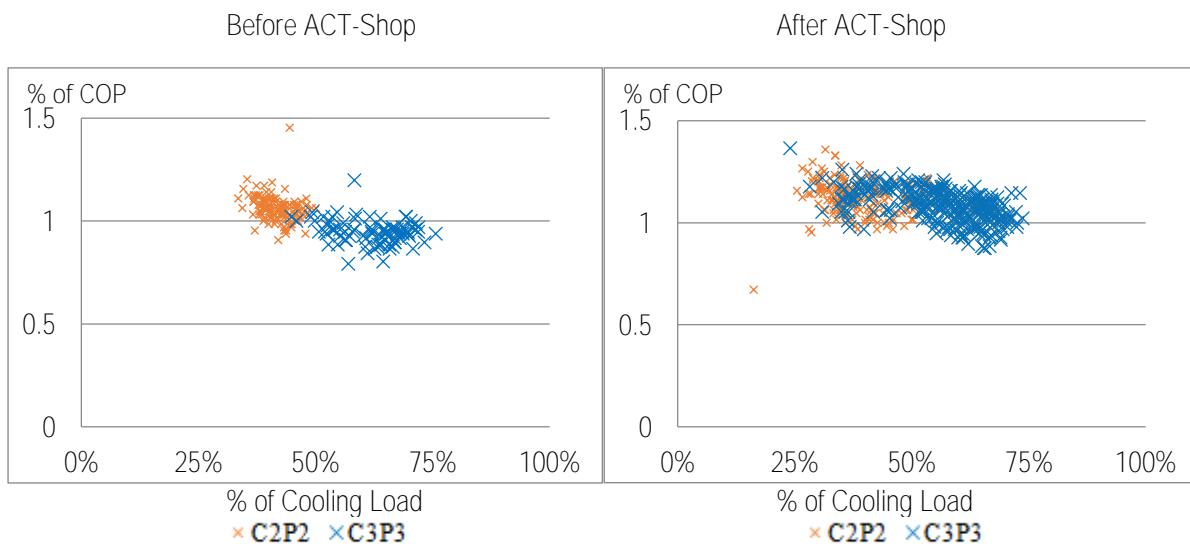

Chart 3a (left) and 3b (right): Overall chiller COP versus cooling load before and after ACT-Shop

Before the ACT-Shop, the number of chillers was operated based on the reference line (Chart 2a). Orange dots and blue dots representing 2 chillers and 3 chillers in operation accordingly were shown in Chart 2a. The chart indicated that within the range of 25% to 50% part load condition, the FLA for three chillers is lower than two chillers in operation. By analysing the COP of the individual chillers, the COP for chillers within the range is higher.

With these findings, the chiller sequencing control was revised from two chiller operation to three chiller operation within the range of 25% to 50%. Chart 2b shows the revised chiller operation.

Chart 3a and 3b illustrate that the overall chiller COP for three chiller operation is higher than that for two chiller operation under the range of 25% to 50%. The average COP for three chiller operation is 3.67, which is higher than that for two chiller operation (3.39) within that range.

This case study illustrates that through this simple screening method, operators can identify potentials to improve the COP of their plant sequencing and the same chart can be used regularly to monitor the plant efficiency and determine the sequencing strategy.

The estimated saving of adopting the new strategies is approximately 120 MWh per month, equivalent to an approximate HKD 117,000 saving per month while little cost was involved.

The other illustration is a building with a chiller plant using a single loop chilled water system with differential pressure bypass. The differential temperature of chilled water (Delta T) was plotted against cooling load. In principle, the level of Delta T should theoretically follow the blue reference line under various cooling load conditions. From Chart 4, the level of Delta T can reach the reference line in the high cooling load region. However, at the low cooling load region, the level of Delta T is far below the reference line. A low Delta T will require more pumping power for the same cooling load and decrease the COP of the chillers due to a lower than required evaporating temperature.

The low Delta T is usually caused by the faulty control valves of the terminal units (FCUs and AHUs) and/or the differential pressure bypass valve. The differential pressure valves were checked and confirmed to be faulty. At the writing of this paper, the faulty valve is being replaced and the checking of the other control valves are in progress. After rectifying those, the differential pressure and hence the amount of bypass will be properly controlled. Significant savings will be expected from pump power and improvement in chiller COP.

This illustrates another simple screening method for operators to monitor the conditions of the chilled water loop which can lead to significant wastage in energy to the chiller plant.

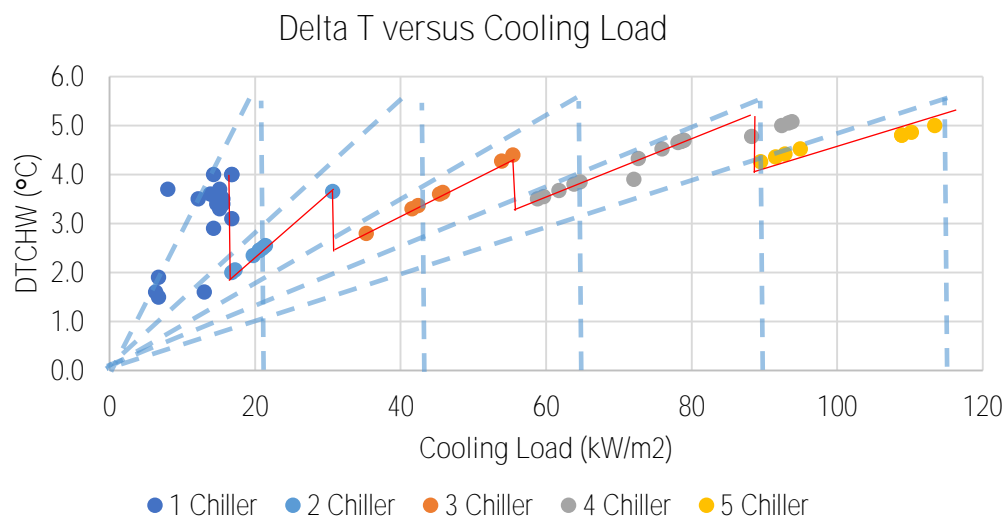

Chart 4: Delta T versus Cooling Load

4.2 Obstacles and limitations

A number of obstacles and limitations were found in the pilot cases which might affect the progress and outcome of this retro-commissioning process.

- Quality of data

As mentioned, the quality of data, including accessibility, format and accuracy is relatively low. This will affect both the process and depth of the study. However, as this is still the norm of the industry for the short and medium term, the Programme is therefore focusing on how to use the data and information available from the limited provisions of instrument in a building.

- Faulty equipment, valves and controls

From the five pilot buildings, a number of equipment which is critical for the control of the system such as valves, temperature control etc. are found to have been seriously deteriorated. A considerable time and effort will be required to rectify those faults before the process can be continued.

- Tenancy commitment

Some tenants, especially for data centre or server room, require a fixed chilled water supply temperature for reliability reasons. However, this limits the reset of chilled water supply temperature. It is worthwhile to consider having a separate system for tenants that has such requirement or provide them with condensing water supply instead of chilled water supply.

- Oversizing of equipment

It was found that a lot of equipment is oversized. Even when they are replacing such equipment, it is uncommon that the capacity of the plant will be reviewed. Although most of the equipment such as pumps and chillers are now provided with variable speed drives, oversizing the equipment will limit the control range and hence the efficiency in part load conditions.

4.3 Effectiveness of ACT-Shop

A survey was carried out with the participants to investigate the effectiveness of the programme and their opinion on the future development of the programme. The results are as below:

Knowledge gained - Participants were asked of the degree of knowledge gained on 11 types of knowledge on retro-commissioning. The feedback is very positive with knowledge gained in all aspects. The two type of **knowledge with the most significant gain are “Key parameters for system control” and “Regular re-tuning”**

Contents of ACT-Shop - **Three types of contents were seen by participants as “Absolutely necessary”.** They are 1 Preliminary system diagnosis; 2 Interpretation of Analysis results and 3 System performance forecasting technique.

In general, knowledge and skill transfer were successfully observed via the Programme. Participants felt that they **become more knowledgeable on their buildings’ HVAC systems and retro-commissioning techniques.** Extra resources of not more than 20% were expected to be needed during the participation of the Programme.. They believed that the Programme duration should be one year or longer. All of them were satisfied with the pilot Programme.

The participants recognised the importance of retro-commissioning, and agreed that there should be trainings for retro-commissioning professionals.

5. CONCLUSION AND THE WAY FORWARD

From this pilot project, we can conclude that

In the participated buildings as mentioned in the previous sections, the lack of equipment for data collection will cause challenges in carrying out retro-commissioning. The low quality data will also increase the difficulties for data analysis. That being said, the Programme has used the readily available data for data analysis. Suggestions have been provided to improve the energy performance of the system and achieve savings on energy and operation cost.

From the survey, through the ACT-Shop, participants have knowledge gain on data collection, data analysis and retro-commissioning. Hence, this participative approach can effectively build up the competence of the industry practitioners in terms of knowledge-based energy management.

The Way Forward

This Programme is well recognised by the Environment Bureau, HKSARG in driving retro-commission to the industry. The Electrical and Mechanical Services Department (EMSD), HKSARG also shows support to the Programme. EMSD will carry out retro-commissioning in Government buildings whilst the HKGBC will be responsible for the private buildings in Hong Kong (Environment Bureau, 2015).

The Programme enables O&M professionals and energy services companies to better identify and actualise the value of retrofitting and retro-commissioning opportunities. This will boost the related demand for such works.

The HKGBC will review the Programme and liaise with EMSD continuously based on our experience and findings within 2017. The Programme is expected to be scaled up to the market in 2018. It will also facilitate the owners of commercial buildings to prepare for the coming energy audit as required by the Building Energy Efficiency Ordinance (BEEO).

REFERENCES

- [1] ASHRAE, 2012. 2012 ASHRAE Handbook - HVAC Systems and Equipment. 1 ed. Atlanta: American Society of Heating, Refrigeration and Air-Conditioning Engineer, Inc.
- [2] Environment Bureau, 2015. Energy Saving Plan For Hong Kong's Built Environment 2015~2025+.
- [3] Xiao, F., and Wang, S., 2009. Progress and methodologies of lifecycle commissioning of HVAC systems to enhance building sustainability. *Renewable and Sustainable Energy Reviews*, 13(5), 1144-1149.

Low-Carbon Building Environment Adaptation Countermeasures of Pingtung County

CHANG Kuei-feng^a, KO Chien-hung^b, CHEN Ping-hung^c, CHOU Po-cheng^d, HUANG Lin-lin^e

^a Pingtung County Government, Taiwan, a001811@oa.pthg.gov.tw

^b Pingtung County Government, Taiwan, a001481@oa.pthg.gov.tw

^c Pingtung County Government, Taiwan, a001841@oa.pthg.gov.tw

^d Shu-Te University, Taiwan, paul@stu.edu.tw

^e Cheng Shiu University, Taiwan, lin8612@yahoo.com.tw

ABSTRACT

Taiwan established the green building label evaluation system in 1999, and implemented the special label for green buildings of Building Technical Regulations. Since the legalization of green building policy, the "green building" has been popularized to folk buildings. However, as Pingtung is located to the south of Tropic of Cancer, in the southernmost tropical climatic region of Taiwan, in comparison to other counties and cities, the existing green building related criteria are obviously insufficient for the peculiar climate of Pingtung. Therefore, the "green building self-government ordinance of Pingtung County" is stipulated.

According to the climate characteristic and agricultural industry characteristic of Pingtung County, the green concepts of roof insulation, photovoltaic, water-saving facilities, bicycle parking space, permeable pavement and low energy-consuming lamps are proposed. In order to build an energy-saving, healthful and comfortable living environment, responding to local climate, from the site development and building planning and design stages, the **concept of "in harmony with nature" is popularized. The passive design techniques of pervious basal disc, green energy rooftop, vertical greenery, general design and deep shading are used, and effective vents and paths are created.**

The new and existing buildings are divided into five classes, the criteria are made in details, and the new intelligence and new technology are imported actively, such as photovoltaic. The environmental objective for energy saving and carbon reduction is attained, and the value of local industry is increased.

Keywords: green building self-government ordinance of Pingtung County, passive design, in harmony with nature

1. INTRODUCTION

A total of 31 cities in the world were listed in the 2013 global "Smarter Cities Challenge". The renewable energy innovation and application plan, which was proposed by the Taiwan Pingtung County government, was the only selected city in Taiwan. In recent years, Pingtung County has made continuous efforts to become a non-nuclear home, and actively promoted the local production and consumption of renewable energy in order to revitalize the local economy. Taiwan established the green building label evaluation system in 1999, and implemented the special label for green buildings of Building Technical Regulations. Since the legalization of green building policy, the "green building" has been popularized to folk buildings. However, as Pingtung is located to the south of Tropic of Cancer, in the southernmost tropical climatic region of Taiwan, in comparison to other counties and cities, the existing green building related criteria are obviously insufficient for the peculiar climate of Pingtung. Therefore, the "green building self-government ordinance of Pingtung County" is stipulated.

The new and existing buildings are divided into five classes, the criteria are made in details, and the new intelligence and new technology are imported actively, such as photovoltaic. The environmental objective for energy saving and carbon reduction is attained, and the value of local industry is increased.

2. LATITUDE AND LONGITUDE OF THE PLAN

Pingtung County, situated in the southernmost Taiwan, is warm all the year around and enjoys sufficient sunshine. Most of its people are engaged in agriculture and aquaculture. In order to implement and create a non-nuclear home and fuel the economy, from 2011, the county government started to launch green energy demonstration, solar plant on water, stilt houses and other experiments. By virtue of using renewable energy, the government aims to encourage the buildings to be self-sufficient, attain the goal of energy conservation and carbon reduction, form innovative industries and pursue environmental sustainability.

Three important strategies are developed as follows: In terms of land restoration plans, the "water conservation and solar power generation" is popularized. With regard to promoting green energy industry, "bidding-free solar photovoltaics 50 MW". In respect of buildings, "green building self-government ordinance of Pingtung County" is formulated. The breakdown is as follows:

2.1 Water conservation and solar power generation

On August 8, 2009, Typhoon Morakot hit all counties and cities in south Taiwan, and Jiadung and Linbian under Pingtung County in south Taiwan were mostly seriously affected. This area is coastal and low-lying. Worse still, over-pumping of groundwater by illegal aquaculturists contribute to subsidence, giving rise to increasingly severe disasters. Besides, the land in the disaster areas was subject to severe salinization. The well-known "black pearl" wax-apple orchards in Pingtung County were soaked in the water so that the wax-apples could not be grown and people lost their livelihoods. Therefore, Pingtung County initiated the land restoration program of "water conservation and solar power generation" in order to improve the long-standing subsidence, and to use the land affected by the Typhoon Morakot and meanwhile to satisfy people's demand of making a living.

Taiwan's solar photovoltaic systems are mainly set on the roofs of government institutions, schools or general buildings. In the reconstruction areas of Typhoon Morakot in remote mountainous villages, the solar power generation systems are also constructed by the government for the use the public facilities. In the event of serious disasters and traffic disruption, such power can be used as the backup power for emergency rescue communications. This program was authorized in March 2010 by the Council for Economic Planning and Development, Executive Yuan, and the full name was "Program of Building of Solar Photovoltaic Power Generation Systems in Severe Subsidence Areas and Land Damaged by Typhoon Morakot in Pingtung County Government", referred to as "Water Conservation and Solar Power Generation Program".

"Water conservation" is mainly designed to assist the fishermen to change their occupation, not to raise fish and not to withdraw groundwater in order to reduce subsidence, land salinization and other problems. "Solar power generation" means that the fish farms and wax-apple orchard land which cannot be used are leased to power plants. Solar panels are built on the ponds, and under the solar panels are set detention ponds so that the originally subsidised land can be recovered and regenerated. The original farmers growing wax-apple or running fish farms are engaged in "power generation". They serve as the landlord of the power generation areas or the professional managers of the photovoltaic areas. Meanwhile, the use of agricultural land meets economic benefits and the affected land can be used otherwise.

The characteristics of the "water conservation and solar power generation program" are as follows:

- The program is currently the largest commercial solar photovoltaic system application in Taiwan.
- During the implementation of the program, apart from the public authorities playing an important role, the public participation is of greater significance, especially the investment by solar photovoltaic manufacturers. Coupled with the mobilization by local farmers and fishermen, this program is a pioneering undertaking in Taiwan's history of photovoltaic industry development. The program is a cooperation example where the local governments, industries, enterprises, communities, farmers and fishermen jointly participate to create a friendly environment, make use of green energy and promote sustainable development of the communities. For the photovoltaic manufacturers involved in this program, apart from commercial considerations, they also assume the corporate social responsibility of returning their hometown.
- The county government acts as an agency and invests in the manufacturers and farmers landlord to safeguard the interests of farmers and help the manufacturers to successfully obtain investment land. The

mutual cooperation between the farmer landlords and the investors shall be subject to the contractual matters signed by both parties. The outline is as follows:

- The development is based on the agricultural land of small farmers, and the land can be filled and recovered, so that land use can gain economic efficiency. The revenue from the power generation is used to pay the rent for farmers and fishermen so that farmers and fishermen can make a stable livelihood, promoting transformation of land use and benefiting land restoration.
- With the investment in preventing warming and avoiding disaster, solar power generation facilities are ground-based for land protection and disaster preparedness.
- The government helped the investment manufacturers to complete power transmission before December 31, 2011 so that the 2011 photovoltaic electricity wholesale rates are applicable.

2.2 Bidding-free solar photovoltaic 50MW

Pingtung County is a large agricultural county, and its government sets the target of establishing a sustainable living environment and proactively develops green energy industries. Meanwhile, owing to the climate pattern of high temperature and humidity around the year, the poultry farmers in the county often suffers from heavy losses because of avian influenza. In order to reduce the incidence of avian influenza and assist the transformation of the poultry houses, the county magistrate Men-an Pan fought with the Bureau of Energy for the photovoltaic poultry house scheme of bidding-free solar photovoltaic 50MW, and promulgated the code of practice "Inclusion of Building Poultry Houses and Solar Energy by Solar Energy Manufacturers and Poultry Farmers into Bidding-free Scheme". The county government accepts the application for bidding-free schemes.

According to the county magistrate Men-an Pan, fighting for the bidding-free scheme for poultry houses aimed to help the farmers to apply for the licenses to use the poultry houses, receive structural reinforcement and gain extra income besides solar power generation in the ways of the solar energy manufacturers' capital and human resources. For instance, solar panels are equipped on the roof of a 1,500-square-meter poultry house and the capacity is set to be 499KW. The farmers' annual income is about RMB 180,000 for 20 years without bearing the maintenance costs of the solar panels. Solar photovoltaic settings can lower temperature and generate power, and roof can receive 20-year leakage-proof and protection. Besides, the farmers can gain additional income by renting the roof.

2.3 Green building self-government ordinance of Pingtung County

This self-government ordinance aims to implement green building design in all types of target buildings and to respond to the local hot climate, and by renewable energy, greening, energy conservation, environmental design and other ways to create exclusive negative carbon equations of the county and make the county become a carbon and disaster-reduction township-type livable county. In January 1, 2016, the ordinance was announced to be implemented. The publicly-owned and public buildings meeting the targets are taken as the key demonstrations to develop local green buildings and promote a living environment of green buildings.

In order to build an energy-saving, healthful and comfortable living environment, responding to local climate, from the site development and building planning and design stages, the concept of "in harmony with nature". PASSIVE DESIGN techniques are encouraged, such as pervious basal disc, green energy rooftop, vertical greenery, general design and deep shading. Also, effective vents and paths and paths are created. In terms of operation methods, green concepts are proposed, such as "roof insulation", "solar photovoltaics", "water-saving facilities", "bicycle parking space" and "low energy-consumption lighting".

The draft self-government ordinance consists of a total of 29 provisions, and the applicable buildings are divided into five categories, and summarized as follows.

- The first type of buildings: Refer to the public new buildings. The buildings are excluded whose budget has been examined and approved prior to the implementation of this self-government ordinance or whose project costs are less than NTD 30 million. The significance of demonstration and public education can be effectively attained through large-scale public sector buildings. Such buildings can serve as a benchmark.



The provided items are as follows: "The roof a building shall be equipped with insulation layer and solar photovoltaic power generation facilities or roof greening facilities", "garbage disposal facilities and garbage storage space shall be furnished within the site", "water-saving toilets shall be adopted in the buildings", "bicycle parking space shall be equipped", "an elevator carrying both personnel and bicycles or bicycle parking space shall be furnished", and "power lines and traffic lines for electric vehicles (motorcycles) shall be reserved in the site".

- The second type of buildings: Refer to the newly-constructed buildings and newly-constructed buildings with over 16 floors applied in accordance with the Regulations for the Multi-purpose Land Use of Public Facility on Urban Planning and the provisions of Chapter 15 Integrated Design of Building Site in Urban Area formulated by the Building Design and Construction under Building Technical Regulations.

The majority of such second types of buildings are "multi-purpose integrated design" and "large-scale congregate housing". They are the buildings which the county people are most closely connected to. The existing studies suggest that the total life cycle carbon emissions of large-scale congregate housing are no less than those of the office buildings. Such buildings can find their ways into people's daily lives by virtue of "green roof", "water-saving appliances and facilities", "bicycle parking space" and design. In this way, people's living habits can be gradually changed, and the next generation can become environment-friendly.

Basically, the requirements for the second types of buildings are similar to those for the first types of buildings. The additional requirements are as follows: Garbage disposal facilities and garbage storage space shall be furnished in the buildings of more than 16 floors", "the utilization rate of green building materials by buildings' interior decoration materials, floor materials and windows shall exceed 45% of total area", and "the bicycle parking space with management functions shall be furnished".

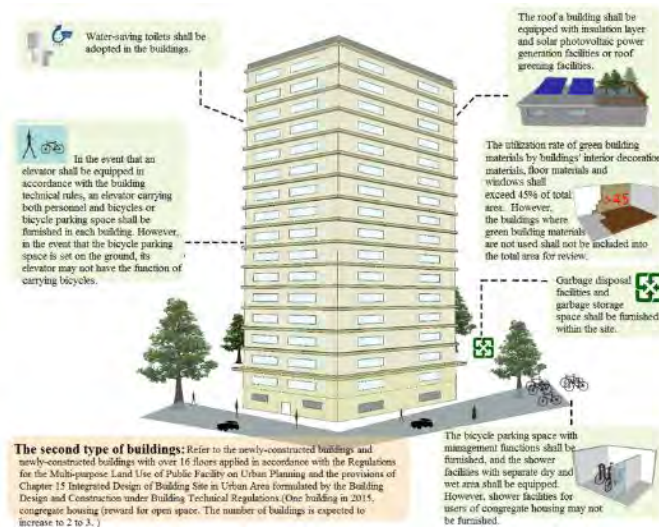

- The third type of buildings: Refer to the newly-constructed factory buildings applied in accordance with the provisions of Chapter 14 Comprehensive Design of Building Site in Urban Area formulated by the Building Design and Construction under Building Technical Regulations. But the site whose floor area is less than 1,000 square meters shall be excluded.

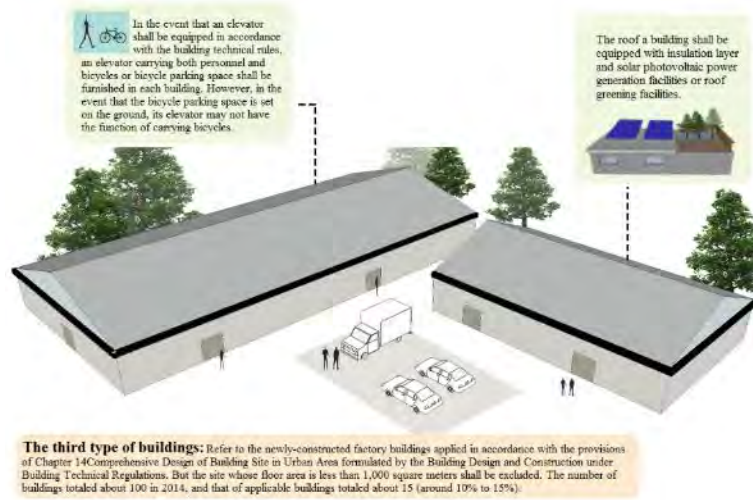

Factories are featured by "heavy electricity consumption". Additionally, compared with metropolitan cities and counties, Pingtung County has a low land density, and is an important area for building factories. As a result, substantial results can be anticipated by improving the design and use habits of factories. There are only two provisions of such buildings as follows: "The building roof shall be equipped with solar photovoltaic power generation facilities or roof greening facilities" and "water-saving toilets shall be used throughout the buildings".

- The fourth type of buildings: Refer to the newly-constructed buildings, except the above-mentioned three types of buildings, and the site's construction area exceeds 200 square meters.

Most of such buildings are small and medium-sized public facilities and shops and most easily reached by the public in life. When such buildings are constructed, the design of new concepts is included. The buildings bring substantial economic benefits to the businesses, and produce a subtle influence on people. It is expected that the concept of healthy and sustainable building environment is integrated into people's life, and can be naturally presented in the county's philosophy of life.

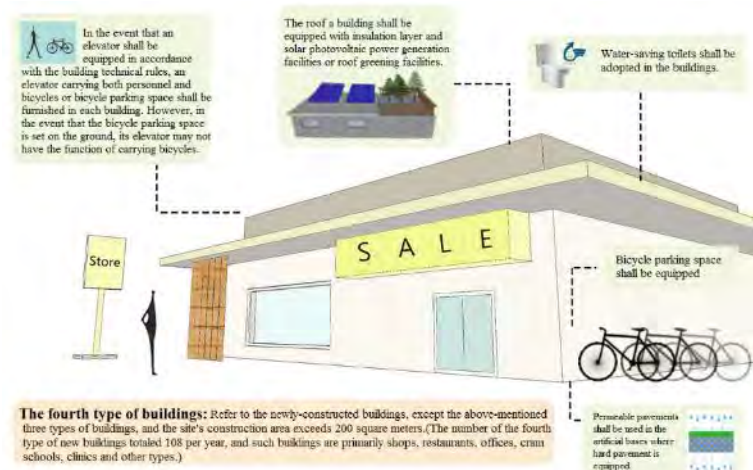

The provisions of such buildings are similar to the foregoing provisions: "The roof of a building shall be equipped with insulation layer and solar photovoltaic power generation facilities or roof greening facilities", "water-saving toilets shall be used throughout the buildings", and "bicycle parking space shall be equipped". The special provision is that "permeable pavements shall be used in the artificial bases where hard pavement is equipped".

- The fifth type of buildings: Buildings with a usage license. That is, the specifications of improving the existing buildings. Since an application for "interior decoration permit" shall be filed in accordance with provisions when the buildings for public use are subject to change of use and interior decoration (Interior Decoration Management Method, 1996), it is stipulated that "new and existing lamps within the application scope shall not be high energy-consuming during application for interior decoration of buildings". The people are encouraged to turn to green buildings during decoration and alteration.

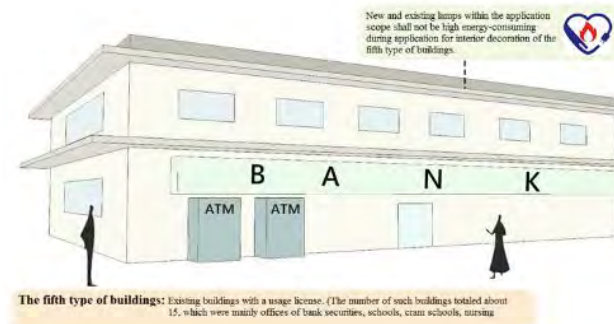

3. CONCLUSION AND RECOMMENDATIONS

It is projected that through this policy, 3.1 million kWh of electricity/ year can be saved each year (for the total electricity consumption of 900 households in a year). 2,190 tons of water/ year can be saved (approximately one international standard swimming pool). 1,912 tons of carbon/ year can be saved (equivalent to 190,000 trees). The total green area reaches 34,500 m²/ year (about 6 football pitches). Therefore, the overall efficiency is considerable.

The "water conservation and solar power generation" program turns the fish farms with subsidence into power plants, and the disaster areas into an emerging area of ground-based solar photovoltaic systems. Three years after the Typhoon Morakot, the "Black Pearl Hometown" and "Breeding Kingdom" have become a "special area of solar energy industry", thereby allowing Pingtung County to become the county with the largest power generation via solar panels and the involved manufacturers to undertake social responsibility. Presently, the targets of Phase 1 have been attained, but there are still uncertainties in the future development. In particular, whether the central government can provide sufficient economic incentives to electricity pricing structure and green energy policies will be the key to sustainable development of Pingtung County's new industries.

Subsequently, by carrying out supporting policies, the annual carbon reductions will grow by multiplication. Gradually, relevant laws and regulations and subsidy regulations will be updated, such as solar photovoltaic facilities, design feedback of Pingtung, three-dimensional green subsidies, existing green building transformation, smart site design, building green highlights and other related methods, plans and activities. Local buildings for Pingtung are found. The overall township styles are progressively connected. Buildings, be they new, old, public or private, can be involved in green building policy. Popularization of green buildings is implemented. The green building self-government ordinance of Pingtung County will become a leading green building self-government ordinance in townships so as to achieve the goal of carbon reduction and disaster relief and township transformation.

In the future, the government's smart grid policy is implemented, so that the achievements of advanced power generation, transmission and distribution, storage, utilization and management can be implemented into the local construction. Meanwhile, Pingtung County can be successfully built through IBM's global promotion of "smart grid city" and the successful experience in helping urban reconstruction of Japan after earthquake in March 31, 2011.

REFERENCES

- [1] Central News Agency Website.
- [2] Project of Science Communication on New Media - The Latest Knowledge on Electric Technology and the Communication in Social Risks (sponsored by the National Science Council).
- [3] Website of the Department of Urban and Rural Development, Pingtung County Government.

Impact of Energy Recovery Ventilation on the Ventilation and CO₂ Concentration in One Bedroom Condominium in Thailand

Daranee JAREEMIT^a, Panpisu JULPANWATTANA^b, Daranee JAREEMIT^c, Jittapat CHORUENGWIWAT^d

^a Faculty of Architecture and Planning, Thammasat University, Thailand, jdaranee@gmail.com

^b Magnolia Quality Development Corporation limited, Thailand, panpisu_ju@dtgsiam.com

^c Faculty of Architecture and Planning, Thammasat University, Thailand, jdaranee@gmail.com

^d Magnolia Quality Development Corporation limited, Thailand, jittapat_ch@dtgsiam.com

ABSTRACT

Building ventilation provides comfortable environment and maintain acceptable indoor air quality. One bedroom condominium in Thailand commonly uses a split type system with no outdoor air intake, which the room ventilation comes from air infiltration through the envelope components only. Insufficient and uncontrolled ventilation rate from the air infiltration might not provide healthy environment for occupants. This paper evaluates the ventilation performance and carbon dioxide concentration in one bedroom condominium with double occupancy based on the ventilation rate performance (VRP) and indoor air quality performance (IAQP) prescribed in ASHRAE Standard 62.1. The room air exchange rates are calculated via using carbon dioxide as a tracer gas. To improve air quality, the energy recovery ventilator (ERV) is installed and supplies two airflow rates of 40 m³/hr and 60 m³/hr. It is found that, the air exchange rates for the bedroom range from 0.40 - 0.64 ACH with an average value of 0.48 (s.d. = 0.09), which is considered as an airtight envelope. The room carbon dioxide concentration rose up to approximately 2,000 ppm when the ERV was not operated. The calculated ventilation rate of 28 m³/hr following the VRP is not sufficient to maintain carbon dioxide concentrations within 1,000 ppm To maintain acceptable carbon dioxide concentration, the ERV should be operated at 60 m³/hr The increase of air exchange rate through the ERV system does not affect indoor humidity.

Keywords: energy recovery system, CO₂ concentration, indoor environmental quality

1. INTRODUCTION

Most people spend an average of 6-8 hours sleeping a day that about one-third of their life. Sleep is a basic human need and the quality of those hours of sleep plays a significant role on physical health such as learning and memory function. The indoor environment including air temperature, relative humidity, and carbon dioxide concentration level could affect the sleep quality and next-day performance.

For studio and one bedroom types of condominium in Thailand (hot humid climate) typically use a wall mounted split type air conditioning with no outdoor air intake to provide human comfort. The room ventilation during the night time comes from the air infiltration through envelope components only. In addition, with the design for high energy efficient building, the room has built tighter thermal envelope, which decreases the room ventilation rate and consequently increases indoor contaminant concentration. Indoor carbon dioxide concentration can be used as indicator of room ventilation rate. According to the ASHRAE ventilation standard, the target of indoor carbon dioxide concentration should not exceed the local outdoor concentration by more than 650 ppm. The National Institute for Occupational Safety and Health (NIOSH) considers that indoor carbon dioxide level above 1,000 ppm indicates inadequate ventilation.

The energy recovery ventilator (ERV) is one of solution to provide sufficient fresh air to improve the air quality. The warm and moist air is preconditioned via energy transfer process before delivering to the room. The objective of the present study was to evaluate the effect of room ventilation via the ERV unit on indoor carbon dioxide concentration, air temperature, and relative humidity in a bedroom in condominium with double occupancy.

2. METHODOLOGY

The experiment of this research was performed in a master bedroom unit of condominium with an area of 10 m² and 2.7 m ceiling height. A 9,000 Btu wall mount split type air condition provides occupants thermal comfort during occupied period while an ERV unit provides the fresh outside air into the bedroom. The study investigated the ventilation and indoor air quality performance for normal operating (no OA intake) and ventilated room conditions with two different airflow rates of 40m³/hr and 60m³/hr by ERV unit. Two occupants normally lived in the room during 6 pm to 8 am.

The indoor carbon dioxide concentration, air temperature, and relative humidity were continuously monitored with HOBO MX carbon dioxide data logger (accuracy of ± 0.21°C for temperature sensor, ± 50ppm for carbon dioxide sensor, and 2% RH for relative humidity sensor). The data was collected every five minutes interval. Figure 1 presents the instrument location installed in the bedroom. One indoor sensor was placed at 1.10m above floor level, which the location avoided exposure to occupants. Another sensor was attached in front of the exhaust of the ERV unit. Outdoor sensor was located in front of the outdoor air intake damper of the ERV unit. After the occupants left the room, the decay of indoor carbon dioxide concentrations were conducted to determine the room ventilation rate.

The air exchange rates were calculated using a linear regression method as shown in Equation (1), where C_a is the background concentration. $C(t)$ and $C(0)$ are the carbon dioxide concentration at time t and 0, respectively.

$$\ln(C(t) - C_a) = -At + \ln(C(0) + C_a)$$

Equation 1



Figure 1: The experiment room and the physical measurements

3. RESULTS AND DISCUSSION

This part shows the comparisons of measured ventilation rates including air infiltration, which influences the indoor environment performance. The investigated results are also compared with the standard recommended limits.

3.1 Room ventilation rate

This present study used carbon dioxide concentration as a tracer gas and the concentration decay data after occupants left the room was used to determine the room air exchange rates. Figure 2 presents the measurement results of indoor and ambient carbon dioxide concentrations for three days during occupied and unoccupied hours when the room operated at normal condition (no OA intake). From the figure, the concentration level rose up to 2,400 ppm. The local outdoor carbon dioxide concentrations typically ranged from 400 - 500ppm. Thus the indoor concentrations should be below 1,000-1,200ppm as defined in the ASHRAE Standard 62.1 - 2010 and NIOSH. Figure 3 shows the concentration decay data when the ERV unit supplied outdoor airflow rate at 40m³/hr and when the unit was switched off (no OA intake) after the occupants left the room in daytime. The room had perfectly well-mixed condition, which an average error of carbon dioxide concentration measured in the room and at exhaust was 4 percent.

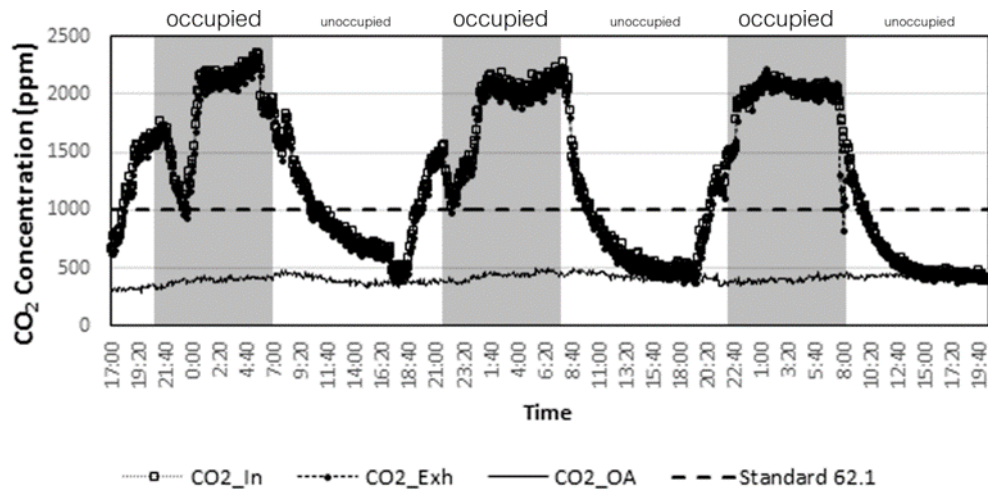

Figure 2: The measured ambient and indoor carbon dioxide concentrations for normal operating condition

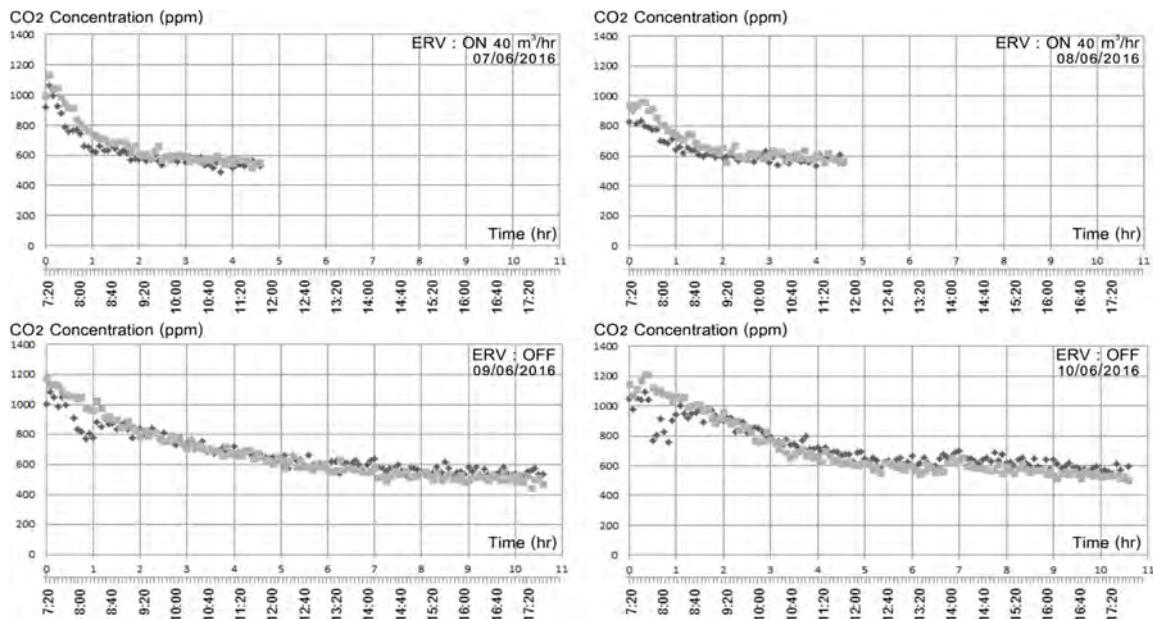

Figure 3: The plot of carbon dioxide concentration decay when the occupants left the tested room at various OA rates

The calculated air exchange rates used optimal regression analysis method. The concentration data was plotted on axes of $\ln C(t)$ against time, t , as prescribed in the ASTM E741 - 2011. In Figure 4, the sample of carbon dioxide concentration decay data when the ERV was switched off (no OA intake) is presented in graph (1) and (2) and graph (3) and (4) illustrates the concentration when the ERV supplied 40 m³/hr outdoor airflow rates. The data typically follows a straight line with a small scatter. From the figure, when the ERV unit was switched on, the indoor carbon dioxide concentration took approximately 2 hours to reach the background concentration that was faster than those for normal operation, which took 3 - 5 hours.

For normal operating condition (no OA intake), the room air exchange rate represented the air infiltration through envelope leakage areas and penetrations since the room has no outdoor air intake from the split type unit. The calculated air exchange rates range from 0.40 - 0.64 h⁻¹ (an average value of 0.48, s.d. = 0.09), which was lower than the required ventilation rate of 1.07 h⁻¹ (28 m³/hr) calculated based on the ventilation rate procedure (VRP) prescribed in ASHRAE Standard 62.1 – 2010. The operation of ERV unit with supplied 40m³/hr outdoor airflow rates can provide acceptable ventilation rate of 1.5 h⁻¹. Figure 5 presents the calculated air exchange rates for normal operating condition and operating ERV unit with outdoor airflow rate of 40m³/hr.

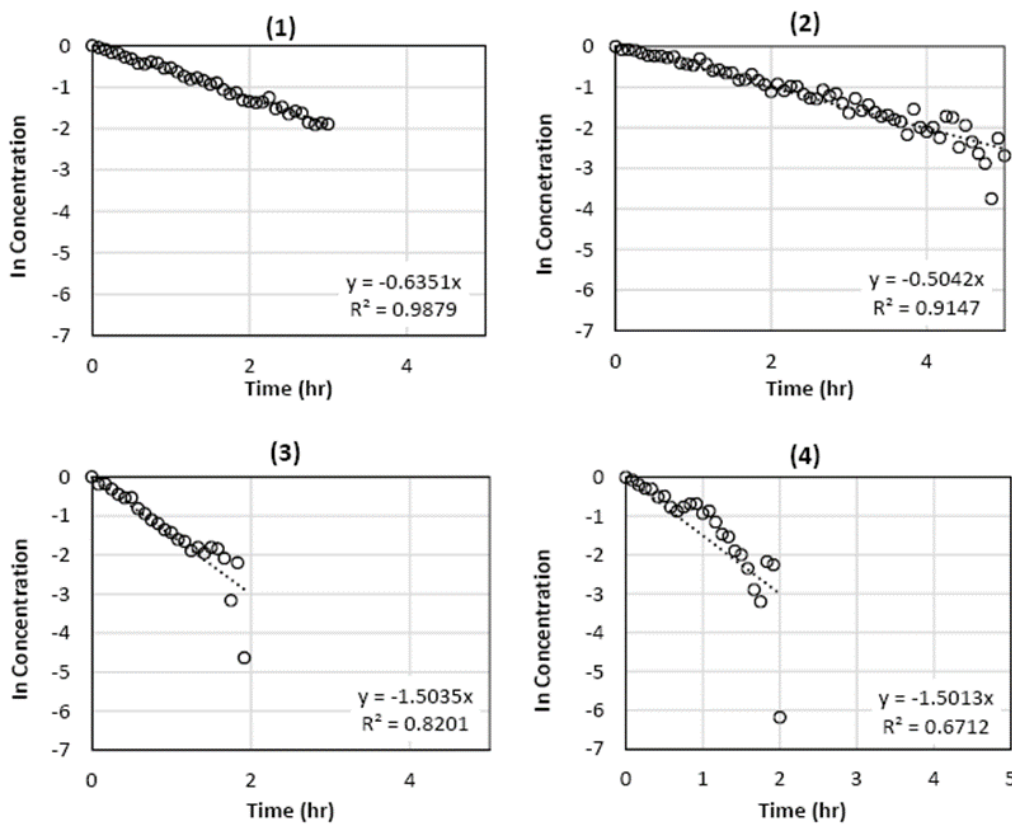

Figure 4: Linear regression analyses for carbon dioxide concentration decay when the ERV supplied outdoor air at 40m³/hr and no outdoor air intake

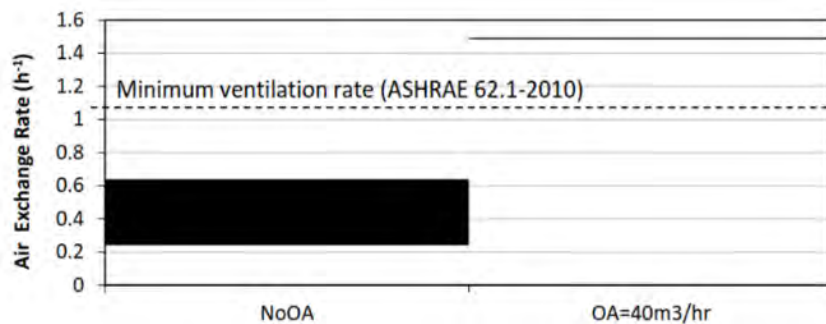

Figure 5: The range of air exchange rates for normal operating condition and the rate for ventilated room with outdoor airflow rate of 40m³/hr.

Considering the envelope air tightness as prescribed in the CIBES Guide A, the room is considered having an airtight envelope, which the air infiltration rates ranging from 0.40 - 0.64 h⁻¹. Such investigated air infiltration rates have the same range when compared to those calculated in modern Thai houses and is considerably lower than the infiltration rate for a traditional Thai house as shown in Figure 6.

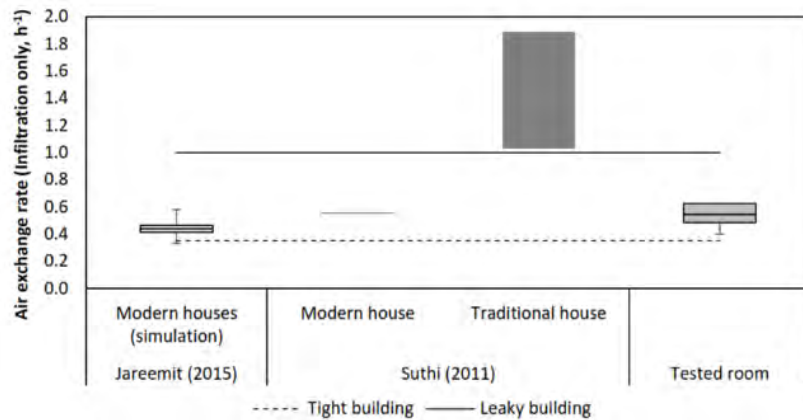

Figure 6: A comparison of air infiltration ranges observed in the tested room and Thai houses.

3.2 The effect of air exchange rates on indoor carbon dioxide concentrations

Figure 7 presents the box plots show the 25th to 75th percentile of the indoor carbon dioxide concentrations with different supplied outdoor airflow rates at 0m³/hr (no OA intake), 40m³/hr, and 60m³/hr by ERV unit when two occupants normally lived in the room during night time; the line in the box shows the median; the circle shows the average. For normal operating condition during occupied period, the indoor carbon dioxide concentration measured in the room exceeded 1,000 ppm (an average value of 1,721 ppm) as recommended in the standard health guidelines. During the week that the ERV unit was operated at 40m³/hr, the indoor carbon dioxide concentrations during the occupied hours were reduced to half with an average value of 930 ppm. During the ERV unit was operated at supplied 60 m³/hr outdoor airflow rate, the carbon dioxide concentrations ranged from 750 – 1,100 ppm (an average value of 853 ppm); however, some of those were higher since the occupants did not switch on the ERV unit.

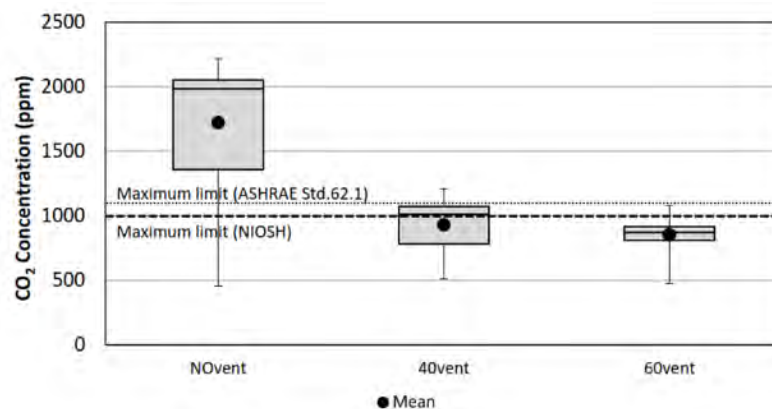

Figure 7: The distributions of measured carbon dioxide concentrations at different outdoor airflow

3.3 The effect of ERV operation on indoor temperature and relative humidity

The indoor air temperature and relative humidity were also measured during the test period. Normally, the room air temperature was controlled within 23 - 28°C with an average value of 24.7°C and the relative humidity ranges from 57 - 75 percent (an average value of 70.4 percent) as shown in Figure 8. Overall, the ERV unit effectively controls moisture content from warm and humid air from outside. Thus, the adjusted outdoor airflow rates slightly affect the room air temperature and relative humidity.

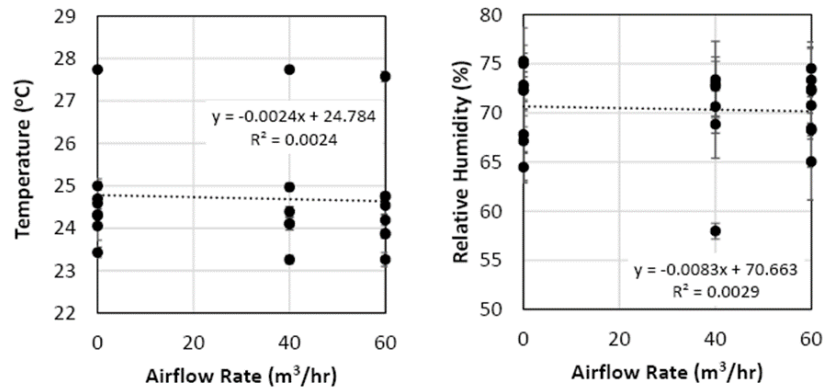

Figure 8: An influence of adjusted outdoor airflow rates on indoor air temperature and relative humidity

4 CONCLUSION

This present study evaluates the indoor carbon dioxide concentrations and thermal performances with various outdoor air intake rates brought through the energy recovery ventilator unit. The operated outdoor airflow rate at 40 m³/hr provided acceptable ventilation rate following the ventilation rate procedure (VRP), which can reduce the indoor carbon dioxide concentration into the half of the concentration in normal operation. However, it is insufficient to provide adequate ventilation rate, which controls indoor carbon dioxide concentration below the recommended limit as defined in the indoor air quality procedure (IAQP). To maintain the carbon dioxide concentration level within the maximum limit, the ERV unit should be operated at maximum capacity with the supply outdoor airflow rate at 60 m³/hr. Overall, the ERV unit provides pretty good controlled air ventilation. Introducing outdoor air intake through the ERV unit slightly affects the change in room temperature and indoor relative humidity. However, the operation at high flow rates could make nuisance sound and lead high energy consumption. Future studies should investigate how occupant's satisfaction with the noise caused by the system operation and the impact of increasing ventilation rates on energy consumption.

ACKNOWLEDGEMENT

This research was supported by Magnolia Quality Development Corporation Limited. The authors are grateful for the effort contributed by Thanyaluk Sriratanachot and the research team from the Faculty of Architecture and Planning, Thammasat University.

REFERENCES

- [1] NIH, 2012. Why Is Sleep Important? - National Heart, Lung, and Blood Institute. URL <https://www.nhlbi.nih.gov/health/health-topics/topics/sdd/why>.
- [2] NIOSH, 2002. Health Hazard Evaluation (HHE) Report. National Institute for Occupational Safety and Health.
- [3] ASTM, 2011. ASTM E741, Test method for determining air change in a single zone by means of a tracer gas dilution. ASTM International.
- [4] Chartered Institution of Building Services Engineers, 2006. Environmental design: CIBSE guide A. CIBSE, London.
- [5] Jareemit, D., 2015. Uncertainty distribution of air infiltration rates of Thai detached homes for energy model. JARs 12(2), 39–51.
- [6] Suthi, K., 2001. Impacts of air infiltration on cooling energy use of Thai house (Master thesis). Chulalongkorn University
- [7] ASHRAE, 2010. ANSI/ASHRAE Standard 62.1-2010, Ventilation for acceptable indoor air quality. American Society of Heating, Refrigerating and Air-Conditioning Engineers, Inc.

Session 5.10: Zero Energy

Achieving Net Zero: A Case Study of Hong Kong's First Zero Carbon Building

Justin LI^a, Margaret KAM^b

^a Construction Industry Council, Hong Kong SAR, justinli@hkcic.org

^b Construction Industry Council, Hong Kong SAR, margaretkam@hkcic.org

ABSTRACT

In line with the urgent international agenda to reduce carbon emissions and mitigate climate change, Hong Kong has pledged to reduce its carbon intensity by 50-60% by 2020. To achieve this target, there is a need to reduce **the electricity consumption in buildings which contribute to 60% of the city's carbon emissions. Net Zero Energy Building (NZE) and Net Zero Carbon Building (NZCB) are key approaches to meet energy and carbon reduction goals. To lead the effort to reduce energy and carbon intensity, the Construction Industry Council (CIC) constructed ZCB—the first zero carbon building in Hong Kong. ZCB showcases** passive design, energy efficient active systems and explores some new possibilities in renewable energy generation in Hong Kong such as trigeneration using biodiesel. With over three years in operation, this paper presents an evaluation of ZCB's energy and carbon performance based on actual performance data.

This paper will first examine the concepts of NZE and NZCB in tackling climate change. The designed and operational energy and carbon performance of ZCB over its first three years of operation is then presented with experiences and lessons learned. The feasibility of achieving zero energy/carbon in a subtropical climate is then considered within the broader context of practice, policy and development of a low carbon built environment in Hong Kong. Having achieved energy positive status in 2015, the design, construction and operation of ZCB demonstrates that zero carbon building is a potential strategy to abate greenhouse gas emissions. However, careful consideration of operational use, ongoing testing and commissioning, occupant comfort and satisfaction, reliable renewable energy generation and ongoing monitoring, diagnosis and correction are critical for effective performance.

Keywords: building performance, Net Zero Energy Building, Net Zero Carbon Building, subtropical climate

1. CLIMATE CHANGE AND NET ZERO

There is an urgent need to minimise the impacts of construction sector activity on the natural environment and to develop low carbon cities (DCLG, 2007; Environment Bureau, 2015a). Having reached an unprecedented first ever-binding agreement to combat climate change at the Paris climate conference (COP21) in December 2015, 195 participating nations are committed to actions and investments toward low carbon economies. The Paris Climate Agreement aims to limit global warming to well below 2°C with a long-term goal of net zero emissions for this century (UNFCCC, 2016).

To reduce carbon emissions, Hong Kong aims to reduce its carbon intensity by 50-60% by 2020 (Environment Bureau, 2015a). In line with this goal, the Hong Kong SAR Government has also launched an "Energy Saving Plan for Hong Kong's Built Environment (2015-2025)" (Environment Bureau, 2015b), which outlines the Government's energy saving policy, strategy and targets. A target is to reduce Hong Kong's energy intensity by 40% by 2025 relative to the 2005 baseline. NZE and NZCB are recognised as viable approaches to help reduce energy use and carbon emissions in the built environment (Cole, 2015; Crawley *et al.*, 2009; Deng *et al.*, 2014).

2. TOWARDS NET ZERO

There is a growing number of NZEs and NZCBs worldwide (Dean, 2014; Pena, 2014; Reeder, 2016) and an increasing net zero certifications (ILFI, 2016). Some of these examples are even energy positive and recent trends have seen a shift to the concept of regenerative design in buildings and developments (Hes and Du Plessis, 2015). Most examples of NZEs and NZCBs are located in relatively cool or temperate climates. There are relatively

fewer examples in a subtropical climate, more particularly, in a highrise and densely populated city such as Hong Kong.

Hong Kong is characterised by a subtropical climate—hot humid summers and mild to cool winters (Hong Kong Observatory, 2015). The typical cooling season in Hong Kong is estimated at 2000 degree-hours, which differs quite significantly to London's 200 degree-hours for example. Meeting the cooling demand for buildings is therefore a significant challenge in Hong Kong (Cheng *et al.*, 2014). Integrating NZEB and NZCB design strategies and technologies that perform effectively in a hot humid subtropical climate is therefore critical.

3. FIRST ZERO CARBON BUILDING IN HONG KONG

The CIC ZCB aims to achieve zero carbon emissions through balancing the energy consumed with energy generated from renewable energy sources on an annual basis. Surplus renewable energy generated is used to offset the embodied carbon of its construction process and major construction materials. Completed in June 2012, ZCB is a 1400m² building situated on a 14700m² site in the industrial and commercial district of Kowloon Bay. It is a three-storey exhibition, education and information centre with indoor and outdoor exhibition facilities, an eco-office, meeting rooms, an eco-home, a multipurpose hall, an eco-cafe and shop. The building is surrounded by an open landscape area with an urban native woodland. Over 50,000 visitors have toured ZCB since its official opening in January 2013. In 2015 alone, there were visitors from over 400 local and overseas organisations including educational institutions, community organisations, professional groups and government departments.

ZCB's energy strategy combines passive design, active systems and onsite renewable energy generation. Over eighty technologies based on principles of sustainable site planning, energy use reduction, low carbon construction and material selection, water use minimisation, building flexibility and adaptability have been integrated into ZCB. 2800 sensors installed throughout the building monitor key environmental performance parameters. Information including carbon dioxide levels, temperature, humidity, renewable energy generation, energy consumption, energy import and surplus energy export to the electricity grid, is collected by the Building Management System (BMS). This data is evaluated to identify areas for energy performance improvements and to optimise operational performance.

4. PERFORMANCE EVALUATION OF ZCB

4.1 Designed performance

The energy demand for ZCB and its surrounding landscape area was expected to be 116MWh/year and 15MWh/year respectively as shown in Figure 1 below.

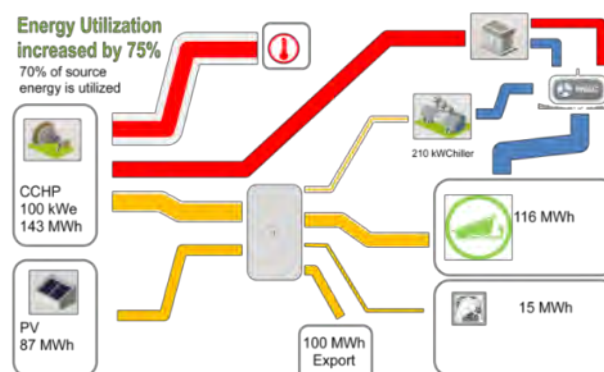

Figure 1: Designed energy performance

The photovoltaic (PV) systems and the Combined Cooling Heating and Power (CCHP) system or tri-generation using biodiesel (B100 waste cooking oil) were estimated to produce 87MWh/year and 143MWh/year respectively. A projected 100MWh/year surplus electricity would be exported to the local grid to offset the embodied carbon accrued during the construction process and for major construction materials. This equates to a carbon reduction of about 45-50 tonnes/year over an assumed 50 year building lifespan as shown in Figure 2.

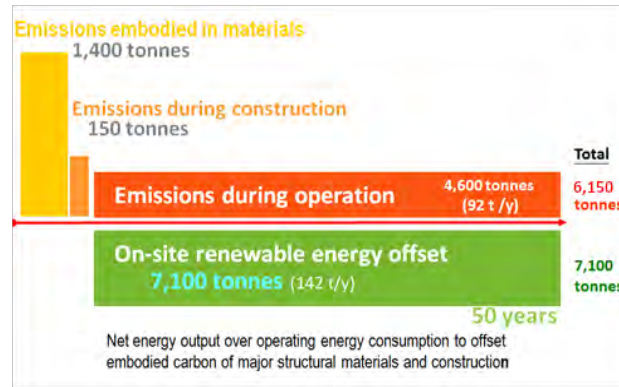

Figure 2: ZCB's carbon strategy

4.2 Operational performance

Three energy audits conducted for ZCB over 2013-2014, and daily monitoring, led to continuous testing and commissioning to finetune the operation of different building services systems. Thus in 2015, ZCB's total renewable energy generation (377MWh) exceeded total energy consumption (355MWh). This resulted in a carbon footprint of -16 tonnes for 2015. Overall, the average yearly energy consumption for 2013-2015 was 339MWh/year—160% over the design estimate of 131MWh/year. The designed and actual energy consumption for 2013, 2014 and 2015 are shown in Figure 3. The following factors can be seen to contribute to this performance gap:

- ZCB is currently operating 7 days a week resulting in an approximate 40% increase in energy consumption over the designed estimate for a 5 day operation week. It has been estimated that 90MWh/year of electricity is consumed for the 2 extra days per week;
- Minor energy consumption was assumed for non-operation hours (19:00 to 08:00) for lighting and power, however actual energy consumption accounted for 22% of total daily energy consumption in summer, and 30% in winter. A base load of 18-20kW was measured for a typical daily lighting and power load profile;
- Higher than expected energy consumption related to non-essential services such as landscape lighting and plumbing and drainage. There is also higher than expected basement plant floor energy consumption.

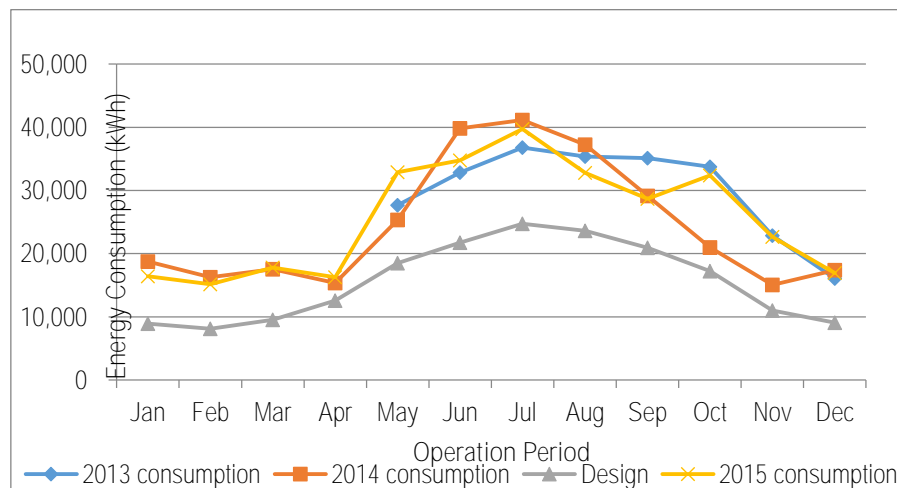

Figure 3: Monthly energy consumption

Renewable energy generation was 14% below the design target for 2013-2014. The CCHP system suffered major breakdowns from May-June 2013 and from August-November 2014. As a result, there was a shortage in energy generation compared with the original design target (Figure 4). In 2015, overall energy generation was 11.5% above the design target. This was mainly due to smooth operation of the system and extension of system operation beyond summer months (May-September) to all year round. PV energy generation is shown in Figure 5. The three types of PV systems (polycrystalline, building integrated PV and CIGS) generated 106MWh of electricity in 2013, 107MWh in 2014 and 105MWh in 2015. This exceeded the predicted annual output of 87MWh by 22%, 24% and 21% respectively.

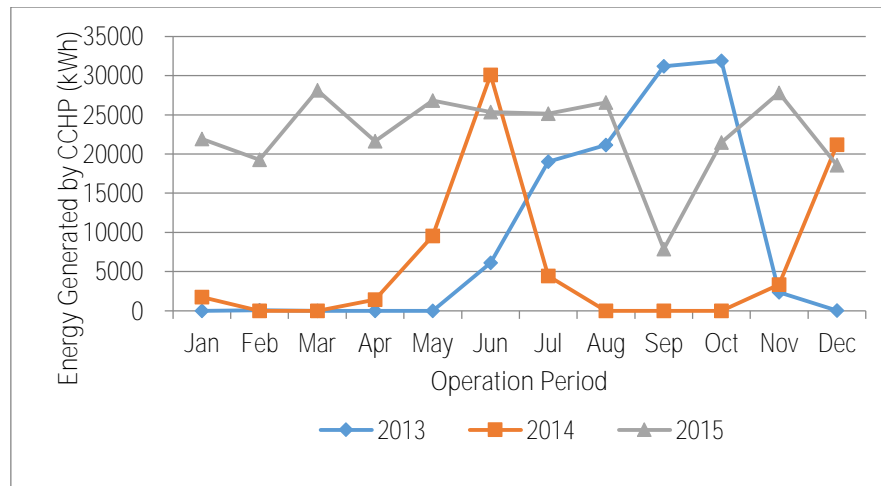

Figure 4: Monthly energy generation by the CCHP system

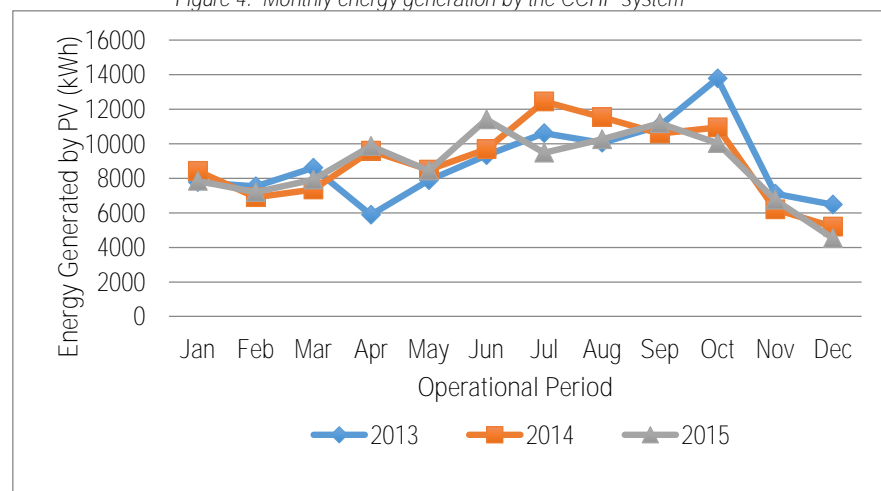

Figure 5: Monthly energy generation by the PV systems

5. EXPERIENCES AND LESSONS LEARNED

5.1. Designed vs. operating target

A major factor that contributed to the current energy performance gap is the disparity between the intended 5 day and actual 7 day use of the building resulting from the demand for ZCB facilities. A significant challenge arising from the evaluation of ZCB is how to accommodate increased activities and changes in operational needs over time while striving to achieve the zero carbon objective. Studies into the performance of NZEBs and NZCBs have found that there is often a wide gap between design objectives (simulated building energy use) and actual measured performance (actual energy consumption). Measured energy consumption can be up to 3.5-5 times initial design estimates (Carbon Trust, 2012). This is often attributed to buildings rarely having a realistic design stage energy use prediction against which operational energy use could be compared. Corney *et al.* (2014) assert that net zero energy and carbon is 'more about designing a building to an operating energy target and then achieving that target'. Post occupancy evaluation and periodic feedback is therefore critical to improve building performance and to the development of future energy use models. Further analysis to examine the effects of different types of activities or uses on ZCB's energy and carbon performance will be carried out.

5.2. Ongoing testing and commissioning

ZCB underwent extended testing and commissioning since its opening in January 2013. Most prominent was the ongoing testing, fine-tuning and performance optimisation of various components of the CCHP system (including the biodiesel generator, pumps, cooling towers and adsorption chiller). Delays in procurement of replacement parts and contractor inexperience in rectifying problems contributed to lengthy gaps in operation. This resulted in a generation shortfall of 36% for the system in 2013-2014. Contingencies should be provided for building systems not operating as designed. A strategic maintenance strategy should be established with preventive measures,

ongoing commissioning, and re-commissioning to align with changes in the operating environment and to improve systems performance over time.

5.3. Occupant behaviour, comfort and satisfaction

Balancing the goal of zero carbon with creating a comfortable indoor environment is a significant challenge. ZCB **is naturally ventilated in the spring, autumn and winter months—accounting for 40% of the year in 2013, 50% in 2014 and 40% in 2015.** However, staff showed dissatisfaction with the thermal comfort level in the building when indoor temperatures on occasion reached a low 9-10°C in winter, and a high of 28-29°C in summer, while the postulated internal comfort range is 18-25.5°C. Opened windows in winter created uncomfortable workspaces. Unanticipated plug loads, including portable heaters in winter and portable fans in summer to attain the desired level of thermal comfort, point to differences in individual preferences and automated controls and temperature set points. Further effort is needed to align user expectations with the zero carbon objective. Periodic user feedback, further education, and behavioural changes are critical to achieve a more optimal balance between the zero carbon objective, a more comfortable indoor environment, and sustainable building operations.

5.4. Reliable renewable energy generation capacity

Reliable renewable energy generation play a critical role in achieving the zero carbon objective. Although the CCHP system underwent trouble shooting and rectifications in 2013-2014, the system generated 272MWh of energy in 2015, almost doubling the designed figure of 143MWh. The facility management staff learned a great deal about the maintenance procedures for the biodiesel generator, the frequency for refueling, optimal water temperatures etc. Balancing the risk of applying more innovative and experimental systems with more tried and tested methods to achieve zero carbon emissions is a significant challenge. With careful consideration for significant overshadowing from surrounding tall buildings during the winter time, the performance of the three PV systems at ZCB exceeded designed output. The suitability and effectiveness of renewable energy systems for a specific site or context is therefore a critical consideration to maximise energy generation.

5.5. Ongoing monitoring, evaluation and performance improvements

An extensive monitoring and data collection system led to complexity in data analysis and interpretation. Consideration should be given to the ease of BMS data extraction for frequent reporting and feedbacks for facility managers and building users on actions to improve operational performance. The scope and level of detail for performance evaluation should also be carefully defined at project outset such that the BMS framework and electrical systems are initially set up to facilitate this process. A new data extraction and analysis system is being installed at ZCB to facilitate more timely analysis and optimisation of systems and technologies.

6. IMPLICATIONS FOR THE HONG KONG CONTEXT

ZCB highlights a number of factors that pose significant challenges for the wider application of NZEB/NZCB principles, systems and technologies in Hong Kong. One factor is whether passive design integrating natural ventilation is a widely applicable strategy in Hong Kong's subtropical high density environment with potentially high levels of humidity, air and noise pollution in Hong Kong. The feasibility of large scale applications of PV systems when overshadowing is common in a highrise environment is another critical consideration. Such limitations to the application of passive design strategies and renewable energy options significantly influence whether net zero energy or carbon can be easily achieved in Hong Kong.

The regulatory and policy framework and the energy infrastructure could be further developed to facilitate the wider adoption of NZEBs and NZCBs in Hong Kong. The application of a new CCHP system with grid feed-in at ZCB highlighted that incentives for grid feed-in could support wider adoption and rebates could help to develop the markets for NZEB/NZCB technologies. Another challenge is how zero energy/carbon principles, systems, technologies and lessons learned from ZCB could be transferred to highrises. More demonstration projects for different building types would be needed. Furthermore, there is untapped potential for applications in the renovation of existing buildings which constitute majority of the building stock in Hong Kong. The ZCB experience also identified the importance of upgrading contractor skills and improving facility management knowledge and user understanding for effective building delivery and operations. There is also scope to develop the business case,

stimulate the private sector, collate and disseminate operational and financial performance data, educate for behavioural change, and to develop zero carbon building policies for a low carbon Hong Kong.

7. CONCLUSION

As a demonstration project, ZCB has shown that the objectives of zero energy and zero carbon can be successfully achieved in Hong Kong. Although implications for highrise buildings in a high density urban context remain to be seen, the insights gained, lessons learned, and potentially applicable solutions in a subtropical climate, is a significant point of departure for further development of strategies for highrises. Projects and research in Hong Kong should investigate beyond current concepts of NZEBs and NZCBs to more recent concepts of net positive energy buildings and regenerative design as well as applications for renovations of existing buildings. Further investigations into how economic, behavioural and social criteria with policy efforts can support the diffusion and implementation of these concepts are needed.

REFERENCES

- [1] Carbon Trust, 2012. Closing the gap: Lessons learned on realising the potential of carbon building. Retrieved from: <https://www.carbontrust.com/media/81361/ctg047-closing-the-gap-low-carbon-building-design.pdf> [Retrieved on 30 July 2016].
- [2] Cheng, V., Lam, T., Ng, T. and Yau, R., 2014. The CIC ZCB: designing a zero carbon building for a hot humid climate. *The Arup Journal*, 1, 72-81.
- [3] Cole, R.J., 2015. Net-zero and net-positive design: a question of value. *Building Research & Information*, 43(1), 1-6.
- [4] Corney, A., Mead, D., Shepherd, A. and Dougherty, L., 2014. 'Net Zero Carbon in California: The Conrad N Hilton Foundation Headquarters', paper presented at the Zero Carbon Buildings Today and in the Future Conference, Birmingham University, 11-12 September.
- [5] Crawley, D., Pless, S. and Torcellini, P., 2009. Getting to net zero. *ASHRAE Journal*, 51(9), 18-25.
- [6] Dean, E., 2014. Zero net energy case study buildings, Pacific Gas and Electric Company, San Francisco. Retrieved from: https://energydesignresources.com/media/19864463/zne_case_study_buildings-11.pdf?traced=true [Retrieved on 1 May 2016].
- [7] Deng, S., Wang, R.Z. and Dai, Y.J., 2014. How to evaluate performance of net zero energy building - A literature research. *Energy*, 71, 1-16.
- [8] DCLG, 2007. Building a Greener Future: policy statement. Department for Communities and Local Government. Retrieved from: <https://www.rbkc.gov.uk/PDF/80%20Building%20a%20Greener%20Future%20Policy%20Statement%20July%202007.pdf> [Retrieved on 24 June 2016].
- [9] Environment Bureau, 2015a. Hong Kong Climate Change Report 2015, Environment Bureau, Hong Kong. Retrieved from: <http://www.enb.gov.hk/sites/default/files/pdf/ClimateChangeEng.pdf> [Retrieved on 5 May 2016].
- [10] Environment Bureau, 2015b. Energy Saving Plan for Hong Kong's Built Environment 2015-2025, Environment Bureau, Hong Kong. Retrieved from: <http://www.enb.gov.hk/sites/default/files/pdf/EnergySavingPlanEn.pdf> [Retrieved on 1 May 2016].
- [11] Hes, D. and Du Plessis, C., 2015. *Designing for Hope: Pathways to Regenerative Sustainability*. Routledge, New York.
- [12] ILFI (International Living Future Institute), Living Building Challenge - Case Studies [Online]. Retrieved from: <http://living-future.org/casestudies> [Retrieved on 25 August 2016].
- [13] Hong Kong Observatory, Climate of Hong Kong [Online]. Retrieved from: http://www.hko.gov.hk/cis/climahk_e.htm [Retrieved on 15 July 2016].
- [14] Reeder, L., 2016. *Net Zero Energy Buildings: Case studies and lessons learned*. Routledge, New York.
- [15] UNFCCC (United Nations Framework Convention on Climate Change), The Paris Agreement [Online]. Retrieved from: http://unfccc.int/paris_agreement/items/9485.php [Retrieved on 20 September 2016].

Life Cycle Greenhouse Gas Emissions of Material Use in the Living Laboratory

Marianne Rose KJENDSETH WIİK^a, Aoife Anne-Marie HOULIHAN WIBERG^b

^a SINTEF, Norway, marianne.wiik@sintef.no

^b Norwegian University of Science and Technology, Norway, aoife.houlihan.wiberg@ntnu.no

ABSTRACT

This paper presents an analysis of the implication design choices have on embodied material emissions, with a view to better understand how the life cycle assessment of buildings can be better integrated into the building design process. The analysis is applied to a pilot net zero emission building (nZEB) called the Living Laboratory, which has been developed by the Norwegian Research Centre on Zero Emission Buildings. The impact of embodied emissions is presented through a series of sensitivity analyses that consider the definition of a functional unit and system boundary. The results for embodied emissions are presented for each building component, and highlight important design drivers for the reduction of emissions in building construction. Compared to the previous ZEB projects, the total embodied emission result from the Living Laboratory of 23.5kgCO_{2eq}/m²/yr is considered high. This is due to the building having a more comprehensive material inventory, which includes more life cycle phases, and uses a higher level of technical equipment and state-of-the-art materials. The results show that the outer roof, photovoltaic system and outer walls drive the highest emissions. Further analysis revealed that in some cases high emissions came from the production phase, whereas in other cases it originated from the replacement phase. The results show that timber, electrical components and metal were responsible for driving the highest emissions. The results show that certain design choices, such as a change in foundation design, can reduce embodied emissions by 21%, which could be further reduced if low carbon concrete was used.

Keywords: net zero emission buildings, embodied emissions, design process

1. INTRODUCTION

1.7 Background

Previously, the Research Centre on Zero Emission Buildings (ZEB) carried out two simplified concept studies in autumn 2011, with the goal of achieving a ZEB-OM ambition level. In the beginning of 2012, it was decided to develop these concepts into more realistic building models; one of the concept studies was an office building, (Dokka et al., 2013) whilst the other was a single-family house (Houlihan Wiberg et al., 2013). The two ZEB concepts were designed to 'provide a benchmark for Nordic conditions (i.e. cold climate) and [as] a starting point for comparison' of embodied emissions (Georges et al., 2015). The Living Laboratory is one of the first net ZEB pilot studies to be built and tested. This report builds upon the embodied emission methodology developed by the ZEB centre, and applies it to the real case of the Living Lab; with a view to better understand the implication of design choices on embodied material emissions. The Living Lab is an experimental facility that uses state-of-the-art materials and technical equipment. It will be tested and occupied by researchers, students and professors from the Norwegian University of Science and Technology (NTNU).

2. BUILDING DESCRIPTION

The Living Laboratory is a single storey, temporary, multi-purpose demonstration and experimental facility. The building is of a detached, single-family house typology, which represents over 52% of the Norwegian building stock (SSB, 2013). The building is located on NTNU's Gløshaugen campus, Trondheim, Norway. A photograph and section of the building can be seen in Figure 1. A comprehensive explanation of the building envelope, services and energy supply system can be found in Inman and Houlihan Wiberg, 2015.

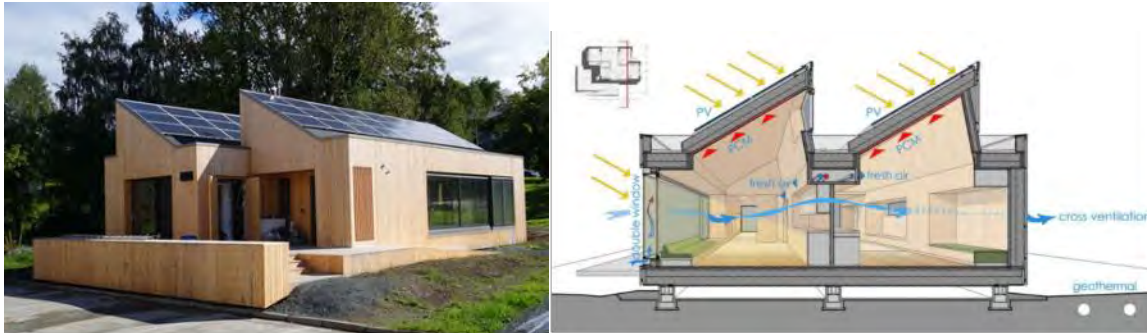

Figure 1: Photo and section of the Living Lab (Finocchiaro et al., 2014).

2.1 Building envelope

The building is comprised of a timber-framed loadbearing structure, with a raised timber floor construction, mineral wool insulation and parquet timber flooring. The building envelope consists of a timber-framed construction, mineral wool insulation, timber cladding, whilst the roof comprises of the same construction with additional integrated phase change material (PCM) and in-roof building adapted photovoltaic panels (BAPV). The north and south windows comprise of triple-glazed units with double-skin insulated aluminium frames. The east and west doors comprise of aluminium-clad timber-framed triple-glazed units with integrated vacuum insulated panels (VIP). The building consists of two adjoining rectangular cells approximately 12.5 x 4.1 metres, with elongated facades facing north and south. The Living Lab contains two bedrooms, one bathroom, a living area, a kitchen, a study, as well as an entrance hallway and technical room. The ground floor has a heated floor area (BRA) of 102 m², a gross floor area (BTA) of 132 m², a net floor area (NTA) of 97 m² and a built up area (BYA) of 219 m². The choice of definition of area plays an important role in the sensitivity of the functional unit which is explained in more detailed in Inman and Houlihan Wiberg, 2015. The total window and door areas are 47.3 m², which gives a window/door to floor area ratio of 46.4%.

2.2 Building services

The building services category includes sanitary installations, heating, ventilation and air conditioning, as well as lighting and common household appliances. In order to simulate multiple energy scenarios, the technical systems for the Living Laboratory have purposefully been over specified. Any additional technical equipment, control systems, sensors or probes used to document the performance of the Living Lab, have been purposefully left out of the material inventory.

2.3 Energy supply system

The energy supply solution for heating, cooling and electricity is an 'all electric' solution based on: 1) High-efficiency PV on the roof, 2) solar thermal collectors on the south façade, 3) geothermal heat pump. An explanation of the passive and active design strategies used, to optimise the design of the Living Lab, can be found in Inman and Houlihan Wiberg, 2015.

3. METHOD

3.1 Goal and scope

The goal of these calculations is to estimate, and thus provide an overview of the materials and components in the Living Laboratory, which contribute the most to embodied CO_{2eq} emissions. The calculations are based on the principals of environmental assessment through life cycle assessment, according to ISO 14044: 2006. The **functional unit is set to 'emissions per 1m² of heated floor area (BRA) per year of operational building lifetime'**, so that the results are comparable with the other ZEB pilot projects. The results are normalised according to a BRA of 102m² and a building lifetime of 60 years. For transparency, a sensitivity analysis of the functional unit, in terms of definition of area and building lifetime, shall be presented.

3.2 System boundary and material inventory

The material inventory was calculated manually using the architect's drawings, and has been cross-referenced with product literature and on-site observations. The system boundary is defined according to EN 15978: 2011 and is limited to the extraction of raw materials and the manufacture of products and materials (A1 - A3), the transport of goods to site (A4) and their installation into the building (A5). Replacement of new materials over the lifetime of the building is also included (B4), including the transportation of these new materials to site (A4). Full details on what is included in the system boundary and material inventory can be found in Inman and Houlihan Wiberg, 2015; as well as information on the reference service lifetimes (RSL) for the different materials and component, which are based on manufacturer's literature, BKS 700.320 and 700.330, Ecoinvent reports and previous ZEB pilot projects. An assumption has been made that the PV panels will be produced 50% better in 30 years' time.

3.3 Calculation method

Generic life cycle inventory data has been accessed from SimaPro Analyst version 8.0.5, and uses datasets from Ecoinvent version 3.1. (PRé, 2015) (Ecoinvent Centre, 2014). All the calculations have been structured in MS Excel according to NS 3451: 2009 Table of Building Elements (NS3451, 2009). The IPCC GWP 100 year scenario method has been used, for the impact assessment of the material inventory (PRé, 2007). The choice of electricity mix used in the production of materials is based on those specified in the Ecoinvent database. For example, the concrete dataset used in the analysis, is based on a concrete process from Switzerland, using the Swiss electricity mix as an input. The photovoltaic modules use a rest of world (ROW) electricity mix factor, since they are produced in Singapore.

4. RESULTS

4.1 Total embodied emission results

The results show that the total embodied emissions are calculated as 23.5kgCO_{2eq}/m²/yr, see Table 1. The majority of emissions come from the production (50%) and replacement (40%) phases. Transport to site and construction emissions account for 5% each.

Life Cycle Stage	kgCO _{2eq}	kgCO _{2eq} /yr	kgCO _{2eq} /m ²	kgCO _{2eq} /m ² /yr
Initial Materials (A1 - A3)	74,121	1,235	727	12.1
Transport to Site (A4)	6,188	103	61	1.0
Construction (A5)	7,412	124	72	1.2
Replacement (B4)	56,067	934	550	9.2
TOTAL	143,788	2,396	1,410	23.5

Table 1: Carbon dioxide (eq) emissions from material use in the Living Laboratory.

When compared to other ZEB projects such as the ZEB single-family house (SFH), the total embodied emissions from the Living Laboratory are considered high. For the same system boundary (A1-3, B4), it can be seen that the Living Lab (21.3kgCO_{2eq}/m²/yr) has three times higher emissions than the SFH (7.2kgCO_{2eq}/m²/yr). During the 60-year lifetime of the two buildings, it can be seen that the Living Lab (130,188kgCO_{2eq}) has double the amount of total emissions than the SFH (69,139kgCO_{2eq}). These higher emissions from the Living Lab can be explained by the fact it has a more detailed material inventory, and a more comprehensive system boundary than the ZEB SFH. Both of these factors contribute to higher total embodied emissions. In addition, the Living Lab has an area of 102m², whilst the ZEB SFH has an area of 160m², which means that the Living Lab has a higher concentration of material and emissions per m² of BRA than the SFH.

The results show that the majority of total emissions (65%) originate from the building envelope, whilst one quarter comes from the PV in the outer roof. The remaining 12% of emissions come from 'heating, ventilation and sanitation' of which appliances account for 8%.

The definition of area plays an important role in the sensitivity of the functional unit, resulting in a two-fold variation in total embodied emissions. The results show that choosing a gross floor area (BTA) scenario results in 18.2kgCO_{2eq}/m²/yr compared to 23.5kgCO_{2eq}/m²/yr in the heated floor area (BRA) scenario. If a net build up area

(BYA) definition is used, emissions are almost half $10.9\text{kgCO}_{2\text{eq}}/\text{m}^2/\text{yr}$, and conversely increased to $24.7\text{kgCO}_{2\text{eq}}/\text{m}^2/\text{yr}$ if net built up area (NTA) is used.

The functional unit is also sensitive to the definition of building lifetime. Given that the Living Lab is a temporary building, it is likely that the building lifetime will be shorter than the standard 60-year lifetime specified. For that reason, a sensitivity analysis of the results, in relation to the length of building lifetime has been calculated. Even though this is a theoretical exercise, the results show more than a 74% decrease in emissions relative to a doubling of building lifetime, from 30 to 60 years. When this lifetime is extended to 75 years, the decrease in emissions is 71%, and 65% when increased to 100 years.

In terms of replacement, the SFH has $1.95\text{kgCO}_{2\text{eq}}/\text{m}^2/\text{yr}$, whilst the Living Lab has $9.2\text{kgCO}_{2\text{eq}}/\text{m}^2/\text{yr}$. This difference is explained by the fact that less than 30% of the materials used in the SFH were replaced during the lifetime of the building, compared to over 40% in the Living Lab, which is explained by the fact that all replaced materials in the Living Lab include transport and construction emissions.

4.2 Building envelope results

One quarter of emissions arise from the outer roof because of the complex roof form, aluminium flashings, roof lights and over-dimensioned PV mounting frame. The PV is the next highest driver, contributing just over one fifth of total emissions, followed by the outer walls with 15% of emissions. Appliances contribute 8.2%, followed by the 'Groundwork and Foundations' (4.5%) and 'Floor Structure' (3.3%). An interesting design driver for reduced emissions was the decision to omit the concrete footing from the strip foundation, which resulted in almost half the quantity of concrete being used (16m^3 to 9m^3) and a 20% reduction in embodied emissions from concrete. Timber contributes to almost one fifth of emissions, because the building is predominantly of timber construction. Similarly some of the wood products have been processed (e.g. plywood processing involves glue additives) which may lead to an increase in embodied emissions compared to unprocessed timber products.

4.3 Building services results

The emissions from appliances account for 8% of total emissions in the building. The replacement emissions originate from the replacement of white goods, which have a product service lifetime of between 10-15 years, and therefore are replaced 4 to 6 times during the lifetime of the building. The washing machine accounts for driving the highest emissions (33%), followed by the dishwasher (20%), oven (19%), fridge freezer (15%), tumble dryer (10%) and hob (4%). Both the sanitary, lighting and electrical categories contributed negligible emissions to total embodied emissions. These categories experience low emissions because at the time in which calculations were carried out, a complete material inventory was not available for these items. The heating system contributes only 3% to total emissions. The solar thermal collectors have an RSL of 25 years and are replaced 2.4 times, whilst the hot water tank and heat pump have an RSL of 20 years and are replaced 3 times. The heat pump accounts for driving the highest emissions (31%) in this component, followed by the solar thermal collectors (26.7%), hot water tank (20%), PEX pipes (12.3%) and heat emission plates (10.1%). The ventilation and air-conditioning category is also responsible for negligible emissions. There are no replacement emissions due to the 60-year RSL. The steel ventilation ducts are responsible for driving the highest emissions (43.6%) in this component, followed by the combi-exhaust (35.8%), supply grill (10.2%), air handling unit (5.5%), combi-intake (3%), extractor fan (1.1%) and flexible duct (0.75%).

4.4 Energy supply system results

The 'other electric' power category is responsible for 23% of total emissions in the building. The PV balance of systems (BOS) accounts for 68% of the replacement emissions, of which the inverters account for 91% of these emissions. The PV replacement emissions account for over one third of emissions. The product service lifetime for PV is 30 years, so they are replaced twice during the lifetime of the building. However, it has been assumed that the panels will be produced 50% better in 30 years' time, with half the amount of material emissions per m^2 . In contrast, the inverters have a 15-year RSL, and are replaced four times. The ZEB emission factor for electricity has been used ($0.136\text{kgCO}_{2\text{eq}}/\text{kWh}$), to calculate a PV cumulative energy yield of approximately $8996\text{ kWh}/\text{m}^2/\text{yr}$ over a 60-year lifetime per m^2 of module (Graabak and Feilberg, 2011) (Kristjansdottir et al., 2016). On-site PV energy production counterbalances $94,054\text{kgCO}_{2\text{eq}}$ of $143,788\text{kgCO}_{2\text{eq}}$ emissions, which equates to 65% of total

embodied material emissions. In order to compensate for all emissions relating to material use, a total of 121m² PV is required, meaning that an additional 42m² of PV would need to be installed on-site (this does not account for the additional material emissions from the installation of additional PV modules and supporting services).

5. DISCUSSION AND CONCLUSION

This report has documented the design and construction of the Living Laboratory in terms of its embodied material emissions. Compared to previous ZEB projects, the results show relatively high-embodied emissions, with total emissions of 1410kgCO_{2eq}/m² over a 60-year lifetime and 23.5kgCO_{2eq}/m²/yr. There are multiple reasons for this. Firstly, a more comprehensive material inventory was available for the Living Lab as an 'as built' project. In addition, the system boundary includes more life cycle stages. Furthermore, since this is a ZEB demonstration building, it has higher emissions than a normal building of its size, since a high level of technical equipment and state-of-the-art materials are used.

The key components, which drove the highest emissions, were found to be in the building envelope (65%). Other key drivers were found in the PV modules (22.7%), and appliances (8.2%). It was interesting to note that the VIP, which is typically identified as a high driver of emissions, was found to be responsible for only 2.2% of emissions, which is largely due to the small quantity used sensitively in the design. The results show that state-of-the-art materials, such as VIP and PCM, may be used sensitively and effectively without contributing significantly to embodied material emissions. A significant finding was found in the choice of a three-strip foundation design, which reduced emissions by almost one third, compared to the raft foundation design used in the single-family house (SFH). As a result, the Living Lab has used half (16m³) the volume of concrete compared to the SFH (32m³). The findings also show that omitting a concrete footing from the foundation, between the design and construction phase, has led to over a 40% reduction in the amount of concrete used (9m³), and a 20% reduction in emissions. This could be further reduced if low carbon concrete was used.

The findings show that components with a high proportion of materials with long RSLs, e.g. 60 years, experience the majority of emissions during the production (50%) phase, whereas components with materials with short RSLs, e.g. 15-20 years, typically have a higher proportion of emissions originating from the replacement (40%) phase. Transport to site and construction emissions account for 5% each. In the outer roof, the majority of emissions came from the production phase (57%) compared to the replacement phase (34.3%), whereby the complex roof form together with the PV mounting frame and flashings drove higher embodied emissions. In contrast, the appliances have one third less (20%) total emissions from the production phase, and 40% higher emissions (80%) from the replacement phase. This is due to the RSL of appliances being 10-15 years, compared to the 60-year lifetime of the building.

The PV emission balance highlights that further measures are required to reduce the amount of emissions relating to material use, and to improve the efficiency of energy production from photovoltaic panels or other renewable sources on-site. Given that the outer roof, PV modules and mounting frame contribute almost half to total embodied emissions, further work could investigate building integrated, instead of building adapted PV, and a less elaborate roof form, which may save on material emissions, simply because less material is used. Further work could include comparing these two types of systems with a non-integrated PV solution that uses a less-complicated flat roof construction. It would be interesting to see how much extra energy could be produced on-site if a one-sloped roof design was implemented, with no overshadowing. The material emission balance highlights that further measures are required, to reduce the amount of emissions relating to material use, and to improve the efficiency of energy production from photovoltaic panels or other renewable sources on-site.

The functional unit sensitivity analysis raises the question of whether or not a 60-year lifetime is appropriate for the Living Lab, since the building is temporary, and will be dismantled at its end-of-life (EOL). In these circumstances, there should be more focus on the demountability and recyclability of the building, rather than the durability of materials. The results also show that the definition of area plays an important role in the sensitivity of the functional unit, resulting in a two-fold variation in total embodied emissions.

In conclusion, it was found that material optimisation should be considered at an early stage in the design process, in order to reduce embodied material emissions. These results provide useful approximations for embodied material emissions, for use by designers during the early design phase, when a detailed material inventory may

not necessarily be available. It also highlights methodological and design considerations when carrying out a life cycle assessment of a building. Furthermore, the Living Lab provides alternative solutions for low embodied emission design.

ACKNOWLEDGMENTS

This article has been written within the Research Centre on Zero Emission Buildings (ZEB). The authors gratefully acknowledge the support from the ZEB partners and the Research Council of Norway.

REFERENCES

- [1] Dokka, T. H., Haase, M., Kristjansdottir, T., Mellegård, S., Time, B., Tønnesen, J. 2013. A zero emission concept analysis of an office building. The Research Centre on Zero Emission Buildings, project report no. 8, SINTEF Academic Press, Oslo.
- [2] Ecoinvent Centre, 2014. Ecoinvent data and reports version 3.1. Swiss Centre for Life Cycle Inventories, Dubendorf.
- [3] Finocchiaro, L., Goia, F., Grynning, S., Gustavsen, A., 2014. The ZEB living lab: A multi-purpose experimental facility. Ghent Expert Meeting Ghent University, Ghent.
- [4] Georges, L., Haase, M., Houlihan Wiberg, A. A-M., Kristjansdottir, T., Risholt, B., 2015. Life cycle emissions analysis of two nZEB concepts. *Building Research and Information*, 43, 82-93.
- [5] Graabak, I., Feilberg, N., 2011. CO2 emissions in different scenarios for electricity generation in Europe. The Research Centre on Zero Emission Buildings, SINTEF Energy, Oslo.
- [6] Houlihan Wiberg, A. A-M., Dokka, T. H., Georges, L., Mellegård, S., Time, B., Haase, M., Lien, A., 2013. A zero emission concept analysis of a Norwegian single-family house: A CO2 accounting method. The Research Centre on Zero Emission Buildings, project report no. 9, SINTEF Academic Press, Oslo.
- [7] Inman, M. R., Houlihan Wiberg, A. A-M., 2015. Life cycle GHG emissions of material use in the living laboratory. The Research Centre on Zero Emissions Buildings, project report no. 24, SINTEF Academic Press, Oslo.
- [8] Kristjansdottir, T., Good, C. S., Inman, M. R., Dahl Schlanbusch, R., Andresen, I. Greenhouse gas emissions from PV systems in residential Zero Emission Buildings – pilot cases from Norway. *Solar Energy*, 133, 155-171.
- [9] Pre Consultants, 2007. IPCC 2007 method GWP 100a version 1.0.2. Netherlands.
- [10] Pre Consultants, 2015. Simapro analyst LCA software version 8.0.5. Netherlands.
- [11] SSB, 2013. Boliger, etter bygningstype og år [online]. Retrieved from: <http://www.ssb.no/befolkning/statistikker/fobboldig/hvert-10-aar/2013-02-26>. [Retrieved on: 30th November 2013].
- [12] ISO 14044: 2006. Environmental management – life cycle assessment – requirements and guidelines. International Standards Organisation.
- [13] NS 3451: 2009. Table of building elements. Standard Norge.
- [14] EN 15978: 2011. Sustainability of construction works – assessment of environmental performance of buildings. Calculation method. International Standards Organisation.

Paradoxical Feasibility of High-rise Zero Carbon Buildings

PAN Weija, YU Cong^b

^a The University of Hong Kong, Hong Kong SAR, wpan@hku.hk

^b The University of Hong Kong, Hong Kong SAR, yucong@connect.hku.hk

ABSTRACT

Zero carbon building (ZCB) has emerged as a most innovative approach to addressing anthropogenic climate change, evidenced by at least the relevant policy formulation and project deliveries in many countries. However, such approach only prevails in contexts where low-rise buildings dominate, while delivering high-rise towards zero carbon is normally arbitrarily perceived to be infeasible, substantiated by the lack of knowledge of high-rise ZCB and worsened by the absence of systems approaches to examining feasibility. This paper aims to contribute to a better understanding of the feasibility of high-rise ZCBs using a paradoxical framework. The research was conducted through the integration of a literature review of ZCB related research and practices worldwide and a study of the five-fold feasibility of high-rise ZCB in Hong Kong. This five-fold feasibility covers the technical, commercial, supply chain, regulatory and socio-cultural aspects. Two real-life high-rise buildings, residential and office, were used to develop energy simulation and carbon estimation baseline models for sensitivity analyses. The results indicate potential of reductions up to 57% energy use and 58.3% carbon emissions of the case buildings based on quick-win and optimisation design solutions and of nearly net-zero with strategic scenarios. However, such technically feasible solutions and scenarios are found to be institutionally difficult if not entirely infeasible. The five-fold feasibility is revealed to be interactive, dynamic and value-laden, with the specific aspects subject to their systems boundaries such as energy and carbon scope and calculation methodology. The resultant solutions and scenarios will inform future practices of reducing building energy and carbon emissions. The contributed paradoxical framework challenges conventional perceptions on feasibility and will guide the quest for high-rise ZCBs as complex socio-technical systems as they are.

Keywords: zero carbon building, high-rise building, feasibility, socio-technical system

1. INTRODUCTION

Buildings worldwide account for as much as 45% of energy consumption and carbon emissions (Butler, 2008), and therefore stand out as the biggest contributor to anthropogenic climate change. Low or Zero Carbon Building (L/ZCB) has been regarded as a most innovative model of sustainable development in the built environment. Many governments have adopted the L/ZCB model as an important strategy for addressing climate change, achieving a low carbon economy and uplifting quality of people's life (Wilford and Ramos, 2009, Pan and Garmston, 2012). In Hong Kong, buildings consume 92% of electricity and contribute 60% of carbon emissions in the city (EMSD, 2015b), which are much higher than the worldwide averages (Pan and Garmston, 2012). The HKSAR government has pledged to achieve a reduction in carbon intensity of at least 50% to 60% on the 2005 baseline by 2020 (ENVB, 2010). There are roughly 2,671,900 stocks of living quarters in Hong Kong as at end-October 2014 (HKCSD, 2014), with a substantial increase annually. Tackling carbon emissions from buildings is a critical component to achieving governmental goals for substantial carbon reduction and long-term sustainability in Hong Kong.

Many countries and regions have promoted Low or Zero Carbon Building (L/ZCB) as a most innovative model of sustainable development, which however present unprecedented challenges to both research and practice. First, there is a lack of consistent L/ZCB definition and methodology. Second, the vast majority of L/ZCBs to date are located in cold and temperate climates. Third, few high-rise L/ZCBs have been reported worldwide.

The aim of this paper is to contribute to a better understanding of the feasibility of high-rise ZCBs using a paradoxical framework. The research was conducted through the integration of a comprehensive literature review of ZCB related research and practices worldwide and a study of the five-fold feasibility of high-rise ZCB in Hong Kong. This five-fold feasibility covers the technical, commercial, supply chain, regulatory and socio-cultural aspects. Two real-life high-rise buildings, public residential and private office, were used to develop energy simulation and carbon estimation baseline models for sensitivity analyses. Scenario-based design solutions are developed to delivering high-rise buildings towards zero carbon.

2. A L/ZCB DEFINITION OF HONG KONG

To address the high-density, high-rise and hot-and-humid features of buildings in Hong Kong, the definition needs to regard L/ZCBs as complex socio-technical systems (Pan and Ning, 2015) and recognise their multidimensional systems boundaries and wide-ranging **stakeholder groups' engagement** (Pan, 2014). A ZCB (or a LCB) is defined as a building within its defined systems boundaries with net-zero (or very low) carbon emissions on an annual basis during the operational stage of this building.

The systems boundaries should be defined in terms of the technical components of the definition within the relevant regulatory, geographic and social contexts (Figure 1).

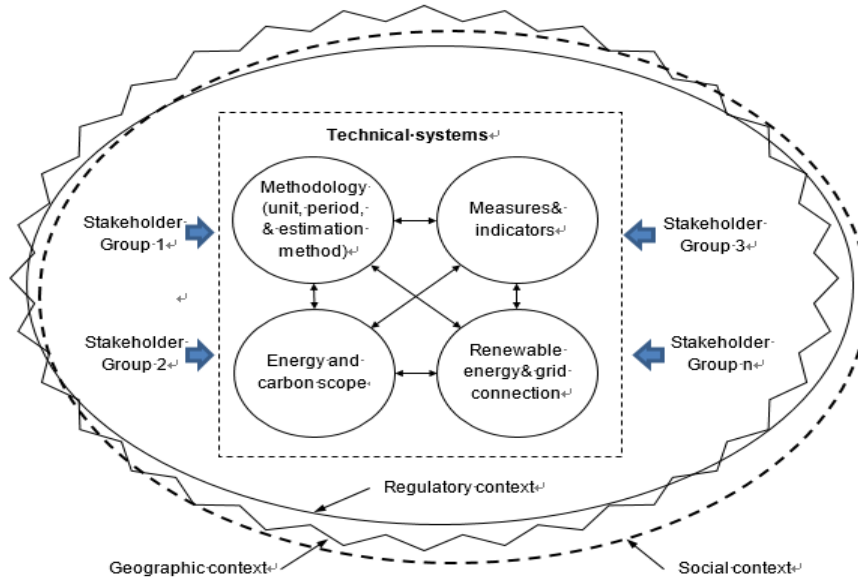

Figure 1: A conceptual model of L/ZCBs as socio-technical systems
(After Pan and Ning, 2015) Note: The contexts interact with each other.

3. HIGH-RISE L/ZCB FEASIBILITY, SCENARIOS & SOLUTIONS

The high-rise L/ZCB feasibility was examined of two types of buildings, public residential and private office buildings (Figure 2). Using two sampled typical real-life building projects, the Base Cases, Quick-win and Optimisation Scenarios were developed.

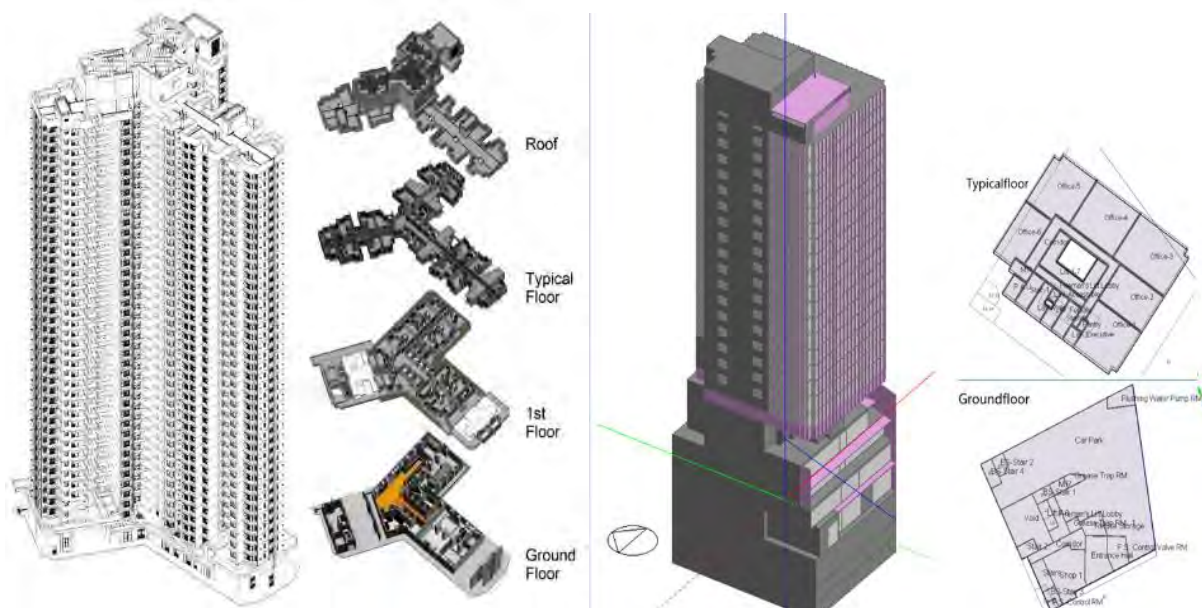

Figure 2 Public residential case building and private office case building and different floors
(Courtesy of Hong Kong Housing Authority, Yau Lee and Sun Hung Kai)

Public residential building

The residential building used for study was a typical 40-storey public housing block adopting modular flat design, completed and occupied since 2013. The Base Case was established through an iterative process of energy simulation and verification drawing on EMSD released end-use energy data, metered energy use and engagement with professionals. The energy use intensity (EUI) was estimated to be 106.6 kWh/(m²-yr), covering in order of significance, cooling electricity (23.5%), cooking gas (22.41%), appliances (20.84%), DWH gas (16.22%), lighting for communal area (4.71%), lighting for residential units (4.55%), lift (3.24%), water pump (2.59%), and other communal area use (1.94%). The carbon emissions intensity (CEI) was calculated as 55.51kg/(m²-yr) (Table 1).

Category	Base Case		Quick-win Scenario		Optimisation Scenario	
	Energy use kWh/m ²	Carbon emissions kg/m ²	Energy use kWh/m ²	Carbon emissions kg/m ²	Energy use kWh/m ²	Carbon emissions kg/m ²
Electricity consumption	65.44	45.81	50.34	35.24	45.07	31.55
Towngas consumption	41.16	9.70	41.16	9.70	31.39	7.40
Total	106.6	55.51	91.5	44.94	76.46	38.95
PV	n/a	n/a	-10.37	-7.26	-21.23	-14.86
Wind turbine	n/a	n/a	-1.39	-0.97	-1.39	-0.97
Net Total	106.6	55.51	79.8 (-25%)	39.71 (-28.5%)	53.88 (-49%)	23.12 (-58.3%)

GFA: 36,286 m²; carbon emission factors for electricity and towngas: 0.7 kg/kWh and 0.2356 kg/kWh.

Table 1: Public residential L/ZCB scenarios

In the Quick-win Scenario, the most energy-sensitive energy saving measures were found to be, in order of significance, cooling set point, gross rated COP of air-conditioner, airtightness, window to wall ratio, window glazing properties, and solar absorptance of wall. The most energy-sensitive design features/parameters were found to be natural ventilation rate and orientation. The U value of wall and window was found to have negative influence on energy consumption when cooling set point is 26 degree C or higher. The solar absorptance and U value of roof were found to have little influence on the overall energy consumption. The impact of the cooling set point on energy saving was revealed to be far larger than that of the building design features/parameters. Renewable energy technologies (PV and wind turbine) with standard efficiency were included, which together could provide electricity **that might offset nearly 13% of the building's total energy consumption.**

In this Optimisation Scenario, the most important energy saving measures adopted included the change of shower time along with the improvement of efficiency of hot water boiler, the improvement of domestic appliance efficiency, cooking stove efficiency, lift with regenerative power and more efficient water pump system. The impact of changing shower time on energy saving was found to be far larger than that of improving equipment efficiency. Renewable energy technologies (PV and wind turbine) with advanced efficiency were included, which could generate electricity **that might offset nearly 30% of the building's total energy consumption.**

To sum up, the developed Quick-win and Optimisation Scenarios could achieve up to 49% EUI and 58.3% CEI reductions from the Base Case, which represents very low energy and carbon high-rise residential buildings, particularly in the hot-and-humid climates. The solutions require the systems integration of passive design, efficiency, behaviour changes and renewable energy, and thus shake conventional perceptions from the political, economic, social and technological perspectives.

Private office building

The office building used for study was a 26-storey typical new private office block adopting insitu concrete method. The Base Case was established through an iterative process and energy simulation and verification drawing on EMSD released end-use energy data and engagement with professionals. The EUI was estimated to be 282.4 kWh/(m²-yr), covering in order of significance, cooling electricity (41.9%), fans (23.6%), appliances (17.5%), interior lighting (16.5%), and then pumps (0.4%). The CEI was calculated as 197.7kg/(m²-yr) (Table 2).

Category	Base Case		Quick-win Scenario		Optimisation Scenario	
	Energy use kWh/m ²	Carbon emissions kg/m ²	Energy use kWh/m ²	Carbon emissions kg/m ²	Energy use kWh/m ²	Carbon emissions kg/m ²
Electricity consumption	282.40	197.70	188.86	132.20	149.52	104.66
PV	n/a	n/a	-11.64	-8.15	-27.6	-19.32
Wind turbine	n/a	n/a	-1.72	-1.20	-1.72	-1.20
Net Total	282.40	197.70	175.5 (-38%)	122.85 (-38%)	120.2 (-57%)	84.14 (-57%)

GRA: 29,305.9 m²; carbon emission factor for electricity: 0.7 kg/kWh.

Table 2: Private office L/ZCB scenarios

In the Quick-win Scenario, the most energy-sensitive energy saving measures were found to be water-cooled **chiller system, daylighting control and underfloor air supply, each of which can reduce the building's total energy use by around 10%**. The most energy-sensitive design feature was found to be fan efficiency, a 0.9 value of which **can reduce the building's total energy use by nearly 30% from that of a 0.3 efficiency. Renewable energy technologies (PV and wind turbine) with standard efficiency were included, which however could only offset around 7.1% of the building's total energy use. In this Optimisation Scenario, the most important energy saving measures adopted included District Cooling System (DCS), Shorten HVAC operation time, turning off unoccupied equipment and other social aspects.** The most important design features/parameters used included raising equipment efficiency, reducing heat gain with better building orientation. The impact of the energy saving measures on energy savings was found to be far larger than that of the building design features/parameters.

To sum up, the developed Quick-win and Optimisation Scenarios could achieve up to 57% EUI and CEI reductions from the Base Case, which represents very low energy and carbon high-rise office buildings, particularly in the hot-and-humid climates. The solutions require the systems integration of passive design, efficiency, behaviour changes and renewable energy, and thus shake traditional perceptions from the political, economic, social and technological perspectives.

Strategic scenarios

Although significant EUI and CEI reductions are attainable (see results outlined in Tables 1 and 2), it is still infeasible to achieve net-zero carbon or net-zero energy for high-rise L/ZCBs in Hong Kong given the current carbon-intensive energy supply and the renewable energy and carbon reduction technologies available in the market. To achieve high-rise net zero carbon, more efficient or emerging renewable energy technologies and/or decarbonisation measures must be explored and adopted. Examples of renewable energy technologies include fuel cells (FC), combined heating, cooling and power (CCHP), district cooling systems (DCS), and examples of decarbonisation measures include carbon capture and storage (CCS), planting trees, changing fuel mix, and decarbonised electricity supply.

Two strategic scenarios are developed (Figure 3). Emerging Renewable Scenario is based on the Optimisation Scenario and takes into account emerging renewable energy technologies such as CCHP, DCS, Fuel Cells (FC) that together may further reduce the net energy use (hence net carbon emissions) of the building towards zero or negative. Decarbonisation Scenario is also based on the Optimisation Scenario but takes into account solutions such as decarbonised electricity generation, changing fuel mix, CCS, tree planting that together may further reduce the net carbon emissions of the building towards zero or negative. It is more realistic to integrate (some of) the technologies and measures proposed for the two strategic scenarios in order to more effectively achieve energy use and carbon emissions reductions while addressing the non-technical aspects of the feasibility.

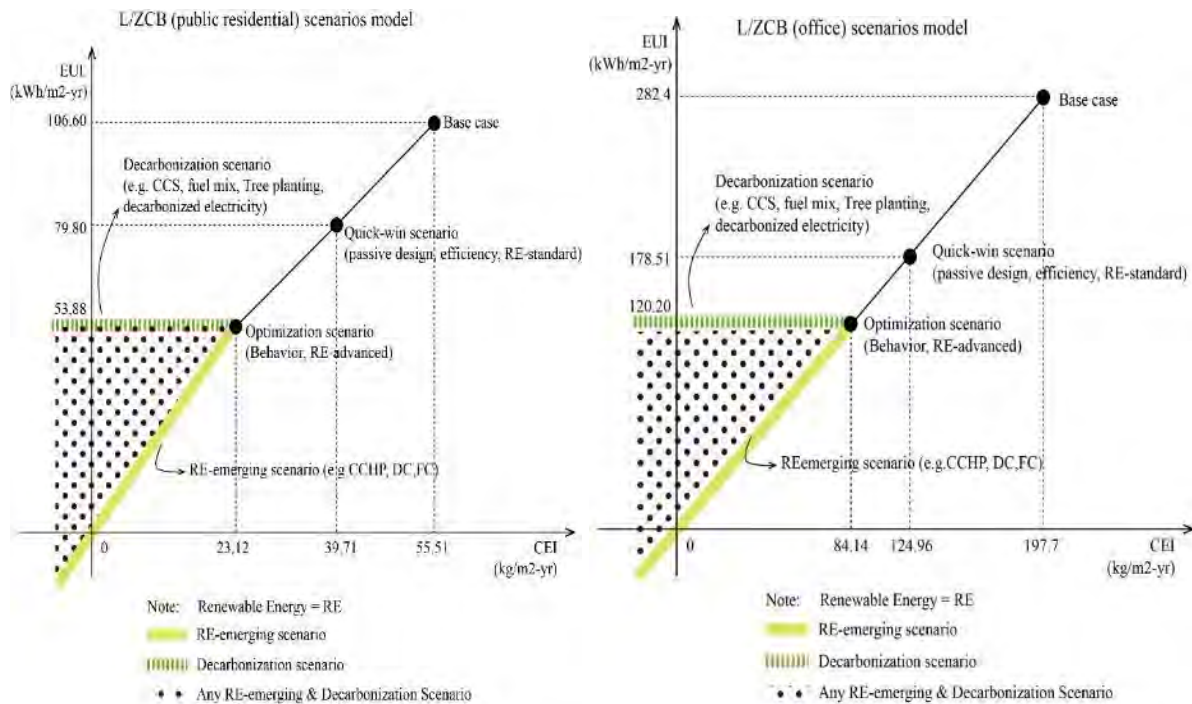

Figure 3: L/ZCB case and scenarios model (left: public residential, right: private office)

High-rise L/ZCB design strategies

A wide range of high-rise L/ZCB design strategies have been developed, which are grouped under ten elements of building energy use and carbon emissions: 1) Reduce and minimize energy demand by user behaviour changes, e.g. reasonably increase cooling set point; 2) Reduce energy loss through building envelope in dynamic trade-off with natural lighting, e.g. reduce heat gain and adopt overhangs and side-fins; 3) Reduce and minimize energy use for M&E systems, e.g. adopt LED and lighting control, increase COP of air conditioner; 4) Reduce and minimize energy use for appliances, e.g. adopt higher efficiency appliances, or adopt towngas driven appliances; 5) Reduce and minimize energy loss in transmission or explore towngas driven counterparts; 6) Decarbonize energy production and supply, e.g. decarbonize electricity generation by using CCS, change fuel mix, use bio-fuel; 7) Adopt and maximise on-site renewable energy generation in dynamic trade-off with land, space and view availability, e.g. adopt BIPV, explore CCHP; 8) Adopt and maximise off-site renewable energy generation in dynamic trade-off with land and space availability and energy loss in transmission, e.g. adopt DCS, solar farm; 9) Adopt accredited renewable energy and/or carbon reductions, e.g. use nuclear power, promote carbon trading; and 10) Adopt carbon offset, capture and storage measures, e.g. plant trees and adopt CCS in dynamic trade-off with land and space availability.

Underlying these strategies is systems theory of dynamical integration, which is required for possibly achieving net zero carbon. Systems optimization is required for achieving different levels of low carbon while addressing socio-technical trade-offs.

4. NON-TECHNICAL FEASIBILITY OF HIGH-RISE L/ZCB

The non-technical feasibility aspects, i.e. socio-cultural preference, commercial viability, supply chain competency, and statutory and regulatory acceptance, were found to be interactive, dynamic and value-laden.

They interacted with each other and as a whole interacted with the technical feasibility. The socio-cultural preference was largely shaped and guided by the political and regulatory acceptance. The supply chain competency had an important implication for the commercial viability. The technical feasibility would determine the commercial viability. The relevant technical scenarios and design solutions would be governed by the political agenda and regulatory framework, and if adopted, be influenced by the other aspects.

Being dynamic, how feasibility the non-technical aspects were (or not) would depend on the technical scenarios and design solutions developed. Although the Quick-win Scenarios were developed using more established efficiency and renewable technologies, the Optimisation Scenarios based on more predicted behavioural changes and adopted more advanced renewable energy technologies, hence embedding uncertainties. The two strategic scenarios, Decarbonisation Scenario and Emerging Renewable Scenario, were then more exposed to political, economic, socio-cultural and technological risks.

Being value-laden, how the non-technical feasibility aspects were perceived by different stakeholders would be subject to their interests in the multi-dimensional aspects of the complex systems boundaries of L/ZCBs.

Nevertheless, the statutory and regulatory acceptance was considered fundamental and the most important in all the non-technical feasibility aspects to delivering high-rise L/ZCB in Hong Kong. The statutory and regulatory acceptance would largely shape and guide the socio-cultural preference. An ambitious but clear carbon reduction target could motivate the industry and market for L/ZCB. This would then enhance the supply chain competency. The government itself is a major client for buildings. The government can lead the adoption of the developed technical scenarios and design solutions and nurture a sharing culture in industry.

5. CONCLUSIONS

This paper has established a socio-technical systems L/ZCB definition, examined the feasibility for two building types: public residential and private office, and developed design strategies and scenario-based design solutions in Hong Kong. The established Base Cases were status quo real-life green buildings. For residential, the developed Quick-win and Optimisation Scenarios could achieve up to 49% EUI and 58.3% CEI reductions from the Base Case. For office, the developed Quick-win and Optimisation Scenarios could achieve up to 57% EUI and CEI reductions. Both represent very low energy-and-carbon high-rise particularly in hot-and-humid climates. The solutions required the systems integration of passive design, efficiency, behaviour changes and renewable energy, and thus shake conventional perceptions from the political, economic, social and technological perspectives. However, such technically feasible solutions and scenarios are found to be institutionally difficult if not entirely infeasible. The five-fold feasibility is revealed to be interactive, dynamic and value-laden, with the specific aspects subject to their systems boundaries such as energy and carbon scope and calculation methodology. To achieve high-rise net zero carbon, more efficient or emerging renewable energy technologies and/or decarbonisation measures must be explored and adopted, yielding the two developed strategic scenarios.

The findings will encourage the take-up of innovative low energy and low carbon technologies in the building sector, which will ultimately accelerate the transition of Hong Kong built environment towards low carbon and sustainability. The findings also contribute to a better understanding of high-rise L/ZCBs in a paradoxical socio-technical systems approach, which challenges conventional perceptions on feasibility and will have profound implications for the future design and delivery of high-rise buildings.

ACKNOWLEDGEMENTS

This research was supported by funding from the Construction Industry Council (CICR/01/13) and a grant from The University of Hong Kong Seed Funding Program for Basic Research (Project No.: 201511159254). Its contents **are solely authors' responsibility and do not necessarily represent the funding bodies' official views.**

REFERENCES

- [1] BOECKER, J. HORST, S. KEITER, T. LAU, A. SCHEFFER, M. TOEVS, B. REED, B. (2009) The Integrative Design Guide to Green Building: redefining the practice of sustainability. John Wiley & Sons Ed., 2009

Studies of Energy-Efficient Measures and Building Integrated Photovoltaic Towards Zero Energy Building

LOU Siwei^a, Danny HW LI^b, Eric WM LEE^c, Joseph C. LAM^d, Stanley KH CHOW^e

^a City University of Hong Kong, Hong Kong SAR, swlou2-c@my.cityu.edu.hk

^b City University of Hong Kong, Hong Kong SAR, bcdanny@cityu.edu.hk

^c City University of Hong Kong, Hong Kong SAR, ericlee@cityu.edu.hk

^d City University of Hong Kong, Hong Kong SAR, bcexem@cityu.edu.hk

^e HKU Space, Hong Kong SAR, stanleychow.cityu.hk@gmail.com

ABSTRACT

This paper studies a number of energy-efficient measures and renewable energy (RE) facilities in creating zero energy buildings (ZEBs). Passive building schemes include energy-efficient building envelope designs, raising the thermostat settings during the hot summer, using natural ventilation in circulation area and installing energy-efficient light fittings with daylight-linked lighting controls. Opaque building integrated photovoltaics (BIPV) are adopted to generate electricity for achieving the ZEB. The analysis was conducted based on a building simulation software eQUEST. The results show that ZEB can be achievable in hot and humid climate areas.

Keywords: energy simulation, school building, zero energy building, renewable energy

1. INTRODUCTION

Buildings account for 40% of worldwide energy consumption and one-third of greenhouse gas emission. Designing zero energy buildings (ZEB) has thus become an international aim to help alleviate the energy sources depletion and the environment deterioration. The ZEB designs need to reduce the energy use through energy-efficient approaches and to adopt renewable energy (RE) to meet the minimum energy needs. In subtropical areas, most of the energy consumption in commercial buildings is used to create a thermally and visually comfortable environment. Solar energy has been identified as having the potential to generate sustainable, inexhaustible, clean, and safe energy in Hong Kong on a wide-scale. Strategies to limit summer heat gain through the building envelope include thermal insulation, thermal mass, window/ glazing, green roofs, raising the thermostat settings during the hot summer, and using natural ventilation in circulation areas. Using energy-efficient lighting fixtures with dimming controls and proper daylighting schemes can reduce the energy used in lighting. Natural light can help reduce the electrical demand and the sensible cooling load. For high-rise buildings, vertically installed semi-transparent and opaque building-integrated photovoltaics (BIPV) are appropriate RE facilities.

To achieve zero energy, it is essential to determine the building demands and PV energy production with the accessible energy saving techniques and the available PV installation space on the building envelop. Building-energy simulation programs are suitable design tools to depict the trade-off between various design alternatives. The annual and monthly building energy expenditures and renewable energy generations can be modelled by comprehensive computer simulations. Recently, the HK government has issued several compulsory and voluntary building-energy codes which accept computer simulations to illustrate compliance. This study presents the **energy saving designs of an institutional building, simulates the building's energy consumption and discusses the findings** and implications. The occupancy, lighting, and office equipment schedules are representative to general office buildings. The similar working procedures can be employed in building designs elsewhere.

2. COMPUTER SIMULATION APPROACH

Energy performance of a building depends on the subtle interactions of many architecture features and building-services equipment. Computer-based building-energy simulations are valuable design aid in giving a **comprehensive picture of the building's energy**-behaviour and the trade-off alternatives in detail. The simulation tool employed in the study is the eQUEST building energy program. The software builds on the well-validated DOE-2.2 program and contributes to various worldwide green building crediting schemes such as LEED and BEAM Plus.

The eQUEST package conducts hour-by-hour calculation, using 8,760 hourly records of measured weather data to analyse the heating and cooling loads, and calculates the energy consumptions. Weather data, however, may vary year-by-year. The typical meteorological year (TMY) of Hong Kong employed for the study was developed by 30 years of the weather recordings which represents the typical year-round local climate for the building energy performance analysis.

3. REFERENCE BUILDING

The institutional building has 13 floors with a total area of around 14,000 m² excluding the open corridors and landscape areas. It has 51 lecture rooms, 4 activity rooms, 7 computer rooms, 6 studios, 2 laboratories, 42 staff offices, a library, a hall and a shop. The electrical, mechanical rooms and car parks are located on the ground floor. The lecture, activity and computer rooms, laboratories, and studios are in the 1st to 10th floors. The 11th floor is for installing cooling towers and other equipment. Most of the offices are in the 12th and 13th floor. There are nature ventilated corridors, atrium and landscape in the building which are not accounted in the total building area. Table 1 gives the occupant densities, fresh airflow rate and equipment densities for different areas according to ASHRAE Standard 62.1-2007, Hong Kong BEAM and ASHRAE handbook. With an efficacy of 100lm/m², the T5 fluorescent lamp can keep the illuminance levels of lecture room at 500 lux, staff office at 300 lux and assembly hall at 200 lux which can meet the required criteria. High frequency dimming controls were used to save the energy consumption of artificial lighting by the daylight.

Area	Area (m ²)	Space cooling?	Occupancy (m ² head ⁻¹)	Equipment (W m ⁻²)	Lighting (W m ⁻²)	Fresh air (m ³ h ⁻¹)	Daylight control?
Lecture Room	4,155	Yes	2.8	2.7	6.7	22	47.5%
Library	592	Yes	9.3	5.4	6.7	29	68.3%
Sports Hall	569	Yes	-	-	4.3	-	No
Computer Room	530	Yes	3.7	21.5	6.7	22	53.4%
Hall	454	Yes	2.7	5.4	4	20	No
Studio	343	Yes	4.6	5.4	6.7	22	48.3%
Activity area	303	Yes	3.7	5.4	6.7	22	63.8%
Lab	219	Yes	3.7	5.4	6.7	22	48.2%
Shop	188	Yes	7	2.7	12	27	52.4%
Office	1754	Yes	9.3	10.8	4	29	83.7%
Office Corridor	304	Yes	-	-	3.2	-	51.1%
Corridor	1,986	No	-	-	3.2	-	24.8%
Electrical	754	No	-	-	16	-	56.5%
Toilet	708	No	-	-	3.2	-	No
Carpark	597	No	-	-	3.2	-	No
Storage	322	No	-	-	8.6	-	No
Server Room	54	No	-	-	16	-	No
Total	13,832		-	-	-	-	-

Table 1: Areas of the Building

The floor-to-floor height is 3.6 m (4.3 m for G/F) and the floor-to-ceiling is 2.8 m. The window-to-wall ratio (WWR) in North, East, South and West are 24.4%, 31.2%, 24.9% and 28.6%, respectively. Properties of the building envelop were assumed according to a previous study and manufacturer catalogues, and are summarized in Table 2.

	U-factor ($W m^{-2} K^{-1}$)	Reflectivity	Shading coefficient	Visible transmittance
Roof	0.8625	0.5	-	-
Wall	4.925	0.7	-	-
Window	5.2	0.86	0.3	0.6

Table 2. Parameters of building envelop

Table 3 specifies the settings of the air-conditioning. The water cooled chiller was used because of its high energy efficiency. The COP of 5.64 was greater than the minimum of ASHRAE Standard 90.1 yet can be achievable by the advanced chillers. Zone air temperature was 25.5°C according to the local suggestions. Zone entering minimum temperature was 14.5°C to keep an 11°C difference from the zone air temperature. Other settings followed the default of the software. During transitional and winter seasons, the outdoor air was introduced as free cooling.

Inputs	Specifications
Air-conditioner type	Water cooled chiller
Coefficient of Performance (COP)	5.64
Number of Chillers	3
Minimum Load Ratio of Chiller	25%
Fan pressure	Supply: 88.9 mm, Return 44.5 mm
Total Efficiency	0.85
Fan control	Variable speed
Zone set air temperature	25.5 (°C)
Zone entering minimum temperature	14.5 (°C)
Zone air flow	18 ($m^3 h^{-1} m^{-2}$)
Maximum outside air temperature for free-cooling	18.33 (°C)
Maximum outside air enthalpy for free-cooling	69.78 ($kJ kg^{-1}$)

Table 3. Description of HVAC system

The daily occupancy, lighting, and HVAC schedules followed the specifications of ASHRAE **Standard 90.1 User's Manual** given in Figure 1. The schedule assumes a level of occupancy in the lecture room after 17:00 and on Saturday, which is quite different from normal schools but are similar to office buildings. Thus the schedules are referred to the office buildings.

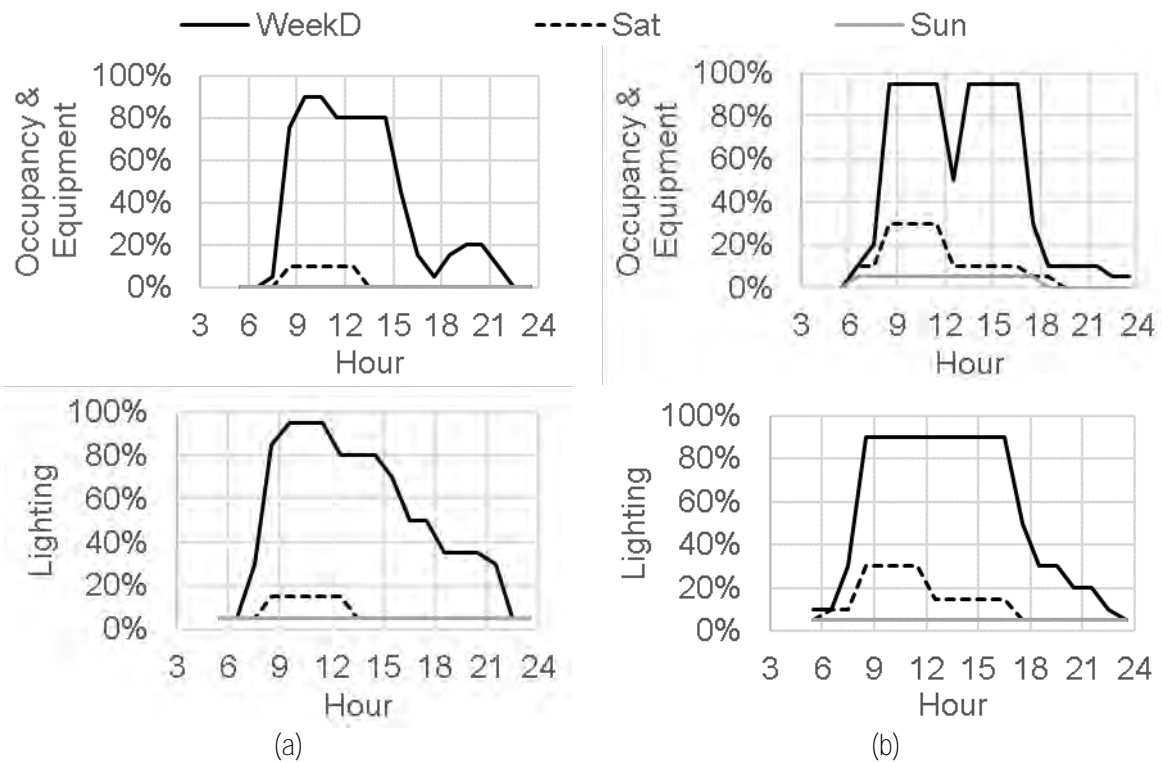

Figure 1: Schedule of occupancy, equipment and lighting usage for (a) Lecture Room; (b) Office

Month	Jan.	Feb.	Mar.	Apr	May	Jun	Jul	Aug	Sep	Oct	Nov	Dec
Date	1	8 to 10	25, 26, 28	4	2, 14	9	1	-	16	1, 10	-	26, 27

Table 4: Holidays of the school

To meet the building power needs by renewable energy, opaque photovoltaic (PV) panels were assumed to be installed on the walls and roof of the building. The semi-transparent PV was not used because of the low transparency and efficiency. The PV panels were assumed to account for 90% of the available areas and modelled using the in-built algorithm of eQUEST software. The generated electricity is fed the grid over the entire year. Table 5 specifies the installed PV module according to the manufacturer catalogue. The crystalline Silicon PV (cS-PV) with high efficiency is suitable to produce electricity on the building envelop with limited space. Table 6 gives the PV installations in the 4 cardinal directions and on the roof (22.3° due South). More PV panels were installed on the roof, East, West and South directions to harvest the maximum amount of energy.

Parameters	Open circuit voltage V_{oc} (V)	Short circuit current I_{sc} (A)	Max power voltage V_{mp} (V)	Max power Current I_{mp} (A)	V_{oc} temperature coefficient ($V/^{\circ}C$)	I_{sc} temperature coefficient ($A/^{\circ}C$)	Area (m^2)
cS-PV	64.9	6.46	54.7	5.98	-0.1766	0.0035	1.68

Table 5: Electrical data under standard test condition

Direction	North	East	South	West	22.3° due South	Total
PV area (m^2)	720	1,190	820	1,190	1,450	5,370

Table 6: Area of the PV in different directions

4. RESULTS AND DATA ANALYSIS

Figure 2 gives the annual electricity consumption and production by all power users and PV panels. Figure 3 presents the percentage of annual energy consumption and production. The annual electricity consumption was 634 MWh. The energy for chiller plant (chiller, heat rejection, and pump), lighting, equipment, and fans accounted for 51%, 25%, 16% and 8% of the total energy consumption. The great chiller and lighting power consumptions are due to the long summer season and year-round lighting needs, respectively. The annual energy consumption per area was 47 kWh/m², which is significantly less than the current benchmarks of 132 kWh/m² for building with central air-conditioning supply for tenants because of the efficient lighting, daylighting dimming, water cooled chiller and nature ventilation.

Since eQUEST assumes unshaded PV panels, the simulated PV panel power output was corrected by their percentage of unshaded hours. The annual electricity generation by PV panels is 640 MWh. The production by PV in East and West directions and the PV tilted by 22.3° due South accounts for 17.7%, 18.1%, and 42.0%, respectively. The power generation of vertically installed PV panels was 372 MWh, which is 58% of the annual building electricity demand.

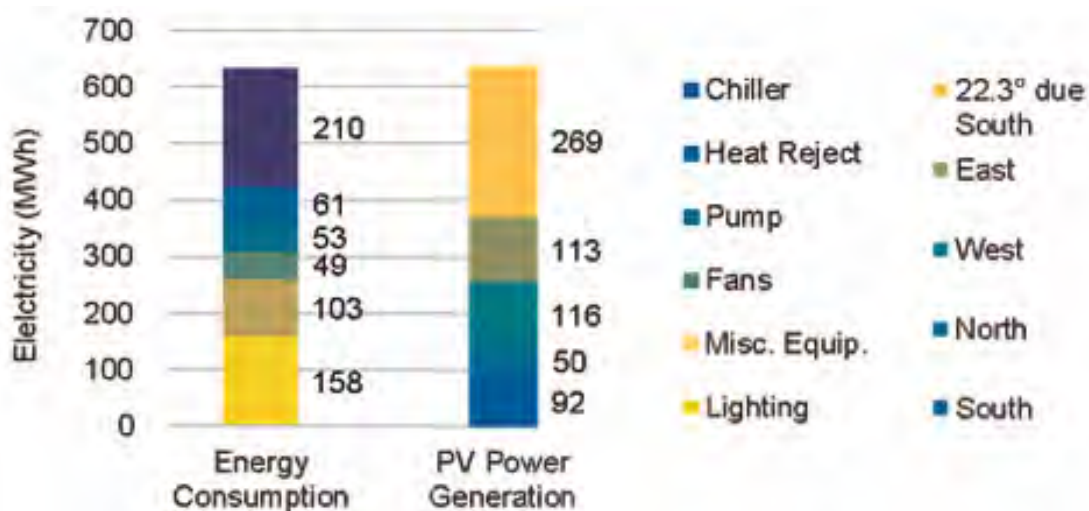

Figure 2: The annual power consumption by building and generation by PV

Figure 4 shows the monthly electricity consumption by different energy users of the building. The large energy consumption in Jul and Aug was because of the hot and humid summer in Hong Kong. The monthly lighting, and equipment energy use are similar because of the similar monthly schedule. The slight variations between months are because of the different public holidays in different months. The fan energy during winter seasons were consumed to meet the cooling demand due to internal loads by the outdoor air.



Figure 3: The percentage of year-round (a) Power consumption and (b) PV power production

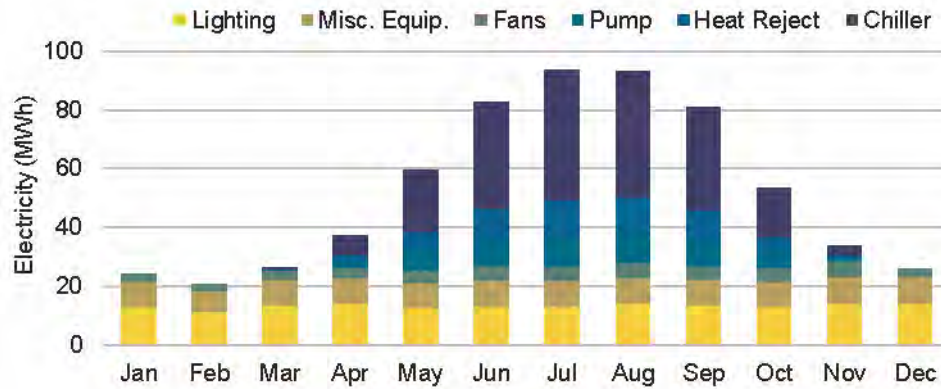

Figure 4: Monthly electricity consumption of different energy users in the building

5. CONCLUSIONS

The eQUEST energy simulation showed the annual energy consumption of an institutional building was about 634 MWh in total corresponding to 47 kWh/m². The energy was saved by daylighting in occupant zones, nature ventilation in the open corridor and atrium, high efficiency HVAC and building integrated photovoltaic (BIPV) panels. Such energy saving techniques were accessible from the present market and not complicate to impose. The annual energy production of vertically installed PVs covered 58% of the electricity use, installation on the roof balanced the rest 42%, which trade-off the annual energy consumption. The results are representative to buildings with the similar plans, load densities and schedules of occupancy, lighting, and equipment. The results show that the zero energy building in hot and humid climate can be achievable by energy saving measures and BIPV. Future work involves the analysis of life cycle cost, carbon savings and environmental benefits of such PV installations.

ACKNOWLEDGEMENTS

Work described was fully supported by a General Research Fund from the Grant Council of HKSAR [Project no. 9041896 (CityU 117713)]. Siwei Lou was supported by a City University of HK studentship.

REFERENCES

- [1] ASHRAE, 2008. 90.1 User's Manual ANSI/ASHRAE/IESNA Standard 90.1-2007. Atlanta, GA.
- [2] ASHRAE., 2007. ASHRAE Handbook: Fundamentals. Atlanta, GA.
- [3] ASHRAE., 2007. Energy Standard for Buildings Except Low-Rise Residential Buildings. Atlanta, GA.
- [4] ASHRAE., 2007. Ventilation for Acceptable Indoor Air Quality. Atlanta, GA.
- [5] Centre of Environmental Technology (CET)., 1999. HK-BEAM (New Offices): An environment assessment for new office designs. Version 1/96R, Hong Kong.
- [6] Chan, A.L.S., Chow, T.T., Fong, S.K.F. and Lin, J.Z., 2006. Generation of a typical meteorological year for Hong Kong. Energy Convers and Manage, 47, 87-96.
- [7] E-Series Commercial Solar Panels, SunPower Corporation [online]. Retrieved from: <https://us.sunpower.com/sites/sunpower/files/sp-e20-327-310-ds-en-ltr-mc4comp-helix-515662a.v3.pdf> [Retrieved on 27 September 2016].
- [8] EMSD., 2007. Guidelines on Performance-based Building Energy Code. Hong Kong.
- [9] EMSD., 2016. Hong Kong Energy End-use Data 2016. Hong Kong.
- [10] Energy Utilization Indexes and Benchmarks for Residential Commercial and Transport Sectors, EMSD [online]. Retrieved from: http://ecib.emsd.gov.hk/en/indicator_cmc.htm [Retrieved on 27 September 2016].
- [11] Hirsch JJ., 2016. The QUick Energy Simulation Tool (eQUEST) Version 3.65. Camarillo, CA.
- [12] Huang, Y., Niu, J.L. and Chung, T.M., 2013. Study on performance of energy-efficient retrofitting measures on commercial building external walls in cooling dominant cities. Appl Energy, 103, 97-108.
- [13] Kolokotsa, D., Rovas, D., Kosmatopoulos, E. and Kalaitzakis, K., 2011. A roadmap towards intelligent net zero- and positive-energy buildings. Sol Energy, 85(12), 3067-3084.
- [14] Li, D.H.W. and Lam, J.C., 2003. An investigation of daylighting performance and energy saving in a daylight corridor. Energy Build, 35(4), 365-373.

- [15] Li, D.H.W., Cheung, K.L., Wong, S.L. and Lam, T.N.T., 2010. An analysis of energy-efficient light fittings and lighting controls. *Appl Energy*, 87(2), 558-567.
- [16] Li, D.H.W., Yang, L. and Lam, J.C., 2013. Zero energy buildings and sustainable development implications – A review. *Energy*, 54, 1-10.
- [17] Li, D.H.W., Yang, L., Lam, J.C., 2013. Zero energy buildings and sustainable development implications—A review. *Energy*, 54, 1-10.
- [18] Lund, H., Marszal, A. and Heiselberg, P., 2011. Zero energy buildings and mismatch compensation factors. *Energy and Buildings*, 43, 1646-1654.
- [19] Mirrahimi, S., Mohamed, M.F., Haw, L.C., Ibrahim, N.L.N., Yusoff, W.F.M. and Aflaki, A., 2016. The effect of building envelope on the thermal comfort and energy saving for high-rise buildings in hot-humid climate. *Renewable and Sustainable Energy Reviews*, 53, 1508-1519.
- [20] Robert, A. and Kummert, M., 2012. Designing net-zero energy buildings for the future climate, not for the past. *Build Environ*, 55, 150-158.
- [21] Water cooled screw chiller, high efficiency, standard sound EWWD-H-XS, DAIKIN [online]. Retrieved from: http://www.daikin.be/docs/ECPEN15-466_LR-tcm478-377622.pdf [Retrieved on 27 September 2016].
- [22] Zeiler, W. and Boxem, G., 2013. Net-zero energy building schools. *Renew Energy*, 49, 282-286.

Net Zero Energy Building Policy: Benchmarking Australian Practices Against Some Asia Pacific Countries

Usha IYER-RANIGA^a

^a RMIT University, Australia, usha.iyer-raniga@rmit.edu.au

ABSTRACT

There is no doubt that the built environment is a key player in contributing to global greenhouse gas emissions. Globally, both best practices from industry and increasingly more stringent regulatory approaches have been used to arrest greenhouse emissions with varying success. In recent years, net zero energy building (NZEB) policies have been announced in Asia-Pacific countries such as Japan and Korea as radical measures to curb energy use so as to mitigate overall emissions.

NZEB definitions and approaches vary. Generally, however, they aim to increase energy efficiency in buildings, while also increasing the use of renewable energy in buildings and renewable energy use generation on site. Japan and Korea both have explicit NZEB policies with varying timelines.

Neither China nor Australia have explicit NZEB but both countries have used varying approaches to increase **energy efficiencies in the built environment. This paper examines Australia's regulatory policies in the building and construction sector in the context of such strong desires by governments in the Asia-Pacific to curb emissions. South Korea and Japan with their explicit policies on NZEBs and China with increased stringency all provide a point of comparative study to determine, what, if any, Australia needs to learn from its Asian counterparts.**

Australia's per capita energy use is one of the highest in the world. The paper commences by exploring the past and current regulatory policies and programs in Australia and a comparison is undertaken with the policies and programs of the identified countries: Japan, South Korea and China. Criteria for comparison are drawn, including; building types covered, energy efficiency approaches, role of various levels of government and compliance. Gaps are identified between these policies with discussions following focusing on the value of NZEB policy for the future of Australia.

Keywords: policy and standard, zero energy buildings, Australia

1. INTRODUCTION

A key message from the Rio+20 Conference in 2012 was that during the 20 years from the first Rio conference in 1992, the pace of change to make lasting changes to anthropogenic emissions needs to be accelerated. This is more so in the Developing Countries, where rapid building and construction activities are taking place. For example, China contributes to billions of sqm of new construction every year. In just one year, from 2010-11, new urban construction increased from 1.7 billion sqm to 2.2 billion sqm (Wei, 2012).

Being a part of the Asia-Pacific, **it is in Australia's interest to keep abreast of policies and programmes with her Asian neighbours. South Korea and Japan have introduced Zero Energy Building policies (ZEB) in recent years, as has India. China, Australia's largest trading partner has not set up any such policies, but they have a strong energy efficiency programme led by the central government in China. Australia does not have a ZEB policy yet, but this is changing.**

Energy efficiency in buildings has at least a forty-year history. The literature is rich with examples of energy technology in theory and practice, thermal comfort, energy use, role of behaviour in energy use and operational waste associated with energy use in buildings in residential and non-residential buildings (Masoso and Grobler 2010, Choi et al 2011, Hauge et al 2011, Sandy 2011 to name a few). Regulatory impacts on energy efficiency have been studied by authors such as Heijden (2016).

The aim of this paper is to undertake a comparative study to examine whether a lack of current ZEB policy is a lost opportunity for the building and construction sector in Australia. A comparative study of the policies in the countries

identified is undertaken using a range of pre set criteria including legislative underpinnings, energy efficiency regulation through the building code, operational performance of buildings and other market based schemes.

This paper commences with definitions of ZEB and associated terms. This is followed by the regulatory landscape in Australia with respect to buildings, both from a design and performance perspective. The regulatory landscapes in Japan, South Korea and China are then presented with attendant roadmaps for ZEBs where applicable. Discussions follow, focusing on the similarities and differences between these approaches leading to the conclusions. The paper concludes that despite a lack of a national ZEB policy, Australia can still make some inroads in reducing its overall emissions due to the focus on reducing operational energy in buildings.

1.1 Definitions of zero energy building (ZEB)

There is no acceptable standard definition of ZEB. Most of the definitions of ZEB do not consider the energy used to build a building, the capital energy or the embodied energy using standard approaches of life cycle inventory analysis. Nor does it refer to the embodied energy for household products and appliances. Yet, this information is critical as the popular meaning attributed to ZEB refers to operational energy use: that is, energy drawn from the grid to operate the building being the same as the energy given back to the grid. The operational energy is typically used for heating, cooling, ventilation, lighting and cooking and for using household appliances in the residential sector and similar uses in the non-residential sector. Net zero from this perspective offers the grid as a source and **a sink for energy (Hernandez and Kenny 2010), thus the term 'net' refers to the energy balance between energy used and energy sold or drawn from the grid.** This offers the opportunity to avoid using energy storage systems, making the system more flexible, though not necessarily cost effective.

Net zero site energy means that a site produces at least the same energy as it uses in a year, independent of the type of energy produced or used (Torcellini and Crawley 2006). Net zero source energy concerns imported and exported energy multiplied by a primary energy conversion factor, enabling flexibility in the heating fuels (Torcellini and Crawley 2006, Torcellini et al 2006). Emissions zero energy refer to renewable supply options on site and off site, based on the fuel supply and associated emissions. Zero energy costs involves the costs only where the use and purchase of energy ends up with a zero balance (Marszal et al 2011).

Recently green buildings have also made its way into the lexicon alongside discussions of energy efficient, low energy and passive buildings. Green buildings generally take a more holistic approach, where energy is one of many considerations; alongside water, waste, materials, building management, site responses, access to transport and indoor environmental quality (Hauge et al 2011). In addition to green building, low carbon has also been included in the discussions where the source of energy use may be low carbon, such as nuclear energy (Kibert and Fard 2012).

The next section considers the regulatory landscapes in Australia, Japan, South Korea and China.

1.2 Regulatory landscape in Australia

Australia aims to reduce emissions to 26-28% on 2005 levels by 2030 (Australian Government 2015a). The main aim to achieve this is through direct action policies to reduce emissions, increase energy productivity and improve the environment. In addition to emissions reduction fund, Australia has a renewable energy target, energy efficiency improvements, phasing out greenhouse gases and direct support in low emission technologies and practices.

There are two recent developments in Australia, focusing on two standards: The National Carbon offset Standard for Buildings and the National Carbon offset Standards for Precincts. While these are in a consultation stage, it is anticipated that Australia is developing not only clear definitions, but also voluntary standards for carbon neutrality and net zero including, NZEB for buildings and precincts. These developments support global and regional developments focusing on reducing global net carbon emissions.

From a regulatory perspective the country has a centralised approach to building code administration through the Australian Building Codes Board (ABCB). The Australian Building Codes Board (ABCB) is a joint initiative of all three levels of government and includes representatives from the building and plumbing industries. The Board was

established by an Inter-Government Agreement (IGA) signed by the Commonwealth, States and Territories on 1 March 1994 (ABCB, 2016a, ABCB 2016b).

The Board's mission is to address issues relating to safety, health, amenity and sustainability in the design and performance of buildings through the National Construction Code (NCC) and the development of effective regulatory systems and appropriate non-regulatory solutions (ABCB 2016b). The ABCB therefore, has input from the Australian States and Territories in the development of the NCC for Australia. The ABCB develops, maintains and administers the NCC. While the ABCB set the agenda for the future of Australia, the ABCB recognises regional differences in the form of state based variations. Compliance for the building code is undertaken at the local level through state based jurisdictions. Building code compliance is generally seen as base level and therefore, represents minimum standards.

Energy efficiency and sustainability became key objectives of the Building Code in 2000 (ABCB 2016a). Commercial and residential sectors are covered. Market leadership and transformation is led by voluntary rating tools, spear headed by the Green Building Council of Australia (GBCA). The Green Star suite of tools developed by the GBCA ensures existing and new buildings conform to overall sustainability, with a major focus on energy-efficient building designs. The National Australian Built Environment Rating System (NABERS) developed by NSW government, but now applied nationally, focuses on actual performance of operational parameters in a building through evidence of the use of energy, water, waste and indoor environmental quality (NABERS 2016). Therefore, NABERS focuses on operational performance unlike the NCC and the Green Star suite of tools.

In 2000, the ABCB announced that it would mandate energy efficiency requirements in the Building Code of Australia (BCA). In 2003, energy efficiency housing provisions were introduced (performance of the building fabric, choice of glazing, sealing the building and such similar measures), with multi residential building provisions introduced in 2005. Non-residential building provisions were introduced the following year; and in 2006, housing stringency was increased to a minimum 5 Star requirements. In 2010, non-residential building stringency and multi residential building stringency was increased, with housing stringency also increasing to 6 Star minimum (ABCB 2016a). At the same time, the Building Energy Efficiency Disclosure Act 2010 was introduced (Australian Government, 2015b), where non-residential buildings over 2000 sqm were required to display their energy use as determined by NABERS rating at the point of lease or sale. This Act was further updated recently in 2015, where **'lighting energy efficiency assessment in relation to a building—an assessment of the energy efficiency of lighting if the building is sold, let or sublet'; or as applied in relation to an area of a building (Australian Government 2015c).**

1.3 Regulatory landscape in Japan

Japan's long term target is to reduce CO₂ emissions by 60% to 80% by 2050. The Japanese government estimated in 2015 that if current energy saving measures were to continue, the energy consumption to 2030 would be more than 10% percent of the 2013 figures (IEE Japan 2015). The genesis of the changes commenced in 2008 when the energy conservation law was passed. Buildings over 2000 sqm were required to submit a report for energy saving. Aligned with this was a recommendation made for middle to small scale housing project of 300 sqm to present reports on energy use (enforced in 2010 as a recommendation rather than mandatory compliance), **introduction of a "top runner" program for a single house supplied by builders selling 150 or more houses annually.** In addition to these are a labelling system for energy saving performance of house or building (Terao 2012).

It is anticipated that by 2030, all new homes would be Zero Energy. Examples of zero energy will need to be made available to the market by 2020. Some of the ways to achieve this are to increase energy efficiency standards, strengthening enforcement of the energy saving act, promoting energy efficiency residentially with appropriate rating and enhancing the more stringent regulations with tax incentives. Supporting technological innovations is critical, but it is acknowledged that this is not the only driver to achieve ZEB. Control interface for lighting, air conditioning, and data specs for energy efficiency in small and medium sized building has also been included.

1.4 Regulatory landscape in South Korea

Building energy consumption contributes to 21% of the total Korean energy consumption, and is expected to increase to 40% by 2030 (Schuetze 2015). The goal is to reduce the greenhouse gas (GHG) emissions in the building sector by a third of business as usual by 2020. The approaches used to achieve emissions reduction are

strengthening building energy regulations and standards. This includes improving energy efficiency of existing buildings, encouraging energy conscious behaviours by users and development of green building technologies and infrastructure systems.

Energy efficiency improvement during the period 2012-2025 takes a stepped approach, such that by 2025, residential buildings have a net zero energy consumption and non-residential buildings have an energy saving rate of 60% of the current energy use. Similar to Japan, the move to the zero energy house is to progress from an energy intensive house in 2009 to a low energy one in 2012, and improve the stringency further thereafter to 2025. This is undertaken through the use of passive house approaches in 2017, leading to ZEB in 2025. A low energy house is expected to save 30% energy and a passive house 60%. Likewise, for non-residential buildings, savings in 2012 was expected to be 15%, 30% in 2017 and 60% in 2025 (Choi 2012).

In South Korea, the government formulated the Low Carbon Green Growth in 2009 (Kang et al 2012). In developing this policy, three main areas were focused upon: regulations, incentives and information. Building energy codes focus on energy efficiency for new and existing buildings (Evans et al 2009). Furthermore, since the residential sector dominates energy use and associated impacts, this has been a key area of focus (Choi 2012). An obvious downside to this plan is that the cost of energy efficiency is still being worked out.

1.5 Regulatory landscape in China

China does not have an explicit ZEB policy. However, there is a very strong focus on energy efficiency, which is a critical path forward for zero energy policies. The Chinese government has enacted several laws on energy conservation and **emission reduction; being the Law of the People's Republic of China on Conserving Energy, the Law of the People's Republic of China on Renewable Energies, and the Regulation on Civil Building and Energy Conservation**. Five year plans are drawn by the national government enacting various policies, and building energy efficiency is a crucial part of these five year plans. China has just moved from its 12th and is currently in its 13th 5 year plan (Wei 2012). Given the scale of building and construction in China, the potential for energy conservation is huge. In China, the proportion of end use energy through building and construction is about 28% whereas in most Developed Countries this figure is approximately 40% (Wei 2012).

As far back as 1986, China brought in energy efficiency codes for buildings, wherein depending on the location, the building was required to meet 50% or 65% energy efficiency. Compliance information demonstrates that new builds have met the energy efficiency requirements and therefore, provide improvements of 46% and 49% over 2005 levels. In the current 13th 5 year plan, the aim is to further increase energy efficiency by another 30%. This is supplemented by monitoring of energy use in state office and public buildings.

In addition to energy efficiency, materials use through construction process and methods has also been an area of focus. Use of green construction methods has the potential to reduce energy consumption by 20% per sqm, water consumption by 63%, timber formwork construction by 87% and general construction waste may be reduced by up to 91% (Wei 2012). Since housing is a huge demand in China, pre fabrication technology, demonstration projects, use of new technology and new construction methods are all being disseminated through information and training, which can be applied to both the high end developers and the small-medium enterprise. Renewable energy use particularly for water heating has a growing market in China and use of photo voltaic for building operation is gathering momentum both in urban and rural housing. The next section presents discussions resulting from these ZEB policies.

2. DISCUSSIONS

The aim of establishing and effecting ZEB policies and programmes are to ultimately impact global carbon emissions. This section considers the various ZEB policies to understand whether the lack of a current ZEB policy **deters Australia's ability to guide and lower carbon emissions. Building regulations generally commence from a base of meeting minimum standards of safety and amenity. Energy efficiency and sustainability are recent objectives added to these minimum criteria from the year 2000 in Australia. Building regulations have also generally moved from prescriptive to performance based codes and this has assisted in ensuring minimum benchmarks outcomes are realised for the building industry in Australia. Australia's compliance with the building code may be through deemed to satisfy measures, performance based approach or a combination of the two.**

While energy efficiency is a central tenet of policies in a number of countries as shown in Table 1, very few countries consider or monitor actual energy use through building performance. Furthermore, the type of energy use is not mandated or referred to in any way. Yet, the definitions of ZEB and relating discussions refer to renewable energy sources located on the building, on site or off site; source or primary energy and delivered or site energy; and energy sources and their associated utilisation factors accounting for the efficiencies in processing, transporting, converting and delivering fuel or energy from the point of extraction to the building site.

Policies/ legislation	Australia	China	Japan	S. Korea
Sustainability as a guiding principle as policy/ guideline	Yes	Yes	Yes	No
Zero energy building policy	No (in early stages of development)	No	Yes	Yes
Energy efficiency in the building code/ energy efficiency mandated through regulation	Yes	Yes	Yes major renovations above a certain size	Yes
Applicability of energy efficiency to existing buildings	Yes not blanket though	Yes	Yes major alternation or renovation	Yes voluntary labelling
Operational energy performance mandated	Yes	No	No	No
Other market based mechanisms/ voluntary schemes	Yes (Green Star)	Yes	Yes (BELS and CASBEE)	Yes

Table 1: Comparative table of ZEB/ energy efficiency policies in chosen countries

Thus, while other countries may strive to achieve real targets set for energy efficiency through ZEB as Japan or South Korea have done or through increasing stringency in energy compliance as China has tried to achieve, the fact remains that none of these countries have any policies or targets that evidences actual energy use as Australia has mandated, through the NABERS rating. Even though these targets are not mandatory annual reporting targets, it does place pressure on demonstrating energy efficiency in buildings, albeit at the point of lease or sale. Building owners need to pay attention to energy efficiency in their own buildings, particularly when considering rising costs of energy and to stay abreast of market competition. It does not mean that there will be flurry of activity for building owners to start retrofitting their buildings but the link between energy use and sale does act as a clear driver as a first step to demonstrate and provide evidence of energy efficiency.

3. CONCLUSIONS

This paper set out to understand if Australia's lack of a currently stated ZEB was hindering Australia from meeting its energy efficiency goals in the built environment. Energy efficiency is considered to be an important aspect of sustainability. Sustainability objectives have become part of building regulations not through the building regulatory process itself, but due to other national and international pressures and these have yet to be fully assessed. In Australia, energy efficiency measures have been mandated, both from a design and a performance perspective but is not consistently applied in the residential and non-residential sectors.

Lack of explicit ZEB policy in Australia is not necessarily a down side. As long as there are mechanisms to monitor actual performance, Australia is in a better place as this squarely places the debate from intent to actual disclosure and how best to fit technology, people and processes to enhance disclosure. Regulation alone is insufficient to realise energy reductions. The question remains however, as to how best to enhance disclosure in the market, most notably in the residential sector so to maximise impact. A more holistic approach needs to be reinforced such that greater collaboration between all sectors (regulatory and non-regulatory) can create positive synergies between market pressures, regulation and current energy efficiency instruments such that leading edge practice today can become tomorrow's minimum standard, reinforcing current paradigms towards energy efficiency and sustainability.

REFERENCES

- [1] ABCB 2016a. NCC Volume One Energy Efficiency Provisions Handbook Non-Mandatory Document. Fourth Edition ed. Canberra, ACT: Australian Building Codes Board.
- [2] ABCB 2016b. NCC Volume Two Energy Efficiency Provisions Handbook Non-Mandatory Document. Fourth Edition ed. Canberra, ACT: Australian Building Codes Board.
- [3] Australian Government. 2015a. Australia's 2030 Climate Change Target. In: Department of Environment, Canberra.
- [4] Australian Government. 2015b. Building Energy Efficiency Disclosure Act 2010. In: Office Of Parliamentary Council (ed.) No 67, 2010. Commonwealth of Australia.
- [5] Australian Government. 2015c. Building Energy Efficiency Disclosure Amendment Act 2015.
- [6] Choi, J.H., Loftness, V. & Aziz, A. 2011. Post- occupancy evaluation of 20 office buildings as basis for future IEQ standards and guidelines. *Energy & Buildings*, 46, 167-175.
- [7] Choi, J.Y. 2012. Policy for Net Zero Energy Buildings in Korea. Approach Towards Energy Efficient Building: Special Focus on Zero Energy Building. Asian Heat Pump & Thermal Storage Technologies Network.
- [8] Evans, M., Chon, H., Shui, B. & Lee, S. E. 2009. Country report on Building energy codes in the Republic of Korea. Pacific Northwest National Laboratory.
- [9] Hauge, Å. L., Thomsen, J. & Berker, T. 2011, J. & Berker, T. 2011. User evaluations of energy efficient buildings: Literature review and further research. *Advances in Building Energy*, 5, 109-127.
- [10] Heijden, J. V. D. 2016. The new governance for low-carbon buildings: mapping, exploring, interrogating. *Building Research & Information*, 44, 575-584.
- [11] Hernandez, P. & Kenny, P. 2010. From net energy to zero energy buildings: Defining life cycle zero energy buildings (LC-ZEB). *Energy & Buildings*, 42, 815-821.
- [12] IEE Japan. 2015. Japan: Government estimates the effects of energy conservation, various energy-saving measures to be implemented. In: New Energy Group, New & Renewable Energy and International Cooperation Unit.
- [13] Kang, S. I., Oh, J.G. & Kim, H. 2012. Korea's Low Carbon Green Growth Strategy. In: OECD Development Centre, OECD.
- [14] Kibert, C. J. & Fard, M. M. 2012. Differentiating Among Low-Energy, Low-Carbon And Net-Zero-Energy Building Strategies For Policy Formulation. *Building Research & Information*, 40, 625-637.
- [15] Marszal, A. J., Heiselberg, P., Bourrelle, J. S., Musall, E., Voss, K., Sartori, I. & Napolitano, A. 2011. Zero Energy Building – A Review Of Definitions And Calculation Methodologies. *Energy & Buildings*, 43, 971-979.
- [16] **Masoso, O. T. & Grobler, L. J. 2010. The Dark Side Of Occupants' Behaviour On Building Energy Use.** *Energy & Buildings*, 42, 173-177.
- [17] NABERS 2016. Introduction To NABERS [Online]. Retrieved from <https://nabers.gov.au/public/webpages/home.aspx> [Retrieved 25 September 2016].
- [18] Sandy, B. 2011. Barriers And Drivers To Green Buildings In Australia And New Zealand. *Journal Of Property Investment & Finance*, 29, 494-509.
- [19] Schuetze, T. 2015. Zero Emission Buildings In Korea—History, Status Quo, And Future Prospects. *Sustainability*, 7, 2745-2767.
- [20] Terao, Y. 2012. Approach Towards ZEB In Japan. Approach Towards Energy Efficient Building: Special Focus On Zero Energy Building. Asian Heat Pump & Thermal Storage Technologies Network.
- [21] Torcellini, P. A. & Crawley, D. B. 2006. Understanding Zero- Energy Buildings. *ASHRAE Journal*, 48, 62-69.
- [22] Torcellini, P. A., Pless, S. & M., A. D. 2006. Zero Energy Buildings: A Critical Look At The Definition. Acee Summer Study August 14–18, 2006, 2006 Pacific Grove, California.
- [23] Wei, X. 2012. Towards Net Zero Energy Buildings In China. Approach Towards Energy Efficient Building: Special Focus On Zero Energy Building. Asian Heat Pump & Thermal Storage Technologies Network.

Session 6.10: Innovative Practices to Transform SBE (1)

Comparative Analyses: Urban Quality, Living Standard, Sustainability. Modernist Housing Estate Vs 21st Century City

Aleksandar TEPAVCEVIC^a

^a Graz University of Technology, Austria, aleksandar.tepavcevic@tugraz.at

ABSTRACT

Observed in the context of the position of large modernist housing estates against contemporary living standards, there are few dominating problems regarding the large modernist housing estates: high energy consumption and the mono-functionality and lack of identity of the urban quarters which question the legitimacy of their existence. Therefore, their future will be largely dependent on their potential to successfully re-integrate themselves into the proclaimed vision of self-sustainable cities and society for the 21st century. In order to explore their current status regarding the requirements of the future city, this paper is analyzing representative example of the modernist housing estates and comparing it with selected examples of the latest contemporary urban development projects in Europe. As a result, this paper provides a comparison chart which involves most important categories of all four masterplans, including building and population density, urban structure, traffic and energy concept, and apartment standards. The chart serves to highlight their similarities and differences, which will visualize the actual gap **between the modernist housing estate from the 1960's and contemporary urban design projects promoting the 21st century living standards.**

Keywords: housing estates, refurbishment strategy, urban development, 21th century city

1. INTRODUCTION

The demands of the envisioned standards for the 21st century society are putting serious pressure on our ecosystem and environment. Growing population accompanied with increased living standard expectations and consumer oriented lifestyle is leading towards ever-growing demand for new resources and energy production. **This "hunger" for energy and resources which continuously modifies the earth's surface, is resulting with decrease of agricultural land and fresh water supply, deforestation, and causing serious climate changes. As a significant contributor to the "global warming" phenomena, the building industry is responsible for about 40% of total energy consumption and therefore potentially could play a big role in the switch towards a green and self-sustainable society.** In this process the concepts of renewable production, recycling and reuse of the resources and energy are inevitable factors which can contribute and secure the desired development goals and standards. Their implementation, both in the area of energy production and in the development of recycled building materials have opened new possibilities for the construction industry. The Nearly ZEB energy standard [1], introduced by European Commission and set for year 2020 for all new buildings, is one of the key parameters which define the sustainability standards of the 21st century city. Pioneering projects of new buildings, quarters and urban masterplans with aforementioned requirements are being built worldwide. The Masdar City, in the UAE, is planned to be one of the first zero-carbon cities driven solely on renewable energy supply [2]. However, most of these promising projects are built on vacant agricultural areas detached from existing urban settlements, which offer no constraints in terms of urban planning and solar exposure, density, etc. Therefore, the application of the, so called, **"tabula rasa" approach might not be suitable in case of already built cities. In this context, one of the crucial questions for the future is how to deal with the existing cities and neighborhoods which were built under different social and political concepts and premises. Until present, very few project have been realized in this field. The new-built "Aktiv Stadthaus" – a residential project in Frankfurt, GER [3] constructed in dense urban environment and the "Plusenergie Haus" – a 1960's prefab housing refurbishment project in Kapfenberg, AT [4] are among first built representatives of the active house solutions on a single building level. On the urban quarter level, there are no comprehensive attempts to tackle this challenge. Neighborhoods erected in different epochs of the city's development might require substantially diverse approaches. This research will focus on modernist housing estates. Understanding and comparing their urban concept with latest planning policies, should give insight in their overall**

condition and level of matching their standards with the up-to-date living requirements. The discussion will be presented in the comparative analysis chapter.

2. THE 21st CENTURY CITY

In order to accomplish this task, it is necessary to analyze and understand the living standards of the 21st century city, set by the society. Numerous architectural theoreticians and practitioners are discussing the validity of current urban and architectural practice, stating that a city for the 21st century should be led by a vision independent from current dominating practices and organized in a more efficient way in order to better respond to global challenges [5, 6]. In some aspects this theoretical approach proposes parallel reform and improvement of our socio-economic system, and therefore remains at this stage more in the domain of conceptual contribution towards the idea of the future society. After failure of modernist urban principles and clear separation of urban functions which created segregated the city structure, current policies favour the return to mixed use urban quarters which should improve everyday life quality in the neighborhoods and city quarters. Distribution of different typologies within the mixed **use scenario is mostly affected by “free market” laws of demand and supply and does not follow any theoretical premises.** Although the rapid urbanization process of the South-East Asia region, especially in countries like China and India, produce enormous urban activities, for the purpose of comparative analysis, as case study examples have been chosen 3 masterplan projects in Europe: Seestadt Aspern – satellite city in the outskirts of Vienna, Austria; Hafencity – city core expansion on the former docklands of the Elbe River in Hamburg, Germany; and Nordhavn – an urban district built on the former harbour area of Copenhagen, Denmark.

These particular urban development projects were chosen for several reasons. All of them are situated in countries with the highest level of economic and social development, which serve as landmarks for life standard quality on a global level. In these countries the social aspect of the **city planning and the “human scale” approach** is traditionally playing a significant role. Cities like Vienna, Hamburg and Copenhagen are internationally recognized as eco-friendly cities with good social system and social housing infrastructure, efficient traffic organization, introduction of new and green mobility concepts, diverse and rich offer of green and leisure areas, shopping facilities and touristic attractions. All these qualities place them, according to respective surveys [7], on top of the list of **most livable cities worldwide. Their desire to take a leading role in remodeling existing cities upon “smart organization” and “sustainable development” criteria, should be reflected through these development projects.** Application of advanced building technologies and innovative heating and cooling concepts, introduction of new mobility concepts, green energy supply, limitation of energy consumption, are qualifying them as cutting edge urban development projects in Europe and worldwide. All of them tend to promote themselves as examples of 21st century city which represent the high-quality urban living standards set for the future society. At last, the similarity of their size, urban program and climatic environment with modernist housing estates, indicates that conclusions gained from the 3 case study examples might be applicable during housing estates reconstruction.

3. MODERNIST HOUSING ESTATES

Built after WWII, as a reaction to postwar housing shortage, the modernist housing estates were often used as a part of the rebuild process of the cities throughout Europe and worldwide. Originally, due to small budgets, housing **estates were imagined as low cost transitional accommodation solutions for the period of country’s fragile uprising economy.** They represent first standardized urban design schemes – housings units made out of prefabricated concrete construction and façade-enclosing elements, which allowed quick assembly on site and relatively long durability. Huge demand on affordable living space and fast construction process triggered their hyper production. These housing estates still make a great portion of the urban tissue in many cities. Due to increased concerns over high energy consumption, their mono-functionality, lack of urban qualities and public depreciation, these housing are often being demolished and replaced with new development schemas [8, 9]. Demolition process is usually connected with both big financial efforts and energy consumption (grey energy). On the other hand, the similarity of their construction and functional logic with contemporary housing buildings indicates that, with a reasonable amount of efforts, a comprehensive reconstruction approach could lead to plausible results.

As a case study example, for the purpose of comparative analysis, has been chosen Nordweststadt housing estate in Frankfurt, Germany, located in the north-west suburban area of the city and built in period 1961-1972. An original, open, pavilion type of urban configuration brought different type of urban qualities in the relatively coherent city layout of Frankfurt. Over the decades, Nordweststadt retained in most of the aspects its positive image as a

peaceful, family-oriented city quartier, favorable among its inhabitants. Still, due to aging of the materials and the construction

which point out on necessary maintenance of the building and public feedback of the residents about living conditions, which clarified the deficiencies of the housing estate, a sort of “cosmetic” reconstruction proposal has been requested from the local authorities. For this purpose, an architectural competition for the area has been announced and carried out, but the prize-winning results remained on paper, with uncertain future scenario regarding their completion.

4. COMPARATIVE ANALYSIS

The comparative analysis chart represents the “ID card” of the case study projects. The chart has been divided into four sub-categories, each focusing on different aspects of the masterplan and representing their most important figures and characteristics: masterplan features (Table 1) urban design concept (Table 2), residential quartier concept (Table 3), residential building concept (Table 4). Accompanying text, under the table, serves to highlight the most important conclusions and to explain relevant details and situations, not presentable in tabular overview. For the purpose of better orientation in the text, the case studies will be represented under following abbreviations: [SA] for Seestadt Aspern, [HC] for Hafencity, [NH] for Nordhavn and [NW] for Nordweststadt.

4.1 Masterplan features

In Table 1, most important general facts and figures of selected projects regarding the construction date and volume, density, population and location are presented.

Location	Seestadt Aspern [10]	Hafencity, Hamburg [11]	Nordhavn, Copenhagen [12]	Nordweststadt, Frankfurt [13]
Facts & Figures				
Year of construction	2007-2030	2001-2025	2012-2060	1961-1972
Area size (ha)	246	155	350	170
Total built area GFA (m ²)	2 600 000	2 500 000	2 875 000	1 150 000
Population	20 000	14 000	40 000	17 000
Workplaces	26 000	45 000	40 000	n/a
Population density (person/ha)	100	110	87.5	106
Building density (m ² /ha)	10 569	16 129	8 215	6 765
Distance to center (km)	13	2	4	8

Table 1: Masterplan features

The data analysis, shows that the population density remains relatively similar on all analyzed sites, regardless of construction period or the size of the design scheme. Regarding the position of the urban districts within the city and their distance to city center, despite obvious advantages of the two new masterplans [HC, NH] all 4 locations have good connection with the city center, reachable within 30 minutes by car or public transportation. On the other hand, an obvious difference is noticeable when comparing the number of workplaces provided on the site. Despite having a commercial center and public facilities which offer a certain amount of jobs, most of the residents of NW are commuting to other part of the city for the work purpose. Relatively low building density in NW, allows possibility for meaningful densification which would try to bridge the gaps towards new development proposals [SA, HC, NH].

4.2 Urban design concept

Table 2 is consisted of the categories, important for the understanding of the structure and functioning of the urban design scheme: urban structure, transportation concept and energy concept.

Location	Seestadt Aspern [10]		Hafencity, Hamburg [11]		Nordhavn, Copenhagen [12]		Nordweststadt, Frankfurt [13]	
Urban structure								
Mixed use (GFA)		%		%		%		%
Housing (m ²)	1 202 038	51	800 900	32	1 700 000	66	1 016 400	89
Office/Commercial (m ²)	686 135	29	1 639 200	65	726 000	28	98 000	9
Social Infrastructure (m ²)	70 040	3	54 700	13	65 000	2.5	14 670	1
Culture/Education (m ²)	27 036	1			74 000	3		
Sport facilities (m ²)	39 141	2			10 000	0.5		
Industry (m ²)	341 364	14	n/a	/	n/a	/	18 200	1
Greenery (m ²)	653 044	/	274 000	/	330 000	/	230 500	/
Water (m ²)	52 225	/	281 000	/	300 000	/	n/a	/
Transportation concept								
Metro line	provided		provided		provided		provided	
Bus line	provided		provided		provided		provided	
Cycle pathways	provided		none		provided		provided	
Electro car/ car sharing	provided		provided		provided		provided	
other	n/a		boat		boat		n/a	
Distance to station(m)	250		350		400		300	
Parking places	25 000		6 700		15 000		5 000	
Energy concept								
Heating	district		district		district		district	
Cooling	none		none		sea/groundwater		none	
Renewable energy	solar		solar		solar/wind		none	
Geothermal energy	used		used		used		not used	
Energy standard	passive house		DGNB gold		passive house		not defined	

Table 2: Urban design concept

All four projects [SA, HC, NH, NW] represent mixed use urban developments which mix residential with other urban functions - commercial, educational, cultural, religious, public, sport, leisure, etc. Two main differences between the modernist housing estate [NW] and the new development projects [SA, HC, NH] are high share of residential function in NW against the other functions (89% -11%) - which gives this district predominantly residential character, and the urban function distribution concept. The structure in the NW is following modernist design guidelines, which assume clear segregation of functions, and separate the urban tissue into few mono-functional clusters. Opposite to that, SA, HC and NH are successfully mixing functions, securing vibrant and dynamic neighborhoods which have significant impact on the increase of the life quality. Possible solution for neutralization of these differences, could be a solar optimized densification approach in respect with urban logic of the NW, with necessary functional typologies (commercial, office, cultural) and restructuration of the existing space, which could introduce new qualities to the district.

The transportation concept is based on the idea of a “5-minute district” (public transport station is reachable within 5-minute walk distance) and offers similar qualities for all selected locations [SA, HC, NH, NW]. Good traffic infrastructure, including metro and bus lines, light trains, boats [HC, NH], car sharing, etc. provide fast connection with the city center. Parking facilities are provided in underground parking garages or as a part of the street profiles, located within close proximity to the apartments. Still, due to absence of an adequate direct connection between **the resident’s apartment and his parking place in the garage, almost 50% of the capacity in NW is unused.** A qualitative difference is visible in the circulation inside the districts and in the quality of public green areas. The pedestrian communication through the green areas is not disabled-friendly on all segments, while the absence of the road hierarchy make orientation in the district [NW] difficult. Lack of planned biking lanes forces cyclists to use alternative paths. Untrimmed greenery combined with **inadequate public lighting system create “dark pockets”** which cause a feeling of insecurity and fear among the residents, especially by night. Qualitative features of other 3 masterplans [SA, HC, NH] such as: construction of separate biking lanes [SA, HC] and the implementation of the **“cycle superhighway” concept in NH, disabled friendly pedestrian road network created with systems of ramps and terrain regulation, road hierarchy achieved through variety of designed road profiles, and application of new materials and coloristic schemes on the urban equipment, could all be implemented to improve the quality of the public spaces and the communication inside the NW housing estate.**

In terms of energy concept, for the purpose of sustainable energy supply for the districts, in case of NW, it was **built a “waste to energy” power plant, but no limitation in terms of energy consumption has been determined.** Rest projects [SA, HC, NH] use renewable energy sources - sun, wind and geothermal energy and have set at least a passive house standard for energy consumption of the buildings. Low building density and big gaps between the buildings in NW, secure their above-average sunlight exposure, both on roof and façade surfaces, and could ensure significant energy production through implementation of photovoltaics and solar thermal panels. This approach could improve its energy balance and raise their overall sustainability.

4.3 Residential quartier concept

Table 3 is mostly focusing on categories necessary to describe the structure of the residential quartier: block typology, housing typology and the apartment structure.

Location		Seestadt Aspern [10]	Hafencity, Hamburg [11]	Nordhavn, Copenhagen [12]	Nordweststadt, Frankfurt [13]
Residential block structure					
Block typologies	Housing	23%	22.5%	90%	90%
	Housing + commercial ground floor	67%	43.75%	10%	10%
	Housing + commercial (25-50%)	6%	18.75%	/	/
	Housing + commercial (50-75%)	3%	15%	/	/
Mixed use		yes	yes	yes	no
Plot ratio		2-3	3.7-6.1	1.8	0.78
Housing typologies	single-family	/	/	/	14%
	terraced	/	/	5%	
	multi-family	100%	100%	95%	86%
Apartment structure	1-room	4%	13%	5%	5%
	2-room	37%	39%	15%	20%
	3-room	40%	33%	50%	60%
	4+ room	19%	15%	30%	15%
Ground floor height (m)		4.5	4.5-7	4	2.5
Ground floor function		mix use	mix use	mix use	residential
Green area function		public/private	public/private	public/private	public
Parking facilities		park garage	park garage	park garage	park garage

Table 3: Residential quartier concept

Residential blocks in NW are consisted of few multi-storey housing prototypes, which in combination with detached houses and terraced housing, create porous pavilion type urban quartiers with residential ground floor use. This logic allows big green areas between the buildings, but offers no private courtyards for residents. Insufficient distribution of playgrounds and urban equipment cause public ignorance of these spaces and their further decay. Enclosure of these quartiers on the ground floor area would separate public from private green area, while introduction of various urban functions for all citizen categories including children playgrounds and social spaces for senior citizens would raise the quality of green surfaces on a level of other 3 masterplans [SA, HC, NH]. While apartment structure remains relatively similar in all four cases, the social structure of buildings in SA, HC and NH offers living space in all categories from low income to luxury apartments. By adding roof extension projects on top of the modernist housing estates [NW], new forms of living units including penthouses could occur and eliminate this disadvantage.

4.4 Residential building concept

Table 4 is reserved for the categories needed to judge the quality of the housing unit: apartment size, accessibility, building technology and energy concept.

Location		Seestadt Aspern [10]	Hafencity, Hamburg [11]	Nordhavn, Copenhagen [12]	Nordweststadt, Frankfurt [13]	
Housing unit structure						
Average apartment size (m ²)	1-room	37.74	45	30	32	
	2-room	57.68	65	60	58	
	3-room	74.46	110	95	72	
	4+ room	97.73	130	110	84	
Vertical circulation		stairs/elevator	stairs/elevator	stairs/elevator	stairs/elevator	
Barrier free		yes	yes	yes	partly	
Heating system		district geothermal	district geothermal	district geothermal	district powerplant	
Cooling system		none	individual	district cooling	none	
Mechanical ventilation		provided	provided	provided	provided	
Natural ventilation		provided	provided	provided	provided	
Energy production		none	exceptionally	solar	not provided	
Energy consumption (KWh/m ² a)		15 (heat)	40 (overall)	20 (heat)	160-170 (heat)	80-95 (heat)

Table 4: Residential building concept

The size and the quality of an average apartment in each category, are better in SA, HC and NH. Thanks to the bigger storey height, new buildings usually offer more possibilities for advanced building technology such as floor heating, improved mechanical ventilation and smart energy concepts. They are also often equipped with solar panels for hot water or energy production, and consume little amounts of energy. Space division with non-load bearing partition walls ensure spatial flexibility. In terms of spatial organization of the apartments, buildings in NW could still match qualities of the modern apartments. Barrier-free access could be achieved with reconfiguration of the communication core and integration of ramps, while application of new energy concepts and smart/double skin facades on housing units, as a part of the thermal refurbishment concept, could significantly reduce the energy consumption and improve their visual qualities, which would give these housing character and identity.

5. CONCLUSION AND PROSPECTIVES

Despite some unarguable disadvantages against new development projects, with the implementation of the aforementioned strategies, Nordweststadt housing estate could find a way to adapt itself to the 21st century city standards. Future research work will focus on creating design proposals both in the urban quartier and residential unit scale in order to visualise theoretical premises and strategies stated in this paper.

ACKNOWLEDGEMENT

The author would like to thank to the employees of the selected companies [10,11,12,13] for participating in this research and for their assistance in providing the data for the analysis.

REFERENCES

- [1] European Commission, Topics [online]. Retrieved from: <http://ec.europa.eu/energy/en/topics/energy-efficiency/buildings>, [Retrieved on 20. September 2016]
- [2] Mubadala Group, Masdar city. [online]. Retrieved from: <http://masdar.ae/> [Retrieved on 03. January 2017]
- [3] HHS Planer + Architekten AG, Projects. [online]. Retrieved from: <http://www.hhs.ag/projekte-wohnen-aktiv-stadthaus-frankfurt.de.html> [Retrieved on 03. January 2017]
- [4] Nussmüller Architekten ZT GmbH, Projects. [online]. Retrieved from: <http://www.nussmueller.at/projekte/sanierung-wohnbau-kapfenberg/> [Retrieved on 03. January 2017]
- [5] Guallart, V., 2012. The Self-Sufficient City. Actar Publishers, New York
- [6] Maas, V., Sverdlov, A. and Waugh, E., 2009. Visionary Cities, The Nai Publishers, Rotterdam

- [7] Wikipedia, Retrieved from: https://en.wikipedia.org/wiki/Mercer_Quality_of_Living_Survey, [Retrieved on 20. September 2016]
- [8] Dezeen Magazine, News. [online]. Retrieved from: <http://www.dezeen.com/2016/08/04/replacement-revealed-brutalist-robin-hood-gardens-smithsons-haworth-tompkins-metropolitan-workshop/> [Retrieved on 25. August 2016]
- [9] Wassenberg, F., 2011. Demolition in the Bijlmermeer: lessons from transforming a large housing estate, Building Research & Information, Edition 39 (4), 363-379
- [10] Data provided by: Wien3420 GmbH Aspern Development AG, www.wien3420.at and ÖVW Bauträger GmbH, www.oevw.at
- [11] Data provided by: Hafencity Hamburg GmbH, www.hafencity.com and Unibail-Rodamco Germany GmbH, www.unibail-rodamco.de
- [12] Data provided by: By & Havn, Copenhagen, www.nordhavnen.dk
- [13] Data provided by: Stadtplanungsamt Frankfurt am Main, www.stadtplanungsamt-frankfurt.de and ABG Frankfurt Holding Wohnungsbau- und Beteiligungsgesellschaft mbH, www.abg-fh.de

Build Less and Make Cities Smarter by Unleashing Potential of Vacant Spaces

CHAN Lai-kiu^a

^a arOstudio Ltd, Hong Kong SAR, qlkchan@gmail.com

ABSTRACT

aTTempspace, which won 2015 Techathon by Hong Kong Science Park, attempts to optimize the use of commercial vacant spaces to reduce demands for new buildings and urban footprint of a city. With the support of a major developer and other landlords in Hong Kong, the paper contributor put the ideas into actions, and turn temporarily vacant spaces, such as vacated buildings waiting for redevelopment, shops to be let and atria in shopping malls, into pop up event spaces, bazaars, shops or temporary storage. It provides affordable offline spaces for non-profit organizations, entrepreneurs, SMEs and startups to try out new ideas and to drive social innovation. This is vital for a city to fuel its growth with new jobs for young people and new business in the development cycle. It also removes deserted spots and unsightly defaced street frontages from the city. Activities and services at these temporary locations bring convenience and choices to the neighbourhood, break the monotony from chain stores, and enriches city life, and ultimately, make high density cities more livable.

To unleash the potential of temporary vacant spaces, innovative solutions are required to tackle the following major challenges:

- A creative business model that brings benefits to all stakeholders, including space providers and users, operators, community and environment.
- Cost-effective, quick-to-install temporary or reusable furniture and basic services (in hot summer months, also cooling) to make spaces usable and reasonably comfortable. In long run, green lease that facilitates these, should be promoted as part of the standard practices.
- Contents readily curated
- Effective promotion via social media and public engagement.
- Meeting various statutory requirements that should be updated to face disruptions caused by technology and new economy.
- Simplified liability protection that avoid the vacancy period spent on tedious legal agreements.

Keywords: green economics, smart neighbourhood, green lease

1. BUILDING LESS, NOT JUST BUILDING BETTER

Building less, not just building better to consume less, is a highly effective and even more direct approach to reduce human footprint on earth. Not only that less lands, whether greenfield or brownfield, will be used up by buildings, less materials and energy will be consumed by building constructions, and less waste and pollutants will be released in the processes. To achieve this, buildings have to be used in highly efficient ways, not only through improved planning that increases spatial density three dimensionally, but also involving the time dimension to reduce vacancy. Reduced vacancy and improved usage of buildings will also bring more activities and life to a neighbourhood making it more livable and smarter.

1.1 Time sharing and reduced vacancy enabled by technology

Progress in technology makes information flow highly efficient and cost-effective. People also gradually establish trust to online credit systems that rate service providers who may be total strangers to them. These lead to the success of new sharing platforms and applications like Airbnb, Uber and Lyft, that facilitate quick matching of supply and demand, and allow people to make better use of vacant units, cars or passenger spaces. They bring new convenience to people and reduce the need for building more hotels and cars or using fuel. The sharing concept revolutionizes the way spaces are used and bring disruption to many traditional business and industries.

The wide application of technology in daily life, which brings direct benefits to people, is core to a smart neighbourhood and city. According to Cohen, the movement was initially driven by technology, and then by government, and now, the world are proceeding to Smart City 3.0 which are co-created by people. Entrepreneurs start up new business all over the world to explore the opportunities from this sharing concept in every sector of life.

aTtempSpace, a technology startup founded by an experienced architect with strong background in sustainable design and solid experience in real estate, attempts to unleash the potential of vacant commercial spaces in the city. This is particularly relevant in a city like Hong Kong, which is notorious for its high rent, but at the same time renowned for its high density model and clever use of spaces.

1.2 Wastage of spaces caused by vacancy in cities

Airbnb makes temporary vacant homes available for visitors stay. But there are still a lot of wastage of spatial resources in cities. Having been the senior executive of a real estate developer and award-winning designer, the paper contributor hopes to find better ways in using vacant spaces and frontages in commercial premises. These includes:

- Vacant units to be leased
- Shopping mall atria or event spaces emptied between activities
- Office lobbies, meeting rooms and other public areas after work and during weekend
- Vacated spaces in buildings waiting for complete acquisition of titles or submission and approval process before redevelopment

Some of these spaces could be at prime locations and of great value to young people, new startups and small business who cannot afford the high rent at these locations.

Without proper attention and management, street frontages of vacant spaces often become the victims of unauthorized advertisement making them very unsightly and messy. Good temporary uses of these frontages will help to improve streetscape and living environment of a neighbourhood (Figure 1).



Figure 1: Better use of street frontage of vacant space will help to improve streetscape and living environment of neighbourhood.

2. BUSINESS CASES AND CHALLENGES FOR TEMPORARY USE OF VACANT SPACE

To lay people outside the real estate industry, it seems easy and obvious to use these vacant spaces. However, there are a lot of challenges in putting the ideas into practices:

- Short term rent means little to landlord

Properties are expensive commodities in cities. Real estate developers are often public listed companies of high value. Even smaller private developers or landlords are mostly millionaires. To them, the return from temporary leasing of their properties are very minimal as compared to the trouble and procedures involved.

- Short time for finding the right user and content.

Commercial business depends very much on locations and its target customers. It requires a good match of location and brands. To find the right user and content for a space in a very short time could be very difficult.

- Liability and protection

Use of space involves certain liability to the space providers as well as the space users. To protect each other, a license, often with lengthy terms and conditions need to be agreed and signed in advance and insurance need to be secured. These processes could easily use up the period of vacancy.

- Short time for making space usable and running

For the space users, to use a space also means fitting out the space to a minimal standard, bringing in goods and merchandises and securing work forces in a very short period of time.

- Promotion and publicity

Being new in a location, it is not easy to draw sufficient attention and traffic to these temporary pop up activities or outlets.

Core to the problems is to find a good business model that brings benefits to all stakeholders and gives sufficient initiatives for them to overcome the problems described above.

- To the building owners

They will be more interested in happenings that can speed up the sale or leasing of a place and ultimately add value to their properties, rather than collecting the minimal rent from temporary uses. For commercial sectors, value of a property often relate to the amount of foot traffic and publicity of a location to people.

- To the space users

They will be most interested in promoting their brands, expanding their customer bases, not only the limited transactions or business done during the temporary period.

In both cases, the success lies in the ability to bring people to a location and to make a location known to public, which practically is a branding exercise.

3. EXPERIMENTAL PROJECT: CREATIVE USE OF VACANT SPACE AS AREA BRANDING TOOL

With the support of a visionary developer, a 6000 sq. ft. high ceiling ground floor vacant space in a factory building were made available and usable for different organizations to pop up different events in three months before its demolition. (Figure 2)



Figure 2: Space vacated waiting for demolition

The project, not only makes the location better known to the public, it re-brands the area as a fun and cool destination. Events conducted includes:

- Old kisses New: TKT (Figure 3)

The first pilot event on a theme that celebrates the mix of old and new culture in Tai Kok Tsui area through the juxtaposition of old craft market with new maker fair, old sugar craft with new 3D sugar printing, new photos of the old districts, history talk about the area and a wide array of performances and games.



Figure 3: First pilot event was arranged in a short period of two months

- A family art and design fun day (Figure 4)



Figure 4 The second event held in the vacant space

- A recycle book fair and lantern art exhibition (Figure 5)



Fig 5 A recycle book fair and a lantern art exhibition

- A drone race and fun day (Figure 6)

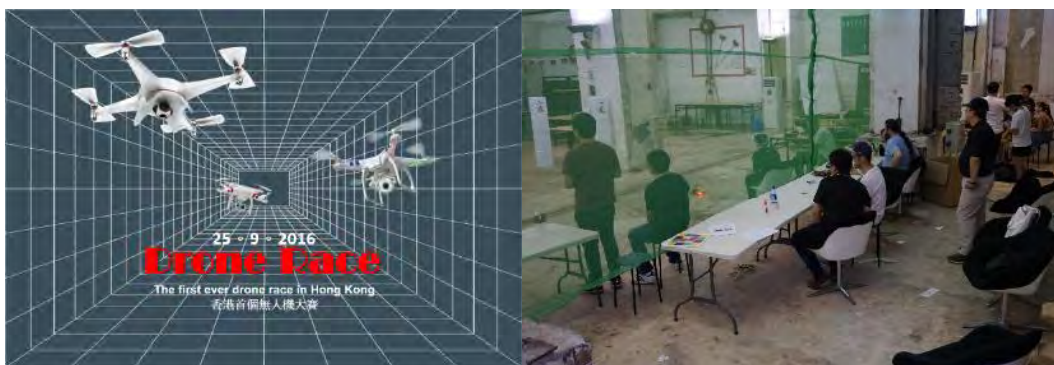

Figure 6: It is a very unusual opportunity to play drone indoor

4. SOLUTIONS TO PROBLEMS TESTED OUT THROUGH THE PROJECT

The following solutions have been tested out in overcoming various problems encountered in temporary use of spaces:

- Provision of basic services

As the building was mostly vacated, temporary power was spared from existing building while sockets units and floodlight were borrowed from construction site to provide power points and general lighting.

- Mobile and reusable systems integrated with lighting provide multi-purpose panels for exhibition and screen for projection. A set of giant mahjong was also done to serve as seating, stands, games and art installation (Figure 7)



Figure 7: Mobile and reusable units provide basic furniture to the space

To further enrich the space, environment artworks using waste materials were installed. (Figure 8)

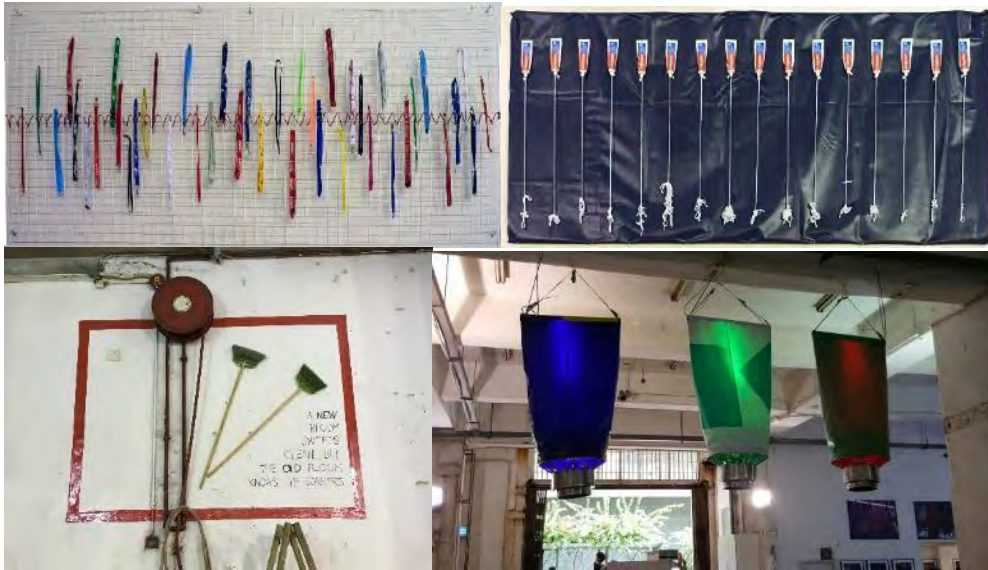

Figure 8: Environmental artworks

- Temporary air conditioning

As the period of vacancy falls into the summer months, basic air conditioning was provided by 4 nos. temporary standing split units and large number of evaporative cooling units. However, the result is far from satisfactory and better solutions need to be sought.

- Meeting regulatory control

Careful checking of town planning, building and lands control were done. However due to the short preparation period, it is totally impossible to properly secure the Place of Public Entertainment License. As compromise, all the **events are limited to “people invited” instead of to public.**

- Liability and protection

As the developer has the vision to facilitate the temporary use, license conditions are kept to the minimum and allow the agreement to be signed by a limited company without personal guarantee. Furthermore, proper third party indemnity insurance was requested in the license agreement to indemnify the owner from liability.

- Promotion and publicity

Knowing promotion is key to the success of such event, a PR agency was brought in at early stage. In an era when content is king, creative ideas go viral in social media. A video of playing the mah-jong done for this project attract over 2 million views and 60 K share on Facebook (Figure 9).

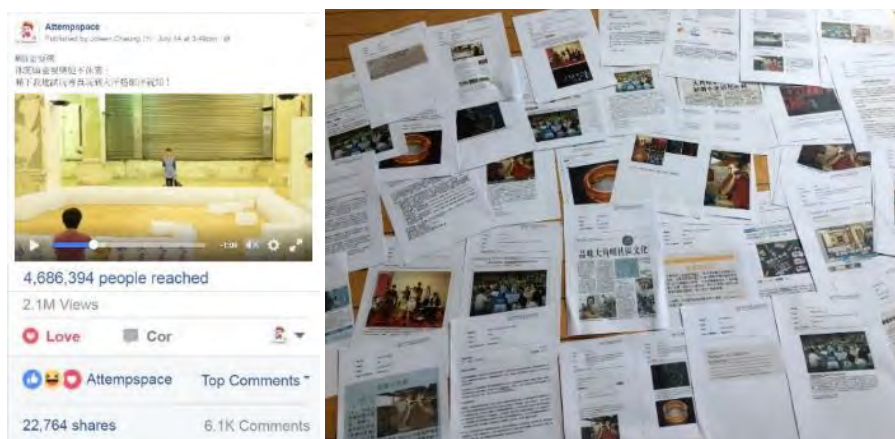

Figure 9: The project enjoys great success in publicity

5. CONCLUSIONS AND LEARNINGS FROM THE PROJECT

The projects prove that the idea is viable and valuable learnings are gained:

- Experience from temporary uses draws traffic and encourage interaction

Temporary pop up events and uses bring new experience and interaction.

In a world people get overwhelmed by information and over-rely on online platform for interaction, the pop up events bring new experience to people, allow them to meet face to face, and foster community interaction.

- Temporary uses are sources of novelty and creativity

Through temporary uses and installation, people can test out new ideas and carry out experiments. And often, these contents are very interesting and novel to visitor. In the creative process, chances of realizing an idea and be allowed to make mistake are highly valuable. All these help to cultivate a creative and innovative culture in a city.

- There are solutions to problems involved in temporary use of space

With a will to try out the idea, the developer and aTTempspace work as a team to overcome various problems encountered and act very fast in making things happen so that the short vacancy period will not be wasted.

- There is a business case for creative use of vacant space

The project proves that creative use of vacant space is a good vehicle for branding both for the space provider and the temporary users. It brings foot traffic to the area, business to its adjoining shops and restaurants, and activities to its neighbourhood, and ultimately enrich city life.

- Temporary use of space can be further enhanced by:

Green lease that does not request the tenants to reinstate a premises to bare shell and disconnect all utilities after expiry of lease.

Corresponding provisions in regulations and statutory controls that shorten applications and approval process.

- Better use of technology

Due to the short preparation time for the pilot project, technology has not been fully employed. In near future we hope to do more projects and experiment other applications of technology which includes:

Crowd-sourcing of content that encourage participation and contribution by public and bring awareness before the happening of events.

IOT shopfront that integrates sensors to collect traffic data and customer profile at a location. Its frontage can also be used as billboards for advertisement, as showcases for products and as screen for online shops.

Green Transformation of Electrical and Mechanical Services Department Headquarters Building

MAK Ka-chun^a, LEUNG Wing-hong^b, Dominic LAU Siu-kei^c

^a Electrical and Mechanical Services Department, Government of the HKSAR, Hong Kong SAR, kcmak@emsd.gov.hk

^b Electrical and Mechanical Services Department, Government of the HKSAR, Hong Kong SAR, whleung@emsd.gov.hk

^c Electrical and Mechanical Services Department, Government of the HKSAR, Hong Kong SAR, dlau@emsd.gov.hk

ABSTRACT

Buildings use about 40% of global energy and they emit approximately one third of global greenhouse gas. In Hong Kong, buildings account for more than 60% of the total annual energy consumption and about 90% of the total electricity consumption. In this connection, building sustainability is a crucial element for meeting the needs of contemporary end users without damaging the prospects of future generations nor increasing environmental burdens to the neighbours.

The Electrical and Mechanical Services Department Headquarters Building (EMSD HQs) situated in Kowloon Bay was formerly an air cargo terminal building in the ex-international airport at Kai Tak. The EMSD HQs successfully exhibited an excellent showcase of sustainable development through renovating the old cargo terminal into an office building and workshop, thus minimizing the generation of construction and demolition wastes.

As a pioneer in advocating environmental responsiveness, the Electrical and Mechanical Services Department (EMSD) always takes a proactive approach in promoting energy efficiency and sustainability. Since moving in the new headquarters in 2005, we have been implementing continuous enhancements to our indoor and outdoor facilities and environment in various aspects to making EMSD HQs greener, not just to meet the changes in operational need but also to enhance sustainability for the sake of our staff, our neighbours and the public at large. These enhancements include many advanced technologies leading to energy and water conservation as well as waste reduction, and are verified using the BEAM Plus environmental assessment tools.

This paper will briefly introduce various sustainable features applied in the green transformation of EMSD HQs, the good practices adopted in operation and management, and the experience gained in the building integration with the community.

Keywords: sustainable neighbourhood, green building management, transformation

1. INTRODUCTION

Being an international metropolitan, Hong Kong is characterized by many high rise buildings to render the spaces needed for our work, living, recreation and commercial activities. Buildings in Hong Kong impact a significant portion of our carbon footprint and account for more than 60% of the total annual energy consumption and about **90% of the total annual electricity consumption**. **To combat climate change, the reduction of our buildings' carbon footprint** is top of our agenda with aspiration towards a vision of developing to a low carbon city.

In around year 2000, the EMSD of the Hong Kong Special Administrative Region (HKSAR) in collaboration with the Architectural Services Department saw the opportunity to give the former Hong Kong Air Cargo Terminal 2 Building (HKACT2) built in early nineties a new life by converting it into the EMSD HQs.

Similar to many existing buildings which are 30+ years old in Hong Kong, energy efficiency of the HKACT2 was not a foremost consideration at that time when it was built. There were tremendous rooms and potentials to improve energy efficiency performance of the building by application of state of the art energy efficient building designs and technologies.

In 2004, the HKACT2 undertook a complete conversion with a sustainable design and construction approach which was fundamentally different from the traditional approach by demolishing the old structure for construction of new building. This approach could save capital construction cost, and the most important of all, avoid generating

unnecessary demolition and construction waste while conserving the embodied energy within the existing building elements.

2. SUSTAINABLE FEATURES

The EMSD HQs, with a total gross floor area of approximate 81,800 square meters, was designed to make full use of the existing concrete structure as far as possible resulting in a saving of HK\$600 million in construction cost. By retaining most of the existing concrete and steel structure of the old building, the volume of construction waste reduced was estimated to amount to a four-storey building of the size of a football pitch.

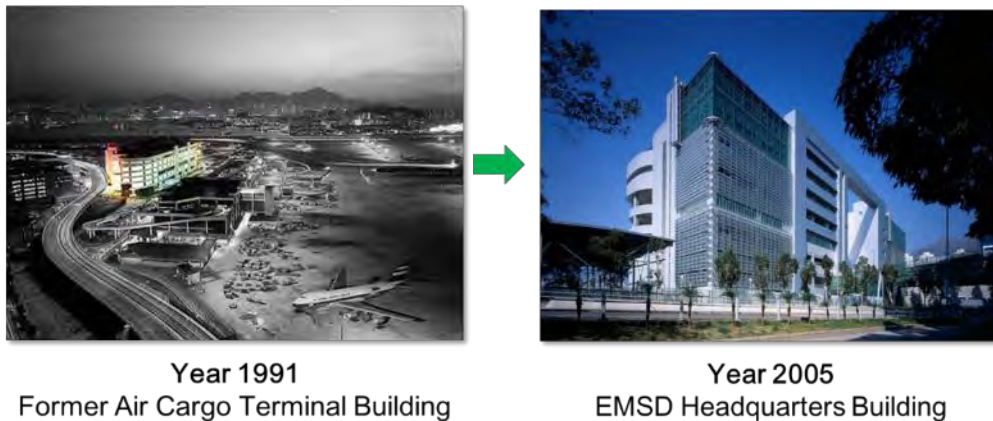

Figure 1: Photos of Former Air Cargo Terminal Building and EMSD Headquarters Building

The refurbishment works were completed in November 2004 and the building was equipped with a number of sustainable features for enhancing energy efficiency and promoted use of renewable energy. Examples of these features are highlighted as follows:

2.1. Building envelope

The building facade is fitted with sun shading architectural fins at the southeast elevation to minimize direct sunlight penetration into the building in the summer and with double-glazing to minimize heat transmission from outside. In addition to the sunshades and double-glazing, green roofs on the second and seventh floors provide thermal insulation to the building as well as pleasant outdoor spaces where staff can interact and relax. A low overall thermal transfer performance of the building envelope is achieved.

2.2. Thermal comfort

As electricity expensed by air-conditioning system shares about half of the total building electricity consumption of a general office building, high efficiency water-cooled chillers using ammonia as refrigerant have been adopted in the EMSD HQs. The coefficient of performance (COP) of the chillers at full load is 5.7 which was about 10% above the requirements in the Code of Practices for Energy Efficiency of Air Conditioning Installations published in 2005. Besides, ammonia is a zero ozone depletion refrigerant and helps minimize global warming effect.

During “off-peak” period of electricity demand, “slurry ice” which is a good thermal storage medium was produced and stored in five ice storage tanks. During peak period of electricity demand, the slurry ice is used to absorb cooling load and hence reducing the maximum loading demand of electrical installation.

The advantage of having high headroom from the old air cargo building enables the use of displacement ventilation via raised floors to supply the conditioned air to offices, instead of using the conventional supply and return air at ceiling level. In workshop areas, natural cross ventilation is achieved by constructing new openings on blank concrete walls with booster fans installed to improve air circulation during sultry days.

2.3. Natural lighting and interior lighting

The use of natural lighting in office areas and main lobby reduces reliance on artificial lightings. Apart from conventional manual lighting switches, smart controls such as occupancy sensors or photo sensors have been applied to the lighting systems at peripheral areas to minimize energy consumption.

For office areas, task lighting coupled with occupancy sensors enables a lower background illumination level and hence a lower lighting energy consumption. In addition, sun pipes installed to harvest direct daylight from roof to 7/F corridor can further reduce the energy consumption of interior lighting.

2.4. Renewable energy

The rooftop solar photovoltaic system installed on roof of the EMSD HQs consists of over 2,300 photovoltaic panels with a maximum installed capacity of 350kW, which was the largest photovoltaic panel system at that time. These panels are grid connected with the electricity power distribution network and can generate electricity from direct sunlight to meet about 3% of the total building electricity demand.

2.5. Water recycling

Grey water such as wastewater from showers, washbasins and kitchen areas of the EMSD HQs is collected, treated using membrane bio-reactor technology and stored in underground tanks for toilet flushing. The approximate saving of water is about 14,000 litres per day.

3. GREEN TRANSFORMATION

Since moving into the new EMSD HQs in 2005, we have been continuing our effort in implementing further enhancement to our facilities and environment, both indoor and outdoor, on a non-stop basis, not only to meet the change in operational needs, but also to enhance the sustainability and greenery of our building as well as the staff productivity and the well-being of our staff, visitors, neighbours and the community at large.

3.1. Thermal comfort enhancements

With advancement of technology, EMSD took the opportunity to pilot install a new water-cooled variable speed oil-free centrifugal compressor chiller in the EMSD HQs in 2008, which was the pioneer use in government at that time. The chiller operates with magnetic bearing technology that reduces energy loss, and is quieter and more energy efficient to run than traditional chillers. The variable speed oil-free chiller that achieves a good part load COP can partner with the original ammonia chillers to achieve the optimum chiller plant efficiency at all partial load conditions. In addition, an electromagnetic induction descale system was installed in 2012 to apply an electric field to prevent formation of scale in the condensing water circuit and hence maintaining the heat transfer efficiency at all times.

In sub-tropical climates like Hong Kong, solar heat gain through building envelope imposes significant cooling load to the air-conditioning systems. In order to reduce the solar heat penetrating through windows, window solar films are installed on the façade glazing of office areas at 6/F, 7/F and rooftop viewing gallery to further lower the heat transfer.

3.2. Lighting power consumption enhancements

As technology advances, LED lighting, photo-sensor lighting control and occupancy sensor lighting control have been widely adopted in refurbishments of the EMSD HQs whenever applicable. The lighting power density of renovated meeting rooms and toilets completed during the period between 2013 and 2015 is around 11W/m² and 7W/m² respectively, which outperforms the minimum requirements of the latest Code of Practice for Energy Efficiency of Building Services Installation 2015 Edition [3] by about 21% & 36% respectively. The existing fluorescent tubes are being replaced by LED lamps progressively to further lower the lighting power consumption of the EMSD HQs.

3.3. Renewables

To cope with the hot water demand of canteen and shower facilities of workshops and better use of solar energy, a solar water heating system with a total solar collector area of 60m² was installed in 2007. The system brings us an annual saving of about 25,000kWh. A sun-tracker concentrated photovoltaic panel, a light shelf and solar powered street lights have also been installed to further promote utilization of solar energy. The enhancement will not come to a halt and there will be installation of solar-wind powered lighting at the piazza for completion in 2017.

3.4. Waste management

At present, most of Hong Kong's food waste is disposed of at landfills. Because of the limited landfill spaces in Hong Kong, such practice is not sustainable. In addition, it creates odor nuisance and generate landfill gases that require further mitigation measures. To reduce the pressure on landfill site, a food decomposer was installed to reduce the food waste from the canteen of the EMSD HQs. An average monthly waste of 500kg is collected for conversion as fertilizer used in landscape area.

In reducing water consumption, a pilot project proposed by staff for using condensate water collected from air handling units of air-conditioning system for toilet flushing was implemented starting from 2012. A rain water harvesting system was also installed in 2014 to collect rain water for irrigation.

Furthermore, we have pledged to reduce waste and recycle the recyclables generated by joining the "Waste Check Charter" launched by the Environmental Protection Department. Besides the hardware, we have implemented good environmental management system to sort and recycle the waste metal and waste oil from vehicle workshop.

3.5. Greenery

To improve the spatial quality of the building, external vertical greening of 200m² was erected as feature walls in the piazza in 2011, while an indoor vertical green wall of 30m² was installed at the ground floor main lobby in 2014. We are now planning further enhancement of the outdoor piazza for completion by 2019. Apart from enlarging the outdoor space for the community to enjoy, more external greening including lawn and vertical greening to enhance the environmental quality are in progress. This not only highlights the function of the space, but also enlivens these areas in midst of an industrial district with a contrast of pattern, colour and textures.

3.6. Building asset management by RFID and BIM

Since 2014, EMSD has pioneered the application of innovative Building Information Modelling (BIM) together with Radio-frequency Identification (RFID) technology which converts and organizes building design information into a 3-dimension digital model to improve the asset management (AM) of the EMSD HQs. With advanced mobile device technology, the estate management staff, and operation and maintenance staff can work more closely and effectively. The operation efficiency would be significantly improved by shortening the response time for fault diagnosis, clearance and service recovery.

3.7. Building energy consumption monitoring

The best measure to ensure the optimum system efficiency and reliability is to nip potential problems and faults in the bud. Apart from incorporating communication gateway between the Central Control and Monitoring System and Building Energy Management System for real time data communication, the EMSD HQs has been progressively adding different smart meters, such as chilled water flow meters in chilled water circuit and branch circuit power meters in electrical sub-circuits, to enhance the existing building energy management system in monitoring the energy performance of building services installations in more details. In addition, the enhancement of building energy management software, including a more powerful energy usage analyzing capability and the capability of issuing energy usage alert, is being implemented.

After the completion of the above enhancement in 2017, the real time energy performance of the EMSD HQs can be monitored closely and abnormal operating conditions can be identified at an earlier stage for necessary rectifications. With the enhanced building energy management system, the logged operation parameters and energy consumption records of different locations of the building can be analyzed in details and more energy

efficient modes of operating set points as well as energy management opportunities can be identified by the operation and maintenance staff through the information network. The new building energy management system can also provide user-friendly dashboards for the building users to visualize their energy consumption, which facilitate the cultivation of energy saving behaviors of building users.

3.8. Green transport

In order to encourage green transport, bicycle parking spaces were set out within the site in 2013 for our staff to return to office by cycling. With the popularity of electric vehicles continues to grow, we also set up charging facilities for visiting electric vehicles in 2015.

4. INTEGRATION WITH COMMUNITY

A green building being a part of the community is simply not sustainable on its own. **Connecting with community enables sustainability to be leveraged beyond the building's boundaries to reach out for the general public.**

By the time the EMSD HQs was designed, a traffic impact assessment concluded that a footbridge across Kai Cheung Road would be required to cater for the increase in pedestrian traffic and enhance the interconnectivity of the EMSD HQs with neighbours. Hence, to enhance connectivity and walkability, a footbridge was then built with the full support from developer of the adjacent commercial complex and forming an important gateway for us to physically reach out to the neighbourhood community.

Coming in through the main entrance, an education path including exhibit features in piazza, exhibition gallery on ground floor and viewing gallery on roof, takes members of community on an exploratory journey and experience of energy efficiency, renewable energy and electrical and mechanical safety. Throughout the past decade, EMSD has been adding and updating exhibits of the **education path to keep visitor's experience fresh, and the revamp of the education path is underway** which will give visitors multi-sensory experience through dynamic, multimedia and interactive displays.

What keeps a building alive is its ability to continuously cope with the different needs of its occupants and visitors. EMSD constantly explores various new ways to enhance our amenities to make the EMSD HQs a greener environment for shared use with the community. Apart from enhancement of the hardware such as enhancing greenery, providing bicycle parking spaces, and widening pedestrian access in piazza, etc., EMSD has engaged a social enterprise to run a café at the main entrance hall in 2015. Through such initiative, EMSD can create opportunities for the underprivileged people, and also foster a caring culture in the community.

To make the EMSD HQs even greener, the air-conditioning system will be connected to the district cooling system (DCS), which is the first district-wide air-conditioning engineering system in Hong Kong, in mid 2017. By that time, the EMSD HQs building will become the first existing building to adopt DCS, and will set out an example for other existing buildings to follow. The DCS consumes approximately 20% less electricity as compared with traditional water-cooled air-conditioning system using fresh water cooling towers. Taking the advantage of energy efficient nature of the DCS, it is anticipated that this enhancement could generate a saving of 1.7 million kWh per year, which is equivalent to the annual electricity consumption for about 300 households. Furthermore, the local heat island effect from the existing cooling tower system can be reduced. After connecting to the DCS, there is a further opportunity to make good use of the existing air-conditioning plant room and ice storage area to convert them into new facilities as part of our sustainable development to make our piazza area more appealing, open, and accessible to people in the neighbourhood.

EMSD is fully committed to **contribute to a greener community**. In line with the Hong Kong Green Building Council's focus to enhance environmental performance of existing buildings, the EMSD HQs has become the first **government building achieving the "Platinum" rating under the BEAM Plus Existing Buildings assessment [4] in 2016**. The project of Transformation of EMSD HQs into a Green Building is also rated "Platinum" in the BEAM Plus Neighbourhood pilot assessment scheme in the same year.

5. CONCLUSION

The transformation of EMSD HQs demonstrated that an old building could be rejuvenated to satisfy the needs of all occupants, visitors and neighbours in a sustainable manner. At different stages of a building cycle, various innovative concepts and elements to optimize the energy performance and sustainability of the building have been considered. The energy performance does not only comply with the minimum requirements including the Building Energy Code, but also aim at outperforming the bare minimum requirements to promote energy efficiency and sustainability. By continuous enhancement and integration with our community, the EMSD HQs is further transforming into a government model to the society in driving towards a low carbon city.

REFERENCES

- [1] Electrical and Mechanical Services Department, Hong Kong SAR Government - Hong Kong Energy End-use Data 2015.
- [2] Electrical and Mechanical Services Department, Hong Kong SAR Government - Code of Practice for Energy Efficiency of Air Conditioning Installations 2005
- [3] Electrical and Mechanical Services Department, Hong Kong SAR Government - Code of Practice for Energy Efficiency of Building Services Installation 2015
- [4] Hong Kong Green Building Council - BEAM Plus Existing Buildings manual V1.2

Shaping Energetic Neighbourhoods: A Dynamic Approach for a Future Proof Urban Energy Planning

Jürgen KNIES^a

^a Jade University of Applied Sciences, Germany, juergen.knies@jade-hs.de

ABSTRACT

The announced heat transition, with a huge impact on the reduction of the greenhouse gases, addresses especially cities. The simple question “Which technological solution of sustainable energy supply should be implemented at which place?” often leads to a confusion of local stakeholders caused by the wide range of possibilities. Besides technological and social challenges, facing the related question of the best location or area will be a key factor of a successful local implementation. The approach enables stakeholders to analyse cities spatially from the perspective of heat demand across planning borders like districts and real estates. The result shows areas of suitability for heat supply systems like LowEx - heating grids, typical district heating systems, or local heat generation, e.g. on block or building level. The shapes of this energy driven neighbourhoods are fuzzy. Due to the scenarios the dynamic spatial change of the suitability patterns can be used as a forecast system for urban planning activities.

Keywords: sustainable neighbourhood, spatial fuzziness, energy supply systems

1. MOTIVATION

The ongoing Energy Transition in Germany has come to a point where it becomes clear that the former focus on power generation is not sufficient to reach the climate protection goals. The enormous potential of greenhouse gas (GHG) reduction in the building sector is now on the political agenda [1] [2]. In 2050 the buildings in Germany shall be carbon-neutral [3]. Two different and also complementary approaches are suitable for this goal [4]:

- Fostering the refurbishment of existing buildings and developing energy standards for new buildings.
- Integration of renewable energy into the heat supply system and replacing fossil fuels.

The future energy system couples the different sectors e.g. heat, power, and logistics on a very local level and enables an exchange of energy between different actors within a neighbourhood [5]. Shaping the energy driven neighbourhood is a dynamic process and connects actors on various energy levels in space and time [6].

The presented approach is not suitable for detailed energy planning. Rather, it fills the gap between urban planning and the detailed planning by a fuzzy shaping of energy driven neighbourhoods [6]. It shall give a first overview for a spatial monitoring of potential heat supply systems based on heat demand data.

2. DATA AND APPROACHES

The approach presented in this contribution is tested in the city of Oldenburg (164.000 citizens) and in the smaller cities of Bramsche and Wallenhorst (36.000/ 23.000 citizens) in Lower Saxony (Germany), so it meets typical sizes of cities in Germany.

2.1 Data and subjects

Heat demand data are derived from models about the age and construction of buildings, the number of inhabitants, the usage within the building etc. So heat demand does not represent the heat consumption. Heat consumption depends on personal behaviour and certain structures, so the heat demand gives a more objective picture.

For the city of Oldenburg the commercial data of DBI GUT GmbH is used (ca. 53.000 points of heat demand data). Input data from 2011 to 2015 are used to model the heat demand. In some cases, the heat demand is revised because the local situation is different from the demand data, e.g. public facilities like schools, university etc. In this case concrete data of the municipality is used or the heat demand is recalculated [7] [8]. A high degree of uncertainty is given in the industrial sector, caused by unknown parameters like the amount of produced goods,

see also [9]. For the cities of Bramsche and Wallenhorst the data of the PlnA project (“Planungsportal für industrielle Abwärme”, planning portal for industrial waste heat) is used (in total ca. 23.000 points) [10]. The county of Osnabrück is involved in the plausibility check.

In both cases the information about the single input data is lost caused by constraints like data protection and business secrecy. So the modelled data is the starting point of the analysis.

2.2 Scenarios of the future energy demand

Due to the data situation and constraints, the scenarios are not driven from the building stock in detail. Is it necessary to think from the GHG – reduction point of view, because the goals and requirements are set.

The meta-analysis on future heat demand in Germany [11] gives a good overview about different assumptions about the future energy demand:

- A reduction by 60% in residential buildings.
- A reduction by 20 to 30 % in the industry sector.

The reduction only by increasing of the efficiency is a critical point. The so called “Efficiency Base” is a constraint according to issues like preservation orders, physical conditions, distance regulations etc. [12]. Only integrating renewable energy sources into heat supply systems without building refurbishment is also not possible, because in reality there are often no adequate, realistic potentials. Both approaches together can meet the goal. Thamling et al. [12] define two scenarios:

- Renewable Heating (RH): Use of the realistic potential of renewable energy resources; coupling heat and power sector, moderate building refurbishment; reduction of heat demand by around 40 %.
- Efficiency (E): Ambitious refurbishment and building activities; reduction of heat demand by around 60 %.

According to the size and heat demand of the buildings, the degree of reduction differs around +/- 5% [13], so smaller buildings have a smaller reduction potential than larger buildings. The heat demand data points are divided into three portions with a third of the total sum of heat demand. So each building is assigned to one of this groups by its present heat demand. For this study the scenarios for dwelling houses, trade and services are defined in Table 1. Industrial buildings have a potential reduction of 20 % in 2050.

Year	2020		2030		2050	
Scenario	E	RH	E	RH	E	RH
Reduction on (spread (+/- 5%))	91%	94%	73%	82%	45%	65%
	86%	89%	68%	77%	40%	60%
	81%	84%	63%	72%	35%	55%

Table 1: Definition of the scenarios and the reduction of heat demand

This generalisation cannot take into account the individual situation of each building, and yet it allows a first picture of the future development. **“A scenario is a story that describes a possible future.”** ([14]; p.8)

2.3 Heat supply classification

The heat supply in urban areas is grid related (gas grid, district heating, or even for heat pumps based on the power grid). The advantage of district heating systems is the flexibility regarding the energy sources [15]. The energy demand density according to the (pipe) line length is a good indicator for a suitable energy supply. The theoretical (pipe)line length for e.g. a district heating system is calculated by the length of the streets, based on OpenStreetMap data, plus the distance between the streets and the demand points per 100 x 100 m raster. The algorithm avoids parallel structure of potential pipelines by creating branches. A spatial smoothing filter takes the average length within the immediate neighbourhood into account to avoid illogical extrema. In combination with the sum of the demand within the raster it is possible to express the indicator as MWh/(m x a).

Limit / Ranges	Definition
----------------	------------

< 0,5 MWh/(m x a)	Single Supply: Heating by fuel cells, air and geothermal heat pumps etc. No connection to a grid, limit for grants [16]
0,5 – 1,5 MWh/(m x a)	Cold/Warm Heating System: Seasonal operation management of a grid (summer: 30-40°C. heat pumps in the house for domestic water, solar thermal and power; winter: 70-90°C. by (decentralized) CHP; integration of industrial waste heat [17][18]. In Germany there are different definitions of low exergy - heating systems, so in this contribution it is focused on systems with the operational specification.
1,5 – 2,75 MWh/(m x a)	Classic District Heating: 70-90°C. by (decentralized) CHPs and supported by heat pumps (industrial heat pumps, solar thermal energy, etc.) [19]
> 2,75 MWh/(m x a)	Site / Block Supply: CHPs on site, direct connection to the gas grid, district heating in the sense of cellular grids

Table 2: Heat density ranges of heat supply systems

The efficiency of district heating systems and the related thresholds (Table 2) are not a static figure, the recent experiences with the integration of sources like solar thermal energy and industrial waste heat into the district heating systems [20] [21] is still in progress. So the suitability of different kinds of heat supply systems, based on the demand density, is not static, too, there is a smooth transition of thresholds.

The transition can be described by the concept of the fuzzy membership [22]. In this case a linear membership function is used. The function differs according to the range of the suitability. The current stage of the thresholds and functions are illustrated in Figure 1 and were derived from publications (Table 2). The definition of these is still in progress caused by the ongoing technological development.

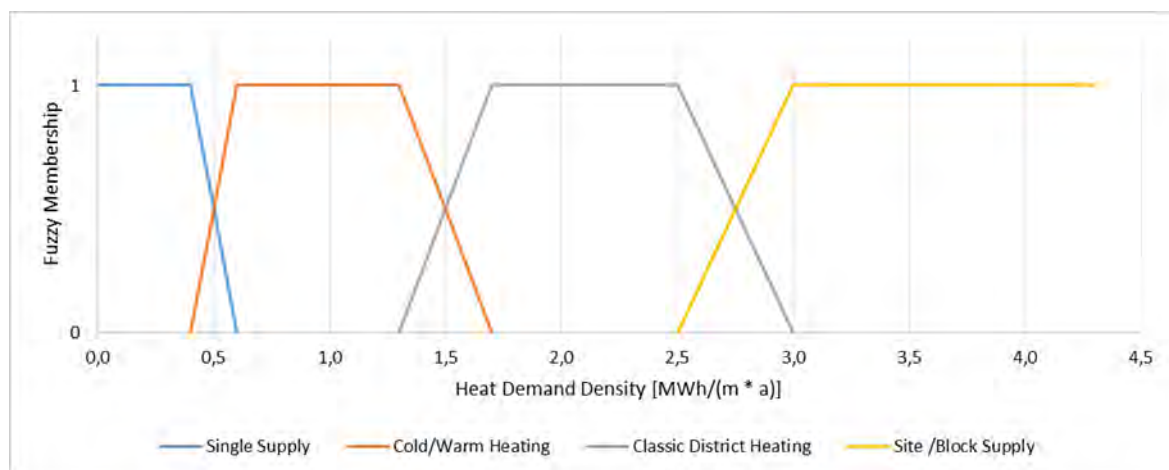

Figure 1: Fuzzy membership of heat supply systems

2.4 Spatial analysis

Based on the rasterized heat demand density and on the concept of the fuzzy membership, the spatial analysis determines the core areas of the different memberships by a supervised Hot Spot Analysis. Combining the Hot Spot Analysis with the scenarios the spots begin to move over space and time. Additionally, the spatial aggregation and combination of the fuzzy memberships enables a city-wide mapping of the leading heat supply system.

3. RESULTS

The analysis of the heat demand density differs in Oldenburg and in Bramsche/ Wallenhorst. The city of Oldenburg is more compact, while Bramsche/ Wallenhorst is more distributed with some sub-centres. An overview of the heat demand density is given in Figure 2.

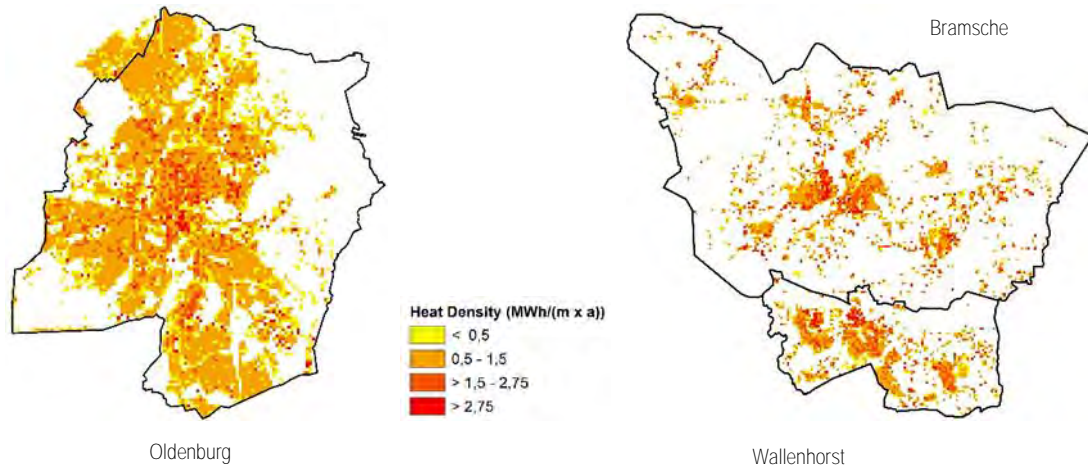

Figure 2: Heat demand density in Oldenburg and Bramsche/ Wallenhorst (Status Quo, unscaled)

The Hot Spot Analysis of the fuzzy suitability with regard to the different heat supply systems allows an overview of the suitability areas in space and time. These areas represent the core areas for the following energy planning in detail. In Figure 3 the Hot Spot Analysis shows the core areas of Cold/Warm Heating System for Oldenburg for both scenarios.

The core areas do not represent the whole settlement area of a city. By combining the fuzzy memberships it is possible to find out the leading heat supply system with a degree of the suitability (Figure 4). Of special interests are the indifferent zones (yellow cells). They are suitable for two different systems equally. So this areas could be very important for the coupling of systems (fuzzy transition). They also represent a smooth transition between the borders between the areas. The proportions of the indifferent areas between the Single Supply areas and the Cold/Warm Heating System areas differs in Oldenburg (14%) and Bramsche/ Wallenhorst (24%). This could be a hint of the patchiness and the more heterogeneous building structure in Bramsche/ Wallenhorst than in Oldenburg.

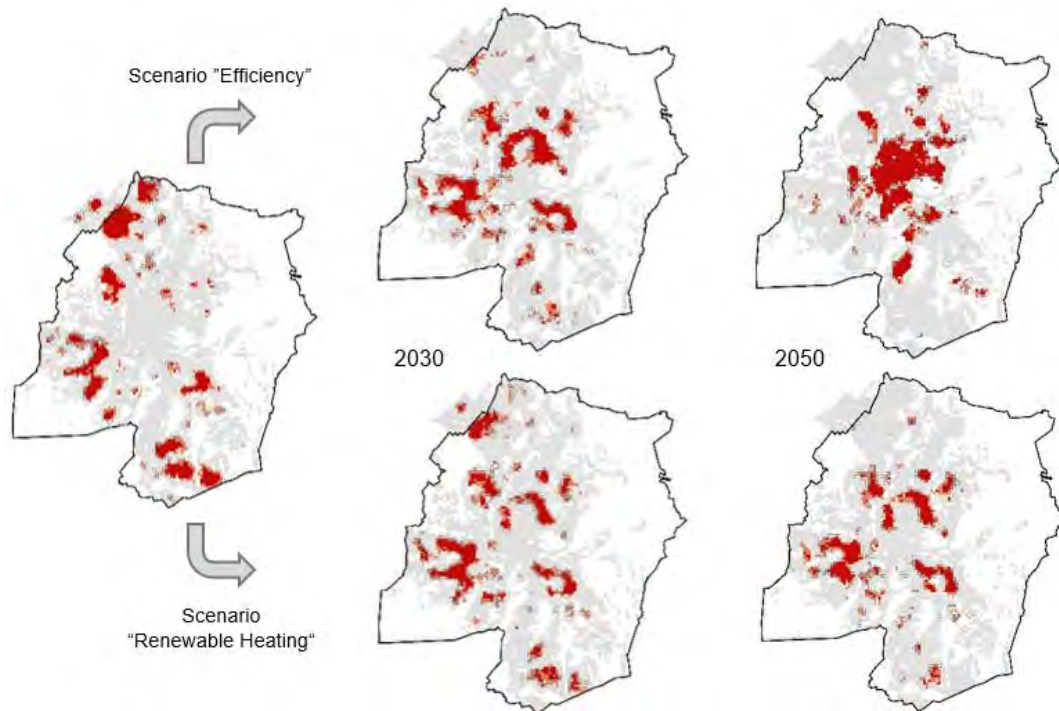

Figure 3: Hot spot analysis of the suitability of cold/ warm heating systems in space and time in Oldenburg (unscaled)

The scenario E leads to a huge area of Cold/Warm Heating Systems in the inner city, so the integration of renewable energy will be a challenge in 2050 there. The scenario RH shows more stable areas, so the areas are more secure for future investments. But then it is necessary to consider, how to bring the renewable (heat) energy amount into the inner city, e.g. industrial waste energy, deep geothermal plants, Power-to-Gas and/ or huge solar heating systems. Figure 4 shows the mapped combination of all suitability areas for both scenarios in 2050.

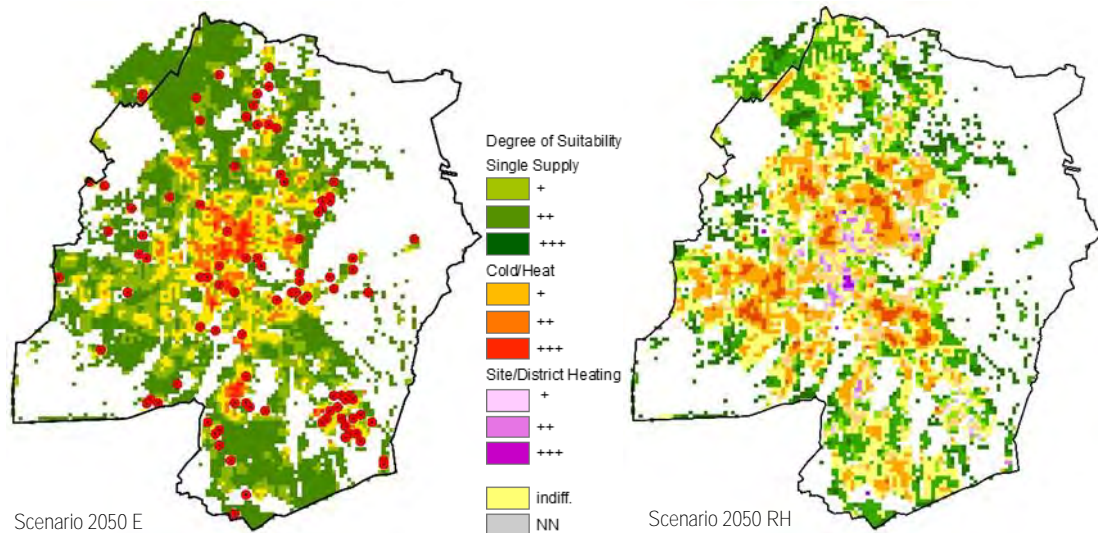

Figure 4: Spatial aggregation and assessment of the suitability in Oldenburg (unscaled)

In 2050 E there are still some sites with a punctual high demand, symbolized with red dots. The analysis of Bramsche/ Wallenhorst shows similar results, but the settlement structure leads to a different patchiness of the suitability areas.

4. CONCLUSION AND OUTLOOK

The presented approach shows, how to create a first idea of a potential local and future development. Now, urban **renewal projects can take into account an overall strategy: “Look over the project-fence.”** The shaping of project areas and the following detailed planning on district level can use it as an orientation. Within energetic driven suitability areas it is possible to find adequate and future proof solutions.

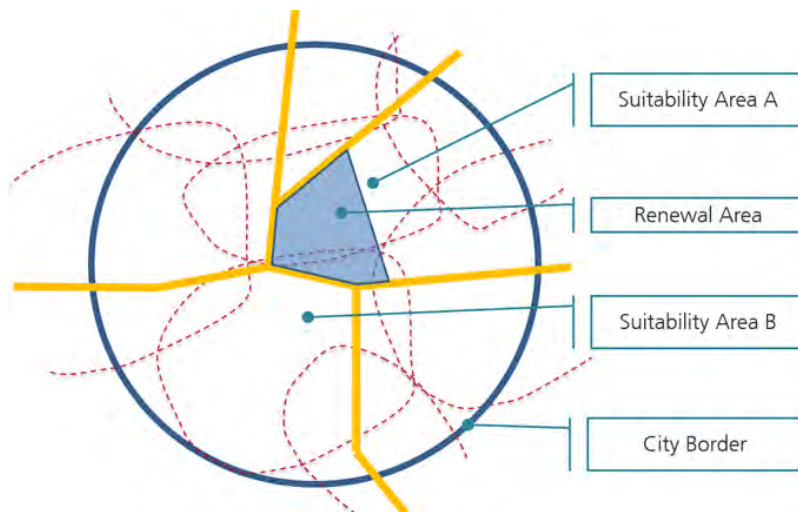

Figure 5: Look over the project-fence with suitability areas

The “Where” and “What” questions can be encircled now on a conceptual level. But the most important question is still open: Who drives the process and how can be brought the ideas of a long term energy planning into action? The approach may help to create a spatial understanding of the stakeholders for the future tasks.

REFERENCES

- [1] S. Kohler, "Wirtschaftliche und politische Anforderungen an die Energiewende im Wärme - und Kältemarkt," 28-Jan-2014, p. 31.
- [2] BMUB, "Klimaschutz in Zahlen." Bundesministerium für Umwelt, Naturschutz, Bau und Reaktorsicherheit (BMUB), Berlin, p. 80, 2015.
- [3] Wuppertal Institut and IFEU, "Diskussionsgrundlage für die zweite Dialogrunde des Beteiligungsprozesses zum Klimaschutzplan 2050 der Bundesregierung - Entwurf von Maßnahmenkurzbeschreibungen nach der Diskussion in den handlungs feldspezifischen Arbeitsgruppen." p. 64, 2016.
- [4] V. Bürger et al., "Klimaneutraler Gebäudebestand 2050." Umweltbundesamt, Dessau-Roßlau, p. 251, 2016.
- [5] A. Claassen, J. Knies, S. Lehnhoff, C. Mayer, S. Rohjans, and S. Rosinger, "Energetic Neighbourhoods – Local Implementation of the Hybrid Grid Concept," 2015, pp. 1–19.
- [6] J. Knies, "The aspect of space in future energy systems," in Sustainable Built Environment Conference 2016 in Hamburg: Strategies, Stakeholders, Success factors, 2016, pp. 1226–1235.
- [7] B. Schloman et al., "Energieverbrauch des Sektors Gewerbe, Handel, Dienstleistungen (GHD) in Deutschland für die Jahre 2011 bis 2013." BMWi, Karlsruhe, München, Nürnberg, 2015.
- [8] M. Hegger and J. Dettmar, Energetische Stadtraumtypen. Bonn: Fraunhofer IRB Verlag, 2014.
- [9] S. Lehnhoff, A. Claassen, M. Reckzügel, M. Meier, and J. Knies, "Technische und ökonomische Machbarkeit Energetischer Nachbarschaften." Universität Oldenburg, Oldenburg, p. 58, 2016.
- [10] S. Mezger, C. Waldhoff, M. Reckzügel, S. Mezger, and C. Waldhoff, "Projekt PlnA - Informations- und Planungsportal Industrielle Abwärme," 2015. [Online]. Available: <http://www.kompetenzzentrum-energie.de/149.html>. [Accessed: 23-Jun-2015].
- [11] Agentur für Erneuerbare Energien e.V., "Metaanalyse: Energiewende im Wärmesektor." Berlin, p. 21, 2015.
- [12] N. Thamling, M. Pehnt, and J. Kirchner, "Hintergrundpapier zur Energieeffizienzstrategie Gebäude." IWU, ifeu, PROGNOSE, Berlin, Heidelberg, Darmstadt, p. 131, 2015.
- [13] M. Wunsch et al., "Potenzial- und Kosten-Nutzen-Analyse zu den Einsatzmöglichkeiten von Kraft-Wärme-Kopplung (Umsetzung der EU-Energieeffizienzrichtlinie) sowie der Evaluierung des KWKG im Jahr 2014," Berlin, 2014.
- [14] Shell International BV, "Scenarios: An Explorer's Guide." p. 98, 2008.
- [15] J. Clausen, "Wärmenetze und Langzeitwärmespeicher als Schlüsseltechnologien der nachhaltigen Wärmeversorgung - Entwicklungspotenziale und Handlungsoptionen." Borderstep, Berlin, pp. 1–37, 2013.
- [16] Kreditanstalt für Wiederaufbau (KfW), "Merkblatt Erneuerbare Energien - KfW- Programm Erneuerbare Energien 'Premium,'" vol. Stand 08/2. KfW, Berlin, pp. 1–15, 2016.
- [17] TFT GmbH, "Kalte Nahwärmenetze Besonderheiten zu Standard- Nahwärmenetzen (Auszüge)," 23-Sep-2015, p. 23.
- [18] C. Neumann, "Effizienz von Nahwärmenetzen im ländlichen Raum, Ergebnisse verschiedener Studien," 25-May-2014, p. 23.
- [19] A. Paar et al., "Transformationsstrategien von fossiler zentraler Fernwärmeversorgung zu Netzen mit höheren Anteilen erneuerbarer Energien." Frankfurt a.M., p. 308, 2013.
- [20] Y. Xing, A. Bagdanavicius, S. Lannon, M. Pirouti, and T. Bassett, "Low Temperature District Heating Network Planning With Focus on Distribution Energy Losses," in International Conference on Applied Energy ICAE 2012, 2012, p. 3.
- [21] D. Schmidt, A. Kallert, M. Blesl, S. Svendsen, N. Nord, and K. Sipilä, "Low temperature district heating for future energy systems," 14th Symp. Dist. Heat. Cool., 2014.
- [22] T. J. Ross, Fuzzy Logic with Engineering Applications, 3rd ed. New Mexico, USA: Wiley & Sons, 2004.

Building Drives for Behaviour Change – Role Model of Sustainability

Ricky LI^a, Edwin CHAN^b, Tony LAM^c, Vincent CHENG^d

^a Arup, Hong Kong SAR, ricky.li@arup.com

^b New World Development Company Limited, Hong Kong SAR, edwinchan@nwd.com.hk

^c Arup, Hong Kong SAR, ngan-tung.lam@arup.com

^d Arup, Hong Kong SAR, vincent.cheng@arup.com

ABSTRACT

The most effective way to realize sustainable lifestyle is not to install considerable amount of cutting-edge technologies, but it is more important to implement sustainable provisions that drive the behaviour change of stakeholders. Demonstration buildings that aim to drive the behaviour change of stakeholders would act as a role model of sustainability to influence everyone engaged with the building, including visitors, building operators, building owner and nearby communities, etc.

The Green Atrium, a 3-storey demonstration building, is built within a residential development in Yuen Long, Hong Kong, in a rural community where large amount of traditional farmlands are located. The Green Atrium is intended to establish the coexistence of commercial activities and environmental protection which are often irreconcilable. It provides a set of commercial facilities serving the visitors and the community—supermarket, restaurant, multi-purpose venue, exhibition venue and rooftop garden. To protect the environment, a total of 28 sustainable features are installed to achieve low carbon operation, as well as to maximize the lifetime of resources such as food and water by creating a circular economy.

There are 4 key objectives of The Green Atrium:

- A role model of future developments for low carbon operation and a prototype for innovative sustainable technologies.
- A showcase of holistic sustainable lifestyle to stakeholders through interactive engagement and implementation of sustainable design features.
- A coexistence model of commercial activities and environmental protection to establish a complementary linkage.
- A focal point to form a hub to promote sustainability, to educate the public, to organize community events, as well as to provide an organic market, given its location within close proximity of agricultural land, vernacular villages and country parks.

Keywords: Behaviour change, sustainability, low carbon, community, commercial, engagement

1. INTRODUCTION

Climate change and environmental depletion are two major ecological challenges facing by humanity. According to United Nations, “sustainable development is development that meets the needs of the present without compromising the ability of future generations to meet their own needs” (WECD, 1987). It consists of three pillars, namely environment, social and economic, which require integration and balance of each area to achieve the ultimate goal of sustainable development. Sustainable development is being commonly applied in building construction to address ecological issues and green buildings are emerged as a result. Green buildings typically contains considerable amount of cutting-edge technologies in the building systems to reduce resource use and to enhance environmental quality of the building. However, this approach is often not effective in terms of sustainability due to the disconnection between building systems and the occupants, in which the social aspect is being neglected. To maximize the benefits of green building, the building shall become a driver for behaviour change of every stakeholder.

In response to become the next generation of sustainable building that preserve the environment and provide social benefits, The Green Atrium was commissioned to be designed in 2013 and completed in 2015. The purpose of The Green Atrium is to become a role model of sustainability and to set an example for future developments. It adopts an eco-living concept that engages the community with the building. The Green Atrium is intended to

establish the coexistence of commercial activities and environmental protection which are often irreconcilable. There are a total of 28 sustainable features installed to achieve low carbon operation and to maximize the lifetime of resources such as food and water by creating a circular economy. The Green Atrium is aimed to begin a revolution in sustainability by making positive impacts to the real estate industry, the construction industry and the community. The outlook of The Green Atrium and the eco-living concept is shown in Figure 1.

This paper discusses the detailed approach of sustainable design development and sustainable operation principles in The Green Atrium for driving behaviour change of stakeholders.



Figure 1: Outlook of The Green Atrium (Left) and eco-living concept (Right)

2. SUSTAINABLE DESIGN

The Green Atrium is an experimental building that offers commercial, educational and community spaces. Climate responsive design approach is adopted to facilitate the use of natural resources. The Green Atrium incorporates active and passive sustainable design considerations, which aims to provide a green hub to promote holistic lifestyle through interactive engagement and sustainable feature installations. Regenerative model is adopted to create a circular economy within the site, extending the life of resources by feeding waste from one system as the resource for another. A total of 28 key sustainable features are categorized to 5 fundamental elements: energy, air, water, food and waste. Each element creates its own cycle and interlink with each other to form a semi-self-sustained system. Furthermore, The Green Atrium is the first project to install the award winning ventilation device, the Air Induction Unit (AIU), providing an innovative and revolutionary experience to building users. The sustainable design features at The Green Atrium are shown in Figure 2.

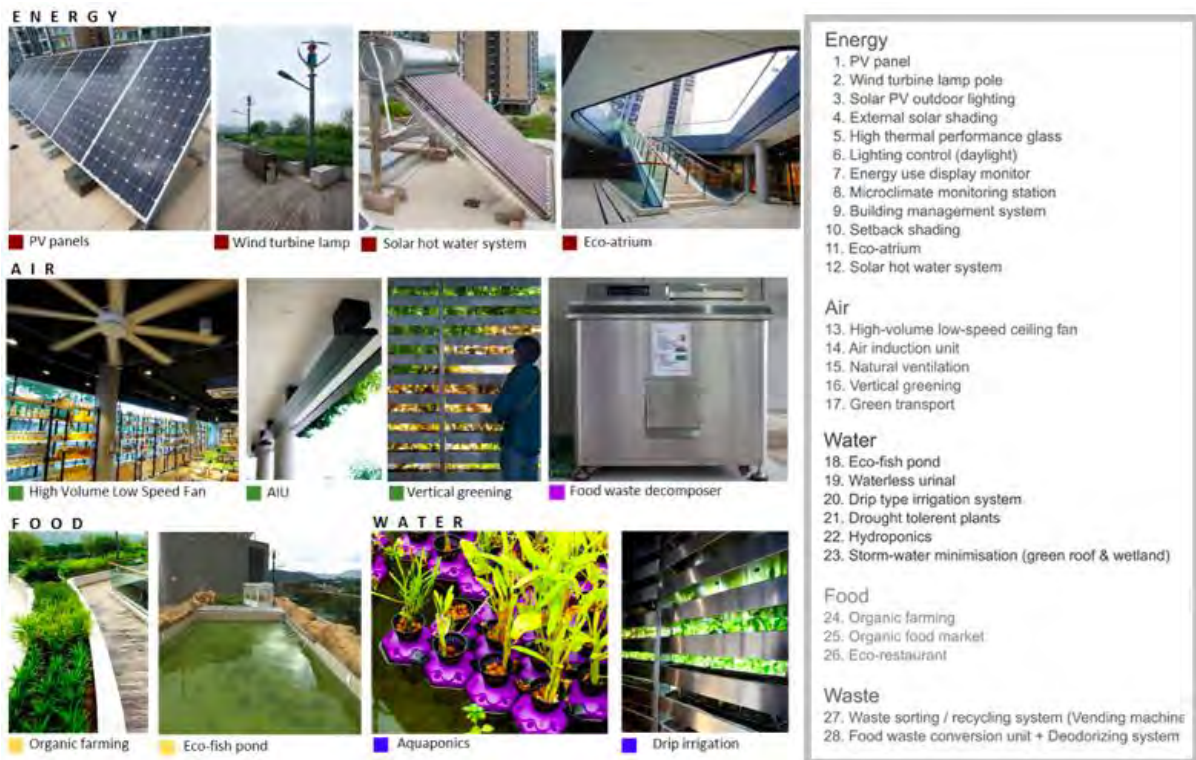

Figure 2: Sustainable features at The Green Atrium

2.1 Climate responsive design

Buildings account for a major portion of total energy use in Hong Kong, nearly 70% of overall energy were consumed by buildings in 2013 (EMSD, 2015). The Green Atrium has adopted both passive and active strategies for de-carbonization. Particularly, climate responsive design was employed from the early architectural planning stage. The architectural design is optimized to accommodate spatial functions and passive design features. The design begins with a bounding volume with maximum GFA of approximately 2,200m². The intermediate level is opened to create a fully shaded semi-outdoor space. An atrium is added to enable fresh air flowing across the building and removing accumulated hot air. The permeability and shallow floor plate depth enhance daylight penetration into the interior space. The microclimatic responsive façade reduces heat exposure on building surface and provides visual comfort for building users.

Furthermore, environmental simulations are carried out to optimize the climate responsive design in terms of natural ventilation, daylight and solar radiation. Starting from a conventional built form, daylight penetration and natural ventilation are inadequate and the facade is exposed to high level of solar radiation. The green wall at 2/F and the setback shading at 1/F effectively reduce the exposure of solar radiation. A large void is added in the middle of the building mass to enhance daylight penetration and natural ventilation through the building. Lastly, high performance XIR glass is installed at G/F shop front to reduce solar load while maintaining exceptional daylight performance for the commercial space. The climate responsive design process using environmental simulation is shown in Figure 3.

Climate responsive design is an effective approach to reduce building energy use and The Green Atrium is setting an example for this design approach.

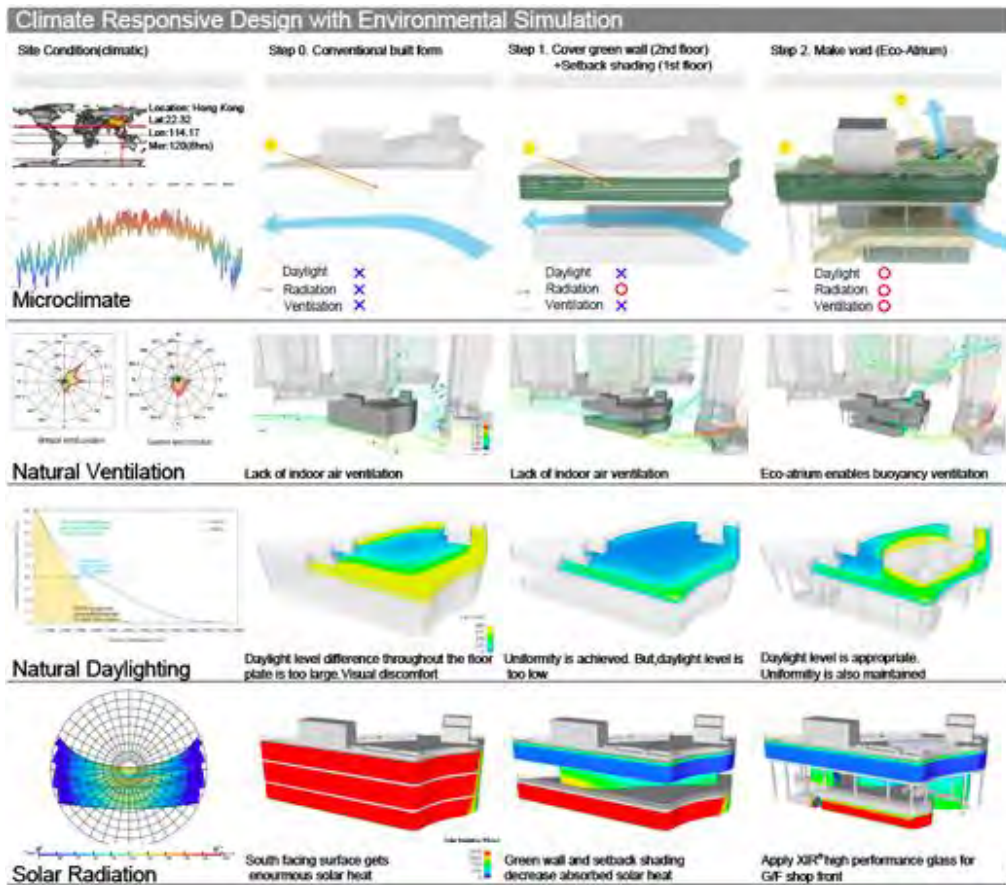

Figure 3: Environmental simulation process for optimizing climate responsive design

2.2 Circular economy

Circular economy is a system that aims to eliminate waste through restorative and regenerative by design (EMAF, 2013). In The Green Atrium, the design of the biological and mechanical systems are based on circular economy, where waste from one system is eliminated by feeding as the resource for another. For example, food waste from the restaurant is being converted into fertilizer and fish feed by the food waste decomposer for on-site farming and fish cultivation. The vegetable and fish crops from on-site farming and fish cultivation would be freshly served at the restaurant in The Green Atrium, thereby creating a closed loop of commodity supply. Another example is the aquaponics system at R/F. It mimics water filtration and recycling process in natural ecology, where the polluted water in fish pond with fish waste is being fed to the hydroponics as nutrient for plants. The in the hydroponics flows back to the fish pond after the toxic substances are removed by the plants. The food waste cycle and system provisions at The Green Atrium are shown in Figure 4.

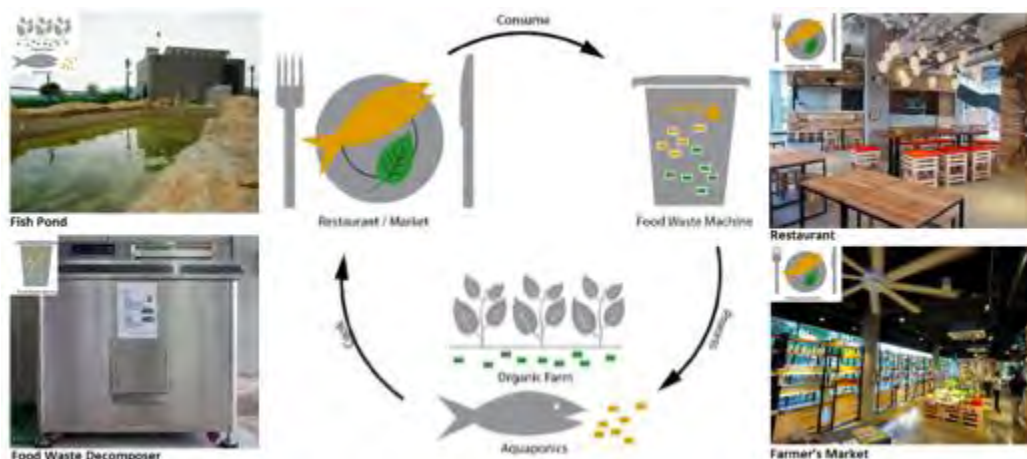

Figure 4: Food waste cycle and system provisions at The Green Atrium

2.3 Innovative technology

The Air Induction Unit (AIU) is a displacement ventilation device stimulating breeze-like moving air for enhanced comfort. It has a minimal and aesthetically pleasing blade-like design that operates using the principle of induction in aerodynamics. It is designed to enhance the thermal comfort by inducing a large volume of gentle air movement. The AIU aims to be an alternative to other means of mechanical ventilation such as industrial fan and ceiling fan.

The AIU is installed at the 1/F semi-outdoor space and it consumes about 30% less energy than using conventional fans. The AIU has no mechanical part exposed to its service environment. It is safer and easier to clean and maintain compared with conventional industrial fans, which lead to lower maintenance cost. The installation of the AIU at The Green Atrium is shown in Figure 5.

The benefits of the AIU is intended to be demonstrated at The Green Atrium. With wide-adoption, the AIU would revolutionize the industry and bring positive impact to the environment and the community.



Figure 5: Installation of AIU at The Green Atrium

3. SUSTAINABLE OPERATION

The operational phase is the longest phase during the lifecycle of a building. It is therefore important to ensure the building is being operated sustainably by taking environment, social and economic aspects into consideration. The sustainable operation at The Green Atrium forms a complementary linkage where commercial activities and environmental protection can co-exist and maintains a symbolic relationship that neither one can be neglected. The upper energy hub sustainably converts natural resources into energy for The Green Atrium, while commercial activities in the lower block provides economic support for the operation of The Green Atrium.

3.1 Post-occupancy evaluation

Previous study shows “over 80 percent of greenhouse gas emissions take place during the operational phase of buildings” (UNEP, 2009). For this reason, it is crucial to ensure the building would be operated in an efficient manner. After a building is designed and constructed, the systems often do not operate as specified during operation. Post-occupancy evaluation (POE) is an evaluation and feedback process that enables design verification and continuous improvement of building systems (HEFCE, 2006).

In The Green Atrium, sensors and meters are installed to monitor energy usage, water usage, renewable energy generation and microclimate of the development. A dashboard displays real-time data of building performance and local climate, allowing visitors and operators to easily view, monitor and evaluate the building performance. The measured data during first year operation shows the energy use of The Green Atrium is 70.8% more efficient in comparison to the energy use benchmark developed by Energy Efficiency Office of the Electrical and Mechanical Services Department for similar building type (EMSD, 2016). The detailed monthly energy consumption breakdown for various energy use and the POE equipment installed at The Green Atrium are shown in Figure 6.

The implementation of POE at The Green Atrium showcases the benefits towards sustainable building operation. It sets a new standard of building operation for future developments.

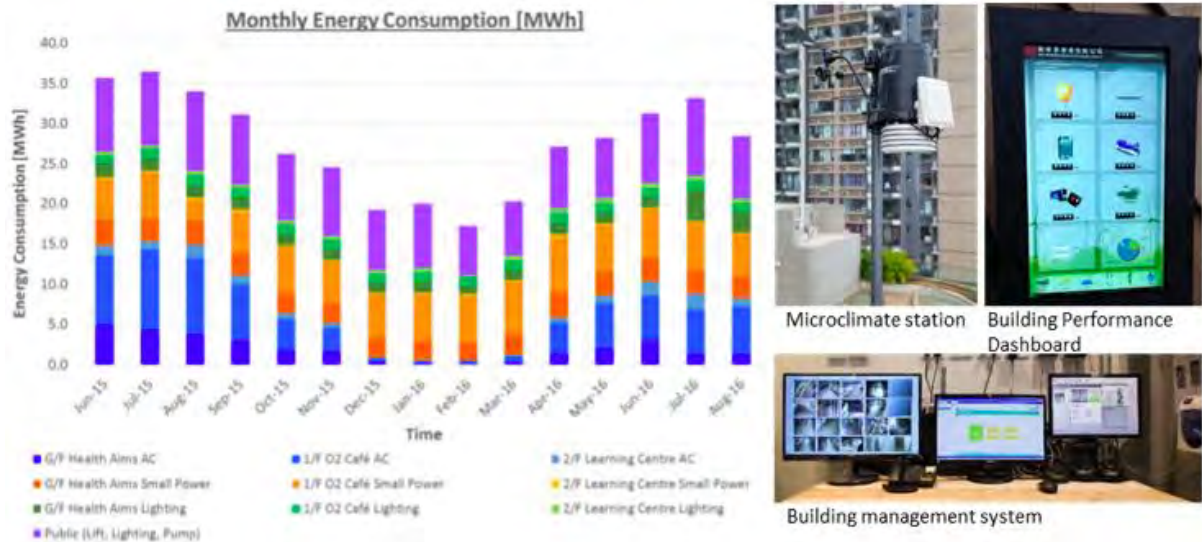

Figure 6: Monthly energy use breakdown from Jun-15 to Aug-16 (Left) and POE Equipment (Right)

3.2 Green community movement

Located within close proximity of agricultural land, vernacular villages and the Country Park in Yuen Long, The Green Atrium forms a focal station to promote sustainable technologies, green community events, as well as organic food production for the neighbourhood. To promote local farming and organic food products to the communities, The Green Atrium provides a venue to sell organic food products at the G/F market and a restaurant to introduce farm-to-table concept at 1/F restaurant. Themed events are organized at The Green Atrium and regular tour are hosted at the 2/F exhibition and R/F educational spaces, during which visitors could understand the relationship between lifestyle, health and sustainability. The schedule of accommodation of the building is summarised in Figure 7.

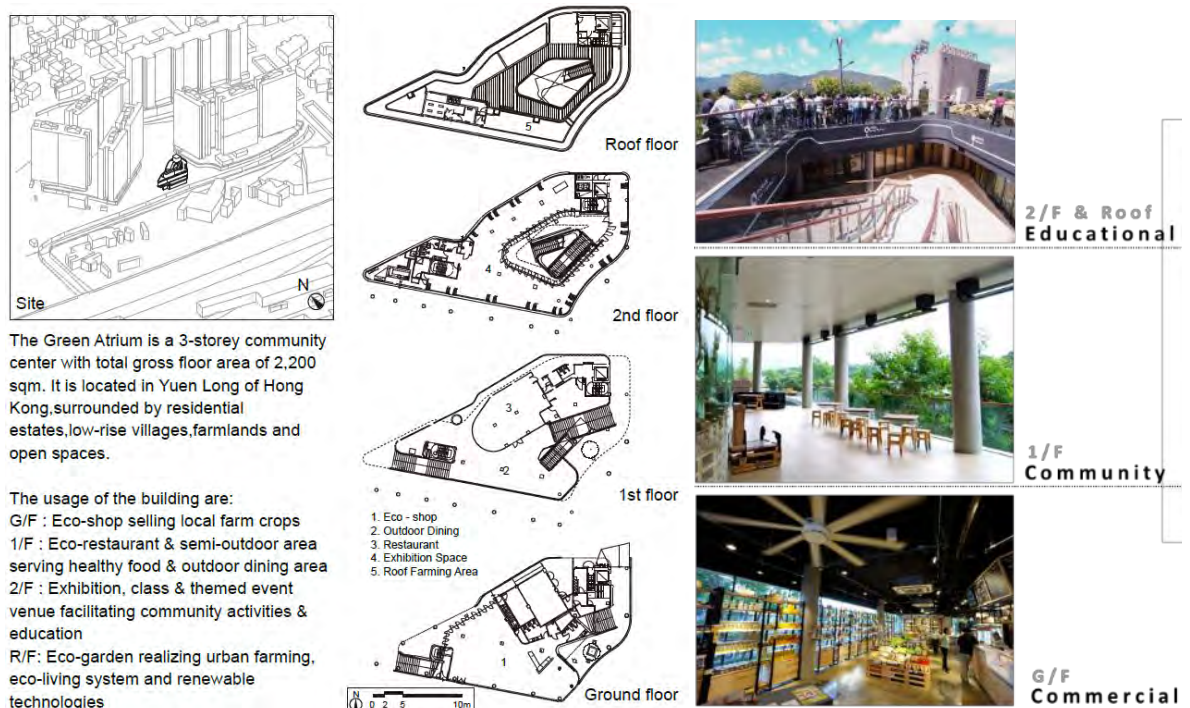

Figure 7: Spatial function breakdown of The Green Atrium

In addition to be a green hub for the community, The Green Atrium equips with infrastructures to facilitate sustainable operation in the neighbourhood. The adjacent residential development, Park Signature, is designed with large openings in the clubhouse for natural ventilation to reduce air-conditioning energy use when weather

permits. The real-time local climatic data measured by the microclimate monitoring station at The Green Atrium provides useful information for the clubhouse operator to use natural ventilation according to the pre-determined thermal comfort criteria.

All in all, The Green Atrium is not only a sustainable building by itself, but it is also a facilitator to transform the local community into a sustainable neighbourhood.

4. CONCLUSIONS

The Green Atrium is a role model of sustainable building, it is aimed to bring benefits to all three dimensions of sustainability, including the social aspect which is often being neglected. Sustainable design concepts are incorporated from the beginning of the architectural planning stage with objectives to provide sustainable operation.

The Green Atrium provides an “experiential ground” allowing new sustainable concepts and prototypes to be put to test, review and improve. The concepts and technologies learnt would be useful for successful adaptation in future projects. New ideas are being implemented in The Green Atrium to push the forefront of sustainability. Climate responsive design, circular economy and AIU are adopted to revolutionize the building construction industry. POE infrastructures are installed to enable performance verification and continuous improvement. Lastly, commercial and educational facilities are provided for building social engagement and driving green movement in the community.

REFERENCES

- [1] Electrical & Mechanical Services Department (EMSD), 2015. Hong Kong Energy End-use Data 2015. Hong Kong
- [2] Electrical & Mechanical Services Department (EMSD), Energy Utilization Indexes and Benchmarks for Residential, Commercial and Transport Sectors [online]. Retrieved from: <http://ecib.emsd.gov.hk/en/index.htm> [Retrieved on 17 June 2016]
- [3] Ellen MacArthur Foundation (EMAF), 2013. Towards the Circular Economy Vol.1: an economic and business rationale for an accelerated transition. United Kingdom
- [4] Higher Education Funding Council for England (HEFCE), 2006. Guide to Post Occupancy Evaluation. United Kingdom
- [5] United Nations Environment Programme (UNEP), 2009. Buildings and Climate Change. UNEP DTIE Sustainable Consumption & Production Branch, Paris
- [6] World Commission on Environment and Development (WECD), 1987. Our Common Future - Brundtland Report. Oxford University Press, Oxford

Session 7.10: Innovative Practices to Transform SBE (2)

A Revolutionary Study Commons and University Library Extension, The Chinese University of Hong Kong

FUNG Siu-man^a, Thomas YUEN Ka-yiu^b

^a The Chinese University of Hong Kong, Hong Kong SAR, smfung@cuhk.edu.hk

^b The Chinese University of Hong Kong, Hong Kong SAR, thomasyuen@cuhk.edu.hk

ABSTRACT



As mother nature, natural resources and heritages worldwide are threatened by the rapid pace of urban growth and development, The Chinese University of Hong Kong (CUHK) has demonstrated her commitment to develop a **“Sustainable Green Campus” through intensive studies, engagements and design innovations.**

The Library Extension project completed in 2012 featured a minimalist and sustainable design that cleverly integrated a love of nature with respect of history, and demonstrated how development needs were balanced with preservation concerns. The tough challenges of the project included the following aspects:

- **Preserving CUHK’s history, values and collective memories**
- Design for quality learning environment
- Exploring opportunities for developing underground space
- Green Building design and efficacy
- User-oriented design and knowledge sharing

The project has explored various new frontiers and opened up opportunities for sustainable development. While the iconic University Mall and Garden dating back to the 1960s were preserved by the innovative design of a generous Learning Commons in the basement, the much loved swifts habitat on the existing Library building was successfully preserved through careful studies and measures. The project has obtained the highest HKBEAM Platinum rating for her sustainability and energy conscious design and was honoured with Green Building Award in 2014.

Keywords: library, green building design, sustainable neighbourhood ding

1. INTRODUCTION

The University Library Complex consisted of three independent buildings with little interactions with each other as **the original 1970’s main library, its 1980’s annex, and the** latest new extension were built decades apart. This project involved the construction of a new Extension and spatial re-organization of the two existing buildings;

merging together and transforming into a coherent whole where different learning activities could come together in the open and free planning spaces.

2. PRESERVING OUR HISTORY, VALUES AND COLLECTIVE MEMORY

2.1. Embedment into the campus environment

The project addressed the core values of **CUHK's** Campus Master Plan and Vision of “combining the tradition with modernity, and bringing China and the West **together**” and sustainability targets.

The new Extension annexed to the iconic University Library preserved the spatial quality and ambient of the University Mall with complimentary massing and height same as the adjacent buildings. The simple and unadorned design preserved the architectural integrity of the central axis of the University Mall and the adjacent landmarks, including the Roman-style garden ‘Forum’ and the ‘Beacon’ on which the sculpture ‘Gate of Wisdom’ stands.

The project featured a minimalist, sustainable, preservative and conservative design that integrated nature with respect to its history; a huge basement was developed under the ‘Forum’ and the ‘Beacon’ to minimize the visual impact.

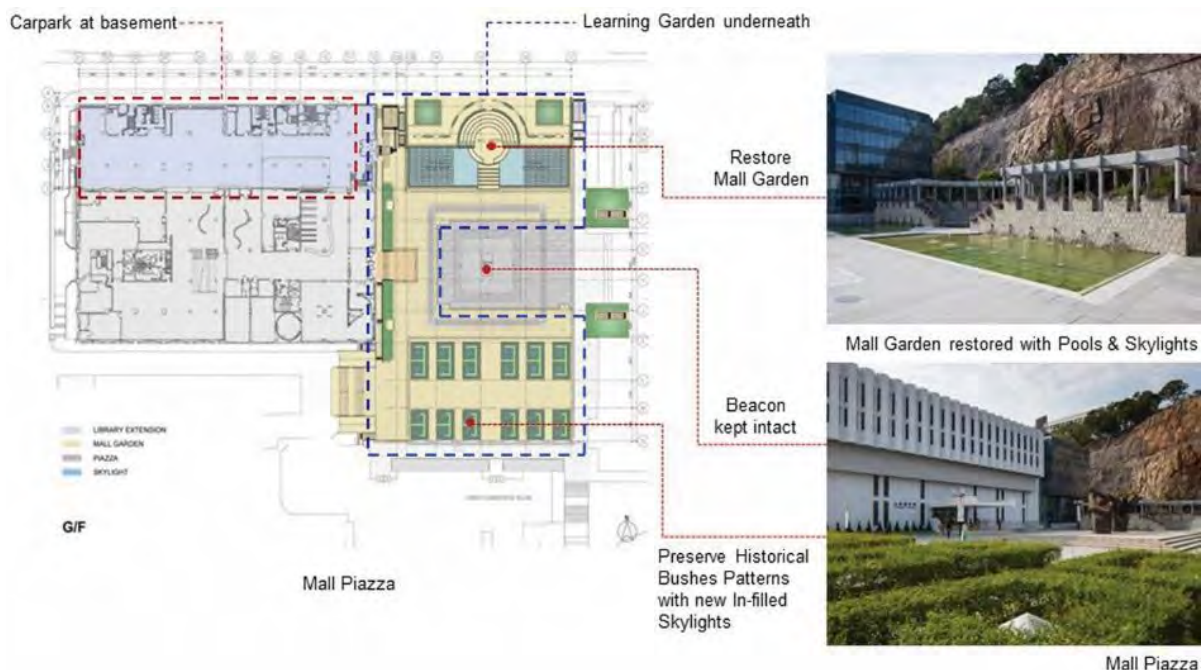
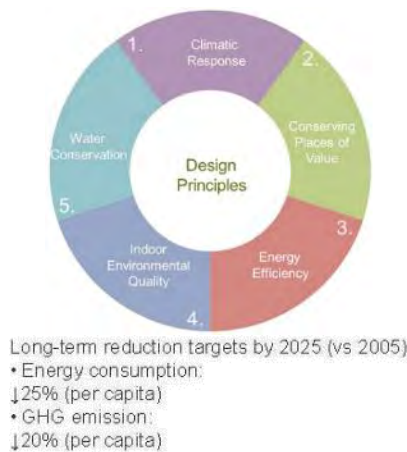

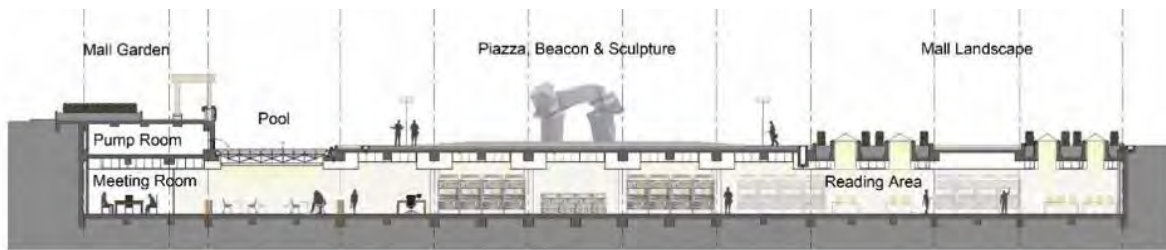

2.2. Preserving historical façade

Inside the Extension, the historical façade of the University Library was preserved to become a feature wall for the atrium space, lighting up by the skylight above, serving as a visual articulation of Meeting the Old and the New.

2.3. Preserving swift habitats

CUHK is home to the largest colony of house swifts in Hong Kong and the eaves of the University Library house over 500 house swifts. To minimise the impact on the house swifts due to the construction of new Extension, CUHK invited consultants to carry out ecological study and was suggested to incorporate bird-friendly glazing for the new Extension and to install artificial nests to allow birds' migration to the south façade of the University Library before the construction.

Bird-friendly façade with fritted pattern glass panels was adopted for the new Extension. Mock-up and tests were also conducted on site to ensure no unwittingly kamikaze performs on the external wall of new Extension.



Preservation of historical façade



Preservation of swifts habitat

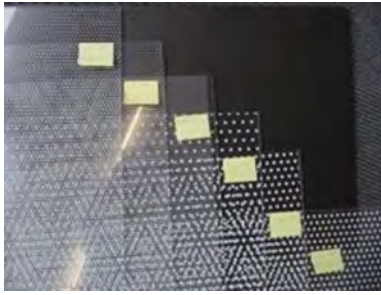

Bird-friendly façade design with fritted glass pattern

3. ENVIRONMENTAL QUALITY

The project aimed at creating quality space conducive to the physical, psychological and emotional needs for learning and interactions.

3.1. Transparency and daylight

External walls of the Extension with low-E double glazing reduced solar heat gain and maximized daylight penetration. It invited lovely nature environment into the study areas during daytime and displayed the indoor study life to the external campus at night.

3.2. Spatial connectivity

As part of the spatial reorganization for the entire Library complex, a central void with a new grand staircase **platform, the 'Reading Garden', was inserted** into the existing library. This physical connection not only opened up the interiors but also enhanced the inter-floor communication and interactions among students for an active learning environment. The existing skylight above further brought daylight into the renovated library floors for both environmental comfort and energy saving.



Reading Garden



Atrium

3.3. Acoustics

Double glazing façade panels provided effective acoustic insulation from the adjacent road traffic to create a quiet learning ambience. Variable air volume (VAV) A/C system was also adopted to minimize noise generation in the interiors. The noise level was mitigated effectively from 80dBA road traffic noise with busy school buses to 35dBA inside the library spaces.

4. INNOVATIVE DEVELOPMENT OF UNDERGROUND SPACE

With an innovative design, the extensive basement of about 4,500 sq.m. was designed into a colourful 'Learning Garden' which presented a new image for library interiors: spacious, cosy and bright. While chairs in vibrant colours and 'Bubble' shape workrooms were available for students having small group discussions or studying alone, the 'Learning Garden' opened up its interiors to glittering daylight and green surroundings above through an extensive

glass ceiling of under-pool skylights. These innovative skylights consisted of a thin layer of water on top of laminated double glazing; the assembly provided desirable thermal insulation for the 'Learning Garden' below.

Inside the Learning Garden, one could find the long, sinuous, wavy, S-shaped table, the 'Learning Path', **woven** students together through its curves and defined a series of study zones. This ambiguity between public and private, openness and enclosure, allowed for different modes of study and flexible use of spaces. Subtle variations in the height, width, and shape of the Learning Path provided a datum line for students to discover new ways of learning.

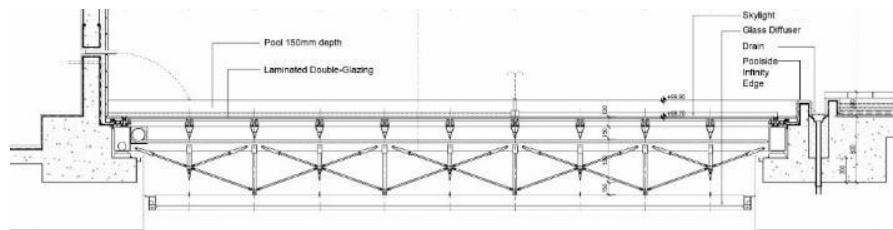

Learning garden and under-pool skylights

5. EFFICACY

The University Library Extension project was honoured with the FuturArc Green Leadership Award 2016. As highlighted in the 10th Anniversary Edition Vol. 48 of FuturArc magazine:

“To align with sustainability policy of The Chinese University of Hong Kong, many energy-efficient features have been adopted for the project. Rainwater and condensate water are collected to serve irrigation, cooling and flushing purposes. Adjacent buildings share a centralised chiller plant, hence reducing the peak electricity demand. To maximize energy savings, different types of sensors have been adopted: fresh airflow control via carbon dioxide sensors and heat pipes; car park ventilation control via nitrogen dioxide and carbon monoxide sensors; a highly efficient heat pump unit for dehumidification and space heating; and PVC panels to generate energy for landscape lights.”

Façade area was reduced effectively by designing the new Extension as an attachment to the original University Library. Extensive basement construction of about 4,500 sq.m. also reduced materials consumption considerably versus conventional superstructure and building envelope construction.

With the objective to preserve the historical Mall Garden, every granite stone of the historical Mall Garden was surveyed, dismantled and reinstalled after the basement construction.



6. USER-ORIENTED DESIGN AND KNOWLEDGE SHARING

This project aimed to develop a people-oriented study space and to provide a healthy and comfortable study environment. Besides making good use of natural daylight and the surrounding greenery, the highly flexible design of the learning commons and its IT backbone further encouraged users to explore their own ways of study with unlimited possibilities. With the implementation of Green product and purchase policies, environmentally-friendly materials and finishes were used throughout the entire building; furthermore, interior lighting and air conditioning were optimized with building automation and sensor systems to achieve excellent indoor air quality and energy saving.

The Library Extension was well received by the users as well as the visiting public and scholars since her completion. It has provided CUHK with an excellence model for education and knowledge sharing in Green Building Design and Sustainability Development. Collaboration with the academia for case studies and data analysis on building performances was also in progress.

Users' feedback

University Librarian - Ms Louise Jones's Comments

"The Learning Garden at the University Library – a most wonderful innovation and a much welcome collaborative space for students and for the Library to make new offerings. It is allowing us to reconceptualize the Library."

FuturArc Green Leadership Award 2016 **juror's comments**

"A project must tell the story of where it is, of people and space ... The entries display a good cross section of innovative and ecologically responsive designs that respond to different social, cultural and climatic contexts...articulate a genuine sense of sustainability, blending in neatly with its surrounding environment; harnessing the use of natural resources a topography..... achieving exquisite spatial qualities, fitness for purpose; and a comforting environment."



Green Building Award 2014 - Hong Kong Green Building Council Merit Award - New buildings category (completed buildings) **jury's citation**

"A comfortable environment with a natural appearance has been created for learning. Attention to the interface between indoors and outdoors may further enhance its humanistic quality."

REFERENCES

- [1] The Hong Kong Institute of Architects Annual Awards 2013
- [2] HKGBC Green Building Award 2014
- [3] FuturArc 10th Anniversary Edition, Volume 48, May-Jun 2016
- [4] The Chinese University of Hong Kong, Campus Master Plan Report, January 2010
- [5] CUHK Strategic Plan 2016-2020
- [6] CUHK Newsletter No. 404, 2012; No. 407, 2012, No. 412, 2013 and No. 418, 2013
- [7] Sustainable Campus, CUHK, Winter 2012
- [8] Images and Photos courtesy of: ULS, CPSO & ISO of CUHK, Aedas Ltd., PangArchitect Ltd.

Nearly Zero-Energy Care Home Design in Cold Climate in China

HOU Shan-shan^a, Phil JONES^b, ZHOU Yanmin^c

^a Cardiff University, United Kingdom, hous1@cardiff.ac.uk

^b Cardiff University, United Kingdom, jonesp@cardiff.ac.uk

^c Tsinghua University, Mainland China, yanminzhou@263.net

ABSTRACT

China is facing an increasing challenge of aging population. United Nations projected that a third of Chinese population will be over 60 by 2050. The requirement for the state and private housing provision for the elderly is emerging due to the absence of children caring for their parents. A revolution in architectural design for the aging population is expected to deal with this unprecedented situation.

In addition, care homes have high energy requirements 24 hours a day and 7 days a week as well as high level comfort requirement. It is important to improve energy efficiency of care homes to tackle the overall fuel security and climate change as well as to reduce the running cost in order to reduce the finance burden in an aging society. However, their energy consumption profile and thermal requirements present both opportunities and challenges to energy positive design which can generate more energy than it consumes.

The paper aims to investigate the potential to deliver nearly zero-energy home design in cold climate in China with a system approach and innovative technologies which have been established in research and practice in the UK. A systems approach for energy positive care home design consists of four steps: 1) reducing internal heat loads, 2) using passive design strategies, 3) applying efficient HVAC systems and 4) integrated renewable energy supply and storage systems. Building simulation is used to optimise the design in each step in order to achieve the most practical design solution.

In this study, a typical care home in China is used to provide the geometry information, and building simulation will be carried out with local context and climate to evaluate the impact of different design steps and strategies. Furthermore, the impact of each design strategy on energy consumption will be discussed.

Keywords: nearly zero-energy care home design, building energy simulation, high performance building

1. INTRODUCTION

China's 13th Five-Year Plan (2016-20) aims to reduce overall energy use by 15% per unit of GDP and carbon emissions by 18% by 2020, compared to the 2015 level (Seligsohn, 2016). In addition, China is facing an increasing challenge of an aging population with a third of its population over 60 by 2050 (Denison and Ren, 2014). An urgent requirement for the state and private care home provision is emerging to replace the traditional model of children caring for their parents at home. Care homes have high energy consumption due to 24/7 operation and a high level comfort requirement. Therefore, it is important to improve the energy efficiency of care homes to tackle the overall fuel security and climate change, and to reduce running costs in order to reduce the financial burden in an aging society.

In order to deliver nearly zero-energy buildings and energy positive buildings, it is important to adopt a holistic systems approach. A systems approach is a sustainable design method that integrates across site planning, architectural design and building engineering, which can provide lower running costs and contribute to reducing the demand on the energy supply infrastructure. A holistic systems approach consists of four steps (Figure 1): 1) Reduce energy demand by using energy efficient lighting and equipment to reduce direct energy usage as well as the heat gains to the space; 2) Apply passive design strategies in relation to site planning, building form and building fabric, to utilize free energy (mainly solar and wind), and reduce heat gains in the cooling season and heat losses in heating season; 3) Use efficient HVAC systems to further reduce energy demand; 4) Integrate renewable energy supply and storage systems to decarbonise remaining energy requirements.

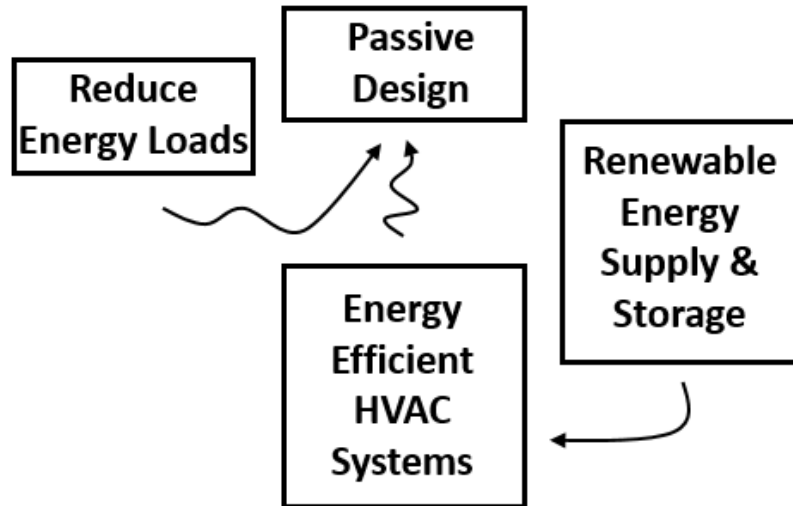

Figure 1: Four steps of a systems approach (Jones et al., 2015)

2. CURRENT STANDARD OF PUBLIC BUILDING DESIGN IN CHINA

The China Design Standard for Energy Efficiency in public buildings (GB50189-2014) developed by the Ministry of Construction is playing an important role in regulating the energy efficiency in commercial buildings in China (Hong et al., 2015). It aims to reduce energy consumption by 30% compared to the 2005 standard. GB50189-2014 provides prescriptive compliance pathway for new building construction and retrofits, covering design standards for building envelope, HVAC systems, lighting, plug loads, water and drainage systems, domestic hot water systems and renewable energy supply systems. All building sub-systems and components must fulfil the prescriptive efficiency requirements.

In relation to energy demand, the GB50189-2014 sets the maximum Lighting Power Density (LPD) for different room types. Table 1 compares the LPD requirements of different countries. The British and American standards are more generous in energy usage in lighting, while the Swiss best practice can provide good lighting condition with less LPD due advanced lighting technologies.

	GB 50189-2014	CIBSE	ASHRAE90.1-2013	SIA180
Lobby	9.0	10-20	11.5	5.6-8.3
Office	9.0	8-12	12	9.1-12.5
Ward room	5.0	9.0	6.7	2.9-4.5
Exam/ treatment	15.0	15.0	18.0	11.6-15.9
Dining/ lounge room	--	--	--	4.6-6.9
Kitchen	--	--	--	12.4-17.0
Circulation area	--	--	--	4.6-7.0

Table 1: LPD requirements of different countries (W/m^2)

Regarding passive design strategies, the GB50189-2014 for cold zone sets the minimum requirements for building fabric. Compared to the Building Code in the UK and US, these requirements are less stringent (Table 2). This reflects the relative poor market penetration of high performance envelope technologies in China, as well as the importance of developing such materials and technologies suitable for the building industry in China (Hong et al., 2015). In addition, the requirements for opaque components are related to shape co-efficient, while the standards for windows are related to Window to Wall Ratio (WWR) and the orientation of the windows.

		GB 50189-2014		Building Regulation Part L 2014		ASHRAE 90.1-2013
		Shape co-efficient \leq 0.3	0.3<Shape co-efficient \leq 0.4	Min.	Recipe	
External wall		0.50	0.45	0.35	0.26	0.291-0.513 [^]
Roof		0.45	0.40	0.25	0.18	0.119-0.184 [^]
Ground floor		0.50	0.45	0.25	0.22	1.263-1.765 [^]
Floor		0.50	0.50	0.25	0.22	0.188-0.321 [^]
Glazing	U-value	2.00-3.00 [*]	1.80-3.00 [*]	2.20	1.60	1.82-2.84 [^]
	G-value	0.35-0.52 [*]	0.42-0.588 [*]	-	0.40	0.40
Party wall		1.0	1.0	-	-	-
Infiltration		-	-	10m ³ /h/m ²	3m ³ /h/m ²	-
Note		[*] The range depends on different WWRs from 0.2 to 0.7. G-values mainly applies for east, west and south windows. [^] The range depends on different construction types.				

Table 2: Fabric efficiency U-value (W/m²/K)

In relation to building service systems, the GB50189-2014 sets the minimum efficiency requirements of HVAC systems. The standard for efficiencies of HVAC systems in China is lower than the relevant standards in the UK and the US (Table 3).

		GB 50189-2014	Building Regulation Part L 2014	ASHRAE 90.1-2013
Chiller efficiency	Water cooled	4.1-5.8	4.5	4.69-6.29
	Air cooled/ evaporative	2.6-3.0		2.4-2.8
Unitary air conditioning	Water cooled	2.9-3.5		3.51-3.6
	Air cooled	2.4-2.75		2.78-3.81
Boiler		86-90%	91%	-
Specific Fan Power		0.27W/m ³ /h	1.8W/L/s	-

Table 3: HVAC systems efficiency (W/m²/K)

In relation to renewable energy supply and storage systems, the GB50189-2014 sets out guidelines for the use of solar power and ground source heat pumps. An evaluation of solar resource is required before the detailed design of a PV system. In addition, the minimum efficiency for heat pump units is defined. However, there is no mandatory requirement or guidance for the renewable energy storage systems.

The following section will introduce the process to investigate the energy performance of a typical care home in Beijing with this systems design approach.

3. RESEARCH METHODOLOGY

3.1 Research flow

This study was conducted in three steps: 1) Select a typical design of care home, located in Beijing; 2) Develop modelling frameworks for current practice, as well as for nearly zero-energy design, including parameters for internal gains, building fabric, HVAC systems and renewable energy supply and storage systems; 3) Conduct building energy simulations for (i) Current practice and (ii) Nearly zero-energy design (good and best practice). The simulation results of monthly and annual energy consumption were compared and discussed.

3.2 Typical care home design

There are two main categories of elderly accommodation in China: 1) Care centres which are staffed 24 hours a day with provision of care; 2) Residential development designed specifically for the elderly but without the level of medical care. This study focuses on the first categories.

A typical good care home design in Beijing is selected (Figure 2). The building is 5 stories above the ground with a floor area of 2100m² for each floor. The floor to ceiling height is 3.3m. The shape coefficient is 0.195, while the WWR is 0.2/ 0.3. It has rooms for 2, 4 and 6 occupants with a capacity of 216. The design of the typical building has carefully considered the space for wheelchair access, good daylighting (all rooms facing south) and natural ventilation potential, as well as good vision.

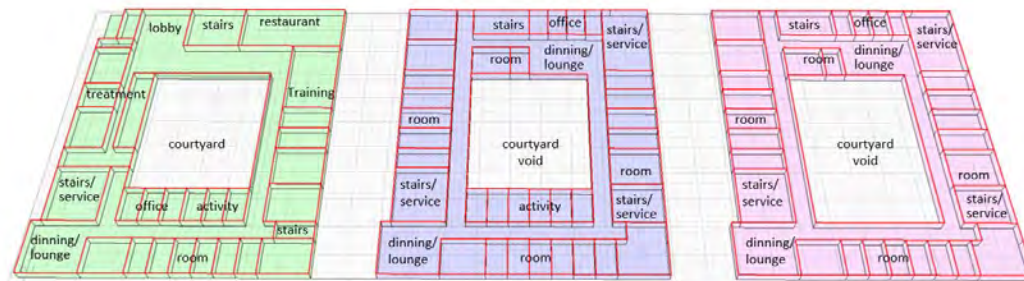

Figure 2: Typical care home design

3.3 Modelling frameworks

Building energy modeling is used to investigate the performance of the typical care home design. Heat Transfer in Buildings version 2 (HTB2), a dynamic building energy model developed at the Welsh School of Architecture since 1970s, has been used in this study. A series of extensive validation has been conducted, including the IEA Annex (Faber, 1980), IEA task 12 (Neymark et al., 2011) and the IEA BESTEST (IEA, 2006). Based on local climate data, building layout and construction details, shading masks, building services, and occupation profiles for people, equipment and lighting, HTB2 can simulate hourly and annual energy consumption and internal thermal conditions. In this study, the building services have been simplified by using an average efficiency and Coefficient of Performance (COP) for heating and cooling systems. The energy generated by PV systems has been calculated using an average PV efficiency.

3.3.1 Current practice

The main input data for current practice are based on the threshold of GB50189-2014 (Table 4). Various studies (Zapata-Lancaster and Tweed, 2014) have found that clients tend to comply to building regulation only.

Internal gains (W/m ²)		Ventilation		Fabric efficiency U-value (W/m ² /K)	
Rooms	Lighting	Plug load	Fresh air	External wall	0.50
Lobby	9.0	9.5	10L/s/person	Roof	0.45
Office	9.0	15.0	10L/s/person	Ground floor	0.50
Ward room	5.0	6.0	10L/s/person	Glazing	2.7
Exam/ treatment	15.0	30.0	10L/s/person		G=52%
Dinning/ lounge	6.9	3.0	10L/s/person	Systems	Boiler efficiency= 88% Cooling COP=3.2
Kitchen	15.9	50.0	30L/s/person		
Circulation area	7.0	0	10L/s/person		
Notes:					
<ul style="list-style-type: none"> • The building is used 7 days a week, 24 hours a day. • The designed room temperature used in the simulation is 21 (winter) to 26°C (summer). • The occupant's load is based on the design. • An infiltration rate at 10m³/h/m² @50Pa is applied, based on the minimum requirement of British Building Regulation Part L 2A. 					

Table 4: Simulation input data for current practice

3.3.2 Nearly zero-energy design

As mentioned in the introduction section, a systems approach integrating four design steps can maximize the energy saving.

First of all, energy efficient lighting systems and equipment should be used to reduce directly consume energy, as well as to decrease cooling load of air conditioning or ventilation systems by reducing heating gains during cooling season. An energy consumption labelling scheme has been developed in Europe to indicate the energy efficiency of appliances and lighting systems in terms of a set of energy efficiency classes from A+++ to G on the label (DEFRA, 2011).

Second, better efficiency of building fabric is required rather than fulfil the minimum requirements. New materials and technologies have entered the construction market, such as multi-layered glazing systems and structural insulated panel systems. For example, the benefits of a multi-layered glazing system with a lower U-value and a lower G-value are: 1) reduce annual heating and cooling consumption, 2) reduce peak loads to decrease capacity of service systems and 3) improve thermal comfort due to better internal glazing surface temperature.

Third, an all-air system can be suitable for care homes to improve indoor air quality, avoid the risk cause by high radiator surface temperature and lead to flexible furniture arrangement. Heating and cooling is provided through a Mechanical Ventilation and Heat Recovery (MVHR) system. It works by extracting heat from the outgoing air to warm incoming air in heating season via an air to air heat exchanger within the MVHR unit. The heat recovery rate of modern MVHR systems can reach 85%. In addition, a dark coloured Transpired Solar Collector (TSC) can be installed on the south and west facing wall in between windows on the upper floors. It is made of a layer of metal cladding with perforations, installed at several centimetres from a building wall to form a cavity (Croitoru et al., 2016). Figure 3 shows the working principles of a typical TSC. It can preheat the outdoor air supply prior to the MVHR in heating season, and the heated air in the cavity can be used to heat domestic hot water in cooling season.

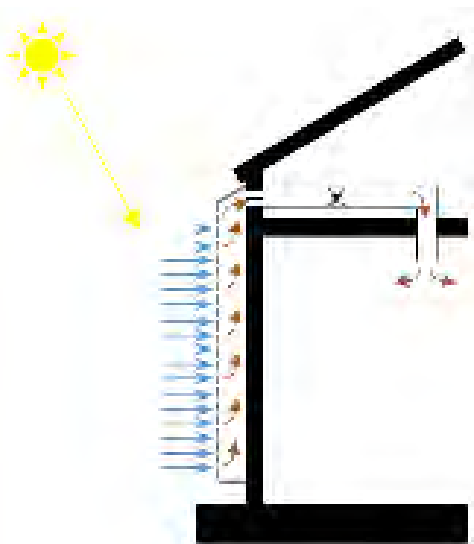

Figure 3: Transpired solar collector figure

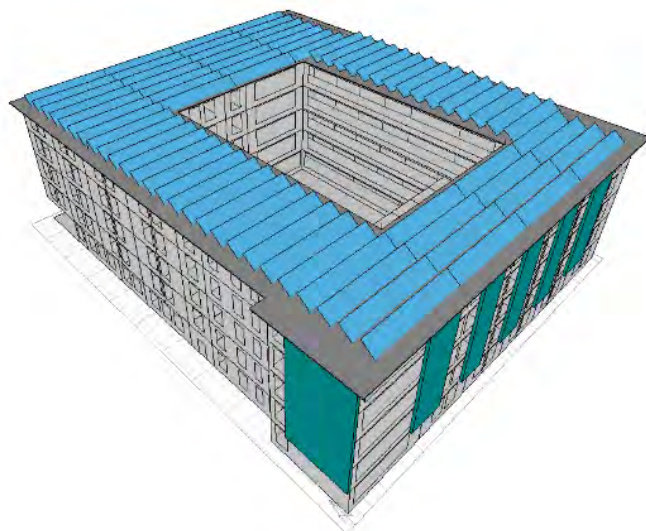

Figure 4: Near zero carbon care home design

Fourth, monocrystalline silicon PV panels (Mono-Si), which is currently the most efficient photovoltaic technology with the module efficiency of 17% can be installed on the roof to decarbonize the energy demand. If more energy generation than consumption, the PV system can be linked to a battery storage before connect it to the grid to reduce the pressure on the grid. Figure 4 shows the installation of PV panels on the roof (blue) and UTSC on the south and west facade from first floor to the top floor (green) on the typical care home building.

Data used in the building energy simulation for nearly zero-energy design is summarized in Table 5.

Internal gains (W/m ²)			Ventilation	Fabric efficiency U-value (W/m ² /K)	
Rooms	Lighting	Plug load	Fresh air	External wall	0.26*/0.15 [^]
Lobby	5.6	4.0*/1.5 [^]	10L/s/person	Roof	0.18*/0.15 [^]
Office	9.0	7.0*/3.0 [^]	10L/s/person	Ground floor	0.22*/0.15 [^]
Ward room	2.9	4.0*/2.0 [^]	10L/s/person	Glazing	1.60*/0.90 [^]
Exam/ treatment	11.6	20.0*/10.0 [^]	10L/s/person		G=40%*/15% [^]
Dinning/ lounge	4.6	2.0*/1.0 [^]	10L/s/person	Systems	
Kitchen	11.6	40.0*/30.0 [^]	30L/s/person	<ul style="list-style-type: none"> • UTSCs (221.8 m²) • MVHR at 85% efficiency • PV (1347.5m²), at 17% efficiency 	
Circulation area	4.6	0/0	10L/s/person		
Notes:					
<ul style="list-style-type: none"> • The lighting and plug load are based on the SIA 2024. • The occupant's load is the same as the current practice, based on the design. • The infiltration rate is (3m³/h/m² @50Pa) are based on the recipe data from the British Building Regulation Part L 2A. • * for good practice, ^ for best practice 					

Table 5: Simulation input data for nearly zero-energy design

This next section will present the simulation results for both current practice and step by step nearly zero-energy design cases.

4. RESULTS AND DISCUSSION

Table 6 shows the monthly heat balance and energy demand of the simulated cases, as well as summarizes annual energy consumption of heating, cooling and lighting equipment. The current practice is the base case with the minimum requirements for building fabric and LPD required by GB50189-2014 for cold zone. The simulation results show that the main heat gain throughout the year is incidental gains (including heat gains from occupants, lighting and equipment) and solar gain. The incidental gain is around 7kWh/m² every month, while the solar gain ranges from 3.4 to 6.2kWh/m² in winter and summer months. The main heat loss is through ventilation (including fresh air requirement and infiltration) and fabric. The ventilation loss ranges from 12.1 to 14.9kWh/m², while the fabric loss ranges from 8.8 to 10.9kWh/m² through winter months. Due to large heat losses from ventilation and fabric, heating will be required from October to February. In addition, cooling will be required from March to August. The total heating and cooling demand is 45.0kWh/m² and 41.5 kWh/m² respectively. The total energy consumption for heating, cooling and lighting equipment is 121.8kWh/m².

With energy efficient lighting and equipment, the incidental gain decreases, which leads to an increase in heating demand, and a reduction in cooling demand. The overall energy consumption for heating, cooling and lighting equipment will be reduced by 11.6% to 107.6kWh/m² for the good practice case, while by 16.6% to 101.6 kWh/m² for the best practice case.

With improved building fabric, the solar gain to the space decreases by one third and two thirds due to the reduction of g-values for the good and best practice cases respectively. The ventilation and fabric loss is reduced due to the improvement of the air tightness and u-values. The overall energy consumption for heating, cooling and lighting equipment will be reduced by 26.3% compared to the base case to 89.8kWh/m² for the good practice case, while by 34.4% to 79.9kWh/m² for the best practice case.

With the application of TSCs and a MVHR system, the overall energy consumption for heating, cooling and lighting equipment will be reduced by 57.7% compared to the base case, to 51.6kWh/m² for the good practice case, while by 67.8% to 39.2kWh/m² for the best practice case.

Cases	Monthly heat balance (kWh/m ²)	Monthly energy demand (kWh/m ²)	Annual energy consumption(kWh/m ²)	
Base case: current practice			Heating	51.1
			Cooling	13.0
			Lighting equipment	57.7
			Total	121.8
Step 1: Reduced energy demand (good)			Heating	57.9
			Cooling	10.6
			Lighting equipment	39.1
			Total	107.6
Step 1: Reduced energy demand (best)			Heating	61.2
			Cooling	9.7
			Lighting equipment	30.7
			Total	101.6
Step 2: Passive design (good)			Heating	40.4
			Cooling	10.3
			Lighting equipment	39.1
			Total	89.8
Step 2: Passive design (best)			Heating	42.2
			Cooling	7.0
			Lighting equipment	30.7
			Total	79.9
Step 3: Efficient HVAC systems (good)			Heating	1.7
			Cooling	10.9
			Lighting equipment	39.1
			Total	51.7
Step 3: Efficient HVAC systems (best)			Heating	0.6
			Cooling	7.9
			Lighting equipment	30.7
			Total	39.2

Table 6: Monthly heat balance and energy demand for current practice, and cases with reduced energy demand, passive design and efficient HVAC systems

Figure 5 shows the solar access of the roof PV panels. Simulation results suggest that monthly energy generated by the PV panels is not sufficient to supply the total energy consumption (Figure 6). The overall energy generated by the roof PV system is 19.4kWh/ floor area/ year, which can meet 37.5% and 49.5% of the reduced energy consumption of the good and best practice cases respectively. Although zero energy target has not been achieved, this systems approach can reduce the total energy consumption of heating, cooling and lighting equipment can be reduced by 73.5% and 83.7% the good and best practice cases respectively.

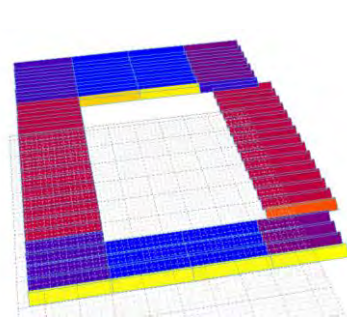

Figure 5: Solar access of the roof PV panels

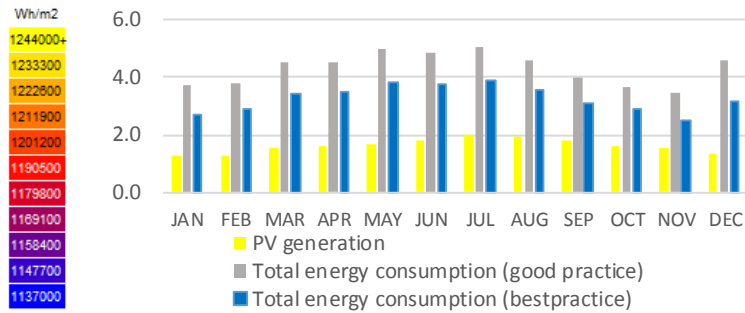

Figure 6: Monthly energy generation vs energy consumption (step 4)

5. CONCLUSION

The paper has introduced the application of a systems approach, combining reduced energy demand, passive design, efficient HVAC systems, and the use of renewable energy systems, to deliver a nearly zero-energy care home design in cold climate zone in China. The building energy simulations have investigated the energy performance of a standard care home building in Beijing in current condition, as well as with the application of the systems approach step by step. In addition, two levels of efficiencies for equipment and building fabric on the energy consumption have been explored. The simulation focuses on energy consumption of heating, cooling, lighting and equipment.

This study identified that the proposed systems approach can nearly eliminate the heating demand, while significantly reduce energy demand in cooling and lighting equipment. With good practice, the total energy consumption can be decrease to 42.3% of the current practice, while with the best practice, the total energy consumption can be reduced to 32.2% of the current practice. In relation to the current practice and availability of advanced technologies and materials, it is not necessary and unpractical to improve the efficiencies of lighting equipment and building fabric to the level of best practice. Practical efficiencies from the good practice can provide substantial energy saving. Furthermore, due to the ratio of roof to floor area, the roof PV system cannot fulfil the total energy consumption of the building, but there is the potential for using solar energy to meet most of the energy supply with the fast development of technologies in the near future. Under current circumstance, supply the remaining energy requirement with energy from grid generated with renewable sources can the option to achieve the zero carbon target.

REFERENCES

- [1] DEFRA 2011. The new EU energy label explained.
- [2] DENISON, E. & REN, G. Y. 2014. China's Concealed Crisis Architectural Design: Designing for the Third Age- Architecture Redefined for a Generation of "Active Agers", 228, 144.
- [3] FABER, O. A. P. 1980. IEA Annex 1 Computer Modelling of Building Performance: Results and Analyses of Avonbank Simulation. St Albans.
- [4] HONG, T., LI, C. & YAN, D. 2015. Updates to the China Design Standard for Energy Efficiency in public buildings. *Energy Policy*, 87, 187-198.
- [5] IEA 2006. Integrated Building Concepts State-of-the-Art Review Report.
- [6] JONES, P., HOU, S. S. & LI, X. 2015. Towards zero carbon design in offices: Integrating smart facades, ventilation, and surface heating and cooling. *Renewable Energy*, 69-76.
- [7] NEYMARK, J., JUDKOFF, R., ALEXANDER, D., FELSMANN, C., STRACHAN, P. & WIJSMAN, A. IEA BESTEST Multi-zone non-airflow in-depth diagnostic cases. 12th IBPSA, 2011 Sydney.
- [8] ZAPATA-LANCASTER, G. & TWEED, C. 2014. Designers' enactment of the policy intentions. An ethnographic study of the adoption of energy regulations in England and Wales, . . *Energy Policy*, 172, 129-139.

Preliminary Study on Natural Ventilation Efficiency in School Stadium by Different Opening Patterns

LI Yenyi^a, CHUNG Poren^b, LIN Hungchun^c, CHIU Fongyu^d, CHEN Chen-yu^e

^a ShuTe University / TSSBE (iISBE-Taiwan), Taiwan, hamaLee@gmail.com

^b Graduate School of Architecture, National ChengKung University, Taiwan, benjamin6686@gmail.com

^c ShuTe University / TSSBE (iISBE-Taiwan), Taiwan, nny97912000@gmail.com

^d Department of Information and Technology Education, Ministry of Education, Taiwan, fangppu@mail.moe.gov.tw

^e Department of Architecture, ChengKung University, Taiwan, Chenyu88@mail.ncku.edu.tw

ABSTRACT

The Ministry of education promoted the sustainable campus development and put into the transformation of the various objectives, in which the gymnasium ventilation type in primary schools usually adopt both natural ventilation and mechanical ventilation design. However due to architectural ontology design problems, the usage of indoor area and maintenance always caused bad indoor temperature and ventilation distribution problems.

This study is to investigate the influence of natural ventilation by different openings and type on the indoor flow in gymnasium, way of thinking about how to make use of natural phenomena, and indoor and outdoor temperature difference or outdoor wind pressure and so on to achieve ventilation, fresh outdoor air is introduced to solve the problem of the heat of the indoor temperature, to ensure the effect of indoor air quality. By reviewing the different opening positions in the gymnasium space, the principle of the natural wind is controlled by the size of the window, which is used to reduce the temperature in the room, and to increase the amount of ventilation. This study aimed at different window opening position, window opening type and window aperture size, as the research change, to collect the literature research on natural ventilation in hot humid climate regions at home and abroad, as a theoretical basis to study, Computational Fluid Dynamics is used to analyse the benefits of natural ventilation, to ensure the reliability and accuracy of the numerical simulation, the amount of the actual situation in the space simulation before test data, data results are compared with CFD numerical simulations, discussion on the effect of the subsequent analysis results on the natural ventilation, analysis and comparison of different ventilation types and specifications, finally unified whole research results, provide for follow-up research planning and project proposals with reference stadium ventilation.

Keywords: natural ventilation, indoor thermal environment, gymnasium, CFD numerical simulation

1. INTRODUCTION

The architectural design of Taiwanese campuses in the past focused on educational function and space rather than sustainable management. Since the campus is the main place where students spend most of their time during school days, the quality of the environment has constant effects on their health.

Based on the quality of air in current school gyms in Taiwan, this study aims to determine the ideal ventilation pattern for school gyms to correspond to the concept of sustainable health management. In general, an effective ventilation pattern can solve the issue of indoor heat with the effect of fresh air convection, enabling the outdoor fresh air to keep flowing to the inside of the building and the indoor hot air to keep ventilating outside, so that the heat and moisture indoors can be decreased, and the indoor air quality can be adjusted.

2. METHODOLOGY

With the adoption of Computational Fluid Dynamics (CFD) simulated and analyzed by computer, this study investigated the gyms in elementary schools to examine the correlation between the opening position of the air windows and the indoor air flow. To ensure the credibility and accuracy of the stimulation data, the in-situ measurement of the actual space condition was conducted prior to the simulation. The schools where the gyms were naturally ventilated were included as the subjects of the assessment.

2.1 Subjects selection

Through the Sustainable Campus and Smart Environment Construction and Efficiency Assessment Project in Taiwan, this study investigated in situ the schools across Taiwan that had been partially reconstructed and selected those which applied to reconstruct their gyms with natural ventilation design in vertical openings, to assess the efficiency of ventilation after the gym reconstruction. The information on the selected subjects is presented in Table 1.

Environmental data			
Regional mean temperature	Highest (July) 28.6°C, the lowest (January) 16.5 °C. on average 23.1°C		
Regional average sunshine	Summer June: 224.6 hours, winter December: 131.11 hours		
wind velocity	Average 2.3m/s	Perennial wind direction	Summer June: West to East Winter December: Northeast
Spatial content			
Build time	1997	Location orientation	East and west direction
Space area	894 m ²	Window and door type	East: no window
Use floor	1 floor		North and South: fixed windows and shutters
Building High	11m		West to: no window
Space height	8m		East and West glass door
Space use	Indoor stadium, auditorium	Ventilation type	Natural ventilation

Table 1: Information of selected subjects

2.2 Relevant variable setting for CFD spatial unit simulation

The unit dimensions of the simulation model in this study were length 40 m, width 20 m, height 8 m, and total area 800 m². Considering that there is usually a stage in a school gym since it is sometimes used as an auditorium, the dimensions of the opening were set as the type of single opening for the spatial unit simulation in this study, shown as Figure 2.

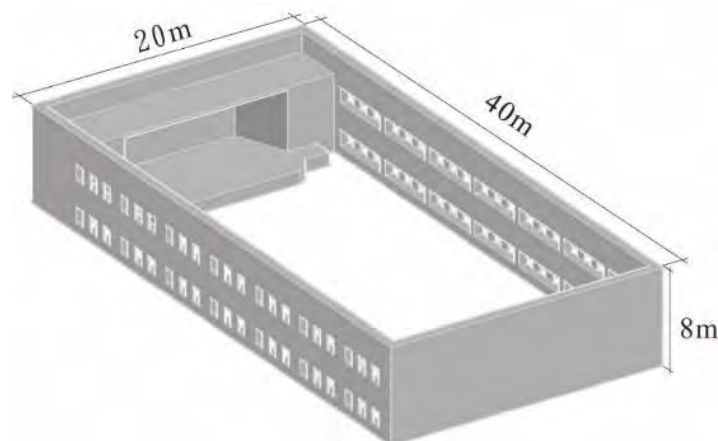

Figure 2: Model of spatial unit simulation

2.3 Opening type setting

The natural lighting surface of the simulation model in this study was 40m in length, and the net width between pillars was 450cm; therefore, the width of the window opening was 150cm. Given the different depths of the pillars on the edge of the building, the dimensions of the air windows are hard to unify; thus, it was unnecessary to modularize the dimensions of the air windows.

The subjects in this study were the elementary schools in Kaohsiung City; 34 of them have a gym on campus. After examining the types of gym openings, the results indicated that 32.4% of them belonged to Type 1, 5.9%

belonged to Type 2, 5.9% belonged to Type 3, 14.7% belonged to Type 4, 11.8% belonged to Type 5, 2.9% belonged to Type 6, 5.9% belonged to Type 7 and 20.6% belonged to Type 8. According to the eight main types of opening, the author of this study arranged the specifications and listed the information in Table 2.









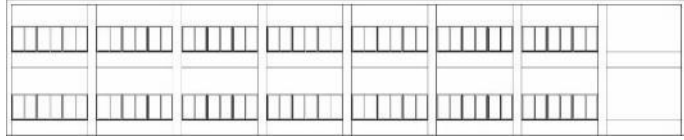

Type 1		Ventilation Path
		
Description	Normal windows on both the top and bottom layers.	
Type 2		Ventilation Path
		
Description	Normal windows only on the bottom layer.	
Type 3		Ventilation Path
		
Description	Normal windows only on the top layer.	
Type 4		Ventilation Path
		
Description	French windows on both the top and bottom layers.	
Type 5		Ventilation Path
		
Description	French windows only on the bottom layer.	

Table 2: The eight main types of gym opening

3. RESULTS AND ANALYSIS OF CFD DATA SIMULATION

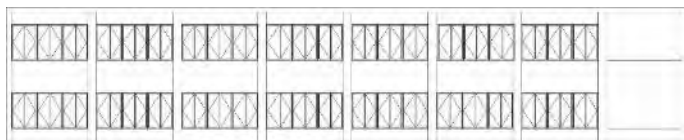
The percentage of average temperature and the assessment factors of indoor wind speed amenity were used respectively to discuss the influences of the sizes of one-layer or two-layer windows upon the indoor thermal and airflow environment. The items of the assessment include: analysis on the distribution of airflow fields and average temperatures, as well as assessment of the amenities and advantages/ disadvantages of different types of window openings.

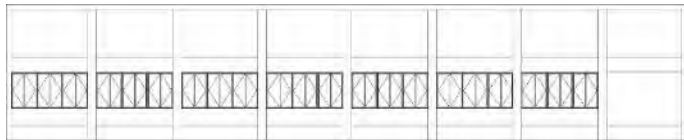
3.1 Influence of one-layer windows on indoor natural ventilation of gyms

Comparing the average temperatures of Type 2, Type 3, Type 5 and Type 6, the results show that among the types of one-layer windows, French windows, whether on the top or the bottom, have a better performance concerning the thermal environment than normal windows do. Type 5, the one with French windows on the bottom layer, has the best performance. The results of average indoor temperature comparison are as follows: in Type 2, when opening normal windows on the bottom layer, the average indoor temperature is 30.3°C; in Type 3, when opening normal windows on the top layer, the average indoor temperature is 0.1°C lower than Type 2, equivalent to a 0.3% decrease; in Type 6, when opening French windows on the top layer, the average indoor temperature is 0.5°C lower than Type 2, equivalent to a 1.5% decrease; in Type 5, when opening French windows on the bottom layer, the average indoor temperature is 0.7°C lower than Type 2, equivalent to a 2.3% decrease. Figure 3 present the percentage comparisons of average temperature between one-layer normal windows and French windows.

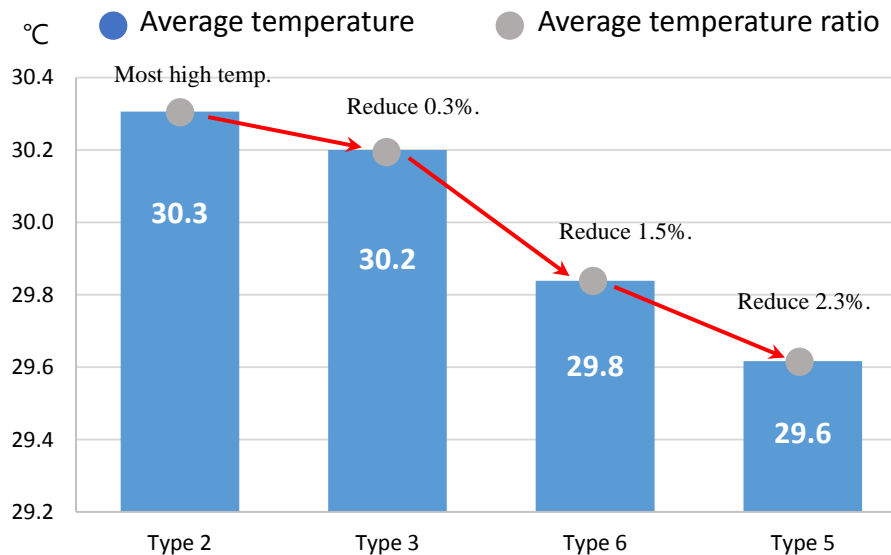

Figure 3: Model of spatial unit simulation

The data on the assessment of the indoor wind speed amenity is shown in Figure 4. The average wind speed values in Type 2, Type 3, Type 5 and Type 6 comply with the acceptable range of average wind speed amenity for indoor environment as defined in this study. To find the better influence pattern of indoor wind speed amenity in gyms, the author also examined the wind speed magnification to observe which of size windows has stronger influence on the indoor flow field inside the gym; the results show that larger windows have better performance on the speed of flow field.

In Type 3, when opening normal windows on the top layer, the average indoor wind speed is 0.13 m/s. In Type 6, when opening French windows on the top layer, the average indoor wind speed is 0.03 m/s higher than Type 3, equivalent to an increase of 1.3 times. In Type 2, when opening normal windows on the bottom layer, the average indoor wind speed is 0.19 m/s higher than Type 3, equivalent to an increase of 2.5 times. In Type 5, when opening French windows on the bottom layer, the average indoor wind speed is 0.26 m/s higher than Type 3, equivalent to a three-fold increase.

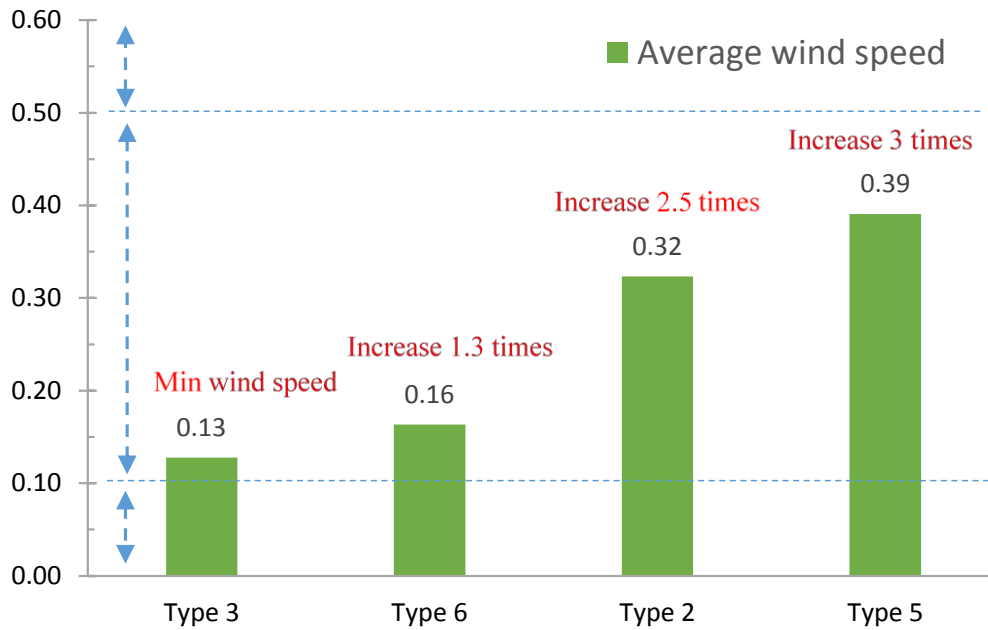

Figure 4: Comparisons of average indoor wind speed amenities among the types of one-layer windows

3.2 Influence of two-layer windows on indoor natural ventilation of gyms

Comparing the average temperature among Type 1, Type 4, Type 7 and Type 8, the results show that the two-layer windows, whether belonging to normal windows or French windows, have better performance on the thermal environment when both the windows on the top and the bottom layers are open. Two-layer windows effectively facilitate the airflow field through the effect of thermal buoyancy, and exchange the indoor airflow with the one outside through the effect of cross ventilation, thereby reducing the sultriness inside the gym. The results of average indoor temperature comparison are as follows: in Type 1, when normal windows are open both on the top and bottom, the average indoor temperature is 29.3°C; in Type 7, when French windows on the top and normal windows on the bottom are open, the average indoor temperature is 0.1°C lower than Type 1, equivalent to a decrease of 0.3%; in Type 4, when French windows are open both on the top and bottom, the average indoor temperature is 0.2°C lower than Type 1, equivalent to a decrease of 0.7%; and in Type 8, when normal windows on the top and French windows on the bottom are open, the average indoor temperature is 0.2°C lower than Type 1, equivalent to a decrease of 0.7%. Figure 5 presents the percentage comparisons of average temperature between two-layer normal windows and French windows.

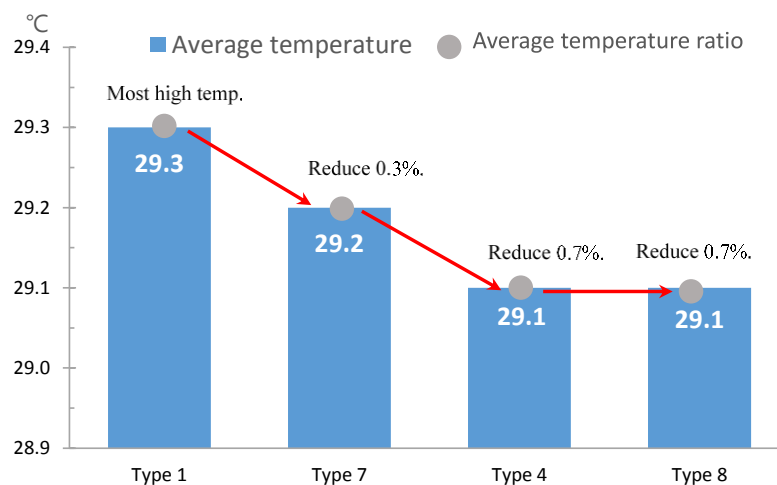

Figure 5: Comparison of average temperature of two-layer windows

The data on the assessment of the indoor wind speed amenity is shown in Figure 6. The average wind speed values in Type 1, Type 4, Type 7 and Type 8 comply with the acceptable range of average wind speed amenity for indoor environment as defined in this study. The author further assessed the other aspect of indoor wind speed amenity in gyms by comparing the wind speed magnification of the above mentioned Types to observe which size of windows has a stronger influence on the indoor flow field inside of the gym; the results show that all the Types of two-layer windows, whether French windows or normal windows, have fine performance on the speed of flow field when they are open.

In Type 7, when French windows on the top and normal windows on the bottom are open, the average indoor wind speed is 0.34 m/s. In Type 4, when French windows on both the top and the bottom are open, the average indoor wind speed is equal to Type 7, 0.34 m/s. In Type 1, when normal windows on both the top and the bottom are open, the average indoor wind speed is 0.01 m/s higher than Type 7, equivalent to an increase by 0.04 times. In Type 8, when normal windows on the top and French windows on the bottom are open, the average indoor wind speed is 0.03 m/s higher than Type 7, equivalent to an increase by 0.1 times.

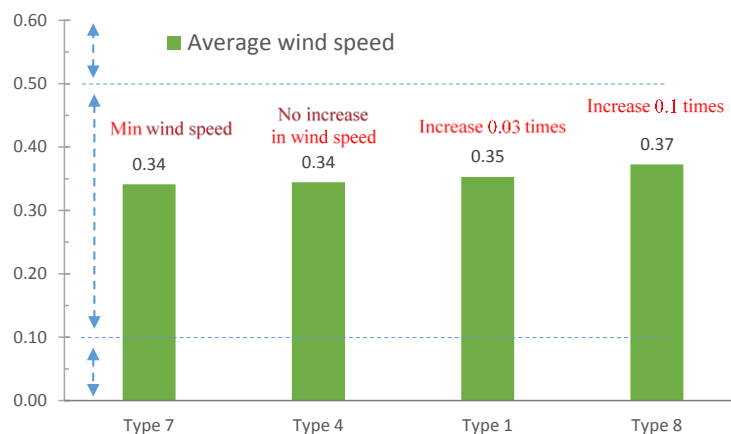

Figure 6: Comparison of average indoor wind speed amenities among the types of two-layer windows

4. CONCLUSION

4.1 Results of influence of one-layer window opening on indoor natural ventilation in gyms

According to the assessment results regarding the amenities of indoor wind speed and thermal environment, the ventilation performance of thermal buoyancy and wind action improves as the indoor heat source increases. When the deviation of the inlet wind speed is bigger, the airflow will facilitate more obvious improvement on the ventilation effect. In addition, the position of window opening can influence the speed of the indoor flow field. The author discovered that the bottom layer window openings in the gym cause a significantly greater speed of flow field than those on the top, and that bigger windows result in a better indoor thermal environment. After simulation, the study found that Type 5 has better performance on the speed of flow field and indoor thermal environment.

4.2 Results of influence of two-layer window opening on indoor natural ventilation in gyms

Two-layer windows effectively facilitate the airflow field through the effect of thermal buoyancy, and exchange the indoor airflow with the one outside through the effect of cross ventilation, thereby lowering the sultriness inside the gym. According to the assessment results regarding the amenities of indoor wind speed and thermal environment, the percentages of average indoor temperature indicate that opening the windows both on the top and the bottom **can achieve the optimum performance regarding the gym's indoor thermal environment.** Two-layer window pattern combines with thermal buoyancy and cross ventilation in the concept of natural ventilation for buildings, making the thermal environment correspond to the level of human comfort. Moreover, the dimensions of the two-layer windows have no significant correlation between the average indoor temperatures. In other words, whether using normal windows or French windows, two-layer windows have fine performance regarding the speed of flow field and thermal environment. Consequently, for the weather conditions in Taiwan, when adopting natural ventilation to improve the quality of indoor environment, the thermal buoyancy and wind action should be included in the consideration to improve the airflow circulation and efficiency.

REFERENCES

- [1] P.C. Wu*, Y.Y. Li, C.C. Lee, C.M. Chiang, H.J. Su. 2003 • Risk Assessment of Formaldehyde at Typical Office Buildings in Taiwan, "Indoor Air" Vol.13,No.4, pp.359-363.
- [2] Yen-Yi Li*, Chu-Yun Huang, Huey-Jen Su, Che-Ming Chiang, 2004 , Variation of Indoor air Pollution Associated with Ventilation Systems in Two Seasons, "Journal of Architecture" Vol.46, pp.81-102.
- [3] YIN Zhi-xiang, LI Jun, ZHANG Shuang. 2015 Numerical study on Mutual Interference of Wind Loading on Stadium Buildings. "Engineering Mechanics".
- [4] C.M. Chiang, P.C. Chou, C.M. Lai, Y.Y. Li, 2001, A methodology to assess the indoor environment in care centers for senior citizens. "Building and Environment", Vol.36, pp. 561-568

Quantifying and Improving Environmental and Human Sustainability in Remote: Region Health Clinics, Australia

Steve BURROUGHS^a

^a University of Canberra, Australia, drsteve@drsteveburroughs.com.au

ABSTRACT

A sustainable building must address environmental sustainability aspects (E.g., energy use) as well as human sustainability (The well-being and productivity of its occupants). Climatic and socioeconomic conditions in remote regions of Australia mean that achieving such sustainability is challenging and costly, much more so than in urban areas. The standard industry response has been an increased reliance on the use of mechanical heating–cooling systems rather than passive design strategies aimed at reducing energy use and improving indoor environmental quality (IEQ) to maintain human well-being and productivity. These methods have come with a significant energy cost and pressure on the power supply system due to high peak loads. This trend is unsustainable as climate projections for remote regions indicate a continuing rise in the number of hot days in summer and cool nights in winter, increasing the demand for energy and associated infrastructure. The performance of health clinics in remote communities with respect to energy use and IEQ is unknown, meaning that these variables cannot be matched to the prevailing climatic conditions. This paper reports the establishment of a research project aimed at quantifying the environmental and human sustainability of remote-region health clinics, based on which strategic interventions and design modifications can be made. In the research, variables related to climate, energy consumption, and IEQ will be measured and monitored for eight clinics in different climatic zones. This will allow the levels and patterns of climatic variables, energy use, and IEQ, and the relationships between them, to be quantified. The findings will be used to inform best practices for improving the energy-use efficiency and IEQ of existing remote-region health clinics as well as informing design solutions for future buildings to optimize sustainability with respect to climate, environmental performance, and occupant well-being.

Keywords: remote health clinics, energy performance, human sustainability

1. INTRODUCTION AND BACKGROUND

Sustainable building practices have made significant advances in the last two decades (Kibert, 2016). However, a truly sustainable building addresses not only environmental impacts but also human sustainability and well-being. Environmental sustainability is the ability to maintain the qualities of the natural environment, including the processes involved in producing energy, as well as the impact of buildings and human activity on the environment. Human sustainability is in large part related to the quality of the built environment and involves specific strategies and methods implemented to enhancing the well-being and productivity of building occupants/ users (E.g., Yang et al., 2014).

Remote parts of Australia are defined based on the physical road distance to the nearest town or service centre. **The officially defined “Remote Australia” covers 86% of the area of the entire country. In the 2006 census (Statistics Australia, 2006), Remote Australia was home to 470,000 people, including 2.5% of the Australian population overall, but 24% of Australia’s Aboriginal and Torres Strait Islander population. The characteristics of Remote Australia** differ from other parts of Australia, and these remote regions have common systemic properties as well as a history of persistent social and economic disadvantage manifest in poor health statistics and weak infrastructure. These systemic, remote-region characteristics when interfaced with changing climate and different energy futures result in impacts, vulnerabilities, and opportunities that differ from those that apply to coastal and urban regions of Australia (Maru et al., 2012). There are particular challenges faced by remote-region buildings and their occupants with respect to environmental and human sustainability compared with urban areas in Australia. These include generally harsher climates with greater temperature extremes and much higher electricity costs (\$5/ kWh versus \$0.2/ kWh).

Remote Australia is served by a network of health clinics and associated staff. These clinics provide a wide range of health services to local populations as well as training medical students and registrars. These healthcare facilities provide care for some of the most vulnerable members of Australian society. Hospitals and clinics serve

the needs of those who are ill or recovering, and need to generate conditions that are conducive to treatment and recovery by mitigating the spread of disease and improving occupant comfort, as well as allowing staff to work productively. Indoor environmental quality (IEQ) provides a critical foundation for meeting this target. However, it is an unfortunate fact that strategies to enhance human health and well-being have played a rather minimal role in the evolution of building standards and practices in remote communities. Further, there is a continuing imperative to reduce the environmental impact of buildings, particularly with respect to energy use, as well as to reduce operational costs. Therefore, it is imperative that human health and productivity, as well as environmental quality, take centre stage in building design, function, and operation so that buildings can perform better for both people and the environment. This can be achieved through a dedicated focus on evidence-based research and measurable performance of sustainability metrics.

The present paper reports a new project investigating the environmental efficiency and human sustainability of health clinics in remote regions of Australia. The project has been defined and is now in the initial stage of execution, with monitoring devices having been installed in one of eight selected clinics as of November 2016. Therefore, the purpose of the paper is to report the rationale for and development of the project, the methodology, and the anticipated outcomes. The project has been commissioned by the Department of Health (DoH) in Australia and is the first of its type in the country. The author is the Principal Investigator of the research team engaged in the research project. The results and findings of the research will provide an important baseline for measuring remote health clinic sustainability.

2. CLIMATE, HUMAN SUSTAINABILITY, AND ENVIRONMENTAL SUSTAINABILITY

Climatic conditions in the remote regions of Australia are acknowledged to be harsh, characterized, for example, by extreme temperatures, wide temperature variation, and high seasonal variation in rainfall. Such conditions pose difficulties for achieving environmentally efficient buildings (E.g., Isaacs, 2006) and for establishing high levels of IEQ for sustaining human comfort and well-being. These challenges are likely to become greater, given projections of climate change and energy requirements, as discussed below.

2.1 Climate

Since 1910, the Australian average annual temperature has increased by 1°C, with most of this warming occurring since 1950. Furthermore, it is likely that average annual temperatures will continue to increase in the near future, and by 2030, temperatures are expected to rise by up to 1.8°C in some inland regions (Maru et al., 2012). There is a high level of uncertainty in the trend of projected rainfall, particularly in inland and northern Australia. Rainfall is likely to decrease in southern areas of Australia, especially in winter, and in southern and eastern areas in spring caused by the contraction in the rainfall belt towards higher latitudes (IPCC, 2007). Increases in evaporation are likely throughout Australia, which, combined with a general decline in precipitation in many parts, provides a strong indication that the Australian environment is generally becoming drier under enhanced greenhouse conditions (Frederiksen et al., 2011).

2.2 Energy needs and costs

Remote Australia is still highly dependent on fossil fuels for transport and for household and public service energy needs. For example, over 31 million litres of diesel fuel were used to generate electricity for major remote communities in NT in 2009, and demand was expected to increase by 25% over the subsequent three years (Maru et al., 2012). Household consumption of energy is rising, and the use of air-conditioning will increase with increasing temperatures in inland Australia, which will lead to even higher demand for energy to maintain current lifestyles and to address the changing requirements of an ageing population. Energy prices are likely to continue to rise as the cost of production of fossil fuel increases, and gas utilities (Which generate electricity using fossil fuels, including natural gas) will be obliged to purchase emissions permits under the Clean Energy Act 2011.

The cost of renewable energy sources affects uptake in Remote Australia. Barriers include pricing, perceptions, relatively immature technology, and the distance between energy sources and markets (Ellis and Peake, 1996; Harrison et al., 1996; Lloyd, 2001; Marinova and Balaguer, 2009). There are high costs of infrastructural development and maintenance associated with remote locations, and immediate economic returns on such

investments are rare. Areas with small populations are often unable to justify upfront and maintenance costs for renewable energy systems (McHenry, 2009).

3. RESEARCH OBJECTIVES AND METHODOLOGY

3.1 Research objectives

Climatic conditions impact significantly on a building's ability to provide the necessary conditions for occupant well-being as well as on its environmental efficiency, particularly its energy consumption. Climatic conditions have changed significantly over the last century, and predictions indicate that changes will continue to occur in the near and mid-term futures. In this respect, it should be noted that many existing DoH health clinics in Remote Australia are performing in climatic conditions that now differ from those applying when they were designed and built. Therefore, it is important that climatic and building performance data be available not only to assist in measuring and managing energy use and IEQ in existing health clinics, but also provide a base upon which future clinics can be planned, designed, constructed, and operated. Currently, DoH has no data regarding environmental sustainability (as measured through energy use) and human sustainability (As measured through IEQ) for its remote health clinics. Such data, when combined with climatic data, should be a valuable tool for developing strategic interventions in existing buildings and for indicating sustainable design solutions in new buildings.

This research involves the collection and analysis of data on the characteristics, occupant response, and environmental performance of DoH health clinics in regional/ remote areas with respect to environmental and human sustainability. The relevant metrics include those related to enhancing human well-being and productivity in remote clinics, as well as the energy consumed to sustain the functions and occupants of the buildings in a bid to maximize environmental efficiencies. As the first project of its kind, the research has the following objectives:

- To generate a baseline database of environmental sustainability and human well-being performance indicators and corresponding measurements for remote-region health clinics in Australia;
- To develop a body of knowledge based on the monitoring and measurement of environmental and human sustainability that will inform decision-making and strategic interventions in remote-region health clinics in Australia; and
- To provide an initial understanding of the key sustainable design and operational aspects when designing, operating, and maintaining remote-region health clinics in Australia.

The findings of the research should be able to be applied to increase, improve, or enhance the following DoH assets and areas of interest: (i) The environmental sustainability and IEQ of its remote-region health clinics; (ii) the well-being and productivity of its staff working in these areas; and (iii) the recovery and well-being of the local populations cared for in the clinics.

3.2 Methodology

This investigation uses a mixed-methods approach to obtain complementary results and evaluations offered by qualitative and quantitative methods. Research in Phase 1 of the project will use qualitative methods including site description, documentation analysis, and a questionnaire survey of building occupants (Medical staff). This will establish data about the current conditions and performance of existing clinic buildings, and how staff operate within them, including issues and constraints.

Phase 2 uses a more quantitative approach, with monitoring instrumentation being installed to continuously measure in-building energy, environmental, and IEQ data, including energy use, temperature, and air quality, as well as climatic data, for a 12-month period. The monitoring instruments will upload data continuously to a cloud-based system that is able to be entered via a portal online. Each clinic will be assessed across key sustainability metrics as described below, establishing a 12-month period of data that will demonstrate how the clinics operate. This will allow DoH to be able to define **what "normal" is for a wide range of metrics as well as the variation.** In addition, site-assessed IEQ variables will be measured and occupancy profiles established. These data will allow a range of indicators to be defined for the selected buildings.

The following data and information will be collected during the project:

- Monitored climatic variables over a 12-month period, including temperature, humidity, wind speed, and rainfall.
- Monitored IEQ metrics over a 12-month period, including volatile organic carbon concentrations, air speed/flow, humidity, temperature, CO₂, CO, formaldehyde, amongst other gases and substances.
- Site-assessed IEQ variables including lighting levels, air exchange, ambient sound levels, particulate matter, and airborne microbials.
- An occupant satisfaction questionnaire will be conducted to augment the quantitative IEQ data and will seek information on aspects of IEQ, comfort, and human sustainability and productivity. The questionnaire will cover occupational profile, time–location data, time–activity data, building layout and furnishings, thermal comfort, air quality, lighting, acoustics, privacy and security, programmed spaces, energy-use patterns, and building sustainability features.
- Monitored energy consumption over a 12-month period, including totals and readings sub-monitored according to function and space within each clinic.
- Energy supply quality and variations over a 12-month period, including power outages (Brown- or black-outs), power supply (Grid, solar, other), and back-up.
- Building occupancy and operational profiles and variations over a 12-month period.
- An inventory of energy-consuming equipment in each clinic.
- Static built environment variables – building design and material characteristics, such as orientation, room layout, material types and properties, passive sustainability features, air systems and ventilation, and insulation.

This research will measure data for remote clinics over a period of 12 months at selected sites in different geographical regions in Australia. The sites for investigation will be based on selecting a range of clinics with respect to differing climatic conditions, building characteristics, and occupancy profiles. Identified sites will cover differing climatic conditions, including at the long-term, seasonal, and diurnal scales, so that the range of environmental constraints on variables such as energy use and IEQ can be considered. This will allow a more accurate characterization to be established of the variation in environmental and human sustainability aspects of remote clinics.

It is considered that eight sites are needed to cover the variation in climate and in other variables of interest such as occupancy and operational profiles, building characteristics, and IEQ variations. Currently, the first site has been identified, at Wanarn in Western Australia (Figure 1 and 2), whose health clinic was built in 2015. The health clinic has 18 rooms in total (For diagnosis, treatment, storage, and other purposes) and a floor area of around 230 m², and serves a population of around 2000 people in Wanarn and the surrounding area. Wanarn has a long-term average maximum temperature of 27.5°C and a mean monthly rainfall of 10–45 mm. Monitoring equipment has now been installed at the Wanarn clinic, and data collection and data portal establishment started in December 2016. Initial results for this clinic are expected to be available during the first and second quarters of 2017. Subsequently, during 2017 and 2018, further clinic locations in remote communities will be identified for investigation in the Northern Territory, South Australia, and Queensland.

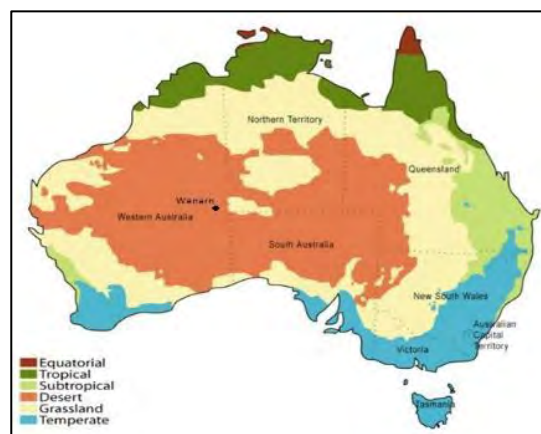

Figure 1: Political states and climatic zones of Australia, and the location of Wanarn. Remote Australia includes the equatorial, tropical, desert, and grassland zones



Figure 2: The Wanam health clinic

3.3 Data analysis

Temporal variations in the monitored quantitative data will be analyzed, including at the diurnal and seasonal scales. This will indicate changing levels of building performance at various temporal scales, and highlight possible problems such as periods of inefficient energy use or of undesirably low IEQ. Quantified correlations between energy-use values, climate variables, staff well-being, and IEQ metrics will establish the relationships between these data, thereby highlighting where and/ or when interventions could be made to optimize the building systems. Site variables measuring occupancy, building design, and building operation and their relationship to the monitored data and survey results will allow additional inferences to be made regarding the levels of, and factors influencing, human and environmental sustainability, thereby suggesting scope for design adaptation and strategic interventions. Building information modelling (BIM) will be used with building energy modelling (BEM) to help explore the relationship between performance and design and to test and identify design improvements using the obtained data

Part of the data analysis effort will be aimed at energy load reduction, followed by the application of energy-efficient solutions to match reduced load profiles. Some emphasis will be placed on designing the building skin to minimise external loads. The data collected will be used as a baseline for energy modelling of different orientations for several Australian climatic zones. Hourly data profiles will demonstrate times and places where loads exceed the established threshold for building heating, ventilation, and air-conditioning (HVAC) systems. BIM/ BEM simulations will also be used to provide load profiles. For example, such modelling can indicate how long exterior shades would need to be deployed in order to minimise external energy gains. This information will enable a design path to be established for generating improved thermal performance and human comfort using mechanical and/ or passive systems.

4. ANTICIPATED OUTCOMES

The anticipated outcomes of the research include the following:

- Generate data that will allow sustainability gaps in existing remote clinics to be identified and solutions to be developed.
- Generate data that will assist in evaluating and prioritising the implementation of new strategies and techniques for achieving energy efficiency.
- Identify the levels of IEQ in remote clinics and develop cost-effective strategies for enhancing these levels.
- Generate results to form a basis for management and decision-making regarding staff well-being and human/ clinic productivity.
- Enhance the energy optimization of building features such as plug loads, lighting, and HVAC systems to reduce energy costs without compromising occupant well-being and productivity.

- Provide workable and reliable data that will inform and guide the planning, design, construction, operation, and maintenance of sustainable clinics in remote regions.
- Establish foundation metrics (Key performance indicators – KPIs) for future use, for benchmarking, and for measuring improvements.
- Guide and set performance standards for energy use and IEQ on a wider basis for health clinics, based on the measured data.
- Identify the utility of the environmental and IEQ data as inputs into evidence-based design via BIM software for generating new clinic concept designs for different climatic zones and occupancy/ operational profiles.

The anticipated scope of the recommendations covers the following:

- Identification of the KPIs that best demonstrate the performance of health clinics and the design and construction of these facilities.
- The use of these KPIs as a basis for strategic interventions in the design, construction, operation, maintenance, and improvement of health clinics.
- Strategic planning to assist in setting priorities focusing on energy reduction and human sustainability and in the design and construction of medical clinics.
- Examination of cost-related issues in the final design of clinics.

REFERENCES

- [1] Ellis, J., and Peake, S. (1996). Renewable energy promotion in IEA countries. *Renewable energy*, 9(1), 1175–1178.
- [2] Frederiksen, C., Frederiksen, J., Sisson, J. M., and Lee Osbrough, S. (2011). Australian winter circulation and rainfall changes and projections. *International Journal of Climate Change Strategies and Management*, 3(2), 170–188.
- [3] Harrison, D., Ho, G., and Mathew, K. (1996). Renewable energy in the outback of Australia. *Renewable energy*, 9(1), 776–780.
- [4] IPCC. (2007). The physical science basis IPCC Fourth Assessment Report: IPCC.
- [5] Isaacs, T. (2006) Evaluation of AccuRate simulations of various design strategies to improve house thermal performance in Darwin and Alice Springs, prepared for the Northern Territory Department of Planning and Infrastructure, Darwin.
- [6] Kibert, C. J. (2016). *Sustainable construction: green building design and delivery*. John Wiley & Sons.
- [7] Lloyd, C. (2001). Renewable energy options for hot water systems in remote areas. *Renewable energy*, 22(1), 335–343.
- [8] Marinova, D., and Balaguer, A. (2009). Transformation in the photovoltaics industry in Australia, Germany and Japan: Comparison of actors, knowledge, institutions and markets. *Renewable energy*, 34(2), 461–464.
- [9] Maru, Y. T., Chewings, V., and Sparrow, A. (2012). Climate change adaptation, energy futures and carbon economies in remote Australia: a review of the current literature, research and policy. CRC-REP Working Paper CW005. (Ninti One Limited: Alice Springs, NT.).
- [10] McHenry, M. P. (2009). Remote area power supply system technologies in Western Australia: New developments in 30 years of slow progress. *Renewable energy*, 34(5), 1348–1353.
- [11] Statistics Australia (2006). Population Distribution, Aboriginal and Torres Strait Islander Australians. ABo Statistics.
- [12] Yang, L., Yan, H., & Lam, J. C. (2014). Thermal comfort and building energy consumption implications—a review. *Applied Energy*, 115, 164–173.

Soaring of Urbanization: Optimized Approaches through Adaptive and Sustainable Masterplanning

Antony HO^a, Rebecca KWAN^b, Kevin WAN^c, Vincent CHENG^d

^a Arup, Hong Kong SAR, antony.ho@arup.com

^b Arup, Hong Kong SAR, rebecca.kwan@arup.com

^c Arup, Hong Kong SAR, kevin.wan@arup.com

^d Arup, Hong Kong SAR, vincent.cheng@arup.com

ABSTRACT

Urbanization is an undeniable trend in modern world. By 2030, count of Mega-cities, residing more than 10 million people, is projected to leap by nearly 50% worldwide. More than half of current world population lives in urban areas and it is estimated to soar to 66% by 2050. Nearly 90% of the projected increase would be happening in Asia and Africa, concentrating in developing countries.

Rising concern requires balanced attention on sustainability, environmental and economical opportunity. In addition, the expanding and crowding urban context demand innovative and manageable solutions to address issues on housing, transportation, utilities, and other developmental priorities.

Sustainable planning on neighbourhood is to allocate socially vibrant, ecologically restorative and economically sound communities with integration of sustainable strategies and balance of Social, Environmental and Economic benefits. Successful cases become distinct fusion of balanced neighbourhood of people and environment, as well as laying sound foundation on reducing carbon footprint and associated environmental impacts in now and future. It is the most critical and cost-effective to address all sustainability issues at master-planning stage.

Adaptive and sustainable masterplanning provides tools to address these concerns and materials innovative solutions. Sustainable planning strategies are deployed to set-pace for a pleasant neighbourhood/district with prioritized endeavours on various aspects. Adaptive analyses are exercised to design practical and approachable solutions, which optimize sustainability and environmental performance. Inspiring ideas and innovative products create new dimension to tackle environmental and microclimatic issues.

Extensive experience in master-planning for sustainable neighbourhood, green building design, and conducting performance evaluation and carbon footprint evaluation has been successfully practised throughout the world, including USA, Asia, Mainland China, Hong Kong, Vietnam, etc. The authors have developed a systematic approach to address all global and local sustainability issues and develop an integrated sustainable solution, which benefit the Communities, Users and Developers.

Keywords: sustainable masterplanning, adaptive analyses, optimization & approach

1. INTRODUCTION

In year 2015, probably every people on Earth should have noticed the effect of Climate Change. It was one of the warmest years in record, with at least anomaly of 0.90C or 1.62OF above annual average temperature, since 1880 (NOAA 2015). Climate change has been widely studied with evidences linking to various intensifying human activities, the leading one of those is Urbanization (Kalnay and Cai, 2003; Argüeso et al, 2014, Zhou et al, 2004).

1.1 Urbanization

World population is on track of continuous growth and urbanization has been growing in accelerated pace in recent decade. By year 2050, world population is projected as over 9.5 billion, out of which 70% will be living in urban areas, almost doubling the urban population 3.4 billion back in year 2009. This translates into addition of 2.5 billion urban occupants in absolute numbers (United Nations, 2014). Out of steep climb, more than 60% of the growth will be anticipated on Asian soil and close to 90 per cent of the total increase is forecasted altogether with Africa region.

In Asia, the percentage of urban population was around 16% in 1950, increased to 40% at present, and is projected to be 65% by 2050, making a progressive increase at a rate of 1% to 5% annually. Japan, Korea, Hong Kong, Singapore and Taiwan are leading developed economies in the region, and having high population portion of urban occupants, ranging from 82% (Korea), 93% (Japan), to 100% (Hong Kong and Singapore) currently (Cheng & Tong, in press 2017).

Most of the South East or South Asian countries are developing countries. Their population are climbing rapidly. Indonesia and the Philippines are about 50% urbanized, with projection up to 65%, whereas Thailand and Vietnam are estimated to rise from current ratio of 30 – 40% to 55% when reaching year 2050.

More and more infrastructure, buildings for housing and social supporting facilities such as schools and hospitals need to be in place to support the urban living. Moreover, mobility and transportation are associated issues, which would deepen complications on the situations. Without proper planning and governance in place, this could lead to social instability and many environmental problems.

1.2 What are anticipated?

Consuming society

Resources of the Earth is no doubt limited. Carry capacity to accommodate a rapidly growing population, which is **moving towards “urban consumerism” would result in only unpleasant outcome on over-consumption on natural resources, forest, grassland, fisheries, energy fuels, etc.**

East Asia economic development has outperformed its Western counterparts in recent years, which has resulted in the forming of more and more consumer societies there. Increasing in income has brought change in people. **They have begun to exhibit a more “Western” lifestyle. The results of this change have manifested themselves in multiple ways. The most notable is that in 2009, China overtook the US as the World’s biggest energy consumer, according to the International Energy Agency. China consumed 2.3 billion tonnes of oil equivalent, 4% more than the US, although still remains the world’s largest consumer of energy per capita.**

Quality of life

Space in denser urban environments with growing urban populations means that land for healthy and functional **“green” space has to compete with development and “grey” city infrastructure. Whilst our city parks, squares, open spaces and streets support networks of green and blue infrastructure, there is a pressing need to maximise and seek out new spaces and surfaces in the city to support quality of life.**

Urban environmental degradation

Human disturbance causes environmental degradation, earth’s natural resources are depleted and environment is compromised in the form of extinction of species, pollution in air, water and soil, and rapid growth in population. Environmental degradation is one of the largest threats that are being looked at in the world today. In city, the activities of urban living have intensified the process. This is particularly critical for the regional developing countries as the measures of control are not in place.

2. MATTERS TO BE ADDRESSED

2.1 Aesthetic quality

Apart from functional aspects of green infrastructure, the aesthetic qualities it can bring are significant. It provides an aesthetic that is potentially timeless owing to natural regeneration (Arup, 2016). Building envelopes have been covered with plants like ivy, wisteria and clematis for centuries, merely enriching the original architecture. This provides not only seasonal colours but also something that changes year after year. The psychological connotations of green infrastructure are multiple, as mentioned in the section on well-being. In addition, there are the psychological and physical interactions. A study showed that people with complex views of nature could accept more glare on their computer screens than those without.

2.2 Place-making

The most expensive property in cities such as New York and London surrounds exceptional green parks such as Central Park and Hyde Park for good reasons. Some of the most successful developments have created **“destinations” rather than just a collection of buildings, by integrating green spaces in their developments.** As urbanization increases, the number of people moving to cities will start to place strain on existing green infrastructure. Therefore, as space becomes rarer, desirable places will need to be created through new vertical and horizontal greening. Havens of peace can be created through new forms of green infrastructure. This is essential to create attractive places for people in cities to escape the 24-hour culture for short periods.

2.3 Air quality

Today, cities suffer from levels of air pollution, which have been shown to affect human health significantly. Large metropolitan cities like London and New York regularly exceed WHO limits for particulate matter. The WHO **estimates that poor air quality led to seven million deaths in 2012; and Yale University’s Environmental Performance Index** has calculated that over 1.78 billion people have inhaled polluted air over the past decade (Cheng & Tong, in press 2017). Air quality is a key driver for public health, particularly in urban areas where the population is heavily exposed to poor air quality. Breathing polluted air has been shown to trigger or exacerbate health problems such as asthma, lung disease and a variety of other medical issues.

2.4 Urban heat

The concreting over of natural spaces and the use of low-reflective materials on buildings contribute to the urban heat island effect. This is caused both by the loss of natural spaces that benefit from adiabatic cooling and by the impact of certain materials commonly used in urban construction such as asphalt and concrete (Arup 2016). Countries such as Greece have painted their buildings white for centuries to avoid overheating. Vegetated roofs can offer similar benefits.

2.5 Energy

Rapid growth of urban population is positively related to the percentage of urban population as more and more people are moving from rural areas to city for livelihood and better quality of life (Cheng & Tong, in press 2017). It is also projected that global urban populace would consume approximately 3 or **4 of the world’s energy** by then (Kamal-Chaoui, 2009). Cities have enormous potential for capturing the energy they received, e.g. heat, wind or sunlight. A renewable energy mix for significant developed countries is no longer merely an option, but is now enshrined in law under climate reduction commitments.

3. HOLISTIC AND OPTIMIZED APPROACH

3.1 Passive design

Passive design is the first principle in sustainable design and should be adapted as well at planning level. Best practice of sustainable passive design could moderate outdoor comfort by enhancing environmental factors. Research (Givoni et al, 2003) had been conducted to identify the factors influential to outdoor thermal comfort perceived by human. Temperature, air movement speed, humidity and solar irradiation, as illustrated in Figure 1, were studied and correlated in the scientific equation to assess comfort level in a scale of 7 steps. Further research (Cheng et al, 2010) **customized Givoni et al’s research for sub-tropical climate.**

The formula of Thermal Sensation (TS) is a collection of multiple factors:

$$TS = 0.1185 \cdot Ta - 0.6019 \cdot WS + 0.0025 \cdot SR + 0.1155 \cdot HR - 4.77$$

Equation 1

Where

TS – Thermal Sensation

Ta – Dry Bulb Air Temperature (OC)

WS – Wind Speed (m/s)

SR – Solar Radiation Intensity (W/m^2)

HR – Absolute Humidity (g/kg air)

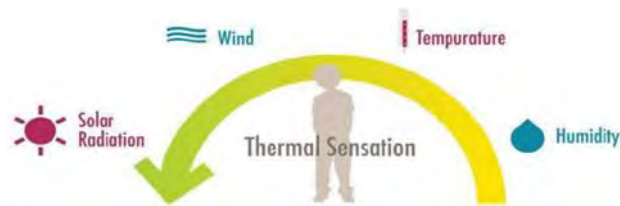

Figure 1: Illustration of thermal sensation and influencing factors

3.2 Urban wind micro-climate

As urban area gets intensified with building density, the more deteriorated situation of wind micro-climate would be in street canyons, especially on pedestrian level. By approaching passive design terminology at planning level, wind corridor is a key strategy to promote areal air movement and enhance pedestrian comfort, which subsequently bringing benefits to natural ventilation design at building design level. Optimized planning should consider to provision strategic street alignment towards prevailing wind to introduce wind corridor for hot season. Deep penetration of breeze into urban region would bring positive benefit to outdoor comfort, as shown in Figure 2. For winter season, especially to northern Asian regional which could reach to sub-zero Celsius temperature, passive planning design would be recommended to adopt staggered block arrangement with respect to incoming prevailing chilly wind for sheltering downstream built environment. Both the strategies tackling summer and winter season by moderating air movement speed to improve thermal sensation of outdoor space.

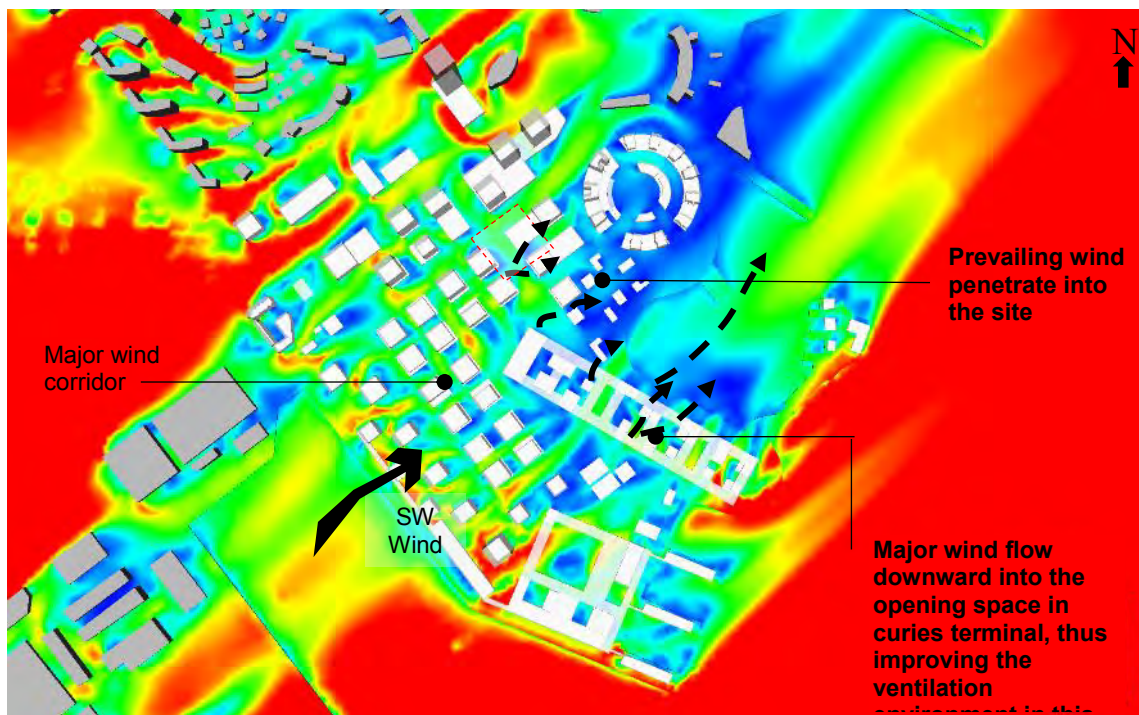

Figure 2: Summer wind microclimate performance simulation of design scheme for a masterplanning project in Shenzhen

In Singapore, Arup succeeded a project with “Environmental Filter” canopy that covers open space, linking up buildings and covering the podiums heritage and buildings. The integrated design of environmental canopy addresses sun, wind, light and rain holistically. As modified into semi-outdoor environment, this sustainable design achieves a tailored balance of promoted wind environment, solar irradiation control, rainfall screening, and air temperature moderation. Thermal comfort have been enhanced effectively with multi-dimensional adaptation of environmental factors, through studies of Built Environment Modelling (BEM) as shown in Figure 3.

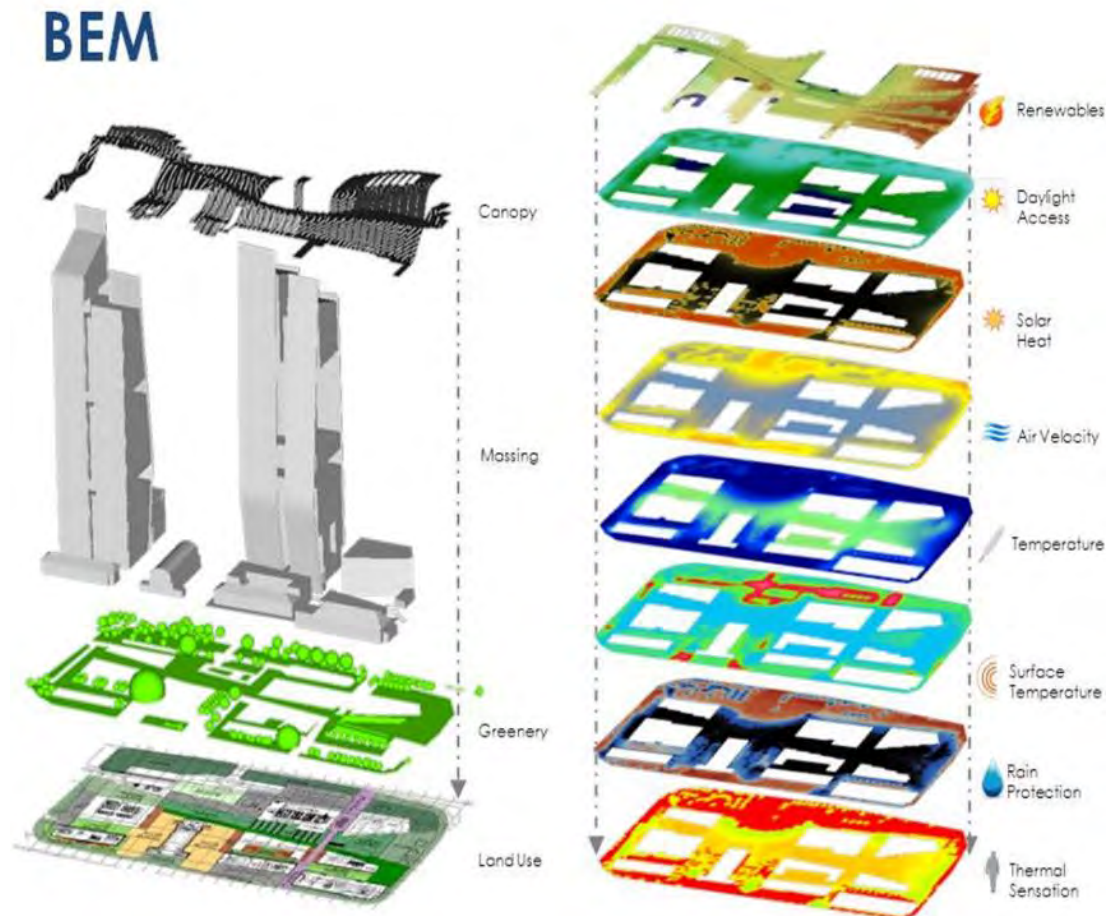

Figure 3: BEM study design optimization of semi-outdoor spatial design for enhanced outdoor thermal comfort

3.3 Urban heat island (UHI) effect

UHI describes an urban area whose temperature is considerably warmer than the surrounding suburbs and rural regions. Metropolitan hardscapes are the primary cause of this effect: concrete sidewalks, asphalt roadways, steel and glass façade, and other solid surfaces, which radiate rather than absorb heat (Arup, 2016). As global urban populations continue to rise, so too will energy consumption and poor air circulation, resulting in higher temperature for city residents. The United States Environmental Protection Agency advises that an urban area with a population exceeding 1 million may be 1 – 3°C hotter in the daytime and up to 12°C warmer in the evening than surrounding areas.

The idea is to improve heat island through city fabric design (Arup 2016). In the study on city level urban heat island effect, typical city grids were modelled with typical surroundings. To calculate the effect that vertical green façade would have on an urban scale would require a relative comparison for a city with and without green facades. The effect of the green facades would most likely be perceived in a reduction in air temperature over the urban landscape, typically referred to as UHI.

For the urban heat island (UHI) effect, it was found that there is a variety of city-associated parameters like the grid, solar radiation, canyon height-to-width ratio, thermal mass and the percentage of green space that influence the effect independent of green envelopes. Figure 4 illustrates indicative street canyon ratio of the 5 cities, Los Angeles, Berlin, London, Melbourne and Hong Kong, selected in study.

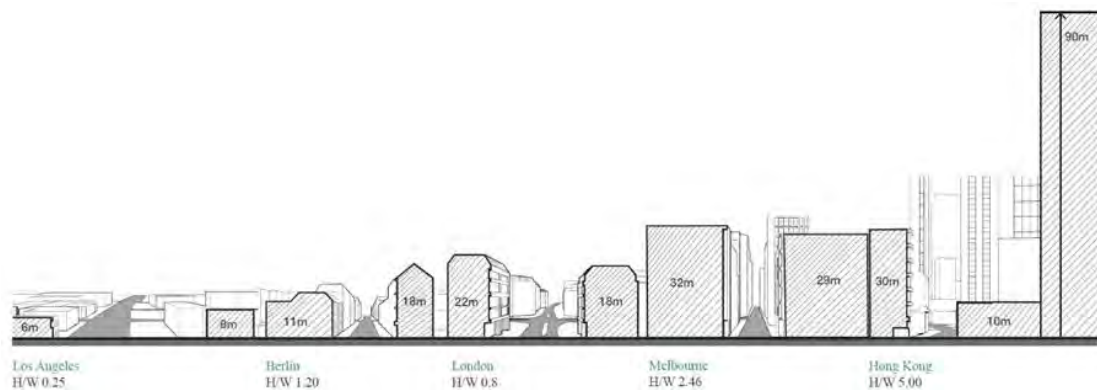

Figure 4. Canyon height-to-width ratio of 5 selected cities

Predicting the UHI effect was not the aim; instead, the change in air temperature to the urban atmosphere was calculated. It was found that vertical façades have the greatest impact on UHI in dense city topologies, as shown in Figure 5. Once the city is widespread (e.g. Los Angeles), most of the solar radiation will be absorbed on the streets instead of along the buildings. Similarly, once the cities are fairly green (e.g. Berlin), the relative benefit of adding vertical green façades makes a smaller difference.



Figure 5: Calculated maximum change in air temperature due to green facades in correlation with height-to-width ratio of street canyons

Green facades are most effective in reducing UHI in cities with a height-to-width (H/W) ratio greater than 2 – very dense urban city centres like Hong Kong or Melbourne fall into this category – peak temperature reductions of up to 10°C having been modelled. Green cities like Berlin experience limited benefit compared to denser cities with more concrete surfaces. Cities with wide streets and low-rise buildings like Los Angeles benefit more from greenery at street level.

3.4 Air pollution

Air Pollution is a complex mixture of gaseous, solid and liquid particles in the air. The list of airborne contaminants in urban spaces is extensive and includes some of the following: dust, pollen, factory emissions, soot, smoke, and motor vehicle exhaust.

Passive design mentioned in previous could improve pollution situation when prevailing wind could penetrate deep into tight urban built environment. However, pollutant accumulation could inevitably reach unhealthy level in calm wind days. Furthermore, busy road traffic in densely populated cities causes poor roadside air quality and it is a direct threat to public health. Due to the density of high-rise buildings, a common characteristic in cities is that many narrow street canyons are created. Street Canyon effect would result in accumulation of pollution is one of the major problems of modern cities. Citizens on pedestrian walkways due to long exposure are subjected to serious health problems. Most of these cities face challenges to achieve acceptable air quality level on the street. **In Beijing during 2013, it was reported that 58 “very unhealthy” days that had an Air Quality Index (AQI) reading higher than 200.**

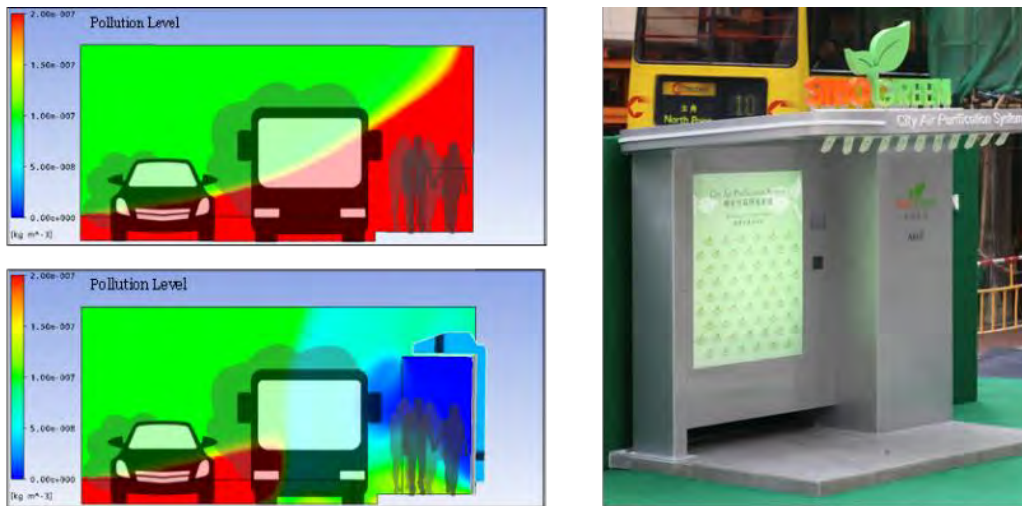

Figure 6: Design of City Air Purification System (CAPS) in a format of road side bus stop.

To serve immediate and pressing needs of curbing air pollution, active system should be considered. Arup and Sino Green have jointly developed a patent-pending design as shown in Figure 6, named the City Air Purification System (CAPS) (Cheng & Tong, in press 2017). The goal of this system is to provide a ventilation system that filters out pollutants and generates purified air for pedestrians in proximity to the system. A prototype, fabricated in the format of a bus stop, has been set up in one of the busiest city streets in Hong Kong. The prototype draws air current through inlet located at the bottom, then processes the airflow with bag filter which is effective in removing fine suspended particles (FSP or PM2.5) before discharging from overhead louver outlet. The discharged air stream is designed to form a wind barrier and provides better air quality “inside” the bus stop prototype. The improvement was measured up to 70% reduction of air pollutants.

3.5 Technological advancements

Advanced air mover

On top of adaptive and optimized passive design, advanced active engineering systems complete the puzzle of sustainable design. Active systems have been widely adopted to modify built environmental conditions. One of the most commonly seen applications is mist cooler, which is regular mitigation measure of evaporative cooling for dry climatic locations during hot season. However, such effective measure could become adverse action if put in place for hot and humid region. Another environmental parameter of thermal sensation, air movement speed, should be focused on to modify environmental conditions.

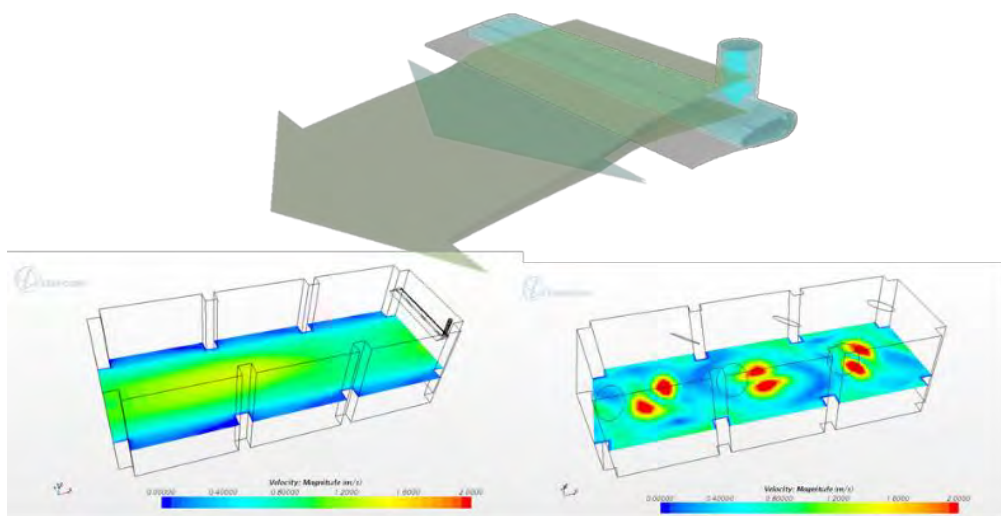

Figure 7: Design of Air Induction Unit (AIU) and study comparison of conventional swing-head fan and AIU on air movement distribution

Arup has conducted research and development on terminal device that could deliver the desired performance. Air Induction Unit (AIU) (Cheng & Tong, in press 2017), as shown in Figure 7, performs air movement similar to conventional fan, but in a much enhanced fashion. It improves ventilation with wide and even spread of air movement delivered in continuous and steady manner, instead of spot and intermittent bursts by swing-head fan. Furthermore, AIU holds merits of minimized electricity consumption and aesthetically harmonic with architectural appearance.

District energy

Conventional energy consumption is unidirectional in nature. Planning of new town provides opportunities to realize low and zero carbon vision at wider scale, which distributed district energy infrastructure is one of the good candidates. At present, utilities supply energy formats to consumption side with minimal feedback in return. This leads to inefficient use of resources as the consumption cannot be analysed and controlled. As shown in Figure 8, Micro-energy Grid (MEG) is a new approach (Kaushal and Basak, 2014; Marnay et al, 2008) which supplies major utility sources combined with a feedback loop and real-time control to reduce both peak demand and energy consumption. Electrical, heating, cooling and gas district networks are centrally managed and monitored via the Total Operation Centre (TOC). This facility acts as the brain of the network, collecting, analysing and managing real-time demand data in order to provide energy in the most efficient way possible.

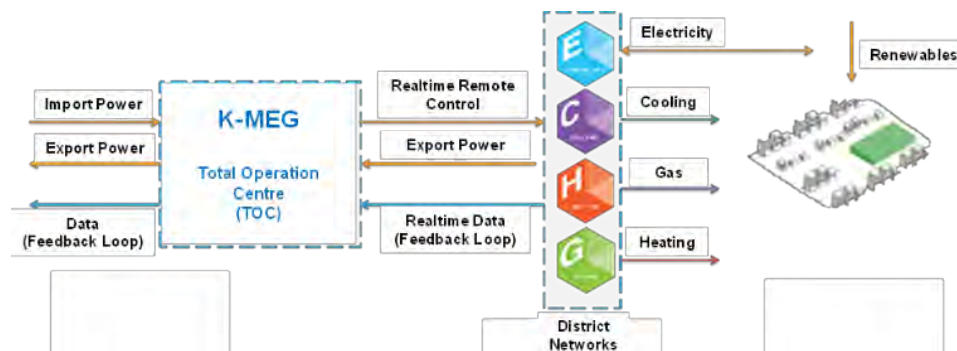

Figure 8: Schematic of Micro-energy Grid

Further improving overall system efficiency can be achieved by centralizing energy conservation systems. With better large-scale technologies becoming available and practical, higher systems efficiency at community level through increasing economies of scale by district energy systems. In addition to higher efficiency, centralised system also benefits by centralising maintenance; hence, maintenance can be managed more effectively through a single professional entity. Moreover, more prime space within buildings can be freed up for higher value functionalities. A successful District Cooling System (DCS) has to be planned and designed with the concept of enhanced system performance and economic. This is done by optimizing the design of chilled water production and the associated distribution network, therefore enhancing the energy efficiency and financial viability. DCS in Kai Tak Development, Hong Kong is one of the most recent experience. It has an energy saving potential up to 35% as compared to traditional building-level air-conditioning system, with better quality and reliability of services.

4. CONCLUSION

This paper presents the idea that rapidly rising on urbanization pushes additional resources pressure to the nature. Urban planning design could be one of the key approaches to demonstrate sustainability.

This is where buildings as a component of cities can make a vital contribution by fundamentally adopting nature-based design approaches. This can be through new ways of providing new development and important retrofitting and refurbishment of existing buildings in cities.

Passive design strategy approaches masterplanning with innovative ideas. Adaptive solutions with optimization addressing key issues of urban heat island and outdoor thermal comfort were presented. Study on street canyon relationship to urban heat island effect and potential mitigation measurement by green building envelope were demonstrated. In addition, technological advancements on active systems demonstrate various measures for enhancement built environment and address key issues due to intense urbanization by innovative system solutions.

REFERENCES

- [1] Argüeso, D., Evans, J.P., Fita, L. et al., 2014. Temperature Response to Future Urbanization and Climate Change, *Climate Dynamics* 42: 2183. doi:10.1007/s00382-013-1789-6.
- [2] Arup, 2016. *Cities Alive, Green Building Envelope*.
- [3] Cheng V., Ng E., Chan C., Givoni B., (2010) *Outdoor Thermal Comfort Study in a Sub-tropical Climate: A Longitudinal Study based in Hong Kong*, *Int J Biometeorol*, Springer.
- [4] Cheng, V.S. and Tong, J.C. (In press, 2017). *Building Sustainability in East Asia: Policy, Design and People*. John Wiley & Sons. ISBN 9781119277002
- [5] Givoni B, Noguchi M, Saaroni H, Pochter O, Yaacov Y, Feller N, Becker S (2003) Outdoor comfort research issues. *Energy Build* 35(1):77–86
- [6] Kalnay E. and Cai M., 2003. Impact of urbanization and land-use change on climate, *Nature*, 423, 528-531, 29 May 2003.
- [7] Kamal-Chaoui, L., and Roberts, A. (eds.), 2009. *Competitive Cities and Climate Change*, *Regional Development Working Papers N2*.
- [8] Kaushal J., Basak P., 2014. *Microgrid: An Emerging Power System and its Deployment in Indian Power Scenario*, *Conference on Integrated Computational Techniques in Electrical Engineering (ICTEE-2014)*
- [9] Marnay C., Zhou N., 2008. *Status of Overseas Microgrid Programs: Microgrid Research Activities in the US*, *Enest Orlando Lawrence Berkeley National Laboratory Report, LBNL-56E*
- [10] NOAA, 2015. *Global Analysis – Annual*.
- [11] United Nations, 2014. *World Urbanization Prospects*.
- [12] Zhou, L., Dickinson, R. E., et al., 2004. Evidence for a Significant Urbanization Effect on Climate in China, *PNAS* Vol 101 no. 26, 29 June 2004.

Poster Session

Water Use of Thin-Layer Green Roof by Vertical-Flow Constructed Wetlands

PENG Jr-jie^a, CL CHENG^b

^a National Taiwan University of Science and Technology, Taiwan, af9864@cpami.gov.tw

^b National Taiwan University of Science and Technology, Taiwan, ccl@mail.ntust.edu.tw

ABSTRACT

Thin-layer green roof is irrigated by tap water supply and supplemented with rainwater as the auxiliary water supply. There have been continuous researches carried out by many domestic and foreign experts and scholars, and there have been many cases proving the water saving benefit of replacing a portion of tap water. However, green roof is still regarded as a facility consuming water resource. In this study, the thin-layer green roof integrated with vertical flow constructed wetland purification effect has been established based on the perspectives of recycling, treatment, and reclamation of water in a building in order to replace the water source of tap water irrigation. The evaluation equation has been proposed for understanding the benefit of using reclaimed water to replacing tap water. In addition to meeting the need of its own irrigation system, it can also be used for the irrigation of other facilities or the water for flushing toilets in a building such that the water demand management of planting and cultivation can be simplified. The advantages of this study is that it can achieve the short cycle of building self-management and the concept of reduction of energy consumption due to the easy access of source of slight pollution generated by a building, which will lead to the benefit of positive sustainable operation.

Keywords: green roof, resource, short cycle

1. INTRODUCTION

The alternative option of creating green roofs (GR) setup involves providing a layer of soil media on top of the roof to improve thermal resistance of the roof and provide heat insulation. Water retained in the soil can also improve the average heat capacity of the soil and delay heat conductance into the interior spaces within the building. The layer of vegetation supported by the GR can also reduce direct exposure to sunlight and lower heat absorption of constructed and concrete surfaces. Evapotranspiration from the vegetative cover can also help modulate the temperature and humidity in the surrounding air. However, GR requires irrigation and therefore consumes water, increasing the demands for water resources of the building. The current approach is to integrate rainwater recycling systems as well as public water supplies. The Industrial Technology Research Institute (ITRI) of Taiwan has conducted water usage surveys with 600 public water users that include tourist hotels, integrated hospitals, key tourism areas, department stores, schools, and public agencies. Survey results show that with the exception of department stores, bathroom activities consumed the highest proportion of water in all other public water users. Large-scale implementation of effective on-site collection, treatment, and reuse of discharged water or sewage for other purposes will significantly reduce water consumption. Gray water recycling systems offer the advantage of improving the stability of water supply, but water treatment equipment tend to be very expensive. A new green landscaping system capable of simultaneously reducing water usage and improving wastewater recycling could be developed if ecological engineering technology capable of emulating the cleansing mechanisms and functions of natural wetlands could be developed and employed in thin-layer GR. This would transform the GR from a net consumer of water into a producer. This improved GR will retain the advantages of GR, while providing water purification functions. Gray water and harvested rainwater could be used in short-range resource recycling within buildings. For example, the water generated and collected by the system can be directed to water consuming amenities and facilities in vicinities for flushing toilets or fighting fires.

2. ESTABLISHING THE MODULAR SYSTEM

This study selected a site in Taiwan Taipei. The surrounding environment is relatively open and offers good ventilation. Building information modeling (BIM) and ECOTECT software simulation were used for the analysis.

The site has an ambient temperature range of 8 to 35°C and an indoor floor space of 49 square meters. Figure 1 shows simulated models and layout plan of the building.

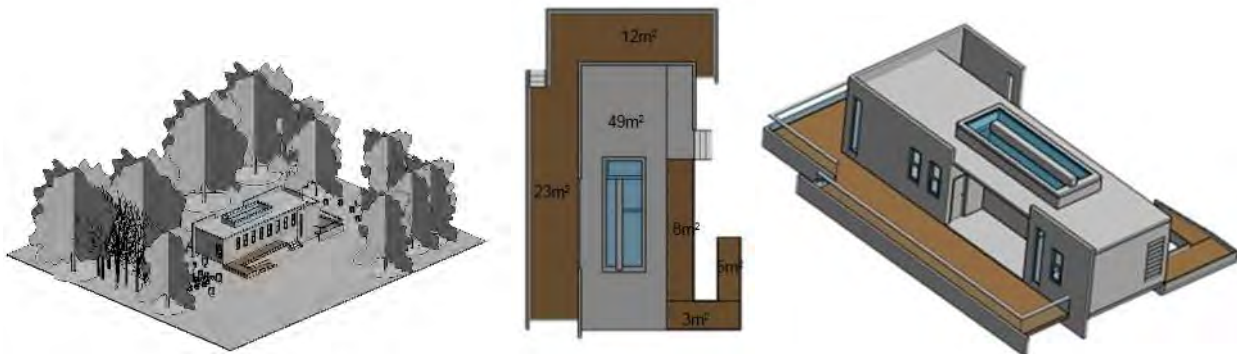

Figure 1: Layout plans and models used for the simulation

2.1. Roof parameter settings

The Technical Specifications for Heat Performance and Energy Saving Designs for Reinforced Building Envelopes stipulated by the Construction and Planning Agency of the Ministry of the Interior was used as a reference in order to estimate the heat transmission coefficient of the roof. The Detail function of the BIM was used to set formulas and parameters for the exposed rooftop (Table 2), general thin-layer GR (Table 3), and thin-layer GR with purification function (Table 4). Parameters include: thermal conductivity, thermal resistance, total thermal resistance, and coefficient of thermal transmittance (U-value). Coefficient of thermal transmittance is the inverse of total thermal resistance, while total thermal resistance is the sum total of thermal resistances of all materials. Thermal conductivity (unit: W/m.K) is also known as heat conductance and can be calculated using the formula of $k = (Q/t) * L / (A * T)$, where k is thermal conductivity, Q is the amount of heat, t is time, L is the length, A is the area, and T is the temperature difference. This expression is used to measure the amount of heat vertically conducted through a material of unit area per unit time per unit temperature difference. Formula of coefficient of thermal transmittance is:

$$U_i = \frac{1}{R} = \frac{1}{\frac{1}{h_o} + \gamma\alpha + \frac{1}{h_i} + \sum \frac{d_x}{k_x}}$$

Major construction components	Thickness, d (m)	Thermal conductivity, 1/k (m.k/w)	Thermal resistance r = d/k (m²/w)	Total thermal resistance R = $\sum r$ (m²/w)	Coefficient of thermal transmittance (w/m²)
Waterproof, bituminous felt with felt board reinforcement	0.01	1/1.4	0.0071	0.8847	1.13
Waterproof barrier and water drainage slopes	0.02	1/1.4	0.0143		
Waterproof strata	0.03	1/0.05	0.6000		
Internal air film	0.001	1/7	0.1429		
Cement mortar	0.02	1/1.5	0.0133		
RC concrete	0.15	1/1.4	0.1071		

Table 2: Settings for the exposed roof structure

Major construction components	Thickness, d (m)	Thermal conductivity 1/k (m.k/w)	Thermal resistance r = d/k (m².k/w)	Total thermal resistance R = $\sum r$ (m².k/w)	Coefficient of thermal transmittance (w/m².k)
Outside air film	0.001	1/23	0.0435	3.819	0.262
Cover plants			0.3600		
Growing layer / light soil	0.2	1/0.47	0.4255		
Sawdust	0.001	1/0.05	2.0000		

Nonwoven fabric and water retention plate	0.02	1/0.19	0.1053		
Waterproof, bituminous felt with felt board reinforcement	0.01	1/1.4	0.0071		
Waterproof barrier and water drainage slopes	0.02	1/1.4	0.0143		
Waterproof strata	0.03	1/0.05	0.6000		
Internal air film	0.001	1/7	0.1429		
Cement mortar	0.02	1/1.5	0.0133		
RC concrete	0.15	1/1.4	0.1071		

Table 3: Settings for the general thin-layer GR

Major construction components	Thickness, d (m)	Thermal conductivity 1/k (m.k/w)	Thermal resistance r = d/k (m ² .k/w)	Total thermal resistance R = $\sum r$ (m ² .k/w)	Coefficient of thermal transmittance (w/m ² .k)
Outside air film	0.001	1/23	0.0435	4.9063	0.203
Cover plants			0.3600		
Ceramic gravel	0.3	1/0.1	3.0000		
PVC	0.02	1/0.039	0.5128		
Nonwoven fabric and water retention plate	0.02	1/0.19	0.1053		
Waterproof, bituminous felt with felt board reinforcement	0.01	1/1.4	0.0071		
Waterproof barrier and water drainage slopes	0.02	1/1.4	0.0143		
Waterproof strata	0.03	1/0.05	0.6000		
Internal air film	0.001	1/7	0.1429		
Cement mortar	0.02	1/1.5	0.0133		
RC concrete	0.15	1/1.4	0.1071		

Table 4: Settings for thin-layer GR with purification functions

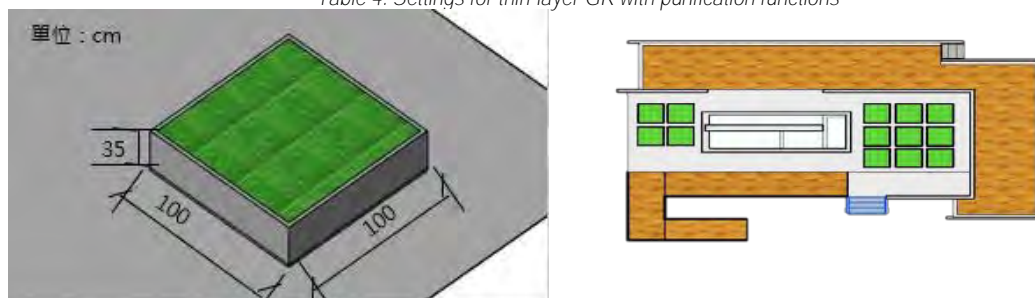

Figure 2: Configuration of the GR module

The thin-layer GR with water purification functions used in this study must consider roof loading, water source quality, and ease of operations in addition to basic requirements and irrigation of the plants growing on the GR. While setting the parameters, BIM was used to modularize the general thin-layer GR and the thin-layer GR with purification functions. These modules were then added to the site model. Due to the need to reserve areas for skylight openings as well as cabling and pipeline arrangements, a layout configuration with 13 thin-layer GR module units was used. (as shown in Figure 2)

Growth medium layer: 100 cm x 100 cm x 12 cm (Length x Width x Height). This layer was designed according to Article 17 that described the minimum active loading regulations described in the chapter of building construction of Building Technical Regulations. Lightweight medium and materials for easier retention and stable volume were selected instead of traditional growth medium. The mixture near the inlet would be composed of ϕ 5~10 mm vermiculite and ϕ 5~10 mm expanded clay aggregate. The middle section was filled with a mixture of ϕ 3~5 mm perlite, ϕ 1~4 mm maifan stone, and other sticky materials. To provide the plants with a good growing environment, the growth medium layer composes at least 30% of the total volume.

First filtration layer: 100 cm x 100 cm x 4 cm (L x W x H), composed of a mixture of diatomaceous earth and diatomite pressed into plates. Diatomaceous earth are extremely inert materials that offer good filtration and purification properties. The extremely tiny pores of the material allow the filtration of foreign materials, dust, and bacteria. Meanwhile, diatomite offers larger pores, strong water adsorption, and chemical stability. The first filtration layer lies between the soil-free medium and the drainage / water retention layers. This layer prevents the growth

medium from being discharged along with the water while preventing discharge pipes at the water retention layer from being clogged.

Drainage and water retention layer: 100 cm x 100 cm x 8 cm (L x W x H). This layer was constructed using recycled polypropylene that is comparable to PE, but offers better physical and mechanical performance in terms of tension and stress resistance. The drainage and retention layer functions as a plate for filtering out contaminants in the water which would then settle at the first filtration layer, preventing the tank from accumulating too much water, leading to deterioration of water quality while retaining enough water for plant use.

Second filtration layer 100 cm x 100 cm x 6 cm (L x W x H). This is composed of ceramic gravel (5), quartz sand, and a gravel layer (6). A discharge outlet was placed at the bottom of the tank to drain the retained water completely.

2.2. Indoor temperature testing

After the BIM models were built, they were then imported into the ECOTECT software to simulate the results for the general thin-layer GR as well as the thin-layer GR with purification functions. Simulation results were then illustrated on a chart for comparisons. The simulation conditions include natural ventilation and the environmental temperature of Taipei City at 12 PM (noon) on August 1st. The areas reviewed in the comparison were the master bedroom (A), living room (B), and toilet (C). (as shown in Figure 3)

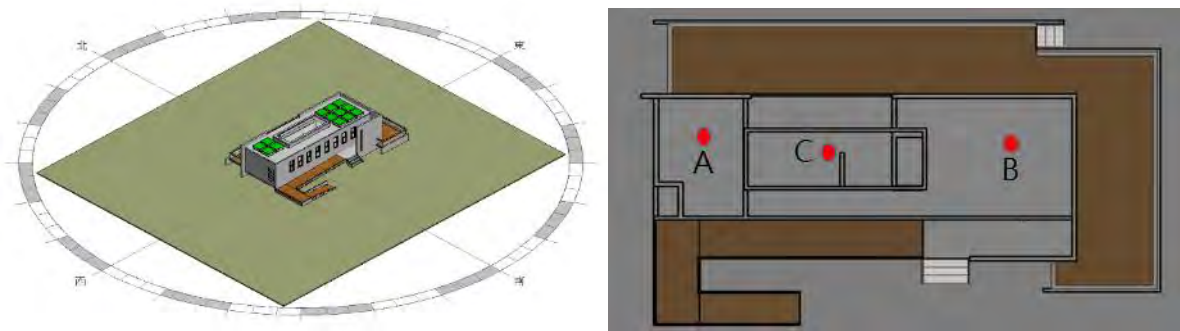

Figure 3: Testing area

2.3. Building a model for a thin-layer GR that employs vertical-flow constructed wetlands

A total of 3 water supply systems were designed for the thin-layer GR with purification functions in this study. The first uses harvested rainwater as the source of water. Gray water will be used if not enough rainfall was received, and public water will only be used if both rainwater and gray water were unable to meet water requirements. If gray water volume exceeds the designed capacity, the excessive quantities will be purified, recycled, and then diverted for irrigating other landscaping facilities or flushing toilets. A study of decision support and cloud operating system for the allocation of stormwater detention capacity published by the Architecture and Building Research Institute (ABRI) of the Ministry of the Interior in 2015 was used as the reference to investigate water cycling when employing vertical-flow constructed wetlands in thin-layer GR and to evaluate a number of different influent flow and hydraulic parameters for various thin-layer GR models. The design volume for water retention was assumed to be equal to the sum of water infiltration and water storage to deduce the related formulas shown in the following:

Design capacity of the GR V (m³). Design volume for water detention = Water infiltration + water storage:

$$V = \text{Min}(A_6 t, 0.42V)$$

A_6 : Area of the GR (m²)

f : Final infiltration rate of the soil at the site m/s

V : Volume of the GR (m³)

t : Standard time delay for maximum rainfall (sec). Default value was set to 86,400 sec

Equation 1

Soil material	Sand	Silt	Clay	Highly plastic clay
Final infiltration rate, f	10^{-5}	10^{-6}	10^{-7}	10^{-7}

Table 5: Setting for the final infiltration rate of the soil at the site

The formula below was used to determine whether to activate or deactivate the gray water injection and calculate the GPV grey water injection rate (m³/hr) into the GR once activated when the maximum GR design volume exceeds the hourly cumulative rainfall:

$$GPV = V_{max} - (I/1000 \times A6)$$

I: Total rainfall (mm/hr)

V_{max}: Maximum roof volume (m³)

Equation 2

The formula below was used to determine whether or not to activate or deactivate the rainwater replenishment system and calculate the GRV replenishment system irrigation rate (m³/hr) once activated when the grey water hourly injection rate into the GR falls below a certain limit:

$$GRV = V_{max} - GPV$$

Equation 3

Incoming runoff retention rate for the thin-layer GR that uses vertical-flow constructed wetland:

$$\frac{(GRV+GPV-V) \times S}{(GRV+GPV)}$$

$$GRR = \dots \times 100\% \dots$$

GRR: Incoming runoff retention rate (%)

GRV: Volume of rainwater that passes through the thin-layer GR module per hour (m³/hr)

GPV: Volume of gray water that passes through the thin-layer GR per hour (m³/hr)

V: Runoff volume of the thin-layer GR per hour (m³/hr)

S: Evaporation rate

Equation 4

Additional considerations must be made to calculate various hydraulic parameters at different influent volume, including the volumes of processed water or wastewater per unit time per unit area. The resulting formula can also be used as an expression for hydraulic loading. Hydraulic loading is an important design and operational parameter for the processing unit. A feasible range should be specified to assess the allowable purification performance of secondary treatment of domestic wastewater.

To calculate various hydraulic parameters at different influent volumes, the hydraulic retention time (HRT) and hydraulic loading of the thin-layer GR with vertical-flow constructed wetland should be calculated:

$$V_r = G_v \times n$$

V_r: Actual volume of the water containing layers (m³)

G_v: Volume of the thin-layer GR module (m³)

n: Porosity (ratio of pore volume to total volume of the materials, and ranges from 0 to 100%)

Equation 5

$$HRT = V_r / Q$$

HRT: Hydraulic retention time (hr)

Q: Inflow (m³/hr)

Equation 6

$$HLR = Q / A_s$$

HLR: Hydraulic loading rate (hr)

A_s: Surface area of the thin-layer GR (m²)

Equation 7

3. ANALYSIS

3.1. Heat island reduction of thin-layer GR with purification function

This study employed BIM tool of ECOTECT software to replace roof materials and simulate the resulting temperature distribution for further analysis. Simulation time for natural ventilation simulations were set without changing the air conditioning settings and scenarios. Daytime was selected for the simulation primarily to evaluate

conduction of solar heat and how it changes indoor temperatures. Thin-layer GR with purification functions was shown to achieve good thermal insulation effects and able to suppress increases in indoor temperatures as it utilized ceramic materials that offer better thermal resistance. Since the BIM system could only analyze average daytime temperatures, further research will be required to determine whether GR can help retain heat or reduce heat dissipation and other energy loss for indoor temperatures and environments during nighttime and provide designers with reference and information needed for effective data utilization.

3.2. Gray water efficiency in the thin-layer GR with purification function

BIM details showed that total water conservation volume would be 1.64 m³ for the 13 GR modules with purification functions after subtracting the water in the growth medium and plant structures. For Taipei City, the average rainfall in the month of June was 325.9 mm with an average hourly rainfall of 0.45 mm. This meant that 1,630 liters of gray water could be purified per hour to replace public water used for irrigation purposes. Hydraulic retention time (HRT) and hydraulic loading were found to be within the recommended design values stipulated for using constructed wetlands for secondary treatment of domestic wastewater. In other words, the system met the HRT and hydraulic loading requirements of decontamination processes using free water surface (FWS) and vertical-flow constructed wetlands. Water requirement management for vegetative cover grown on GR was made easier. The advantages was that water could be easily acquired from light polluted wastewater from the buildings as well as rainwater. Under the concept of short-range water recycling, these sources of water could also be used for other irrigation purposes, benefiting the environment with sustainable management. However, this study has yet to carry out in-depth investigation of variables of the thin-layer GR that include structural form, dimensions, materials, choice of aquatic plants, choice of lightweight growth medium, and climate changes and their relationships to gray water decontamination performance in the system. These investigations may be carried out in subsequent studies.

4. CONCLUSIONS

BIM was employed to investigate hydraulic conditions and parameters under different inflow volumes and thin-layer GR types, and to establish models for hydraulic retention time (HRT), hydraulic loading, and pollution loading models to understand and assess reasonable grey water recycling and usage models for irrigation and toilet flushing in the building. Lightly polluted wastewater discharged from building showers and sinks as well as rainwater could be adequately controlled and treated through this system. Once water quality reaches an acceptable standard, the treated water could be used for irrigating GR and other landscaping features or for flushing toilets. Water requirement management for vegetative cover grown on GR was also made more convenient. The advantages was that light polluted wastewater from the buildings as well as rainwater could be easily acquired. Under the concept of short-range water recycling, these sources of water could also be used for other irrigation purposes, providing positive sustainable management and benefiting the environment in the process.

REFERENCES

- [1] Sakkas. Panos, " Domestic Greywater Treatment through the Integration of Constructed Wetlands in Living Wall Systems, Master Thesis", TU Delf, 2012.
- [2] Odum, E.P., and G.W. Barrett, "Fundamentals of Ecology", Thomson Learning Co, U.S.A, 2005.
- [3] Mitsch, W. J., and R. F. Wilson, " Improving the success of wetland creation and restoration with know-how, time, and self-design", *Ecological Application*. Vol.6, p.77-83,1996.
- [4] Tchobanoglous, G., and F.L. Burton, " Wastewater Engineering-Treatment. Disposal", Reuse McGraw-Hill, Inc. U.S.A,1991.
- [5] A. Gross, O. Shmueli, Z. Ronen, E. Raveh, " Recycled vertical flow constructed wetland (RVFCW)—a novel method of recycling greywater for irrigation in small communities and households", *Chemosphere* 66,pp.916-923,2007.
- [6] Barrio P.E, "Anyalysis of the Green Roofs Cooling Potential in buildings." *Energy and Buildings*, 27,pp. 179-193,1998.
- [7] Hammer, D. A., "Creating Freshwater Wetlands. CRC Press", Inc. U.S.A, 1996.
- [8] Sullivan, G, "Establishing vegetation in restored and created coastal wetland", U.S.A,pp.119-155, 2001.
- [9] IWA, "Constructed wetlands for pollution control : processes, performance, design and operation", IWA published,2000.

- [10] E. Friedler, "Quality of Individual Domestic Greywater Streams and its Implication for On-Site Treatment and Reuse Possibilities", *Environmental technology*, Vol. 25, pp.997-1008, 2004.
- [11] Mauchamp, A., P. Chauvelon, and P. Grillas, "Restoration of floodplain wetlands: open polders along a coastal river in Mediterranean France", *Vistre marches. Ecological engineering*. Vol. 18, pp.619-632, 2002.
- [12] J. Vymazal, "Constructed Wetlands, Subsurface Flow, Reference Module in Earth Systems and Environmental Sciences", *Encyclopedia of Ecology*, pp.748-764, 2008.
- [13] Matjaz Nekrep Perc, "Vertical constructed wetland for embedded grey water treatment", 40th International Symposium of CIB W062 on Water Supply and Drainage for Buildings, 2014.
- [14] A. Stefanakis, C.S. Akratos, V.A. Tsihrintzis, "Vertical Flow Constructed wetlands—Eco-engineering Systems for Wastewater and Sludge Treatment", *ELSEVIER*, 2014.
- [15] Marion, W. and Urban, K, User's manual for TMY2. National Renewable Energy Laboratory, U.S.A., 1995.
- [16] Villarreal, E. L. and A. Dixon. "Analysis of a rainwater collection system for domestic water supply in Ringdansen, Norrköping, Sweden." *Building and Environment* 40(9): 1174-1184, 2005
- [17] Lyon, J. G. and J. McCarthy. *Wetland and Environmental Applications of GIS*. CRC Press. U.S.A., 1995

“Sponge City”, A Mental Experiment with Scientific Solution for “Sustainable Neighbourhood”

James XIONG Jian^a, Jason YANG^b, TANG Yuqi^c, Simon TANG^d

^a WSP | PARSONS BRINCKERHOFF, Hong Kong SAR, xiong.james@pbworld.com

^b WSP | PARSONS BRINCKERHOFF, Hong Kong SAR, jason.yang@wspgroup.com.hk

^c WSP | PARSONS BRINCKERHOFF, Hong Kong SAR, yuqi.tang@wspgroup.com

^d WSP | PARSONS BRINCKERHOFF, Hong Kong SAR, simon.tang@wspgroup.com.hk

ABSTRACT

With worldwide cities getting bigger and climate change threatening to bring more extreme weather, about half of **China's cities are considered water scarce or severely water scarce by UN measures and another half fail to reach national standards for flood prevention.** “Sponge cities” equivalent terms to Low-impact development (LID) used in North America and sustainable urban drainage systems (SUDS) in the UK, a re-imagination of the urban environment where almost every raindrop is captured, controlled and reused has been trendy in China. Instead of funneling rainwater away, a sponge city retains it for use. Some might be used to recharge depleted aquifers or irrigate gardens and urban farms. Some could replace the drinking water to flush toilets and clean homes.

A study recently being completed on “Sponge City” planning of Sino-Singapore Tianjin Eco-city is located in North China. The study aims to help the local government achieving the goals of storm water reduction and source runoff control. In this way, the **Eco-city could retain, infiltrate and purify storm water, and fulfil the concept of “sponge city”.** Storm Water Management Model (SWMM) was selected to simulate runoff process and assess the effect of using different combinations of LID facilities. The model result shows that the LID measure can help control 80% of the annual total runoff under the design precipitation. In consideration of high salinity in **Eco-city's water and soil, the recommended LID facilities include green roof with cistern, high level rain-parterre, ecological pond, pervious pavement and grass swale.** Guideline of each kind of facility is provided as well for next stage detail design. The study demonstrates reverse-engineering a city to make it more spongey requires a mental shift back up by practical scientific solutions.

Keywords: low impact development, sponge city, sustainable neighbourhood

1. INTRODUCTION

High groundwater level and soil salinization are the main constraints for sponge city construction of Tianjin Eco-city and other Northern Chinese Cities. Considering the goal of improving water environment and restoring water ecology, and the constraints in Tianjin Eco-city, the overall sponge city construction strategy for Eco-city is determined as the combination of small-scale distributed measures and large-scale regional measures. It is a **combination of pilot “sponge city” neighbourhood as well as a whole city development strategic vision.**

Technically, this study is to build Low Impact Development (LID) hydrological model for Tianjin Eco-City by using the SWMM software. LID layout schemes are compared and optimized in combination with the hydrological status of Eco-city to determine the control indexes of LID rainwater system and resources utilization system. Best practical LID facilities and technologies for Tianjin Eco-city are recommended. It is an effort to experiment the relevant technology and to back up the mentally fundamental thinking and behaviours.

2. SIMULATION FOR ECO-CITY LID RAINFALL SYSTEM

The study area is to set as 150.58km² of Tianjin Eco-City including the original Central Eco-City Area, Binhai Tourism Area and Tianjin Marine Economic Area. Figure 1 shows the assessment area.



Figure 1: The study area

2.1 Technical approach

The technical approach for the Eco-city LID model development is as followed:

- Define the sub-catchment of the research areas according to the rainwater systems, regional land use planning and road network;
- Set up the design targets (mainly for volume capture ratio of annual rainfall) according to the relevant national requirements on sponge city development;
- Determine the boundary conditions;
- Digitalise the inputs of SWMM model, including topography, soil, land use, slope, impervious rate, etc.;
- Primarily set the control indexes and combinations of different LID facilities, simulate and analyze whether design targets could be met;
- Adjust the control indexes to meet the design targets;
- Design the Best Management Practice (BMP) measures for process and end control, evaluate extra rainwater regulation and storage measures and carry out SWMM simulation;
- Determine the optimal “LID+BMP” combination measures and build up the index system for the Eco-city.

The defined sub-catchment and the major model parameters are shown in Figure 2 and Table 1.



Figure 2: Sub-catchment area of Eco-city

Module Parameters	Adjusted Value
Impervious rate (%imperv)	10-80
Manning coefficient in impervious area (N-imperv)	0.012
Manning coefficient in pervious area (N-perv)	0.032
Manning coefficient in pipelines (roughness)	0.013-0.015
Depression storage depth in impervious area (S-imperv)/mm	0.38
Depression storage depth in pervious area (S-perv)/mm	1.52
Maximum infiltration rate of Horton module (Max.Infil)/(mm/h)	75
Minimum infiltration rate of Horton module (Min.Infil)/(mm/h)	3.8
Decay coefficient of Horton module (α)	0.006

Table 1: Major hydrological parameters of Low Impact Development (LID) module

2.2 Hydrological computation

Design rainfall

According to Outdoor Drainage Design Guideline (GB50014-2006) (2014 edition), the Annual Maximum Value Method shall be adopted in the storm intensity formula for designing drainage system if the area has over 20 years of rainfall records; value of many years can be adopted if the area has less than 20 years of rainfall record.

The storm intensity formula adopted in Tianjin is as follow:

$$q = \frac{3841 \times (1 + 0.85 \lg P)}{(t + 17)^{0.85}} (L / S.ha)$$

Where, q = Designed storm intensity (l/s•ha); P = Recurrence period (year); t = rainfall duration (min).

Overall objectives

The control volume capture ratio of annual rainfall shall be no less than 80%, corresponding to 30.4 mm of design rainfall for Tianjin. The pollution control indexes of rainwater runoff shall be calculated based on Suspended Solid (SS) and Chemical Oxygen Demand (COD). The total annual removal rate of SS shall be more than or equal to 30%, and the total annual removal rate of COD shall be more than or equal to 20%.

Rainfall type selection

As stated above, the control volume capture ratio of annual rainfall shall be no less than 80%. According to the storm intensity formula for Tianjin city area, the corresponding rainfall type is obtained for the Eco-city by using the Chicago Method.

The model also simulates the storm of single-peak long-duration rains for 2-year and 30-year recurrence period by Chicago Method:

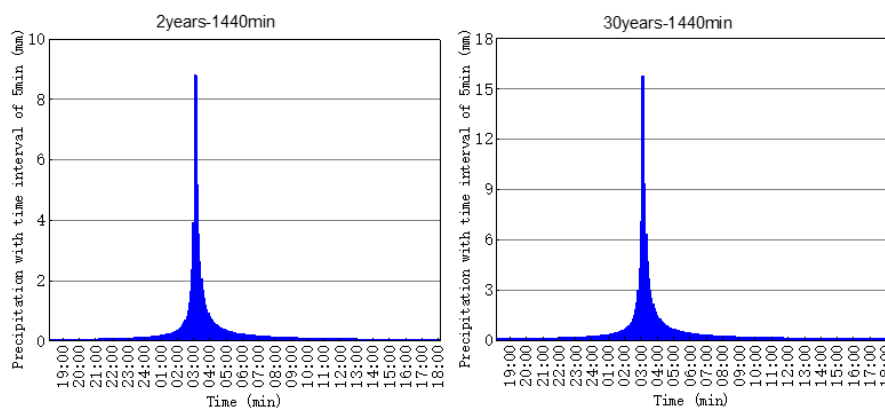

Figure 3: Rainfall process of 2-year and 30-year long-duration rain types in Eco-city

2.3 Model results

The simulation analysis were carried out on tradition practices of drainage system (without LID) and sponge city building schemes (with LID) in ECO-CITY, mainly including designed rainfall analysis, general analysis and runoff process analysis.

Design rainfall analysis

The total runoff process of the design rainfall type based on 80% control volume capture ratio of annual rainfall (30.4mm of design rainfall) is shown below:

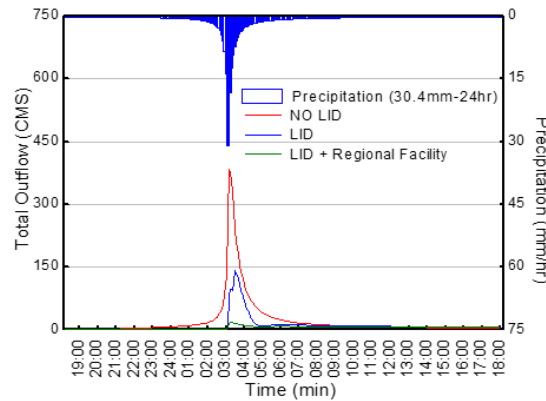

Figure 4: Outflow comparison of Eco-City system with/ without LID

As shown in the above figure, for 30.4 mm rainfall during 24 hours, the outflow could be controlled after adding LID facilities and regional facilities in the planning area. The result meets the requirements of Technical Guidelines for Sponge City Building (Trial version) for 80% control volume capture ratio of annual rainfall.

General analysis

The comparison for total outflow under 2-year and 30-year recurrence period is shown below:

Total Outflow (10 thousand m ³)	2years-24hr	30years-24hr
NO LID	650	1251
LID	504	1084
LID + Region Facility	250	931
Runoff Reduction Rate	61.5%	25.6%

Table 2: Comparison for total outflow under different recurrence period

Results show that the sponge city building scheme can reduce the total outflow. However, with the rainfall intensity increases, the storage volume of LID facility tends to be fully utilized and cannot store more runoff. Thus, the LID facility is more effective during regular rainfall than during heavy rainfall.

Comparison results of peak runoff values under different recurrence period are shown in Table 3. Results show that the sponge city building scheme can effectively reduce the peak value in the project area, and can also help controlling flood risks in the Eco-city.

Peak Value (m ³ /s)	2years-24hr	30years-24hr
NO LID	1768	3800
LID	1355	3468
LID + Region Facility	580	925
Runoff Peak Value Reduction Rate	67.2%	75.7%

Table 3: Comparison for peak flow under different recurrence period

Runoff process analysis

Runoff processes for 24-h rainfall under 2-year and 30-year recurrence period in the project area are analysed. The results are shown as below:

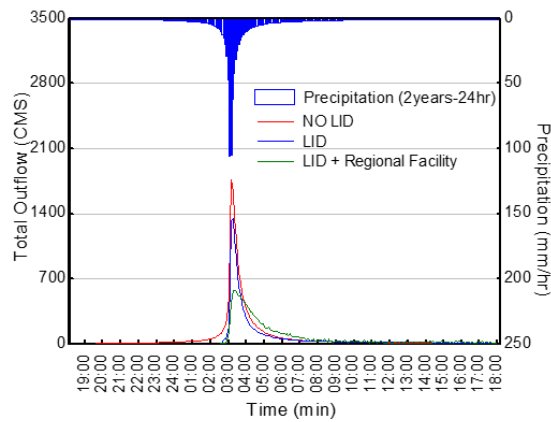

Figure 5: Outflow comparisons for 2-year long-duration rain type with/ without LID

As shown in Figure 5, under 24h rainfall of 2-year recurrence period, the systemic outflow peak value is significantly reduced by 67.2%, and the total runoff amount is also significantly reduced by 61.5% after adding LID and regional facilities in the project area.

As shown in Figure 6, under 24h rainfall of 30-year recurrence period, the runoff peak is significantly reduced by 75.7% after adding LID and regional facilities in the planning area. And the total runoff reduction rate is 25.6.

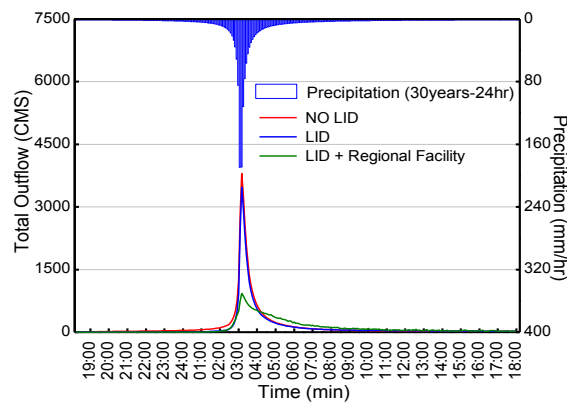

Figure 6: Flow comparison for 30-year long-duration rain type with/ without LID

3. CONTROL SCHEME FOR LID RAINWATER SYSTEM AND RESOURCE UTILIZATION

3.1. Applicable LID facilities in Tianjin Eco-city

Considering the major water issues and restriction factors in Tianjin Eco-city, the combination construction of the small-scale distributed measures and large-scale regional measures is recommended as the general strategy for sponge city building in Eco-city. Small-scale distributed measures include green roof, rainwater barrel, high-level rainwater parterre, ecological pond, pervious pavement, grass swale, rainwater garden (rainwater storage) and etc; Large-scale regional measures include regional treatment and storage, green storage/reservation (constructed wetland, wet pond, etc.).

3.2. Control quota distribution of LID measures of Eco-city

According to calculation of the above-mentioned LID models, the control quota distribution of LID measures of various land types of Tianjin Eco-City can be acquired. Figure 8 shows plan figures for LID measure distribution of different land types of Tianjin Eco-City.

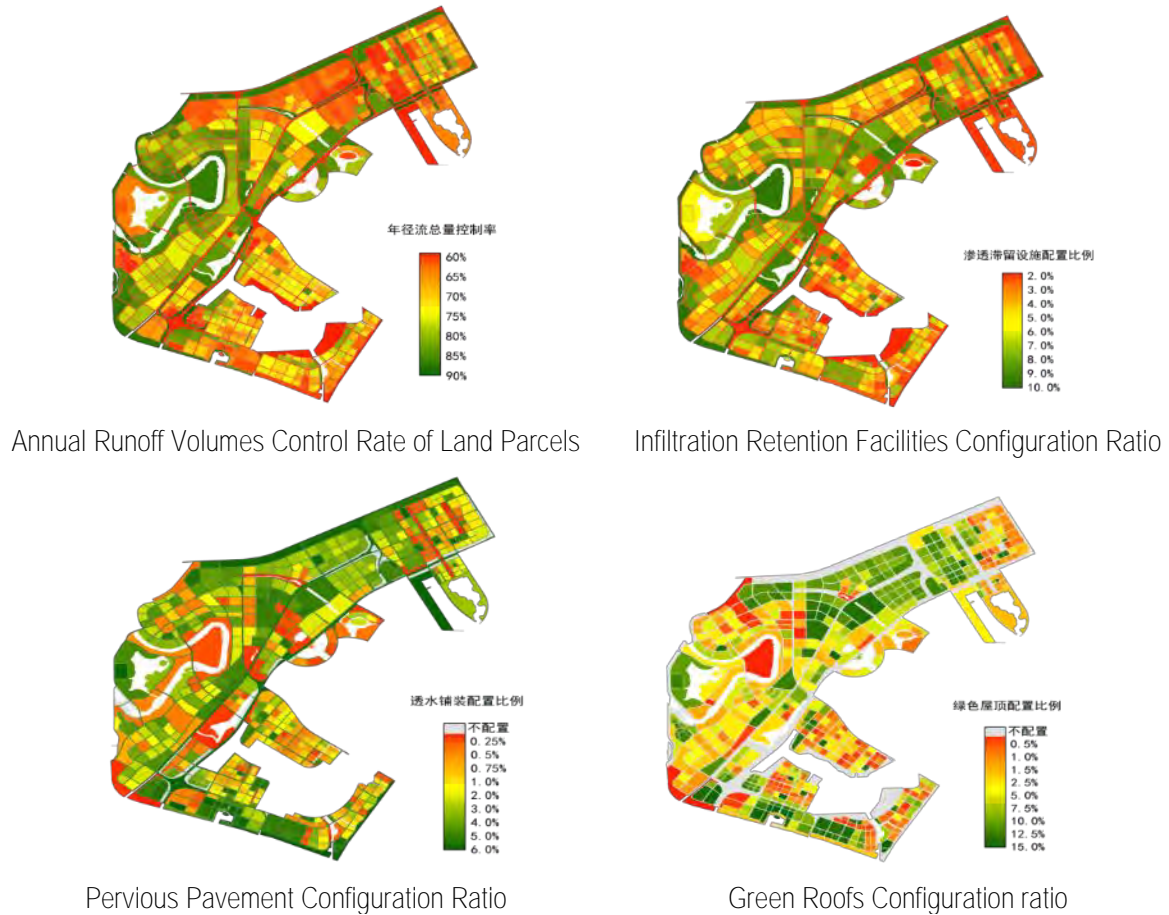

Figure 8: Control quota for different land use type

4. CONCLUSION

At the designed storm of 30.4 mm (control volume capture ratio of 80%), the LID facilities can significantly control the total runoff and peak value. However, in case of 24h 2-year and 30-year recurrence period rainfall, only adopting LID facilities does not exert significant effects on controlling the total runoff and the peak value. After adopting regional sponge city facility, the total runoff and its peak value are significantly reduced at the 24-h rainfall of 2-year and 30-year rainfall. Thus, the LID facilities is proposed as the main method for controlling the non-point source pollution in the Eco-city, and regional facilities is proposed in combination with the LID facility to control urban waterlogging.

LID facility should be chosen based on the situation of the project area. Attentions should be paid on following aspects during design and construction of LID facility for Tianjin Eco-city:

- Use soil with high permeability to increase water retaining capacity;
- Avoid secondary pollution during design and construction stage for LID facility, especially focus on the possible pollution brought by biological retention facility.
- Good regular maintenance is essential for ensuring the effect of LID facility.

The study results demonstrated that “sponge city” is a mental experiment with scientific solution for implement “sustainable neighbourhood”.

REFERENCES

- [1] Michael E. Dietz., 2007. Low Impact Development Practices: A Review of Current Research and Recommendations for Future Directions. *Water Air Soil Pollut*, 186:351-363
- [2] PRC. Ministry of Housing and Urban-Rural Development, October 2014, *Sponge City Design Technical Guideline (Trial Version)*
- [3] **Prince George's County, Maryland Department of Environmental Resources, July 1999, Low-Impact Development Hydrologic Analysis**
- [4] United States Environmental Protection Agency, September 2009, *SUSTAIN- A Framework for Placement of Best anagement Practices in Urban Watersheds to Protect Water Quality*

Track 8: Innovative Processes and Methodologies to Transform SBE

Session 1.11: Processes, Design, Tools and Methodologies in SBE (1)

Does the Sequence Matter? - Investigating the Impact of the Order of Design Decisions on the Life Cycle Performance

Julia TSCHETWERTAK^a, Sven SCHNEIDER^b, Alexander HOLLBERG^c, Dirk DONATH^d, Jürgen RUTH^e

^a Bauhaus-University Weimar, Germany, julia.tschetwertak@uni-weimar.de

^b Bauhaus-University Weimar, Germany, sven.schneider@uni-weimar.de

^c Bauhaus-University Weimar, Germany, alexander.hollberg@uni-weimar.de

^d Bauhaus-University Weimar, Germany, donath@uni-weimar.de

^e Bauhaus-University Weimar, Germany, juergen.ruth@uni-weimar.de

ABSTRACT

Life Cycle Assessment (LCA) is increasingly gaining importance in regards to building sustainability evaluation. Life Cycle Performance (LCP) describes the sum of all expenses for the production, operation and deconstruction in relation to the use and lifespan of a building. Considering LCP at the very early stages of the design process can have a significant impact on the overall LCP of the building. Thereby a multi-stage decision-making (MD) process allows the generation of a wide range of designs without eliminating the variants which seem to have comparatively low LCP in the beginning. Within this process all design variants are being developed until the final LCP calculation. By means of the MD tree, the planner can easily compare the different designs. This paper is questioning the order of the design stages used in the MD process for optimizing the LCP: Starting with the building volume and finishing with the construction type can be regarded as a typical sequence for arriving at a solution. But what consequences would a change of this order have? In practice planners can mix up the design order intuitively e.g. by having an idea for a specific construction type and start to develop the building volume based on that. In the following paper this process of switching the sequence of design stages is mimicked by a computational parametric tool. The aim is to investigate the impact of the stage order on the LCP and the geometry of building variants. Findings from the case study can be utilized in practice for the creation of generative tools based on MD processes.

Keywords: multi-stage decision-making process, Life Cycle Performance, design process, design automation

1. INTRODUCTION

Life Cycle Assessment (LCA) is increasingly gaining importance in regards to building sustainability evaluation, mostly in the form of building certification labels utilized in architectural practice. The application of LCA at a late stage of the design process to evaluate the environmental impact is not sufficient on its own if the results are not used to improve the design (Wittstock et al., 2009). The highest optimization potential lies within the early design stages where the decisions made have the biggest influence on energy demand (Hegger et al., 2007) and environmental impact (Schneider, 2011) while featuring the smallest costs for changes to the design (Paulson, 1976). However, in practice most fundamental decisions concerning the building geometry are made with little or no involvement of simulation software (Picco, 2014). Regarding the design process as a search process, where variants are generated, evaluated, selected and improved in an iterative manner (Newell & Simon, 1972) suggests the aid of computational tools to minimize the time for arriving at a solution. Referring to Rittel (1992), there are several methods to search for solutions: these range from a linear approach, where one single solution is produced in each design stage and no alternatives are created (Figure 1a); to a simplified multi-stage decision making approach, where for each stage of a design multiple variants are created, and the best one is developed further in the subsequent stages (Figure 1b); to a multi-stage decision-making (MD) process, where in each stage all design variants are considered (Figure 1c). The latter strategy generates a much higher number of designs than the other two methods what reduces the risk of missing out good solutions. Additionally, it holds the potential of discovering design variants which have comparatively worse performance in the early stages, although in combination with

aspects from the following stages, their performance can improve significantly. By means of the MD tree (Figure 1c), the planner can easily compare the different designs and decide which geometry to choose.

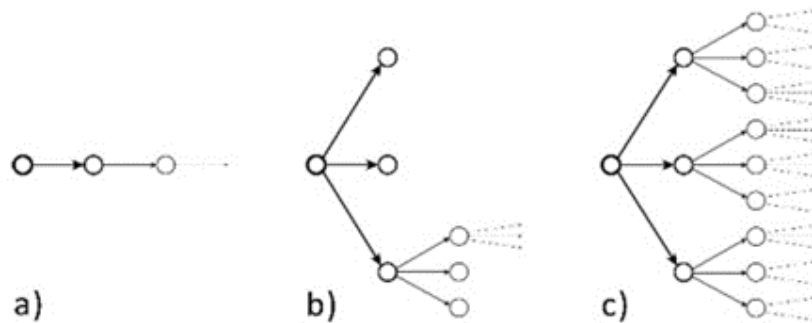

Figure 1: (a) Linear process (b) Simplified multi-stage decision-making process (c) Multi-stage decision-making (MD) process (Rittel, 1970)

The following paper is questioning the order of the design stages used in an MD process for finding optimized design variants according to the desired Life Cycle Performance (LCP). The LCP is a measure for the environmental performance of a building during the whole life cycle and in this context, it is used as an assessment value for the different designs. For arriving at a design solution it may seem logical to proceed from the general to the detail (Lawson, 2005), however, does that strategy lead to best solutions or is changing the sequence an option for achieving even better results?

2. METHODOLOGY

Is a computational tool which operates based on the MD process to be developed for the implementation in architectural practice, fundamental as well as detailed theoretical knowledge of this design process becomes necessary. In architectural theory, the topic of sequence, also referred to as stage order, in the MD process is widely unexplored. The following paper addresses this issue by means of a case study. For that matter, a parametric computational tool which is able to generate, analyze, optimize and visualize design variants in an MD tree has been programmed using the software Grasshopper3D (Rutten, 2015) for Rhinoceros3D.

Starting with the building volume plus the circulation core and concluding with the construction type can be regarded as a typical sequence for arriving at a solution. That stage order is the basis for the first MD process of the case study. Although, in practice planners can mix up the design order e.g. by having an idea concerning the construction type and develop the building volume from there. This sequence is the theory behind the second MD process explored in the case study. Both sequences are compared by regarding the design variants of the two resulting MD trees. That method should provide knowledge on the influence of stage order on the design outcomes in MD processes. Implementing those findings in future MD processes can lead to better designs with higher LCP values. The setup of the case study is explained in the following.

2.1 Parametric model generation

Generating numerous design variants in a short amount of time requires parametrically defined models which can easily be altered by changing the parameter values. In the following case study, two to four residential buildings are located on a rectangular site which is shaded at three sides. For study purposes the floor area ratio (FAR) is kept very low at 0.6, ensuring a high solution space (high FAR leads to geometrically fairly similar solutions). Each design variant has a total floor area of 2500m² which is divided into subareas for the individual buildings on the site. Minimum and maximum dimensions are set to ensure reasonable sizing of the building volumes. The buildings can have two to four floors and the glazing area is constantly 30% of the exterior wall area. Due to the parametric positioning of the buildings on the site it is likely that these initially intersect. Therefore, an algorithm, which resolves the intersections plus maintains a pre-set minimum distance between the buildings, has been developed. Additionally, building cores which include the main circulation spaces within the buildings are inserted. In order to enable natural lighting and ventilation, they solely can be positioned at exterior walls, preferably in shaded areas to keep the solar gains to the usable floor spaces. If a building exceeds a defined building size, further circulation cores are added. All of those model features are parametrically controlled and each combination of the parameter

values generates different design variants. The analysis starts automatically after the creation of every single design variant.

2.2 Building model analysis

2.2.1 Solar analysis

Solar radiation analysis is a fast way of evaluating the solar radiation on the building exterior considering shading from surrounding buildings for the time frame of one year. Visualized on the building façade, the results display to which extend the building is exposed to sunlight and indicate the potential amount of daylight in the interior.

2.2.2 Energy analysis

In order to quickly calculate the operational energy demand, we implemented a quasi-steady state method with monthly energy balances within Grasshopper. The implemented algorithms are based on DIN V 18599-2:2011 (DIN, 2011) and have been verified in Lichtenheld et al. (2015). The developed parametric energy calculation tool is able to provide results in real time (< 0.1s).

2.2.3 LCP analysis

In this paper, a previously developed parametric Life Cycle Assessment method (PLCA) is used (Hollberg & Ruth, 2016). Based on the 3D model generated in Grasshopper, the surface areas are extracted to automatically establish a bill of quantities needed for the calculation of embodied energy and environmental impacts (life cycle modules A1-A3, C and D). The environmental indicators for the individual materials are taken from ökobau.dat (BBSR, 2011) which complies with EN 15804 (CEN/TC 350, 2012). For the calculation of the LCP, we used the weighting process included in the DGNB certification. The procedure is explained in Hollberg et al. (2016).

2.3 Optimization process

Optimization serves the finding of design variants according to a design goal, which in this case study is the maximal LCP. These optimization processes operate based on evolutionary Algorithms (Rechenberg, 1994) conducted by Galapagos (Rutten, 2011) which is an inbuilt component in Grasshopper.

For starting an optimization, a parametric model, an assessment formula called the fitness and a fitness goal are required. The optimization of the first stage in the first MD process aims to find the best sizing of the building volumes, their location on the site plus the position of the cores at the exterior walls of the buildings. Here the fitness takes into account multiple performance criteria such as the average building surface area to volume ratio (S/V), the average solar radiation of the façade and the average shading value of the cores. The latter describes the difference of the solar radiation actually reaching the cores to the desired shaded condition and is purely based on an assumption of the authors. According to this assumption, the LCP might increase by arranging the buildings in a shorter distance to each other to create small but highly shaded areas on the façades. In those areas the circulation cores should be placed. Since the areas of the exterior walls where the cores are attached are excluded from the average solar radiation value of the façades, this value might increase what leads to a higher LCP. This assumption represents ideas that planners may have for improving the design. After all performance criteria are defined, their values are remapped to a domain which goes from 0 to 1 to ensure that all values stay in the same number range for them to have approximately equal impact on the fitness. In the following mathematical equation those performance criteria are combined:

Fitness = average S/V – average solar radiation + average shading factor.

The goal of this fitness is minimization and it expresses, that the average S/V as well as the average shading factor aim for minimization, whereas the average solar radiation should be increased. In the second stage of the first sequence, the resulting optimized design variant is combined with six different construction types and accordingly six LCP values are calculated.

In contrast, for the optimization in the second MD process where the construction types are defined in the first stage and the volumes plus cores in the following, the fitness is the LCP itself which should be maximized.

3. RESULTS

As the first MD tree displays, for each configuration of two, three and four buildings, three variants for building volumes plus cores are generated by means of optimization (Figure 2, left). The fitness used for the optimizations in the first stage of sequence 1 considers the average S/V of the building, the average solar radiation on the façade and the average shading value of the cores. It is not possible to take the LCP as the fitness at that point because one more stage is following which holds multiple aspects, in this case the six pre-selected construction types. Determining the construction type is essential for the LCP calculation. Since the construction types are only included in the second stage of this sequence, defining a custom fitness equation for the optimization in the first stage becomes inevitably.

Regarding the LCP values for the different construction types, a repeating pattern becomes apparent. For every design variant the order of the LCP from best to worst is the same, which indicates, that every single construction type has a specific influence on the LCP. For example, the worst LCP comes with the concrete construction and the best with the wood construction type. For enabling a better comparison between the different design variants, distances from each building to the closest building nearby are calculated. The average distance for every individual design variant is assigned. The overall average distance of all designs in the first MD tree is 4.52m, which means that most of the buildings are positioned relatively close to each other.

In the second MD tree the order of generating the volumes plus cores and applying the construction types is switched around. Hence, the first stage in that MD tree includes the six construction types (Figure 2, right). From there in stage two, for each construction type three design variants are generated with two, three and four buildings. Since no more stages with multiple aspects are following, the fitness for the optimization of the volumes plus cores in the second stage is the LCP, which needs to be maximized. The LCP values of the second MD tree show the same pattern as described for the first MD tree. Comparing the two MD trees reveals that the LCP values are quite similar with a slight deviation from 0.7% to a maximum of 6.2%. In 83% of the calculations the second MD tree delivered the best LCP. The average distance of all design variants is roughly doubled with 10.27m.

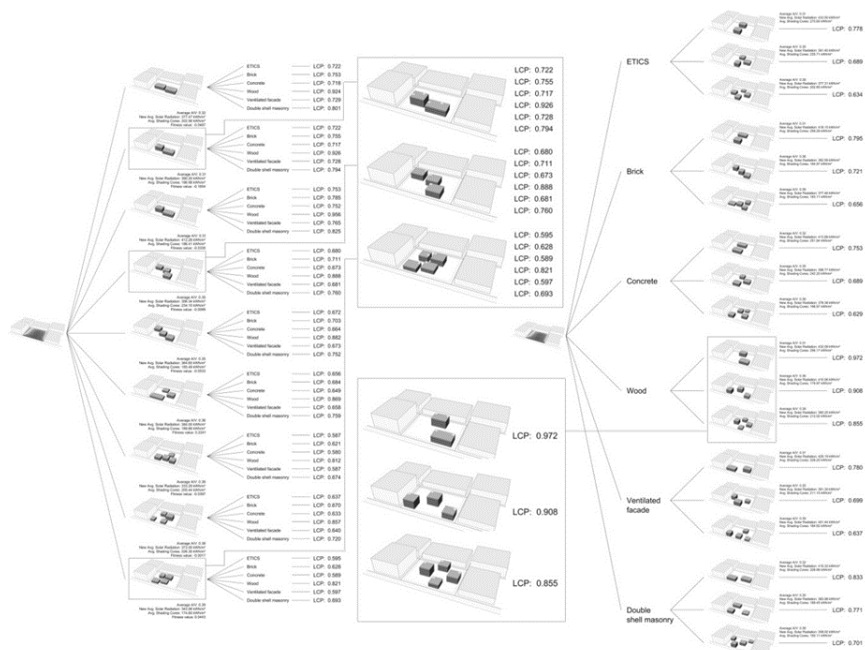

Figure 2: First MD tree (left), second MD tree (right), for each tree three variants are enlarged for readability.

4. DISCUSSION

From the results of the case study it can be concluded, that sequence has an influence on the resulting LCP and on the geometries of the design variants. However, the pattern amongst the LCP values reasoning in the influence of the different properties of each individual construction type is constantly the same for both MD trees. That shows, that the pattern-like behaviour of the LCP is not connected to the stage order. Although both, the first and the second MD tree deliver similar LCP results, there is a deviation of a maximum of 6.2% in the LCP values. In 83% of the cases, the best LCP results come from sequence 2, where first the construction type is determined and from there the volumes plus cores are developed. The reason for that, are the different fitness equations used for optimization in the two sequences (due to the missing construction types in the first stage of sequence 1). The fitness of the first stage in sequence 1 combines the three seemingly main performance criteria which influence the LCP. Those are the average S/V, the average solar radiation on the façade and the average shading value of the cores. Maintaining the number ranges of all performance criteria without scaling them to the range of 0 to 1 could result in an overly dominant influence of the criterion with the highest number range. In contrast, the one with the smallest number range would have relatively low impact. Therefore, all three performance criteria got assigned **an equal influence on the fitness based on the planner's own judgement**. Assigning appropriate weighting to each performance criterion is a difficult task. The weighting is indicating to which extent the LCP is influenced by the different performance criteria, but this information is mostly unavailable. Therefore, the planner has to not only decide which performance criteria to include in the fitness equation but also which weighting to apply.

In contrast, the weighting in the second fitness which is the LCP itself, is different. That influence is reflected by the average building distance of both sequences. In sequence 1, the buildings have an average distance of 4.52 m, which means they are located relatively close to each other. This is the consequence of the high influence of the average shading value of the cores on the fitness equation. For achieving a certain amount of shading for the cores at some parts of the building façades, the optimization algorithm creates shaded areas by arranging the buildings close to each other. That however, results in a lower average solar radiation on the building façades which leads to worse LCP values in comparison to sequence 2. It can be concluded, that the custom fitness **equation was not completely appropriate in regards to the final goal of achieving maximal LCP**. The author's assumption of improving the design outcomes by including an average shading value of the cores in the fitness equation was proven wrong and should be excluded from the fitness.

In contrast to sequence 1, the average building distance of 10.27 m of sequence 2 is resulting from the LCP as the fitness. For maximizing the LCP, the optimization algorithm is aiming for the maximum solar radiation on the building facades. This leads to the minimization of shading by arranging the buildings relatively far apart. The LCP values of sequence 2 were higher than of sequence 1 because the most efficient way of establishing a fitness equation is to take directly the final assessment method as the fitness which was the LCP in this case study.

The case study proves that it is of importance to pay special attention to the fitness equation and to the weighting used for optimization. It can be concluded, that the optimization delivers best results when the fitness is oriented towards the final assessment method as much as possible. That means, the performance criteria included in the fitness equation plus their weighting should have a similar influence on the final result (LCP) as on the fitness. An even better option is to take the final result as the fitness, which was the case in the second sequence. For that reason, the order of the second MD process was more effective in finding optimized design variants in regards to the LCP.

5. CONCLUSION

As the case study shows, the sequence matters when it comes to MD processes. Highly dependent on the stage order, the fitness for optimizations has a major influence on the resulting design variants as well as on the final assessment value. Best optimization results can be achieved by applying the least possible amount of different fitness equations in one sequence and by using the design goal as the fitness. Findings from the case study can be regarded as theoretical background for the creation of generative tools based on MD processes. By means of MD trees planners can get a better understanding of how different construction types influence the LCP as well as the geometry of the design variants. MD trees can help designers to explore a wide range of designs according to the desired performance and choose one for further development. The processes can be programmed to function

highly automated, what minimizes the calculation time and makes it more likely to be applied in architectural practice.

REFERENCES

- [1] BBSR, 2011. ökobau.dat. Available at: <http://www.oekobaudat.de/archiv/oekobaudat-2011.html> [Accessed December 12, 2015].
- [2] CEN/TC 350, 2012. EN 15804 Sustainability of construction works. - Environmental product declaration - Core rules for the product category of construction products.
- [3] DIN, 2011. DIN V 18599-2:2011 Energetische Bewertung von Gebäuden - Berechnung des Nutz-, End- und Primärenergiebedarfs für Heizung, Kühlung, Lüftung, Trinkwasser und Beleuchtung - Teil 2: Nutzenergiebedarf für Heizen und Kühlen von Gebäudezonen. , p.111.
- [4] Hegger, M., Fuchs, M., Stark, T. and Zeumer, M., 2007. Energie Atlas: Nachhaltige Architektur. Birkhäuser
- [5] Hollberg, A. & Ruth, J., 2016. LCA in architectural design—a parametric approach. The International Journal of Life Cycle Assessment, 21(7), pp.943–960. Available at: <http://link.springer.com/10.1007/s11367-016-1065-1>.
- [6] Hollberg, A. et al., 2016. A Method for Evaluating the Environmental Life Cycle Potential of Building Geometry. In Sustainable Built Environment (SBE) regional conference. Zurich, Switzerland.
- [7] ISO, 2009. DIN EN ISO 14040:2009 Umweltmanagement – Ökobilanz – Grundsätze und Rahmenbedingungen (ISO).
- [8] **Kägi, T. et al., 2016. Session “Midpoint, endpoint or single score for decision-making?”—SETAC Europe 25th Annual Meeting, May 5th, 2015. The International Journal of Life Cycle Assessment, 21(1), pp.129–132.**
- [9] Lawson, B., 2005. How Designers Think – The Design Process Demystified. 4th Edition, Architectural Press, Oxford.
- [10] Lichtenheld, T., Hollberg, A. & Klüber, N., 2015. Echtzeitenergieanalyse für den parametrischen Gebäudeentwurf. In Bauphysiktage Kaiserslautern. Kaiserslautern: Technische Universität Kaiserslautern.
- [11] Newell, A. and Simon, H. A., 1972. Human problem solving. Prentice-Hall
- [12] Paulson Jr., B. C., 1976. Designing to Reduce Construction Costs. J. Constr., vol. 102, no. 4
- [13] Picco, M., Lollini, R. and Marengo, M., 2014. Towards energy performance evaluation in early stage building design: A simplification methodology for commercial building models. Energy Build., vol. 76
- [14] Rechenberg, I., 1994. Evolutionsstrategie '94. Frommann Holzboog.
- [15] Rittel, H. W. J., 1992. Planen Entwerfen Design. Ausgewählte Schriften zu Theorie und Methodik. Stuttgart: W. Kohlhammer GmbH.
- [16] Rutten, D., 2011, Evolutionary Principles applied to Problem Solving using Galapagos [online]. Retrieved from: <http://www.grasshopper3d.com/profiles/blogs/evolutionary-principles> [Retrieved on 27 September 2016].
- [17] Rutten, D., 2015, Grasshopper3D [online]. Retrieved from: <http://www.grasshopper3d.com> [Retrieved on 11 November 2015].
- [18] Schneider, C., 2011. Steuerung der Nachhaltigkeit im Planungs- und Realisierungsprozess von Büro- und Verwaltungsgebäuden.
- [19] Wittstock, B., Albrecht, S., Makishi Colodel, C., Lindner, J. P., Hauser, G. and Sedlbauer, K., 2009. **Gebäude aus Lebenszyklusperspektive – Ökobilanzen im Bauwesen. Bauphysik, vol. 31**

Rethinking Architectural Passive Cooling Strategies in New Zealand's Non-residential Building Stock

Lesley METIBOGUN^a, George BAIRD^b

^a School of Architecture, Victoria University of Wellington, New Zealand, lesley.metibogun@vuw.ac.nz

^b School of Architecture, Victoria University of Wellington, New Zealand, george.baird@vuw.ac.nz

ABSTRACT

Whereas traditional building designs successfully integrated passive cooling strategies, current non-residential buildings have become dependent on mechanical cooling to achieve thermal comfort. The aim of this study is to demonstrate that with appropriate design input passive methods of cooling can be successfully incorporated into non-residential buildings. Following a brief outline of how our dependence on mechanical cooling has spread over the full range of building types and climatic zones, the focus of this paper is on non-residential buildings in temperate climates where passive cooling should be feasible in principle. It was found that current design policies, regulations and guidelines and current building design practices militate against their use. Perceived association with prestige, inflexibility of design processes, rigid planning regulations and sustainability rating systems were identified as key factors forcing the need for mechanical cooling. Recommendations are made on how to further encourage development in this direction from the perspective of architectural design.

Keywords: climatic responsive architecture, passive cooling, non-residential buildings

1. INTRODUCTION

New Zealand's non-residential building stock was estimated at 41,154 with a total floor area of 39.9 million m² (Cory, 2016). The non-residential building stock is divided into five size ranges, namely; size S1, S2, S3, S4, and S5 with a minimum floor area of 5 m², 650 m², 1500 m², 3500 m², and 9000 m² respectively. It is interesting to note that the building size S4 and S5 are large and they are mostly multi-storey buildings with percentage of buildings at 4% and 1% respectively. Small buildings, S1, S2, and S3 amount to 80% of the stock. The non-residential building stock is classified into three building use types namely; commercial office, retail, and others. Cory (2016) found that air conditioning was present in large commercial buildings (mainly office buildings). Despite the development of sustainable building design strategies with the potential to avoid overheating risk, the unnecessary use of air conditioning is escalating in non-residential building stock. The use of air conditioning in the non-residential buildings has become a norm in New Zealand (NZ) due to poor architectural design (Budin & Leardini, 2015). It is also evident that some of the current design practices and guidelines militate against the implementation of architectural passive cooling strategies which could alleviate the potential for overheating (Byrd, 2012).

Lenoir et al. (2012, pp157) **stressed that "thermal comfort can be achieved in public buildings without air conditioning"**. How has the human race survived for millions of years without air conditioning, but suddenly cannot live without it? Is it so difficult to design without air conditioning? The following paper includes a brief description of the trend towards dependence on mechanical cooling; the impact of the energy crises; the changing climate and sustainable building strategies; the relationship between current practices and the institutional drivers and the use of air conditioning; and studies on retrofitting non-residential building for passive cooling. This study aims to understand the trend towards the dependence on mechanical cooling and current design practices and regulations that have encouraged the spread of air conditioning specifically for temperate climates within the practical context of NZ non-residential building stock.

2. THE TREND TOWARDS DEPENDENCE ON MECHANICAL COOLING

Prior to the 1900s, non-residential buildings utilised passive design strategies, enabling solar penetration into the building in winter and shading to prevent it during the summertime (Arnold, 1999). Generally speaking, buildings were designed to adapt to the climate with minimal impact on the environment (Donn & Cresswell-Wells, 2014). Passive design strategies require little increase in building cost without any additional running cost. However, while passive design strategies have both economic and environmental benefits, they have perceived limitations. Between 1900 and 1920, there was a gap in research into passive design strategies (Gokarakonda & Kumar, 2016)

leading to their gradual neglect with the result that overheating became more common in buildings. This led to a worldwide growth of alternative means to solve overheating problems in non-residential buildings. The conventional solution to overheating was the installation of air conditioning (Yu et al., 2009) and this resulted in a high market drive for air conditioners (Balaras et al., 2007).

The modern air conditioning was invented by Carrier in 1920. It was primarily aimed at controlling internal temperature (Arnold, 1999). It was first applied to Abraham and Straus city departmental store in Brooklyn, New York, USA. However, the first entirely air conditioned building was the Millam High-rise Building in 1928. It was also installed for the senate and house chamber of the US Capitol, Washington, DC, in 1928 which eventually became the largest cooling system serving offices with a capacity totaling, 4800tr (16800KW). Air conditioning was **installed in the UK in 1928 in Lloyd's Bank. As of 1961**, only five buildings were installed with air conditioning in London; but by the 1990s, about 80% of newly constructed office buildings were air conditioned. Currently, virtually all new office buildings have air conditioning installed (Roaf, 2015).

The use of air conditioning altered architecture and paved way for buildings to be designed without consideration for the natural environment. It displaced the need for natural ventilation and permitted building designers to ignore solar protection in hot weather (Givoni, 1998a). Despite increased use of air conditioning in the building industry, there was no significant issue with energy cost as electricity was cheap. A consequence of this is buildings became dependent on an uninterrupted supply of electricity since, without air-conditioning, they cannot operate (Byrd & Leardini, 2011).

3. ENERGY CRISES, CHANGING CLIMATE, AND SUSTAINABLE BUILDING STRATEGIES

Following the energy crises of the 1970s, governments crafted legislation that would decrease their reliance on diminishing energy sources (International Energy Agency (IEA) 2007). In addition, the spread of air conditioning has led to power cuts (Herring & Roy 2007) and increased electricity prices (Balaras et al., 2007). For example, in Australia in 2011, for every \$1500 spent on air-conditioning, \$7000 had to be spent on improving the electrical infrastructure (Fanning, 2012). Almost 20% of electricity consumption in U.S. homes goes to air conditioning, as much as the entire continent of Africa uses for all purposes (Cox, 2012). Electricity generated from fossil energies such as coal, oil, and gas, or from uranium, will inevitably decline in time. But before the disappearance of these resources, galloping inflation, due mainly to the scarcity of these fuels, will make their purchase at reasonable prices impossible and results in air conditioning systems becoming too expensive to operate.

The Intergovernmental Panel on Climate Change (IPCC) projected that by 2100, there would be an increase in the average earth surface temperature of between 1.4 and 5.8°C (Hallegatte, 2009). Furthermore, the reality of climate change and its associated negative impact on the built environment (Guan, 2009) has made the need for adaptive measures obvious. Climate change is expected to further exacerbate the risk of overheating in buildings (Crawley, 2008). As a response, sustainable building initiatives were developed to enhance the environmental quality of buildings by reducing their negative impacts on the natural environment (Buckman et al., 2014). The first building suitability rating tool, the Building Research Establishment Environmental Assessment Method BREEAM was **developed in the United Kingdom in 1990 and the New Zealand's version, Green Star was launched in 2007 (Prins, 2015)**. Budin & Leardini (2015) in a study of the performance of Green Star rated office buildings in New Zealand, reported that naturally ventilated buildings in New Zealand overheat while over 90% of Green Star certified buildings in the Auckland region are air conditioned. This seems completely contradictory to the concept of sustainable building. A sustainable building should be “self- **sufficient**” and **must aim at optimising the use of natural ventilation, wind and daylight and avoiding too much summer heat penetration into the building, to save energy consumption and enhance occupants' comfort** (Givoni, 1998b).

4. RELATIONSHIP BETWEEN CURRENT PRACTICES, INSTITUTIONAL DRIVERS AND THE USE OF AIR CONDITIONING

Most of the award winning NZ non-residential buildings, even certified Green Star buildings, are fully glazed (Byrd, 2012). A typical example is the School of Business at the University of Auckland. The building is fully glazed without any means of natural ventilation. Although it is aesthetically pleasing, these kinds of buildings easily get overheated during the summer time (Byrd, 2010). It can be argued that prestige-architecture drives overheating in NZ. Modern architecture should be innovative in a way to mitigate the growing climate change challenge and not compound it.

The Green Star NZ (2016) recommends a 2.5 % daylight factor as the minimum daylight for an office building. It also specifies that 400 lux of light is adequate for visual work. This may have influenced over glazing of office buildings in NZ. Byrd & Hildon (1979) estimated that to achieve a 2.5 % daylight factor in a room of 7 metres in depth; it would require the window aperture to be 80% of the wall area. Considering glazing bars, sills and building structure, this would effectively require the entire external wall to be glazed. Also, the temperature range given by Green Star NZ for an air conditioned building is narrow while that of a naturally ventilated building is wide. Architects find it convenient to design with air conditioning to achieve this. No wonder air conditioning has become the choice of all architects designing green buildings in NZ (Budin & Leardini, 2015).

The NZ Property Council encourages air conditioning by awarding quality grading 'A', 'B', and 'C' to non-residential building based on the amount of air conditioning installed. The more air conditioning, the higher the grading with resulting higher rental value. This is consistent with Smith's (1999) claim that air conditioned office buildings are regarded as being of a high quality and attract a price premium. Why should architects bother designing for natural ventilation when the building will have a low rental value? "The New Zealand Institute of architects (NZIA) is also known to give awards, which should be based on performance, to buildings that self-evidently do not perform". They gave a 'sustainability' award in 2010 to a fully glazed office building without solar protection on the notion that the "significant environmental feature concerning its energy performance was that the building had been double-glazed: a mandatory requirement for a building that is fully glazed" (Byrd, 2016). If a building can be air conditioned, why bother with solar shading or good orientation? Is that a good thing for sustainable architecture?

Non-residential buildings have developed in many unsustainable directions over the years (Roaf et al., 2009) and while proffering expedient solutions, the unnecessary use of air conditioning has been a major contributor (Walker et al., 2014). While it is apparent that air conditioning offers a solution to overheating by controlling internal

temperature, the resulting health, environmental and economic challenges caused by this technology are worth rethinking. A working architectural cooling strategy to reduce the use of air conditioning in temperate climates where passive cooling should be feasible for long periods of mild outside temperature is needed. The next section reviews strategies that could achieve this aim.

5. RETROFITTING NON-RESIDENTIAL BUILDINGS FOR PASSIVE COOLING

75% of the floor area of the existing stock will soon require retrofit upgrading (Cory 2016). Since 2011, there are several on-going seismic retrofits of the non-residential building in NZ due to recent earthquake. Thompson (2015) suggests improving natural ventilation in buildings while seismic retrofit is on-going. Apart from energy saving potential, Camilleri et al. (2001) stated that there is an opportunity for reduction in greenhouse gas (GGH) emission.

The ways in which buildings are designed, constructed, upgraded, and occupied require a real change and these are **known as 'adaptation strategies'** (Barbhuiya et al., 2013). **There are many ways by which the construction industry and researchers can make buildings more energy efficient and reduce their green-house gas emissions in relation to climate change. These are referred to as "mitigation strategies" (Camilleri et al., 2001). Adaptation and mitigation strategies are complementary measures that can assist to effectively reduce overheating.** Barbhuiya et al., (2013) propose a passive design approach aiming at **minimising carbon emissions and improving occupants' comfort.** They suggested reducing internal heat gain, improving window performance, proper building orientation, and wall insulation.

In a NZ study, Camilleri et al., 2001 suggested adaptation and mitigation strategies but expressed the view that **"placing restrictions on window areas or prescribing shading or window treatment, might well be rejected by the design and construction sectors as being too restrictive and prescriptive, as they currently enjoy an almost unlimited reign in the form and aesthetics of their buildings.** At the extremes, anything from a windowless box, to a building with roof and walls made entirely of glass can (with sufficient care) be made to comply with the NZ Building Code" (Camilleri et al., 2001 pp 448). Similarly, a recent study conducted by Cory (2016) on the possibility of retrofitting the entire New Zealand non-residential building stock to be Net Zero Energy, recommended passive strategies, energy efficient and renewable strategies. His study demonstrates these retrofit solutions would be effective in reducing energy consumption and buildings would hardly require air conditioning under current climate conditions. The next section highlights the methodology employed in a recent case study.

6. RETROFITTING A PREVIOUSLY AIR CONDITIONED BUILDING FOR PASSIVE COOLLING – A RECENT CASE STUDY

The main methods for this case study were on-site physical observation and interviews with occupants. The aim was to investigate the design process employed and also to verify how the building actually performs in practice **through occupants' experience. Photography was used as a means for data collection (Groat & Wang, 2002). The data from the occupants' experience were then analysed using discourse analysis.** Discourse analysis is the study of social life, understood through analysis of

language in its widest sense (including face-to-face talk, non-verbal interaction, images, symbols, and documents (Potter & Wetherell, 1987).

6.1 Building description The 12-storey Aorangi House on 85 Molesworth Street, Wellington central business district was built in 1970 with a net lettable area of about 5,000 m². The building gradually became largely unoccupied due to ventilation, cooling, and heating problems. In terms of aesthetic, the building was no longer appealing, the environmental control systems was substandard as per performance. Structurally, it was unsafe for business activities as it was a risk to life and required a total refurbishment.

6.2 Integrated design approach

A team of architects and engineers was engaged by the building owner to work in collaboration in an integrated design process with the goal of developing a seismic upgrade of the existing building structure; critically tackle the problem of thermal discomfort by developing an improved thermal control strategy; explore the possibility of retrofitting the entire building to be naturally ventilated. After a series of coordination meetings between the design team members and the building owner, a passive design and seismic design upgrade, and other active technologies were developed. The following section describes how the passive design features were integrated into the existing building.



Figure 1: The East view showing the operable windows and overhangs used as solar shading

6.3 Passive design features

To allow for improved thermal modulation, the ceiling was left open but painted and about 40% acoustic panels laid on it. The aim was to better admit daylight into the building. The core areas were the only place covered with a suspended acoustic

ceiling. The building is largely naturally ventilated and cooled. This is made possible by utilizing both low and high-level window openings. These provide proper ventilation during winter. There is also night ventilation which assists in cooling the building during summer. Air conditioning was installed to assist in cooling should the internal temperature exceed 25°C especially during the summertime, but is rarely used. Glazing covers 33% of the total building wall area. External shading louvers were designed specifically for the north, east and west facades (see Figure 1). The concrete structure provides thermal mass which compliments passive heating and mitigates

overheating in summer. An external insulation (German-engineered sto-system) was applied to the external façade and covered with a 3-coat plaster.

6.4 Feedback from occupants

It was found that the building internal temperatures have been comfortable. On those few occasions when it exceeded 25°C during the 2015/ 2016 summer the air conditioning switched on automatically (Baird et al., 2011).

7. CONCLUSION AND RECOMMENDATION

Reducing the non-essential use of air conditioning by developing a passive cooling technology means non-residential buildings will become more energy efficient. This implies a significantly reduced demand for national **electricity. This will also complement government's target to make the nation carbon neutral and meet the international target of a 20% carbon reduction by 2020.** It is apparent that the NZ non-residential building stock is now at the risk of overheating. Further study that seeks to understand the current overheating risk and cooling requirement in a wide range of non-**residential buildings in NZ's climatic condition and offer an effective** solution to inform design decisions is essential. How these decisions should be implemented in government initiated policies and regulations to develop a more sustainable non-residential building stock and reduce the use of air conditioning in it, is highly recommended. As the challenges are not just peculiar to NZ, the potential application of the developed solutions should be investigated and evaluated for other temperate climates.

REFERENCES

- [1] Baird, G., Marriage, G., Masters, B. & Dykes, C., 2015. Aorangi house, Wellington - performance in practice of a refurbished office building. The Institution of Professional Engineers New Zealand, IPENZ Transactions, 1-10.
- [2] Balaras, C.A., Grossmanb, G., Henningc, H., Ferreirad, C. A., Podessere, E., Wangd, L. & Wiemken, E., 2007. Solar air conditioning in Europe-an overview. Renewable and Sustainable Energy Reviews, 11(2), 299–314.
- [3] Barbhuiya, S., Barbhuiya, S. & Nikraz, H., 2013. Adaptation to the future climate: A low carbon building design challenge. Procedia Engineering, 51(NUICONE 2012), 194–199.
- [4] Buckman, A. H., Mayfield, M. & Beck, S., 2014. What is a Smart Building? Smart and Sustainable Built Environment, 3(2), 92–109.
- [5] Budin, H. & Leardini, P.M., 2015. 'Actual performance of naturally ventilated and air-conditioned Green Star certified office buildings in New Zealand' paper presented at the 49th International Conference of the Architectural Science Association, Melbourne, Australia 1-4 December.
- [6] Byrd, H., 2016. Cooling NZ : institutional drivers behind the growth in air-conditioning. paper presented at the 46th International Conference of the Architectural Science Association, Queensland, November 2012.
- [7] Byrd, H., 2012. Post-occupancy evaluation of green buildings: the measured impact of over-glazing. Architectural Science Review, 55(3), 206–212.
- [8] Byrd, H. & Leardini, P., 2011. Green buildings: Issues for New Zealand. Procedia Engineering, 21(February), 481–488.
- [9] Byrd, H. & Hildon, A., 1979. Daylighting: appraisal at the early design stages. Lighting Research and Technology Vol. 11.No.2.
- [10] Camilleri, M., Jaques, R. & Isaacs, N., 2001. Impacts of climate change on building performance in New Zealand. Building Research & Information, 29(6), 440–450.
- [11] Cory, S., 2016. An Exploration of the Feasibility of Converting the New Zealand Commercial Building Stock to be Net Zero Energy. Thesis (PhD). Victoria University of Wellington.
- [12] Cox, S., (2013). "Losing Our Cool: Uncomfortable Truths About Our Air-Conditioned World (and Finding New Ways to Get Through the Summer)". The New Press. 1595586024, 9781595586025
- [13] Crawley, D.B., 2008. Estimating the impacts of climate change and urbanization on building performance. Journal of Building Performance Simulation, 1(2), 91–115.
- [14] Fanning, E., 2012. The Hidden Cost of Infinite Energy. The Global Mail Retrieved from <http://www.theglobalmail.org/feature/the-hidden-cost-of-infinite-energy-part-1/19/>
- [15] Givoni, B., 1998a. Climate considerations in building and urban design. Building, 241–300.

- [16] Givoni, B., 1998b. Effectiveness of mass and night ventilation in lowering the indoor daytime temperatures. Part I: 1993 experimental periods. *Energy and Buildings*, 28(1), 25–32.
- [17] Groat, L. & Wang D. 2002 *Architectural Research Method*. John Wiley and Sons: New York.
- [18] Gokarakonda, S. & Kumar, A., 2016. Passive Architectural Design Index applied to vernacular and passive buildings. *International Journal of Environmental Studies*, 73(4), 563–572.
- [19] Guan, L., 2009. Global Warming : Impact on Building Design and Performance. *Encyclopedia of Energy Engineering and Technology*, 774–779.
- [20] Hallegatte, S., 2009. Strategies to adapt to an uncertain climate change. *Global Environmental Change*, 19(2), 240–247.
- [21] Herring, H. & Roy, R., 2007. Technological innovation, energy efficient design and the rebound effect. *Technovation*, 27(4), 194–203.
- [22] IEA (International Energy Agency), 2007. Renewables for heating and cooling. *Technology*, 1–210.
- [23] Lenoir, A., Baird, G. & Garde, F., 2012. Post-occupancy evaluation and experimental feedback of a net zero-energy building in a tropical climate. *Architectural Science Review*, 55(3), 156–168.
- [24] Potter J. & Wetherell M. 1987. *Discourse and Social Psychology: Beyond Attitudes and Behaviour*. London: Sage
- [25] Prins, H., 2015. **Adapting to Constraints – a Study of Green Star New Zealand ’ s Effects on Decision Making Using Classic Grounded Theory** . Thesis (MSc). Victoria University of Wellington.
- [26] Roaf, S., Crichton, D. & Nicol, F., 2009. *Adapting Buildings and Cities for Climate Change - A 21st Century Survival Guide Second Edition*.
- [27] Roaf, S., Nicol, F. & Rijal, H., 2015. Designing for comfort at high temperatures. *Architectural Science Review*, 58(August), 35–38.
- [28] Smith, K. S., 1999, 'Social aspects of climate change and office building' Centre for research evaluation and social assessment (CRESA). Wellington.
- [29] Thompson, J., Donn, M. & Baird, G., 2016. 'Utilising Calibration to Quality Assure CFD Models for Predicting Thermal Comfort in Naturally Ventilated Buildings Designed for High Occupancies', paper presented at 9th Windsor Conference, Windsor, UK, 7-10 April.
- [30] **Walker, G., Shove, E. & Brown, S., 2014. How does air conditioning become “needed”? A case study of routes, rationales and dynamics. *Energy Research and Social Science*, 4(C), 1–9.**
- [31] Yua, B.F., Hua, Z.B., Liua, M., Yangb, H.L. Kongb, Q.X. & Liub, Y.H., 2009. Review of research on air-conditioning systems and indoor air quality control for human health. *International Journal of Refrigeration*, 32(1), 3–20.

Building in Existing Contexts – Densification

Paul FLOERKE^a

^a Department of Architectural Science, Ryerson University, Canada, paul.floerke@ryerson.ca

ABSTRACT

An important theme of applied research is the realization of climate adapted, energy efficient, and soundly constructed environments unfolding to an innovative architectural concept.

Existing buildings, especially certain building typologies are increasingly emphasized as themes. Quality criteria of buildings are much more difficult to capture and must be descriptive. Deciding on these will become a future challenge.

Research clearly shows, that dealing with buildings in existing contexts is considered a main focus. The densification of cities is an ongoing topic, which can be achieved without dissolving the embodied energy, which exists through the built environment. This is one major aspect. Another aspect at the same time being respected when activating existing structures is the reduction of necessary new energy – site management, used resources/ materials, actual construction etc. - for new buildings in identical locations, which often do not achieve higher quality architecture or comparably extended life cycles. Beyond this, the social culture value of existing structures has not been fully assessed. This is an underlying momentum for reconsidering architecture of the sixties and seventies. Roof-top extensions to existing structures is one way of adding to the densification using the potentials of the buildings while simultaneously refurbishing the envelope and considering reuse, recycling.

The approach is to work on areas that have been highly neglected. Architects often prefer to **focus on the „new building object“** and less on existing structures, especially those of eras, which are deemed unattractive but will be of high importance to the future architectural profession.

Keywords: densification, building typologies, potentials of existing buildings, modernity

1. INTRODUCTION

The Catalogue of Typologies – Rooftop Extensions has been developed in the context of the research project **„P845 Building in existing structures – potentials of lightweight steel constructions“**.

A total number of 108 out of 154 worldwide selected projects are presented in this catalogue, focusing on existing buildings in urban situations considering densification through extensions and additions.

Similarities between the 154 projects have been analyzed by implementing an abstract graphical method.

The further uniqueness of this publication is the interdisciplinary combination of architectural and engineering documents for precedents studies.

The comparison of schematic sketches led to 6 typologies to which all projects can be related:

- A Roof
- B Cube
- C Inserted
- D Free Form
- E Add On
- F Gap

Within the typology-categories A to F, the Catalogue of Typologies – Rooftop Extensions is structured as follows:

- Chapter 4 Introduction of project related Typologies
- Chapter 5 Project-related overview

- Chapter 6 Detailed presentation of selected projects

The objective of this catalogue is to identify general conditions according to the given information of every typology. This catalogue is to be understood as a manual for clients, planners and the building industry. The presented solutions can be transferred into different contexts and provide assistance to the decision-making process. The variety of solutions, specifically considering the urban context, show how existing potentials can be used for roof-top extensions, which contribute to the densification of cities.

(Please follow the link in references for a free download of the full English/ German version)

2. CASE STUDIES

2.1 Former IBM Building, hanover, lower saxony, Germany



Figure 1: Model photography, IBM-Building Hannover, 2012. Detlef Pödehl, Fotografenmeister, Technische Universität Dortmund.

Building in existing contexts has long been one of the most important architectural challenges in Germany. The building inventory is in a phase of over saturation in Germany.

We can only operate to preserve resources if we learn to appropriately and sensibly deal with the existing ones. In this context, post-war modernism raises one of the most increasingly important challenges - buildings constructed in the 1960's and '70's.

Whereas buildings completed in the 1950's are generally well accepted, an aversion exists towards modernist buildings. It appears that the contemporary generation of protagonists of architecture in Germany, whose fathers were the planners and builders of this period, are the opponents of the typical post war architectural canon.

These buildings are demolished without investigating their potential for utilization in planning and economics; if they are demolished, both the embodied gray energy and energy for demolition as well as the historical social-cultural value are all lost. Certainly, not all buildings of this period are significant, but many are. Structures that appear, on first glance, to be almost unsolvable offer, on second glance, the potential for new solutions, especially in the context of the densification of urban areas. In this context, avoiding construction and demolition waste is a priority. Only after considering this should waste management or possible rebuilding on the same site follow.

When a site is rebuilt, there is no guarantee of equal or higher architectural quality especially considering the calculation that an amortisation based on thirty years is necessary to maximize the investment return.

The less an existing building has to be modified, the less the energy that has to be implemented and the more the social and cultural value is raised.

The degree of intervention, specifically the degree of modification, constitutes the critical factor concerning the utilization of the existing building and the method of identifying and using **the building's full existing capacity**.

Embedded in this method lies a process of selection, which can be either a controlled or uncontrolled sequence of events. In addition to this, it is often vague as to who decides which value is to be sustained, which criteria are to be followed, and which particular criteria are to be emphasized. This is a complex process that eventually constitutes a decision over the existing building.

The above-mentioned context raises aspects for an approach towards a "theory of disappearance", which involves processes which make it impossible to reconstruct, and in which artefacts of historical movements disappear forever, especially when they are not leading the list of architectural favourites.



Figure 2: IBM-Building, Hannover, 2011. Detlef Podehl, Fotografenmeister, Technische Universität Dortmund.

Prof. Dieter Oesterlen's IBM-building in Hannover, Germany, built in the late 1960's, is representative of the 'Braunschweiger Schule' (Braunschweiger School of Architecture). Oesterlen, a renowned post-war architect, sensitively intervened in existing buildings and contexts of what had heavily destroyed Germany, and, specifically, what Hannover was confronted with.

It could be said that in the process of disappearance, there is an underlying form of catharsis in the destruction of things we prefer to forget. Often, reconstruction or preservation of buildings is done with the intention of **remembering and reminiscing**. Oesterlen's approach, as illustrated by the historical site development in Hannover, shows a not very well-recognized strategy of reconstructing the urban context of a pre-war situation. A school built in 1890 in the same location was so substantially damaged that had to be demolished even after several attempts to provisionally repair it. The school was located in the urban context among several multi-storey apartment buildings and could be read as an explicit differently designed volume. Oesterlen has a similar interpretation of the situation, while following a modernistic architectural expression (see historic maps below).

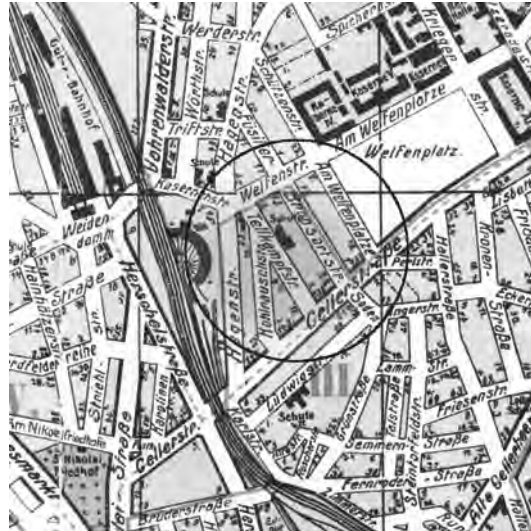

Figure 3: Historic maps, IBM-Building site, Hannover, 1914. Stadtarchiv Hannover, kpr Nr. 0966 Stadtplan Hannover, 1914 Mitte 00001.

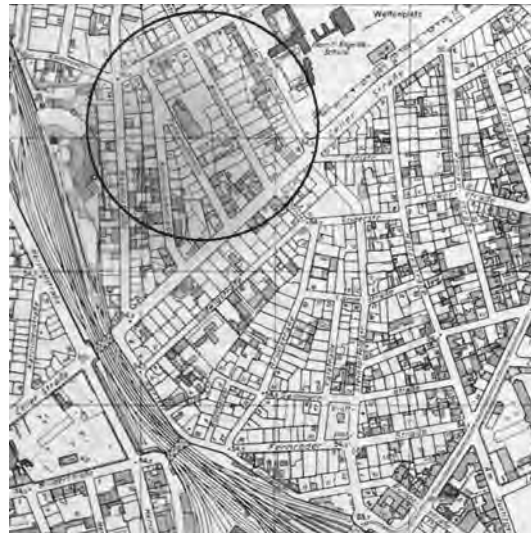

Figure 4: Historic maps, IBM-Building site, Hannover, 1954. Stadtarchiv Hannover, Dt. Grundkarte 1:5000 Blatt, Hannover 1954.

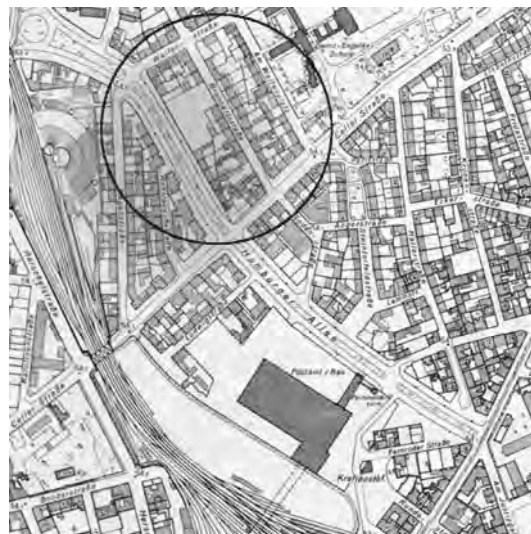

Figure 5: Historic maps, IBM-Building site, Hannover, 1961. Stadtarchiv Hannover, Dt. Grundkarte 1:5000 Blatt, Hannover 1961.

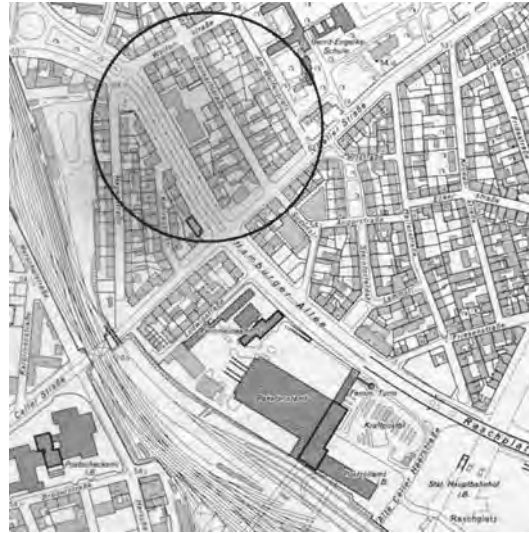

Figure 6: Historic maps, IBM-Building site, Hannover, 1971. Stadtarchiv Hannover, Dt. Grundkarte 1:5000 Blatt, Hannover 1971.

The IBM building cannot be seen as a disruptive building in an ensemble of residential buildings. As a modern office building of its time, it offers deep floor plans with multilayered grid structures, which coincided with the spatial program.

Even by today's standards, daylight simulations for the building clearly show a functional structure. The fixed sun louvers, after investigations of sunlight positioning, prove to be a sophisticated sun-screening device and cannot merely be regarded as a design-oriented application. This fixed sun-screening device is functional while simultaneously reflecting the building's expression.

Analysis of the floor plan types has shown the utilizable grids for different office typologies. Grid drawings and utilization are in accordance with the German government's criteria of building in existing contexts.

The actual measured existing potential of the primary steel reinforced concrete structure of the building would allow a 1 to 2-storey addition, provided it is executed in a light weight steel structure. However, the envelope design is not consistent with contemporary or future standards and would have to be in steel in order to maintain the narrow window framing profiles.

This building is a reflection of the context of the preservation of social and cultural values. The approach or process suggests a strategy for examining buildings of a similar type.

General assumptions and speculations concerning these building types, their architectural quality, their utilization possibilities, and feasibility studies alone do not go far enough. Only the explicit illumination of historical references, the inherent processes, and what can be evaluated as existing cultural inventory, as well as the explicit investigation of anticipated future uses can provide support in making decisions concerning conservation, modernization, or possible extensions to existing buildings. A modification is at its best when existing buildings in all of their facets and resources have been completely captured and understood.

2.2 University of Hamburg - Campus Von-Melle-Park (VMP), Hamburg (Germany)

The development of university campuses in Germany found its climax in the sixties and seventies. The architecture conceived during this period left its imprint as the architecture of the booming years of economy. This period often created university satellite campuses on the fringe of the cities.

Universities located in the down town core could only be implemented, if post-war vacated lots were made available.

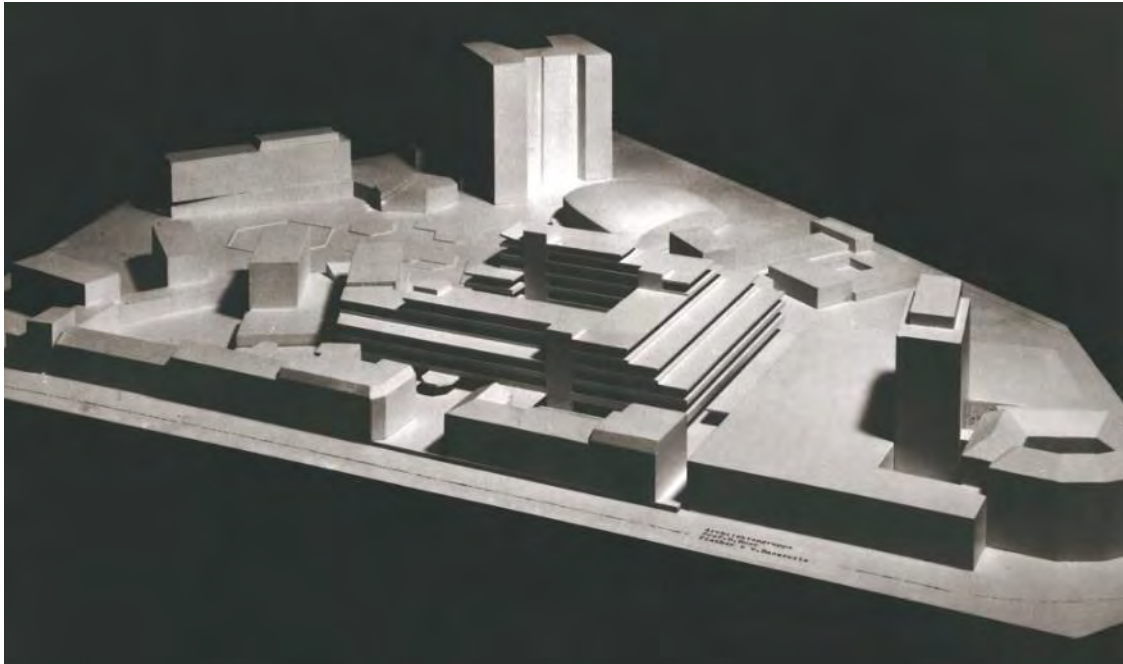

Figure 7: Model, Campus Von-Melle-Park, University of Hamburg, 1971. from: Architektengemeinschaft WIWI II. Hoor, Prof. D., Geelhaar, K., Fischer, C.F., v. Bassew, H. (1971): Erweiterungsbäude des Fachbereichs Wirtschaftswissenschaften der Universität Hamburg. Planunterlagen als Anlage zur Leistungsbeschreibung, cover.

The development of the main campus for the University of Hamburg began in the late 1950's according to the plans of the architect and urban planner Paul Seitz, who was the first director of the city planning division for the City of Hamburg from 1953-1963. Paul Seitz planned two of the existing buildings:

The Philosophy tower (Philosophenturm/ VMP6 (1959-91)) and the Paedagogy Institute (Pädagogisches Institut/VMP8 (1957-60)).

The university campus is characterized by a loose accumulation of individually designed buildings for separate institutes. The concept of the campus was to be comparable to the values of a democratic and pluralistic educational system.



Figure 8: Maps of existing situation and new building of VMP5, 1971. from: Architektengemeinschaft WIWI II. Hoor, Prof. D., Geelhaar, K., Fischer, C.F., v. Bassew, H. (1971): Erweiterungsbäude des Fachbereichs Wirtschaftswissenschaften der Universität Hamburg. Planunterlagen als Anlage zur Leistungsbeschreibung, page 3.

The building ensemble of the university campus was extended in the early seventies. Von-Melle-Park 5 was planned as an extension to the Faculty of Economics and executed ready for occupancy by an architects association for the University of Hamburg.

SIEMENS using prefabricated concrete components completed the building in 1975.



Figure 9: Mapping of listed university buildings, Hamburg, 2016. www.geoportal-hamburg.de/Geoportal/geo-online/index.html (Stand 19.03.2016).

The entire university campus is under ensemble protection (see light-red coloured areas in Figure 3). All buildings are protected historic heritage (see dark-red coloured buildings). Exceptions to this are only the building VMP5 as well as the areas of the university library.

The Hamburg Ministry of Culture Office for the Protection of Historic Buildings will soon be establishing guidelines for the refurbishment process of the existing buildings.

In preliminary discussion with the Culture Office main objectives for the future refurbishment plans were determined. Maintaining materials, building volumes and nuances of colouring are of paramount concern. All interventions or modernizations should respect the principle of identifying the year the building was built this way referencing its cultural context. At the same time the buildings must adhere to the current requirements of energy efficiency.

For every required construction project in the existing context, the decision between conservation of the ensemble and the improvement of the building performance becomes a balancing act.

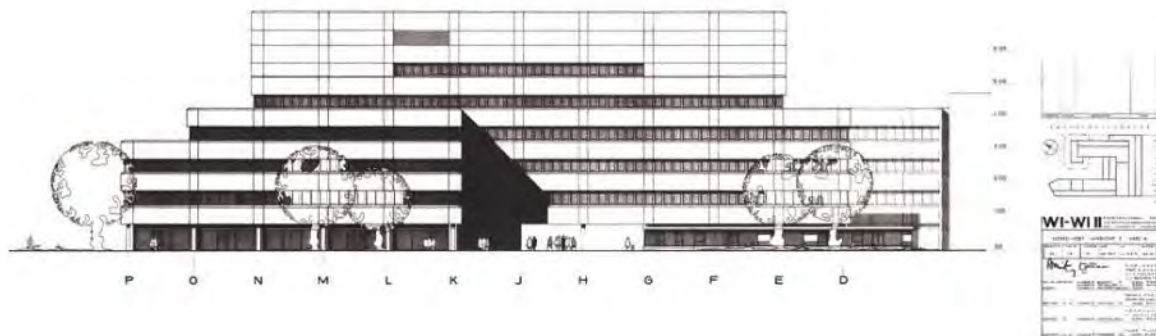

Figure 10: Northeast elevation, Von-Melle-Park 5, 1971. from: *Architektengemeinschaft WIWI II. Hoor, Prof. D., Geelhaar, K., Fischer, C.F., v. Bassew, H. (1971): Erweiterungsgebäude des Fachbereichs Wirtschaftswissenschaften der Universität Hamburg. Planunterlagen als Anlage zur Leistungsbeschreibung, page 15.*

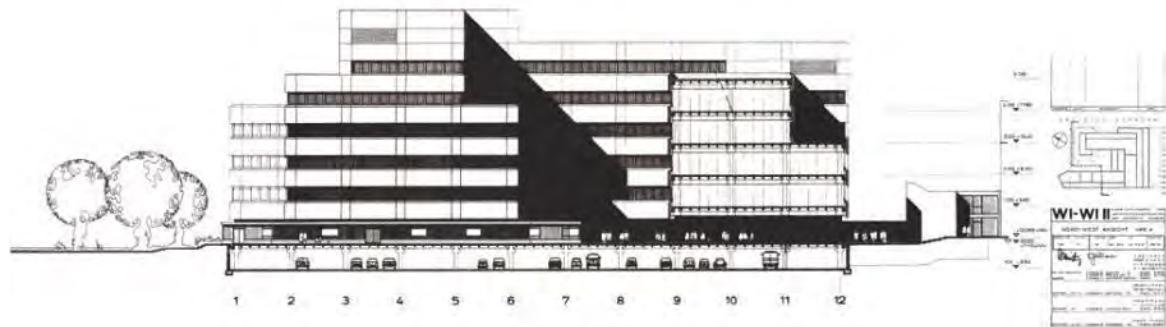

Figure 11: Northwest elevation, Von-Melle-Park 5, 1971. from: *Architektengemeinschaft WIWI II*. Hoor, Prof. D., Geelhaar, K., Fischer, C.F., v. Bassew, H. (1971): *Erweiterungsgebäude des Fachbereichs Wirtschaftswissenschaften der Universität Hamburg. Planunterlagen als Anlage zur Leistungsbeschreibung*, page 14.

Refurbishing buildings of the seventies demands, besides renewing the mechanical systems also updating to the existing fire codes, removing contaminated materials as well as improving the building envelope. After 40 years the existing envelope is in need of an upgrade. The facade consists of concrete sandwich panels and framed sliding windows with aluminum profiles. The concrete, or the exterior was exposed to harsh weather conditions and has been subject to heavy corrosion. All windows are leaky and are difficult to operate including the sun shading devices.

A refurbishment concept was developed by the architects PASD-Feldmeier Wrede (Germany), in respect to the architecture of the building as a protected ensemble.



Figure 12: Photography of north façade corner, Von-Melle-Park 5, 2016. *PASD Architekten. Feldmeier | Wrede*. Photography taken by Maria Tumanovska, 02/2016.

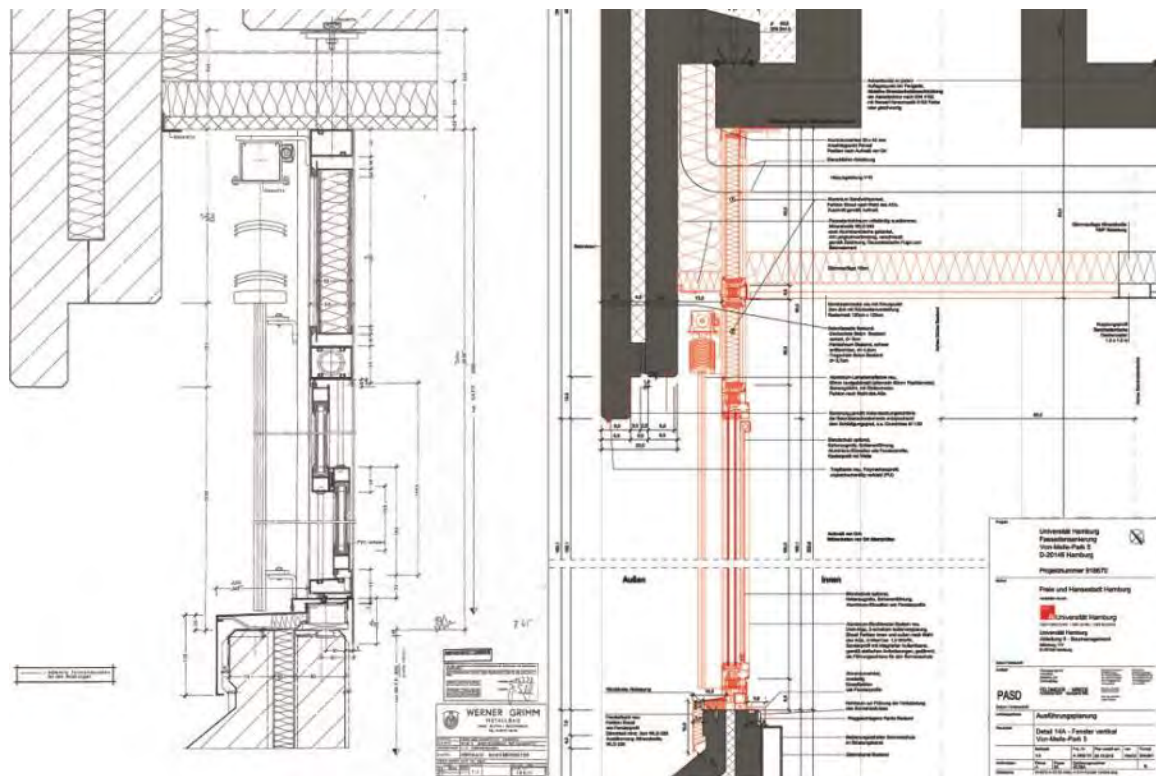

Figure 13: Vertical window section, built situation and refurbishment. *Werkplanung 1971: Werner Grimm Metallbau Eutin. Ausschnitt*
Werkplanung 2016: PASD Architekten. Feldmeier & Wrede

The sliding aluminum windows were installed in the early seventies. These windows provide no thermal separation but were assembled with insulated double-glazing.

To bridge the structural height of 2.60 m, hollow section columns were mounted according to the secondary grid of 1.20 m. The hollow columns are used to attach the window elements vertically. All window constructions end at 2.60 m, aligned with the edge of the dropped ceiling, which runs further above the framed windows into the exterior of the facade. This void is also used to accommodate pipes for the heating system, which lead behind the prefabricated panels to the floors above.

Remaining inoperable for years are the sun-shading devices, which was to be centrally monitored and controlled by the South facing elevation.

In the frame of the obligatory analysis of the existing building, the commissioned replacement of the windows evolved into an extensive issue. The refurbishment plans include a vapour tight window construction aligned with the insulation of the exterior wall element. To compensate for the dewpoint at the bottom of the window, the windows will be insulated.

Integrating a structural pilaster strip will strengthen the window frames. These pilasters can also be utilized for the subsequent assembly of the sun-shading device. Window elements will be realized with aluminum framing in an anodised coloured tone modelled after the existing facade.

The dropped ceiling will be reduced according to the depth of the room, replacing the insulation material. Penetrating heating pipes through the sandwich panels will be sealed and taped airtight. To prevent condensation, the voids in the facade will be filled with additional insulation. The envelope facing south will be installed with a sun-shading device, which can be individually controlled by the users.

A dismantling of contaminated building materials will be undertaken during the course of the refurbishment of the windows. Applied asbestos plates as well as batten insulation will be removed. Asbestos cords, which were inserted to the points of support, will be coated with a bonding paint.

To maintain the appearance of the facade, the concrete panels will be cleansed and damaged spots repaired. The drainage line on the panels will be re-profiled. The concrete panels will be coated with a water repellent in the final process. All seals will be substituted with current compression tape along the joints and seams.



Figure 14: Visualisation of north façade corner, Von-Melle-Park 5, 2016. PASD Architekten. Feldmeier • Wrede. Visualisation made by Mariia Tumanovsk

3. CONCLUSION

The three chapters of this paper give a coherent detailed view on the discourse around buildings in existing contexts. Not only giving a view on the hidden potentials in the built environment for densification through extensions, primarily to the roof-top, but also a view on individual buildings. As case studies they deliver important strategies of approaching this area of concern towards renewable existing urban environments, which may be transferred to similar contexts.

Only through initial analysis, which delivers a deep understanding of the building in its object character and assessment of its social cultural and economic value, can appropriate decisions be made.

A detailed focus on the building components is inevitable, if refurbishment aiming at improvement of utilization and performance are to be brought in accordance with the quality of appearance. Comprehensively respecting these aspects signifies adding to the quality of the urban fabric.

REFERENCES

- [1] **Hassler, U. (Hg.), Dumont d'Ayot, C. (2009)** : Bauten der Boomjahre. Paradoxien der Erhaltung.
- [2] Lange, R. (1995) : Architekturführer Hamburg. Edition Axel Menges. Stuttgart, p. 125.
- [3] <http://www.architekturarchiv-web.de/portraets/s-t/seitz/index.html> (Stand 20.03.2016).
- [4] Architektengemeinschaft WIWI II. Hoor, Prof. D., Geelhaar, K., Fischer, C.F., v. Bassew, H. (1971): Erweiterungsgebäude des Fachbereichs Wirtschaftswissenschaften der Universität Hamburg. Planunterlagen als Anlage zur Leistungsbeschreibung, p. 1.
- [5] Werkpläne der Firma Siemens, Archiv der Universität Hamburg.
- [6] Floerke, P., Weiss, S., Stein, I., Wagner, M. : Typologienkatalog – Gebaeudeaufstockungen (Catalogue of Typologies – Rooftop Extensions), Bauforumstahl, Duesseldorf, 2014. https://www.bauforumstahl.de/upload/publications/150301_Typologienkatalog_Onlineausgabe_k.pdf

Problems and Prospects of Urban Compaction – A Case of Jaipur City

Sakshi BANSAL^a, Satish PIPRALIA^b.

^a Malaviya National Institute of Technology Jaipur, India, sakban510@gmail.com

^b Malaviya National Institute of Technology Jaipur, India, spipralia.arch@mnit.ac.in

ABSTRACT

The compact city is an integrated form of city with high density, mixed uses and intensification of land uses with centralised activities and higher densities. It requires provision of facilities within a walkable distance and an efficient public transport system to reduce the energy consumption and the pollution so created. The compact city is a form of sustainable urban form as it becomes a solution to the present problem of urban sprawl and rapid development of cities towards the outskirts. Indian cities are expanding in size with their urban boundaries extending outwards. There is a lot of pressure on urban land which due to haphazard development is getting wasted. The compact city is a way to reduce the pressure on land by utilising it to the maximum with higher economic productivity and better environmental quality. The following paper discusses the various parameters which are used to measure compactness of a city and using them the urban compact form of Jaipur city has been analysed.

1. INTRODUCTION

The term compact city was coined for the first time by George Dantzig & Thomas L. Saaty in 1973. The compact form has been studied in the planning literature mostly during the last twenty years to implement the sustainability within the urban environment. Sustainable urban development lays emphasis on having high residential density with mixed land uses, provision of infrastructure facilities within walkable distance, efficient public transport system, low energy consumption, reduced pollution and better social interaction.

According to various authors compact city can be defined as an intensified use of space in the city with higher residential densities and centralisation, more intensified land use and where the growth is encouraged within the boundaries of existing urban areas, but with no development beyond its periphery. It is one of the solution to the problem of the rapid development of the decentralisation outwards of the cities. The compact city includes wiser use of land as land uses are more intensified, thereby avoiding wastage of land. As the nature of the city is more compact, **it reduces travel distances from office to home which saves user's travelling time. The sub-urban agricultural land can be preserved as it requires lesser land to be converted to urban area, thereby saving agricultural land.** The per capita infrastructure spending also reduces as the provision of infrastructure in a compact city is made for higher serving population within smaller area. This saves spending on infrastructure to reach out to farther distances as in case of sprawl. It creates a healthy urban environment as there is lesser dependence on vehicles.

1.1 Urbanisation and compact city

At present, 50% of world population is residing in urban area which is assumed to rise to 70% by 2050. There has been a decrease in densities of cities of both developed and developing countries from 1990 to 2000. The reason for this being the space is not utilised entirely and sprawl. Large metro cities have more space as hinterland and which is underutilised. The cost of housing in suburbs is less but the hinterlands depend majorly on fuel and transport. A balance between density and sprawl, transportation, energy and resources is the need of the hour. There is a constant push for cities which can cater to higher densities.

2. EMERGENCE OF COMPACT CITY

The UNCED Agenda 21 proposals had embodied resource conservation and waste minimization in the late eighties and early nineties to achieve a sustainable urban environment. The countries around the world have started making policies to make their cities compact. A compact urban form in built up areas facilitates local energy generation technologies and at urban fringes it conserves land resources for agriculture, recreation and water and energy provision.

2.1 Measuring the urban form

Urban built form is the physical manifestation of various activity systems in a city, and is a reflection of preferences, perceptions and aspirations of the people. The activity systems are translated into various land uses on the ground. Different land uses generate different built forms. The spatial organization of the city allows planners to formulate policies for future development by incorporating the existing character of the city. The urban form of a city is suggestive of the degree of compactness that can be achieved and that exists in the city. It becomes important to know the level of compactness that exists in the built form if we plan to make it compact for future, given that compact city is accepted as the sustainable urban form.

2.2 Indicators of compact city

Since compact city is the upcoming sustainable form of urban growth it becomes essential to know the parameters that define the compact city. Various researchers have worked upon computing the indicators that can be used to depict the compact city characteristics. The indicators are directly generated from the concept of compact city which are density, land use distribution, density dispersion, transportation, accessibility and shape of the city.

3. STUDY AREA

The study area selected is Jaipur city. Jaipur is the capital city of Rajasthan and the 10th most populous city in India. The study includes measurement of various indicators of compact city for Jaipur to view its potential for future growth. Jaipur is witnessing a rapid growth in its trade and manufacturing industries. It is attracting investment opportunities from all over India. Big international companies and manufacturing industries are eyeing Jaipur as another hub for their growth in India. All these factors contribute towards a large influx of population that is moving to the city. As a result of this population growth the city boundaries have been expanding and the city is facing urban sprawl. The population has become twice from 1991 to 2011 and at the same time the area has become three times from 1991 to 2011. It suggests there has been wasteful use of land. There is a need to plan for higher density compact development which can accommodate this population growth within lesser area.

4. ANALYSIS OF THE STUDY AREA

4.1 Density

High density city is the most important indicator of a compact city. Urban sprawl is an outcome with low-density suburban residential. To preserve the precious sub urban land the compact city form should be incorporated in our cities. Density determines in large part the cost in money, energy, and resources to build and maintain public infrastructure. In addition to infrastructure, density also influences the amount of fuel needed for automobile travel. The greater the density in an urban area, the more its sewers and roads can be made compact.

The population of Jaipur is 3046163 as of Census 2011. The municipal area of Jaipur covers an area of 326 sq. km in 2011. The Jaipur Municipal Corporation (JMC) Area is further divided into the walled city and the rest of JMC area. The average developed density of Jaipur has changed from 152 pph in 1971 to 148 pph in 1991 and 123 pph in 2011. Thus there has been a continuous decline in the density of the city which shows there is a need to control the urban area per person which is increasing. There are 77 wards in the city as of 2011. Figure 1 shows the variation of the gross density in the various wards of the city. The highest gross density is found in the core area or the walled city area as high as 998 pph in ward 53. The density decreases as we go away from walled city. (Source: Census of India & Jaipur Master Development Plan)

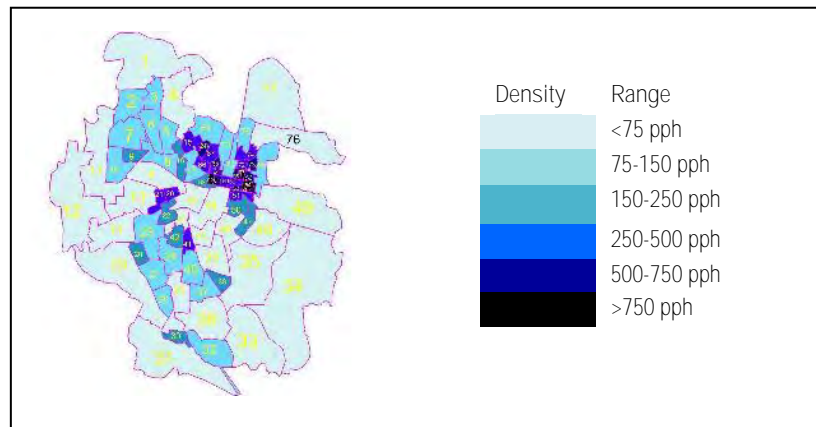

Figure 1: The gross density variation in the various wards of Jaipur city, 2011

4.2 Land use distribution

The land use distribution can be studied to understand the intensity of land use. For a compact city, high density mixed land use is preferable with ample open spaces.

Sr. No.	Major Landuse Purpose	Area (ha)	% to Total Area	% to Developed Land	
				Actual existing in city (%)	UDPFI recommendations (%)
1	Residential	14000	42.87	66.22	35-40
2	Commercial	730	2.24	3.45	4-5
3	Industrial	1600	4.90	7.57	12-14
4	Public and Semi Public	1200	3.67	5.68	14-16
5	Government	340	1.04	1.61	
6	Circulation	2203	6.75	10.42	15-18
7	Recreation	448	1.37	2.12	20-25
8	Mixed land use	620	1.90	2.93	-
Total Developed Area		21141	64.73	-	
9	Agriculture	6900	21.13	-	-
10	Government reserved	701	2.15	-	-
11	Water bodies	520	1.59	-	-
12	Vacant & undeveloped	3396	10.40	-	-
Total Area under Municipal Corporation		32658	100	-	-

Source: Jaipur Master Development Plan, 2025

Table 1: Existing land use distribution in Jaipur 2011

Residential land use far exceeds the norms where as all other land uses are far below the prescribed norms. Such a trend indicates wasteful use of land, inadequate infrastructure, and lack of employment opportunities in the study area. The fast growth of the built up area as compared to other land uses has adversely affected the availability of infrastructure in the system. The land use under recreation and circulation is much lower than recommended. Jaipur city is therefore, facing problems pertaining to road network, water supply, sewerage, drainage, traffic and transportation, etc.

4.3 Density dispersion

Density is an important indicator of a compact city so is the type of density distribution that exists in the city. To understand the pattern of density in the Jaipur city we have studied the density profile, the distribution of density and cumulative population as the distance from the Central Business District (CBD) increases. The approach taken

to study the variation is by taking the centroid of each of the ward in the city and measuring its distance from the central point of the CBD and variation in density with this distance.

A negatively sloped exponential curve is formed if the densities are high at the center of city and decrease away towards periphery. The density gradient determines the travel distances in the city and the consumption of land across the city. The density gradient map of the city of Jaipur is negatively sloped curve majorly but there are a few junctions where the graph shows peaks of high density due to presence of certain important centres such as high density town Sanganer is located here. Due to presence of natural barrier on the north east side of the city which is surrounded by hills on the major eastern and north eastern side leads to growth in the west, north and south western areas.

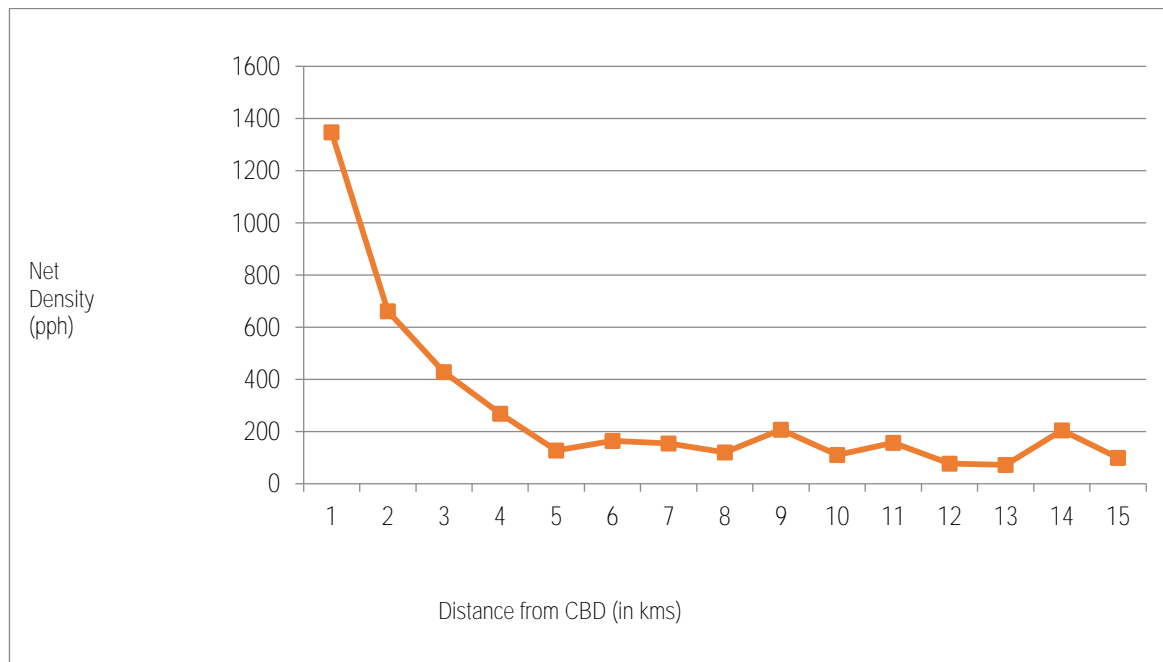

Figure 2: Density distribution pattern as the distance from the CBD increases, 2011

For the Jaipur city, as of 2011, 80% of the population resides within 9-10 kms from the CBD. The closeness to the CBD helps in determining the travel distances of the people. People within 5 km radius are considered close enough to the CBD and it is assumed the distance shall be covered within 15-20 mins by a bicycle. However, the travel distances in the city of Jaipur are to the order of 9-10 kms. For this we need a strong public transportation system to cater to the people in order to keep the city compact and reduce dependency on cars.

4.4 Transportation network

A compact city to be functional needs good connectivity and efficient movement of both goods and passengers. Therefore, public transport has a very important role to boost up activities and promote development in desired corridors. A city can be efficiently compact only when its public transport has the ability to cater to the population being served to reduce dependency on private vehicular use. Wilber Smith and Associates study shows the percentage mode share of trips that are made using each type of transit mode in Jaipur city. The non-motorized transit (NMT) is 32% which is considerably good; the share of private vehicles (35%) is more than twice the ideal values (10-15%) for a city with 2-4 million population. Jaipur city shows a very less share of transit or public transport modes (33%), which shows the lack of investment in public transport infrastructure even though we have seen that the travel distances are of the order 9-10 kms in the city which needs a strong public transport system.

For Jaipur, the evaluated value of congestion index is 0.30 which is slightly higher than the average congestion index (CI=0.26) in Indian cities reflecting an average road network system with certain congested corridors at peak hours. Chandigarh has the lowest congestion index (CI=0) which is very good quality road network.

The average walkability index in Indian cities is found to be 0.52. Jaipur has WI as 0.64 which is close to the average index which suggests that the city has an overall average pedestrianisation. The large cities have better

pedestrian facilities than small or medium towns. If we see developed countries, London has an index of 1.5-1.7 which is extremely good.

4.5 Accessibility index

Accessibility or proximity of a service, place, or intended activity may be described as how efficiently with less time and travel distance a person can reach there. Two types of Accessibility indices are (i) Public Transport Accessibility Index and (ii) Service Accessibility Index.

Public Transport Accessibility Index is formulated as the inverse of the average distance (in km) required to be travelled to reach the nearest bus-stop/ railway station (suburban/ metro) by residents. Higher the index means better public transport accessibility. The Average Public Transport Accessibility index over the cities is found to be 1.05. For Jaipur, the Public Transport Accessibility index is 1.38 which is slightly higher than the average.

Service Accessibility index is based on the percentage of work trips completed within 15 min time. Higher index indicates better service accessibility. In Jaipur, 51% of total work trips are made within 15 min. The accessibility index value for Jaipur is 0.7. The average service accessibility index comes to 0.68 for Indian cities. However, it is close to the average value in Indian cities.

4.6 Shape of the city

The shape of the city may affect the compactness of the city. Linear cities have longer travel distances while circularly growing cities have smaller radial travel distances. The travel distances for work, shopping and recreation vary as the shape of the city varies. The shape of the city is much affected by the locale factors which may include physical barriers, heritage sites, natural reserves, etc. The dispersion index is defined as follows:

$$p = (\sum diwi)/[2/3(A/\pi)^{1/2}] \text{ or } p = (\sum diwi)/(2/3)r$$

Where, d_i is the distance of the centroid of the i th tract (or ward or zone) from the CBD or CG, weighted by the tract's share of population w_i ; A is the built-up area of the city; r is the radius of a circle with area A .

The value of dispersion index as 1.0 is considered as the threshold between compactness and dispersion. Larger the index, less compact the city is. **There are 77 wards in Jaipur and the distance of each ward's centroid from the CBD has been calculated and the weighted population is multiplied to find the value of dispersion index for the city of Jaipur. It has been calculated as 1.166. It is evident that Jaipur is a lot of scope to become compact as it lags behind.**

5. CONCLUSION

Jaipur city has seen a sudden urbanization which has led to a growth of city which wasn't planned for. The core was set up in the 18th century. The city has experienced a southward and westward growth majorly due to the presence of Aravalli range on the east and north. The growth boundaries are expanding with an alarming rate and there is a need to contain the urban form. The study shows that Jaipur has all the components that are required for a compact city. The city at present is heading towards dispersion and there is an urgent requirement to contain its compactness. The dispersion index which was 1.166 suggests that there is a lot of scope for Jaipur to improve its compact character. The wards having densities lower than 150 pph can be redensified. These wards cover more than 40% of the city area. The density distribution shows a tendency of population moving from the center to the peripheral areas. The public mode of transportation's share is poor and should be enhanced.

The compact urban form has a close relationship to the sustainability of the urban environment. The policy makers need to promote the public transportation and formulate policies to reduce car dependency/ ownership. The accessibility to the public transport and service places also helps in containing the compact character of the city. The proximity to work places and commercial areas increases the compactness of the urban form. The efficient supply of social infrastructure and public services within the neighborhood should be promoted. The compact city policies should be incorporated in the development strategies to control urban expansion caused by rapid population growth.

REFERENCES

- [1] Xie and Yongqing, Urban Compaction and Its Impacts On Urban Development in China: A Case Study of Beijing
- [2] Coorey and Lau, Urban Compactness and Its Progress Towards Sustainability: The Hong Kong Scenario
- [3] Elizabeth Burton, Housing for an Urban Renaissance: Implications for Social Equity
- [4] Rajashree Kotharkar, Pankaj Bahadure, Measuring Compact Urban Form: A Case of Nagpur City, India
- [5] **Wilber Smith Associates' Traffic and Transportation Study for Dpr for Proposed Jaipur Metro Feb 2010**
- [6] Nikos A. Salingaros (2007) Compact City Replaces Sprawl
- [7] David Dodman (2009) Urban Density and Climate Change
- [8] Shohreh Khodabakhshi, Density & Sustainable Urban Development
- [9] Anthony Gar-On Yeh, Urban Form and Density in Sustainable Development
- [10] Hideo Harasawa (2002) Compact City Project -Institute for Global Environmental Strategies
- [11] Frediani, J, Giacobbe, N.; Ravella, O.; Pistola, J. (2008) Compact City – Sprawl City: Two Interacting Urban Forms
- [12] S. Fatone, E. Conticelli & S. Tondelli (2012) Environmental Sustainability and Urban Densification
- [13] Jenks Et Al (1996) The Compact City: A Sustainable Urban Form

Where Planning Regulations and Development Practice Collide: The Multi-Storey Apartment Building in Subtropical Brisbane Australia

Rosemary Jean KENNEDY^a

^a *Queensland University of Technology, Australia, r.kennedy@qut.edu.au*

ABSTRACT

Brisbane Australia has been undergoing a growth cycle since 2011, with many new apartment buildings on the **skyline. Brisbane City Council's e-Plan Multiple Dwelling Code unequivocally links the city's character and identity, and residents' way of life**, to the local subtropical climate and landscape. Performance outcomes for code assessable apartment developments promote cross-ventilation and well-designed private outdoor spaces (for example, balconies) to be achieved by correctly designed fundamental structural controls - orientation, spatial configuration, and shading.

A sample of recently-approved 5 – 30 storeys apartment buildings in Brisbane's inner urban renewal areas was studied for performance under the Code. Spatial-structural architectural data were collected from documents **submitted for development approval to Council's online system. A 65-year-old apartment building recognised as an Australian significant building of the 20th Century** was also analysed.

The research identified performance gaps between planning policy and actual design. The older building outperformed the new under all criteria. Little diversity in building configurations, spatial characteristics and basic floor layouts was observed. Overall, the approach utilised by developers is producing formulaic apartments that cannot be effectively cross-ventilated and that have extremely limited or no private open space.

Developers' primary interests are to maximise yield and 'the view'. This paper provides evidence that the planning code is having little effect on key items driven by these aims. These are: compact form (large building volume enclosed by a small façade area) that reduces the extent of external walls available for effective openings; and extensively glazed, unshaded external walls that are compensated for with air-conditioning technology. The quest for views is also compromising the utility of balconies with glazed balustrades diminishing usable, comfortable, private outdoor area. These products are unlikely to meet future market preferences for more authentic innovative place-based buildings and make long-term liveability and sustainability aims difficult to achieve.

Keywords: policy and regulation, subtropical, apartments

1. INTRODUCTION

Brisbane Australia has been undergoing a growth cycle since 2011, with many new apartment buildings appearing **on the skyline. Performance outcomes for code assessable apartment developments under Brisbane City Council's e-Plan Multiple Dwelling Code (2014)** promote cross-ventilation and well-designed private outdoor spaces (for example, balconies) to be achieved by correctly designed fundamental structural controls - orientation, spatial configuration, and shading. The structural (architectural) approach to thermal comfort design aligns most closely **with Brisbane residents' preferences for occupant control over indoor environments, and occasional energy use** (Kennedy, Buys, & Miller, 2015).

Developers' primary interests are to maximise yield and 'the view'. Generic design strategies that are applied to achieve these aims have an effect on the factors that residents consider important for liveability in the subtropics such as availability of natural ventilation to control thermal comfort, access to private outdoor space for everyday home-based activities (Kennedy et al., 2015). Developers favour compact form, where large building volume is enclosed by a small façade area (Barton & Watts, 2013) and extensive external glazing for views. The former reduces the extent of external walls available for effective openings, while the heat gain associated with the latter is compensated for by mechanical controls (air-conditioning technology) often without shading to mitigate glare, and reflectance problems.

The purpose of this paper is to present data and discussion on how recently-approved buildings measure up to the **objectives of the Multiple Dwelling Code (MDC) unequivocally links the city's character and identity, and residents' way of life**, to the local subtropical climate and landscape.

2. CLIMATIC DESIGN APPROACHES AND BUILDING CONFIGURATION

Brisbane is located in Queensland Australia at 27.5°S and 153°E. The natural conditions of the mild subtropical **climate fall within the "comfort zone"** (Ballinger, Prasad, & Rudder, 1992) 80% of the year, and continuous air-conditioning as a function of dwellings is rarely desired by residents. Nevertheless, cooler temperate or hot humid tropical climatic conditions are experienced annually, each requiring specific design responses. It is important to **admit the sun's energy and store using thermal mass when it is required during winter** (Givoni, 1998); and exclude direct sun by orientation and shading strategies and remove heat by in summer (Hollo, 1995). Ventilation to provide air movement reduces the effects of humidity (Emmanuel, 2005).

The relationship between external wall area and enclosed floor area (WTF) is critical in the success of these strategies. Using the structural approach, increasing the extent of external walls is beneficial in terms of opportunities for openings for cross-ventilation, and daylight availability (Ratti, Baker, & Steemers, 2005). The natural ventilation strategy (integrating structural form, and sizes and locations of openings) can have more of an impact on comfort than thermal mass, both in summer and winter. On the other hand, if the mechanical approach is adopted, reducing the extent of external walls in apartment buildings is beneficial for restricting heat gain or loss through the façade.

Expressing this relationship as Surface Area to Volume ($SAm^2/Vol m^3$) ratio provides an indicator of whether the overall building form is fundamentally appropriate to the local climate conditions. The higher the ratio, the greater **extent of external wall area indicated. The lower the ratio, the more 'compact' the structural form is, with greater volume being enclosed by least surface area.** Thus, reducing the extent of external walls is essentially a strategy for heating conservation (Oldfield, Trabucco, & Wood, 2009) and is not suitable for tropical and subtropical conditions.

The relationship between external wall area and enclosed floor area (WTF) is also a critical measure of cost effectiveness in the value profile of a multi-storey building (Barton & Watts, 2013). From a construction cost perspective, the lower the cost of enclosing a unit of floor area with external walls, the better. The greater the number of dwellings on an individual floor plate of an apartment building means that the developer can increase profit by recouping the cost of constructing the external wall from a greater number of purchasers.

The metric is also an indicator of the spatial properties of dwellings: a high WTF ratio implies that dwellings have **a greater extent of façade available to the interior spaces, while a low WTF ratio tends to indicate a "deeper" plan** shape with less external façade available. In multi-storey buildings with several dwellings on each level, the lower the WTF ratio, the more the building form precludes passive forms of control over moderating the internal dwelling environment, and the more air-conditioning is needed.

The MDC Performance Outcomes (POs) and associated Acceptable Outcomes (AOs) exemplify the passive climatic structural approach to design rather than the technological approach (see Table 1 for a sample).

PERFORMANCE OUTCOME	ACCEPTABLE OUTCOME METRICS
PO 20 Development includes buildings that exhibit subtropical design character and subtropical living	<ul style="list-style-type: none"> • 1 of: Dual aspect / greater than 2.4m ceilings / Habitable rooms with 2 windows or openings; • Weather and sun protected external doors and windows to habitable rooms; • Sun-shading or deep recesses on North; • Sun-protection on West.
PO 28 Development must provide attractive and functional private open space for residents	<ul style="list-style-type: none"> • 12m² minimum balcony area • 3.0m minimum dimension

<p>PO 29 Development provides a resident with functional outdoor living space that receives natural light but is shaded to protect the resident from direct sunlight</p>	<ul style="list-style-type: none"> • Solar access (form, materials, orientation) • 75% of a dwelling's outdoor living area N or NE (taking into account desired street interface and privacy outcomes)
--	---

Table 1: The MDC's Performance Outcomes and Acceptable Outcomes for Assessable Development

3. METHODOLOGY

This research focuses on a sample of recently-approved multi-storey residential buildings (MSRBs) from five to 30 **storeys tall in Brisbane's medium and high-density zones** in inner urban renewal areas. Projects with Development Approval (DA) post-2011 were identified by searching Council's online planning application system. A sample of 15 projects was purposively selected to take into account a range of scales of development and spatial configurations. Building usage was primarily Class 2 (Apartments) as defined by National Construction Code (Building Code of Australia) Volume 1(2013) but could also be mixed-use with multiple classifications, for example Hotel (Class 3), Commercial or Professional offices (Class 5), Retail (Class 6). Relevant DA documents were accessed from the online system, and a content analysis of architectural drawings (plans, sections and elevations) was conducted.

In addition, the Torbreck Apartment building completed in 1960, situated at 182 Dornoch Terrace, Highgate Hill was selected as a benchmark case. This building is an Australian Institute of **Architects 'Significant Building of the 20th Century'** (2010). The researchers accessed documents from a case study (Centre for Subtropical Design, 2006).

The research was conducted as a desk-top study during the period December 2015 to February 2016. Field observations to assess any differences between approved designs and built outcomes, or to identify resident modifications were not undertaken because not all of the building construction was complete at the time.

The following spatial-structural metrics were used to gain an understanding of the extent of opportunities for cross-ventilation and daylight availability: Building form and spatial configuration - (for example: tower, podium, core location and single or double loaded corridor, and number of storeys); typical private dwelling unit size, calculated as **fully enclosed covered area (FECA) measured to line of 'weather-tightness'; external wall-to-internal floor area (WTF) ratio of typical dwellings; Surface Area to Volume (SA m²/Vol m³) ratio of overall building.**

The Floor Area Ratio (FAR) of typical apartment building floor plates were calculated to determine potential for **developer's yield. The metrics for FAR included net saleable area (all dwellings areas exclusively allocated to private dwelling units including balconies or similar) and common areas (shared by the residents of each floor including lifts, corridors and lobbies, stairs, ducts, plant rooms, electrical rooms, indoor garbage storage, lift motor rooms, administration areas and any gymnasiums, indoor swimming pools, common laundries, common bathrooms, common changing facilities, business centres, community/lounge/activity rooms and so on).**

Utility of private outdoor space was measured according to the metrics for minimum dimensions and screening in the MDC.

4. RESULTS AND DISCUSSION

The research identified performance gaps between planning policy and actual design. Table 2 (see over) summarises the results. Overall, the approach utilised by developers is producing formulaic apartments that cannot be effectively cross-ventilated and that have extremely limited or no private open space. Little diversity in building configurations, spatial characteristics and basic floor layouts was observed.

The older building (Case 16) out-performed the new under all criteria. The benchmark Case 16 SA/Vol metric reflects the slender forms of its two towers, and associated cooling natural ventilation strategy. Half of the buildings represented by the sample have similar or higher SA/Vol ratios, and half have lower. All three towers in Case 15, a **multi-tower project, have very low SA/Vol ratios, indicating a 'compact' building form unsuited to the structural approach desired in the subtropics.** Another multi-tower project (Case 14) demonstrates both the highest and one

of the lowest ratios. Surprisingly one low-rise building (Case 5) also exhibits the compact characteristic that is more suitable to heating conservation, rather than cooling by cross-ventilation.

Table 3 below summarises the findings of wall-to-floor ratio investigations for typical dwellings within the buildings, showing the benchmark Case 16, and the maximum and minimum cases. Case 16 has larger more spacious apartments and high WTF ratio indicating high potential for a successful ventilation strategy. The area of glazing compared to the overall external wall area indicates that walls are solid mass material compared to Case 15 where the external wall area is fully glazed. It is also worth mentioning that the primary functional requirements of windows under the BCA are admission of daylight and ventilation. View out of the window is a secondary function that has **been given primacy by developers' imperatives.**

The greater external façade area of the older building provides both thermal mass and opportunities for strategic openings, balancing daylighting and cross-ventilation appropriate for warm climates in accordance with recommended climate-responsive design strategies (Ratti et al., 2005). Glazed walls in MSRBs may be desirable for views and daylight (J. Lee, Je, & Byun, 2011), but unless **a holistic architectural logic that serves the occupants'** needs is employed, they can become the greatest source of glare and heat transfer and thermal discomfort in both temperate (Hofer, 2008) and tropical (Lam, 2000) climates.

ID	Ht Storeys	Building Form	Spatial Configuration	No of dwellings	Typical Floor Area Ratio	SAVol (m ² /m ³)	Balcony Area ≥12m ²	BalconyMin dim ≥ 3m	Solar Design	Balustrade transparency
1	5	Tower	Edge-core DL	19	8:1	0.167	N/Y	Y	Y	0
2	5	Tower	Edge-core DL	17	9:1	0.174	N	N	Part	50
3	5	Tower	Edge-core DL	14	12:1	0.210	Y	Y	part	0
4	5	2 Towers	T1 Central-core DL T2 Edge-core DL	21 22 43	15:1 7:1	T1 0.139 T2 0.136	Y	Y	part	80
5	5	Tower	Central Core DL	20	17:1	0.107	Y	Y	Y	80
6	5	Tower	Edge-core DL	16	13:1	0.195	Y	Y	part	100
7	7	Tower & Podium	Central Core DL	18	9:1	0.194	Y	Y	part	100
8	7	Tower	Central-core DL	38	8:1	0.185	N	N	N	NA
9	7	Tower	Edge-core	17	14:1	0.168	Y	Y	part	80
10	7	Tower	Edge-core DL	18	10:1	0.242	Y	Y	N	100
11	20	Tower & Podium	Central Core DL	140	7:1	0.125	N	N	N	90
12	10	Tower	Central core DL	48	7:1	0.166	Y	Y	Y	50
13	15	Tower	Central core DL	135	7:1	0.082	N	N	part	100
14	30	3 Towers (25 st) 5 storey Podium	Central-core DL	352 296 267 915	10:1 7:1 11:1	T1 0.090 T2 0.265 T3 0.237	N	N	N	100

15	30	3 Towers (12, 27, 28) Podium (5 storey)	Central- core DL	40 257 97 206 601	7:1 7:1 6:1	T1 0.097 T2 0.089 T3 0.063	N*	N	N	100
16	22	2 Towers Podium	Central- core DL & Ext-core SL	91 49 140	8:1 9:1	T1 0.150 T2 0.164	N*	N	Y	50

Doubled Loaded (DL); Single Loaded (SL); *Some POSs meets this requirement; ^Balustrade transparency used as a proxy for screening to private outdoor space

Table 2: Summary of Case Study Building Characteristics

Case	Building height Storeys	Typical dwelling	FECA m ²	External wall area m ²	WTF ratio	Glazing area m ²	Total openable area m ²
Benchmark Case 16	22	1B/1Ba	92	37.8	0.41	7	5
		2B/1Ba	107	53.7	0.50	26	13
Maximum Case 6	5	1B/1Ba	52	49	0.94	10	5
		2B/2Ba	74	58	0.78	18	5
Minimum Case 15	30	1B/1Ba	50	6.9	0.13	6.9	6
		2B/2Ba	81	8.7	0.10	8.7	6

Table 3: External Wall-to-Floor Ratio for typical dwelling units

Untreated glazing can be the main avenue for unwanted heat gain throughout the year in the subtropics (ABCB, 2010). The desk-top study could not determine whether low emissivity and spectral selective glazing technology which is of benefit to reduce heat gain (D. H. Lee, 2000) was intended. It is important to note that low-E glazing does not automatically translate into a high performance façade, and it is associated with unshaded buildings. In the subtropics, the structural approach to window design is associated with controlling thermal comfort in summer through shading to control overheating and with generating air movement to counter humidity (Szokolay, 2008). Shading devices also reduce glare and the intensity of daylight entering habitable areas (Edmonds & Greenup, 2002).

Private outdoor living spaces varied quite widely in terms of space and form. Very few dwellings in the sample had primary outdoor living spaces that exceeded 12m² despite outdoor living being one of the hallmarks of **Brisbane's** subtropical lifestyle. While the width of balconies varied across the cases, depths varied widely and many were extremely shallow (460mm, Case 15) or non-existent (Case 8). Most cases incorporated glass balustrades to balconies which offered no sun protection and inhibited air flow. Only 25% of cases had well-resolved designs that complied with the MDC.

The sample analysis demonstrates the tensions between developer's quest for yield and the planning policy's desire to promote climate-responsive building form for MSRBs to play a valuable part of the sustainable subtropical city of the 21st Century. BCC has established that 'structural' design approaches are suitable for multi-residential development Brisbane. But evidently, the current 'passing standard' is too low to achieve acceptable sustainable design. Code Assessable pathways to Development Approval are preferred by developers in order to accelerate the process and thus save money. Ironically, generic solutions are not necessarily the most cost efficient outcomes.

5. CONCLUSIONS

Successful design of private apartment dwellings depends on the overall building form and configurations that require less energy. A major challenge for planning codes is to reconcile the environmental drivers of building form (light and ventilation to dwellings) versus economic drivers (wall-to-floor area) and net-to-gross saleable floor area. This paper has revealed the tensions between the MDC and generic MSRB solutions. It provides evidence that **key items driven by developers' aims to maximise yield and privilege 'views' above other important design**

considerations make it difficult for apartment dwellers to fully embrace climate-responsive high density subtropical living.

Next steps in this research is to investigate the root problems in the current system that results in generic design in order to propose what can be done to enhance the lived experience for Brisbane residents and neighbours (including surrounding community) using effective planning to achieve design approaches suitable for the local subtropical humid climate.

REFERENCES

- [1] BCB. (2010). Energy Efficiency Provisions for BCA 2010 Volume One Information Handbook. Canberra: Australian Building Codes Board Retrieved from http://www.abcb.gov.au/education-events-resources/publications/-/media/Files/Download/Documents/Education_and_Training/Handbooks/2010_EE-Handbook-BCA-2010-Vol1-web.ashx. National Construction Codes (Building Code of Australia) Volume 1, (2013).
- [2] Australian Institute of Architects. (2010). Nationally Significant 20th-Century Architecture, Stanhill Flats (April 7, 2010 ed.).
- [3] Ballinger, J. A., Prasad, D. K., & Rudder, D. (1992). Energy Efficient Australian Housing. City: Australian Government Publishing Service.
- [4] Barton, J., & Watts, S. (2013). Office vs Residential: The Economics of Building Tall. CTBUH Journal, 2013(II), 38-43.
- [5] Brisbane City Council. (2014). Brisbane City Plan 2014. Brisbane: Brisbane City Council Retrieved from <http://eplan.brisbane.qld.gov.au/>.
- [6] Centre for Subtropical Design. (2006). Subtropical Design Multi-Unit Dwelling Case Study Torbreck Home Units. Retrieved from Brisbane: https://eprints.qut.edu.au/view/person/Kennedy_Rosemary.html
- [7] Edmonds, I. R., & Greenup, P. J. (2002). Daylighting in the tropics. Solar Energy, 73(2), 111-121.
- [8] Emmanuel, M. R. (2005). An Urban Approach to Climate-Sensitive Design Strategies for the Tropics. New York: Spon Press.
- [9] Givoni, B. (1998). Climate considerations in Building and Urban Design. New York: Van Nostrand Reinhold.
- [10] Hofer, N. (2008). Compilation Report of the Process, Findings and Recommendations from the False Creek North Post-Occupancy Evaluation. Retrieved from Vancouver:
- [11] Hollo, N. (1995). Warm house cool house: inspirational designs for low-energy housing (1st ed.). Marrickville: Choice Books.
- [12] **Kennedy, R., Buys, L., & Miller, E. (2015). Residents' Experiences of Privacy and Comfort in Multi-Storey Apartment Dwellings in Subtropical Brisbane. Sustainability, 7(6), 7741.**
- [13] Lam, J. C. (2000). Residential sector air conditioning loads and electricity use in Hong Kong. Energy Conversion & Management, 41, 1757-1768.
- [14] Lee, D. H. (2000). Humid Tropical Air Conditioning Mechanical Engineering Services Application Manual. In A. C. a. H. I. Australian Institute of Refrigeration (Ed.), (First Revision and reprint September 2000 ed., Vol. 20). Melbourne: AIRAH.
- [15] Lee, J., Je, H., & Byun, J. (2011). Well-Being index of super tall residential buildings in Korea. Building and Environment, 46(5), 1184 - 1194. doi:<http://dx.doi.org/esp1.library.qut.edu.au/10.1016/j.buildenv.2010.12.010>
- [16] Oldfield, P., Trabucco, D., & Wood, A. (2009). Five energy generations of tall buildings: an historical analysis of energy consumption in high-rise buildings. The Journal of Architecture, 14(5), 591-613. doi:10.1080/13602360903119405
- [17] Ratti, C., Baker, N., & Steemers, K. (2005). Energy consumption and urban texture. Energy and Buildings, 37(7), 762-776. doi:<http://dx.doi.org/10.1016/j.enbuild.2004.10.010>
- [18] Szokolay, S. V. (2008). Introduction to architectural science: the basis of sustainable design (2nd ed.). Oxford: Architectural Press.

Session 2.11: Processes, Design, Tools and Methodologies in SBE (2)

Decision Making in the Pre-design Stage of Building Renovation Projects

Anne N NIELSEN^a, Tine S LARSEN^b, Rasmus L JENSEN^c, Søren B NISSEN^d

^a University College of Northern Denmark, Denmark, anni@ucn.dk

^a Aalborg University, Denmark, anni@ucn.dk

^b Aalborg University, Denmark, tsl@civil.aau.dk

^c Aalborg University, Denmark, rlj@civil.aau.dk

^d University College of Northern Denmark, Denmark, sbn@ucn.dk

ABSTRACT

There is a great potential in renovating our existing building stock, in terms of improving environmental, economic and social qualities. Meeting the increasing performance requirements for sustainable construction entails an increasing level of complexity in the design process of both new buildings and renovation projects. Decision support tools are one solution that can help the building owner manage this complexity. This study investigates the current decision-making processes among Danish professional building owners, in order to propose a conceptual framework for future decision support tools for sustainable renovation. Design Science Research Methodology has been used as the main methodological framework. Current practices for setting goals for sustainability, determining the current state of the buildings and prioritizing which buildings to renovate within a building portfolio, have been explored through semi-structured interviews with five professional building owners. The study showed that there is a need for tools to support the professional building owner in setting goals for sustainability at an early stage. Tools to support the registration of existing buildings and prioritization among buildings to renovate were not seen as a direct need among this specific user group. This work proposes a conceptual framework for future decision support tools based on the findings, focusing on setting goals for sustainability within renovation projects, either within a sustainability assessment scheme (e.g. DGNB-DK), or project specific sustainability criteria. The results presented in this paper are a part of an ongoing research project focusing on developing a new decision support tool for sustainable renovation.

Keywords: decision support, DGNB, deep building renovation

1. INTRODUCTION

Buildings are responsible for more than 40% of energy use worldwide, and one third of global greenhouse gas emissions, causing increasing attention on sustainable development within the construction industry. Along with tightening the regulations for energy efficiency in new buildings, the Danish government sees great potential in improving the energy efficiency in the existing building stock (Danish Ministry of Energy Utilities and Climate 2014). Broadening the perspective from the narrow focus on energy efficiency to a more holistic approach to sustainability, the Danish building industry has chosen DGNB-DK as a common ground for assessing sustainability in buildings, encompassing social, economic, environmental, technical, process and site quality. The increasing demand for sustainable solutions entails an increasing level of complexity in renovation projects. Multiple decisions have to be made throughout the design process; sustainability criteria are numerous and often conflicting, and on top of that, sustainability goals are not always clarified at an early stage, which makes it even harder for the professional building owner to operate and manage decisions in a systematic and efficient way. Decision support tools are one solution that can help the building owner manage this complexity.

Prior to this study, a literature review has been undertaken (Nielsen et al. 2016). In the review, 43 existing decision support tools for building renovation were analysed and categorised in relation to where in the renovation process they can support the decision maker, along with a proposed road map for designing future decision support tools for renovation projects. This study builds on the findings from the literature review by investigating the needs in practice for Danish professional building owners, within the specific areas of setting goals for sustainability, registration of existing buildings and prioritization among buildings to renovate.

In addition to the tools included in the literature review, which were all documented in international scientific journals or conference proceedings, several tools have emerged within the Danish construction industry. The BDB-method (BDB-metoden Aps 2016) is a method designed for the building owner to manage the strategic vision from idea to construction and operation, with a flexible approach to sustainability. The BDB-method is intended to be used for both new buildings and in renovation projects. Another new tool is the BSV decision tool (Teknologisk Institut 2016), which goal is to provide a comprehensive and clear foundation for making decisions regarding energy renovation of buildings. The tool is aimed towards the professional building owner, municipalities, board of directors, advisors and contractors. A digital dialogue and prioritization tool for project managers in housing associations is currently under development; the tool is based on DGNB-DK and seeks to enhance dialogue on sustainability among the project managers, occupants and operation personnel, both in renovation projects and in new building projects (Den almene forsøgspulje 2016). The emergent development of new tools reflects the growing need for tools to support dialogue, communication and decision-making in the early stages of renovation projects among the different actors and stakeholders. The existing tools differ slightly in their aim and objectives, though revolving around the same main goal of improving the renovation process within the Danish building industry. In our opinion, developing new tools, and advancing existing tools, will only strengthen the common goal of improving the decision-making process in renovation projects.

This study contains interviews with five professional building owners so as to investigate how they currently set goals for sustainability in renovation projects, how they register the actual condition of the existing buildings and how they prioritize which buildings to renovate within a building portfolio. The study reported in this article is a part of an ongoing research process focusing on the development of a new decision support tool for sustainable building renovation aimed towards professional building owners. Involving potential users at this stage has been an important step to understanding the problem context. The main contribution of this article is a conceptual framework, which can serve as a foundation for future design and development of decision support tools for sustainable building renovation. Furthermore, the article provides useful insights into the decision-making process of professional building owners in Denmark.

2. METHODOLOGY

The methodological framework used in this research project is Design Science Research Methodology (DSRM). DSRM incorporates principles, practices and procedures of designing successful artefacts and has been widely applied in information system research. Peffers et al. (2007) have described the overall steps within DSRM as problem identification, defining objectives for a solution to the problem, design and development of the artifact, demonstration of the artifact, followed by evaluation and communication of the results. The steps are iterative, but the design and development take their point of departure in the problem definition. The results presented in this paper relate to the step of defining objectives for a solution, hereunder investigating a specific business context and developing requirements for a new artefact. Furthermore, this study follows the guidelines suggested by Hevner et al. (2004) for understanding, executing and evaluating research within Design Science Research. The method for data collection has been qualitative, semi-structured interviews with building professionals from three Danish municipalities and two housing associations. The municipalities and housing organisations chosen for the interviews are all professional building owners managing large building portfolios, with the vast majority of their construction projects being deep renovation projects. The themes of the interviews were based on findings from the preceding literature review, which suggests a roadmap for future development of decision support tools for renovation projects. In order to analyse the data, the interviews were subsequently transcribed, condensed and coded into relevant themes and sub-themes.

3. RESULTS

3.1 Decision contexts

The Danish municipalities are characterized by being political organizations, with internal departments responsible for building projects and building owner consultancy within each municipality. Technically, the building owners are other administration departments within the municipality, constituted by politicians in different fields, with none or limited professional knowledge within building design. The housing associations interviewed for this study also serve as building owner consultants, with local occupant administrations from the housing departments functioning as the “building owners” or decision makers. In both cases, the consultants are a part of the organizations, providing

a foundation for politicians or occupant representatives for making qualified decisions regarding potential construction projects, both new buildings and renovation projects.

3.2 Sustainability goals in renovation projects

The interviewed professionals from the municipalities and housing associations were asked how they currently set goals for sustainability in renovation projects in their organisation. It was concluded that both the municipalities and housing associations often do not have a formal procedure for setting goals for sustainability. Often, the goals are implicit and based on “what we are used to doing”. However, one of the interviewed municipalities has recently developed a sustainability manual for both maintenance, renovation, rebuilding and new building projects, based on the DGNB-DK certification system, but slightly simplified and adapted to the different project types. They use the sustainability manual as a guide intended to be included in the building brief of their projects to ensure a focused and consistent approach to sustainability.

For the housing associations, the residents are involved in the decision of whether or not to renovate, and therefore their process includes a high level of occupants involvement. Their biggest challenge is to convince the occupant representatives to make sustainable choices, **to “sell the idea” of sustainability, as they cannot always see the direct value they get in return for the increased rents following a renovation.** For one of the housing associations, the goals are set from project to project; they have no standardised procedure for goal setting due to the high level of user involvement. For the other housing association, they have a goal to certify all major projects using the DGNB-DK assessment scheme. However, the initial choice to renovate one or more buildings stems from the administrative boards of the occupants. The housing association is currently in the process of certifying their first building, their own administrative office building, in order to gain experience and to evaluate the value of a DGNB-DK certified building. The housing association serves as building owner consultant, and because they are not the **actual building owner, they can only inspire and “sell” the idea to the occupant representatives. Therein lies a challenge in implementing sustainability goals for their construction activities: they find it hard to convince the occupants to choose sustainable solutions. Also, they miss a common understanding of “sustainability” and feeling of ownership across the different departments in their organisation.** Currently, only the construction department is concerned with the sustainability goals, but they wish to include the maintenance department and the rental department as well to ensure a common ground for their activities and goals. The importance of dialogue, both internally in the organisation and externally with included stakeholders, was addressed as an important issue, and one of the biggest challenges, for achieving sustainability goals, as well as prioritization and assessment of available options. Another organizational challenge faced by the housing associations is that they rely on funding from a public fund, and therefore they need to comply with the criteria valued by the fund to get their projects financed.

Interviewees from the municipalities addressed the issue of integrating political goals in the renovation projects as well as the issue of the politicians not being explicit in their goals regarding renovation. Not knowing what is prioritized on the political level makes it hard to implement specific goals in the renovation process. A strategic tool for enhancing dialogue among politicians and the building professionals was requested in order to strengthen the goal setting process and to make goals explicit. Furthermore, all municipalities address the organisational boundaries of their budgets being divided between a construction budget and operation budget as a major challenge in setting efficient goals for sustainability, because they are not entirely able to include a life cycle perspective in their decision-making and sustainability goals. It was specifically addressed by the municipalities that there is a need for a strategic tool that can support them in setting goals for sustainability.

All the interviewees address the importance of making explicit goals, e.g. the level of ambition regarding DGNB-DK certification, in the cases in which certification is a goal. The interviewees all agree that sustainability is important to discuss in the early stages. Also, a majority of the interviewed persons call for a common ground for **the understanding and definition of “sustainability” among the included actors, not only at the early stages of the building process but also later, e.g. in the construction phase.** None of the interviewees use specific tools for setting sustainability goals. However, they see their facility management system and other building administration systems as a helpful foundation for making informed decisions.

3.3 Registration of the current state of existing buildings

Another question for the interviewees was how they currently register the actual state of their buildings. All interviewees explain that they have a good idea of the current state of their buildings, and when they need deep renovation, due to on-site technical personnel. The interviewed municipalities recently started to collect and enter existing building data into new facility management systems. Before this activity, the information was stored in different places, such as physical and digital folders and Excel sheets. Up to this point, they had to rely on the specific knowledge of individual employees about the different buildings. Relying on knowledge from individual employees made it hard to transfer the knowledge because the process was not automated. Collecting and entering data has been, and still is, a comprehensive and time-consuming process. However, they expect that having their building data in one place will make the processes easier in the future.

One of the housing associations explains that they make an examination of the building before they start a renovation project and that the users take part in the building examination. The housing association mentions that e.g. creating BIM models of their existing buildings would be unnecessary and too time-consuming as they know their buildings very well and have employees on site who can easily find information on the physical building if needed.

As there are already well-used procedures and tools for registration of existing buildings among the interviewed user group, it is not considered necessary that a new decision support tool includes this specific aspect, but instead, extracts the required data from the facility management systems if needed.

3.4 Prioritization among buildings to renovate

The municipalities and housing associations were asked how they currently prioritize which buildings to renovate. After the need for renovation has been identified, the prioritization process is approached differently in the housing associations and municipalities. The housing associations have a democratic process in which the occupants have to vote whether or not to renovate as this will also entail an increased rent. For the municipalities, the prioritization lies on the political level where the politicians need to decide what to prioritize. Common is that all the interviewees act as advisors and have to communicate their professional recommendations, hereunder the aspects of sustainability, to decision makers that do not have professional knowledge in the field of building renovation, either politicians or occupants or other departments within their organisations. This makes their challenges comparable, however not similar, as the interests and background of the politicians and occupants might differ. To sum up, the prioritization aspect was not a big issue for the interviewees, simply because they are not the actual decision-makers themselves, but consultants who are providing or facilitating the decision process and priorities.

4. A CONCEPTUAL FRAMEWORK FOR FUTURE DECISION SUPPORT TOOLS FOR BUILDING RENOVATION

The need for communication and dialogue was highly emphasized among the interviewees, but the situations and needs are different for municipalities and housing associations. Therefore, it is recommended by the authors that one tool does not try to encompass all user contexts, but focus specifically on one user group, e.g. municipalities in Denmark, with the prospect of adapting the tool to different user groups and contexts. Based on the findings, the main functionality for future tools should be to help the user set goals for sustainability in renovation projects (Figure 1). If certification of the building(s) is a goal, future tools should provide a framework for setting goals for each criterion within the certification scheme. The certification schemes have predefined weights for each criterion so the user can estimate which criteria to prioritize and how many points they seek to achieve. If certification is not a goal, it is suggested that a weighting module is included in future tools, with the function of assigning weights to the chosen criteria, to reflect the values of the decision-makers. Based on the preceding literature review, the authors suggest encompassing the weighting method Analytic Hierarchy Process.

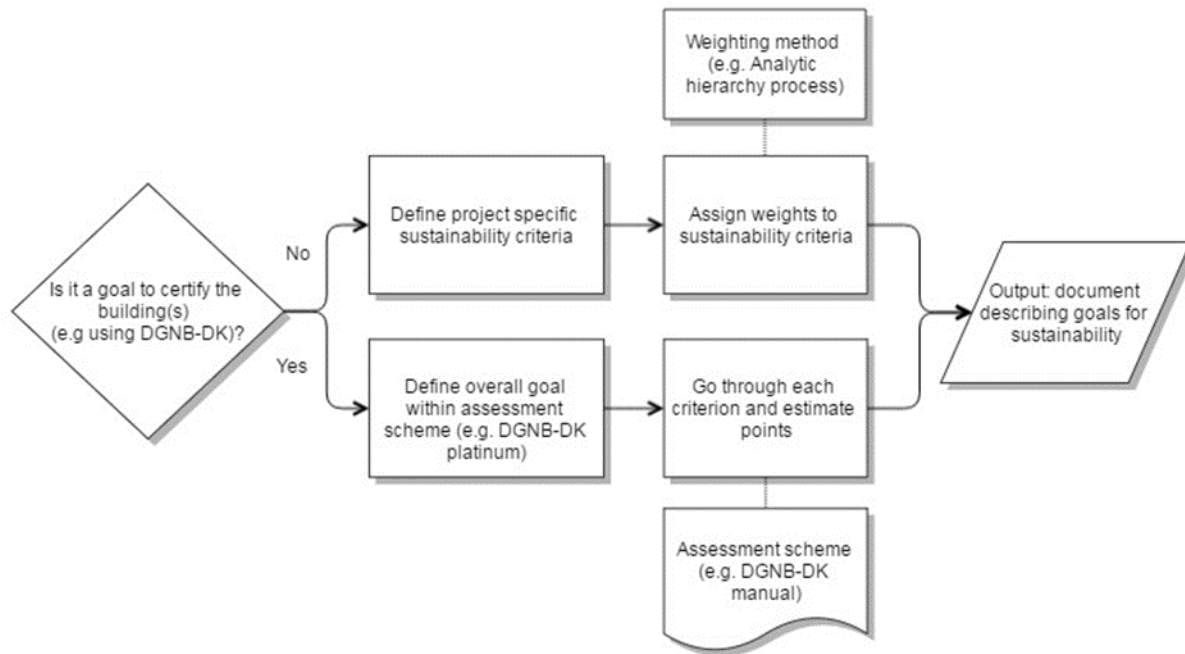

Figure 1: A conceptual framework for setting sustainability goals within renovation projects.

Providing a framework for setting goals for sustainability can enhance the dialogue between the advisor and the building owner and help ensure that goals are made explicit at an early stage. Furthermore, documenting sustainability goals early on can provide useful guidelines throughout the process, even though the goals might change later on. In that case, the tool could be useful at different stages of the design process if the goals need to be modified due to unforeseen factors. Also, the tool could be used in the design process to assess different design alternatives or to assess the final building if certification is not a goal. If the building is certified using DGNB-DK, points can be obtained by documenting sustainability goals in the early project phase. The tool could help provide this documentation.

5. CONCLUSION

The aim of this study was to investigate current practices among building professionals in Danish municipalities and housing associations in order to suggest a conceptual framework for future decision support tools for sustainable building renovation. The study has provided useful insights into how Danish municipalities and housing associations currently set goals for sustainability within renovation projects, how they register existing building data and how they prioritize which buildings to renovate. It was found that there is a need for a decision support tool that can support the professional building owner in setting goals for sustainability within renovation projects. A majority of the interviewees explained that they are already in the process of building a database of their existing building portfolio, for which reason it is not seen as a need to provide a new tool to support the registration process. Furthermore, it was found that prioritization among the buildings to renovate is not a task that lies directly within the departments of the interviewed building professionals and is, therefore, not suggested as a primary focus point in the context of this study. This does not mean that registration and prioritization are not relevant aspects to consider for future decision support tools, but it is not a need within this specific user group.

The results in this article reflect the insights gained from five interviews in a Danish context. It is suggested to focus on one specific user group in the design and development of future decision support tools in order to understand the users in-depth and, thereby, potentially increase the usefulness of new tools. Future research within this research project will focus on the design and development, demonstration and evaluation of a new decision support tool for setting sustainability goals within renovation projects in a Danish context. The focus of this article is on the decision-making process related to building renovation, but the suggested concept could be just as useful in setting goals for new buildings.

REFERENCES

- [1] BDB-metoden Aps, 2016. BDB-metoden. Available at: <http://bdb-metoden.dk/> [Accessed May 9, 2016].
- [2] Danish Ministry of Energy, Utilities and Climate, 2014. Strategi for energirenovering af bygninger, Denmark.
- [3] Den almene forsøgspulje, 2016. Den almene forsøgspulje. Available at: <http://www.denalmeneforsogspulje.dk/stoettede-projekter/igangvaerende-projekter.aspx>.
- [4] Hevner, A.R. et al., 2004. Essay in Information Design Science systems. MIS Quarterly, 28(1), pp.75–105.
- [5] Nielsen, A.N. et al., 2016. Early stage decision support for sustainable building renovation – A review. Building and Environment, 103, pp.165–181.
- [6] Peffers, K. et al., 2007. A Design Science Research Methodology for Information Systems Research. Journal of Management Information Systems, 24(3), pp.45–77.
- [7] Teknologisk Institut, 2016. BSV-beslutningsværktøj. Available at: http://www.teknologisk.dk/energirenovering-2020/valg-mellem-loesninger-til-energirenovering-beslutningsvaerktoej/36652_2 [Accessed September 5, 2016].

A Holistic Thriving Design Approach

Dennis LEE^a

^a *Architecture:Innovativ Limited, Hong Kong SAR, dennislee@arch-innovativ.com*

ABSTRACT

According to the Brundtland Report in 1987, Sustainability is to “meet the needs of the present without compromising the ability of future generation to meet their own needs.” This definition suggests maintaining the status quo, limiting damage, and protecting existing resources without addressing any leap, growth, or innovation. Unfortunately, the most popular word associated with social, corporate, and individual responsibility nowadays is about not ruining it for our children, as if less bad would be good enough.

By contrast, according to strategist Ralph Thurm, “ThriveAbility” is the sum of Sustainability and Innovation. “ThriveAbility” goes beyond collecting points for sustainability evaluation program certifications, beyond specifying recycled or renewable materials, and definitely beyond mere guilt management. We shall aspire to thrive with the transcendental knowledge passed onto us, with research and development, with creativity and imagination, and rethink the way we create products and our living environments. “Thriving Design” starts from the very beginning – when we first conceive a product or a building or a neighborhood, we shall consider beyond how it is designed, constructed, used, and paid for, also how it is maintained, repaired, retired, and recycled. This is a true holistic design approach to the life-cycle of the hardware and living environments to optimize materials and energy consumption, to produce no waste, and to create lasting values.

For Thriving Design to become a reality, we also need supportive governance, rules and regulations, distribution channels, and affordable pricing structures for the mass market. Thriving Design intricately intertwines with the financial aspects of the ecosystem. One has to be both an idealist and a realist. If we could demonstrate long term benefits and quantifiable savings, the market would tip favourably towards the holistic approach. Guilt management would not be needed, as following the trend would simply be the smartest decision.

Keywords: design process, green ethics, green economics

1. INTRODUCTION

According to the Brundtland Report to the General Assembly of the United Nations in 1987, “sustainability” is to “meet the needs of the present without compromising the ability of future generation to meet their own needs.” (Brundtland, 1987). This definition suggests maintaining the status quo, limiting damage, and protecting existing resources without addressing any leap, growth, or innovation. Unfortunately, the most popular word associated with social, corporate, and individual responsibility nowadays is about not ruining it for our children, as if less bad would be good enough. William McDonough and Michael Braungart, co-authors of Cradle to Cradle, ridiculed the use of vocabulary such as reduce, avoid, minimize, sustain, limit, whereas none of these “actions” halt resources depletion and destruction, only slowing them down, allowing them to take place in smaller increments over a longer period of time (McDonough et al., 2002).

By contrast, according to environmental strategist Ralph Thurm, “ThriveAbility” is the sum of sustainability and innovation. “ThriveAbility” goes beyond collecting points for sustainability evaluation program certifications, beyond specifying recycled or renewable materials, and definitely beyond mere guilt management. We shall aspire to thrive with the transcendental knowledge passed onto us, with research and development, with creativity and imagination, and rethink the way we create products and living environments. Thriving Design starts from the very beginning – when we first conceive a product or a building or a neighborhood, we shall consider beyond how it is designed, constructed, used, and paid for, also how it is maintained, repaired, retired, recycled, and re-used. This is a true holistic design approach to the life-cycle of the hardware and living environments to optimize materials and energy consumption, to produce no waste, to re-use resources, and to create lasting values. The idea echoes the concept of “Cradle to Cradle”: to consider waste as food, nutrients, and raw materials for new products (McDonough et al., 2002).

2. THE CONVENTIONAL PRACTICE

Out of all hardware produced in the world, one can hardly disagree that the most expensive commodity we make are buildings and infrastructure. Electricity consumption in buildings tops the greenhouse gas emission chart in the U.S., roughly 40 percent of the total national emission, making the Architects and Engineers the de facto professionals most responsible for energy consumption and pollution (Friedman, 2008). The calculation estimated emission during the operation of buildings and have not taken into account the resources consumed in the construction of new buildings, often in large material quantity with significant wastage; and the demolition of old buildings, often resulted in substantial construction wastes that end up in incinerators and landfills.

At present, majority of buildings are still designed and constructed in conventional “Cradle-to-Grave” means where “resources are extracted, shaped into products, sold, and eventually disposed of in a ‘grave’ of some kind.” (McDonough et al., 2002). We still specify conventional building systems and construction methods because they have been proven to work. However, one cannot blame all problems of pollution, waste production, and wasted energy on Architects and Engineers alone. How often have Architects come up with green ideas or Engineers propose renewable energy systems and got humbled by project managers in budget meetings? The fancy term “value engineering”, by eliminating green design and systems, meant that owners do not see the value of such green design and systems outweighing their initial capital costs. Ultimately, Architects and Engineers’ services are commission-based to design, coordinate with the project team, work with main contractors, and bring the owners’ visions to reality, but they do not have the final say in decision-making. There is a financial component in any design and construction projects often more significant than any other project criteria and goals because material and labour costs are very high, lands are expensive, and owners’ ultimate intention is to increase the value of their property and maximize returns on investments. Our challenge is to prove, using empirical evidence, that a holistic Thriving Design approach is more profitable in a long run. If we could demonstrate long term benefits and quantifiable savings to owners, the market would tip favourably without our need to advocate.

3. THE PROBLEM WITH THE STATUS QUO

Let us examine the common design and construction practice. For projects large or small, project phases more or less follow a linear timeline from conception to completion. Figure 1 illustrates a Typical Design and Construction Phase Flowchart. Consultants are usually engaged from Pre-Design when all parties discussed project goals, contractual terms and conditions, design fees, etc., to Final Completion when defects were rectified and the project is completed such that owners can occupy the building for the intended purpose. The duration of work phases are often clearly defined so owners would relieve consultants’ liability when defects are rectified and warranty expires, and would not need to continuously engage the consultants for additional fees beyond contractual terms.



Figure 1: Typical design and construction phase flowchart

There are only so many pre-destined fates aging buildings would face. For the ones with some cultural or architectural significance, they might be rated historical monuments and would be preserved. Majority of buildings share the same fate in demolition when they aged and deteriorated to the point they no longer serve a functional purpose or generate justifiable revenue. While it takes years to design and construct buildings, demolitions are often optimized to squeeze out the last dollar of rental income, or exploded to rubbles within seconds in true Las Vegas style. The implosion of building produce plumes of smokes and tons of construction waste, sometimes enjoyed by the shouting and cheering crowds as another entertaining spectacle. The original consultants are long gone and long forgotten as their services are not needed in destruction, which is the antonym of what the team does.

Locally in Hong Kong, although less dramatic and more time-consuming, buildings are demolished for the same purpose of making ways to more valuable and profitable future. Daily construction waste generated in Hong Kong tops 4,000 tons per day and which would be moved to public filling reception facilities, sorting facilities, or landfill sites in Tseung Kwan O, Tuen Mun, and Sheung Shui. To emulate common practice in other first-world economies, Hong Kong government developed a “Polluter Pays Principle” years ago such that waste producers would be

charged for their disposal. Certainly, the charging scheme brought in extra revenue for the government but the **problem of waste management remained. Nothing has changed except “waste disposal” became an extra line item on the budget sheet.** There is zero innovation in the policy and it did not reduce waste significantly.

Other than promotion with nice slogans and taglines, there had been limited public or private revolutionary recycling **program that make substantial impacts in waste management. Besides, “recycling” is probably the most abused and misused word nowadays** as most of the claimed recycled products are in fact downcycled, meaning the process of converting the materials actually reduces the quality of such materials over time (McDonough et al., 2002). Downcycled materials contain less quality, less nutrients, and less properties of their previous lives while more energy or chemicals were added to make the materials useful again. We often forget to ask: how clean is the energy that was injected to making of the claimed recycled products?

4. THE WAY FORWARD: FIVE KEY CRITERIA

A holistic Thriving Design approach for the design and construction industry calls for a complete new paradigm in reconsidering the fundamental concept of building, recycle materials, use and comfort, and waste. The revolutionary design approach shall include but not limited to the following five key criteria.

4.1 Think of building as a system, not a structure

Paulo Coelho wrote in his critically acclaimed novel *Brida* that in life a person can choose to build or to plant. He **stated, “The builders might take years over their tasks, but one day, they finish what they’re doing... Life loses its meaning when the building stops.”** On the other hand, for those who plants, **“they endure storms and all the many vicissitudes of the seasons, and they rarely rest. But unlike a building, a garden never stops growing. And while it requires the gardener’s constant attention, it also allows life for the gardener to be a great adventure.”** (Coelho, 1990). Thomas Friedman expanded the same idea in *Hot, Flat, and Crowded*, **“when you start to think of building as a system, not a block of bricks, all kinds of things become possible. And just imagine all these highly efficient smart buildings being integrated into an intelligent Energy Internet, where each building’s flexibility is used to serve the needs of other buildings, not just its own.”** (Friedman, 2008).

As a system, buildings can take in solar, thermal, gravitational, and kinetic energy and produce more than they consume, or through on-site filtration plant to purify and produce effluents that are potable water. Buildings can have their own micro-systems to serve users and macro-system networked to share resources, to compensate one another due to differences in scale, use, foot traffic, siting, solar orientation, etc. In fact groundbreaking **technologies are already out there but not commercialized for the market. We need an overhaul “creative destruction” with the “scrapping of old technologies and old ways of doing things for the new... to increase productivity and therefore is the only way to raise average living standards on a sustained basis.”** (Greenspan, 2007) Similar to how light bulbs replaced candles, water heaters replaced boiling pots, fan coil units replaced fireplaces, new technologies are usually unpopular with a high premium when first introduced, but prove to be convenient, efficient, and cost-savings when the market matures. Construction industry must keep pushing cutting-edge technology to consider **“building as a system for energy production” such that the “zero carbon building” is an obsolete concept, but “energy productive buildings” define the new norm.**

4.2 Design beyond form and function

In a holistic Thriving Design approach, consultants cannot merely make design decisions based on form and function, also taking into account building maintenance and its afterlife. Thus, Architects and Engineers need to design not only the hardware, also the constructive process on how buildings are assembled as well as the reversal process on **how they are dissembled when retired. The concept of “demolition” would be replaced by a new phase of “dissembling” to truly re-use and recycle the materials.** Too often we have seen demolition in action and there are perfectly undamaged materials, products, furniture, sanitary-ware, ironmongery being dumped into the same pile. To tackle the problem of construction waste, charging disposal fees only license the guilt-free mentality and eliminating the source is the only effective way. Figure 2 illustrates a Thriving Design and Construction Phase Flowchart putting equal emphasis on the afterlife of the building and re-use what conventionally considered waste as raw materials for new buildings.

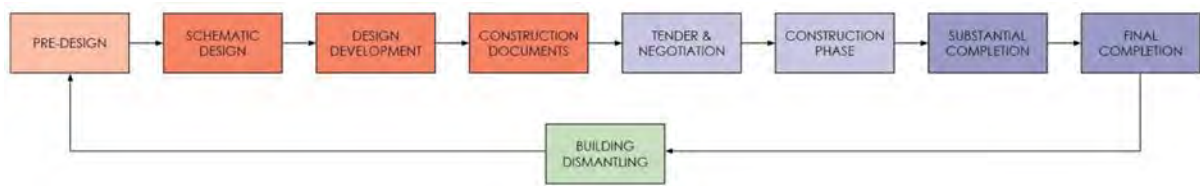

Figure 2: Thriving design and construction phase flowchart

Building Information Model, a.k.a. BIM, had been around for more than a decade and still being selectively considered by owners due to additional consultancy fees or misconception that their projects were too small in scale to justify the use. The strength of BIM is not in the “M” but in the “I”, therefore scale shall not serve as a factor to consider its benefits. While 3D model is for visualization of the built environment, it is the embedded parametric information and attributes that address construction means and methods. In a Thriving Design approach, the use of BIM is mandatory because everything could be constructed and simulated in 3D space, meaning we can foresee and eliminate problems during design and construction given a capable and prudent builder, streamline replacement materials and parts during operation, and anticipate the reversal process during dissembling.

4.3 Redefine our needs and manage our consumption

The shift from consumption to experience based lifestyle is not just fashionable, but a world phenomenon as consumers nowadays increasingly demand experiential or back-to-basics values across all commerce. We are now much more acutely aware of the importance of fundamental qualities of life and authentic lifestyles, including but not limited to genuine connection with friends and family, optimal consumption, organic and non-processed food, health and exercises, etc. As much as technology leap in recent decades, also the trend to appreciate simplicity and un-engineered lifestyles. The same shall apply to buildings and energy consumption.

According to Friedman, “energy efficiency was always the quickest, cheapest, most effective way to create clean power, because the best form of power is the power that doesn’t have to be generated at all because you eliminated demand for it.” (Friedman, 2008). Owners and project team shall take a step back and ask fundamental questions concerning use and comfort, spatial efficiency, optimal energy use, etc. Such deliberation may lead one to consider natural ventilation instead of overloaded air conditioning system, natural lighting instead of artificial, natural landscape instead of hardscape, etc. None of these passive design techniques are new or innovative, what needs to innovate is our mind in re-defining our needs and our sense of comfort. Currently most of the utility providers in the world calculate the required loading based on peak demand networking with redundancy system to minimize service disruption. Controlling our consumption not only alleviate the high demand, also the redundancy that often went to waste.

We also need to reconsider what constitutes “green building”. The true measure of a building’s impact to the health of the users and the environment stretches from its initial conception to design, construction, completion, and throughout operations. Unfortunately, most popular sustainability design evaluation programs nowadays including LEED and BEAM Plus certify buildings as “sustainable” purely based on decisions and actions made during design and construction process with no means to follow up with their operational performance for years to come. While a building might take several years to design and construct depending on its scale, average building life span nowadays is over 50 years with better materials, technology and techniques. The current practice is no different than stating a woman is healthy purely based on her conditions during inception and at birth, instead of a continuous evaluation or body checks throughout her lifetime. Earning a green certificate therefore paves only halfway of the road to true responsible design if not less. An unbiased and independent performance evaluation platform shall be in place to assess any new or existing buildings during their operations and such evaluation must base on actual energy consumption data collected from utility bills, metering, and users’ feedback. Management begins with measurement. With good policies and data transparency, owners and design professionals can work with utility providers who must measure consumption for billing purposes to evaluate the true energy performance of buildings.

4.4 Dream big and believe we are part of the solution

Environmentalist Paul Gilding once said, “How we respond now will decide the future of human civilization. We are the people we’ve been waiting for. There is no one else. There is no other time. It’s us and it is now.” (Friedman, 2008). Often times we got dejected by reality, by the budget-conscious owners, by the expensive green system prices that can hardly justify their life cycle costs. We shall remember, when the energy efficient and on-site renewable energy options provide clear financial benefits and rewards to owners who have long-term visions, the commercial market will tip and funding of further research and development would explode. In any revolution somebody has to play the role of a pioneer, to push, to advocate. We are the people responsible, right now. There is no one else, there is no other time.

To challenge ourselves in the spirit of thriving, we shall also consider how buildings, as systems, can upcycle their materials and components such that their intrinsic value worth more than their predecessors. Building owners and design professionals often see nature as the enemy, as it deteriorates and cracks the new look, the fresh coat of paint, the perfect alignments. In fact, nature is only doing what nature does without bias. Similar to how cedar wood ages and self-protects against insects, rotting, and temperature stress; or copper cladding and corten steel rust to become stronger and more aesthetically pleasing, Thriving Designers needs to explore, experiment, research, and develop new materials and methods that work with nature instead of against it, to consider nature and weathering as providers of fresh inputs and resources in the upcycling process.

4.5 Build rapport with the guardian and the commerce

Famed urbanist Jane Jacobs once described the two fundamental syndromes of human civilizations are the guardian and the commerce. The guardian is the government, whose primary purpose is to preserve and protect the public. The commerce is the everyday exchange of values between individuals, companies, and organizations **in form of currency. While we shouldn’t see nature as an enemy, individuals in the commerce also shouldn’t see the guardian as one. It is the government’s or the building department’s job to be skeptical of new ideas and new standards, thus requesting substantial evidence or proofs or tests or internationally-recognized certification to validate the new as their core concern is public safety and common good.** Once owners and design professionals recognized such parameters and rules of the game, we understand the challenge in executing Thriving Design and getting statutory approval hinge on our ability to demonstrate the add-values while maintaining public safety and common good as high priorities.

Most governments champion innovation with substantial public funding in technology and energy research, therefore we shall all be on the same boat. The challenge is that a government is not a single entity, but many subsidiary departments and they do not necessary work in synch. Consider it check-and-balances or otherwise, departments must protect their turfs and guard their interests in fear of making disastrous or careless decisions that jeopardize public safety. On the other hand, departments are often operating under pressure to innovate themselves. The process to build rapport with each and all of the subsidiary departments, along with industry leaders, manufacturers, users, and stakeholders to reach common consensus would be long and enduring, but worthy and necessary.

5. CONCLUSION

The dream of Thriving Design requires a complete change in our work habits and thinking such that we do not automatically assume the same design and construction practices repeatedly. Experience tells us certain materials and methods work, unfortunately experience is also one of the biggest obstacles in true innovation which often **defies what had been done before. Charles Duhigg states in The Power of Habit, “A movement starts because of the social habits of a community, and the weak ties that hold neighborhoods and clans together. And it endures because of a movement’s leaders give participants new habits that create a fresh sense of identity and a feeling of ownership. Usually, only when all three parts of this process are fulfilled can a movement become self-propelling and reach a critical mass.”** (Duhigg, 2012). Thriving Design approach is a movement in defying old habits of design and construction means and methods, it requires collaboration of professionals in their respective expertise as well as users and the public at large to share that common belief in thriving to bring this vision to reality.

Economist Jeffrey Sachs summed it up perfectly why innovation is the only way moving forward: “countries have a big market, further raises productivity and expands the size of the market, and creates new incentives for innovation. This momentum creates, in fact, a chain reaction, which economists call endogenous growth.” (Sachs, 2005). We need continuous growth for any economies and continuous innovation is about the only means to increase market size, creating what W. Chan Kim and Renee Mauborgne called the uncontested market places or **“blue oceans” (Kim et al., 2005), raising the currency to enhance a larger market, which drives further innovation.** Therefore, innovation and economic growth must be interdependent of one another, walking hand-in-hand, with a clear destiny for a better world. A holistic Thriving Design approach must be the path moving forward to build true thriving communities and living environments that protects the health and wellbeing of people while respecting the land and our finite resources.

REFERENCES

- [1] Brundtland, G.H., 1987. 'Report of the World Commission on Environment and Development: Our Common Future', report presented to the General Assembly of the United Nations, October.
- [2] Coelho, P., 1990. *Brida*. Harper Collins, New York.
- [3] Duhigg, C., 2012. *The Power of Habit: Why We Do What We Do in Life and Business*. Random House, London.
- [4] Friedman, T., 2008. *Hot, Flat, and Crowded*. Farrar, Straus and Giroux Publication, New York.
- [5] Greenspan, A., 2007. *The Age of Turbulence: Adventures in a New World*. Penguin Press, New York.
- [6] Kim, W.C. and Mauborgne, R., 2005. *Blue Ocean Strategy*. Harvard Business Review, Boston.
- [7] McDonough, W. and Braungart, M., 2002. *Cradle to Cradle: Remaking the Way We Make Things*. North Point Press, New York.
- [8] Sachs, J., 2005. *The End of Poverty*. Penguin Books, New York.

Fostering Sustainable Buildings in Indonesia by Foreign Developer for Resilience

Dennis MUI Heung-fu^a

^a Pacific Century Premium Developments Ltd, Hong Kong SAR, dhfmui@netvigator.com

ABSTRACT

The built environment has been confronted by the global climate change and human created threats especially **terrorism in today's world. The society has a strong desire in advancing the sustainable design to resilient building** to cope with these vulnerabilities reactively and proactively. Resilience is the capability to adapt to changing conditions and to maintain or regain functionality and vitality in the face of stress or disturbance. In the context of built environment, it is to incorporate into the design of a building, aspects and features that allow the building to carry out its intended functions, now and in the foreseeable future. Fostering resilient building is a challenge especially for a foreign developer in the Indonesian environment, where the stakeholders have inevitably different culture, technology savvy, body of project management knowledge, mindset and approach.

The paper aims at sharing with the sustainable community from a foreign developer's perspective the experience of developing a Grade A+ office development in Jakarta to put such ideas into action, the project management strategy adopted during the project life cycle, difficulties encountered, how they have been overcome from the project outset since its inception in 2012 and the sustainable technologies employed for resilience. The development acquired the LEED Pre-certification Platinum grade in 2014, the first of its kind in Indonesia, and the GreenShip Design Recognition Platinum grade certification. Besides, the project was one of the finalists under the New Building Category (Building Projects under Design) of the HKBGC 2014 Green Building Award and was conferred the Winner of the Best Green Development and a highly commended Best Office Development in the 2015 Indonesia Property Awards. The project was also the highly commended Best Green Development in the 2015 South East Asia Property Awards. To recognize the contribution in promoting sustainability to local industry, the developer was also awarded the Winner of the Special Recognition in Sustainable Development in the 2016 Indonesian Property Awards. It is due to complete in 2nd quarter of 2017.

Keywords: design process, sustainable building, resilience

1. INTRODUCTION

Since the publication of the "Our Common Future" by the United Nations World Commissions on Environment and Development in 1987, the society has been pursuing sustainability for nearly three decades. There is increasing awareness and demand of community at large for a better place to live and work. Most of the corporations have incorporated in their Corporate Social Responsibility (CSR) policy sustainable development in which environmental responsibilities is an important part of the CSR. Sustainable buildings has proliferated in the property development **sector partly due to the developer's own CSR and to a larger extent, the demand of the market especially those** multi-national corporations which are looking for office premises that are greener for meeting the demand of the **company's CSR** and aspiration of their staff. To attract prestigious tenants who are willing to pay reasonable rent, the office building has to be of high quality and sustainable.

There was forecast in 2012 estimating that around 3.2 million m² of extra office space would appear in the central business district of Jakarta over the next six years (RICS, 2012). The estimation had indicated the expected severe competition for reputable quality tenants in the office market. With such competitive market and against the backdrop of the economic uncertainty in Southeast Asia, developers have inevitably to transcend the norm in order to compete with others for filling up the space within a reasonable timeframe. Thus, the main driver for a better world is the community at large which controls the market force while the government, professionals or technology are catalysts of the process. The property developers have to follow suit to maintain a lucrative business.

For the abovementioned reasons, it was already decided at the inception stage that the office development be targeted to transcend Grade A+ quality.

2. FROM SUSTAINABILITY TO RESILIENCE

2.1 Sustainability

The establishment of the World Green Building Council in 2001 has provided an international property focus for the global sustainability agenda, with significant representation of membership across Asia (APREA, 2012). A range of green building rating schemes have developed since then in different countries to rate the design of buildings in resources conservation and efficacy, biodiversity, enhancing the indoor environmental quality for the safety and health of occupants as well as overall community connectivity.

The United States Green Building Council LEED rating system, initially developed in 2000, is the most widely used green building rating system globally. It has been used as a building standard by multi-national tenants with a deep commitment to sustainability and has established the basic framework for many green building rating systems around the world including in Asia Pacific (APREA, 2012). While utilizing the basic framework of LEED, countries have developed the detailed requirements to accommodate their local differences and put different emphasis on the elements. For example, Green Mark (Singapore) has higher weighting on energy while that of water is higher in Greenship (Indonesia).

2.2 Resilience

The built environment has been confronted by the global climate change and human created threats especially **terrorism in today's world. Sustainability is all about protecting** nature and the environment from human endeavours. However, there is need to protect humans from both the Mother Nature and human threats. As a result, resilience is the next evolution of sustainability (Peng et al., 2012). Hence, the society has a strong desire in advancing the sustainable design to resilient building to cope with these vulnerabilities reactively and proactively.

Resilience was defined by the United Nations Development Programme as the tendency to maintain integrity when subject to disturbance (Levina & Tirpak, 2006). RDI (n.d.a) described resilience is the capacity to adapt to changing conditions and to maintain or regain functionality and vitality in the face of stress or disturbance. It is the capacity to bounce back after a disturbance or interruption. Through resilience livable conditions in the event of natural disasters, loss of power, or other interruptions in normally available services can be maintained. In the context of built environment, resilience means incorporating into the design of a building, aspects and features that allow the building to carry out its intended functions, now and in the foreseeable future (Alfraidi & Boussabaine, 2015).

Resilient design is the intentional design of buildings, landscapes, communities, and regions in response to vulnerabilities caused by climate change and power outages. RDI, n.d.a). Resilient Design Institute (n.d.b) listed out the design principles in a more macro scale. ResilientCity (n.d.) proposed building design principles for designing and constructing buildings in a post-carbon climate responsive building environment. Alfraidi and Boussabaine (2015) more specifically addressed building resilience design in the face of climate change under the categories of site, layout, structure, envelope, system and operation. Champagne and Aktas (2016) surveyed **different literatures the principles for resilience to withstand external stressors that may arise over the buildings'** lifetime for it to be truly sustainable. Based on the above sources, the principles of resilient building design are listed below:

- Meeting basic human needs including potable water, sanitation, energy, livable conditions, lighting, safe air and occupant health;
- Anticipation of interruptions and a dynamic future – adaptation to changing climate such as higher temperatures, flooding, earthquakes, solar flares and anthropogenic actions like terrorism and cyberterrorism;
- Diverse and redundant systems;
- Use low carbon-input materials systems;
- Maximising the use of day-lighting;
- Design for future flexibility of use e.g. modularity and standardization;
- Durability and robustness including strong building envelope;
- Systems that can be serviced/maintained with local material/parts and labours;
- Low energy inputs for constructability and ongoing building operations;

- Renewable energy for less reliability on grid power; and
- Water capture and storage, and usage reduction.

2.3 Assessment of resilience

The existing sustainability or green rating tools, such as LEED, BREEAM, Green Star and CASBEE can be used to assess whether new developments address both the adaptation and mitigation demands of climate change (Stubbs & Beckmann, 2013). Champagne and Aktas (2016) analysed the overlaps between resilient design principles and the LEED certification system and concluded that some of the principles identified have already been incorporated by the existing LEED rating system. To address the gaps, it was recommended to use future climate projections instead of historical data for Site Assessment and Rainwater Management credits, and to revise the Regional Priority credits with regard to flood, drought, water, pest, fire, storm and air to achieve regional resilience based on regional climate projections.

Therefore, it is necessary to integrate resilience into the sustainable building certification system and consider the gaps in light of the local environment to incorporate the necessary resilient features in the development project cycle.

3. LOCAL CONTEXT

A developer constructing building in a foreign country will inevitably encounter issues such as differences in culture, technology savvy, body of project management knowledge, mindset and approach. Strenuous effort is required to foster sustainable building in environment like Indonesia. It will be even more challenging if the target is to transcend sustainability to resilience. In Jakarta, public and sustainable transportation is almost non-existence making the selection of suitable site not been easy.

According to the local professions, Greenship was first launched in June 2010. There was lack of local experience in sustainable design and knowledge on resilience at the time of the project inception in 2012. There were only few developments that had been built with sustainable features and rated by LEED or even Greenship. It was not easy to find professional consultants and contractors who are environmentally responsible and knowledgeable on the requirements of sustainable building technology and the rating tools. For examples, knowledge of recycled contents in materials, concept of using regionally manufactured materials and construction environmental management plan and waste recycling appeared to be new to the contractors and material suppliers. Chillers optimisation control for energy consumption reduction and integrated building management system are not common in Jakarta. Materials that are environmentally friendly may need to be imported and can be costly because of taxation issue besides the transportation cost.

Knowledge on local authority approval process, technological practice on design, quality control and construction methodology as well as language barrier are also challenges which foreign developers have to face.

4. APPROACH TO SUSTAINABILITY AND RESILIENCE

The ten Knowledge Areas of PMBOK® (PMI, 2013) were applied to manage the project and in particular to formulate the strategies as described in the ensuing paragraphs to overcome the hurdles. Figure 1 depicts the approach.

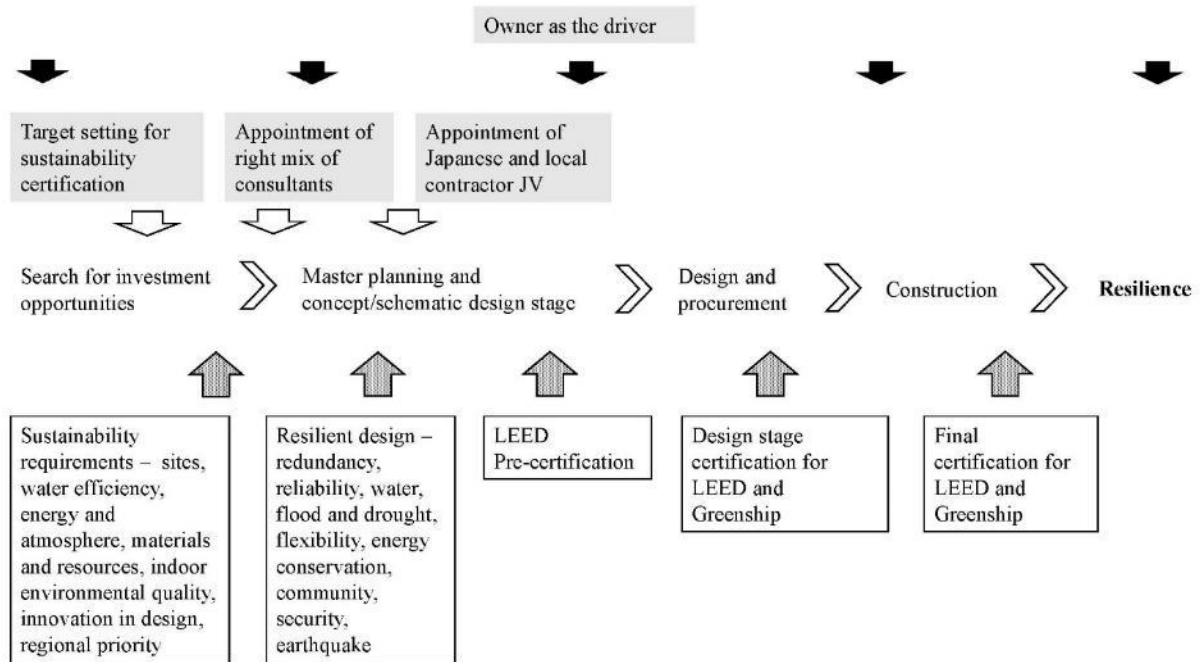

Figure 1: Approach to sustainability and resilience

Appointment of professional consultants with the appropriate mix of specialty – To complement the knowledge base of the local team on both local practice and authority approval process, and to top up the deficiency in knowledge base of sustainability in Jakarta, besides employing experienced local professionals, specialists were drawn from different regions for example, architect from Japan, sustainability consultant and independent commissioning authority from Singapore, wind tunnel laboratory from the State, façade consultant from Hong Kong and security experts from Dubai/London for design beyond the local standards.

Early appointment of the key professional team members – During the searching for investment opportunities, the local architect who is also the founder of the Green Building Council in Indonesia was appointed to assess the viability of each targeted piece of land and selection of suitable sustainable site which was located nearby the future mass transit station. The consultants were appointed at the very early stage and some even before the formalisation of the land deal. They included those for architectural (both local and overseas), quantity surveying, sustainability, mechanical/electrical, structural/civil, façade and property management. This has ensured the early incorporation of the design elements and the integration of the design for sustainability and resilience.

Ride on Japanese culture in construction – Japanese contractors are often giving the industry the impression of attentive to construction details, quality control and timely delivery. A joint operation between a Japanese contractor and the largest local contractor was appointed to construct the building to complement each other in delivering the **project to meet the developer's expectation on time, cost and quality.**

Early involvement of the main contractor – The main contractor was involved in the project as early as at the time of land plot searching to give advice on buildability, cost and time factors with due consideration to the locally available skill, materials and methodology and to familiar with the resilience building requirements.

Project management team of the developer as the driver of the process - The usual problem with professionals is that each member will only focus on their own specialty. This problem will be exacerbated for a multi-cultural team with different mother languages. However, sustainability and resilience need integration. The approach to circumvent is to have the project management team of the developer to reinforce the advice from the sustainability consultant and coordinate with team to ensure design integration in particular with the local context and the compatibility with local construction practice and methodology.

Setting target at project outset – The target of highest grade for LEED and GreenShip rating was set at the outset of the project to ensure that the appointed team members were working towards the same common goals starting from day one.

Step by step approach for certification process – Since the local team has not much experience in the green rating tools, a step by step approach was adopted i.e. undergoing pre-certification, design stage certification and construction stage certification. This was purposely done for the team to get familiar with the process and the requirements as well as to ensure that the sustainability initiatives were incorporated in the various stages of the project development – design, tendering, construction, sales and operation.

5. HIGHLIGHTS OF FEATURES

The development was pre-certified with platinum grade by LEED in 2014, the first of its kind in Indonesia and has undergone the design stage certification. It also acquired the GreenShip Design Recognition Platinum grade certification. Besides, it was one of the finalists under the New Building Category (Building Under Design) of the HKGBC 2014 Green Building Award and was conferred the Winner of the Best Green Development and a highly commended Best Office Development in the 2015 Indonesia Property Award and the highly commended Best Green Development in 2015 South East Asia Property Awards. To recognize the contribution in promoting sustainability to local industry, the developer was also awarded the Winner of the Special Recognition in Sustainable Development in the 2016 Indonesian Property Awards. These certifications and awards have illustrated that applicable features of sustainability and resilience such as site connectivity, heat island mitigation, landscaping and biodiversity, recycled materials, regionally manufactured materials, daylighting application, energy conservation, low emitting materials, heat recovery, increased ventilation etc. were incorporated. So, instead of going through the features in details, the more salient ones with consideration are summarised in Table 1 below.

Resilience principle	Features
Redundancy and reliability	100% backup power by diesel generator; Dual electrical risers; Dual telecommunication lead in and risers; Spare chiller cooling capacity for future increase in cooling load; 100% WiFi coverage in common area for connectivity; 100% mobile network coverage for connectivity;
Water	Reduction in water use by using efficient water devices and sanitary fitments; Deep wells as backup water supply;
Flood and drought	Zero run-off design; Ground floor level at 1 m above the flood plain; Installation water gates to prevent backflow; Critical equipment on Level 6; Long soak pond to control the site run-off; Greywater and black water recycling; Rainwater harvesting; Reducing landscape water use using drip irrigation system and indigenous plants;
Flexibility	Modular and standardized design; Raised flooring; High floor to floor (4.5m) and high false ceiling (3.05m from the raised flooring); Variable air volume air-conditioning system integrated with lighting system; Coordinated ceiling and flooring grids, column spacing and façade modular size; Spare electricity and chilled water supply in each tenancy floor for future expansion;
Energy conservation	Waste heat recovery from the toilet exhaust; Chillers optimization control; LED lighting with daylight sensors in perimeter zone and motion sensors in staircase and toilets;

	VVVF lift system with destination control and regenerative braking; 25%, 30% and 33% saving as compared to baselines of LEED, Green Mark and Greenship respectively;
Community	Clear goals for sustainability parameters in tenancy lease, tenancy fit out guidelines and tenancy manual; Post occupancy evaluation; Measurement and verification plan to mitigate deviation of building performance;

Table 1: Summary of resilience features

Besides, earthquake and security are important issues for designing resilience in Jakarta. In 2012, Indonesia government introduced the new Indonesian Earthquake Regulation (SNI 1726:2012) which requires high-rise **building to sustain standard seismic load to 'Life Safety' performance for withstanding earthquake occurrence equals to 8.5 Richter Scale. The building was designed to have the 'immediate occupancy' performance during** Maximum Considered Earthquake (once in approximately 2475 years return period i.e. 2% probability of being exceeded in 50 years) with the Importance Factor of 1.25 which means that the building has been designed to withstand 25% more seismic forces compared to other buildings designed in accordance with the regulation. Instead of using seismic isolation or passive damping such as diagonal viscous damper or friction pad which are less appropriate for high rise buildings and reinforced concrete cast-in-place, composite structure with concrete-filled steel tube column and shear wall system was used.

A security risk assessment in accordance with ISO 31000 Standard for Risk Management and the associated Security Management Handbook and blast assessment were conducted to identify security hazards, threats and vulnerabilities facing the project in Indonesia. Protection objectives were determined against the identified medium and higher risk scenarios following the strategy of detecting threats before they can affect an asset, delaying the threats from accessing an asset, and allow enough time for a coordinated response to be deployed. Measures were incorporated to ensure critical assets have defences that will limit potential for prolonged outage of operations. It is not intended to reveal the details of measures in this paper because of sensitivity. Generally, the measures include physical protection, automatic access control, CCTV, automotive number plate recognition, intrusion detection, vehicle and personnel screening systems to mitigate high risk scenarios caused by bomb blast, petty/opportunistic theft, office theft, trespass, sabotage.

6. ONCLUSION

With the application of the PMBOK® Knowledge Areas on crafting the project management strategies by appointing the right mix of professionals and Japanese/local joint reputable partnership builder, setting the target at the outset of the project, developer's project management team as the process driver and adopting the step by step approach for certification process, a foreign developer to develop sustainable building for resilience in environment like Indonesia could be made possible to meet the demand of the customer and market, expectation of the developer and aspiration of the sustainable community. The building was at the final stage of construction at the time of writing this paper. The challenge yet to face was to ensure that the contractor(s) would follow diligently the sustainability and resilience design intents for achieving the targets.

REFERENCES

- [1] Alfraidi, Y and Boussabaine, A., 2015. Design Resilient Building Strategies in Face of Climate Change. International Journal of Civil, Environmental, Structural, Construction and Architectural Engineering, Vol: 9, No:1, 23-28.
- [2] Asia Pacific Real Estate Association Limited (APREA), 2012. APREA Sustainability Handbook 1st Edition [online]. Retrieved from: <http://www.asprea.com> [Retrieved on 11 August 2016].
- [3] Champagne, C. and Aktas, C., 2016. Assessing the Resilience of LEED Certified Green Buildings. Procedia Engineering, 145 (2016), 380-387.
- [4] Levina, E. and Tirpak, D. 2006. Adaptation to Climate Change: Key Terms. Organisation for Economic Co-operation and Development.
- [5] Peng, T., Lemay, L. and Hansen, J. 2012. Resilience is the new sustainability [online]. Retrieved from: <http://www.nrmca.org/resilience> [Retrieved on 11 August 2016].
- [6] Project Management Institute (PMI), 2013. A Guide to the Project Management Body of Knowledge 5th Edition. Project Management Institute, Inc., Newton Square, Pennsylvania.
- [7] Resilient Design Institute (RDI), n.d.a. What is resilience [online]. Retrieved from: <http://www.resilientdesign.org> [Retrieved on 12 May 2016].
- [8] Resilient Design Institute (RDI), n.d.b. Resilient Design Principles [online]. Retrieved from: <http://www.resilientdesign.org> [Retrieved on 12 May 2016].
- [9] ResilientCity, n.d. Building Design Principles [online]. Retrieved from <http://resilientcity.org> [Retrieved on 12 May 2016].
- [10] Royal Institute of Chartered Surveyors (RICS), 2012. Intelligence, Modus Asia Edition, October, pp. 8.
- [11] Stubbs, B. and Beckmann, K., 2013. Green rating tools and climate resilient buildings [online]. Retrieved from <https://www.hw.ac.uk> [Retrieved on 19 May 2016].

Reconsidering the Design of High-rise Mass Housing in Tropical Climates - A Case Study in Malaysia

FOO Chee-hung^a, GAN Hock-beng^b, Zuhairi Abd HAMID^c

^a Construction Research Institute of Malaysia, Malaysia, foo@cidb.gov.my

^b G&A Architect, Malaysia, gaarchitect@yahoo.com

^c Construction Research Institute of Malaysia, Malaysia, zuhairi@cidb.gov.my

ABSTRACT

Malaysia have witnessed massive housing development for the last three decades. Many high-rise residential projects have mushroomed across the urban landscape in Malaysia. There is, however, a limitation of architectural design theory for high-rise buildings, especially the passive design principles. This paper aims to address this issue by proposing a flexible housing design system for the high-rise affordable housing in tropical country. The proposed alternative is a combined design and construction system that makes use of the open plan design concept and the Industrialized Building System (IBS) construction method, to produce a variety of housing design options that meet possible user requirements not yet identified at the design stage, while retaining principal uniformity to facilitate the execution of simple but accurate construction with a minimal initial cost. Such system is able to provide the physical spatial arrangements that are conducive for the socio-cultural wellbeing of a community along while complementing the environment. Besides, the system combines both machine production and mass customization, offering more than 10,000 possible designs including prefabricated structures, factory-made structures, dwelling plan and flexible design, to provide an affordable and sustainable housing for all. On a much larger scale, it can facilitate the shift towards higher quality housing in the country, and eventually provide a new dimension in the design of comfortable and sustainable housing for the tropical country.

Keywords: passive design, affordable housing, high performance building

1. INTRODUCTION

Housing emerges as a vital issue to the wellbeing of the community in many modern cities. This is especially true in countries like Japan, Singapore, and Hong Kong, where the lack of developable land in urban areas has made high-rise housing the mode of living for the vast majority of the people. High-rise housing has technical and economic advantages that enable it to form a distinctive feature of housing accommodation in virtually all densely populated urban areas around the world. Such housing type has the potential to decongest the urban sprawl on the ground level, as well as increase the urban density, and housing higher number of families in lesser space. In contrast to the low-rise and single-family houses, high-rise housing is capable of accommodating more inhabitants per unit of area of land and decrease the cost of municipal infrastructure.

As in many other Asian countries, the urban growth in Malaysia has been rapid in the past decades. According to **the report titled East Asia's Changing Urban Landscape: Measuring a Decade of Spatial Growth, Malaysia is one** of the most urbanized countries of East Asia, with its urban land grew with an average annual growth rate of 1.5%, from about 3,900 km² to 4,600 between 2000 and 2010. In terms of urban population, the rate is on the rise from 26.6% in 1960 to 74.7% in 2015, and is expected to surpass 80% by 2020. **Due to the country's rapid urbanization** process, the construction of high rise development is obvious, especially for the limited prime land in states such as Kuala Lumpur, Selangor, and Penang. This can be seen from the increasing number of vertical residential developments being planned and built in most major cities of these states.

While apartment living seems to be the housing solution for densely populated areas, its environmental impacts are still a matter of concern. According to the report titled Residential Apartments Sustainability Plan: A plan to achieve environmental performance in new and existing apartment buildings, the utility consumption per person at a building level is greater in high-rise apartments than landed dwellings. This is particularly high in buildings with **centralized plant and equipment and underground car parks, in which up to 60% of an apartment building's total** energy is used in these common areas. The report also found that residents in apartment recycle half the amount that residents in single houses do, in addition to the extremely high water consumption in apartment living as compared to the landed counterpart. In such a living environment where high density is inevitable, there are strong

opinions that high rise development contributes to an urban pathology and social decay in residential areas, which could undermine the character, livability, social fabric and even the public health of a city (Wan Abd Aziz et al., 2014; Cappon, 1971).

Furthermore, changes in the demographic make-up due to the diversity of family typologies and household arrangements have generated a need for housing that can adapt to different privacy, space, use requirements, and life styles. The present apartment housing, however, have rigid structure, interlocking plan, and predetermined function, in which very few of them can really satisfy the highly variable spatial needs of the various users. According to Karim (2012) and Isnin et al. (2012), users, especially in mass housing, are not satisfied with their housing conditions. Criticisms have been made upon the architectural design of this mass housing include the lack of storage area, small size and deep location of the kitchen, minimum external wall area, complicated partitions, less cross ventilation etc. (Sahabuddin and Gonzalez-Longo, 2015). Given the need for sustainability and the generally important consideration of environmental and social values in the longer term, proposing freedom to choose among options that fit individual needs and aspirations is indeed essential at the housing design stage. **In this sense, flexible housing design can be a suitable solution that capable to fulfil the ever changing dweller's spatial requirements.**

However, the major objection to flexible designs is that flexibility entails complex construction and hence higher costs – the economy of scale through repetition is the main reason inadequate standardized designs are being used in the first place (Wong, 2010). Besides, the theory of flexibility is still largely unconsidered in the realm of residential design, even though it has already been applied in office and commercial building developments (Habraken, 2008). Furthermore, Alegre and Heitor (2004) revealed that the capacity of the reinforced concrete building to allow for changes through the conversion of the spatial layout is limited by the construction system. It is under these circumstances that the present study is conducted, with the aim of proposing a housing design system that integrating housing design with industrial construction system. By adopting flexibility as the inherent architectural design strategy, the proposed system is able to provide the physical spatial arrangements that are conducive for the socio-cultural wellbeing of a community along while complementing the environment. Besides, the system combines both machine production and mass customization, offering more than 10,000 possible designs including prefabricated structures, factory-made structures, dwelling plan and flexible design, to provide an affordable and sustainable housing for all. It makes possible the creation of dwellings which may grow old yet without becoming obsolete; incorporating the latest design ideas and technologies, yet have a sense of history on the Malaysian housing design (the rumah kampung design); allowing the communities to live for generations, yet incorporating the potential of adaptation.

2. DIVERGENT DWELLING DESIGN (D3) SYSTEM

The Divergent Dwelling Design, or D3 in short, is a combined design and construction system directly responses to the fundamental demographic and economic pressure that heightened the need for an appropriate solution for the urban mass housing. It makes use of the open plan design concept and the Industrialized Building System (IBS) construction method, to produce a variety of housing design options that meet possible user requirements not yet identified at the design stage, while retaining principal uniformity to facilitate the execution of simple but accurate construction with a minimal initial cost.

The proposed D3 basic architectural plan is a square shaped plot (Figure 1), having a plurality of “dynamic” space lots (where the bathroom, kitchen, and other dwelling services located) arranged peripheral of the plot so as to be in contact with the outdoor environment; and a plurality of structures such as the dining room, bedroom, or any other spaces located in the “core” space lot which is capable of being arranged, modified, and customized in plurality of designs according to the user's needs. While the plot is standardized to allow for efficient manufacturing, it can take any desired shape including square, rectangle, as well as other polygonal shapes (Figure 2). With the built-in architectural flexibility, D3 basic dwelling unit can be divided into more than one plan, in which the occupant can choose the floor plan they want to live before moving in, thereby achieving harmony between the basic structure and the various sizes of dwellings in the long term. This is similar to the automotive industry, where each individual functional unit is freely bonded with the core structure to serve different occupants' requirement.

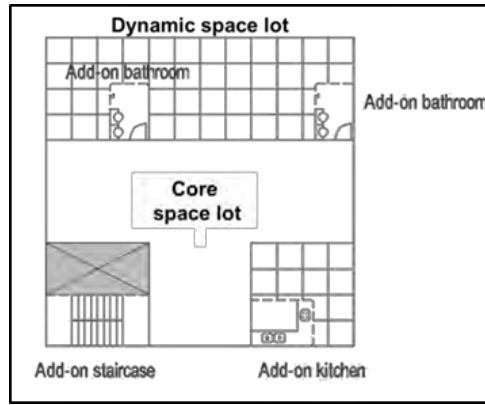

Figure 1: D3 basic architectural plan

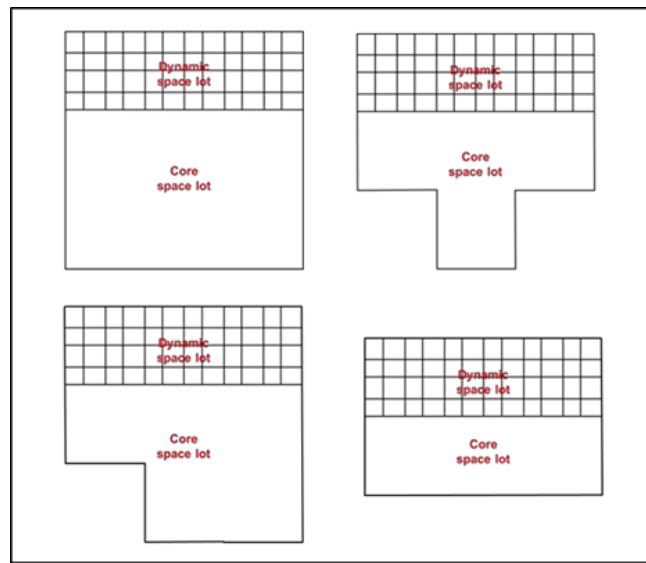

Figure 2: Various shapes of D3 basic dwelling unit

Every D3 building is designed and built in such a way that both the structure and infill of the building are treated as separate entities in order to optimize the efficiency of building assembly and modification. As depicted in Figure 3, the basic layout can be configured into various plans, simply by partitioning the core space lot or rearranging the location of bathroom and kitchen within the dynamic space lot. In other words, there is no one fixed plan in D3 design system but a flexible plan that houses endless of possibilities. Owing to the use of a number of interchangeable component sub-assemblies, D3 makes possible the transfer of construction process from building to manufacturing, with component manufacturers and end-users playing a much larger role in the design process. For example, the bathroom, kitchen, partition, façade etc. are mass produced which then divergently attached to the building structure (Figure 4). The occupant has wide spectrum of choice with regards to products in the market. Since each system is independently manufactured in a controlled environment, the development entails the use of technology and innovation, without the involvement of excessive site labour, time, and cost. In this sense, D3 comprehends the advances of science and technology over time, leading to a faster production at economical rate.

Once the design system is in tandem with serial production and standardization, there will be no bounds for the development of a sustainable community that can accommodate a wide diversity of users and household types. Prospective occupants can choose from a catalogue of available components which are tailored to individual lifestyles and budgets. This enables the occupants to consume only the type and quantity of features they currently require or can afford. For example, a variety of kitchen options that suit a wide range of household lifestyles can be offered by the manufacturers without significant increase of their administrative and operational costs due to the prefabricated nature of kitchen cabinetry. Besides, the variety of configurations available caters to desires for increased work surfaces, space economy, and the inclusion of washer, dryer and recycling facilities within the

kitchen. Similarly, the bathroom requirements also vary according to the occupants and their individual scenarios. Normally, two bathrooms will be provided for every affordable house in Malaysia. However, the number of bathroom is not restricted in D3 housing; if the number of occupants and their schedules justify for another bathroom, D3 open plan concept would satisfy this requirement by balancing the size and location of this additional bathroom with the remaining spaces in the dwelling unit. Consequently, the bathroom options offered by D3 housing can range in size from powder rooms to complete bathrooms with shower, bath, toilet, and sink. Since every individual dwelling unit is flexible enough to adapt to the changing needs of both existing families and future users, the combination of these units will enable a variety of sustainable habitual spaces to be processed, which then can constantly renew themselves without becoming obsolete.

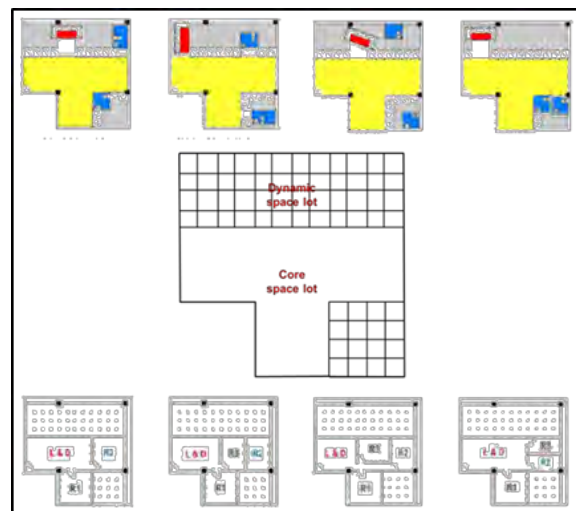

Figure 3: Different variations in the arrangement and partitioning of D3 basic dwelling unit

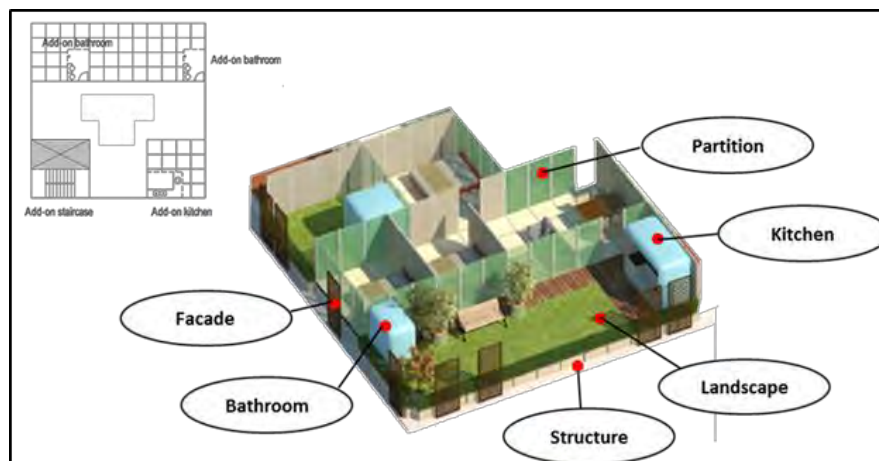

Figure 4: D3 independent building systems

The principles underlying the design of facades are analogous to those governing the structure and plan: flexibility and individual identity. By positioning the dynamic space lot in the peripheral of the plot, a setback of walls is created where no external walls to be in contact with the outdoor environment. Such setting can be well-adopted in the apartment development, imparting a sense of individual identity and differentiating vertical occupancies or uses, yet avoiding the extremes of monotony and theme park atmospheric elements (Figure 5). One of the most common drawbacks of prefabricated housing is the homogenous and repetitive nature of the development, which is a by-product of the economies of scale. The value of providing a diversity of appearances is that it satisfies the **individual user's personal requirement for identity and self-expression**, counteracting any potential feeling of anonymity resulting from increased density, and it incorporates – or rather predicts and pre-structures – the inevitable variety caused by change overtime.



Figure 5: Examples of flexible façade combination

3. D3 SUSTAINABLE STRATEGY

Malaysia is situated in a maritime equatorial area, where the climate is generally the same throughout the year, with uniform temperatures, high humidity, light winds, and heavy rainfall (Hyde, 2008). The very nature of the Malaysian climate necessitates mechanically ventilated or air-conditioned interiors, especially in urban areas. However, poor design and indiscriminate use of air conditioning have resulted in huge increases in energy use. Passive and low energy design strategies are too often excluded from the affordable housing projects because they are deemed to add cost to the construction, though they are the solutions for a sustainable future. D3 directly responds to the fundamental demographic and economic pressure that has heightened the need for a new housing alternative which appropriately integrates affordability and sustainability. To ensure mass housing populations could enjoy eco-housing with affordable price, affordability is designed in at the beginning by adopting a simple design layout, which is flexible enough for adaptation and yet suits to the tropical climatic condition.

In the case of D3 design system, cross ventilation is optimized by having an elongated dwelling shape together with minimal partitions or interior walls. This is not only allowing for easy passage of air and cross-ventilation, but also encouraging a good lighting of the interiors, as well as the flexible use of space. Besides, the parallel arrangement of windows and the placement of high louvers on the internal walls of each bedroom also ensure adequate wind from outside flows through the house. By setting back the exterior walls 2.1m from the peripheral of the dwelling, no walls are exposed directly to the outdoor environment. Solar radiation is, thus, effectively controlled with the large thatched upper floor ceiling that acts as the overhang. Together with the installation of adjustable louvres or grilles as building façade, a barrier is created which not only provides good shading and protection against driving rain, but also to some extent maintain the quality of openness for ventilation and outdoor views. The setback also creates an open porch that makes possible the occupants to enjoy the open-air landscape. With careful planting or selection of vertical green, the open porch can function as a buffer corridor that aids in air circulation. The presence of air movement will then enhance the evaporative and convective cooling from the skin **and can further increase the occupants' comfort. Glare, which is a major source** of stress in the tropical climate, is effectively controlled by using louvres or grilles which break up large bright areas into tiny ones and yet allow the interiors to be lighted up; or by planting less reflective vegetation. Figure 6 illustrates the interior views of the D3 housing.

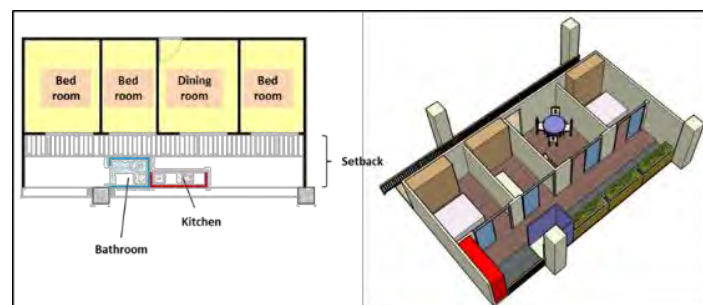

Figure 6: Typical D3 apartment layout

The use of reinforced concrete skeleton structure ensures a lot of the qualities that aid flexibility in housing design, which then contribute to the housing affordability and sustainability. First, prefabrication construction allows for the design of flexible internal space layout are variable to accommodate different family structures. The constant improvement in prefabrication technology that supported by the incorporation of lightweight, durable, smooth edged, space efficient, and universally adopted specifications will ensure that mass housings remain affordable and sustainable for the long term. Second, the use of concrete as the main structural material contributes to a wide range of inherent benefits at no extra cost, such as its proven integral fire resistance, high levels of sound insulation, and robust finishes. Through its very nature, concrete provides robust surfaces for walls, partitions, columns, soffits and cladding that are easily sealed and free of ledges or joint details. All these may finally lead to the lower maintenance costs of the building while set in motion an efficient, cost effective and practical method for solving housing needs and overcrowding concerns in urban areas. However, realizing that the concrete industry is responsible for 10% of worldwide CO₂ emissions, the limited use of concrete is also to be considered in D3 design system. For example, complicated wall arrangements are avoided in D3 housing, so that less concrete wall panels are used as internal partition. Within a typical D3 dwelling unit, walls that facing the outdoor environment is eliminated with the installation of aluminium sliding doors. Since the infills of D3 housing are prefabricated materials that are subject to change, lightweight materials that have a low heat storage capacity such as gypsum board and plasterboard with insulation can always be used in replacement of the existing one. In short, flexibility in terms of architectural and construction process is the key strategy of sustainability in D3 housing.

4. CONCLUSION

With increasingly rapid transformation of the life-style of residents, user preferences out-grow the capacity of buildings faster than ever before. Residential housing, especially mass housing that is not designed to satisfy **immediate needs only will eventually become obsolete when they can no longer serve the users' changing needs.** D3 design system introduced here can generate a better and cheaper habitat option through the application of existing science, technology and machine production capability. This concept is able to provide a new dimension in the design of comfortable and sustainable housing for the tropical country. The importance of this housing solution is reflected in its ability to solve the housing problems of especially the poor in a manner that is most appropriate to their socio-economic and cultural needs, by using environmental friendly method, contribute to the sustainable development of the construction industry, offers what people demand from a house and that they can live how they want to within it, by taking into account (i) The spatial and functional arrangement, (ii) The potential **to expand spaces for increased occupant's usage,** (iii) Maximizing natural lighting and ventilation, (iv) The continuity of the traditional housing concepts into a modern contemporary residential development. On a much larger scale, D3 can facilitate the shift towards a higher quality housing in the country, and eventually create sustainable dwellings for everyone in anywhere in the country.

REFERENCES

- [1] Alegre, A. and Heitor, T. 2004. Flexibility in in the first generation of reinforced concrete4 housing: a public housing estate in Lisbon. *Construction History*, 20, 85 – 93.
- [2] Cappon, D. 1971. Mental Health in the High-Rise. *Canadian Journal of Public Health*, 62(5), 426 –431.
- [3] Habraken, J. 2008. Design for flexibility. *Building Research & Information*, 36, 290 – 296.
- [4] Isnin, Z., Ramli, R., Hashim, A.E. and Ali, I.M. 2012. Sustainable issues in low cost housing alteration projects. *Procedia – Social and Behavioural Sciences*, 36, 292 – 401.
- [5] Karim, H.A. (2012). Low cost housing environment: Compromising quality of life? *Procedia – Social and Behavioural Science*, 35, 44 – 53.
- [6] Sahabuddin, M.F. M. and Gonzalez-Longo, C. 2015. Traditional values and their adaptation in social housing design: Towards a new typology and establishment of 'air house' standard in Malaysia. *International Journal of Architectural Research*, 9(2), 31 – 44.
- [7] Wan Abd Aziz, W.N.A., Haniff, N.R., Musa, Z.N., Mohd Aini, A., Sarip, A.G. and Zyed, Z. 2014. 'Vertical living phenomenon in Malaysia', paper presented at FIG Congress, *Engaging the Challenges – Enhancing the Relevance*, Kuala Lumpur, 16 – 24 June.
- [8] Wong, J.F. 2010. Factors affecting open building implementation in high density mass housing design in Hong Kong. *Habitat International*, 34(2), 174 – 182.

Embodied Energy Versus **Building Height, The “Premium”** of Building Tall

Rolf André BOHNE^a, Benedicte KASPERSEN^b, Julie LYSLO SKULLESTAD^c, Egil YTREHUS^d

^a NTNU, The Norwegian University of Science and Technology, Norway, rolf.bohne@ntnu.no

^b NTNU, The Norwegian University of Science and Technology, Norway, benkasp@gmail.com

^c NTNU, The Norwegian University of Science and Technology, Norway, julielys@stud.ntnu.no

^d NTNU, The Norwegian University of Science and Technology, Norway, egil.ytrehus@gmail.com

ABSTRACT

Smart and sustainable cities require a higher population density, and thus taller buildings. The general idea is that **we can “invest” more into buildings, since we can “save” on transportation. But is there an optimal building height in cities? In this paper we explore the “premium” of building tall, with respect to the embodied energy of construction materials and technical systems.** This paper is a first step towards understanding cities total energy consumption.

In this context a CO₂ premium means: increased greenhouse gas emissions per square meter area with increasing building height. The analysis is carried out through a Life Cycle Assessment, using Simapro. The scope of the study is limited to cradle-to-gate.

The results show that there is a small premium of building tall on a per square meter basis. But there are large variations between the embodied energy of buildings, built with different construction materials. It is therefore of crucial importance to select the right construction materials in future projects, in order to move towards smart and sustainable cities.

Keywords: life cycle assessment, building tall, embodied energy

1. INTRODUCTION

Smart and sustainable cities require a higher population density, and thus taller buildings. The general idea is that **we can “invest” more into buildings, since we can “save” on transportation. But is there an optimal building height in cities? In this paper, we explore the “premium” of building tall, with respect to the embodied energy of construction materials and technical systems.** This paper is a first step towards understanding cities total energy consumption.

In this paper, a “CO₂ premium” means increased greenhouse gas (GHG) emissions per square meter area with increasing building height. Thus, this paper is investigating the following research questions:

- **Is there a “CO₂ premium” of building tall?**
- Is there an optimal building height?
- Is there a preferable construction material for the structural components?

1.1 Goal and scope of the study

The goal of this study is to understand how embodied and in-use GHG emissions varies with building height, and thus seek to determine an optimal building height with respect to optimise GHG emission per m² floor area of the buildings. A better understanding of these relationships are necessary to understand the dynamics of smart and sustainable neighbourhoods and cities for the future.

This study focusses on GHG emissions from buildings and building components. As such, it constitutes a first step towards a holistic understanding of integrated city environments, exploring the relationships between buildings components and infrastructure systems (transport, water, sewage, waste and telecom). Equally, it is a first step toward creating design criteria for the sustainable cities of the future.

Since the purpose of this study is to assess the impact of buildings on climate change, we have limited the study to investigating the relationship between embodied and in-use carbon emissions versus building height. In order

to making comparison between the results possible, we present the finding on a per m² basis, and thus the functional unit chosen is kg CO_{2eq}/m² UFA. The system borders are set to cradle-to-gate.

In addition, since the focus of the study is to investigate the relationship between environmental impact and building height, all factors that are believed to be independent of building height, such as lighting systems, materials for internal surfaces and furniture are excluded from the analysis.

1.2 The building

As a basis for this study is two real buildings that are scaled up or down, and where the material need for alternative construction materials is calculated (Ytrehus, 2015; Kaspersen, 2016 and Skullerud, 2016), Table 1.

	3	7	12	21
Location	USA	USA	USA	Norway
Design wind speed	67 m/s	67 m/s	67 m/s	26 m/s
Live load	2.4 kN/m ²	2.4 kN/m ²	2.4 kN/m ²	2-3 kN/m ²
Storey height	3.66 m	3.66 m	3.66 m	3.4 m
Building height	12 m	26.5 m	44.8 m	76 m
Gross floor area	2613 m ²	6097 m ²	10542 m ²	11823 m ²

Table 1: Building specifications

An early study (Ytrehus, 2015) showed that in-situ-cast concrete was more favourable than other construction techniques with concrete. The up and downscaling of the buildings, as well as the calculation of the timber structures were done in-house, with assistance and quality check provided by a major Norwegian engineering consultancy company. The materials needed for the structural parts of the buildings are given in Table 2.

Material	RC structures				Steel structures				Timber structures			
	3	7	12	21	3	7	12	21	3	7	12	21
Concrete C25/30 (m ³)	925	2031	3436	0	23	174	261	0	23	174	261	3
Concrete C35/45 (m ³)	0	0	0	7186	0	0	0	718	0	0	0	718
Rebar steel (t)	51	105	186	955	2	24	36	93	2	24	36	93
Construction steel (t)	0	0	0	0	197	397	684	1995	0	0	0	0
Glulam (m ³)	0	0	0	0	0	0	0	0	78	125	206	234
CLT (m ³)	0	0	0	0	0	0	0	0	513	1410	2792	4639

Table 2: Material quantity data

Kaspersen et al. (2016) investigated the CO₂ premium of the technical system (Plumbing and HVAC installations, Electrical power and elevators) for the same case buildings. Their findings showed a weak decrease of embodied emissions per m² with building height, up until 12 stories. At heights from 12 stories and upwards, an increase (premium) in embodied emissions from the technical systems was identified. An overview of what is included is provided in Table 3;

Technical installation	Underlying system	Production phase	Use phase
Plumbing and HVAC installation	Plumbing	+	+
	Heating	+	+
	Ventilation	+	+
	Comfort cooling	+	+
Electrical power	Low currents	÷	+
	Lighting	÷	+
Other installations	Elevator	+	+

Table 3: Overview of the technical installations included in the study

In this study, we are using the findings of Kaspersen et al. on the embodied energy in the analysis. With respect to embodied energy from façade system, there are numerous different choices. In a case study on CO₂ emissions from buildings Leung and Yip (2008) found that curtain wall façade systems ranged from approximately 8 to 250 kg CO_{2eq}/m² of facades installed. In this study, we have varied the embodied emissions from facade systems between 15 and 150 kg CO_{2eq}/m² over a 60-year lifetime of the building, and thereby including different design choices and maintenance calculation.

Since we are interested both future and existing buildings, we have modelled the in-use GHG emissions based on a very low energy demand of 50 kWh/m² (with some synergies based on size). And, although this is a low number **by today's standards, it is higher proposed regulations for the future (EU, 2010). The reason we also include in-use emissions in this study, is to understand importance of in-use emissions versus embodied emission over a**

lifetime of 60 years for the building. Including in this is equally the pumping of water to height, which is found to be of a neglectable nature, less than 0,1% of total energy consumption (Aronsen et. al.,2015).

1.3 Sensitivity, best case versus worst case

The sensitivity analyses are based on 1) The best case and worst case for the production of varying construction materials, such as concrete, steel, facade and timber products, 2) The carbon intensity of the in-use energy mix, Table 4.

Material	Concrete C 25/30	Concrete C 40/45	Rebar Steel	Steel	Glulam	CLT	Technical installations	Façade systems	Electricity
Unit	kg CO ₂ /m ³	kg CO ₂ /m ³	kg CO ₂ /t	kg CO ₂ /t	kg CO ₂ /m ³	kg CO ₂ /m ³	kg CO ₂ /m ²	kg CO ₂ /m ²	kg CO ₂ /kwh
Worst case	349	404	2120	2400	159*	173*	45	300	350
Best Case	207	265	480	1600	91*	104*	32	30	132

* We are not applying consequential LCA, and thus a net carbon storage of approximately 600 kg per m3 timber products are not accounted for.

Table 4: Input data for best case and worst case sensitivity analysis

2. RESULTS AND DISCUSSION

The result below is shown as a shaded area between the best case and worst case (sensitivity analysis) for the various building parts; foundation, structural components, technical systems, façade systems and also for the in-use energy consumption. The functional unit for all the analysis is kg CO_{2eq}/m² floor area.

2.1 Embodied energy

Figure 1 shows embodied energy from the foundation work versus building height. As expected there is a premium for building tall, as taller buildings require a stronger fundament. In this analysis, we have used the same fundament across different structural materials. That this might be an overkill for timber buildings is here not taken into consideration. Given the goal and scope of the analysis, this is of minor concern.

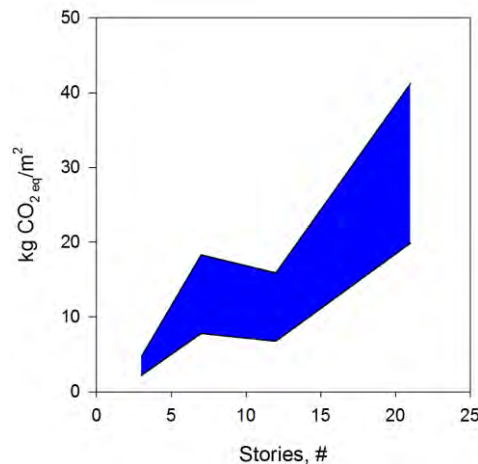

Figure 1: Embodied emissions from the foundation versus building height

The contribution of the structural components is shown in Figure 2. There is a weak negative trend in emissions up until 12 stories tall for buildings made from reinforced concrete or steel. These are cases where steel-based constructions have higher emissions than buildings of concrete. Buildings made of timber has significantly lower emissions than building made of concrete and steel. An interesting point is that the environmental impact from the timber construction is much lower than for concrete and steel buildings, although we have excluded carbon storage from this study. If carbon storage had been uncounted for, we would have negative emissions from the timber buildings of approximately 600 kg CO₂/m² (Skullestad, 2015).

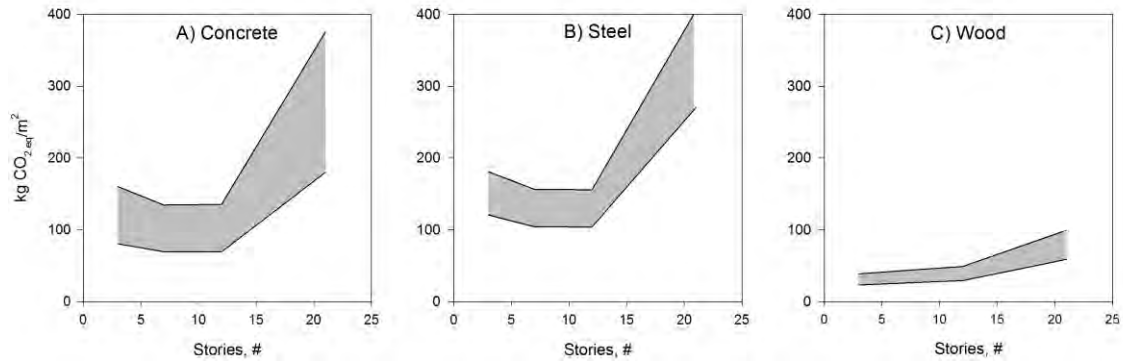

Figure 2: Embodied emissions from the structural components versus building height. A) Reinforced concrete, B) Steel and C) Timber buildings

The embodied emissions from the technical installations shows a weak decrease in embodied emissions up until 12 stories, Figure 3. From 12 stories and up, there is a small increase in emissions (“premium”) with building height. We believe that this “premium” will increase further with even taller buildings.

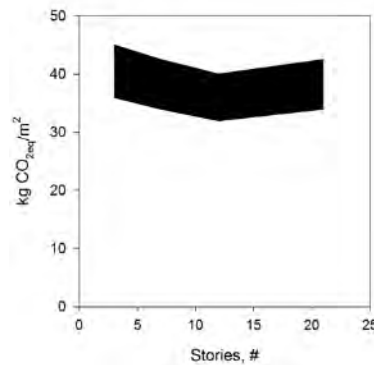

Figure 3: Embodied emissions from the technical installations versus building height

Figure 4 shows the embodied emissions from façade systems. These results are interesting for several reasons. Firstly, this reflects the great difference in embodied emissions from different façade systems per m² façade (including various maintenance interval schemes). There is a factor of 10 difference between the best and the worst case, Table 1.

Secondly, the U-shape of the curve suggests a decrease in emission with height up until 12 stories. After 12 stories, **there is increase in emissions (“premium”) with building height. We found that this behaviour can be explained by** the surface (wall) to volume ratio of the building, and as such a more a design issue. This relationship will, however, always be there, and thus suggesting that there could be optimal building height with respect to embodied emissions.

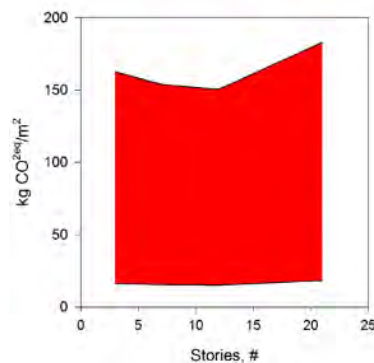

Figure 4: Embodied emissions from the facade systems versus building height

2.2 In-use-energy demand

In addition to embodied emissions from construction materials, we investigated the impact of in-use energy consumption on total emissions from the buildings over a 60-year period, Figure 5. The results clearly show that energy consumption – and the corresponding emissions – decrease with increasing building height. This change corresponds with changes in surface area to volume changes in the buildings.

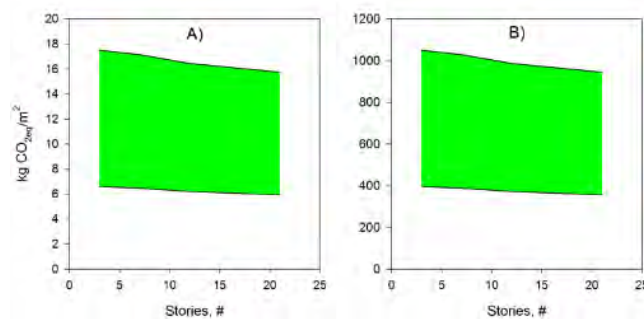

Figure 5: Emissions from the in-use energy consumption versus building height. A) Annual emissions, and B) Aggregated emissions over 60 years

The difference between the worst case and best case clearly reflects the different carbon intensities of the power grid, and are therefore outside the control of the users of the buildings. The best case reflects the expected future carbon intensity of the European grid in 2050 of 132 g CO_{2eq}/kwh, while the worst case shows today's average of 350g CO_{2eq}/kwh (Graabak and Feilberg, 2011).

2.3 Embodied and in-use GHG emissions over a 60-year service period

The total GHG emissions from the buildings over a 60-year period time period is shown in Figure 6. The results revealed some interesting relationships.

Firstly, although the expected energy consumption is very low (45 to 50 kwh/m²), in-use energy consumption still is responsible for more than 50% of the total emissions over a 60-year period. This finding suggests that a continuous focus on the reduction of the in-use energy demand – as well as a decrease in carbon intensity of the electric grid – is of utmost importance. Thus, the reduction in energy demand from dwellings, will have a double effect. This because a lowered demand for electricity in turn will eliminate the need for the least effective (most expensive) and most polluting power plants.

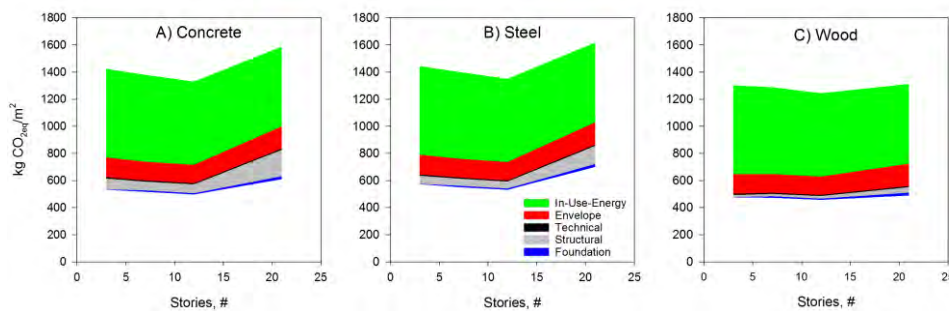

Figure 6: Total emissions from buildings versus building height over a 60 period, for A) Concrete buildings, B) Steel frame buildings and C) Timber buildings

Secondly, there is a significant opportunity for GHG emissions to be harvested by better use of construction materials. This especially concerns the increased use of wood as structural material and in the façade, which would significantly reduce GHG emission from buildings.

Lastly, the figure clearly suggests that there is an optimal building height. According to the figure, this optimum is to be found somewhere between 10 and 20 stories. This result, however, has to be verified with a larger empirical study.

3. CONCLUSION

The analysis presented in this paper indicates that there exists an optimum for building height somewhere between 10 and 20 stories regardless of construction technologies. For all the investigated building heights, wood will significantly reduce the embodied emissions from the building. Within all the scenarios presented in this paper, there is a significant discrepancy between the worst-case and the best-case CO₂ emissions. The most accessible gains stem from addressing façade and avoiding energy input to the building. Further research: the study presented in this paper does not include the potential effects of carbon storage of the building. Such effects will prominently appear in timber structures, and will potentially have significant GHG emission reduction effects.

Although the results presented in this paper indicate an optimal height of buildings (in the range between 10 - 20 stories), this can change within an analysis that include a broader scope. If, for instance, the system is expanded to include transport systems and networks, the potential seems to exist for permitting building heights of more than 20 stories. This will be explored in future papers.

REFERENCES

- [1] Aronsen, T., Galtung, S., Karlsen, Ø., Røyland, D. and Sandvik, H. (2015) "Energy Optimal City Planning, Experts in Teamwork - Project Report, NTNU, Spring 2015,".
- [2] European Union (2010) Directive 2010/31/EU of the European Parliament and of the Council of 19 May 2010 on the energy performance of buildings. <https://ec.europa.eu/energy/en/topics/energy-efficiency/buildings/nearly-zero-energy-buildings>
- [3] Graabak, I. and Feilberg, N. (2011). CO₂ emissions in different scenarios for electricity generation in Europe. Technical report from SINTEF Energy for the Research Centre on Zero Emission Buildings.
- [4] Kaspersen, B., Lohne, J. and Bohne, R.A. (2016) "Exploring the CO₂-Impact for Building Height: A Study on Technical Building Installations." SBE16 Tallinn and Helsinki Conference; Build Green and Renovate Deep, 5-7 October 2016, Tallinn and Helsinki. Energy Procedia 00 (2016) 000–000.
- [5] Leung, M., and Yip, M. (2008) "Impact of Construction Project Designs on CO₂ Emissions". CIB 2008. <http://www.irbnet.de/daten/iconda/CIB20888.pdf> accessed October 2016.
- [6] Resch, E., Lohne, J., Kvamsdal, T., and Bohne, R.A. (2016) "Impact of urban density and building height on energy use in cities". SBE16 Tallinn and Helsinki Conference; Build Green and Renovate Deep, 5-7 October 2016, Tallinn and Helsinki. Energy Procedia 00 (2016) 000–000
- [7] Skullestad, J.K., Lohne, J. and Bohne, R.A. (2016) "High-Rise Timber Buildings as a Climate Change Mitigation Measure - A Comparative LCA of Structural System Alternatives". SBE16 Tallinn and Helsinki Conference; Build Green and Renovate Deep, 5-7 October 2016, Tallinn and Helsinki. Energy Procedia 00 (2016) 000–000
- [8] Ytrehus, E.K., Bohne, R.A. and Lohne, J. (2015) "Investigating the "CO₂-premium" for building height". ISIE conference 2015- Taking stock of industrial ecology, University of Surrey, Guildford, UK - 7-10 July 2015.

Session 3.11: BIM for Sustainability (1)

BIM Based Deep Building Renovation Optimisation for Sustainability

HUANG Lizhen^a, Guri KRIGSVOLL^b, Bjørn Arild GODAGER^c, Anne Lise P. HELÅSEN^d

^a Norwegian University of Science and Technology, Norway, lizhen.huang@ntnu.no

^b Norwegian University of Science and Technology, Norway, guri.krigsvoll@ntnu.no

^c Norwegian University of Science and Technology, Norway, bjoern.godager@ntnu.no

^d Arkitektpartner AS, Norway, anne-lise@arkitektpartner.no

ABSTRACT

As long lifetime products, the buildings will stand several decades. The current existing buildings is the dominate part of buildings stock. To improve the existing buildings energy performance is one of key for building sector to meet the goal of global warming mitigation. However, how to do deep renovation in good way, specific with comprehensive considering the environmental impact and cost, is well studied yet. This paper develops a framework to identify the optimized solutions for the deep renovation for less environmental impacts and better cost effective with integrating BIM, life cycle assessment, life cycle costing and multi-objective optimization technologies. A family house built in 1966 in Oslo in Norway is applied to be a case study for this paper. The results indicate that: 1) the renovation of housing itself with better insulation will be more cost-effective than the installation of PV panel; 2) the reduction of greenhouse gases is not as significant as energy saving of renovation because the electricity supply in Norway is mostly from hydropower.

Keywords: deep renovation, LCA, BIM, optimization, Norway

1. INTRODUCTION

Buildings consumed 33843 TWh of energy in 2010, which is 30% more than the level in 1990. By 2050, energy use for buildings is expected to be doubled due to a global rise in floor area of around 130%. Most energy used for buildings today are from fossil fuel, which causes greenhouse gases emissions. Building sector, so-called 40% sector to the global warming potential, is identified as one of the key sector for global warming mitigation. Moreover, as long life products, the existing building are anticipated to still accounting for more than 50% of the global building stock in 2050; in the OECD countries, this figure is closer to 75%. One of main element of contemporary sustainability discourse is that human beings must keep the level of CO₂eq in the atmosphere below 450 parts per million (ppm) in order to have a 50% chance of staying below a catastrophic global average temperature rise of 2 °C above pre-industrial levels. If such greenhouse gas emissions (GHG) emission objectives are to be met, it is necessary to do deep renovation on buildings to reduce carbon emission considerably.

The life cycle assessment (LCA) is proved as a well suitable tool for obtaining the full picture of the environmental implications of running buildings. Numerous studies has analysed the environmental impacts of buildings/dwelling with life cycle perspectives. Equally, economic is one of three dimensions of sustainable development. The cost-effectiveness is one of the key components of the building design. The life cycle cost (LCC) analysis, working as the effective tools, looks at the economic over the life of building. However, finding solutions to support the progress in the environmental friendly and cost-effective is not easy. The studies, which combine the life cycle assessment and life cycle costing to seeking the sustainable buildings, is relative recent, for example. These existing studies concentrate on the energy efficiency of new design residential buildings. As one of main issue for OECD countries, renovation of current buildings are not well studies. As the consequence, the knowledge on deep renovation with optimising way, specific with comprehensive considering the environmental impact and cost, is not enough. This study tries to add the knowledge of environment impacts and cost caused by deep renovation of buildings, especially to identify the optimizing solutions for the deep renovation for less environmental impacts and more cost effective. In order to identify the goal, this study conducts a decision-making framework, with integrating BIM, life cycle assessment, life cycle costing and multi objective optimization for buildings. A detached house in Norway built in 1966 will be used for case study.

2. METHOD

2.1 BIM modelling

Over the past decades, there had been a growing interest of the construction sector in using Building Information Models (BIM). BIM modelling is approved to be an effective tool to manage accurate building information over the whole life cycle. This study conducts the BIM model for the existing building for the life cycle assessment by onsite survey and interview. The BIM model is processed in the Revit software.

2.2 Life cycle assessment

The LCA in this framework follows the ISO 14040/44 methodology. The ReCiPe Midpoint (H) V1.1 method has been used to estimate the environmental impacts.

- Goal, scope and reference unit

The goal of the LCA study is to estimating the life cycle environment impact due to the deep renovation of the buildings in Norway. While some LCA studies on buildings defines 1 m² floor area or 1 m³ gross volume as functional unit, EN15978 uses the whole building as a functional equivalent. Since the function is delivered by the building as a whole, and not by the floor area/gross volume, the study use the whole building as function unit for **the LCA. Thus, the reference unit in this study is defined as “the off-site preparation, on-site renovation, use and demolition of one building over the lifetime of 50 years”.** The lifetime of a building is a difficult parameter to standardise since it depends on many factors. This study assume the lifetime as 50 years after deep renovation. The off-site preparation stage involves the extraction and manufacture of construction materials and fuels, transportation through the supply chain and to the building site. The renovation stage consider the on-site energy use for necessary demolition and installation. In this study, the operation stage considers energy used by occupants for space cooling, lighting, hot water, and appliances. The energy for demolition is difficult to estimate due the unknown future technology and impossible sorting between original part and renovated part. Therefore, the demolition stage considers waste. The demolition waste off renovated building only refer to the waste from the materials used for renovation. The waste from original part are excluded. Due to the data access, the treatment of waste produced during renovation and demolition are excluded, while the transportation of such waste to the disposal site are included.

- System description, assumptions and data

The system boundaries, the assumptions made for and the data estimated are mainly depend on the renovation projects. The consumption of materials for renovation will be calculated from the information dig outing from the BIM. Moreover, there is common assumption in the framework. Machines and tools for the renovation are used for more than one site. Thus, this study does not consider the consumption of machines and tools. The on-site daily energy consumption are used to calculate the energy consumption for equipment operation and transport on the site. It excludes the transportation of construction machines, equipment and tools to the site. The background inventory data are from EPD Norge and Ecoinvent database.

- Impact assessment

The ReCiPe Midpoint (H) V1.1 method was used to estimate the environmental impacts. The following midpoint impact categories are used: Climate change (GWP) and Particulate matter formation (PMFP). The environmental impact, E_i , is calculated by following the logic of total environmental impact ($E_{i_{tot}}$), equation 1, but where system boards are placed in such way that the end-of-life stage only consider the transportation of the waste;

$$E_{i_{tot}} = \sum_{E_i} (E_{i_{ot}} + E_{i_r} + E_{i_o} + E_{i_d} + E_{i_e})$$

Where tot = total impact, ot = off-site preparation (including extraction of materials, production of construction materials, transport), r = on-site renovation process, o = operation, d = deconstruction and e = waste handling and end-of-life activities.

Equation 1

2.3 Life cycle cost

The life cycle cost analysis estimates the relevant cost throughout the life of buildings. The determination of the cost of building is a challenge task, due to the long lifetime of buildings. The price of labour, fuel, material and component can be significantly different from year to year and depend on the location, market and quality. The value of money today and in the future are not equal, because of inflation. Most of the existing LCC studies follows the method developed by , which eliminated inflation from all escalation and discount rates. However, the inflation rate is difficult to estimating for several decades. To decrease such uncertainty, this study follow the study to use the undiscounted cost. This study assume that the technology and cost for operation in future is same to today. Equally, all cost here are calculated as 2015 price. Moreover, this study does not consider the mortgage. In this study, LCC corresponds the system boundary of LCA. The cost for renovation consider the potential payment paid by the owner. The cost for operation considers the payment for energy bill. At the end of life, the residual value is normally not considered in the demolition. Thus, the end of life stage only consider the cost for the transportation of the waste. In this study, the database in Holte (following the Norwegian standard NS3450) are mainly used. Tax is not included.

The life cycle cost, C , is calculated by following the logic of the cost (C_{tot}) as equation 2.

$$C_{i_{tot}} = \sum_{E_i} (C_{i_{ot}} + C_{i_r} + C_{i_o} + C_{i_d} + C_{i_e})$$

Equation 2

2.4 Optimization

The optimization problem here is multi-objective optimization as follows:

$$\text{MinLCC, MinLCEI, MinLCE}_c, \& \text{MaxLCE}_p$$

Subject to:

$$0 \leq LCC \leq C_c$$

$$0 \leq LCEI \leq C_{EI}$$

$$0 \leq LCE_c \leq C_E / LCE_p$$

Where, LCC = life cycle cost, LCEI = the life cycle environment impact, LCEc = life cycle energy consumption, LCEp = life energy production. If the deep renovation aims to be nearly zero energy building with renewable energy production on-site, the LCEp will consider.

To simply the optimization of problem and involve the property owners/users perspective. This study follow the literature with solving a multi objective optimization problem with the objective functions for a given weighted vector w_i yields a single optimised solution. Analytic hierarchy process (AHP) can decompose a complex decision problem into several sub-problems in terms of hierarchical levels, where each level represents a set of criteria, sub-criteria, or attributes related to each sub-problem. AHP is proved to have some of its advantages over other multi criteria decision making (MCDM) tools. AHP has been chosen for this study to identify the weighting of indicators.

Level 1	Level 2	Level 3	Level 4
Deep renovation optimization solutions	Theme	Criteria	Indicators
	Environmental impacts (life cycle perspective)	Local impacts	PM10 Emissions
		Global impacts	GHGs emissions
	Resource	Energy	Energy production
			Energy consumption
	Cost	Life cycle cost	Life cycle cost

Table 1: The assessment indicators for the deep renovation

The optimization here will be processed by Linear Programming (LP) algorithm. Thus, the LP model of single objective optimization form as:

$$\text{Min} Y = \sum_{i=1}^I w_i (z_i x_i)$$

Subject to:

$$0 \leq X_i \leq C_i, i = 1, 2, 3 \dots I$$

Where, Y= objective function, x_i = the output of indicators, $z_i x_i$ is the normalized value of the indicators. w_i is weighting and the sum of weight will equal to 1.

The Matlab software will be used for the optimization.

3. CASE STUDY

A detached house (226 m²) located in Oslo built in 1966 is selected to be a case study for the project. The figure 1 presents the 3D models of the building.

The house has U-value 0.5 for roof, 0.82 for the façade and 2.4 for windows. The renovation aims to make this old house as nearly zero energy building. The house use annually around 47000 kWh for heating and ventilation, 14000 kWh for hot-water, lighting and appliance, etc. It is supposed to be two part: 1) to renovate it following the existing building code in Norway (TEK10), 2) to install the solar PV panel to produce the enough electricity for the building. The solar resource is much more in summer than in winter in Norway. The electricity produced by buildings is not allowed to sell now, but it will be possible in the future. Therefore, it is supposed to use the electricity for car charging in the summer time. In the winter, the house still need to buy the electricity from the grid. It is supposed that the electricity used for car charging will cover the electricity bought from the grid. The average sunlight hours in Oslo area are 1632 hours annually. The installation of solar PV will get the 10000 NOK (Norwegian kroner) and 1250 NOK per kW (up to 15 kW) subsidies from ENOVA. The average cost of installation of Solar PV is 13NOK per Watt. The PV panel is assumed to be renewed after 25 years. The electricity get from grid is estimated as one NOK per kWh according the current bill information.



Figure 1: 3D model of the house from south-west

After analysis, the house will have two options on the renovation; the difference of two options is shown in the table 2.

Solutions	energy saving after renovation (kWh/year)	energy production requirement (kWh/year)	GWP (ton CO ₂ eq)	PMFP(kg PM10 eq)	LCC(million NOK)
Option 1: Change roof, facade, and window+ install the solar pv	25306	35780	56.13	282.75	1.04
Option 2: Change roof (not increasing the insulation quality) facade, and window+ install the solar pv	20507	40579	62.69	48.59	1.06

Table 2: Main results for two options

The users' perspective is indicated as weighting for optimization according their willing to pay. The result of optimization showed that the option 1 is selected because the owner want to priority on energy saving, life cycle cost and GWP.

4. DISCUSSION AND CONCLUSION

This study concentrates on the users' perspectives, environmental requisites and cost as the study framework for identifying, analysing and assessing the solutions for the deep renovation. It explore and develop an assessment and optimization by using the BIM, life cycle assessment, life cycle cost analysis and multi-objective decision making technology for the deep renovation of buildings. The case of a family house built 50 years ago in Norway is used for analysis.

It is found that the saving of energy for the renovated to be current building code on roof, façade and windows will save energy use around 25 MWh annually and 1.3 million NOK energy cost in total life. The most cost effective

renovation part is the façade. It costs around 0.25 NOK to get 1 kWh energy saving. The installation of PV panel on the roof is also a good options for cost saving (investment with 1 NOK will get around 3 NOK payback). However, the renovation of housing itself will be more cost-effective than the installation of PV panel. The saving of the GWP of the renovation is not as significant as the energy saving and life cost saving. The renovation will cause more local PMFP. This is mainly because that the 99% of current electricity in Norway is from hydropower which is already is renewable energy.

There are some uncertainty of the results. Firstly, the material consumption data is from the BIM model, but the energy use data is from simulation. The simulation will create some uncertainty of the results. So the post renovation evaluation will conducted later to improve the reliable of the results. Secondly, the buildings is long life products. The life cycle scenario, including the lifetime, end of life treatment, etc., will impact the results. This require future studies on analysing the uncertainty of life cycle scenario of building in details.

REFERENCES

- [1] Chau, C.K., T.M. Leung, and W.Y. Ng, A review on Life Cycle Assessment, Life Cycle Energy Assessment and Life Cycle Carbon Emissions Assessment on buildings. *Applied Energy*, 2015. 143(0): p. 395-413.
- [2] Abd Rashid, A.F. and S. Yusoff, A review of life cycle assessment method for building industry. *Renewable and Sustainable Energy Reviews*, 2015. 45(5): p. 244-248.
- [3] Islam, H., M. Jollands, and S. Setunge, Life cycle assessment and life cycle cost implication of residential buildings—A review. *Renewable and Sustainable Energy Reviews*, 2015. 42(2): p. 129-140.
- [4] Islam, H., et al., Life cycle assessment and life cycle cost implications for roofing and floor designs in residential buildings. *Energy and Buildings*, 2015. 104: p. 250-263.
- [5] Islam, H., et al., Optimization approach of balancing life cycle cost and environmental impacts on residential building design. *Energy and Buildings*, 2015. 87: p. 282-292.
- [6] Islam, H., M. Jollands, and S. Setunge, Life cycle assessment and life cycle cost implication of residential buildings - A review. *Renewable and Sustainable Energy Reviews*, 2015. 42: p. 129-140.
- [7] Eleftheriadis, S., D. Mumovic, and P. Greening, Life cycle energy efficiency in building structures: A review of current developments and future outlooks based on BIM capabilities. *Renewable and Sustainable Energy Reviews*, 2017. 67: p. 811-825.
- [8] ISO, ISO 14040-Environmental management -- Life cycle assessment -- Principles and framework. 2006: Geneva.
- [9] ISO, ISO 14044-Environmental management - life cycle assessment- requirements and guidelines, in Geneva. 2006.
- [10] Cuéllar-Franca, R.M. and A. Azapagic, Environmental impacts of the UK residential sector: Life cycle assessment of houses. *Building and Environment*, 2012. 54(0): p. 86-99.
- [11] Asdrubali, F., C. Baldassarri, and V. Fthenakis, Life cycle analysis in the construction sector: Guiding the optimization of conventional Italian buildings. *Energy and Buildings*, 2013. 64(0): p. 73-89.
- [12] Standards, E., EN 15978 Sustainability of construction works - Assessment of environmental performance of buildings - Calculation method. 2011, EUROPEAN STANDARD.
- [13] Adalberth, K., Energy use during the life cycle of single-unit dwellings: Examples. *Building and Environment*, 1997. 32(4): p. 321-329.
- [14] Zabalza Bribián, I., A. Aranda Usón, and S. Scarpellini, Life cycle assessment in buildings: State-of-the-art and simplified LCA methodology as a complement for building certification. *Building and Environment*, 2009. 44(12): p. 2510-2520.
- [15] Cuéllar-Franca, R.M. and A. Azapagic, Environmental impacts of the UK residential sector: Life cycle assessment of houses. *Building and Environment*, 2012. 54: p. 86-99.
- [16] Fuller, S.K. and S.R. Petersen, Life cycle costing manual for the federal energy management program, NIST handbook 135. 1996: National Institute of Standards and Technology, Gaithersburg.
- [17] Reidy, R., et al., Guidelines for life cycle cost analysis. 2005: Stanford University Land and Buildings.
- [18] Keoleian, G.A., S. Blanchard, and P. Reppe, Life-cycle energy, costs, and strategies for improving a single-family house. *Journal of Industrial Ecology*, 2000. 4(2): p. 135-156.
- [19] Konak, A., D.W. Coit, and A.E. Smith, Multi-objective optimization using genetic algorithms: A tutorial. *Reliability Engineering & System Safety*, 2006. 91(9): p. 992-1007.

- [20] Rizet, C., et al., Assessing carbon footprint and energy efficiency in competing supply chains: Review - Case studies and benchmarking. *Transportation Research Part D: Transport and Environment*, 2012. 17(4): p. 293-300.
- [21] Shen, L., K. Muduli, and A. Barve, Developing a sustainable development framework in the context of mining industries: AHP approach. *Resources Policy*, 2015. 46, Part 1: p. 15-26.
- [22] Govindan, K., et al., Multi criteria decision making approaches for green supplier evaluation and selection: a literature review. *Journal of Cleaner Production*, 2015. 98: p. 66-83.
- [23] climatemps. Sunshine & Daylight Hours in Oslo, Norway. 2016 [cited 2016 Sep.20]; Available from: <http://www.oslo.climatemps.com/sunlight.php>.

Integrating BIM for Sustainable Planning, Design, Construction and Facilities Management for Hong Kong's Public Housing Development

Lawrence KW CHUNG^a Edmund CHAN^b

^a Hong Kong Housing Authority, Government of the HKSAR, Hong Kong SAR, kw.chung@housingauthority.gov.hk

^b Hong Kong Housing Authority, Government of the HKSAR, Hong Kong SAR, edmund.chan@housingauthority.gov.hk

ABSTRACT

The Hong Kong Housing Authority (HA) implement a public housing programme which cover all stages of development, from planning to design, construction and facility management. Building sustainably has always been one of our main objectives, and to this end, we continue to drive for innovation to improve the environmental performance of our development. In the past decade, we have devoted ourselves to integrate the use of Building Information Modelling (BIM) to enhance design efficiency, improve environmental performances, and advance the quality and safety of our work for the entire building development life cycle. We have successfully integrated BIM at all stages of our work, including:

- Feasibility and planning stage – Integration of BIM and geographic information system (GIS) to facilitate a variety of studies, including visual impact assessments, ridge line, vantage point and shadow analyses as well as site appraisal studies.
- Scheme design stage - Use of BIM for site specific design and value management
- Detail design stage - Use of BIM to enhance design efficiency and achieve energy saving.
- Construction stage - Use of BIM for site safety and construction planning.
- Post completion stage - Use of BIM for facilities and asset management.

BIM is transforming the construction industry worldwide and it can also contribute a great deal in sustainability. **This paper will explore this subject in detail citing HA's experience as a reference.**

Keywords: building information modelling, building performance analysis, sustainable design

1. INTRODUCTION

Established in 1973 under the Housing Ordinance, the Hong Kong Housing Authority (HA) develops and implements one of the largest public housing programme in the **World**. **Today, about 30% of the Hong Kong's** seven million population is living in about 750,000 flats in public rental estates. Another 15% of our population is living in subsidized sale flats. In support of the Government policy on housing, HKHA plans, builds, manages and maintains different types of subsidized public housing in meeting the housing needs of those who cannot afford private housing in Hong Kong. According to the latest update to the Long Term Housing Strategy as contained in the Policy Address 2016, the Government has further adjusted the projection of housing demand for the 10-year period from 2016/17 to 2025/26, and the public housing supply target will comprise 200,000 public rental housing units and 80,000 subsidized sale flats. With such a sizable programme to implement whilst ensuring quality, safe and healthy living in such a high density compact city as well as for people of all ages and abilities, it is quite a challenging task to accomplish. Invalid source specified..

Building sustainably has always been one of our main objectives, and to this end, we continue to drive for innovation to improve the environmental performance of our public housing developments. In the past decade, we have devoted ourselves to integrating the use of Building Information Modelling (BIM) to enhance design efficiency, improve environmental performance, and advance the quality and safety of our built environment for the entire life cycle. With the concerted effort by staff at all levels, HA has, over the years, embarked on a number of innovative research and developments in BIM. We have achieved great success at many fronts and have applied it to good use in our projects. In this paper, we will highlight how we apply these innovations at different stages of our work, from planning to design, construction and facilities management.

2. INTEGRATING BIM FOR SUSTAINABLE PLANNING, DESIGN, CONSTRUCTION AND FACILITIES MANAGEMENT

2.1 Feasibility and planning stage

2.1.1 Integration of BIM and geographic information system (GIS)

Traditionally, BIM and GIS are two separate platforms which operate independently. Since 2009-2010, we saw the need and benefits in integrating the two systems to assist in the planning and design of our estates. In 2013/14 our colleagues have developed a data transformation tool which allows BIM models to be imported into the 3D GIS platform. The successful integration of BIM and GIS has been a significant breakthrough which facilitates a number of useful applications in the planning and design of public housing development, including visual impact assessments, ridge line, vantage point and shadow analyses as well as site appraisal studies. (Figure 1)

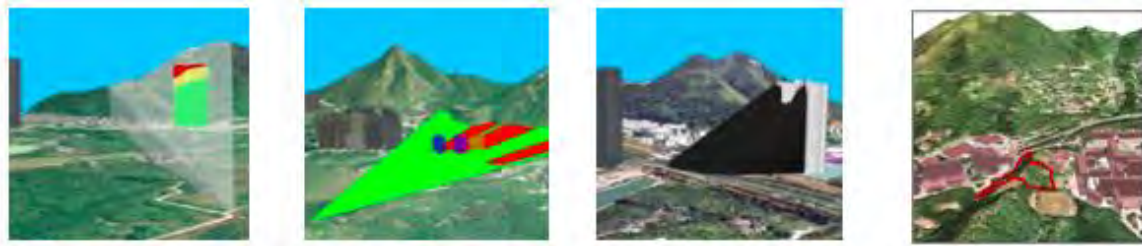

Figure 1: Left to right: Ridge line analysis, vantage point analysis, shadow analysis, site appraisal study

The 3D GIS platform contains accurate geo-spatial data on features such as the terrain, orthophoto, existing buildings and infrastructure of Hong Kong. By importing BIM models of our proposed public housing developments into the 3D GIS platform, our planners and architects can perform accurate visual impact assessments that was not possible before. It replaces the traditional method of taking photos at specific locations to create photo montages for visual assessment which are considered to be less accurate.

In addition, the integrated BIM and GIS platform is also very useful for carrying out site appraisal study as it provides a much clearer understanding of the site, its surrounding and the vicinity area in a 3D environment when compared to the traditional method of using 2D site location plans. We have successfully used the integrated BIM and GIS platform to carry out more than 60 site potential studies and visual impact assessments since 2014, as a standard application for all projects.

2.2 Scheme design stage

2.2.1 BIM for site-specific design

Given the challenges posed by individual site constraints, characteristics and environmental concerns, in 2008 HA developed a library of Modular Flat Design (MFD) to form a basis for creating site-specific block designs. BIM was used in the development of the Modular Flat Design. The precise geometry of a 3D BIM model allows for detailed refinement of the design and construction details of the Modular Flat Design. This enables us to enhance precasting and reduce material consumption for each flat on one hand, and optimizing the dimension of internal space for human comfort on the other hand. With the 3D BIM models of the Modular Flat Design, project teams can quickly assemble and create site-specific blocks and test out different designs options. It also facilitates preliminary environmental studies such as daylight analysis, and assists project teams to select the best design option to meet environmental performance targets. (Figure 2) Applying BIM to Modular flats, we are now exploring the use of BIM for quantity take-off and Statutory Submission of General Building Plans for building control.

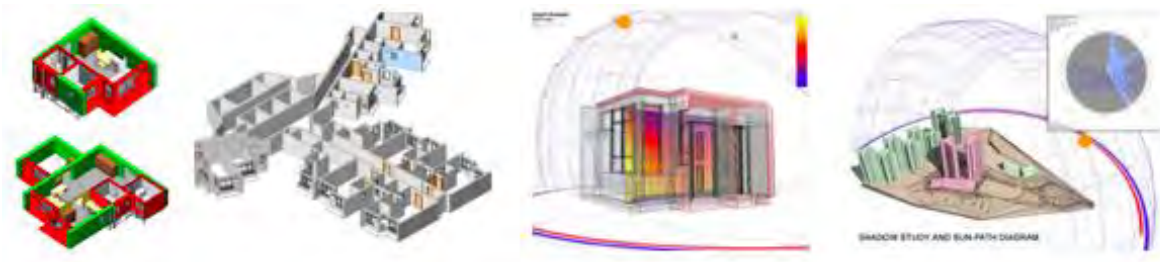

Figure 2: BIM for site specific design. (From left to right) MFD BIM models, assembly of site specific block design, daylight analysis for MFD, daylight analysis for site specific block design

2.2.2 BIM for Value Management

BIM has also been used as a Value Management tool at scheme design stage. For our project at Hin Tin Street in Shatin, we have used BIM for value management to compare the merits between a six-flat and an eight-flat per floor design option, as well as other structural design options to achieve optimum time and cost efficiency. This was made possible by integrating BIM with a construction management software to compare the construction time required between different options; and also by comparing the construction cost by extracting the quantity and materials of the building elements for comparison. (Figure 3)



Figure 3: BIM for value management at Hin Tin Street

2.3 Detail design stage

2.3.1 BIM for environmental analyses

Through the integration of BIM with other environmental analysis software, we were able to carry out detailed environmental and technical analyses at detail design stage, including lighting simulation, daylight and solar radiation analyses.

In 2014, we successfully integrated BIM with a lighting analysis software to perform lighting simulation for our project at Sheung Shui Area 36. Our colleagues discovered a way to import BIM models created in Revit® into Dialux®, a lighting simulation software, to carry out lighting analysis and calculations. The successful integration of the two softwares was a significant step forward in the area of integrating BIM for sustainable design to reduce energy consumption. (Figure 4)

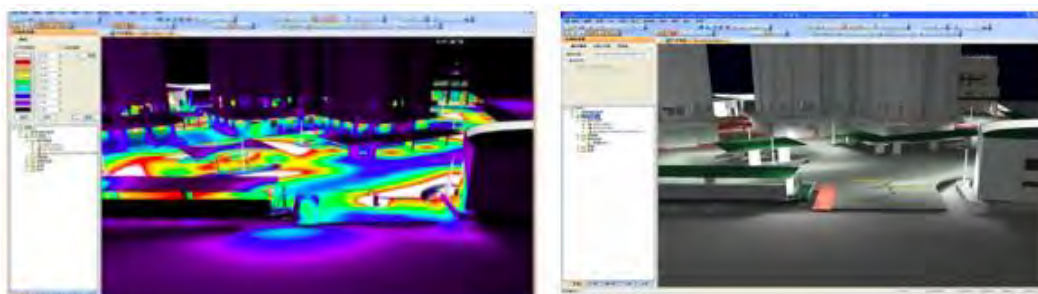

Figure 4: Integrating BIM with lighting analysis software

With the rising cost of energy and increasing environmental concerns, there is tremendous potential in the area of integrating BIM for environmental analyses. As more and more companies are launching new software to meet increased demand for building energy and environmental performance analysis, we continue to search for suitable software to widen our application of BIM. (Figure 5)

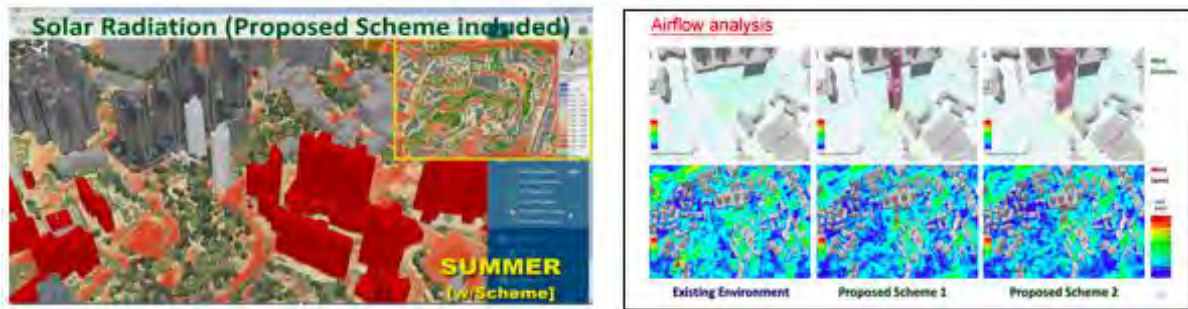

Figure 5: Testing of new software for solar radiation analysis and airflow analysis

Currently, we have integrated BIM to facilitate a number of different assessments at various stages. In the future we hope to apply BIM to facilitate more assessments, including some that may assist BEAM accreditation. (Figure 6)

Twenty five different studies to be carried out at various stages		
1 Air Ventilation Assessment (AVA)	10 Architectural Feasibility Studies (AFS)	19 Land Decontamination Study (LDS)
2 Microclimate Studies (MCS)	11 Planning and Engineering Study (PES)	20 Ground Assessment (GA)
3 Retail Viability Study (RVS)	12 Environmental Assessment Study (EAS)	21 Natural Terrain Hazardous Study (NTHS)
4 Visual Impact Assessment (VIA)	13 Air Quality Objectives (AQOs) Assessment	22 Potentially Hazardous Installations Assessment (PHIA)
5 Heritage Impact Assessment (HIA)	14 Odour Assessment (OA)	23 Tree Survey (TS)
6 Ecological Assessment (EA)	15 Chimney Emission Impact Assessment (CEIA)	24 Condition Survey for Existing Building
7 Land Use Studies (LUS)	16 Traffic Impact Assessment (TIA)	25 Land Surveying (LS)
8 Site Potential Studies (SPS)	17 Drainage Impact Assessment (DIA)	
9 Project Feasibility Studies (PFS)	18 Sewerage Impact Assessment (SIA)	

Legend: BIM currently used to facilitate assessment (in conjunction with other platforms/software)
 Potential use of BIM to facilitate assessment

Figure 6: BIM facilitates a number of different studies and assessments at various stages

2.4 Construction Stage

2.4.1 BIM for site safety planning

Safety in construction is our top priority. In the last few years, HA have been working with contractors to use BIM extensively for site safety planning to identify and resolve potential risks and problems prior to carrying out actual work on site. For the demolition of Lower Ngau Tau Kok (LNTK) Estate in 2010, our project team and contractor used BIM to create a video to plan the entire demolition process. The buildings to be demolished in LNTK were our earliest buildings with precast concrete elements. The demolition work requires careful planning in terms of the sequence of demolition and safety precautions. With the video, workers and supervisors were able to visualize and rehearse the demolition procedures safely in a virtual environment and then carry out their work subsequently on site in a precise manner. The outcome was outstanding and resulted in zero accident. (Figure 7)



Figure 7: Site safety planning for demolition of Lower Ngau Tau Kok Estate

2.4.2 BIM for construction planning

Tung Tau Cottage Area East was a project with complex topography which comprised three platforms with significant level difference, and it is our first project using BIM at the design stage. Thereafter, BIM was used to create a detailed 4D virtual construction simulation of the entire construction sequence, from site formation to foundation and superstructure. The objective was to verify the viability of the design as well as enhancing the effectiveness of the proposed construction sequence. The construction simulation was subsequently used at construction stage to monitor and compare against actual site progress. The project was completed on time and with enhanced productivity. (Figure 8)



Figure 8: Construction sequence planning for Tung Tau Cottage Area East

2.4.3 Integrated use of BIM and Radio Frequency Identification (RFID)

In 2014, HA collaborated with the University of Hong Kong (HKU) and Hong Kong Polytechnic University (PolyU) to create a consolidated BIM and RFID platform for our project at Tuen Mun Area 54 Site 2. RFID tags were embedded into selected precast building components to track the fabrication, delivery, storage and installation of the precast building components. The successful integrated use of BIM with RFID technologies may extend to other prefabricated elements in both public and private construction projects to enhance the efficiency of logistics and supply chain management. (Figure 9)

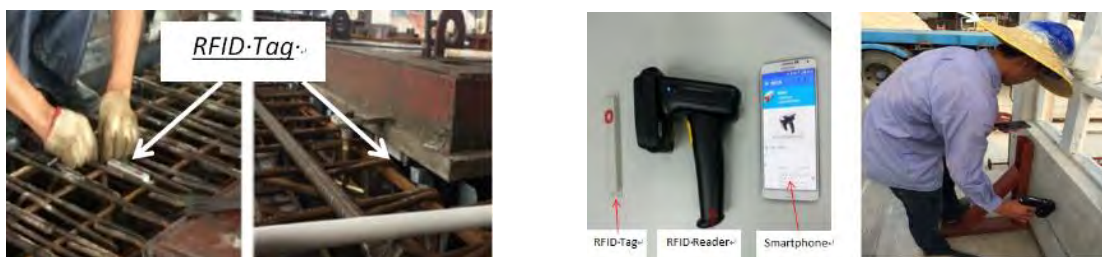

Figure 9: Installation and scanning of RFID tags embedded in precast concrete elements.

2.5 Post Completion Stage

2.5.1 BIM for facilities and asset management

To fully utilize the benefit of BIM, it is important that all the information and parameters captured in the BIM model during design and construction stages be carried forward for facilities and asset management at post completion stage.

For “Domain”, our Shopping Centre development at Yau Tong, a data rich model was created at construction stage which contains information such as construction drawings, product certificates and warranties. This data rich model is useful to our facilities managers for storage and retrieval of integrated building, maintenance and

management data for future facilities management. For our project at Sheung Shui Area 36, the complicated and dense network of underground utilities and pipes were carefully documented in the BIM model during construction stage which will be very useful for carrying out future maintenance work. (Figure 10)

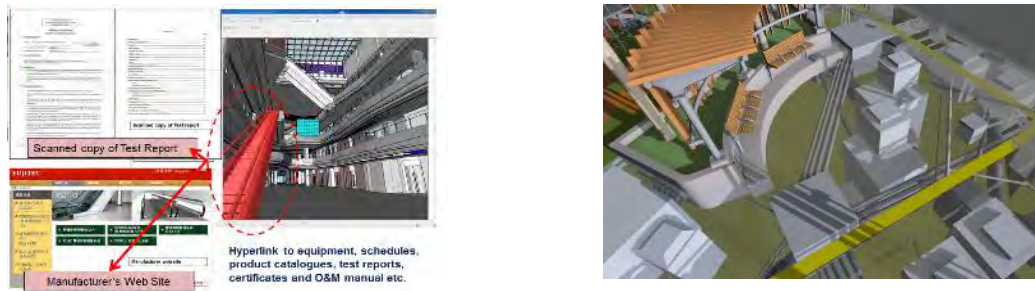

Figure 10: Data rich as-built model for Domain Shopping Centre for facility management (Left)
Underground utilities at Sheung Shui Area 36 for future maintenance (Right)

3. CONCLUSION AND WAY FORWARD

HA has successfully integrated BIM at all stages of our work from planning to design, construction and facilities management and we have seen significant improvements in all areas of our work. This integrated application of BIM has enabled us to achieve social, economic as well as environmental benefits. We have been constantly extending the use of BIM to enhance the quality and efficiency of our work towards sustainable development. Looking forward, we plan to venture into other areas of BIM research and innovation including environmental analyses, statutory submission and material specification. We strongly believe that BIM will play a major role in the construction industry in the future and HA will continue to drive for innovation in this area and put ideas into action.

REFERENCES

- [1] Fung, A. Y. (2016). Quality Public Housing in a Vertical City. Hong Kong: STBUH.

BIM Enabled Life Cycle Environmental Analysis for A Small Scale Zero Energy House

YANG Wei^a, LI Qiyuan^b, YU Hanze^c, ZHANG Yifan^d

^a School of Architecture, Tianjin University, Mainland China, walker_yang@tju.edu.cn

^b School of Architecture, Tianjin University, Mainland China, qiyuan_li@tju.edu.cn

^c School of Architecture, Tianjin University, Mainland China, hanzeyu@usc.edu

^d School of Architecture, Tianjin University, China, susan_tju@126.com

ABSTRACT

The zero-energy house manages to reduce the energy consumption during its usage phase by using high-performance containment and equipment systems, accompanying with the solar photovoltaic modules and other renewable energy utilization system. It also puts forward higher requirements to the production, construction, maintenance and replacement of building components. Therefore, its embodied energy consumption and environmental impact are usually higher than the general building. It is necessary to analyze these aspects from the perspective of life cycle assessment.

The zero energy building has a higher demand for long-term maintenance and component replacement due to the complexity of its construction and equipment system. Building information model (BIM) provides a sharing data platform for multi-disciplines during the construction and post-operation phase of projects. In this paper, the **BIM-LCA method is used to analyze the environmental impact of building materials' whole life cycles**. The Global Warming Potential (GWP) and Primary Energy (PE) of a small scale residential building under common energy-saving and zero energy consumption scenarios are compared and analyzed. The environmental impact analysis method based on BIM-LCA of the zero-energy house is discussed.

Keywords: life-cycle assessment, BIM, zero energy house

1. INTRODUCTION

In order to reduce carbon emissions and fossil fuel combustion, the international community has proposed the definition of "zero energy building" to carry out technical research since the 1970s. The definition of zero-energy building by the Department of **Energy of the United States is that "an energy-efficient building where, on a source energy basis, the actual annual delivered energy is less than or equal to the on-site renewable exported energy"**.

In different contexts, the definitions of the boundary division, measurement index, conversion coefficient and balance period of the zero-energy building have not reached a same standard. But most of the definitions for the energy consumption stay at the building operation phase, but not include the production of building materials and the energy consumed by the recycling phase. Therefore, some scholars put forward the concept of Life Cycle Zero Energy Building (LC-ZEB). For example, the study of Maurizio and others introduces the concept of life cycle zero-energy consumption. They calculate the following factors: final energy as metric, primary energy as metric, life cycle energy driven energy balance under the condition of energy balance in order to emphasize the importance of considering the energy content of building materials in the study of the zero-energy building. Hernandez **introduces the definition of "life cycle zero energy building" with a simplified calculation formula: Annual Life Cycle Energy (ALCE) = Annual Energy Use (AEU) + Annual Embodied Energy (AEE) = 0**. A more objective evaluation of LC-ZEB can only be made by a comprehensive consideration of AEU and AEE (Table 1).

	Formula	Definition
Operational zero energy building	$AEU = 0, AEE > 0, ALCE > 0$	Refer only to the energy that is used in the operation of the building.
Life cycle zero energy building	$ALCE = AEU + AEE$	Accounting for the embodied energy of building components together with energy use in operation.
Energy producing building	AEU is negative, $AEU > AEE$, ALCE	

Table 2

The Sunflower zero-energy house discussed in this paper is analyzed of the environmental impact of buildings in the context of life cycle based on the zero energy consumption during use stage.

2. METHODOLOGY

In this paper, a small-scale zero-energy solar house – “Sunflower” – is selected as a case to analyze its energy consumption and life cycle environmental impact. As the general energy saving house used to compare with the Sunflower, its structural system, internal and external decoration, home appliances, building exterior shape, window and wall ratios are all the same as the Sunflower. Its energy system design parameters, heat transfer **coefficient of transparent structure are both following the latest version of Tianjin’s Design standard for energy efficiency of residential buildings.**

	General energy-saving house	Sunflower
U-value of exterior doors and windows	≤ 1.5 ($U = 1.46 [W/(m^2 \cdot K)]$)	≤ 1.0 ($U = 0.814 [W/(m^2 \cdot K)]$)
Source of electricity supply	Urban power network	PV power generation system
Heating system	District heating boiler (Gas)	Solar radiant heating
Cooling System	Electric air conditioning	Radiant sky cooling system

Table 2

At this stage, most of the residential buildings are still using the urban power network, electricity air-conditioning for cooling and gas fired boiler for heating, so the general energy-saving building should also follow the above energy system while calculating its energy consumption in use stage and environmental impact of equipment and materials (Table 2).

The environmental impact at all stages of the life cycle can be calculated by modeling a detailed (including envelope structure, decoration materials, and energy systems) model in Revit of which the information can be read in Tally. At the same time, the Sunflower model is established in the Design Builder energy simulation software to calculate the energy consumption of the use stage. Through the above data, in the context of the life cycle, the zero-energy **house’s Global Warming Potential (GWP), and Primary Energy (PE), non-renewable primary energy consumption (NPE)** are discussed.

2.1 Life cycle standards and system boundary

In this paper, the life cycle assessment of the solar energy zero-energy house takes into account two key indicators: total primary energy consumption, and global warming potential (GWP). Energy consumption during the operation phase include heating, cooling, lighting, domestic hot water (DHW), and equipment energy consumption (Figure.1). By using Tally for the calculation of life cycle environmental impacts, the default system boundary of the building products is set to include the manufacturing, transportation, construction, maintenance, replacement, demolition and recycling stages. Therefore, in this study, the transportation process is only considered in the material manufacturing stage. The transportation to and from the site in the construction and waste disposal stages are not included.

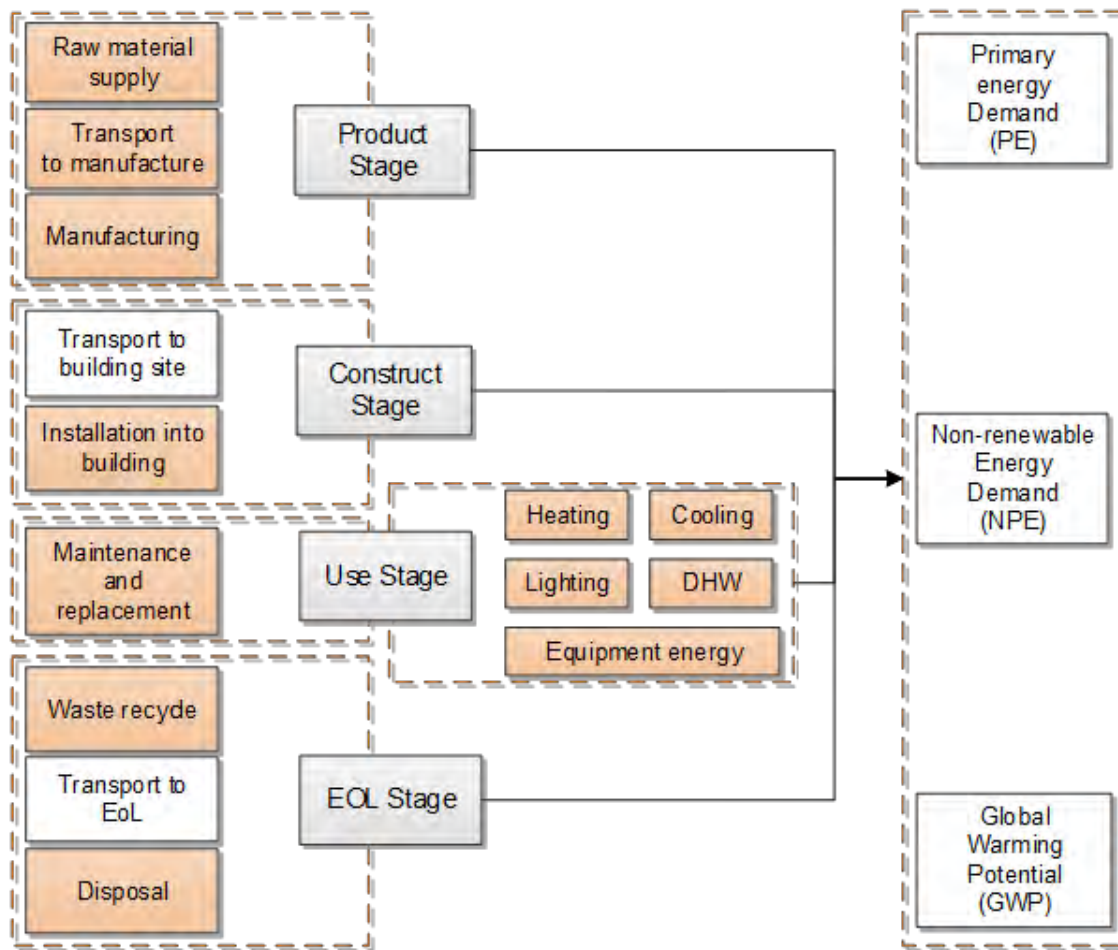

Figure 1: System boundary of the study (The orange box indicates the boundary of LCA)

2.2 Tools and indicators

In this study, Revit is chosen as the BIM/Revit tool to describe the structure and material of the building. The add-in Tally is chosen mainly for the life cycle assessment. Tally is able to link the detailed construction layers of the building model to obtain the geometrical and material information from it. In the meanwhile, Tally's building material LCI data is derived from the GaBi database and its lifecycle impact assessment is based on the TRACI 2.1 standard.

Most of the life-cycle inventory data for building material applied in this study are based on Tally's default database. A small amount of the missing data are quoted from the Ecoinvent and Ökobau.dat databases. At present, China has not yet established a complete building life cycle inventory database for building products which can have good interoperability with the BIM software. Although the use of European and American databases for China's domestic building case study will lead to some biases in the absolute values of the results, the outputs can still provide evidence with the relative values in the comparison of the solutions with different the energy-saving levels on the same building prototype. Table 3 shows the LCI data sources for the major materials applied in the case study and the rate of recovery in the end-of-life stage.

This study mainly focus on the examination of primary energy consumption and greenhouse gas emissions. Other environmental impact types, such as Ozone Depletion Potential (ODP), Acidification Potential (AP), etc., are not discussed in this paper.

Material's name	Database	End of Life
Steel	GaBi(Tally)	98% recovered 2% landfilled (inert material)
wood	GaBi(Tally)	14.5% recovered (credited as avoided burden) 22% incinerated with energy recovery 63.5% landfilled (untreated wood waste)
glass	GaBi(Tally)	100% to landfill (inert waste)
PV system	LEGAP(Ecoinvent)	3.7% landfilled 27.2% recovered 69.1% heating and regenerative cycle

Table 3

Figure 2 shows the mind processes of this article. The energy consumption data of building used in different scenarios simulated by Design Builder is imported into Tally, and the LCA results are output. Then the Global Warming Potential (GWP) and Primary Energy (PE) of the building under common energy-saving and zero energy consumption scenarios are compared and analysed.

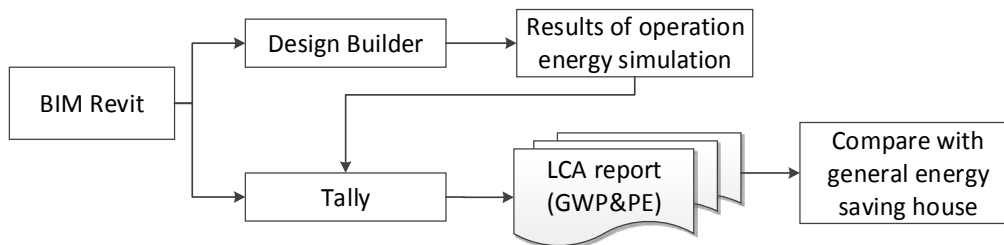

Figure 2: Technical roadmap of the methodology

3. CASE STUDY

3.1 Building model (Site)

Table 4 reports the main site Geographical and climatic data, as well as some building features.

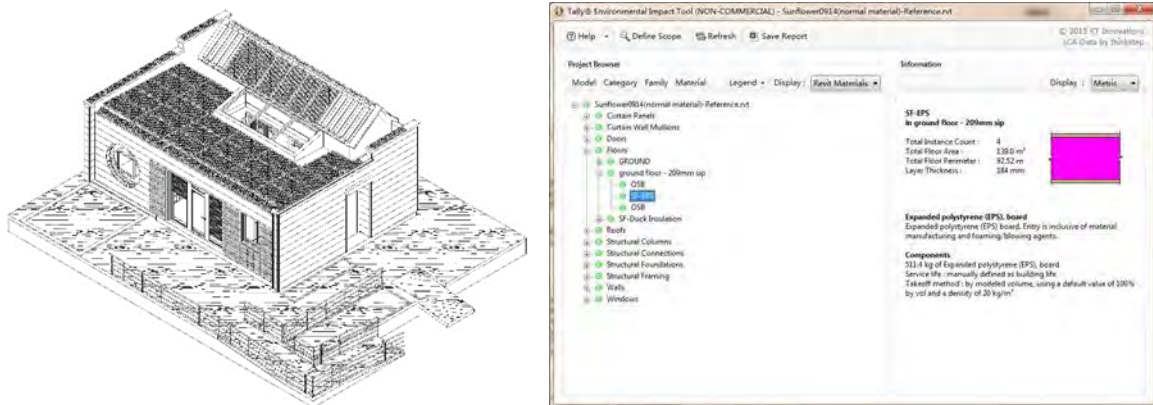

Figure 3: The image of the interface of Tally and the Revit model of Sunflower

3.2 Description of the building

Sunflower is a small single-story residential house with a light atrium in Tianjin, China. It has a steel structure based on an independent basis, mixed with light timber framed beams by Parallel strand lumber (PSL) and the Structural Insulated Panels (SIP) system.

The house is occupied by 3 people. The glazing area to the gross wall surface ratio is 30.7% for the south facade, because of the glass door in the east, the east window-wall ratio is 26.64%.and 4.35% for the north one.

3.3 The building envelope

In order to meet the design standard of the zero-energy house, the design of "energy control" must be done. Before using renewable energy, the standard of low energy consumption should be achieved through strengthening insulation and improving energy efficiency. Table 5 reports the material and their thermal performance respectively. **The heat transfer coefficients of the house's envelope structure are all under the requirements of Design standard** for energy efficiency of passive low-energy residential buildings. Table 5 presents the thermal properties and the material composition of the building envelope.

External structures	U-value	External structures	U-value
External wall	0.15	Window	0.8
Ground	0.15		
Roof	0.15	Door	1.0

Table 5

3.4 The building service

Sunflower uses the composite energy system basing on radiant panels. The energy of domestic heating water (DHW) comes from solar through the tubular solar collector which locate at the south and north slopes of the roof. The functioning area of the tubular solar collectors is 2.08m².

The lighting system of the house is designed to minimize the energy consumption while meeting the specified demand of the rooms. The lighting fixtures are Compact fluorescent lamps (CFLs). The lighting power is set to 5W/m².

The electric power of the house comes from the solar photovoltaic system by the solar photovoltaic cells which **locate on the roof and walls. The Mono crystal silicon battery module's efficiency which placed at the sloping roof, flat roof, and parapet can reach 15.9%** in the standard measurement state, the ones at the east, west and south façade can reach 14.8%.

The main parameters in Design Builder: Winter: 20°C, Summer: 26°C; Relative humidity: 40 - 55%; Fresh air volume: 30m³/h/p; Cold air infiltration: 0.4 ach/h.

4. DISCUSSION OF THE RESULTS

4.1 Comparative analysis of the use stage

4.1.1 Energy consumption of the general energy-saving house

After entering the climate parameters of Tianjin in energy consumption simulation software and setting the transport efficiency of the gas boiler heating system to 0.9, the COP of air-conditioning to 4.0. It comes with the result that the consumption of gas is 2870.94kwh, of electric power is 6375.54kwh. These results then are imported into Tally, converting to the GWP of 412062.3kwh, primary energy of 5011316.45MJ.

4.1.2 Energy consumption of the Sunflower during the operation stage

The energy consumption of Sunflower during its use stage mainly from the electric power except the solar power used by heating, cooling and hot water. PV panels on the roof along with facades of buildings can provide adequate electric power for the building. According to the statistics of PV power generation in Design builder, the annual output power from photovoltaic panels is 7221.9Kwh/a. The net balance of electric power by PV is 3666.03kWh/a. Figure 4 shows the relationship between electricity production and consumption for the whole year. The spare electric power can be stored in the battery and also be delivered to the urban power grid through the inverter.

Viewing from the results for annual energy balance, PV plates' power generation is significantly greater than the building's power consumption. Therefore, we assume that the excessive electricity would be transferred to the urban power grid. If less PV modules were applied and the annual energy balance is near zero, then the off-grid solar power system could apply. However, it must be equipped with batteries, which will cost up to 30% - 50% of

the whole power generation system. As the common domestic batteries' lifespan is 3 - 5 years, the replacement will lead to additional costs and embodied impacts.

4.1.3 Comparative analysis of the primary energy

The electric power consumption of Sunflower during its use stage mainly comes from the PV panels except for a small part of December from the urban power grid. So the spare electric power generated by the PV panels can be delivered back to the grid and used by other buildings. The GWP and primary energy calculated from transmission electric power are negative. Table 6 and Figure 5 shows the comparative analysis of the GWP and primary energy between general energy saving building and Sunflower.

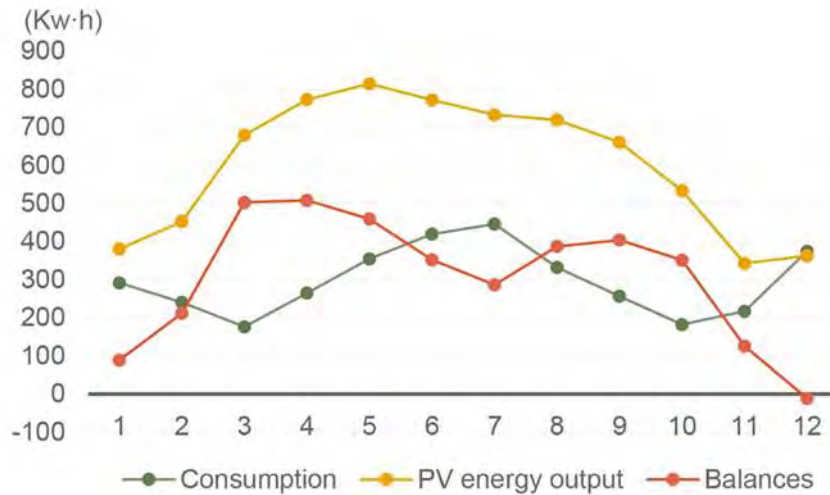

Figure 4: Sunflower's power consumption, PV energy output and power balances (Monthly)

In order to maintain the uniformity of database sources, the calculation method of primary energy consumption and GWP used in this article is derived from Tally's average conversion coefficient of China's electricity and gas. In the calculation of the delivery of power from PV panels to the urban power network, the loss rate of China Power network is 6.64% as published.

	GWP(kgCO ₂ eq)	PE (MJ)	NPE (MJ)
General	412062.30	5011316.46	4741124.87
Sunflower	-196220.12	-2318219.83	-2179992.07

Table 6

4.2 Comparative analysis of the LCA of building materials

It can be read from the figure.6 that the PV panels take the largest part of the environmental impacts of Sunflower, although their power generation capacity can override the embodied energy and carbon. The PV panel not only has a large environmental impact at the construction phase, it also needs replacement during the usage phase due to its operation life is around 15 - 25 years. This article does not consider the improper cleaning and maintenance, resulting in the annual damage and impact during the service life of the PV modules. Therefore, the power output of the PV system might be over-estimated under the actual situation, and the earlier replacement **could lead to greater environmental impacts. In addition, the replacement of the building's out doors and windows** will also cause an increase in the value of material environmental impacts.

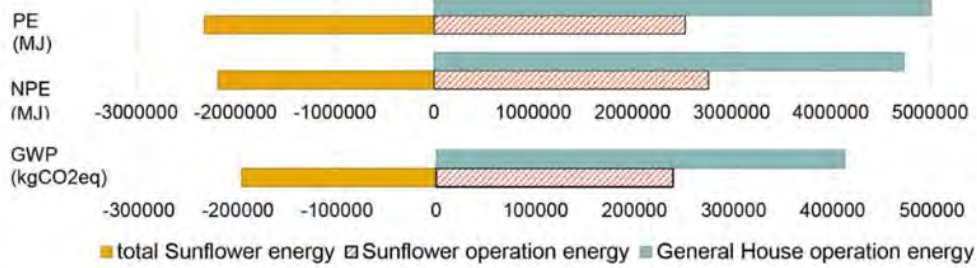

Figure 5: Comparison of PE, NPE, and GWP of operation energy consumption between Sunflower and general energy saving building

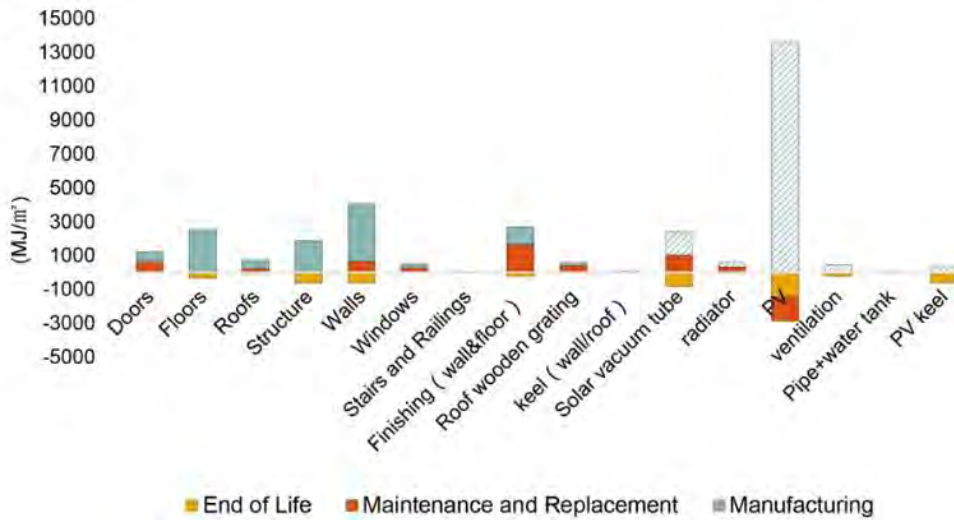

Figure 6: Life cycle primary energy demand of Sunflower's material

4.3 Analysis of total life cycle energy consumption

Although the environmental impact of Sunflower's materials is greater than that of the general energy saving building, the energy of the materials takes a small part of the whole life cycle energy consumption and this difference value can be covered by the electric power generated by the zero-energy house. So from this life-cycle perspective, Sunflower's energy consumption is still close to zero (Figure 7).

Figure 8 shows the cumulative GWP value of Sunflower over time. There is a significant increase in carbon emissions in the 20th and 40th years when the PV panels require replacement. At the end of the life time, PV panels can be recycled after replacement or demolition, and the life cycle impacts of the building can also be reduced. The reduction of GHG emission from material recycling is included in the value of 'maintenance and replacement'.

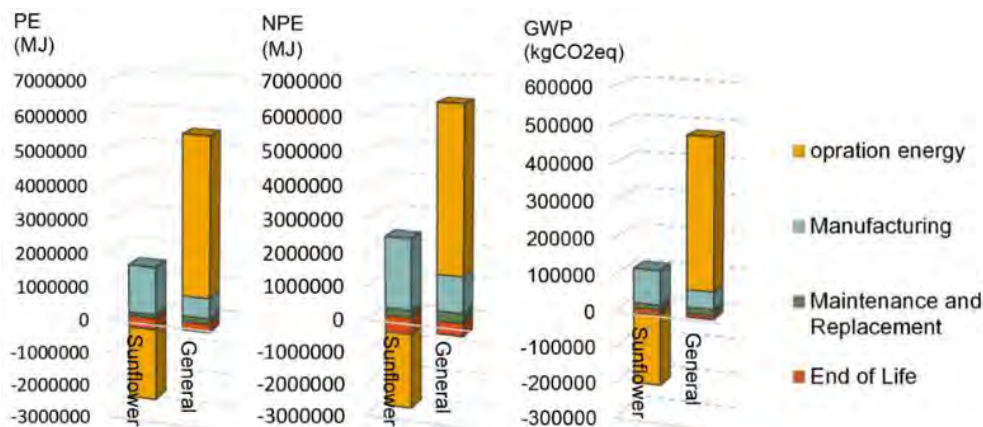
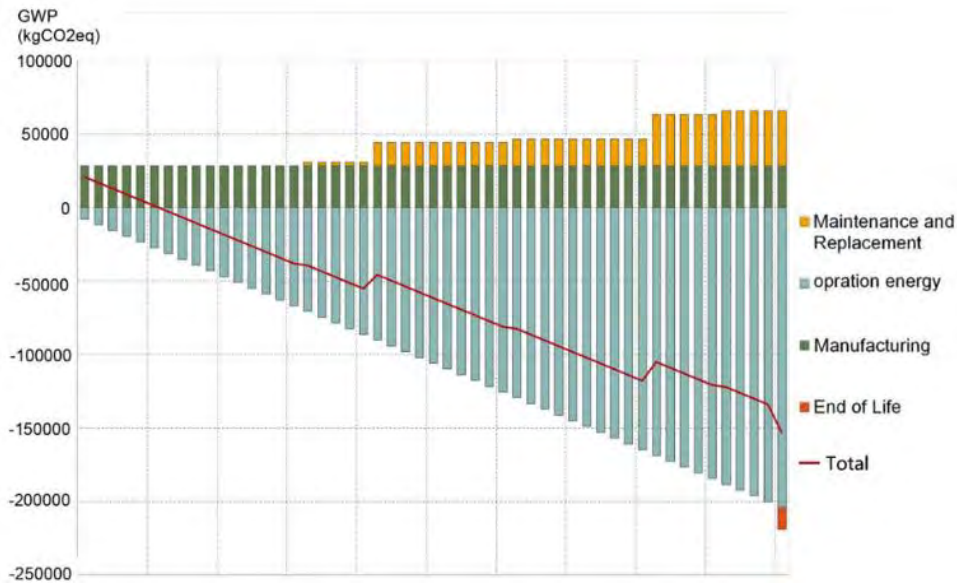

Figure 7: Comparison of the life cycle environmental impacts between Sunflower and general energy saving building



5. DISSCUSION AND CONCLUSION

By using the BIM enabled LCA calculation method, the life-cycle energy consumption and GWP of a small scale residential building at the general energy saving standard and positive energy level are analysed and compared. **The conclusion is that in order to understand the environmental performance of the “zero-energy buildings”** comprehensively, it is necessary to consider their energy consumption and environmental impacts during the whole life-cycle.

In this study, a detailed model with the building construction system and equipment system is established in the BIM model, adopting with the LCA tool Tally, which is compatible with Revit. The result shows that it is necessary to carry on the analysis at the BIM standard data platform which shares data through multiple disciplines and phases due to the complexity of the envelope construction and the renewable energy system of the zero-energy buildings.

Despite the interactivity between Design Builder and Revit, the Revit model cannot be easily docked with the original model. Therefore, during the process of energy simulation, the model was rebuilt in the Design Builder to ensure the accuracy of energy consumption simulation results.

Although the results show that the positive energy scenario have obvious ecological benefits, it costs much higher in the new construction stage. In the future study, the life cycle cost of the building will be included in the scope of the study, aiming at a more comprehensive evaluation of zero-energy buildings.

ACKNOWLEDGEMENT

This contribution is supported by Project 51478294, 51628803 funded by NSFC, the Program of Introducing Talents of Discipline to Universities (B13011), and by the International S&T Cooperation Project 2014DFE70210 funded by the MOST. The reviewers had provided valuable advices on the revision of the contribution.

REFERENCES

- [1] China Electricity Council, Basic statistics list of power, About Organisers [online]. <http://www.cec.org.cn/guihuayutongji/tongjixinxi/niandushuju/2016-09-22/158761>. [2016-10-3].
- [2] Design standard for energy efficiency of passive low-energy residential buildings (DB13 (J)/T177-2015)
- [3] Hernandez, P. and Kenny, P., 2010. From net energy to zero energy buildings: Defining life cycle zero energy buildings (LC-ZEB), *Energy and Buildings*, 42(6), 815-821.
- [4] Houlihan Wiberg, A., Georges, L., 2014. A net zero emission concept analysis of a single-family house. *Energy and Buildings*, 74,101-110.
- [5] Lu Y., 2016. A Study on BIM-LCA based Green Building Design Optimization. MD. Tianjin University.
- [6] Maurizio C., Francesco G., 2014. Energy life-cycle approach in Net zero energy buildings balance: Operation and embodied energy of an Italian case study. Thesis (PhD). Name of University.
- [7] Sartori, I., Napolitano, A. and Voss, K., 2012. Net zero energy buildings: A consistent definition framework. *Energy and Buildings*, 48, 220-23.
- [8] Shady A., 2016, Towards regenerative and positive impact architecture: A comparison of two net zero energy buildings, *Sustainable Cities and Society*,26, 393–406
- [9] Shicong Z., Wei X, 2013. Research on definition development and main content of zero energy building. *Building Science*, 29(10), 114-120.
- [10] Tianjin energy efficiency design standard for residential buildings (DB29-1-2013)
- [11] Torben V., 1977.Dimensioning of the solar heating system in the zero energy house in Denmark, *Solar Energy*, 19, 195-199 .
- [12] US Department of Energy. Zero Energy Buildings [online]. <http://zeb.building-green.com> [2014-05-26].
- [13] Wolfgang F., 1997, Life-cycle energy analysis: comparasion of low-energy house, passive house, self-sufficient house
- [14] YANG XQ.,2011. Research on design and technical strategies of zero-energy solar house prototype. PhD. Tianjin University

The Use of FTA (Fault Tree Analysis) to Evaluate the Contribution of BIM Platform to The Environmental Quality on Rehabilitated Buildings

Fabiana DIAS DA SILVA^a, Monica Santos SALGADO^b

^a*Petrobras, Brazil, fabyds@gmail.com*

^b*Federal University of Rio de Janeiro, Brazil, monicassalgado@ufrj.br*

ABSTRACT

Several studies recognize the potential of interventions in existing buildings that ensure sustainability and improve the environmental quality of cities. The rehabilitation of these constructions reduces the consumption of natural resources and the intervention in new lands. In the context of sustainable design, the use of tools that support the integrated and collaborative work as Building Information Modeling (BIM) offers a great potential to identify and propose interventions that implement sustainable practices both in new buildings as in rehabilitation of existing buildings. In order to evaluate the possibilities of the use of BIM Platform in a building environmental performance analysis a case study on the head office of an important Brazilian company at Rio de Janeiro was performed. **The original design of the building is a result of a national design contest and its construction was performed in the 70's.** Improving the environmental performance of the building was one of the principals of the rehabilitation design, which used AQUA HQE environmental assessment and the Brazilian energy efficient performance PROCEL as its parameters. The company design team defined the environmental quality profile for the rehabilitation, later; they hired a design office to develop the design using BIM Platform. The design office developed a digital model that could work in an integrated and multidisciplinary manner. However, there has been little integration between the definition and verification of categories and environmental targets of AQUA HQE method and the employment of BIM model. This article is part of a PhD Thesis, and presents the results of the analysis of the potentialities of BIM Platform through the use of FTA – Fault Tree Analysis Method. The results suggest that the use of BIM model since the beginning of the rehabilitation design process could brought more dynamic and integrated design solutions. Therefore, one must review the practices of design process that aims for integrated design solutions through collaborative work.

Keywords: rehabilitation, environmental quality, BIM

1. INTRODUCTION

Since the 1990's, the civil construction industry is facing different challenges regarding innovation in both design process and construction management. In this period, the increment in the discussions concerning sustainability in the construction production was observed, as well, as the spread of different certification systems for "green" constructions. In general, the tools are attempting to: achieve continuous improvement to optimize building performance and minimize environmental impact; provide a measure of a building's effect on the environment; and set credible standards by which buildings can be judged objectively. [3]

In this scenario, the rehabilitation of buildings enables the extension of the buildings' life cycle through the improvement of energy performance and comfort conditions for occupants. Therefore, the rehabilitation becomes an opportunity to achieve sustainability requirements, through taking into account the needs of current users and ensuring the extension of building's life cycle for future generations

Thus, this paper submits a case study where the BIM platform had been used for the rehabilitation of an existing building, aiming to facilitate the design management process and the inclusion of the requirements of AQUA environmental certification. The AQUA certification is an adaptation of the French method HQE – High Environmental Quality.

This paper is part of an ongoing doctoral research. The first results have been presented on WSB 14 Barcelona. The final part – presented on this paper – includes the use of FTA (Fault Tree Analysis) to evaluate the faults during design management process for the development of sustainable buildings.

2. ENVIRONMENTAL CERTIFICATIONS

Environmental certifications are tools that seek to evaluate and measure the environmental performance of buildings. Each country has developed its environmental reference, considering the specific characteristics of the different regions. Reed et al. [3] point out that the systems of assessment of environmental performance aimed at promoting continuous improvement to optimize building performance, minimize environmental impact and to establish reliable standards by which buildings can be evaluated objectively.

Only recently, Brazil has given its first steps towards the discussion and the adoption of methodologies that might help the production of building with high environmental quality. Among the foreign methods that arrived in the country, it is possible to highlight the LEED™ North American system (Leadership in Energy and Environmental Design), the French method HQE® (Haute Qualité Environnementale) which was adapted to the Brazilian reality into AQUA HQE process, the British method BREEAM and SBTool, developed by iiSBE. The first two methods have been adopted by Brazilians constructors, particularly on the Southeast region of the country.

It is important to highlight the role of the environmental certifications regardless the preference provided by stakeholders. It is understood that the main merit of proposals is in helping architects and engineers to re-think the design process aiming at the incorporation of solutions that may contribute positively for the environmental quality of the building.

Chart 1 presents a comparison among the main certifications adopted in Brazil. Through this analysis, it is possible to point out that AQUA HQE and SBTool methods have some advantages in comparison to BREEAM and LEED, as they offer greater flexibility and a demand for an integrated design process. Solutions and practices adopted will depend on the context of each architecture design and each phase of the project, and should be consistent with the previous step and the intended goals which must be defined early in the design process. Thus, there is no prompt model that can be used without analyzing the specificities of each demand.

Certification		BREEAM (1990)	LEED (1998)	SBTool iiSBE (1996)	HQE (1996) AQUA-HQE (2008)
Method	Country of origin	United Kingdom	United States	International group	France/Brazil
	Categories	Management; Health and wellness; Energy; Transport; Water management; Materials; waste; Land use and ecology; Pollution and contamination; Innovation	1-Integrative think; 2 Energy; 3- Water; 4 Waste; 5- Material; 6 Location and transportation; 7 Sustainable sites; 8- Health and human experience; 9- Regional impacts; 10 –Global, regional and local; 11- Innovation	Presents numerous requirements of the three dimensions of sustainability: environmental, social and economic.	4 groups which are divided into 14 targets and about 160 aspects related to: Eco construction, eco-management, comfort and health
	Evaluation	Percentage over the total achieved and classification level: correct, good, very good, excellent and outstanding.	By points from a checklist, which classifies the building into four levels (from certified to platinum)	Presents 9 categories and 44 parameters related to both qualitative and quantitative issues.	Certifies the process and the product through Project management system (SGE) and Environmental quality framework (QAE)
	Performance analysis	Sum of points obtained in 10 categories and applications the environmental weighting factor	Prescriptive: the points are obtained meeting the requirements of credits.	Rating the performance	Rating the performance

Chart 1: Comparison among environmental certifications

Certification		BREEAM (1990)	LEED (1998)	SBTool iiSBE (1996)	HOE (1996) AQUA-HOE(2008)
	Design Phases considered	From Design to maintenance of building	From Design to maintenance of building	Building life cycle	Design and construction
Method	Results	Overall percentage and by category and the rating level. Partial certificate of the design phase.	The result is the sum of points obtained on Evaluation stage.	The result is called sustainable note and it is the three sustainable dimensions synthesized.	The final result is in compliance with environmental quality profile
	Flexibility / Adaptability	The system considers the regional differences and gives preference to local regulations.	Regional credits restricted to the United States. ACPs possibility of including local specificities.	Contextualized assessment to regional specificities. Users can make changes in the parameters.	The entrepreneur sets the environmental performance profile according to the features of the enterprise
	Certification process	BREEAM Assessor defined by the client verifies if the project meets the certification requirements, validates the evidence obtained and requests the final formal certification	After registration, the project team should collect information and perform calculations to meet the prerequisites and credits. The evaluation is made by the USGBC.	1) Registration. 2) Pre-assessment by the designer using the Web-based tool or filling the system spreadsheet 3) Verification by iiSBE 4) Validation. 5) Certification.	Certification phases: program, design and implementation. The use and maintenance phase can also be certified.
	Transparency	The assessment is based on available technical manuals for free	The evaluation is based on categories of environmental impact. The weight of credits is not explained.	The methodology is explained through the certification reference.	The methodology is explained through the certification reference.

Chart 1: Comparison among environmental certifications (Part 2)
Source: Elaborated by the authors

2.1 BIM and sustainable design

Among the possibilities offered by the information technology aiming to facilitate this process, the BIM platform – Building Information Modeling – is highlighted, since it allows the conjugation of all aspects involved in the design process and verification of the impact of design decisions identifying incompatibilities.

The Building Information Modeling (BIM) is an anticipation of the reality that deals with developing a set of representations (models) of the construction information. Thus, a database is built which may be used and updated **during all its life cycle. The “BIM” platform emerged at late 1970’s in the United States and Europe, mainly in Finland [4]. The migration for the “BIM” platform is relatively slow in Brazil, and still passes through an acceptance process by the offices.**

In this sense, it must be highlighted the research developed by Olin’s et al [2] informing the potential of BIM platform as a cooperation instrument, that can be used for both the management of documents and information, for project management, budgets control, planning, schedule, environmental simulations and to analyze variables related to feasibility, costs, energy and environmental performance. The authors add that BIM advantages are not limited to the conception phases of the design and construction, and they may be useful throughout all life cycle of the building such as maintenance, rehabilitation, analysis of space usage and environmental management as well as costs of the operational performance.

3. CASE STUDY

To provide continuity to the survey about the possibilities of the use of BIM Platform in a building environmental performance analysis, a case study was accomplished in a company headquartered in the city of Rio de Janeiro. The original design of the building that lodges the company was chosen by means of a competition organized by the company through the Institute of Architects of Brazil (IAB-RJ), in 1967. The building conception includes precepts of bioclimatic architecture, which should follow the main requirements defined in the official announcement: the maximum occupation of the land with minimum of vertical circulation; the valorization of the

social contact in pleasant environments and the desire of becoming a landmark in the city's architecture, highlighting its landscape, but integrated with its surrounding. [1]



Photo 1: Construction and its surrounding

Around 2008, remodel works were performed in the area of air conditioning aiming at increasing the energy saving. To check the efficiency of those new systems, the works were performed in the 6th floor, which has been totally reformed [1]. The enhancement in this floor has oriented the development of the Basic Design for the other floors and, in 2013, the rehabilitation design has been initiated, aiming at the adequacy to the current and future needs of the construction.

3.1 AQUA HQE and BIM platform for rehabilitation process

The development of the renovation/ requalification design was divided into four stages: Conceptual Design, Basic Design, Detailed Design and Construction. Firstly, the Conceptual and Basic Design Phases were accomplished, using the conventional 2D software for design. The option of making models using BIM platform took place in the Detailed Design due the complexity of the design. Moreover, the interest in adapting the building to meet the requirements of AQUA process justified even more the production of the model in BIM. In relation to the environmental certification, an option was made by the AQUA process in light of its resilience, as the stakeholder must prepare the Environmental Quality Profile (QAE) according to the specificities of the construction. [5]

One of the main issues that led to the decision of BIM model construction was the possibility of creating a database of the project. This will facilitate the operation and maintenance activities of the building as well as the accomplishment of future reforms. Therefore, it is necessary to enable and to familiarize the professionals that are responsible for the building maintenance with the use of this tool, in order to keep the database always updated.

Regarding AQUA certification for existing buildings, it is worth adding that there is no need to perform simulations, only the proof by calculation, reports, standards and inventories. In the case studied, nevertheless, considering the parametrical modeling, it would be even possible to perform such simulations.

3.2 The use of fault tree analysis

The Fault Tree Analysis, according to Vesely et al [6] is a systematic method for information on a system. The proposal is a deductive analysis to resolve an unwanted event exhaustively searching for the causes of failure, thus clearly showing all the different interfaces that are necessary to reach the undesired event (top event). The method can be used to evaluate a proposed project according to its safety and reliability, optimize test and maintenance, quantifying the probability of failures and also identify the weaknesses of a system, the effects of human error and effective improvements to a system. Figure 1 shows schematically the symbols used for the construction of a fault tree.

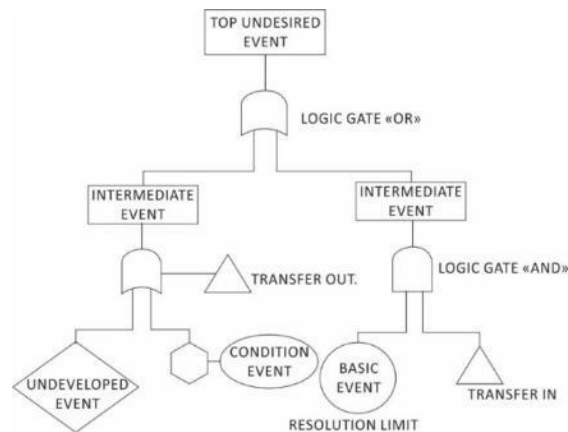

Figure 1: Example of a fault tree

The undesired top event that was explored is: "The project environment quality profile has not been established in a collaborative process".

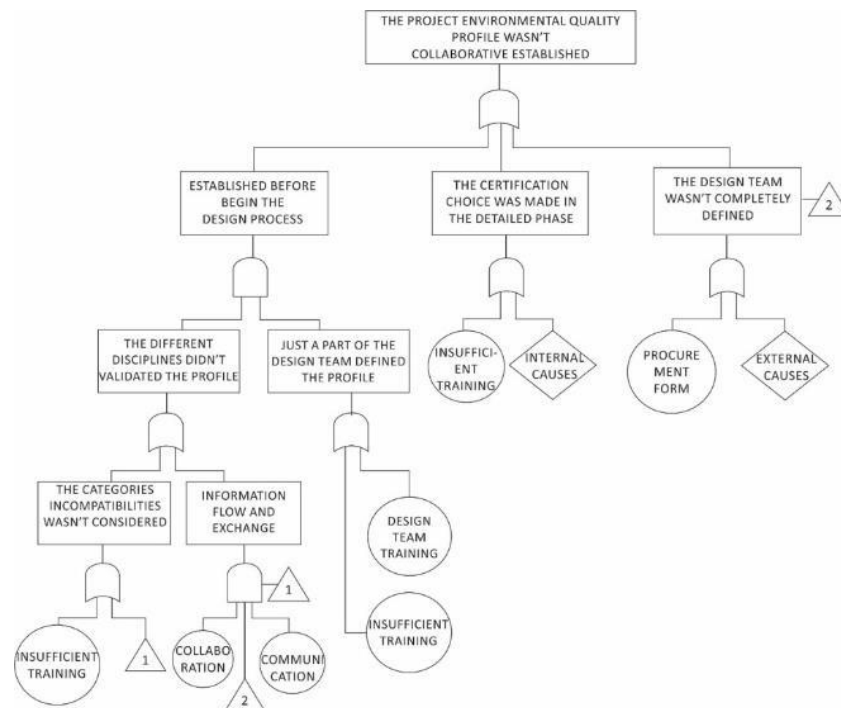

Figure 2: Fault tree construction

From the top-event, began the construction of the FTA, as shown in Figure 2. Among the evidences of the first level of the tree, two intermediate events should be highlighted: environmental profile has been established before **the beginning of design process** and **the design team wasn't completely defined**.

The application of FTA on the case study has revealed four aspects to be considered in order to improve BIM implementation: (1) The lack of qualification in the potential offered by BIM Platform; (2) insufficient training; (3) the working method used by the design team to develop projects; and (4) the obstacles to design projects with high environmental quality.

4. DATA ANALYSIS AND CONCLUSIONS

In this case study BIM has not been adopted aiming the improvement of the environmental performance of the rehabilitated building. The case study analyzed through FTA method revealed that, in fact, the use of BIM has been adopted exclusively for its potential in use-operation and maintenance phase and to overcome in the design phase the complexity of the facilities design.

If BIM Platform had been considered since the beginning of the rehabilitation process it probably would bring more efficiency and transparency to the process, not only in what refers to meet the sustainable requirements as to the preparation of the necessary documentation for certification.

The application of FTA method allows the evaluation of unwanted events as result of aspects related to the design process management approach adopted in this project, which needs to be revised for the realization of new projects. The most important lesson learned with FTA analyses is the necessity to overcome the sequential view of the design process with high environmental quality.

ACKNOWLEDGMENT

The author thanks National Council for Research and Development – CNPq – and Brazilian Petroleum Corporation - PETROBRAS – for the financial support of this research.

REFERENCES

- [1] GUAISTI, Jacira M. G. (2008) Diretrizes de sustentabilidade de edifícios de escritórios: estudo de caso do Edifício Marechal Adhemar de Queiroz, 2008 Thesis (Master degree in Management system). Universidade Federal Fluminense, Rio de Janeiro.
- [2] OLIN, J.; JYLHA, T.; JUNNILA, S.. Virtuality: What does it means for FM?. In: CIB W070, W092 & TG72 INTERNATIONAL CONFERENCE ON FACILITIES MANAGEMENT, PROCUREMENT SYSTEMS AND PUBLIC PRIVATE PARTNERSHIP, 1, 2012, Cape Town. **Proceedings Cape Town: University Of Cape Town**, 2012. p. 20 - 26. Available in: <<http://www.cibworld.nl/>>. (Access on August 23rd, 2016).
- [3] REED, R. et al. (2009) International Comparison of Sustainable Rating Tools. *Journal of Sustainable Real State*, v. I. n. 1. Available in: <<http://www.costar.com/josre/JournalPdfs/01-Sustainable-Rating-Tools.pdf>>. (Access on: August 23rd, 2016).
- [4] RIBEIRO, A. B. (2013) O potencial das ferramentas de modelagem digital para a construção sustentável. In: IV COLÓQUIO DO PROARQ, Rio Janeiro, Anais... Rio de Janeiro: PROARQ/FAU/UFRJ.
- [5] SILVA, F.; SALGADO, M.; CAMPOS, A. The potential of BIM Platform in building modernization aiming to environmental certification. In: WORLD SUSTAINABLE BUILDING 2014: ?Results...Are We Moving as Quickly as we Should? 2014, Barcelona. *Proceedings...* Madrid: GBCe, 2014.
- [6] VESELY, W et al. (1981) *Fault tree handbook*. Washington: U.S. Nuclear Regulatory Commision.

Sustainable Buildings with BIM

Peter KONCZ^a

^a GRAPHISOFT Asia Ltd., Hong Kong SAR, pkoncz@graphisoft.com

ABSTRACT

In today's world, cutting the design and construction cost of a building is not enough to make it a sustainable project. Clients and developers need to think of the operation phase, where a lot of resources are spent to maintain the internal comfort requirements dictated by regulations or the occupants. Cutting operation cost by optimization of energy consumption is one of the key ways to make a truly lean project and increase the return on investment for building owners.

There are two main approaches to cut energy consumption. One is using expensive, but high-end building systems to meet internal requirements, although this requires some time to return the extra dollars. Another way is to design buildings that uses low-carbon materials and demand less energy, therefore lower performance systems can be used, decreasing the overall environmental footprint of the project. A smart building design with good materials can even result in zero energy balance.

Building Information Modeling is a method, where instead of 2D drawings, 3D, information-rich models are used to design and execute projects. This allows more coordination, earlier decision making and less errors, resulting in a lower project cost in general. The very same BIM model can be used to analyze and compare design variations, giving feedback to both designer and developer about the expected building performance in the very early design phase.

GRAPHISOFT® ignited the BIM revolution in 1984 with ARCHICAD®, the industry first BIM software for architects. GRAPHISOFT continues to lead the industry with innovative **solutions such as EcoDesigner STAR, the world's first fully BIM-integrated "GREEN" design solution.**

Clients and architects can work together to build better buildings that are more sustainable, demand less energy **or even none and use our world's resources** in a more efficient way.

Keywords: BIM, analysis, sustainability

1. INTRODUCTION

In the following paper will explain the fundamentals of BIM, how BIM models are used for energy analysis and introduce 3 case studies, where such software was used to make better decisions, validate design concepts or design a more sustainable building.

1.1 About BIM

Building Information Modeling is a buzzword these days which is often misused or represents only a small subset of the whole concept, in many cases limited to 3D models of buildings. 3D modelling is not a new thing, we have been able to create visualization of buildings for decades. What differentiates BIM from 3D modelling is the **information contained in the elements and it's special relationship with the technical drawings produced from the 3D model**. This information, embedded in the elements of a virtual building model, can be utilised by many stakeholders of the project from start to completion to make more informed decisions, reduce risk and increase transparency, ultimately resulting in a project delivered with accuracy on time and within budget.

In a broader view, BIM not only represents the model itself, but the methodology of how it is used within a company. As opposed to 2D drawing based project delivery, BIM brings new methods for delivering projects. 2D drawings are an abstract representation of something that is in three dimensions, so it involves a double abstraction process. The architect needs to translate the 3D design idea into 2D and the users (client or contractor, manufacturers) need to translate this 2D abstraction back to real building elements. Eventually, the vision of BIM is to eliminate 2D drawings and the process of abstraction by allowing designers to directly, contractors to assemble the building

and operators to maintain the building by using the BIM models developed during this process. Since the whole process is built upon the virtual 3D representation of the future building, enriched with all the same information, which can be found in reality, it becomes extremely efficient, transparent and safe.

1.2 About ARCHICAD

ARCHICAD is the leading Building Information Modeling (BIM) software solution for the architecture and design industry. All creative work and design documentation happens in 3D, so you can make design decisions and see **the results in a project's real, 3D environment**. Designers work on a single building model to create, document, and construct their ideas -- changes are fast and automatic. Automatically updated, one-click documentation makes even the most tedious tasks fast and easy.

1.3 About EcoDesigner STAR

EcoDesigner STAR is built to serve highly energy-efficient building design by turning ARCHICAD Building Information Models (BIM) into multiple thermal zone Building Energy Models (BEM). Architects can now enjoy the benefits of high-end building energy performance simulation and reporting without leaving ARCHICAD. Low and net-zero energy building design is made easy for architects worldwide with EcoDesigner STAR's standard compliant energy simulation engine, advanced energy model visualization and documentation.

In addition to the integrated energy simulation functionality, EcoDesigner STAR's advanced BEM export interfaces (such as gbXML and PHPP) allow full collaboration workflow with building energy consultants and enable data export from ARCHICAD to local building energy code compliance calculation applications.

1.4 About whole building energy efficiency optimisation

Software tools only give us the technology to achieve good results, but they aren't enough alone. A good workflow is the key to make use of the tools at hand. Tools like ARCHICAD or EcoDesigner Star allow professionals more than just analyzing the buildings at once. In fact, they allow continuous feedback and supply real data at various stages of design.

The final requirement of such analysis is, of course, cost. Professionals want to know how much money will they have to spend on an annual scale on utilities. Patrick MacLeamy says that for every 1 dollar spent on design, 60 more dollars will be spent on the operation of the building. This includes management cost, but amongst all it energy consumption.

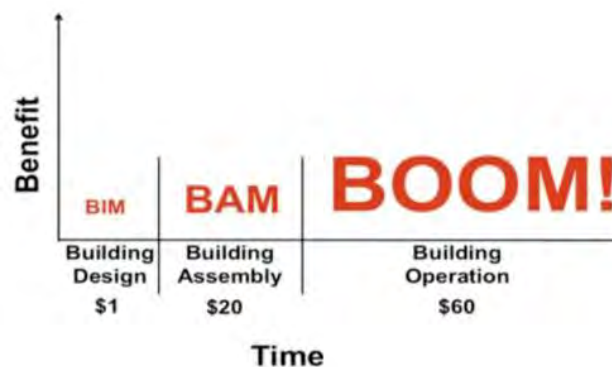

Figure 1: BIM, BAM, BOOM by Patrick MacLeamy, BuildingSmart International

If future building owners can estimate and compare energy consumption cost of different design options in a relatively early stage, they can significantly reduce their expenses later on. Architects can be the execution of this analysis, as even the architecture of the building can contribute to its energy demand.

According to the Environmental Bureau and EMSD, electricity generation is the largest source of local green house gas emissions, accounting for about 68% of the total in 2012 and the single largest category of electricity consumption in Hong Kong in both the commercial and the residential sector is in air conditioning.

In the 2016 Policy Address, the Government committed a reduction target of 40% in energy intensity by 2025 in **the Energy Saving Plan for Hong Kong's Built Environment 2015~2025+**.

It is quite clear that not only for new buildings, but for the existing built environment of Hong Kong, air conditioning is one of the major factors that affect the environment and account for the majority of the building energy consumption related costs. It is clear that reducing air conditioning cost for existing buildings and minimize estimated costs for new buildings not only complies with these trends, but yields tangible economic benefits. In following few paragraphs I will elaborate how this can be estimated with software aided workflows.

1.4.1 Climate analysis

Energy evaluation software is not only purposed for the final examination. A careful analysis of the local climate is **also possible. By constructing a virtual space with zero thickness walls and 100% transmission rate (called "paper box") for external structures, we create a room** in which the same internal requirements occur as in the external spaces. The concept of this space is to serve as a boundary to define an interior space. The software allows us to examine the internal conditions and draw the conclusions for the best low energy design strategy for our building.

This information is present in climate files that can be downloaded from the internet. The software allows us to **visualize and extract that data by analyzing the space inside the "paper box". In the evaluation report, we can get the Degree Days and Unmet Load Hours. The Heating and Cooling requirements for a given structure at a specific location are considered to be directly proportional to the number of "Degree Days" at that location.**

Unmet Load Hours are the number of hours during a year when the internal temperature is out of the comfort range defined in the operation profile. Operation Profile is practically a schedule that records human activity in different types of spaces, providing data, such as Hot Water requirements, humidity generation and electricity requirements due to lighting and equipment usage. Unmet Load Hours can also be visualized in the Daily Temperature Profile diagrams for typical days of different seasons.

1.4.2 The low energy architectural solution set

There are different levels of energy analysis within the project. At first, we need to specify the internal comfort requirements, such as temperature, humidity level or hot water need. These internal requirements will be related to the heating, cooling and electricity needs of a project. Then we can already start the application of analysis, as the architectural design has effect on the final energy consumption of a building. A common practice is that buildings are designed solely to maximise commercial benefits and increase the rentable areas. This results in large, glassed surfaces, facing west and south that need a lot of air conditioning. This huge air conditioning need can only be balanced by large performance coolers, which in addition to the large cooling requirement also consume a lot of electricity. Using higher quality equipment is sure helping to reduce final consumption, but a smarter architectural design can reduce the cooling requirement on the first place. Using software solutions like BIM, architects and investors can now exactly estimate the affects of picking the right architectural solutions to optimize the design. It is called Project Specific Low Energy Solution Set. The solutions are chosen by a careful analysis of each architectural solution compared to a Baseline Design, which is the Sensitivity Analysis. After the analysis the final solution set can be selected. In a practical example, the quality of the window glazing and frames can affect the cooling need by reducing the heat gain from direct sun radiation. Comparing the calculation results of a Baseline Design using single glazed panels and metal frames with an improved design, using triple glazed panels and plastic frames, it is possible to see the reduction in the cooling need, which is in direct relationship with the future costs. It is easy to compare the cost savings with the required investment of such improved fenestration, so owners can make a well informed decision about these important design options. Architects can also justify their intentions with real data, which is benefit for both parties.

1.4.3 Energy consumption levels and optimisation

After we have optimized the architectural design by selecting the appropriate solutions that are justified by analytic results, we can select the suitable building systems.

Building Systems can be selected based on their output performance that is needed to balance the heating and **cooling requirements in a building. This is called "Energy Demand" and it can be calculated by adding unspecified**

building systems that show us how much raw energy is needed to be balanced. The problem with building systems **is that they also use energy, mostly electricity, during operation. So the building's energy consumption equals the energy demand, plus the consumption of the selected Building Systems.** In this stage, energy consumption can further be reduced by selecting highly efficient Building System hardware.

After the energy consumption of the building is selected we also have to consider, how this energy is supplied. It makes a huge difference for example, if the electricity is produced from renewable energy like wind or water or by **burning fossils, for example coal. In the latter case, the building's Carbon Footprint is indirectly increased by the result of coal burning that is needed to supply the electricity need.**

Speaking of Carbon Footprint, it is also essential to understand the concept of Embodied Energy of building materials. Each type of building material represents a sum of energy that was used to produce it from nature. Clay for example is very low energy as it is natural, while aluminium represents a higher energy level, as it is quite expensive to produce. The way these materials were produced also affects indirectly the environmental impact of the building. This is the highest level of the analysis, which is called Fuel Consumption. It can also be understood as environmental impact.

2. CASE STUDY – ECODESIGNER INFORMATION KEY TO GAINING PLANNING CONSENT

2.1 Introduction

2030 Architects Ltd works throughout Cumbria and the North West to create high quality Low Carbon buildings and environments for existing and future generations. We use GRAPHISOFT® ArchiCAD® as our BIM design system as well as more traditional methods of drafting. Our approach is inclusive and contextual, whether working for an individual householder, community or corporate client to create buildings and places of quality in harmony with the natural environment.

2.2 About the practice

We work regularly with a range of local consultants and find the ease with which information can be communicated **via the BIM model to have great commercial value. GRAPHISOFT EcoDesigner™, which is tightly integrated with ArchiCAD,** is used in conjunction with SAP and SBEM calculations, and we also use the PassivHaus spreadsheet for fine tuning of designs. The speed with which EcoDesigner can provide feedback is the key to making strategic early design decisions. Experience gives us a feel for what can be achieved on a site, but having the confirmation of the EcoDesigner evaluation from concept stage onwards is extremely valuable.

The use of ArchiCAD in our practice means that we can communicate 3D visualisations of the scheme from day one. We can also confirm the general standards of energy efficiency that we are aspiring to by using EcoDesigner as an additional tool. This gives us, and clients, confidence in developing the detailed designs knowing that we will be able to achieve the desired results without having costly and time consuming planning amendments.

2.3 Creating sustainable new holiday lets, Cumbria

The evaluation information from EcoDesigner has been extremely useful in demonstrating the effects of different glazing options, particularly as we are developing an existing planning approval which had a far more conventional appearance. The current scheme is a radical departure from the existing consent and the use of 3D modeling and justification of the environmental concepts have greatly assisted discussions with the planning authority resulting in a new approval for the current design. Environmentally we have achieved a double A SAP rating for both energy and environment categories whilst using electric heating combined with a large Photovoltaic array and a superinsulated concrete block construction. All of the major design decisions, whether to go timber frame with low thermal mass or conventional build with heavier mass have been checked using EcoDesigner because it is so easy and quick! Because we can run these checks as part of the modeling we use them a lot, as opposed to the other alternatives, which we only use at the critical stages having once established the broad performance criteria.

The overall form of the design is intended as an interpretation of the local barn vernacular; it has a simple rectangular footprint with a pitched roof. The scheme takes advantage of the spectacular views across open fields to the South and East with large areas of glazing, which also serves to provide passive solar gain. The precise

areas of glazing were modeled at an early stage using EcoDesigner to ensure that we did not suffer from too much heat gain or heat loss. The ability to analyse the whole design very quickly and set target U values for the structure is something that we use all the time in early conceptual models.

As the site is rural with no mains gas we have explored the potential for an all electric building and found that with careful design we can achieve the desired SAP ratings. Subject to confirmation these dwellings will also achieve a CSH rating of 4, and all... or at least mostly due to careful use of GRAPHISOFT EcoDesigner.

3. CASE STUDY - THE RURAL REGENERATION CENTRE IN KENT DESIGNED USING **ARCHICAD IS THE UK'S FIRST CERTIFIED PASSIVHAUS EDUCATIONAL BUILDING [3]**

3.1 Introduction

The drive for sustainable architecture is pushing architects to develop designs that not only deliver on appearance but also take account of energy consumption, carbon emissions and operational costs. This requires the modelling of intricate detail, with sustainable design choices made in one area of a building significantly impacting other aspects of the design. This is further compounded when taking the design to the standards outlined by Passivhaus.

3.2 About the project

Designing to this level of detail requires software that can not only support the development of the model using BIM but also integral sustainability tools that can tell, even from early stage design, the energy output of the building.

Therefore when it came to designing The Rural Regeneration Centre at Hadlow College in Kent to Passivhaus standards, James Anwyl, Director of EUROBUILD used ArchiCAD® together with its integrated thermal performance module – EcoDesigner - to evaluate the energy consumption of the design and MEP Modeller to co-ordinate the services within the building.

The result is that the Rural Regeneration Centre at Hadlow College is a showcase of low carbon and renewable **technology. One of the top three agricultural colleges in the UK, Hadlow College's new Centre will use just 10%** of the typical energy consumption of a modern building and is the first such building in the UK to be constructed using prefabricated materials.

The Rural Regeneration Centre is a sympathetic conversion and extension to redundant cow sheds (over 95% of the original shed **structure was retained on site**) on the **College's fully operational dairy farm. Built using** prefabricated structural insulated panels, the centre was planned using Building Information Modelling (BIM) by ArchiCAD and assembled in just three days. In under 10 days overall, the structure was airtight to a very high standard of 0.34h-1.

A number of sustainable technologies have been implemented throughout the centre including a super efficient mechanical ventilation system, triple glazed windows, and a ground source heat pump for heating and cooling. The sanitary rooms all have waterless urinals, low flush toilets, timed water-saver taps and moderated flow showers. Low energy T5 lighting is used through-out the carefully planned building.

The Rural Regeneration Centre is also a great example of marrying a strong architectural design with sustainability and the Passivhaus requirements. For example, the building has a full-height, north-facing window to provide plenty of light to the main seminar room. However this feature provides problems when running it through the Passivhaus planning package and has required thoughtful design in other areas of the building to make up for it. This has included designing in a lot of solar gain to the south and south west elevations and from the skylights, as well as upping the insulation in the walls from the usual 300mm to 400mm. These carefully considered design improvements were modelled in ArchiCAD to assess their visual impact and thermal performance.

Another challenging design issue was ventilation, which needed to meet the requirements of fresh air rates for teaching spaces (Building Bulletin 101) but yet balance this against the energy consumption of the fans. To achieve this, the most efficient mechanical ventilation system that is certified for Passivhaus use has been implemented – a Drexel and Weiss Aero Centro unit. The unit provides background ventilation daily and also allows the ventilation

rates to be boosted in the teaching spaces to just above 8 l/ s/ person when they are at full capacity to meet the necessary requirements.

Anwyl sums up the success of this project quite simply, “Designing and building Hadlow College to certified Passivhaus standard, at less than £1,500/ m², was only possible using the right BIM software and the right prefabricated system.”

To date the Rural Regeneration Centre has been awarded Passivhaus certification, the first educational establishment to achieve this accolade and has won the Environmental Project of the Year at the Construction Computing Awards. Anwyl is continuing his passion to marry aesthetically pleasing designs whilst delivering low **energy buildings with a number of Passivhaus projects in the pipeline. Through his firm’s deep knowledge of the fine detail required to design the most sustainable buildings, and the ability to model and test designs with ArchiCAD, EcoDesigner and MEP Modeller, EUROBUILD is delivering beautiful, energy efficient buildings at speed and scale.**

And the enthusiasm Anwyl exudes for Hadlow is also shared by the Client. Mark Lumsdon-Taylor, Hadlow College **Finance Director, comments “EUROBUILD delivered a fantastic, innovative sustainable design that has won numerous awards – exactly what we asked for and more - and investing in the early stage design development really paid dividends during the construction phase.”**

4. CASE STUDY - MAKING OLD BECOME NEW AND EFFICIENT

4.1 Introduction

Constructive Thinking Studio, based in Liverpool, is a design-led practice which has quality of design at the heart of its role. Very experienced in sustainable design the Practice is fully accredited Code for Sustainable Homes, On Construction Domestic Energy Assessor (ONDEA), and advises on early-stage energy strategies.

4.2 About the project

This project is the reinstatement of a pair of three storey Victorian terraces under Registered Social Landlord (RSL) control. The properties had been converted into six 1-bedroom apartments in the 1970s. Our goal was to bring the terraces back to individual houses and, in doing so, adhere to good conservation principles whilst enhancing their environmental performance.

The development forms part of the Technology Strategy Board’s Retrofit for the Future competition. Our entry proposed a series of low-carbon measures designed to enhance thermal performance, increase air-tightness and supplement the heating and electrical load with the introduction of energy-saving technologies.

Our aim was to suggest a palette of measures that could be selected from on an ad-hoc basis to apply to all similar conservation area dwellings. At inception (stage 1) we had not identified a property so we modeled (in GRAPHISOFT® ArchiCAD®) a typical 3-storey Liverpool terrace with an east-west orientation. We assumed the property to be of solid wall brick construction, single-glazed sash windows, an un-insulated slate roof and timber **suspended floors with basements under the main plan of the house. We then used GRAPHISOFT EcoDesigner™** to analyse the structure and estimate energy use. Working in ArchiCAD and EcoDesigner it was possible to model a series of scenarios to test the efficacy of changing windows, enhancing thermal performance to the roof, incorporating internal and external wall insulation and improving the air infiltration rate.

We modeled the existing properties and tested the energy usage using EcoDesigner. We were able to estimate the effects of MVHR (mechanical ventilation and heat recovery) and Solar HW (hot water). Our energy calculations were then adjusted to take into account the PV (photovoltaic) slates. **Having this as a ‘live’ working model allowed us to trial varying solutions and to tweak the design on the fly.** Of particular use at early stage design was the ability to override the U-values (thermal efficiency) of elements (within certain parameters) as we have a stock selection of wall solutions already calculated. We have returned to use EcoDesigner at later stages in order to compare the control and augmented project. In early stages, the actual returned values from EcoDesigner were in the same proportion as those from our SAP calculator (in excess of a 60% reduction in energy use.) This gave us the confidence that we needed to use the software as a design tool.

As architects we use the Building Information Model (BIM) for all of our projects. ArchiCAD allows us to produce fully coordinated drawings, details, schedules and quantities, as well as share information with other members of the design team. Moreover, our workflow is improved by the automatic (controllable) update of drawings when making changes to the model.

We made use of many other ArchiCAD features in this project. As we have a large client body we produced **interactive presentation files from GRAPHISOFT BIM Explorer™ (BIMx) to illustrate the construction work-flow** and, on site, to explain working details to the Building Inspector via iPad. We used 3D document to show 3D details to the contractor during the tender process. In the studio we were able to use BIM for clash detection and for designing plumbing runs with the heating engineer. We have also used interactive scheduling to assist the contractor and for cost control.

It is very evident to this Practice that using ArchiCAD BIM to create a virtual building model not only has great benefit to us in expressing our ideas to clients but it is also hugely helpful in conveying design intent and detail to the other parties involved in design and construction. Our strong focus on sustainability, as illustrated by the certifications we hold, means we are able to assess quickly the value of building performance software. EcoDesigner has proved to be an extremely valuable tool in helping us refine and test our ideas throughout design, from early concepts to documentation.

5. CONCLUSION

BIM is becoming the new industry standard and traditional trades of design and construction will have to transfer to the use of model based information databases more and more.

Beyond the fundamental benefits of BIM, energy analysis can deliver additional earnings for all parties within the projects. Designers can validate their design decisions towards clients and authorities. Builders can verify their choice of materials and equipment to ensure lower energy consumption. Building owners can significantly cut final utilities cost by estimating the future energy consumption of the buildings and urging designers and builders to use more environmentally friendly materials and solutions when planning and realizing the project.

BIM based energy analysis is faster and more accurate than traditional manual calculation as it is using the same virtual building models as other stakeholders. As models with the required level of detail are already available in the early design stage, it becomes possible to start thinking about the future early and perform multiple iterations of energy analysis even before the detailed design is complete. In traditional methods, energy analysis is an isolated trade, which gathers input for its calculation manually from 2D drawings. BIM based analysis is built on top of the virtual building model, so there is much less loss of information.

REFERENCES

- [1] GRAPHISOFT, CASE STUDY | Rural Regeneration Centre, Hadlow College [online]. Retrieved from: <http://www.graphisoft.com> [Retrieved on 28 Sept 2016].
- [2] GRAPHISOFT, CASE STUDY | EcoDesigner information key to gaining Planning Consent [online]. Retrieved from: <http://www.graphisoft.com> [Retrieved on 28 Sept 2016].
- [3] GRAPHISOFT, CASE STUDY | Making Old become New, and Efficient! 53-55 Botanic Road, Liverpool [online]. Retrieved from: <http://www.graphisoft.com> [Retrieved on 28 Sept 2016].
- [4] Smart City Consortium, Advisory Papers [online]. Retrieved from: <https://smartcity.org.hk/index.php/information/advisory-papers/86-ap2016-1> [Retrieved on 12 January 2017].
- [5] Environmental Bureau, Energy Saving Plan | Environmental Bureau [online]. Retrieved from: <http://www.enb.gov.hk/en/energysavingplan.html> [Retrieved on 12 January 2017].
- [6] GRAPHISOFT, Learn about the power of EcoDesigner Star [online]. Retrieved from: http://www.graphisoft.com/archicad/ecodesigner_star/ [Retrieved on 12 January 2017].

Session 4.11: BIM for Sustainability (2)

Assessment of Different Data Collection Methods for the Creation of BIM Models for Existing Buildings

Bjoern Arild GODAGER^a, Guri KRIGSVOLD^b

^a Norwegian University of Science and Technology, Norway, bjoern.godager@ntnu.no

^b Norwegian University of Science and Technology, Norway, guri.kringsvold@ntnu.no

ABSTRACT

This article focuses on the important considerations related to some actual data collection methods in conjunction with the development of Building Information Modelling (BIM) in existing buildings. The interest associated with creating such models is increasing steadily, in line with better equipment and methods, lower costs and more maturity in the market. Building owners around the world see this as an increasingly sustainable commitment. However, there are some pitfalls, and the paper has devoted some attention related to knowledge about requirements of ordering such a BIM. The most focused data collection methods in the article are terrestrial laser scanning, drone and mobile BIM measurement systems. The last two methods are quite new, and they are exciting additions, which tend to work together with other methods such as scanning. In addition, these methods are significantly cheaper than conventional scanning. The article shows examples of case studies of these methods and connects the results to selected "state of the art" articles, guidelines and tutorials.

Keywords: sustainable creation of BIM in existing buildings, data capture methods, deep building renovation

1. INTRODUCTION

Today we are moving towards a world where 3D is the expected format, whether it is in games, the cinema or world of construction and surveying. The scope of all the BIM technology will be a catalyst for many new and more effective ways of working in all stages of the life cycles of the construction project.

Volk et al. (2014, p.109) wrote: "Results show scarce BIM implementation in existing buildings yet, due to challenges of (1) High modelling/ conversion effort from captured building data into semantic BIM objects, (2) Updating of information in BIM and (3) Handling of uncertain data, objects and relations in BIM occurring in existing buildings."

The challenges are not solved yet, however the technology is in good progress, and more and more owners or shareholders want to create and use BIM in their existing buildings, because they realize it is sustainable of many reasons (Eastman et al. 2011, p.151-155).

To model existing buildings with BIM, it is important to have clear goals and thoughts about how to take advantage of this. The model specification defines how the modelling requirements should be performed, geometric accuracy and what level of detail it should have. Many major building owners want BIM models in their existing buildings, but they often have a lack of BIM knowledge within their own organization. (Eastman et al, 2011) focuses on how the owner can increase their knowledge and thus get a better claim document and thereupon a better and customized intelligent "BIM". However, many existing Facility Management (FM) software are still far from being good at implementing BIM. The main focus within BIM has for many years been on the earlier building phases in front, while knowledge, standards and guidelines related to FM have not been as much a priority. However, there are some American and British guidelines. Anyhow, it is perceived an increasingly focus on the modelling of existing buildings in recent years. GSA (GSA BIM Guide for 3D Imaging) have guides, and there are others like PAS 1192-2 and PAS 1192-3 (BSI: 2013, 2014).

In rebuilding or in further development of existing buildings, architects often rely on construction or as-built drawings of existing structures as a basis for design. However, there are often discrepancies between the as-built drawings and "as-is". These differences often lead to structural problems, and this can lead to costly and delaying modifications or design changes (Reginato, 2014).

There is a lot of available information about several data collection methods used to perform modelling in existing building. This paper will consider some very relevant data collection methods and 3D imaging technologies (Chapter 2) for this modelling.

The paper has a special focus on the combination of data acquisition with terrestrial laser scanning (TLS), inexpensive drones and Mobile BIM Measurement Systems. Data collection from simple measurement, as well as from existing analogue or digital drawings are less treated here, but they are important nevertheless. The work is based on various case studies with TLS and one study in 2016 with a drone at Campus NTNU in Gjøevik, combined **with literature search. The aim has been how to create a "SLIM BIM" in a rational and satisfactory manner with respect to geometric accuracy and with relevant building information.** To create a SLIM-BIM is the first step to make a complete 3D model of a building. The discussion related to use of drones is based on a bachelor thesis (Obrestad and Soerensen, 2016).

The model will give many benefits, for instance improved management of buildings, ability to connect a Facility Management system (FM), basis for planning tools for repackaging/ change in existing buildings and basis for later, new adjacent developments.

The studies had both existing, 2D digital drawings, TLS and measurements with drone. The aim was to find out how a simple drone can help improve the geometric model, so in fact we had to combine TLS and drone data. The models are georeferenced, although it was not necessary in this project. The objective of this article is to consider the combination of data from drone and laser to BIM purposes.

2. DATA COLLECTION METHODS

Data collection normally constitutes the greatest part of the total cost by the creation of a Building Information Model in existing buildings, so there are good reasons to approach such a work with good plans. The work can be determined in several ways, but the choice of method will depend on what is available and possible, subscription or model material, accuracy requirements, expertise, available software, equipment and existing guidelines. Anyhow, independent of data collection methods it is important to perform accurate georeferencing at the very beginning.

A BIM survey challenges the surveyor to collect much more information about the building due to the parametric tools of the software and a basic understanding of how the model is physically built.

The resultant survey model will be a combination of detail and information, and it will be a mix of graphical and non-graphical content. This will be considered as the overall Level of Development (Plowman Craven 2015).

It will normally be a good solution to use a combination of several data capture methods. If a building has existing drawings, it will be of great benefit and be a natural starting point in the process. Anyhow, drawings are only drawings and do not necessarily coincide with what it is actually built. Existing buildings often have a lack of good as-built documentation, and it typically leads to a certain need for surveying. This chapter will focus more specific on 1) TLS, 2) Drone and 3) Mobile 3D-Measurement-System.

2.1 Terrestrial Laser Scanning (TLS)

The speed and quality of the scanners increase, while equipment and labor cost decreases, and this allows the value-proportion for using 3D scanning technology clearer than ever (Randall, 2013, p.3).

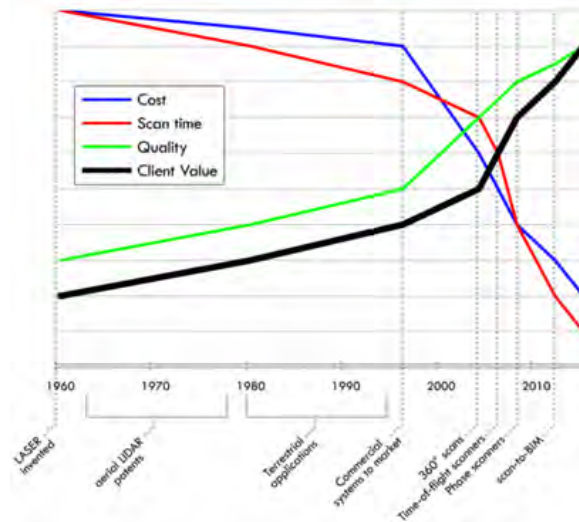

Figure 1: Timeline of 3D scanning development (Randall 2013, p.3)

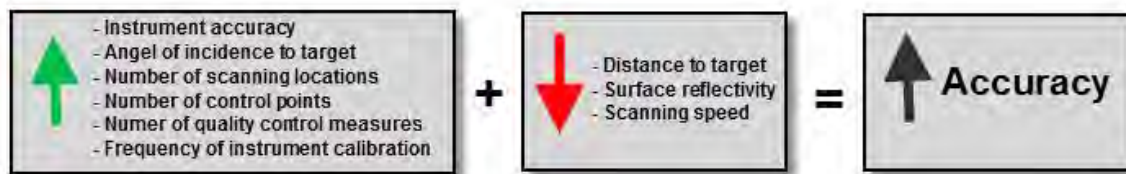

Figure 2: General rules of thumb for achieving higher accuracy, designed with inspiration from Randall (2013, p.5)

BSI (2013, 2014) has specifications for information management for the capital/delivery phase of construction projects using building information modelling. It offers guidance on the use and maintenance of the asset information model (AIM) to support the planned preventative maintenance program and the portfolio management activity for the life of the asset.

The Reference Guide from Plowman Craven (2015) is one of many good guidelines. These guides could be some very important key points on the journey to make a "SLIM BIM", which is the first step to build up a more complete 3D BIM.

Anil (2011, p.4) wrote "We identified five main concepts that are unique to "as-is" BIMs and are not represented with existing BIMs. These characteristics are point density, noise, occlusions, model deviations, and the links between the points and building components." This means there is a need for further research and development in this field.

The last part of this chapter is a summary of methods used in the case studies:

- "Targets" or benchmarks points were optimally located and measured prior to scanning by a combination of traverses and a fixed network
- A total station was used to measure the targets in front of the scanning area.
- The targets were calculated in a selected datum/ coordinate system
- The point resolution was selected before the scan started.

Becerik-Gerber (2011, p. 649 - 658) has argued more specific related to assessment of target types and layouts in 3D laser scanning for registration of accuracy.

After completing the scanning, unwanted point clouds were deleted, the stored images were draped into the 3D model, and measures from each position were linked to the model, first by storey, afterwards collected. It generated a TrueView, allowing the user to move freely around the model. The finished X, Y and Z data was imported into 3D software (Leica Cyclone), displayed as a point cloud and modelled. The model was exported from Leica

Cyclone and linked to two programs with more BIM functionality (Autodesk Revit Structure and ArchiCad). The dimensions of the Revit model were compared with existing buildings, as well as the previous ArchiCad model of the building. The composite model was exported as TrueView and PTS file was used for modelling of a BIM model. The modelling was carried out in Revit Structure.

Existing analogue and digital drawings were then included into the scanned model, and adjusted as necessary. Each single room has not been scanned.

2.2 Data capture with drone

How can UAV Data Fit into the Scan to BIM Workflow? UAVs are an alternative solution that readily addresses the need to capture inaccessible areas such as roofs. In the study the external TLS data for the building was merged with the point clouds taken from the drone, to produce a complete point cloud of the exterior building. The drone is not suited for indoor mapping, because of its size and speed, so it will still only be an outdoor supplement. It is experienced, even with a simple and cheap drone, how point clouds from an UAV survey also provided images of a building from every angle we wanted, and this provided a much better information than could be achieved from only ground based scanning techniques (Figure 3).

The TLS data is taken an earlier year, so the accuracy considerations is based on comparison of distances measured with a laser and distances in the point cloud (Figure 4).

How can UAV Data Fit into the Scan to BIM Workflow? It is a lot of available photogrammetry software here, but in this study Pix4D was used. Research shows that it currently is very little standardisation of requirements and processes. This varies from project to project, but the various companies seem to make their own rules, as long as this is not standardized. However, there are some guidelines which are mentioned in this chapter.

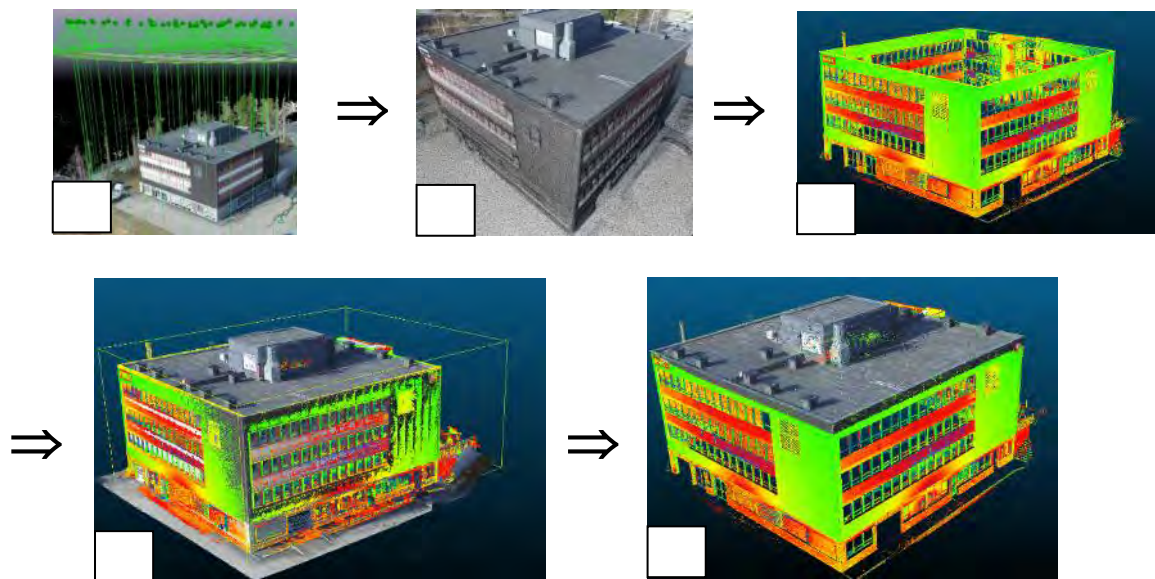

Figure 3: Different steps in combining Drone data and TLS data. 1) Photo/ data capture positions from Drone 2) Triangulated model from Drone, 3) TLS Data 4) Combination of TLS data and drone data 5) Drone data on the roof, TLS in areas with colours

Photogrammetric point clouds are missing normals at the points. Therefore, we do not know which way is pointing outwards. This can partly be calculated in the software afterwards, but intensity, number of return pulses, placement of scanner etc. will never be able to get in a point cloud of drone data. Since this is information that makes it easier to sort a point cloud and automatically identify objects, a point cloud generated by photogrammetry will never be worth as much as a laser scanned point cloud in a "Scan to BIM" process.

The main question here is: Will the data from the photogrammetric point cloud be accurate enough to BIM? Due to an equipment request which was cancelled, there were challenges of merging test data from drone and data from the laser conducted with an older laser scanned point cloud. Table 1 gives the specific results from selected comparisons between the two data sets. The differences are showing +/- 5 - 10 cm with the selected resolution. Drones with higher resolution cameras can provide higher accuracy. The resolution in the camera part is important for the accuracy.

	Measured area	Measured with laser	Measured in point cloud (m)	Difference (m)
1	Short side	3.765	3.712	0.053 m
2	Distance between corner and door frame	22.170	22.171	0.001 m
3	Distance between corner and door, long side	18.179	18.188	0.091 m
4	Length partition ceiling	9.524	9.509	0.015 m
5	Distance between two ventilation towers on roofs	25.941	25.810	0.131 m
6	Length long side of the building roof	10.396	10.381	0.015 m
7	Length short side of the building roof	6.841	6.891	0.050 m

Table 1: Shows distances measured with laser and in Recap

In addition to the drone resolution factors like lighting conditions, altitude, overlapping, supplemental control points (pass points) will influence the accuracy.

2.3 Measuring systems with integrated, manual data capture and modelling software inside

The market now offers measurement systems with integrated, manual data capture and modelling software. It becomes like a surveying equipment that connects directly to the PC and can be used for quality assurance of existing drawings or to create all models from scratch to get the proper basis for further planning. The solution appears to be suitable measuring key points for walls, floors and ceilings. Manually selected points outside or inside a building can be measured, drawn and modelled completely in one operation. The use of conventional TLS can be perceived as a bit "overkill" in some situations, and suppliers of less costly equipment of this type is expected to increase, and get a niche.

The geometric accuracy of this method will depend on the measurement plan and the quality of the measurement equipment. How this is carried out with regard to adhering many measuring positions and spaces could follow the same basic manner as the TLS.

This kind of equipment is not used in these case studies, but the author knows one type (Flexijet) used in some hospital projects in Norway. This method is included in this article to show a short summary of its possible use.

3. CONCLUSION AND FUTURE WORK

The study has looked at some selected measurement methods to create a BIM in existing buildings and shows that in many cases it will make sense to combine two or more of the described methods. When establishing 3D models of existing buildings, geometric accuracy requirement may not always be the most important. However, it is perhaps more important that the building is complete. These are factors that building owners must decide for themselves. There is no doubt that TLS is more accurate than a model generated from photogrammetry, especially when using inexpensive equipment.

A TLS normally would be used, when high accuracy is wanted, drawings are inadequate, and the model have to be georeferenced in a nationally adopted reference system.

TLS will anyhow often leave some bad mapped or missing areas. Our study wanted to test how a simple drone can help improve the geometric model. The study has shown it is possible to combine those two methods. The

study also wanted to consider the geometry accuracy a drone could provide (Figure 4), but it seems to be a need for more studies to say something clear about the geometric accuracy. The research anyhow shows that even with an inexpensive drone, an accuracy of a few cm is possible.

With improvements in positioning accuracies, developments with software and a continual improvement in understanding from drone operators, point accuracies have now been demonstrated and validated down to just a few millimetres. Of this reasons we will see much more research and documentation in this area in near future.

The study has showed that UAV survey will provide clients accurate point cloud data, which can be processed and imported into actual BIM software to create an intelligent 3D model in existing buildings.

TLS or measuring systems with integrated manual data capture and modelling software inside could both be used inside the buildings.

The embracing of information rich BIM technologies will be a catalyst for new and more efficient ways of working at all stages of the sustainable building project lifecycle, and the operations and maintenance part (O&M) looks very interesting in the future. In this development, it also seems very necessary that building owners increase their expertise, and contribute to better coordination of requirements that should apply when establishing BIM models in existing buildings.

REFERENCES

- [1] Anil, E. B., Tang, P., Akinci, B., Huber D. 2013. 'Deviation analysis method for the assessment of the quality of the as-is Building Information Models generated from point cloud data'. © 2013 Elsevier B.V. *Automation in Construction*, March 2014, Vol.38, pp.109-127.
- [2] Arayici, Y. (2010), 'Use of the 3D laser scanner technology in the Built Environment', In: Geller, P.S. (Ed.), *Built Environment: Design, Management, and Applications*, Environmental Science, Engineering and Technology, Nova Science Publishers, NY USA, pp. 89-120.
- [3] Becerik-Gerber B, Farrokh Jazizadeh, F., Kavulya, G., G. Calis G., 2010: 'Assessment of target types and layouts in 3D laser scanning for registration accuracy', available at: *Automation in Construction*, Volume 20, Issue 5
- [4] British Standards Institution (BSI). 2013. 'PAS 1192-2:2013 Specification for information management for the capital/ delivery phase of construction projects using building information modelling'.
- [5] British Standards Institution (BSI). 2014. 'PAS 1192-3:2014 Specification for information management for the operational phase of assets using building information modelling'.
- [6] *Building Design + Construction*. '9 best practices for effective laser scanning'. Retrieved from: <https://www.bdcnetwork.com/9-best-practices-effective-laser-scanning>, [Retrieved on 25 September 2016].
- [7] Comparison of photogrammetry software. Wikiwand. 2016. Retrieved from: http://www.wikiwand.com/en/Comparison_of_photogrammetry_software. [Retrieved on 05 Oktober]
- [8] Eastman, C. Teicholz, P., Sacks R., Liston, R. 2011. *BIM Handbook: 'A Guide to Building Information Modeling for Owners, Managers, Designers, Engineers and Contractors'*, 2nd Edition, (p. vii, 151-155). ISBN: 978-0-470-54137-1
- [9] Flexijet Innovation CAD-Measurement. Retrieved from: <https://www.flexijet.info/en/>, [Retrieved on 15 September 2016].
- [10] http://www.gsa.gov/portal/mediald/226819/fileName/GSA_BIM_Guide_Series_03.action
- [11] Kedzierski, M., Walczykowski, P., Orych, A., and Czarnecka, P.: 'Accuracy assessment of modeling architectural structures and details using terrestrial laser scanning, *Int. Arch. Photogramm. Remote Sens. Spatial Inf. Sci.*, XL-5/W7, 241-243, doi:10.5194/isprsarchives-XL-5-W7-241-2015, 2015.
- [12] Nichols, T. 2015. '9 best practices for effective laser scanning'. *Building Design & Construction*. Available at: <https://www.bdcnetwork.com/9-best-practices-effective-laser-scanning>, [Retrieved on 5 Oktober 2016].
- [13] Obrestad, G.; og Sørensen, J.B. 2016. 'Kombinere data fra drone og laser til BIM-formål' ('The combination of data from drone and terrestrial laser to BIM purposes', Norwegian University of Science and Technology in in Gjøvik, Available from: <http://hdl.handle.net/11250/2413420>, 62 p.
- [14] Phanto DJI Phantom 3 Advanced. Retrieved from: <https://www.drone-world.com/dji-phantom-3-specs-info-guide-kits>. [Retrieved on 05 Oktober]

- [15] Pix4D. Advanced photogrammetry software uses images to create professional orthomosaics, point clouds, models and more. Retrieved from: <https://pix4d.com/> [Retrieved on 15 September]
- [16] Plowman Craven (2012), 'BIM survey specification v2.0.3'. Retrieved from: www.plowmancraven.co.uk/bim-survey-specification/, [Retrieved on 27 September 2016].
- [17] Plowman Craven. 2015. 'BIM Specification and Reference Guide'.
- [18] Plowman Craven. '3D Laser Scanning and BIM for Existing Buildings'. Retrieved from: <https://www.plowmancraven.co.uk/assets/resources/datasheets/laser-scanning-and-bim-for-existing-buildings-2.pdf>, [Retrieved on 29 September 2016].
- [19] Randall T., Philp D., 2013, 'Client-Guide-to-3D-Scanning-and-Data-Capture.The Building Information Modelling (BIM) Task Group', 31 p., [Retrieved on 02 October 2016].
- [20] Reginato J. M., 2014. 'Using Laser Scanning to Determine As-Is Building Conditions'. Associated Schools of Construction, 8 p.
- [21] The BIM hub. 2016. 'From UAV to BIM – How UAV Data Fits into the Scan to BIM Workflow' available at: https://thebimhub.com/2016/03/23/uav-bim-how-uav-data-fits-scan-bim-workflow/#.V_jHIsIKAu9 [Retrieved on 1 October 2016].
- [22] U.S. General Services Administration (GSA). 2009. 'GSA Building Information Modeling Guide Series: 03 – GSA BIM Guide for 3D Imaging'.
- [23] Volk, R., Stengel, J. and Schultmann, F. (2014), 'Building information modeling (BIM) for existing buildings – literature review and future needs', Automation in Construction, Vol. 38, pp. 109-127

Boost Sustainability Certification by Using BIM

Heinz J BERNEGGER^a, Carsten K DRUHMANN^b

^a Zurich University of Applied Sciences ZHAW, Institute of Facility Management, Switzerland, heinz.bernegger@zhaw.ch

^b Zurich University of Applied Sciences ZHAW, Institute of Facility Management, Switzerland, carsten.druhmnn@zhaw.ch

ABSTRACT

Building performance only can be developed in the long-term perspective with holistically constructed instruments in place. In Switzerland the use of the adapted DGNB certification system enables major projects such as hospitals, research laboratories or shopping centers being optimized in a holistic and sustainable way despite a high level of complexity. The use of BIM will play a key role: In 2016 five of the largest national portfolio holders have jointly decided to use BIM from now on.

The DGNB rating system assesses a building on level «pre-certification» (valid until completion) and «certification» (unlimited from start of operation/use) with more than 40 criteria and 120 sub-indicators. A big success factor for an optimized sustainable design is the usability of the evaluation system in early planning stages because changes are significantly cheaper than in later stages. The project can be rated «As-plannend» at this time based on a «digital model». To increase the validity of the evaluation, the virtual building modeling must be precise and enriched with information (e.g. materialization of the building), which are usually not available at this stage of planning. This challenges planners and architects.

The presented research will show, which criteria and sub-indicators of the DGNB system can be tested BIM-based. By analysing current certified DGNB projects (on level «pre-certification») in Switzerland it will be shown which types of BIM tools are already being used and how their distribution in projects is right now. The final chapter will outline the potential of BIM, if used in a consistent way in the sustainability certification process, and the necessary steps of development to achieve the goal of a 100%-BIM-based certification by 2020.

Keywords: BIM, sustainable building rating systems, life cycle management

1. INTRODUCTION

In practice, but also in science Green Building rating system and Building Information Management (BIM) as a method are still largely perceived as separate tools. However, a more integrated viewing should open up in future new possibilities and value creation models, both instruments will mutual benefit from.

1.1 Green building rating systems in Switzerland

The international map shows a variety of rating systems used for assessing the sustainability of buildings. In Europe are primarily three systems in place: the British BREEAM system (UK BRE Environmental Asset Method) for existing buildings, the American LEED system (Leadership in Energy and Environmental Design), known for office buildings and tenant improvements and the German DGNB - Certificate of German Sustainable Building Council. In addition to these «big three» systems there are several country-specific systems available, such as the French HQE-system or the TQB-system in Austria, which are negligible in terms of their distribution in Switzerland.

In Switzerland today we are facing a microcosm of Swiss instruments, in a co-existence with international developments over the past 10 years. Actors have been universities (ESI – Economic Sustainability Indicator by University of Zurich), cities (energy cities label, swiss cities organisation), financial institutes (Green Property Label by Credit Suisse), federal offices and NGOs (e.g. SNBS - Swiss Sustainable Building Standard; Federal Office of Energy) as well as large construction companies (e.g. GENAB – Building Sustainable Construction by Implenia). Since 2009 the Swiss Sustainable Building Council (SGNI) fully adapted the german DGNB rating system and led it successfully into the market. As a result Switzerland has already a wide experience at rating sustainable buildings.

1.2 Swiss BIM definition

BIM may have several meanings, depending on a stakeholders view. The Swiss understanding of BIM reflects best in newly developed SIA leaflet PRSNR 59205 (2016, in consultation) 2016 on the application of BIM method: "Building Information Modelling (BIM) is a method which utilizes digital building models. Models are databases of information about the building and its immediate landscape. The method supports the cooperation and data exchange between all stakeholders during the lifecycle of a building." Thus it is not the aim to map a building digitally as detailed as possible. In fact, building data should be processed, used and made available to all project partners in accordance with the discrete project goals/steps. This understanding is also in line with international definitions such as «The National BIM Standard-United States (NBIMS-US)». In connection with sustainability certification the following working definition shows the understanding of BIM for the research presented here:

SUSTAIN BIM is a method to use digital building data models within the process of sustainability ratings of buildings and areas. This method supports the cooperation and the exchange of data during the complete certification process.

2. METHODOLOGY

As a basis for the research is used the DGNB-system version Office and Administrative Buildings "NBV2015". The system architecture is as follows:

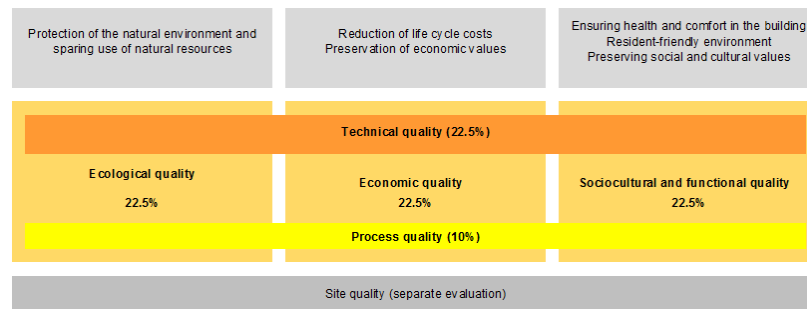

Figure 1: DGNB system architecture (BIM scope in colour)

This study only takes the building-related quality criteria into conclusion, which have direct impact on the rating results. Criteria regarding the location of a building are indirectly included in the evaluation (DGNB-System, version 2012/15, criteria "ECO 2.2 marketability" (see Table 1), but with a small proportion of 3.2 percent of the total weighting. The clustered process criteria rate the quality of planning and construction of a new building. For existing buildings processes related to operation are rated and therefore not based on the "the building as a product" and were therefore not considered in the following analysis. Using BIM-based instruments for building operation in the future, it would be beneficial to incorporate these processes into the framework for future studies.

Besides the investigation of the Swiss DGNB rating system itself, a literature review and six expert interviews (with people involved in projects which are already certified or on their way) have been carried out for this study.

3. APPROPRIATE CRITERIA FOR BIM-BASED CERTIFICATION

The Swiss DGNB-System is a performance orientated rating system, which takes all aspects of sustainability into consideration, whenever possible via simulated or predictable aspects. Also the German Sustainable Building Council (DGNB) aims for restructuring their ratings system in balance with the BIM-methodology and their tools in the near future.

Basically, three types support levels can be distinguished from in the Swiss DGNB-system's criteria (see Table 1):

- Criteria rating punctually supported (e.g. via BIM predictable characteristics, ratios)
- Basic data support and partially supported (e.g. consistent quantity structure derived from the 3D model)
- Fully or mostly automated (e.g. use of BIM tools such as REVIT or LESOSAI (CH) for automated calculations, verification and reporting)

DGNB Office Version 2015				
no.	Weight	critereon		
ENV1.1	7.9%	Life Cycle Impact Assessment		
ENV1.2	3.4%	Local Environment Impact		
ENV1.3	1.1%	Responsible Procurement		
SOC1.1	5.4%	Thermal Comfort		
SOC1.3	1.1%	Acoustic Comfort		
SOC1.4	3.2%	Visual Comfort		
SOC2.1	3.2%	Design for All		
	25.3%	fully automatable (BIM Tools)		7
ENV2.1	5.6%	Life Cycle Impact Assessment - Primary Energy		
ENV2.2	2.3%	Drinking Water Demand and Waste Water		
ENV2.3	2.3%	Land Use		
ECO1.1	9.6%	Life Cycle Cost		
ECO2.1	9.6%	Flexibility and adaptability		
SOC1.5	2.1%	User Control		
TEC1.1	0.0%	Fire Safety		
TEC1.2	4.1%	Sound Insulation		
TEC1.3	4.1%	Building Envelope Quality		
TEC1.6	4.1%	Deconstruction and Disassembly		
	43.8%	partially supportable (Tools)		10
ECO2.2	3.2%	Commercial Viability		
SOC1.6	2.1%	Quality of outdoor & indoor spaces		
SOC1.7	1.1%	Safety and Security		
SOC2.2	1.1%	Public Access		
TEC1.4	4.1%	Adaptability of Technical Systems		
TEC1.5	4.1%	Cleaning and Maintenance		
TEC3.1	2.0%	Mobility Infrastructure		
	17.7%	selectively supportable (Parameters)		7
SOC1.2	3.2%	Indoor Air Quality		
	3.2%	not supportable		
	90.0%			
PRO1.1	1.4%	Comprehensive Project Brief		
PRO1.3	1.4%	Design Concept		
PRO1.4	1.0%	Sustainability Aspects in Tender Phase		
PRO1.5	1.0%	Documentation for Facility Management		
PRO1.6	1.4%	Procedures for urban planning and design		
PRO2.1	1.0%	Environmental Impact of Construction		
PRO2.2	1.4%	Construction Quality Assurance		
PRO2.3	1.4%	Systematic Commissioning		
	10.0%			
SITE1.1	0.0%	Local Environment		
SITE1.2	0.0%	Public Image and Social Conditions		
SITE1.3	0.0%	Transport Access		
SITE1.4	0.0%	Access to Amenities		

Table 1: Weighted shares of the three criteria types

The overview shows that 86.8 percent of the global criteria are supportable with BIM. Exception is only «indoor air quality», because it is based on real measurements.

Today there are three types of tools used in practice:

- Virtual Building Model Software
- Model Checker Software (rule-based conformance testing)
- Simulation Software

It could be shown that 76.5 percent (of the total weight) of criteria can be supported by using data coming from the virtual building model, 59.7 percent via automated checks with rule-based instruments and 48.8 percent can be supported by using simulation software. (Basis NBV15-GER)

Based on experience from recently done and running Swiss DGNB certification projects, we identified about 20 BIM-related instruments being used for different purposes by architects and engineers working with the Swiss

DGNB rating system. The LESOSAI software enjoys a special status, because it is used today for a full assessment of three criterias and potentially can be used for rating three more. In terms of a systematic review of sustainability aspects the use of model checker software is not apparent from the documents to be delivered for certification. Overall, the real use of BIM software currently covers approximately 67.5 percent of the criteria (total weighting). Almost all of the evaluated BIM software products use shared data about the characteristics of building materials and products. Compared to other international and national certification schemes the Swiss DGNB system attaches great importance to the characteristics of building materials and products. Their characteristics are very comprehensively accounted and influence the results of a Swiss DGNB rating, direct and indirect, somewhere between 50 - 75 percent, without considering process criteria. (Basis NBV12-CH)

In the more recent DGNB version 2015, the proportion even increased further, as shown in the following table. The impact on the costs of a certification is correspondingly high (see Table 2).

DGNB Office Version 2015									
topic	criteria group	no.	%	criterion	impact		min	max	
Environmental Quality (ENV)	Global and Local Environmental Impacts (ENV 10)	ENV1.1	7.9%	Life Cycle Impact Assessment			9	7.1%	7.9%
		ENV1.2	3.4%	Local Environment Impact			10	3.4%	3.4%
		ENV1.3	1.1%	Responsible Procurement			4	0.4%	1.1%
	Resource Consumption and Waste Generation (ENV 20)	ENV2.1	5.6%	Life Cycle Impact Assessment - Primary Energy			9	5.0%	5.6%
		ENV2.2	2.3%	Drinking Water Demand and Waste Water Volume			5	1.2%	2.3%
		ENV2.3	2.3%	Land Use					
Economic quality (ECO)	Life Cycle Costs (E CO10)	ECO1.1	9.6%	Life Cycle Cost			9	8.6%	9.6%
		ECO2.1	9.6%	Flexibility and adaptability			2	1.9%	9.6%
	Economic Development (E CO20)	ECO2.2	3.2%	Commercial Viability			1	0.3%	3.2%
Sociocultural and Functional Quality (SOC)	Health, Comfort and User-Friendliness (SOC 10)	SOC1.1	5.4%	Thermal Comfort			9	4.9%	5.4%
		SOC1.2	3.2%	Indoor Air Quality			10	3.2%	3.2%
		SOC1.3	1.1%	Acoustic Comfort			6	0.7%	1.1%
		SOC1.4	3.2%	Visual Comfort			6	1.9%	3.2%
		SOC1.5	2.1%	User Control			1	0.2%	2.1%
		SOC1.6	2.1%	Quality of outdoor & indoor spaces			2	0.4%	2.1%
		SOC1.7	1.1%	Safety and Security			9	1.0%	1.1%
		SOC2.1	3.2%	Design for All			3	1.0%	3.2%
	Functionality (SOC 20)	SOC2.2	1.1%	Public Access, Benefits to the public					
	Technical Quality (TEC)	Quality of technical Implementation (TEC 10)	TEC1.1	0.0%	Fire Safety				
TEC1.2			4.1%	Sound Insulation			7	2.9%	4.1%
TEC1.3			4.1%	Building Envelope Quality			8	3.3%	4.1%
TEC1.4			4.1%	Adaptability of Technical Systems					
TEC1.5			4.1%	Cleaning and Maintenance			6	2.5%	4.1%
TEC1.6			4.1%	Deconstruction and Disassembly			8	3.3%	4.1%
Mobility (TEC 30)		TEC3.1	2.0%	Mobility Infrastructure					
TOTAL							53.2%	80.5%	

Table 2: Building and construction materials relevant to DGNB criteria (NBV15-GER)

4. HOW TO IMPLEMENT BIM INTO THE CERTIFICATION PROCESS?

The Swiss DGNB certification process is currently divided in the following sub-phases (see Table 3): 1) pre-assessment, 2) pre-certificate ("as-planned") and 3) certificate ("as-built"). The sub-steps are carried out in coordination with the general outline phase based on the SIA Standard 112 of the Swiss engineer and architect association.

no.	SIA phases	no.	SIA sub-phases	Phase SGN1	Description of services in the accompanying project audit
1	Strategic planning	1	Definition of needs, solution strategies	Pre-assessment	Kick-off workshop with client
2	Preliminary studies	2.1	Project definition, feasibility study		Quick check
		2.2	Selection procedures		Participation in planning competition / study contract
3	Project	3.1	Preliminary project	Calculation	Pre-check
			Construction project		Definition of sustainability goals
			Permit-obtaining procedure / submitted project		Beginning of pre-certification process
4	Invitation to bid	4.1	Invitation to bid, comparison of quotations, application for contract awarding	Pre-certificate	Monitoring of planning process with a focus on certification
					Submission of pre-certification documents / awarding of pre-certificate (in SIA phase 3.3.2)
5	Implementation	5.1	Construction project	Verification	Project optimization (including virtualization and simulations)
			Implementation		Preparation of pre-certification documents
			Commissioning, completion		Submission of pre-certification documents / awarding of pre-certificate (in SIA phase 3.3.2)
6	Management	5.1	Operation	Building-certificate	Beginning of certification process for new buildings
			Maintenance		Assistance with tendering and awarding
					Verification
					Control of construction process
					Preparation of certification documents (certificate for new buildings)
					Submission of certification documents > Awarding of certificate

Table 3: Allocation of certification levels to the general planning and construction phases according to SIA

The Swiss DGNB pre-certificate "as-planned" is being used in practice on the one hand side as a marketing tool for e.g. tenant search and on the other hand by the builders as quality assurance tool for creating a high planning predictability. The main problem in practice today is that the specific materialization is usually fixed in later planning stages. Many important core criteria (LCA, LCC, etc.) for pre-certification cause therefore huge uncertainties concerning the achievement of assigned quality targets (silver, gold, platinum). To solve this problem, two approaches are currently being pursued in Switzerland:

- Simplified calculations as of the average characteristics of whole products classes contained in e.g. EPD's (environmental product declarations) or use of general product class data bases (e.g. KBOB list for LCA)
- Early BIM-based materialization in coordination between client and architect

Based on the analysis of current Swiss DGNB projects, the first approach is currently the most preferred. Aiming for a full BIM-based certification this must be considered, however, as an interim solution. The second approach is currently applied only partially in Switzerland since it also implies changes in the existing status quo of Swiss planning culture. For a future fully BIM-based certification process therefore the following model is proposed:

no.	SIA phases	no.	SIA sub-phases	Phase SGN I	Description of services in the accompanying project audit
1	Strategic planning	1	Definition of needs, solution strategies	Pre BIM Pre-assessment	Kick-off workshop with client
2	Preliminary studies	2.1	Project definition, feasibility study		Quick check
		2.2	Selection procedures		Participation in planning competition / study contract
					Pre-check
					Definition of sustainability goals
3	Project	3.1	Preliminary project	BIM model Planning certificate	Beginning of pre-certification process for planned project (= building as planned)
		3.2	Construction project		Monitoring of planning process with a focus on certification
		3.3	Permit-obtaining procedure / submitted project		Project optimization (including virtualization and simulations)
			Verification (including model checking)		
					Preparation of pre-certification documents (planning certificate)
4	Invitation to bid	4.1	Invitation to bid, comparison of quotations, application for contract awarding		Submission of pre-certification documents / awarding of planning certificate (in SIA phase 3)
5	Implementation	5.1	Detailed construction project	BIM method Building certificate	Beginning of certification process for new buildings (= building as planned)
		5.2	Implementation		Assistance with tendering and awarding
		5.3	Commissioning, completion		Control of construction process
					Preparation of certification documents (building certificate / "as build")
					Submission of certification documents > Awarding of certificate

Figure 2: Fully BIM-based certification process

It will be appreciated that the timing of the pre-certificate has been rearwardly moved to phase 5.1 «preliminary project». In the future, a "key-ready" project hand over as-planned will be possible. It will help to prevent cancellation of the certification by the client due to uncertainty of achieving the aimed for quality level.

5. FULLY BIM-BASED CERTIFICATION

Based on the previous findings three development stages are proposed on the road to a fully BIM-based certification:

Level 1 includes all product-based core criteria of material and energy LCA, life cycle cost, recyclability and risk evaluation. Together they display about 30 percent of the evaluation and impact the achievable quality level of a building significantly. A one-stop solution, as the BIM-based Lesosai software (CH) represents, proves to be enormously helpful, because each product used has different advantages and disadvantages with respect to the addressed core criteria. An integral solution is also desirable because in larger projects hundreds of building materials and products are used in different quantities. Tracking the impact of changes in material or product selection on overall evaluation can be determined as very cumbersome. The time factor is, at the stage where it comes to the choice of materials, very significant.

The European green building councils are currently striving to formulate six core criteria which are to be valid for all three major certification systems, BREEAM, LEED and DGNB, which should also be anchored in European policy and standardization. If this project is to be successful, it can be expected that the objectives of level 1 will be achieved in common for all international systems.

Level 2 includes all criteria, which are used for evaluating the building as a product, (process criteria related to planning and construction excluded). A coordinated tool-environment, standardized interfaces and the general use of the IFC format could deliver many benefits. A set of fully operationalized predictable criteria could be a base. With the newer DGNB-System Version 2015 this target seems relatively achievable. However, many criteria show two ways of evaluation. Firstly, the calculation of performance via simulations and measurements for the pre-certificate and secondly, the assessment of compliance with certain criterion-related requirements, which can be checked using a model checker.

Level 3 also includes the process criteria during planning and construction for project development as well as for buildings in operation. In order to assess the appropriate process quality BIM-based, a high level of transparency and operationalized documentation of the entire flow of information is necessary with respect to different parts of the phases (located temporally and spatially).

Based on the research results and expert interviews carried out by the authors it can be expected to achieve stage 1 in Switzerland in the next 3-4 years. Even stage 2 is within reach (next 4 - 6 years). Just stage 3 (evaluating process criteria BIM-based) needs a longer development period of approximately 6 - 10 years, obstacles like e.g. data protection issues can be expected in practical implementation and application.

6. CONCLUSION

The presented study results lead to the following conclusion: To achieve stage 1 (core criteria tool) of a BIM-based certification process, it is necessary to develop a comprehensive integrated tool solution. In Switzerland, this is could be the LESOSAI application (Swiss solution), which has the capability to cover LCA and LCC related criteria evaluation. To achieve stage 2 (BIM-based "building as a product" -criteria) the already existing simulation tools need to be supplemented with intelligent model checker tools, which can cover the operationalized criteria contained in the DGNB system in a BIM-based way comprehensively. Corresponding rulesets in model checker applications (e.g. Solibri) need to be developed for this purpose, due to the fact that few rule sets are accessible today (often for single purposes e.g. accessibility or for specific business needs or countries). To achieve stage 3 (BIM-based process criteria) major adjustments have to be done for system-related criteria requirements as well as advanced BIM applications are necessary in the medium term. Following this study the ZHAW Institute of Facility Management is in preparation of more research activities.

The results of this study show, that a lot of the material and product-related data needed for certification by Swiss DGNB can be drawn from BIM-based planning and construction processes, as some kind of a by-product. This will help to avoid "additional costs" may be caused by a sustainability certification. Assuming that building certificates will have more significant impact on the property value, a combination of sustainability certification with the use of BIM will make the investment for the appliance of BIM even more valuable on the longterm.

The result is a sustainable win-win situation both technologies can mutually benefit from, and environment and society as well.

REFERENCES

- [1] DGNB (2012). DGNB System in der Version 2015 für Büro- und Verwaltungsgebäude. DGNB Selbstverlag.
- [2] Egger, M. et al. (2013). BIM Leitfaden für Deutschland. Forschungsprogramm Zukunft Bau (BMVBS). 74-76.
- [3] Official Lesosai presentation (2016). Lesosai und BIM. E4tech Software S.A., Lausanne, p3-11.
- [4] SIA: (2016) Building Information Modelling (BIM) – Grundlagen zur Anwendung der BIM-Methode. Vernehmlassung Entwurf prSIA 2051, p.7
- [5] SIA: Regulation SIA 112 2001. Service Model. 1st edition 3000/ Schwabe, MuttENZ. p. 6.
- [6] US BIM Standard (2015). National BIM Standard-United States Version 3 Release Postponed 2015.
- [7] Wallbaum H. (2010). Stärkung des Netzwerkes nachhaltiges Bauen Schweiz. Inputpapier KBOB/ETHZ, p19-21.

LCA Integration in BIM Through the Use of Integrated Dynamic Models

Marios TSIKOS^a, Kristoffer NEGENDAHL^b, Jan Schipull KAUSCHEN^c

^a Burohappold Engineering, United Kingdom, marios.tsikos@burohappold.com

^b Technical University of Denmark, denmark, kmj@byg.dtu.dk

^c Vandkunsten Architects, denmark, jak@vandkunst.dk

ABSTRACT

The Architecture, Engineering and Construction industry has many times been criticized for lack of control and management of its environmental impacts. In an attempt to monitor and minimize these impacts, the method of Life Cycle Assessment is being used more and more often during the design process of construction projects. Nevertheless, the whole process of **performing a building's LCA is considered time consuming which sometimes** prevents the design teams from using it more than once in the end of the design as a way to assess the impacts of their final design. The aim of this study is to suggest a method which will render LCA a design tool used during **the whole design process. The study focuses not only in creating a tool that will be able to assess a building's environmental impacts, but will also be an analysis tool which will help the design teams make the right decisions and help them minimize their design's environmental impacts. To achieve this, this study evaluated the potential** of integrating LCA into BIM, developed and proposed an Integrated Dynamic Model using Revit, Dynamo and Excel. The Integrated Dynamic model was used in case studies the results of which were compared with the respective ones from other established LCA software. The results showed that the integrated dynamic model can create results of equal quality and precision with other specialized software while demanding significantly less time. The ease of use of such an integrated dynamic model and the instant creation of results could render it a decision-making tool in respect with LCA.

Keywords: Life Cycle Assessment, Building Information Modelling, design process

1. INTRODUCTION

Recent studies have shown that buildings are responsible for 30 - 40% of the energy consumption in Europe (Zabalza Bribián et al. 2009) and 40 - 50% of the greenhouse gas produced globally (Abd Rashid & Yusoff 2015). Increased awareness on the fact has led to the conduction of studies on how to reduce the environmental impacts of buildings. Life Cycle Assessment (LCA) which is one of the methods that have been developed and used to quantify the environmental impacts of a process or product (European Commission -- Joint Research Centre -- Institute for Environment and Sustainability 2010) is used in the building sector since 1990 in order to assess the environmental impacts of buildings (Ortiz et al. 2009). On the other hand, the building industry continuously aims **for cost reduction and simultaneous increase of the projects' quality (Tao & Tam 2013). Therefore, methods that** can lead to more sustainable design of buildings while assisting in keeping the total budget low are of high interest in the last few years.

Various tools and methods have been developed till today that can assess a building's environmental impacts (Liu et al. 2015) but few have been done to assist the architects and engineers to make the right choices in the early design stage of a building. Considering that the early stage of a building design is the stage when environmental matters are best arranged and given the fact that making good design decisions at the initial stage plays an important role in reducing a project's cost and completion time, the development of such a tool is considered necessary. The emerge of Building Information Modelling (BIM) concept, the wide use of it in the Architecture, Engineering and Construction (AEC) industry and the benefits of its use in respects with the information enrichment and visual representation of a building (Eastman 2011), dictates that such a tool should also be able to be integrated and interact with the most popular BIM software in the AEC industry.

This study aims to develop an Integrated Dynamic Model (IDM) (Negendahl 2015) that would enable design teams to assess the environmental impacts of their design from the early stages of the design through the end of it. The developed model is built to function as a design tool for the design team and offer useful feedback regarding the environmental impacts.

The IDM developed during this study consists of Revit (Autodesk 2016), Dynamo (Autodesk 2015) and an external Life Cycle Impacts (LCI) database. The results of this IDM are produced in a material level and exported in an excel sheet enabling the analysts perform hotspot analyses in a material level, construction type level or construction category level.

2. LCA IN CONSTRUCTION INDUSTRY AND BIM

The recognition of LCA as a factor of sustainability assessment of buildings has led to the increasing use of it in the construction industry. The way it is usually performed though, differs from LCAs performed for other products. The fact that buildings are not industrialized products in their majority makes a detailed LCA hard and time consuming. For this reason, in most of the cases these assessments are based on a material database that **contains various generic materials' impacts per specific quantity unit**. These impacts are then multiplied with the **quantities of the construction's materials to give the total impacts of the construction**.

The emerge of BIM concept, the wide use of it in the AEC industry and the benefits of its use in respects with the information enrichment and visual representation of a building (Eastman 2011), dictates that BIM models could be **the source of all relevant information needed for a project's LCA**.

The integration of projects' LCA studies in BIM will not only make LCA analysis faster but by using the graphical interface of BIM tools, the results from the LCA analysis will be communicated better among the different engineering disciplines and architects. This better communication of results could lead in more sustainable solutions for the studied buildings and projects (Jensen & Nielsen 2011).

3. PROPOSED METHOD (INTEGRATED DYNAMIC MODEL)

The proposed method consists of an Integrated Dynamic Model where the connection of Revit is used with an external material LCI database and the Visual Programming Language (VPL) Dynamo. The LCI database is the source where VPL gets the environmental impacts of the used materials from. The database consists of all common construction materials and their environmental impacts per a specific functional unit (m^2 or m^3).

The basic concept of the proposed model is that there is a permanent link between the Revit materials and the Database materials resulting to zero input from the user every time they want to perform an LCA. To achieve this permanent link, a unique material ID is employed which is the same in both the Revit material library and the LCI database.

Given the material linkage, a script developed in Dynamo is able to automatically read and understand each Revit **material's environmental impacts from** the LCI database. Getting the material take-off from the BIM model in the same script, it is possible to calculate the total life cycle environmental impacts. Finally, the results are formed accordingly and exported in a new excel sheet which generates all the necessary graphs and charts.

As shown in the model's overview in Figure 1, an advantage of calculations actually happening in the BIM environment itself is the graphical feedback of the results. The use of Dynamo for the entire calculation means that the model can also take advantage of the colour override functionalities it offers. The final results are interpreted visually in the BIM environment and numerically by being exported in an excel sheet where analytical charts are produced.

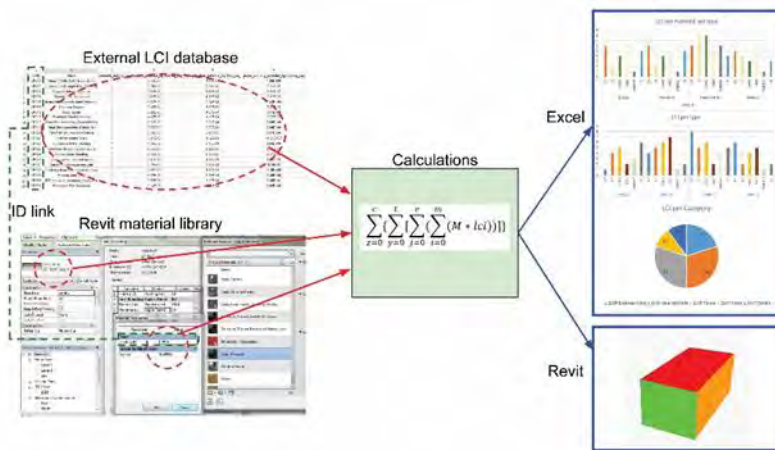

Figure 1: Overview of the proposed model for LCA integration to BIM

3.1 Life cycle impacts database structure

The Excel based database (Figure 2) contains the life cycle environmental impacts of a number of predefined construction materials for specific impact categories. **The materials' functional unit was chosen to be m² or m³** since these quantities can be extracted from the BIM model. The materials that are modelled in Revit as membranes are stored with their impacts per m² while all the rest as impacts per m³.

	A	B	C	D	E	F	G	H	I	J	K	L	M	N	O	P	Q	R	S	T	U	V	W	X	Y	Z	AA	AB	AC	
	Material Name	Date Source	Density	Densit y Unit	Functional Unit	GWP	ODP	POCP	AP	EP	ADPE	PENRE	PERE	RSF	GWP	ODP	POCP	AP	EP	ADPE	PENRE	PERE	RSF	ID	Life Expectanc y - Out	Life Expectanc y - Core	Life Expectanc y - In			
12	1.1.02_Lime (C 2015)	06/08/15	1980.0	kg/m3	m3	1459	1E-07	0.0341	0.4154	0.006	2E-05	6446	54.88	0.04	EoL→	0.00	0.00	0.00	0.00	0.00	0.00	0.00	0.00	0.00	0.00	00018	50	50	120	
14	1.1.02_Calcium 2015	06/08/15	2210.0	kg/m3	m3	2457.8	2E-07	0.0644	0.8995	0.1131	3E-05	10935	122.213	0.07	EoL→	0.00	0.00	0.00	0.00	0.00	0.00	0.00	0.00	0.00	0.00	0.00	00017	50	50	120
16	1.1.03_Anhydri 2015	06/08/15	2900.0	kg/m3	m3	290.43	4E-07	0.1036	1.7341	0.0721	4E-05	3516	109.102	0.06	EoL→	0.00	0.00	0.00	0.00	0.00	0.00	0.00	0.00	0.00	0.00	0.00	00014	50	50	120
18	1.1.03_Gypsum 2015	06/08/15	2320.0	kg/m3	m3	604.13	4E-07	0.0765	0.9791	0.0827	2E-05	8991.8	192.676	0.11	EoL→	0.00	0.00	0.00	0.00	0.00	0.00	0.00	0.00	0.00	0.00	0.00	00016	50	50	120
20	1.1.03_Gypsum 2015	06/08/15	2320.0	kg/m3	m3	294.02	2E-07	0.0255	0.2967	0.0388	0.048	4906.6	116.993	0.05	EoL→	0.00	0.00	0.00	0.00	0.00	0.00	0.00	0.00	0.00	0.00	0.00	00018	50	50	120
22	1.1.03_Gypsum 2015	06/08/15	2320.0	kg/m3	m3	6.8598	2E-06	0.6037	0.0297	0.0071	0.992	91.802	7.7624	0	EoL→	0.00	0.00	0.00	0.00	0.00	0.00	0.00	0.00	0.00	0.00	0.00	00020	50	50	120
24	1.1.04_Clay poi 2015	06/08/15	1320.0	kg/m3	m3	464.64	2E-07	0.8372	0.5288	0.0556	6E-06	1821.6	73.92	0.01	EoL→	0.00	0.00	0.00	0.00	0.00	0.00	0.00	0.00	0.00	0.00	0.00	00022	50	50	120
26	1.2.01_Gravel (2015)	06/08/15	2000.0	kg/m3	m3	17.546	2E-08	-0.014	0.0586	0.0129	1E-06	214.4	14.134	0.02	EoL→	0.00	0.00	0.00	0.00	0.00	0.00	0.00	0.00	0.00	0.00	0.00	00024	50	50	120
28	1.2.01_Sand ig 2015	06/08/15	1900.0	kg/m3	m3	16.889	1E-06	-0.014	0.0557	0.0123	1E-06	203.88	13.4273	0.02	EoL→	0.00	0.00	0.00	0.00	0.00	0.00	0.00	0.00	0.00	0.00	0.00	00026	50	50	120
30	1.2.01_Sand gr 2015	06/08/15	1950.0	kg/m3	m3	83.714	2E-06	-0.007	0.1149	0.0214	7E-06	1792.8	16.928	0.03	EoL→	0.00	0.00	0.00	0.00	0.00	0.00	0.00	0.00	0.00	0.00	0.00	00028	50	50	120
32	1.2.02_Limesto 2015	06/08/15	1350.0	kg/m3	m3	29.201	8E-08	-0.008	0.0723	0.013	2E-06	486.88	69.7265	0	EoL→	0.00	0.00	0.00	0.00	0.00	0.00	0.00	0.00	0.00	0.00	0.00	00029	50	50	120
34	1.2.02_Cruiate 2015	06/08/15	1350.0	kg/m3	m3	58.347	1E-07	-0.004	0.0957	0.0164	4E-06	883.64	80.355	0.01	EoL→	0.00	0.00	0.00	0.00	0.00	0.00	0.00	0.00	0.00	0.00	0.00	00032	50	50	120
36	1.2.02_Limesto 2015	06/08/15	1400.0	kg/m3	m3	30.282	1E-07	-0.008	0.0715	0.0135	2E-06	425.12	51.862	0.01	EoL→	0.00	0.00	0.00	0.00	0.00	0.00	0.00	0.00	0.00	0.00	0.00	00034	50	50	120
38	1.2.02_Cruiate 2015	06/08/15	1400.0	kg/m3	m3	60.508	1E-07	-0.004	0.0992	0.017	4E-06	916.3	52.22	0.01	EoL→	0.00	0.00	0.00	0.00	0.00	0.00	0.00	0.00	0.00	0.00	0.00	00036	50	50	120
40	1.2.02_Limesto 2015	06/08/15	1600.0	kg/m3	m3	34.608	1E-07	-0.009	0.0867	0.0154	2E-06	481.26	58.928	0.01	EoL→	0.00	0.00	0.00	0.00	0.00	0.00	0.00	0.00	0.00	0.00	0.00	00038	50	50	120
42	1.2.02_Cruiate 2015	06/08/15	1600.0	kg/m3	m3	69.152	1E-07	-0.005	0.1134	0.0194	4E-06	1047.2	59.88	0.01	EoL→	0.00	0.00	0.00	0.00	0.00	0.00	0.00	0.00	0.00	0.00	0.00	00040	50	50	120
44	1.2.02_Light w 2015	06/08/15	1200.0	kg/m3	m3	16.282	8E-08	-0.004	0.0658	0.0195	7E-07	139.56	8.4004	0	EoL→	0.00	0.00	0.00	0.00	0.00	0.00	0.00	0.00	0.00	0.00	0.00	00042	50	50	120
46	1.2.02_Lime gr 2015	06/08/15	1100.0	kg/m3	m3	4.4666	2E-10	-0.001	0.0488	0.0121	2E-07	99.772	3.5624	0	EoL→	0.00	0.00	0.00	0.00	0.00	0.00	0.00	0.00	0.00	0.00	0.00	00044	50	50	120
48	1.2.03_Permice 2015	06/08/15	300.0	kg/m2	m2	2.5767	2E-99	-3E-64	0.0165	0.0041	2E-07	34.86	2.1072	0	EoL→	0.00	0.00	0.00	0.00	0.00	0.00	0.00	0.00	0.00	0.00	0.00	00046	50	50	120
50	1.2.03_Washin 2015	06/08/15	300.0	kg/m2	m2	3.189	2E-49	-0.003	0.02	0.005	2E-07	43.41	2.4426	0	EoL→	0.00	0.00	0.00	0.00	0.00	0.00	0.00	0.00	0.00	0.00	0.00	00048	50	50	120
52	1.2.04_Expand 2015	06/08/15	500.0	kg/m3	m3	237.17	2E-07	0.1191	1.6491	0.073	1E-04	3551.8	352.482	10.3	EoL→	0.00	0.00	0.00	0.00	0.00	0.00	0.00	0.00	0.00	0.00	0.00	00050	50	50	120
54	1.2.05_Expand 2015	06/08/15	800.0	kg/m3	m3	281.69	2E-07	0.1126	2.566	0.099	4E-06	1752.8	78.836	0.04	EoL→	0.00	0.00	0.00	0.00	0.00	0.00	0.00	0.00	0.00	0.00	0.00	00052	50	50	120
57	1.2.06_Expand 2015	06/08/15	280.0	kg/m3	m3	78.12	1E-07	0.0035	0.2252	0.0549	1E-05	1642.6	491.04	0.02	EoL→	0.00	0.00	0.00	0.00	0.00	0.00	0.00	0.00	0.00	0.00	0.00	00055	50	50	120
59	1.2.07_Perite (2015)	06/08/15	6000.0	kg/m3	m3	545.5	2E-07	0.084	0.7656	0.1947	2E-05	7631	85.4	0.06	EoL→	0.00	0.00	0.00	0.00	0.00	0.00	0.00	0.00	0.00	0.00	0.00	00057	50	50	120
61	1.2.07_Perite (2015)	06/08/15	6000.0	kg/m3	m3	563.9	2E-07	0.0856	0.811	0.1989	3E-05	8151	86.44	0.06	EoL→	0.00	0.00	0.00	0.00	0.00	0.00	0.00	0.00	0.00	0.00	0.00	00059	50	50	120

Figure 2: LCI database structure

The environmental impacts are divided into manufacturing impacts and End-of-Life (EoL) impacts to enable the organization of the final results into the respective life cycle categories. For validation reasons information like the functional unit, the density and the source for each material are also stored in the database. The life expectancy of each material is given in three different values to enable the lifetime estimation of each material in the BIM model according to its exposure to the exterior environment. This way, the same material can be considered with different lifetime whether it is placed on the exterior of an exterior wall, on an interior wall or in the core of a wall.

3.2 Datasets and material linking

The unique ID which serves as the link between the database materials and the BIM materials is stored both in the database (Figure 2) and the BIM model. In the BIM model the material ID is stored as a material property which can be read by the VPL that will then identify and link it with a dataset. This way, a permanent link is created between the LCI database and the BIM material library reducing the time needed for a whole LCA performance since the user is not called to link the materials one by one as in most of the LCA applications. In this method, the link is performed only once when the LCI database and the BIM material library are formed. After this and for every **new project the BIM material library will always contain the “key” (Figure 4) to its materials' respective datasets** in the database.

3.3 Classification system

Although in most BIM applications the elements that can be used are sorted per categories like beams, walls, columns, etc., there are a lot of cases where elements have to be modelled as generic models. Regarding this specific application, this means that these elements and their respective environmental impacts cannot be included in a category in the interpretation of the results. By employing a classification system, these elements can be given a code which specifies what kind of element they are. Then, VPL, by reading these codes sorts the final results by **code**. **This way, in the final results, in the beams' impacts not only the elements that were modelled as beams will be included but also elements modelled as generic models and used as beams.**

In this specific application, the BIM7AA encoding system (BIM7AA 2015) is used because it is simple enough to use and provides all the functionalities needed. Similarly, other encoding or classification systems can be used **according to the developer's or user's preference.**

3.4 Dynamo script

For the proposed IDM, the VPL works not only as the medium to translate and transfer the data to the Building Performance Simulation (BPS) tool, but as the BPS tool itself. Subsequently, the Dynamo script (Figure 3) contains coding for both reading-gathering data from the design tool (Revit) and the database and performing the **calculations**. **The Dynamo script can be "divided" in parts**-steps that undertake different functionalities. These functionalities can be divided to Material take-off, database reading, materials-datasets matching, LCI calculation and communication of results.

The material take-off gets all the materials' quantities in m² or m³ depending on if they are modelled as membrane or regular materials. The database reading results in importing of the excel database into Dynamo and the sorting of the data into appropriate lists which facilitate the calculation thereafter. The materials-datasets matching actually links every material with a dataset by creating a list of keys which is of equal size with the materials' list and leads to the corresponding datasets (Figure 4).

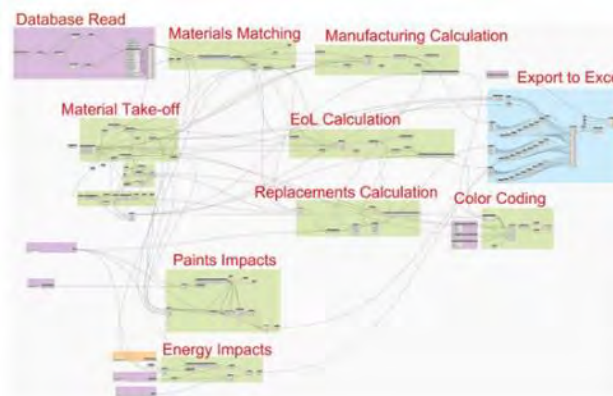

Figure 3: Dynamo script overview

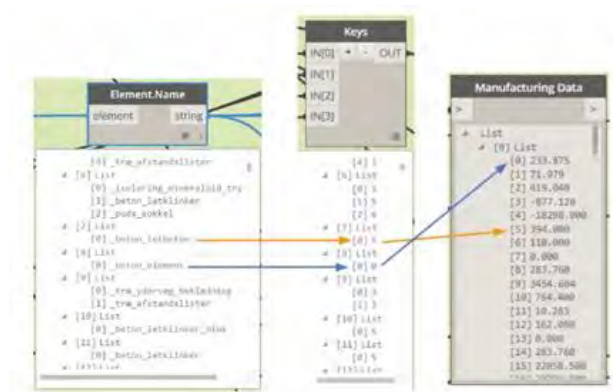

Figure 4: Revit material linkage with LCI

The LCI calculation takes under consideration the manufacturing, the EoL and the use stage of each material. The **use stage is considered by the number of replacement of each material during the building's lifetime. This is achieved by estimating each material's lifetime according to its exposure to the exterior environment and the lifetimes provided in the database.** Furthermore, the impacts of the paints and the energy used are also included. The paints are treated differently since it is a common practice not to be added as materials in the BIM model but as a graphical representation or text information. For this application, the paints information is added as text information in the material which is then recognized by the script that can treat it as a regular material. The energy impacts are included in order to make the final report more complete. Ideally the energy consumption would be calculated in the design tool itself being automatically accessible by the VPL.

Finally, after the calculation of the impacts, the communication of the results occurs both analytically and visually (Figure 5). VPL, taking the advantage of producing the results in the BIM environment, color-codes all elements in the geometrical model according to their contribution to the final impacts. This color-coding can be performed for **any impact category or element category (walls, roofs, etc.) according to the user's preference. The elements can also be color-coded according to some predefined reference values or relatively to each other.**

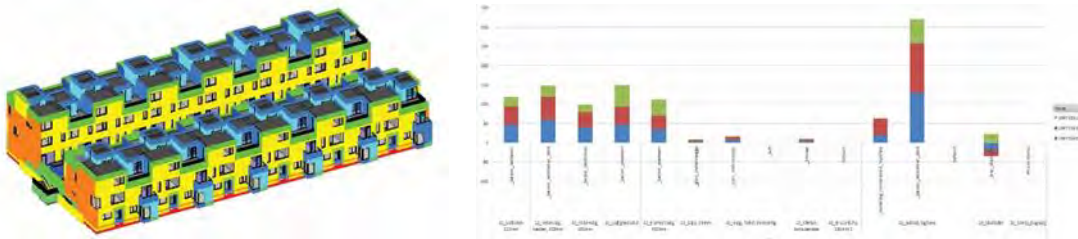

Figure 5: Visual (left) and analytical (right) representation of results

As for the analytical results, these are exported to an Excel sheet sorted by material, family type, classification number and life cycle stage. This detailed production of results enables better comparison of design options by using charts that are produced automatically in Excel.

3.5 Pre-check

The accuracy of the produced results by the proposed LCA IDM depends on the accuracy of the datasets and the accuracy of the information of the Revit model. To ensure that all needed information are included in the Revit model, a new IDM is used to check the BIM model before the LCA IDM is run. This IDM performs various checks before it approves that the BIM model is ready to be used to the LCA IDM. Of course, the LCA IDM is built in a way that it surpasses and ignores (but reports) any potential errors so that it gives a final result. This pre-check **IDM's purpose is to enhance the accuracy of the LCA model's results by informing the modeller what is not modelled correctly.** The checks performed by this IDM include missing classification codes, missing or invalid material IDs, wrong material links and elements with no materials assigned. The results of these checks are communicated by text in the VPL environment and visually by color-coding the problematic elements in the BIM model.

4. EVALUATION OF THE LCA INTEGRATED DYNAMIC MODEL

The proposed IDM was evaluated in terms of accuracy of results and time needed for a full LCA analysis. This was **done by performing a building's** assessment with the developed IDM, LCAbyg (Statens Byggeforskningsinstitut Aalborg Universitet 2016) and tally (KT Innovations et al. 2015). LCAbyg was chosen because it is among the most popular LCA tools for assessing buildings in Denmark and its results were used for assessing the accuracy of the developed IDM. As for tally, since it uses an American database and a different LCA method than the custom LCI database, a deviation was expected between its results and the results of the IDM. It was chosen though mainly for comparing the efficiency of the two methods in terms of time needed for a full LCA assessment. For the same case study, the Global Warming Potential (GWP) results are presented at Table 1.

Tool/Method	GWP (kg CO ₂ Eq.)	Deviation
Integrated Dynamic model	1,38E+06	0%
LCAByg	1,44E+06	+4%
Tally	2,84E+06	+51%

Table 1: GWP results of case study

Regarding the time needed for a full assessment, the proposed IDM created results in less than one minute while using tally this time was more than two hours since all materials had to manually be linked with datasets one by one. **The IDM's strongest advantage though, is the fact that it is a tool that can be easily modified by the user to meet any specific requirement.** By modifying the custom LCI database and adding new "equivalent" datasets the practitioner can overcome issues like including elements that are not modelled in the BIM model (screws, foils, tapes etc.), including non-conventional materials and in general to adjust the whole process according to the standards the BIM model is produced.

5. DISCUSSION

After the evaluation of the developed IDM, it appears that it could potentially be useful for engineers and architects who try to monitor and minimize the environmental impacts of their design in all stages, from the pre-conceptual to the end of the detailed one. Nevertheless, there are factors that can affect the validity of the results of the developed IDMs. These factors include the precision of the BIM model, the material take-off precision and the accuracy of the database. The BIM model precision is related with the geometry modelled by the modeller, while the material take-off is related to the software itself. For the purpose of this study it is assumed that the material take-off produced from Revit is accurate enough for use in LCA. As for the database, since it is custom made by getting datasets from other databases or by creating new ones, its accuracy can strongly affect the final results. **For this reason, it is recommended that the database's datasets come from the same source.**

Furthermore, the same concept with the developed IDM can be used to perform Life Cycle Cost (LCC) assessments of buildings. Similarly with the LCA IDM, an LCC IDM can use a cost database of materials or elements and thus **estimate the cost during the building's life cycle.**

6. CONCLUSION

The case studies of the proposed IDM showed that such a model could facilitate the assessment of a building from the early stages of design and provide useful feedback in a short amount of time. The level of detail of the produced results facilitates the further analysis by the LCA practitioner. The results can be interpreted in material, construction type and construction category level, helping the practitioner perform a hotspot analysis, detect materials and constructions causing higher impacts and perform the necessary changes. The visual representation of the results directly in the BIM environment by color-coding of the building elements is also a feature that is helpful in terms of quickly detecting the hotspots in the construction type level.

Regarding the complexity, the use of IDMs for LCA is considered not more complicated than the use of conventional simplified LCA tools. The complexity in this case has mainly to do with the use of the VPL language. The practitioner must have some basic knowledge in VPL while at least one practitioner in the design team should be able to verify the final results and maintain the LCI database. On the other hand, the assessments are performed much faster in the IDM while LCA knowledge is not a prerequisite for a practitioner to perform them. This, combined with the fact that the inventory is automatically updated when changes occur in the geometrical model, enables the production of more results with a lot of iterations in considerably less time and leaves the LCA specialist more time to analyse the results instead of creating them and then analyse them. In the same time the modeller can use the time saved for more iterations or other tasks more relevant to their discipline.

To conclude with, this study showed that the use of LCA IDMs can help towards the integration of LCA in the design process and the design of more sustainable constructions in terms of environmental impacts. The developed IDM, with some further development and improvements could be used by design teams while they could be the basis for development of new more stable and precise LCA IDMs.

REFERENCES

- [1] Abd Rashid, A.F. & Yusoff, S., 2015. A review of life cycle assessment method for building industry. *Renewable and Sustainable Energy Reviews*, 45, pp.244–248.
- [2] Autodesk, 2015. Dynamo. Available at: <http://dynamobim.org/learn/>.
- [3] Autodesk, 2016. Revit. Available at: <http://www.autodesk.com/products/revit-family/overview>.
- [4] BIM7AA, 2015. BIM7AA TYPE CODE V. 2.1 - 2015.07.09 UK., pp.1–28. Available at: <http://www.bim7aa.dk/>.
- [5] Eastman, C.M., 2011. *BIM handbook: a guide to building information modeling for owners, managers, designers, engineers and contractors*, Wiley.
- [6] European Commission -- Joint Research Centre -- Institute for Environment and Sustainability, 2010. *International Reference Life Cycle Data System (ILCD) Handbook -- General guide for Life Cycle Assessment -- Detailed guidance*,
- [7] Jensen, L.B. & Nielsen, T.R., 2011. Obstacles and new opportunities for integrated design.
- [8] KT Innovations, Thinkstep & Autodesk, 2015. tally. Available at: <http://choosetally.com/>.
- [9] Liu, S., Meng, X. & Tam, C., 2015. Building information modeling based building design optimization for sustainability. *Energy and Buildings*, 105, pp.139–153.
- [10] Negendahl, K., 2015. Building performance simulation in the early design stage: An introduction to integrated dynamic models. *Automation in Construction*, 54, pp.39–53.
- [11] Ortiz, O., Castells, F. & Sonnemann, G., 2009. Sustainability in the construction industry: A review of recent developments based on LCA. *Construction and Building Materials*, 23(1), pp.28–39.
- [12] Statens Byggeforskningsinstitut Aalborg Universitet, 2016. LCAByg. Available at: <http://www.lcabyg.dk/>.
- [13] Tao, R. & Tam, C.-M., 2013. System reliability theory based multiple-objective optimization model for construction projects. *Automation in Construction*, 31, pp.54–64.
- [14] Zabalza Bribián, I., Aranda Usón, A. & Scarpellini, S., 2009. Life cycle assessment in buildings: State-of-the-art and simplified LCA methodology as a complement for building certification. *Building and Environment*, 44(12), pp.2510–2520.

Visualising Embodied Impacts Using Building Information Modelling (BIM)

Martin RÖCK^a, Guillaume HABERT^b, Alexander PASSER^c

^a Working Group Sustainability Assessment - Institute of Technology and Testing of Building Materials - Graz University of Technology, Austria, martin.roeck@tugraz.at

^b Chair of Sustainable Construction, Institute of Construction & Infrastructure Mgmt., ETH Zurich, Switzerland, habert@ibi.baug.ethz.ch

^c Working Group Sustainability Assessment - Institute of Technology and Testing of Building Materials - Graz University of Technology, Austria, alexander.passer@tugraz.at

ABSTRACT

Against the background of changing societies and our planet's changing climate, the project presented deals with the various aspects of sustainability and tries to envision a democratic and sustainable design process supported by technology.

To identify the purpose and objectives for the project, a participatory design process with a co-housing group was **conducted to define the group's common vision** and requirements towards a residential project. Through several workshops these were elaborated and shaped into first conceptual designs. To assess and improve the environmental performance of these concepts and support fact-based design decisions, a variety of scenarios for building materialisation, energy standard and energy supply mix were compared through the application of Life Cycle Assessment (LCA). Working towards the integration of LCA into the architectural design and planning process, a prototypical workflow to combine LCA with the planning method of Building Information Modelling (BIM) was developed. Through the application of visual scripting, essential steps of LCA could be integrated into a BIM workflow and innovative methods of communicating assessment results using the digital building model could be shown.

Keywords: life-cycle assessment, Building Information Modelling, embodied energy

1. INTRODUCTION

In a rapidly evolving and energy demanding present, sustainability is gaining ever more relevance in designing new buildings and infrastructure as well as retrofitting the existing building stock. The sheer number of stakeholders involved in the highly interrelated building design and planning process emphasizes the need for clear communication among all parties involved on how to improve the environmental performance of the built environment.

To evaluate the environmental performance of buildings over their life cycle, the method of Life Cycle Assessment (LCA) has been widely accepted, standardized and is increasingly applied to assess the built environment. LCA is commonly used to assess and improve upstream processes, like material sourcing and production of construction products through Environmental Product Declarations (EPDs). Comprehensive LCA of buildings is mainly applied to evaluate and document existing buildings but is hardly implemented in the building design process.

At the same time, state-of-the-art planning and building management methods like Building Information Modelling (BIM), follow an object-oriented modelling approach and provide potential to integrate life cycle information and LCA during the design process. The increasing standardization of BIM in terms of building element structure, Levels of Detail in modelling (LOD), and intended purpose of the building model in different planning stages furthermore supports a transparent and comprehensible application of BIM for LCA.

In order to tackle the outlined challenges and support the integration of comprehensible LCA during the building design process, we build on the advances mentioned and integrate information on embodied impacts into BIM. This enables us to use the model to evaluate the sum of embodied impacts using predefined construction profiles to test different materialization options by linking the process with an existing assessment tool. Furthermore, we present a prototypical method to visualize the embodied impacts using the BIM model, to support intuitive optimization and the communication of assessment results throughout the planning process.

2. METHODOLOGY

The environmental design process presented is based on requirements and a building design developed throughout a participatory design process with future inhabitants of a residential co-housing project.

To assess the environmental performance of the architectural concept in various stages, we perform a simplified LCA through application of the district evaluation spreadsheet tool (DEST) of the Swiss 2000 Watt society, comparing the results to the underlying benchmarks of the 2000 Watt society model. A first assessment comparing different materialization options is based on the program and requirements of the participatory process and serves as an estimate result to further develop the conceptual building design.

The developed design is then assessed using actual element quantities of the BIM model to refine the Life Cycle Inventory (LCI). Within the DEST the LCI is by default structured according to Swiss building element structure eBKP-H which was designed to evaluate building element cost. This element structure was also applied to structure the building elements of the BIM model to serve as a common structure and support data exchange between the DEST and the BIM model. This supported the extraction and transfer of quantities as well as the integration of life cycle information in the BIM model, which was automated through the application of Visual Scripting (VS).

2.1 Tools

Building Information Modelling (BIM) is a contemporary digital planning and building management method. A building information model (BIM model) is a component-specific building database that can be used to hold, update and document information related to the building life cycle. The object-based BIM model is increasingly used for cost management and life cycle analysis. In the present paper BIM is used to extract building quantities for LCA as well as to host life cycle information on the environmental performance of the building elements. The 3D model is also used to visualize information for communication with other stakeholders.

2000 Watt society provides environmental benchmarks for the development of districts and buildings in impact categories of Global Warming Potential (GWP) and Primary Energy Demand (PED_{nr} and PED_{total}), based on the calculation of a personalized “environmental budget”, which must not exceed 2000 Watt constant energy consumption per capita. The method of LCA is used for the assessment of the building concept, through the application of the 2000 Watt society district evaluation spreadsheet tool (DEST). The tool provides component-specific values for embodied impacts for various (customizable) construction options as well as a simplified calculation of the impacts of operational energy demand based on the building energy efficiency classification. The database used is Ecolnvent version 2.2 with calculations based on a building Reference Service Period (RSP) of 60 years.

Visual scripting (VS) provides a graphical scripting interface to manipulate parametrised geometry and alphanumeric data. **VS was used to access the BIM model's geometry and alphanumeric information as well as** to exchange data with the DEST using spreadsheet software. The processes automated to support the integrated LCA and communication of results were: a) Extraction of element quantities from the BIM model; b) Transfer of quantities to 2000 Watt DEST; c) Assessment within 2000 Watt DEST based on BIM quantities and scenario settings; d) Extraction of overall results on building performance in relation to established benchmarks; e) Extraction of detailed assessment data and results (component-specific embodied impacts); f) Integration of component-specific impacts into building elements in the BIM model; g) Visualization of component-specific impacts using the BIM model

2.2 Case study and scenarios

To identify suitable solutions for the further design process of the case study building, different scenarios were assessed for a consistent conceptual building design. The assessment scenarios defined and calculated in the DEST are a combination of options for materialisation (construction profiles, CP), envelope quality and technical services (energy standard, ES), as well as multiple options for the energy mix used to supply the operational energy demand (energy mix, EM). CP, ES and EM each comprised three different options – see exemplary options for CP in Figure 1. Following the strategy of improving the building's environmental performance through efficiency, consistency and sufficiency a total of 27 scenarios was tested.

CONSTRUCTION PROFILE		Overview materialisation
CP1	Massive, concrete	Concrete walls, concrete ceiling and roof construction, wood/aluminum windows, lightweight stud partition
CP2	Lightweight, timber	Wood frame construction walls, wood-concrete composite floor and roof construction, wood/aluminum windows, lightweight stud partition
CP3	Brick-timber (custom)	Perforated brick walls, coffered wooden ceiling and roof construction, wood/aluminum windows, plasterboard partition

Figure 78: Description of options for materialisation (CP), envelope quality and technical services (ES), and energy mix used to supply operational energy demand (EM)

3. RESULTS

In the following, results are first of all presented for the overall performance of the individual building scenarios assessed. Based on these results a group of well-performing scenarios could be identified and investigated in more detail. A best scenario in terms of embodied impacts was identified and the detailed (component-specific) results are presented and discussed in the following. For the refined LCI of this assessment, quantities have been extracted from the BIM model. Detailed LCA results are then presented using conventional diagrams as well as a novel method of visualizing embodied impacts using the BIM model. The three construction profiles are also visually compared to test the visualisation workflow and show its potential for communication of design variants and assessment results to clients and other stakeholders.

The LCA results of the scenario assessments were evaluated in terms of their total environmental impacts regarding the impact categories of GWP and PEDnr. Results are structured into embodied impacts (construction and demolition + replacement), operational (operational energy demand) and building induced mobility. Building induced mobility is a parameter set forth by the 2000 Watt society model, which includes the environmental impacts caused by transfer from or to the building, based on the location of the building and the quality of the connection to the public transit networks. As the site location of the project is fixed, the focus was on identifying suitable building scenarios based on the improvement of the variable parameters of embodied and operational impacts in both impact categories.

In a first step, all 27 scenarios were assessed and the sum of embodied and operational impacts (total impacts) analysed regarding the fulfilment of the target values for PEDnr and GWP. The mapped data shows three clusters (green, orange, red), which result from the energy mix chosen for the scenarios. (see Figure 2)

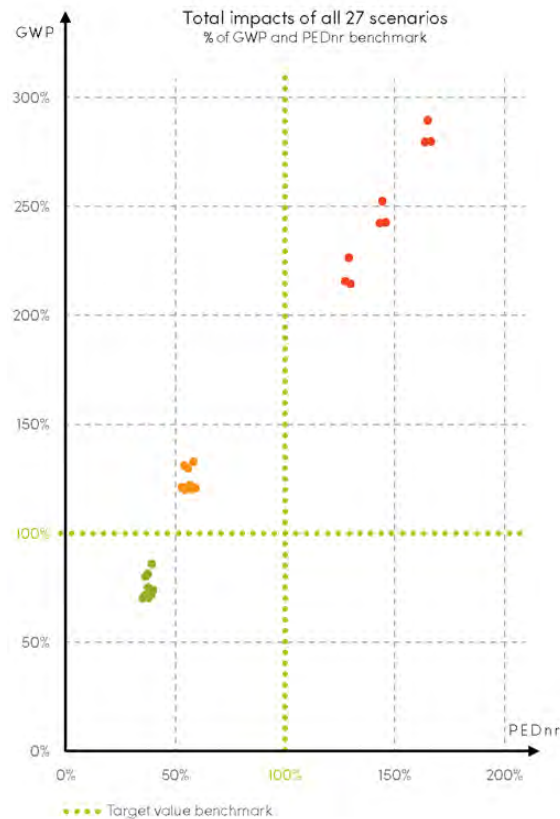

Figure 2: Graph showing the fulfilment of target values for the total impacts of each scenario in impact categories PEDnr and GWP. Clusters of the scenarios resulting from chosen energy mix (EM) can be clearly identified.

- Red cluster: Scenarios 1 - 9, (which apply EM1) are not able to meet either GWP nor PEDnr target values, due to the high impacts caused by building operation.
- Orange cluster: Scenarios 10 - 18 (all applying EM2) are able to meet requirements of PEDnr, however fail to fulfil GWP benchmarks.
- Green cluster: Only the scenarios 19 - 27, which apply energy mix EM3, manage to fulfil the target values in both impact categories, PEDnr and GWP.

Scenario results showed the green cluster of scenarios 19 - 27 should be further investigated. Based on the premise of reducing embodied impacts - and as scenarios 19 - 27 are all applying EM3, which is the best performing, renewable energy mix scenario - scenarios 20 and 21 (CP2 and CP3, each with ES1 and EM3) can be considered suitable construction profiles for the further design process.

Based on a specific construction profile and energy standard – in our case scenario 21 was chosen as the best performing case – the impacts per building element and the contribution of different component categories to the sum of embodied impacts can be identified. Using quantities of the actual building design, e.g. when directly extracted from the BIM model as in our case, the share of an element category of the total embodied impacts can be put in relation to the share of the total quantities assessed to identify the dominance of a certain element category (see Figure 3). High dominance indicates that certain element categories, or individual building elements for that matter, have higher contribution to embodied impacts than to the sum of areas quantified. Focusing on these elements therefore provides high potential for effective improvement of embodied impacts. Especially element categories C 2.1B (external walls above terrain) and E3 (windows and doors) show high dominance and thus potential for improvement in the further design process.

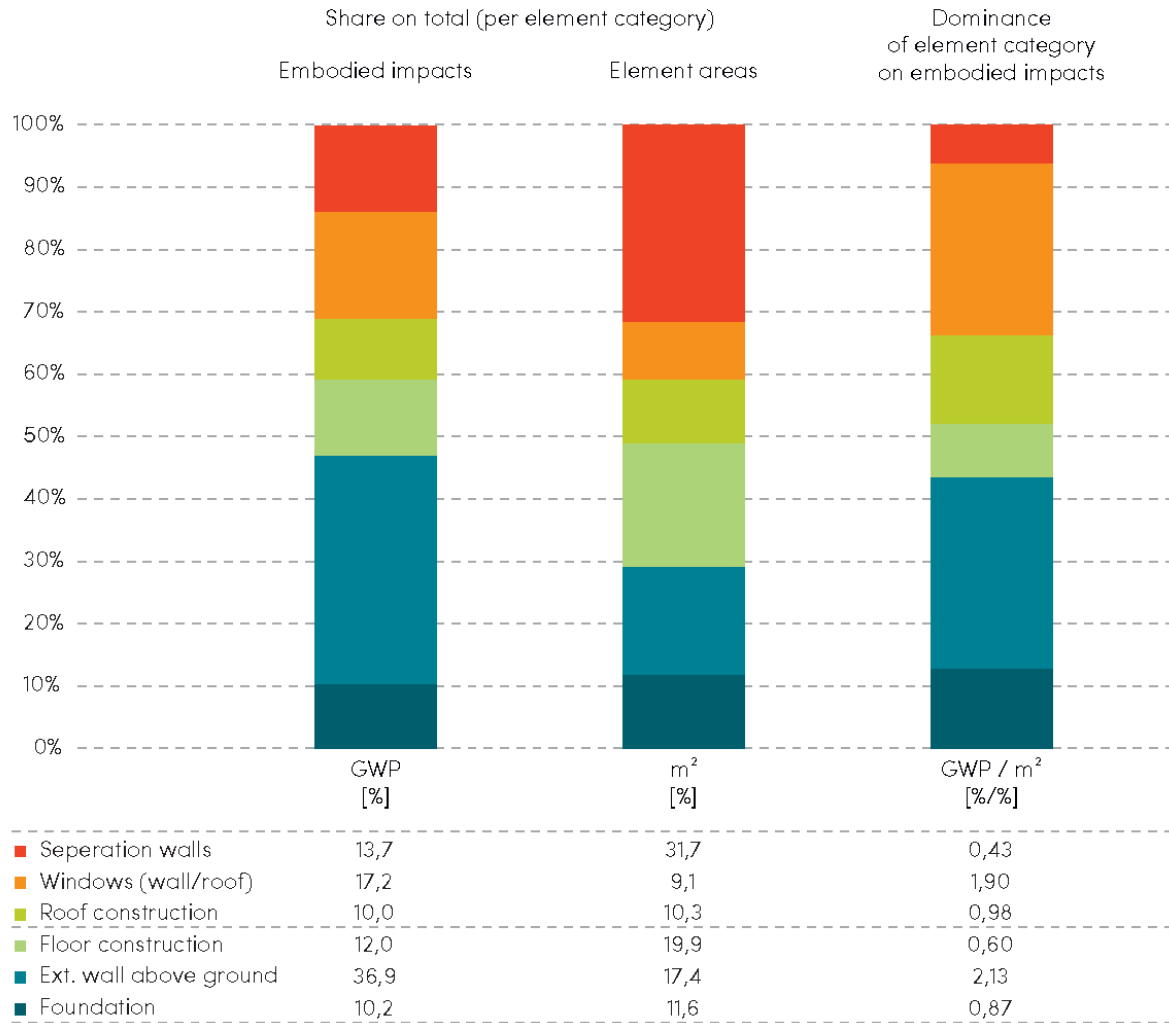

Figure 3: Dominance analysis of element categories. Calculated by comparing an element category's share of total embodied impacts to its share of the total element areas assessed. Values for CP3 (Scenario 21).

4. VISUALIZATION OF IMPACTS

In order to present results and support further development of the design, component-specific embodied impacts can be visualized in different ways. Using the 3D BIM model to present results in a comprehensible way helps to inform designers during the process and to communicate design decisions to clients and other stakeholders. Figure 4 shows possible applications of this visualization workflow to present information on embodied impacts.

This can serve the visualisation of, for example: a) Embodied impacts per unit (m², m³ or per piece) of components; b) Share of the element category of the total of embodied impacts; c) Share of an element category of the totally assessed element quantities, as well as; d) Dominance of a certain element category in the total embodied impacts. The latter highlights areas and elements suitable for effective improvement of embodied impacts (see also Figure 3). Thus, a visual comparison of different construction profiles can help identify strengths and weaknesses as well as potential for improvement in the building design. This may also support the future development of BIM integrated LCA processes.

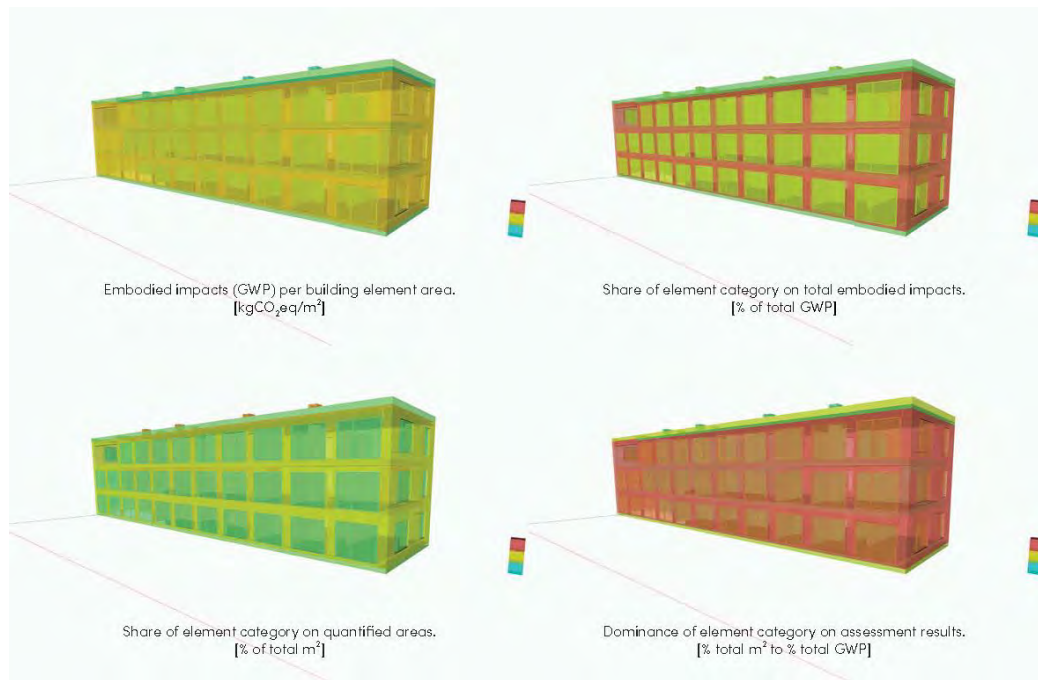

Figure 4: Visualisation of different aspects and results of LCA for scenario 21. Embodied impacts (GWP) per element area, the share of an element category of the total impacts as well as on the areas quantified for the LCI. Combining these shares one can identify the dominance of a certain element category, to highlight elements with improvement potential. The dominance illustration clearly shows external walls and windows in red being the dominating elements categories.

5. DISCUSSION AND OUTLOOK

In the analysis of the scenarios the high dominance of the energy mix could be shown, as in EM3 all construction profiles and energy standards were able to meet the benchmarks. This highlights the importance of choosing a clever energy mix for buildings, which should be based on renewable energy sources wherever possible. For construction profiles (CP) and energy standards (ES) tested, the ES chosen for high energy efficiency during operation also showed higher embodied impacts, due to more insulation and technical systems. This again highlights the possible advantages of reducing embodied as well as total impacts through low impact construction materials and a clever energy mix. The conducted scenario analysis and identification of suitable options can improve design decisions throughout the process and support sustainable building design based on a process-integrated assessment.

For the BIM based quantification, plausible values and results could be shown, supporting the applicability of BIM quantity extraction for LCI in future LCAs. Furthermore, the integration of impact data into the BIM model using the same element structure allowed for a component-specific visualization of impacts, independent of the assessment results. Meanwhile, the validity and completeness of an assessment performed on the basis of component-specific (“per component area”) impacts should be subject to further research through the comparison with complete conventional LCAs on a considerably large number of case studies.

The presented visualization of embodied impacts could promote understanding of the embodied impact concept amongst designers as well as the communication of LCA with clients, planners and other stakeholders. In the future, integration of embodied impacts into BIM combined with building energy simulation towards a process-integrated LCA could enable real-time assessment and a constant visual feedback of the building performance in terms of embodied and operational impacts. The application of visual scripting for that matter is to be further investigated and can support the development of such processes.

Current developments of BIM towards the integration of EPDs through the link to external property and product databases may provide potential to include building and element specific environmental benchmarks to be used during a BIM supported building design process. These developments should be closely monitored and influenced where feasible to improve the integration of LCA and BIM and support sustainable building design processes in the future.

REFERENCES

- [1] A. Hollberg and J. Ruth, "LCA in building design – A parametric approach," *Int. J. Life Cycle Assess.*, vol. forthcomin, 2016.
- [2] ASI, ÖNORM A 6241-2. Austrian Standards Institute, 2015.
- [3] BIMForum, "Level of Development Specification," *BIM Forum*, no. April, p. 195, 2015.
- [4] CEN, ÖNORM EN 15978 - Nachhaltigkeit von Bauwerken - Bewertung der umweltbezogenen Qualität von Gebäuden - Berechnungsmethode. Austria, 2012, p. 64.
- [5] CEN, ÖNORM EN ISO 14040 - Environmental management - Life cycle assessment - Principles and framework. 2006, p. 30.
- [6] CEN, ÖNORM EN ISO 14044 - Environmental management - Life cycle assessment - Requirements and guidelines. 2006, p. 55.
- [7] CEN, TC 442. CEN TC 442, 2016.
- [8] D. Kellenberger, M. Ménard, S. Schneider, M. Hänger, M. Org, K. Victor, and S. Lenel, Arealentwicklung für die 2000-Watt-Gesellschaft: Beurteilungsmethode in Anlehnung an den SIA-Effizienzpfad Energie, no. August. 2012.
- [9] F. B. France, U. Cubasch, P. F. Uk, P. Friedlingstein, P. C. France, M. Collins, and C. Josefino, "Climate Change 2013: The Physical Science Basis. Summary for Policymakers," 2013.
- [10] F. Gschösser, A. Passer, and S. Marchtrenker, "Life Cycle Assessments and the Austrian Construction Sector," in *Full Papers of the International conference on Sustainable Buildings – Construction Products & Technologies*, 2013, pp. 1021–1032.
- [11] K. Kensek, "Visual Programming for Building Information Modeling: Energy and Shading Analysis Case Studies," *J. greenbuilding*, vol. 10, no. 4, pp. 28–43, 2015.
- [12] K. Pfäffli and H. Preisig, "SIA Effizienzpfad Energie," no. 201, 2010.
- [13] M. Balouktsi, "Embodied impacts in stakeholder decision - making in the construction sector," no. March, 2016.
- [14] NATSPEC, "BIM and LOD - Building Information Modelling and Level of Development.," 2013.
- [15] R. Frischknecht, F. Wyss, S. B. Knöpfel, and P. Stolz, "Life cycle assessment in the building sector: analytical tools, environmental information and labels," *Int. J. Life Cycle Assess.*, pp. 421–425, 2015.
- [16] S. Norouzian-Maleki, S. Bell, S.-B. Hosseini, and M. Faizi, "Developing and testing a framework for the assessment of neighbourhood liveability in two contrasting countries: Iran and Estonia," *Ecol. Indic.*, vol. 48, pp. 263–271, Jan. 2015.
- [17] SIA, "eBKP-H SN 506 511 Baukostenplan Hochbau," 2009.
- [18] UNEP SBCI, "Buildings and Climate Change. Summary for Decision-Makers," 2009.

Lifecycle Evaluation of Building Sustainability Using BIM

Raja SHAHMIR^a, ZHANG Cheng^b

^a Xi'an Jiaotong-Liverpool University, Mainland China, raja.shahmir@xjtlu.edu.cn

^b Xi'an Jiaotong-Liverpool University, Mainland China, cheng.zhang@xjtlu.edu.cn

ABSTRACT

Buildings use about 40% of global energy and they emit approximately one-third of GHG emissions. Having such high impact on global sustainability indicators, buildings have greatest potential to reduce this impact. The key to reduce this impact is by quantifying the impact caused during different phases of the life cycle of building (design, construction and operation) and prioritizing the impact mitigating strategies. Life Cycle Analysis is the most adopted methodology for quantifying the impact, however to suggest the impact mitigating strategies is quite cumbersome as multiple software tools are used to conduct such analysis and the reports generated are static. BIM has the potential to keep this data dynamic and enable real-time analysis of these parameters thereby offering intelligent solutions. Previous researches conducted did not utilize the full potential of BIM in integrating life cycle analysis with BIM as most studies exported the model from the main BIM authoring tool and do not consider bringing back the results to the BIM model thereby making the effort useless for incorporating changes in the model.

A novel framework to conduct the analysis within the BIM environment is proposed in this paper focused on both embodied and operational Energy & Carbon as it constitutes a major portion of Life Cycle Analysis of a building. This framework has four steps: i) Data Collection which includes both the design data required for simulations and actual data from the sensors, ii) Data Mapping ensures the proper input of data into the model in a suitable format and at a reasonable memory location by creating content space, iii) Data Analysis comprises of Whole Building Energy Simulation, Life Cycle Energy Analysis and comparison between Simulated and Actual Energy consumption and iv) Alternatives Provision guides the designers to implement effective solutions for reducing the total energy consumption and carbon emissions.

Keywords: building sustainability, BIM, lifecycle evaluation

1. INTRODUCTION

Sustainability has been a high priority goal for the current construction projects; to evaluate and rate the alternatives some common parameters needs to be established to compare them. Life Cycle Energy and Carbon Emissions are the most effective parameters based on which the alternatives can be compared. Quantification of these parameters require a standard method for calculation as well as the data that will act as the input for this method. The process for collecting this information and evaluating the building faces two major challenges: First is the fragmented nature of the construction industry and second is Temporal data that is needed to perform analysis such as Material Wastage, Energy Consumption Data, Air Quality Management, Commissioning and Post Occupational Activities.

The first challenge of fragmented nature of the construction industry brings forward the issue of specialized software that are adopted by experts of a certain phase (such as design) which are not interoperable with other phases there by forcing re-input of data for the subsequent phases which in-turn breaks the virtual chain of building construction process. To address this issue IFC file formats are utilized which allow the interoperability between software products of different vendors but with limitations.

The second challenge of the collection of temporal data brings forward the effort needed to collect the data and the accuracy of the data collection process. A Real-Time Location System (RTLS) is proposed to ensure the accuracy of the spatial position of the sensors. Energy consumption data is collected using a sensing system and energy consumption patterns are analysed based on the spatial division in the building. An expert system is developed to forecast and diagnose energy consumption and achieve energy efficiency by providing corrective measures. Building Information Model acts as a database that can hold all the relevant information for every phase of construction if the templates of the BIM authoring tool are designed as such.

2. LITERATURE REVIEW

Policies, laws and regulations around the world are pushing the construction sector to adopt sustainable innovation in terms of products and processes (Hellstrom, 2007; Steurer, 2011). Building sustainability refers to a building structure and the processes for its use that are environmentally responsible and resource-efficient throughout the building's life-cycle: from siting to design, construction, operation, maintenance, renovation and demolition (UEPA, 2011). This encompasses efficient utilization of resources (energy, water etc.), reduction in environmental degradation due to pollution & waste and regeneration of resources through onsite mechanisms & treatment plants. Sustainability assessment can be defined as the process of identifying, predicting and evaluating the potential impacts of initiatives and alternatives (Devuyst, 2000). Achieving sustainable buildings is possible through a broad range of products and services like heat pumps, solar collectors, insulation systems, shading devices, phase-change materials heating and cooling equipment, photovoltaics, sensor systems for intelligent energy management and energy control and monitoring systems (Kolokotsa, 2011). Therefore, to make a particular building sustainable stakeholders need to do market search and comparison of various solutions based on sustainability criteria, such as return-on-investment, CO₂ emissions, the potential for reducing energy consumption etc. Forecasts of the EIA (2010) show that energy consumption in buildings is increasing at a rate comparable to those of the industrial and transportation sectors. Interestingly, the building sector has the highest energy saving and pollution reduction potential, given the flexibility of its demands (Ipcc, 2007). An information intensive process is necessary to consider the phenomenal number of high-end technology solutions and their suitability for the particular project. By applying sustainable techniques and methods over a period, there should be a considerable amount of change resulting in reduced environmental impacts not only within the built environment but also on a larger ecological scale (Bynum et al., 2013).

In order to measure the building performance sensing system is needed to monitor, collect and transmit the data for analysis. Different sensors, monitoring and control equipment used in various researches are:

- iMeterRail (Electricity meter for electric switch boards): The sensor monitors the consumption of an electrical circuit to deduct the level and kind of activity in each moment.
- Power Plug (Measurement of electrical consumption and control of electric devices): The sensor monitors the consumption of an electrical device
- Clamp (Measurement of electrical consumption of circuits): The sensor monitors the consumption of a **building's section to deduct the level and kind of activity in each moment.**
- Air monitor (Indoor Air quality modules with 4 different sensors: temperature, relative humidity, CO₂ and CO): The sensor monitors air quality of a space to deduct the people density in that space.
- Gateway 1 (Receives data from RF 868 MHz and RS485 devices and send over a TCP/IP connection): The device acquires the data from several devices.
- Gateway 2 (Receives data from ZigBee sensors and sends over a TCP/IP connection): The device acquires the data from several devices.
- RFID Receiver (Equipment to track RFID cards passing by): Track Individual occupants carrying RFID cards.
- RFID Cards (Radio Frequency Cards to be tracked by RFID Receivers): To be carried by Individual Occupants participating in Individual-Based scenarios.
- RFID Reader (Module used to detect the proximity of a RFID tag): The reader is used to track the position **of a person or equipment inside the pilot's buildings.**

As far as building energy is concerned, Embodied energy (EE) and Operational energy (OE) together constitutes **a building's life cycle energy (LCE)**. EE involves the initial energy of the construction (material and burden associated with material consumption in buildings) and OE reveals the energy utilized in operating phase (Praseeda et. al., 2016). There are two more types associated with building energy namely demolition and disposal energy but these are rarely addressed as they together form less than 1% of life cycle energy (Sartori and Hestenes, 2007; Ramesh et. al., 2010).

Both primary energy or secondary energy can be considered for LCE. Primary energy is the raw fuel that is used to create heat and electricity, such as natural gas, coal, or fuel oil while secondary energy is the energy product created from a raw fuel, such as electricity purchased from the grid or heat received from a district steam system (Asif et al., 2007; Atmaca, 2016).

There are three methods used in life cycle analysis: process analysis, input–output (I–O) analysis and hybrid analysis. Due to the complexity of the upstream requirements for goods and services, the process analysis which is used widely has some disadvantages. The second method, I–O analysis, uses national average data for each sector of the economy and is considered by many researchers to be more comprehensive than process analysis. On the other hand, **I–O analysis is usually used as a “black box”, with little understanding of the values being assumed for each process** (Crawford, 2008).

BIM consist of three words Building, Information and Modelling. Building: any structure like residential/commercial buildings, Hospitals and different Infrastructures. Information: the complete information about the building like cost, quality management, safety measures, risk management, structural elements, architectural information. Modeling: a complete 3D representation (Azhar et al., 2012). BIM can be applied in sustainability analysis widely while considering for example building orientation, building envelope, and construction materials. With the introduction of BIM, different attributes of the building envelopes can be recorded in the digital database, for instance carbon dioxide emission, which facilitates the automatic sustainability assessments of buildings.

A framework for utilizing BIM for sustainable building design is proposed by Zhang et. al., 2014). In this study a rule-based system is proposed for checking building model against the building codes and provide instructions on sustainable design practice. Rules are developed as per the LEED standards and Revit is as used as BIM authoring tool. A plug-in is developed to assess the building as per LEED. Another study conducted by Jalaei and Jarade (2014), proposed BIM for assessing sustainability of Buildings. Anton and Diaz (2014) studied the integration of Life Cycle Assessment in the BIM environment highlighted a missing link between the Environmental Information (such as Embodied energy and Carbon) with the BIM objects.

The lack of integration between environmental analyses and the main BIM simulation processes may lead to inefficient afterward modification to meet certain environmental criteria. Another feature which is common to all environmental analyses system is that they demand large amounts of design and construction data in different formats, and the accuracy of analysis depends on the quality and availability of data from all phases of the project (Alwan et al., 2015).

3. MOTIVATION

A lot of research has been conducted on evaluating the building design based on embodied and operational energy consumption as well as carbon emissions but such studies are case-based i.e. the outcome is usually a static report that show the statistics of that particular project. The data entered and processed are lost due to a disconnect between the different applications used in the process. The very nature of this process is iterative but due to the limitation of the existing frameworks slight changes cannot be incorporated and needs a complete cycle of steps performed on it before any meaningful results are obtained. Interoperability and reusability of life cycle sustainability data has been the prime focus of this research paper.

4. PROPOSED FRAMEWORK

Figure 1 below shows the framework for Lifecycle Evaluation of Building Sustainability. It has four steps namely Data Collection, Data Mapping, Data Analysis and Alternatives Provision.

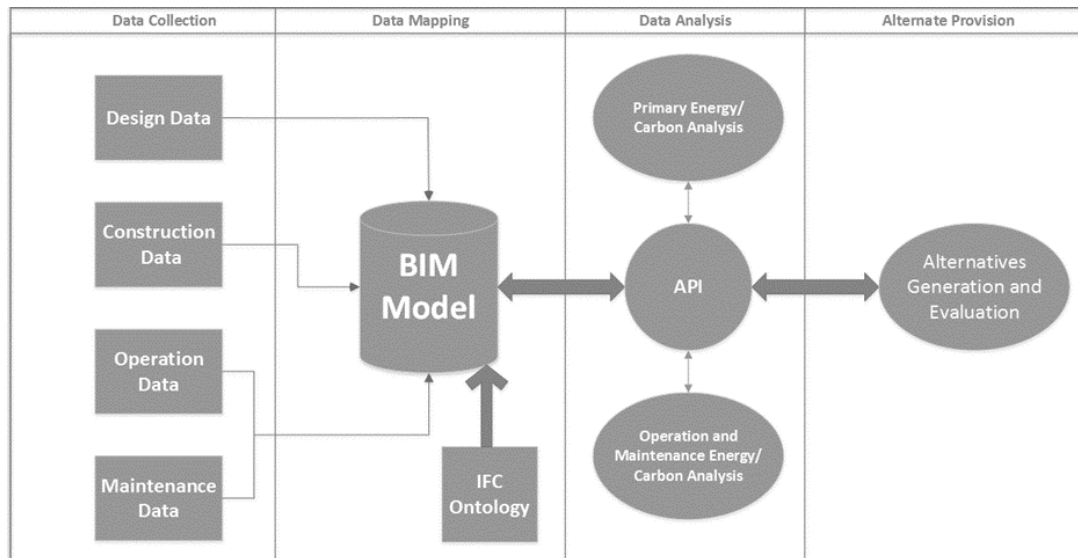

Figure 1: Framework for lifecycle evaluation of building sustainability

Data Collection: In order to evaluate the primary energy consumption all the direct and indirect processes associated with building over its lifecycle are to be quantified which includes all activities from material extraction, manufacturing, transportation, construction, refurbishment and replacement, and disposal activities at the end of **the building's life. The data collected can be further divided into two categories.** First category includes data that is associated to design and other category includes temporal data collected during the construction and operation stage. The design data encompasses the geometry of the buildings, properties of the building elements, location and orientation of the building, the embodied energy of the construction materials (The values of the embodied energy can be linked to any suitable database that can holistically estimate the impact such as Inventory of Carbon and Energy (ICE) (Hammond et al., 2008)). The temporal data that needs to be collected is the amount of energy consumed during construction (both direct and indirect), wastage of building materials, energy consumed in transportation of material from plant to site, operational energy consumed during the operation phase and the energy consumed on maintenance over the life span of the building. The operation energy can be divided into heating/cooling load, building services and electrical appliances. A real-time location system will be incorporated to make the data location wise intelligent to provide basis for break down analysis. The operation and maintenance energy will also be estimated through whole building energy simulations with standard occupancy schedules and considering standard maintenance schedules. BIM will act as a platform to integrate all the data which will be discussed in the next phase.

Data Mapping: A typical BIM authoring tool has provisions for assigning geometry and location data as well as element properties but does not provide content space for embodied energy of materials, construction energy, material transportation energy, operation energy and maintenance energy. As mentioned previously in the data collection step that this data is of two types thus require different types of content space. First type includes data available during the design stage; this can be further divided into single value data such as Embodied Energy (MJ/Kg) and the other type includes expected occupancy schedules and estimated maintenance schedules. The second type i.e. temporal data includes wastage of building materials, construction energy, energy consumed in transportation of material from plant to site, operational energy consumed during the operation phase and the energy consumed on maintenance over the life span of the building. To make all this data interoperable a standard data exchange protocol needs to be set up. IFC acts as a standard data exchange protocol for construction data but is limited to the conventional BIM entities so it needs to be extended as explained in the next section.

IFC Ontology: An IFC export from any BIM authoring tool generally exports standard entities present within the model and does not export any additional attributes that may be input into the model. Since some additional parameters are input in the last step, there is a need to establish a relationship between standard project entities and these newly added parameters. IFC Ontology will be developed by using any suitable environment to map this data in the IFC format which will make this data interoperable among different IFC enabled software suits with a variety of applications.

Data Analysis: Whole Building Energy Simulation will be based on LEED and will account for Minimum and Optimized energy performance credits. It will take into consideration the building geometry, location and orientation as well as properties of the building elements to perform solar gain, total energy gain, and Lighting Analysis. Occupancy schedules will help to simulate the heating/ cooling loads. Life Cycle Energy analysis (based on MR credit: Building life-cycle impact reduction) will take into account the embodied energy, construction energy, material wastage and maintenance schedules to calculate the whole life cycle energy. The actual operational energy will be calculated by sensor data which will be based on Building Level Energy metering credits. A comparison will be made between the simulated loads and actual values.

Alternatives Provision: Provision of alternatives and their evaluation is the prime goal of life cycle evaluation. An API is developed to link up all the data provided for a single alternative and enable the designer to change the material configuration of the model and compare with the base model in real time. A report will be generated based on the selection of material configuration describing the life cycle impact of different alternatives and highlighting the most effective solutions.

5. CONCLUSION

Today's construction projects need extensive simulations with regards to sustainability aspects. This framework is intended to cater two very critical needs of these projects. First is incorporating data for various alternatives as well as their simulated reflections on the sustainability aspects in a single model database. Second is recording and mapping of the actual consumption patterns as well as enabling comparison with the simulated values to record the impact of sustainable measures taken during the design, construction and operation phase of the building project. The most important advantage of this framework is that it allows all its activity within the main BIM authoring tool thereby saving time and effort to generate and compare alternatives in addition to accommodating changes in the building geometry.

REFERENCES

- [1] Adem, Atmaca, 2016. Life cycle assessment and cost analysis of residential buildings in south east of Turkey: part 1—review and methodology. *Int J Life Cycle Assess* DOI 10.1007/s11367-016-1050-8
- [2] Alwan, Z., Greenwood, D. & Gledson, B., 2015. Rapid LEED evaluation performed with BIM based sustainability analysis on a virtual construction project. *Construction Innovation*. 15(2). pp. 134-150.
- [3] Anton, Laura Alvarez and Diaz, Jaoquin, 2014. Integration of life cycle assessment in a BIM environment. *Procedia Engineering* 85: 26 – 32.
- [4] Asif, M., Muneer, T., and R. Kelley, 2007. Life cycle assessment: A case study of adwelling home in Scotland, *Building and Environment* 42(3), pp. 1391 –1394, doi:10.1016/j.buildenv.2005.11.023
- [5] Azhar, S., Khalfan, M., & Maqsood, T, 2012. Building information modelling (BIM): now and beyond. *Australasian Journal of Construction Economics and Building*, 12(4), 15-28
- [6] **Bynum, P., Issa, R. R. A., and Olbina, S., 2013. "Building Information Modeling in Support of Sustainable Design and Construction", *J. Constr. Eng. Manage.* 2013.139:24-34.**
- [7] Crawford RH, 2008. Validation of a hybrid life-cycle inventory analysis method. *J Environ Manag* 88:496–506
- [8] Devuyt D., 2000. Linking impact assessment and sustainable development at the local level: the introduction of sustainability assessment systems. *Sustainable Development* 8:67–78.
- [9] EIA., 2010. Energy consumption by sector. *Annual Energy Outlook 2010*, DOE/EIA-0383(2012)/June 2010, U.S. Energy Information Administration
- [10] Hammond, G., Jones, C., Lowrie, F., & Tse, P. (2008). *Inventory of carbon & Energy: ICE*. Bath: Sustainable Energy Research Team, Department of Mechanical Engineering, University of Bath.
- [11] Hellstrom T., 2007. Dimensions of environmentally sustainable innovation: the structure of eco-innovation concepts. *Sustainable Development* 15(3): 148–159. DOI: 10.1002/sd.30
- [12] Intergovernmental Panel on Climate Change (IPCC), 2007. *Climate change 2007: Synthesis report*. IPCC 4th Assessment Report.
- [13] Jalaei, Farzad and Jrade, Ahmad, 2014. An Automated BIM Model to Conceptually Design, Analyze, Simulate, and Assess Sustainable Building Projects *Journal of Construction Engineering* Volume 2014, Article ID 672896,

- [14] Kolokotsa, D., D. Rovas, E. Kosmatopoulos, K. Kalaitzakis, 2011. A roadmap towards intelligent net zero- and positive-energy buildings, *Solar Energy* 85 (2011) 3067–3084
- [15] Praseeda, K.I, Venkatarama, B.V. and M. Mani, 2016. Embodied and operational energy of urban residential buildings in India. *Energy and Buildings* 110 (2016) 211–219
- [16] Ramesh, T., R. Prakash, K.K. Shukla, 2010. Life cycle energy analysis of buildings: an overview, *Energy Build.* 42 (2010) 1592–1600
- [17] Sartori I. and Hestnes A.G., 2007. Energy use in the life cycle of conventional and low energy buildings: a review article, *Energy Build.* 39 (2007) 249–257.
- [18] Steurer R, Hametner M., 2011. Objectives and indicators in sustainable development strategies: similarities and variances across Europe. *Sustainable Development* in press. DOI: 10.1002/sd.501
- [19] U. E. P. Agency, Green building — basic information, 2011. <http://www.epa.gov/greenbuilding/pubs/about.htm2011>.
- [20] Zhang, C., Chen, J., Sun, X. and Hammad, A., 2014. Lifecycle Evaluation of Building Sustainability using BIM and RTLS, in *Proceeding of the 2014 Winter Simulation Conference*, Savannah, GA, US.

Session 5.11: Processes, Design, Tool and Methodologies in SBE (3)

Assessing Sustainable Urban Densification Using Geographic Information Systems

Natasha CABRERA-JARA^a, Daniel ORELLANA^b, M. Augusta HERMIDA^c

^a Universidad de Cuenca, Ecuador, natasha.cabrera@ucuenca.edu.ec

^b Universidad de Cuenca, Ecuador, daniel.orellana@ucuenca.edu.ec

^c Universidad de Cuenca, Ecuador, augusta.hermida@ucuenca.edu.ec

ABSTRACT

Facing the expansive growth of cities and the wasteful consumption of resources, cities must be measured in its immense complexity, and its parts and layers must be observed so as to assess its ability to support such pressures. Cities should look at themselves and define how far away they are from a sustainable model, which means a greater sense of community, mixed uses, higher densities, better public space, higher quality of life, less energy consume, among others. This paper presents a toolbox for assessing sustainable urban densification using Geographic Information Systems (GIS). The toolbox uses spatial analysis and cartographic representation techniques to characterize and analyze the spatial distribution of a set of indicators using an orthogonal grid. The toolbox includes the automatic computation of 20 indicators of urban sustainability organized in four themes: compactness, diversity of uses, urban green, and socio-spatial integration. It also computes a Sustainable Urban Densification Index for each cell of the grid allowing to explore and discover spatial patterns of urban sustainability. The toolbox includes options for parameterization of both the indicators and the index, offering flexibility for adapting it to different realities and needs. These features allows the application of the toolbox for a wide variety of studies, such as comparative analysis of different cities or urban fabrics, monitoring of performance of urban policies, assessment of the impact of urban densification and urban sprawl, and future scenario evaluation. The toolbox is publicly available to researchers, practitioners, urban officials, technicians and students interested in urban sustainability.

Keywords: urban indicators, spatial analysis, sustainable neighborhood

1. INTRODUCTION

"Measure what is measurable, and make measurable what is not so"

Galileo Galilei

The city is, among other definitions, a spatial and relational phenomenon, the most comprehensive work of human activity (Whitman cited in Chueca, 2011, p.19). It is a scene of life, so that understanding it means approaching its inhabitants. Therefore, the desire to study the city represents an act that involves tackling its immense complexity, observing its parts and abstracting the different layers that constitute it. La ciudad es esto (Hermida et al., 2015a) proposes a tool for measuring and comparing urban sustainability taking as a main issue housing densification and intensification of uses. Besides, this tool considers the different variables that affect urban life and mobility, green infrastructure and social cohesion (Hermida et al., 2015b, p. 29). In fact, compact city is assumed as a sustainable urban model and densification as a key variable for analysis.

1.1 The abstraction of the city

Due to the expansive growth of cities and their wasteful consumption of resources it is necessary to measure their ability to face these pressures (Cabrera *et al.*, 2015). The dispersed city has failed as urban model (Arbury, 2005) and its effects require a change of course. For this reason cities should look at themselves to assess how much they have deviated from the compact model, which defends cities with a greater sense of community, mixed and walkable uses, higher densities, more space for its inhabitants and less for the car (Lehmann, 2010). It is necessary to measure how the city resembles the compact and diverse model and thus demonstrates urban sustainability (Rueda, 2008). With this in view techniques of spatial representation GIS (geographic information systems), that

integrate mapping and information resources allowing the organization, storage, analysis and modeling of large amounts of geo-referenced data (Olaya, 2011) are used. Drawing on these data it is possible to create indicators represented in layers of geographic information that may overlap to measure urban sustainability addressing spatial heterogeneity.

While GIS tools are useful and maps are essential to navigate and locate boundaries and landmarks, some representations are inefficient to visualize and communicate information as the visual impact of data displayed in a spatial way is influenced by the way space is divided (London Data Store, 2015). Irregular divisions of cartographic maps carry the "modifiable area unit problem" MAUP (Openshaw, 1981) due to the variability of spatial boundaries and the lack of a regular unit area which present spatial and statistical calculations (densities, proportions, etc.). To reduce the visual impact and to maintain possibilities of comparative analysis a regular grid is chosen. This divides the territory analyzed in uniform cells (Figure 1). The grid is dimensioned according to the average area of a city block and its cells contain at least 4 blocks. In the case of Cuenca-Ecuador, the cells are sized 200m x 200m (Hermida *et al.*, 2015a, p. 35).

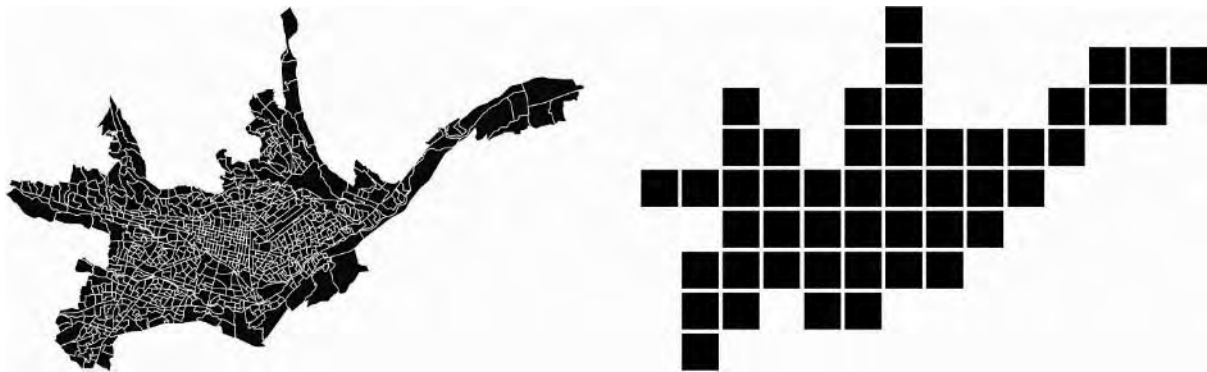

Figure 1: Division of the urban fabric through a square grid

2. INDICATORS SYSTEM

The construction of this system uses at a starting point 52 indicators extracted from the indicator system for large and medium-sized cities (Agencia de Ecología Urbana de Barcelona and Red de Redes de Desarrollo Local Sostenible, 2009), and the environmental sustainability indicators plan of Seville (Rueda, 2008). From these studies 20 indicators are proposed, which are adapted to the city of Cuenca and organized into four axes: 1) compactness, 2) diversity of uses, 3) urban green, and 4) socio-spatial integration (Table 1) (Hermida *et al.*, 2015a, p. 36). The criteria for the selection and development of these indicators are based primarily on relevance, cost of production and information value. In this sense the existence of updated cadastral data to reduce the cost in obtaining information becomes fundamental.

Code	Name	Description
Axis 1: Compactness		
01	Urban housing density	Housing net density per hectare. It evidences consumption of residential land.
02	Inhabitants density	Inhabitants net density per hectare. It is complementary to the previous.
03	Absolute compactness	Building intensity, equivalent to building volume on a given surface.
04	Percentage of pedestrian road	Percentage of public road intended foot citizen.
05	Alternative transportation proximity	Percentage of population with access to three or more modes of transport other than the private car.
06	Pedestrian accessibility	Degree of accessibility on foot for the public road.
07	Percentage of closed condominium	Percentage of area destined to gated communities.
08	Empty lots area	Percentage of unused land or buildings on the block.

Axis 2: Diversity of uses		
09	Urban complexity	Diversity and frequency of uses. It evidences the mixture of activities.
10	Ratio of activity and residence	Ratio of commerce activities and the amount of housing.
11	Daily commerce activities	Simultaneous coverage of day-to-day commerce activities.
12	Spatial and functional continuity of corridor	Street interaction in relation to percentage of pedestrian road and complexity of uses.
Axis 3: Urban green		
13	Permeability of public land	Degree of permeability public land.
14	Green area per capita	Ratio of public green space and the number of inhabitants.
15	Volume of green in public space	Percentage of volume street occupied by vegetation.
16	Proximity to the nearest green area	Closeness of the population walk to the nearest green area.
17	Simultaneous proximity to three types of green areas	Closeness of the population walk to three types of green areas.
Axis 4: Socio-spatial integration		
18	Provision of infrastructure	Simultaneous coverage of different types of infrastructure.
19	Percentage of households in quartile 1	Fraction of households cataloged in quartile 1.
20	Socio-spatial segregation	Percentage of low-income population, measured in quartiles.

Table 1: Indicators system proposed

2.1 A synthetic index of sustainability

After the building of these 20 urban sustainability indicators, the Sustainable Urban Densification Index is proposed by obtaining four sub-indexes (Table 2). These in turn are built from 9 of the 20 indicators.

Sub-index	Indicator	Optimum value
Housing and diversity of uses	Urban housing density	>40 dwellings/hectare
	Urban complexity	>4
Pedestrian accessibility	Pedestrian accessibility	>75%
	Alternative transportation proximity	100%
Urban green	Green area per capita	>15m ² /inhabitant
	Volume of green in public space	>30%
	Simultaneous proximity to three types of green areas	100%
Socio-spatial integration	Percentage of households in quartile 1	25%
	Socio-spatial segregation	0,76-1,25

Table 2: Sub-indexes for calculating the synthetic index

The Sustainable Urban Densification Index represents the relative valuation of sustainability in terms of density and composition through the four sub-indexes, allowing a global reading and facilitating comparisons. Additionally, the results are normalized to values from zero to one, with zero being the lowest and 1 the highest value of sustainability (Hermida *et al.*, 2015a, p. 123). The index and the values of these indicators are represented through the regular grid of 200x200mm (Figure 2).

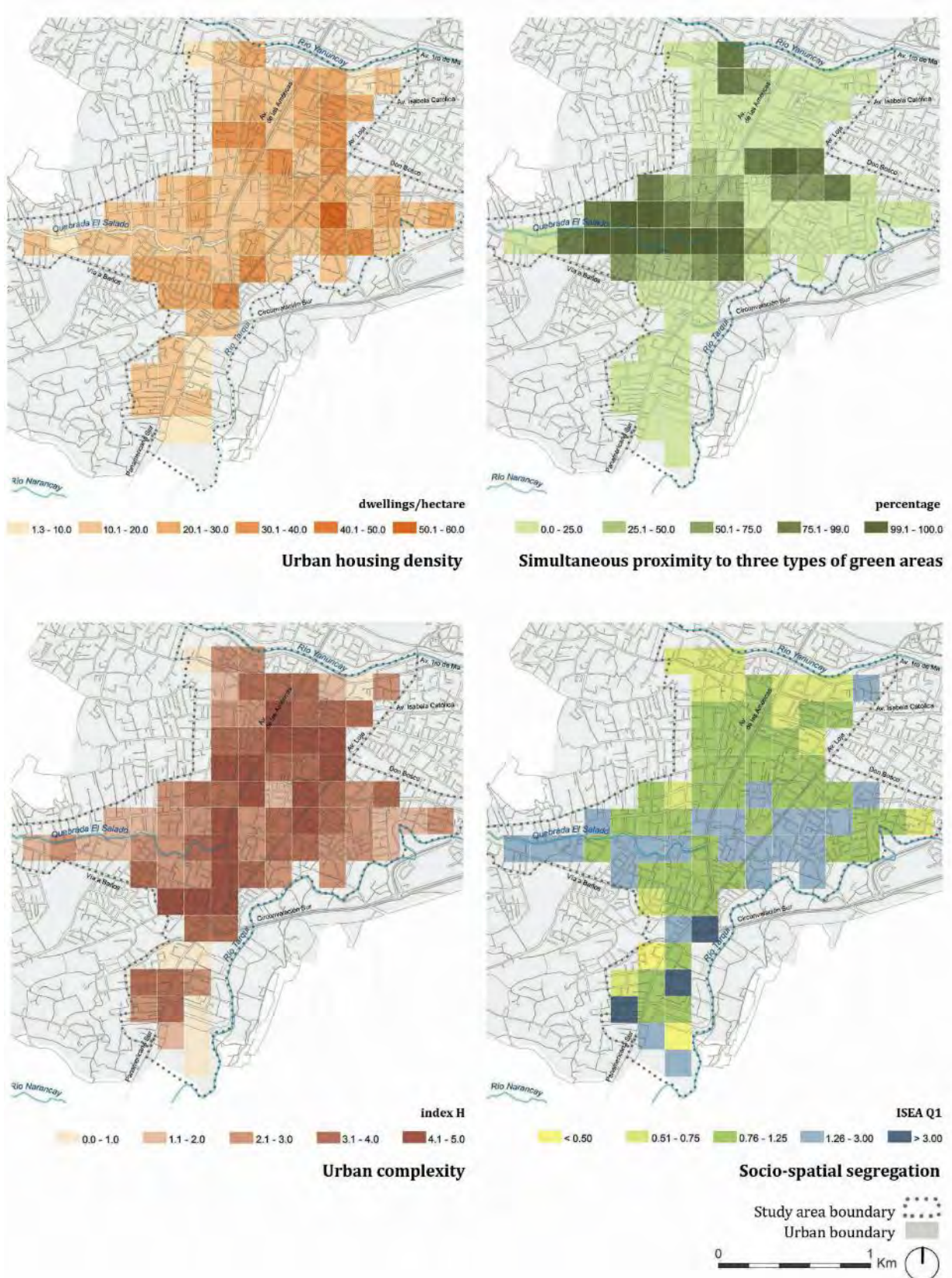

Figure 2: Spatial representation of indicators

3. AUTOMATION

The calculation of the indicators and the index is automated within GIS, using process flows that take data entry, stored inside geographic layers and tables, perform spatial aggregation operations, overlay, execute statistical calculation and produce results which are referenced to each grid cell (Figure 3). A tool for calculating each

indicator and a tool for calculating the Sustainable Urban Densification Index using ArcGIS 10.3 has been implemented. These tools are clustered in a "Toolbox" and can be executed through a friendly graphical user interface or through a command line that allows greater flexibility.

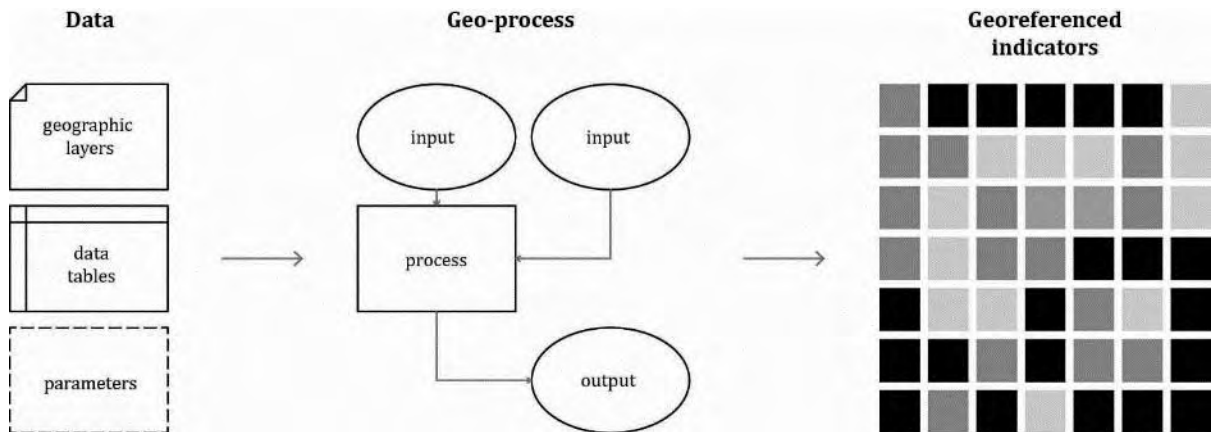

Figure 3: Schematic of process automation

To use the tools, a data structure is required so the names and locations of the input files should be standardized according to a table in the Toolbox. Table 3 shows an example of the input data required for the calculation of an indicator.

Indicator	List of data needed with the required name	Description
Percentage of households in quartile 1	Malla_200x200.shp	Shape with the grid of 200x200m. Each cell must be assigned with a code.
	Manzanas_Condiciones_Vida.shp	Shape with blocks, whose attribute table contains the number of total households and the number of them in quartile 1, considering four elements: construction quality, access to public services, education and health services affiliation (Orellana and Osorio, 2014).

Table 3: Required information for calculating the indicator "Percentage of households in quartile 1"

The files generated by each tool are automatically placed in a folder output structure depending on the indicator or index, which includes: a) the original files of each indicator; b) the intermediate files generated by geo-processes; and c) the final file that corresponds to the spatial representation of the values obtained for each indicator (Figure 4).

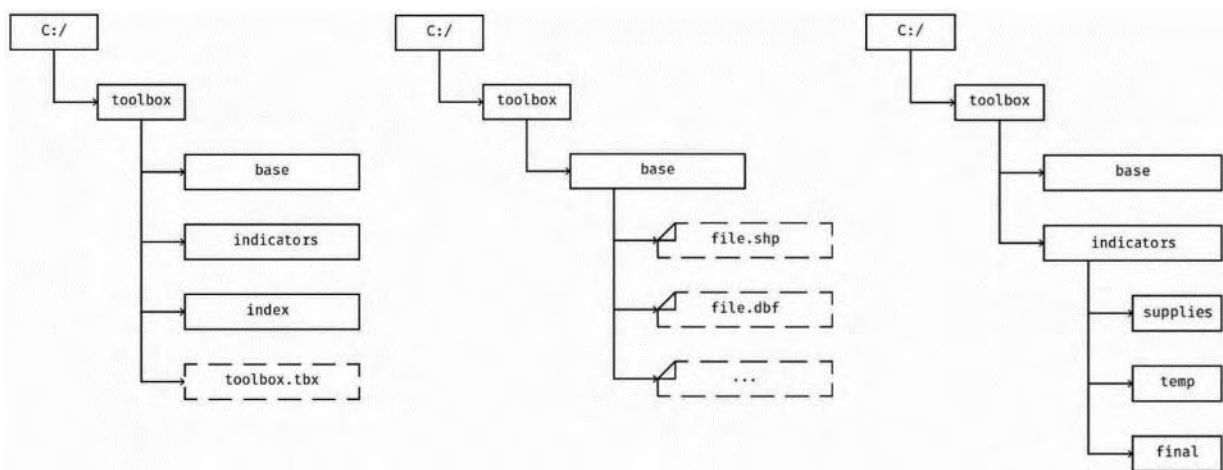

Figure 4: Organization of the information required for automation

To calculate the index, results of 9 indicators are required; therefore it is necessary to run the tools to calculate each indicator first. In order to facilitate the use of the Toolbox, each automation process is accompanied by a management protocol -a detailed explanation of each indicator and suggested representation ranges-.

4. CONCLUSIONS

This automation process by using geographic information systems, aims to facilitate the evaluation of urban sustainability in terms of densification in different cities, using the same methodology, which allows comparison between different cities or different areas within the same city. The most important requirement of the proposed approach is the availability of the necessary input data, so the indicators intend -as far as possible- to use secondary sources available in local government, to avoid obtaining data in field. Therefore the result is partly dependent on the quality of information available, which is highly variable for Latin American cases.

The proposed Toolbox has been developed in such a way that allows the parameterization of the calculations and representation ranges, enabling the adaptation of the optimum values for different assessment approaches. This feature makes it a useful tool for a well informed and evidence based debate about different ways of assessing the parameters that affect sustainability, especially in terms of densification.

The Toolbox, a set of demonstration data, a tutorial and research documents are publicly available to all individuals and institutions. The next step in this line of work consists of the implementation of this tool in open source software as an effort to democratize access and use of information and public debate on the decision-making around our urban spaces.

REFERENCES

- [1] Agencia de Ecología Urbana de Barcelona and Red de Redes de Desarrollo Local Sostenible, 2009. Sistema de indicadores y condicionantes para ciudades grandes y medianas. Gobierno de España, Barcelona.
- [2] Arbury, J., 2005. From urban sprawl to compact city. An analysis of urban growth management in Auckland. Thesis. University of Auckland.
- [3] Cabrera, N., Orellana, D., Hermida, A. and Osorio, P., 2015. Assessing the sustainability of urban density. Indicators in the case of Cuenca (Ecuador). *Bitácora Urbano Territorial*, 25(2), 21-34.
- [4] Chueca, F., 2011. Breve historia del urbanismo. Alianza, Madrid.
- [5] Hermida, A., Orellana, D., Cabrera, N., Osorio, P. and Calle, C., 2015a. La ciudad es esto. Medición y representación espacial para ciudades compactas sustentables. Universidad de Cuenca, Cuenca.
- [6] Hermida, A., Hermida, C., Cabrera, N. and Calle, C., 2015b. La densidad urbana como variable de análisis de la ciudad. El caso de Cuenca, Ecuador. *Revista EURE*, 41(124), 25-44.
- [7] Lehmann, S., 2010. Green Urbanism: Formulating a Series of Holistic Principles. *SAPIENS*, 3(2) [online]. Retrieved from: <https://sapiens.revues.org/1057> [Retrieved on 14 May 2016].
- [8] London Data Store, 2015. London Squared Map. After the flood [online]. Retrieved from: <http://aftertheflood.co/projects/london-squared-map> [Retrieved on 10 May 2016].
- [9] Olaya, V., 2011. Sistemas de Información Geográfica [online]. Retrieved from: ftp://ftp.ehu.es/cidira/profs/iipbaiza/Libro_SIG.pdf [Retrieved on 6 May 2016].
- [10] Openshaw, S. 1981. The modifiable area unit problem. *Quantitative geography a British view*, 35, 60-70.
- [11] Orellana, D. and Osorio, P., 2014. Segregación socio-espacial urbana en Cuenca, Ecuador. *Analitika, Revista de Análisis Estadístico*, 8(2), 27-38.
- [12] Rueda, S. (ed.) 2008. Plan Especial de Indicadores de Sustentabilidad Ambiental de la Actividad Urbanística de Sevilla [online]. Retrieved from: <http://www.upv.es/contenidos/CAMUNISO/info/U0681581.pdf> [Retrieved on 20 April 2016].

Traffic Quality Index to Intersections Considering Fuel Efficiency

Fabianne Miranda AGUIAR^a, Marta Monteiro da Costa CRUZ^b, Gregório Coelho de MORAIS NETO^c, Adelmo Inacio BERTOLDE^d

^a Federal University of Espírito Santo, Brazil, fabianneaguiar@gmail.com

^b Federal University of Espírito Santo, Brazil, marta.cruz@ufes.br

^c Federal University of Espírito Santo, Brazil, gregorioufes@msn.com

^d Federal University of Espírito Santo, Brazil, Adelmo.ufes@gmail.com

ABSTRACT

The environmental conditions of urban areas are directly affected by the operation in their road intersections and by the amount of vehicles and its dispersion throughout the day. To measure these conditions, the present study aims to propose a Traffic Quality Index (TQI) applicable to urban intersections and for comparing traffic performance, bringing a comprehensive methodology about the parameters involved in intersection quality. To prepare the TQI, it was used the Delphi methodology, through opinion of traffic experts. The results supported the selection of a group containing five parameters, namely: delay per vehicle; stops per vehicle; average speed; fuel efficiency and queue size. The formulation of the TQI has been established based on the values of parameters scored and their respective weights and evaluated for use of sum or product. Aiming at its validation, the TQI was applied to four intersections (two of them non-signalized and the other two signalized), simulated by Synchro Studio 9 software, and the results were compared with those obtained by the HCM (Highway Capacity Manual) and ICU (Intersection Capacity Utilization). It was found that the TQI product is more sensitive to roads changes and is a tool to assist the development and evaluation of urban road design and traffic planning, and that its use is complementary to the HCM and ICU methodologies.

Keywords: policy and regulation, traffic quality Index, traffic simulation.

1. INTRODUCTION

The environmental conditions of urban spaces for vehicles are directly affected by the operation at their intersections, the number of vehicles traveling on the road network and its dispersion throughout the day. With the growth of cities and the consequent increase in the amount of circulating vehicles, public agencies responsible for the planning of cities have required impact studies road of new projects. These studies are aimed, among other things, assess the current quality of road intersections and estimate the future quality in a pre-established horizon.

There are several methodologies that can be used in studies of intersections, such as the Webster Method (Webster and Cobbe, 1966) and Percentile Method (Trafficware LLC, 2014). The most widespread is the Highway Capacity Manual - HCM (Transportation Research Board, 2010). The HCM has the criterion for evaluating the identification of delay per vehicle intersection or approach, measured in seconds per vehicle. Another very common methodology is Intersection Capacity Utilization - ICU (Husch and Albeck, 2003), which compares the volume of active traffic at the intersection with a traffic capacity.

However, the available methodologies are not yet able to predict the quality of traffic through a broader approach that considers a set of more comprehensive variables related to the quality and fuel efficiency, like delay per vehicle and capacity of the intersection, as mentioned, and number of stops, vehicle emissions, among others. In this sense, this paper proposes a Traffic Quality Index - TQI, whose determination was based through transport specialists opinion and quality indicator variables that could be measured by applying traffic simulation.

The formulation of TQI was based on procedure adopted by studies using the Delphi Methodology (Dalkey and Helmer, 1963) to obtain the opinion of experts to identify variables related to quality indexes. The final selection of the parameters was the result from consensus opinions obtained in feedback round.

The establishment of a Traffic Quality Index is of great importance for road impact assessments and can support decisions on physical and operational changes on urban roads. In this context this study is innovative because it provides a more comprehensive approach to assessing the quality of traffic that presented by the most known methodologies available.

2. TRAFFIC QUALITY INDEX DEFINITION

In this section the details of the Traffic Quality Index (TQI) definition are presented, such as the steps used, its formulation, questionnaire application, scoring criteria, traffic simulation and sensitivity analysis

2.1 Steps considered for the TQI

The TQI setting method is divided into sequential steps, being necessary, firstly, the formulation of the index, followed by traffic simulation, sensitivity analysis and validation. It is important to note that in the simulation stage were modeled intersections in two versions to enable sensitivity analysis. The version "A" shows the simulation of the real traffic volumes collected, whereas version "B" shows the simulation of half traffic volumes.

2.2 Election of study case

Following Delphi methodology (Dalkey and Helmer, 1963), two questionnaires were applied to experts who works with traffic planning or operation, one in each stage of the research. In the first stage, the Questionnaire 1 had variables related to quality indicators and participant should choose which would be included in the general equation and establish a weight of 0 to 100. Nine variables that indicates the quality of movement or environment and that can be obtained by traffic simulation were evaluated. They are: delay per vehicle (s); stop delay per vehicle (s); stops per vehicle (stops/veh); average speed (km/h); fuel efficiency (km/l); vehicles with denied entry to the road network (veh); maximum queue lengths (m); average queue length (m) and 95th percentile queue length (m).

Once these variables are measured on different scales and units, it was also necessary to establish, in the first stage, scoring criteria able to parameterize the values for variables in a predetermined range.

In the next step, the second questionnaire was applied showing the statistics based on the previous questionnaire answers. This way the participants could re-evaluate their answers based on the previous opinion of the group and, thus, allow the convergence of the results.

After completing the steps of selection of variables, assigning weights and scoring criteria, was made a sensitivity analysis of the index using the forms of sum and product operators, as the following equations (Equation 1 and Equation 2). These formulations represent two forms of aggregation of subindices commonly used to obtain a final index (Abbasi and Abbasi, 2012).

$$TQI_S = \sum_{i=1}^N W_i Q_i$$

Equation 1

$$TQI_P = \prod_{i=1}^N Q_i^{W_i}$$

Equation 2

where, TQI_S = Traffic Quality Index – sum formulation; TQI_P = Traffic Quality Index – product formulation; W = weight assigned to each variable; Q = score of the intersection for each selected variable, according scoring criteria developed; i = each variable included in the calculation; N = total number of variables included in the calculation.

2.3 Delphi questionnaire application

Questionnaire 1 was sent to a group of about 40 experts obtaining 23 valid responses, of which 18 have continued to research by completing the questionnaire 2. There is no consensus in the literature on the number of participants used in Delphi studies (Hsu and Sandford, 2007), however most of them uses between 15 and 20 responders (Ludwig, 1997).

The profile of respondents is made up of independent professionals, consultants, civil servants and academics who work with urban and transportation planning and traffic control in the Brazilian states of Espírito Santo, Rio de

Janeiro, Ceará, São Paulo, Rio Grande do Sul and Brasília. Table 1 shows the results obtained regarding the inclusion of variables.

The results show that the variable 9 (95th percentile queue length) was not a relevant factor for calculating the TOI, according to the opinion of the respondents.

N°	Variable	Measurement	Answers (%)		
			Include	Not to include	Undecided
1	Delay per vehicle	Seconds	94.4	5.6	0.0
2	Stop delay per vehicle	Seconds	83.3	16.7	0.0
3	Stops per vehicle	Stops/veh	72.2	22.2	5.6
4	Average speed	Km/hour	83.3	16.7	0.0
5	Fuel efficiency	Km/litre	83.3	16.7	0.0
6	Vehicles with denied entry to the road network	Units	66.7	33.3	0.0
7	Maximum queue length	Meter	83.3	16.7	0.0
8	Average queue length	Meter	100.0	0.0	0.0
9	95th percentile queue length	Meter	44.4	33.3	22.2

PS: Highlighted the highest values
Table 1: Results obtained in the Questionnaire 2 – Variables inclusion

The final responses were evaluate for inclusion rate, which was calculated for insertion into the TOI formulation to include divergent views of the respondents. Its value is equivalent to the percentage of inclusions to the total of valid responses, considering only the results "include" and "not to include". Regarding the weights of the variables, it took the median of the results in order to avoid the influence of extreme points. It arbitrated that the sum of all weights should result in one (1), thereby yielding the final weight used at the general TOI equation. Table 2 shows the results obtained. Variables with inclusion rate lesser than 70% were excluded (variables 6 and 9). Variables 2 and 7 were exclude to avoid redundancy since they have lower inclusion rates than the variables 1 and 8, respectively. Variable 4 was exclude because the delay is dependent on vehicle average speed, among other factors.

N°	Variables	Resposes		Incl. rate x Weigth	Final weigth	
		Inclusion rate	Weigth			
1	Delay per vehicle	0.9444	7	6.61	0.2778	
2	Stop delay per vehicle	0.8333	8			
3	Stops per vehicle	0.7647	7	5.35	0.2250	
4	Average speed	0.8333	5			
5	Fuel efficiency	0.8333	7	5.83	0.2450	
6	Vehicles with denied entry to the road network	0.6667	5			
7	Maximum queue length	0.8333	8			
8	Average queue length	1.0000	6	6.00	0.2522	
9	95th percentile queue length	0.5714	5			
				Sum	23.79	1.0000

Table 2: Inclusion rate, median and final weight of the variables evaluated in the questionnaires

2.4 Scoring criteria development

The selected variables were scored according to the classification given by the traffic simulator (Husch and Albeck, 2003), **except "queue size" that was given by expert opinion** because the software does not classify this variable. Thus, graphics were produced by correlation between the results ranges presented by the software to "delay per vehicle", "stops per vehicle" and "fuel efficiency" and standardized scale ranging from 0 to 10. These are graphs presented in Figure 1. It was used polynomial correlation because its greater adherence to the collected data.

The development of scoring criteria for the variable "queue" dismissed the outliers. A correlation was made between the valid responses from the questionnaires and the standardized scale. Note that the sensitivity of queue size decreases as increase its size.

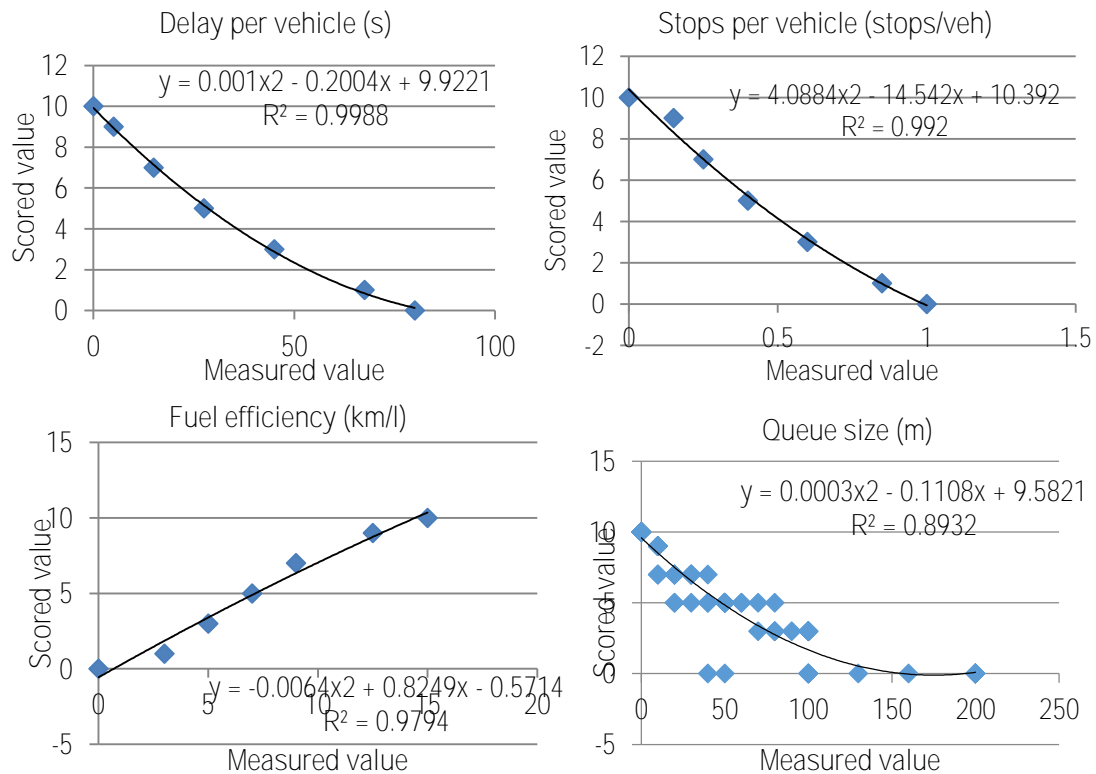

Figure 1: Score criteria to "delay per vehicle", "stops per vehicle" and "fuel efficiency" variables

Thus, the equations that defines the traffic quality variables for TQI are represent by the following linear regression equations.

$$A = f(x) = 0.001x_a^2 - 0.2004x_a + 9.9221$$

Equation 3

$$P = f(x) = 4.0884x_p^2 - 14.542x_p + 10.392$$

Equation 4

$$E = f(x) = -0.0064x_e^2 + 0.8249x_e - 0.5714$$

Equation 5

$$F = f(x) = 0.0003x_f^2 - 0.1108x_f + 9.5821$$

Equation 6

where A = Scored delay per vehicle (s); x_a = Measured delay per vehicle (s); P = Scored stops per vehicle (stops/ veh); x_p = Measured stops per vehicle (stops/ veh); E = Scored fuel efficiency (km/ l); x_e = Measured fuel efficiency (km/ l); F = Scored queue length (m); x_f = Measured queue length (m).

2.5 Traffic simulation

Equations 3 to 6 were applied in the quality evaluation of four intersections that has different flows, geometries and operational logistics, considering the peak vehicle volumes and its reduce it by half, in order to analyze the sensitivity of the formulation to the same geometric and operational characteristics. These intersections were modeled and simulated using Synchro Studio 9 (Husch and Albeck, 2003) to enable the achievement of results of TQI variables and to compare it to the ratios obtained for HCM and ICU.

Currently, there are several softwares used for traffic simulation, such as Vissim, Rodel and Sidra, highlighting to SimTraffic, Corsin and Aimsun. Simtraffic from Synchro Studio 9 package was used in this research (Husch and Albeck, 2003), since that is the most used in the city under study and the database of the intersections was accessible. The information is initially created through mesoscopic analysis in order to be simulated through the microsimulation and animation traffic.

The intersections selected for the simulation was a roundabout (intersection 1), a unsignalized (controlled by signal "stop" sign - intersection 2) and two pretimed (one with 3 and another with 4 branches - intersections 3 and 4). To sensitivity analysis, for each intersection was simulated an "A" version, with peak hour volumes, and a "B" version, with the volumes of the first version reduced by half.

The traffic simulation was performed with the software standard configurations and the total simulation time was 10 minutes. The results for delay and ICU are shown in Table 3 with their respective levels of service. The qualitative scale used to quantify "delay" level of service is the one presented by the Transportation Research Board (2010), while to quantify the "ICU" level of service is the one presented by Invalid source specified..

Intersection	Delay (s)		ICU	
	Measurement	Level of service	Measurement	Level of service
1A	43.4	E	0.99	F
1B	7.5	A	0.55	A
2A	12.3	B	0.68	C
2B	3.5	A	0.41	A
3A	68.5	E	0.77	D
3B	19.1	B	0.44	A
4A	20.6	C	0.84	E
4B	10.8	B	0.47	A

Table 3: Simulation results – delay and ICU

The results measured for input variables from TQI are shown in Table 4 with the respective scored values resulting from the application of the Equations 3-6.

Intersection	A		P		E		F	
	ME	SC	ME	SC	ME	SC	ME	SC
1A	7.4	8.49	0.25	7.01	4.6	3.09	27.45	6.77
1B	2.6	9.41	0.27	6.76	8.4	5.91	10.85	8.42
2A	2.8	9.37	0.30	6.40	11.9	8.34	10.98	8.40
2B	1.5	9.62	0.21	7.52	13.2	9.20	5.63	8.97
3A	18.8	6.51	0.48	4.35	4.0	2.63	38.30	5.78
3B	14.3	7.26	0.50	4.14	5.7	3.92	18.96	7.59
4A	17.2	6.77	0.36	5.69	2.0	1.05	39.14	5.70
4B	14.3	7.26	0.50	4.14	5.7	3.92	27.15	6.80

Note: ME = measured value; PN = scored value.

Table 4. Results for measured and scored variables

Then the TQI formulations were obtained through application of the final weights of the variables shown in Table 2 to Equations 1 and 2, resulting in Equations 7-8 listed below.

$$TQI_S = 0.2778A + 0.2250P + 0.2450E + 0.2522F$$

Equation 7

$$TQI_P = A^{0.2778} \times P^{0.2250} \times E^{0.2450} \times F^{0.2522}$$

Equation 8

where TQI_S = Traffic Quality Index – sum formulation; TQI_P = Traffic Quality Index – product formulation; A = Scored delay per vehicle (s); P = Scored stops per vehicle (stops/ veh); E = Scored fuel efficiency (km/ l); F = Scored queue length (m).

2.6 Traffic simulation

The scored values were applied to Equations 7 and 8 to obtain the values of TQI_S and TQI_P , respectively, from intersections. These results are shown below in Table 5 by intersection groups (A = traffic volume obtained by counting, B = traffic volume obtained by counting halved).

Intersection	TQI_S			TQI_P		
	A	B	B-A	A	B	B-A
1	6.40	7.71	1.31	6.00	7.58	1.58
2	8.20	8.88	0.68	8.13	8.84	0.71
3	4.89	5.82	0.93	4.62	5.56	0.94
4	4.86	5.62	0.76	3.95	5.41	1.46

Table 5: Results for TQI_S e TQI_P

Observed up through the columns "B-A" that TQI presents best results with volume traffic reduction, even with sum or product formulation. Furthermore, it notes that the values of the TQI_P column "B-A" are larger than the corresponding TQI_S , indicating that the first index is more sensitive to changes attributed.

Table 6 presents a comparison values obtained for TQI with HCM and ICU, both indexes commonly used in traffic analysis. It is observed that TQI large variations not necessarily imply ICU and HCM large variations.

Intersestion	TQI_S	TQI_P	ICU	HCM
1A	6.40	6.00	F	E
1B	7.71	7.58	A	A
2A	8.20	8.13	C	B
2B	8.88	8.84	A	A
3A	4.89	4.62	D	E
3B	5.82	5.56	A	B
4A	4.86	3.95	F	F
4B	5.62	5.41	A	B

Table 6: Comparison values obtained for TQI with HCM and ICU

The values obtained by TQI did not follow those obtained by the ICU and the HCM. The simulation results show ICU values with classification F with TQI_S ranging between 4.86 and 6.40 and TQI_P ranging from 3.95 to 6:00, that represents a very high amplitude. This fact occurs as two intersections with the same capacity utilization may have different values for TQI input variables (delay per vehicle, stops per vehicle, fuel efficiency and queue length).

Another example is the existence of intersection with E classification to HCM showing its TQI_S ranging between 4.89 and 6.40 and its TQI_P between 4.62 and 6.00. The explanation for this is due to the fact that the TQI considers a wider range of variables in its composition to describe the quality of traffic. In addition, "delay per vehicle" values from TQI are obtained by simulation, while the HCM is calculated by its own methodology (Transportation Research Board, 2010).

3. CONCLUSIONS AND RECOMENDATIONS

The proposed index consists of indicators commonly observed in transport planning routine through computer simulation. This allows its use as a tool for assessing quality of traffic and can be applied as a criterion in the process of projects and transportation planning.

The design of the TQI based on the opinion of the expert group covered in this research indicates that the quality of the traffic of an urban intersection can be better analyzed if include in the formulation stops per vehicle, fuel efficiency and queue length, than just the delay per vehicle variable. Thus, although the ICU and HCM are used to analyze the quality of traffic, TQI covers better this concept because includes the other parameters, all of them directly related to the traffic quality.

About its formulation, the TQI application to the simulated intersections of this study showed greater susceptibility of the product equation to the traffic volume change effects, and it is recommended this as an assessment tool format.

It is important to state that the index should not be static, because as the computational simulation tools allow obtaining new variables with reliable results, the formulation of TQI should be reevaluated.

REFERENCES

- [1] Abbasi, T. and Abbasi, S. 2012. Water Quality Indices. Elsevier.
- [2] Dalkey, N. and Helmer, O. 1963. An Experimental Application of the Delphi Method to the Use of Experts. Management Science.
- [3] Hsu, C. C. and Sandford, B. 2007. The Delphi Technique: Making sense of consensus. Practical Assessment Research and Evaluation (Vol 12 No 10).
- [4] Husch, D. and Albeck, J. 2003. Trafficware Intersection Capacity Utilization. Albany, C. A., Estados Unidos: Trafficware Corporation.
- [5] Ludwing, B. 1997. Predicting the Future: Have You Considered Using the Delphi Methodology? Journal of Extension, 35. Retrieved from: <http://www.joe.org/joe/1997october/tt2.html>.
- [6] Trafficware LLC. 2014. Synchro Studio 9 User Guide.
- [7] Transportation Research Board. 2010. Highway Capacity Manual. Washington, D.C., Estados Unidos: National Research Council.
- [8] Webster, F. and Cobbe, B. 1966. Traffic Signals. Road Research Technical Paper nº 56.

A Simulation-Based Method to Assess 3D Urban Noise Environment in High-Density Cities

GUO Mengdi^a, HUANG Jianxiang^b

^a The University of Hong Kong, Hong Kong SAR, mguo@hku.hk

^b The University of Hong Kong, Hong Kong SAR, jxhuang@hku.hk

ABSTRACT

Urban noise is a major nuisance and health hazard in Hong Kong. Existing assessment methods are limited in their capacities; many do not apply to high-density cities. We developed a numerical model capable of assessing individual or household noise exposure in high-density cities. The purpose is to provide a tool for population-based health research and to inform urban planning decisions. The model is based on ray-tracing techniques. It takes into account geometric spreading, air absorption, material reflection coefficient and scattering properties of surfaces. The model is being evaluated in lab experiment and field measurement while the balance is held between accuracy and computing efficiency. Results showed that the new model allows us to assess noise exposure for individuals and households in high-density cities.

Keywords: design process, acoustic simulation, urban noise environment

1. INTRODUCTION

Noise is a major pollutant and health hazard in dense cities. Excessive exposure to noise disturbs concentration and sleep, violates intellectual activities, and engenders adverse health effects (Basner et al., 2014; Berglund et al., 2000). Residents of high-density cities are more likely to suffer from a variety of noise sources due to the complex spatial configuration (Lam et al., 2013). It is important to understand urban noise environment and investigating noise-related health impacts (van Kempen & Babisch, 2012). Hong Kong is an exemplar of high-density city for Asia and the rest of the developing world, where, road traffic is the dominant source of urban noise. Existing researches found road traffic noise associated with adverse health impacts (Lam et al., 2012; Lam & Chung, 2012; Environmental Protection Department, n.d.; GovHK, n.d.). Existing study (Tang & Tong, 2004; To et al., 2002; Mak et al., 2010) applied LimA, a commercial noise-mapping software capable of calculating noise propagation (Brüel & Kjær, n.d.; Law et al., 2011) in combination with Calculation of Road Traffic Noise (CRTN) algorithm (Brüel & Kjær, n.d.; Department of Transport Welsh Office, 1988, Lam et al., 2012), a U.K.-developed standard for road traffic noise.

Existing noise-mapping techniques are limited when applied to high-density cities. Most software is developed in European or North American context where building types and traffic profiles differ from those in Asian cities (International Organization for Standardization, 1996; Salomons et al., 2011). Most are “black-box” software with little flexibility for customized data input. Many are developed for stand-alone PCs and incompatible with cluster computers. Further, these softwares are difficulty for urban planners to operate and understand (Brüel & Kjær, n.d.). There is a need for an efficient tool that can be applied in dense cities and understood by urban planners (Ding et al., 2014, Pai, 2006).

We propose a novel numerical model to simulate the impacts of road traffic noise in complex spatial configuration or high-density cities. A pilot study was conducted in Sai Ying Pun neighbourhood in Hong Kong. This model returns the intensity of sound energy in 3D urban space. Results can be visualized to enhance understanding of noise environment for non-experts. This model is designed to be able to exchange data with urban planning software such as ArcGIS, Rhinoceros, and SketchUp Pro. It has the potential to serve as a planning and design tool. It would also support population-based health studies by linking traffic noise exposure and health outcomes at household levels.

2. A NUMERICAL MODEL FOR NOISE SIMULATION

This numerical model is proposed to assess household noise exposure in high-density cities. It consists three major sectors: 1) Identifying sound propagation paths with ray tracing; 2) Calculating sound energy attenuation along a propagation path; 3) Synthesizing echogram contributed by each path. The calculation process is concluded with noise exposure at receiver point.

2.1 Ray tracing

We applied backward ray tracing technique to simulate sound propagation in complex spatial configuration. Ray tracing has long been adopted for simulating sound propagation with multiple reflections. It traces the route and reflections of emitted rays for intersection with pre-located detectors (Krokstad et al., 1968; Kulowski, 1985). Seeing the difference between urban scale and wavelength of sound, we employed rays to represent sound propagation paths in high-density cities. We utilized the ray tracing engine of RADIANCE, a state-of-the-art day lighting simulation tool (Radiance-online n.d.). This tool has been extensively validated in many day lighting researches, yet to be applied for acoustic studies (Mardaljevic, 1995; Reinhart & Walkenhorst, 2001). It supports the manipulation of backward ray tracing, and facilitates efficient and accurate calculation of ray paths (Ward et al., 1988; Ward, 1994). We adopted this ray tracing engine for acoustic simulation through handling material characters, receiver parameters, noise source attributes, geometries, etc. In the ray tracing process, rays are randomly emitted from receiver points and intersection points following the Monte Carlo function. Through one or more times of reflection, they would end somewhere in the geometry. Only part of the rays, amongst all, is able to build connection between receivers and resources. These valid rays were then sorted out for ensuing calculation of attenuation through propagation (Figure 1).

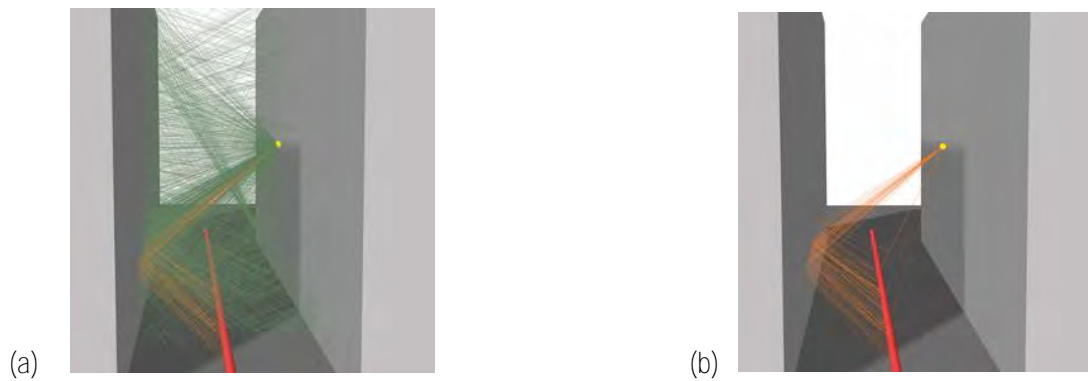

Figure 1: a) Rays are emitted from receiver point (yellow point) into space, including both valid (orange) and invalid (green) rays
b) Only valid rays (orange strings) are able to build connection between sound source (red pipe) and receiver point through direct connection or reflections

2.2 Propagation attenuation

In high-density cities, where spatial configuration is highly complex, the propagation of sound rays is limited in horizontal direction. The propagation paths extend in vertical direction with multiple reflections. Therefore, in addition to attenuation in free field condition, the loss of sound energy upon reflection is considered prior to other types of excess attenuation in our model. Each valid ray contributes an echogram to a receiver point. This echogram is calculated with sound intensity at source and attenuation through propagation. The computation of propagation attenuation (AttenP) takes into account the characters of each ray and 1) Geometric spreading loss (Attengeo), 2) Air absorption (Attenair), 3) Reflection (Attenrefl) and 4) scattering (Attenscat) at reflection surfaces along all segments of each ray path, as expressed in Equation (1). Attengeo and Attenair account for attenuation along transmission in free field condition; and Attenrefl and Attenscat calculates sound energy loss upon reflection. Road traffic noise is calculated with local standard, i.e. the CRTN type of equation (Tang & Tong, 2004).

$$Atten_P = \sum_{k=0}^n f(Atten_{geo}, Atten_{air}, Atten_{refl}, Atten_{scat})$$

Where n is the total segment number of the ray path
Equation 1

For road traffic noise calculation, cylindrical equation is adopted to calculate geometric spreading loss. Sound intensity attenuates in inverse proportion to the increase of propagation distance, independent from frequency (Attenborough, 2007). Air absorption varies with temperature, humidity, pressure, frequency, and transmission distance according to ISO 9613-1 (International Organization for Standardization, 1993). Energy loss due to multiple reflections is estimated with materials characters of reflecting surface. It includes noise reduction coefficient (NRC) and scattering coefficient, and is frequency-dependent. NRC accounts for the reduction of total sound energy upon striking a surface. Scattering coefficient calculates the distribution of energy in specular and non-specular directions. **The angular energy distribution of scattered rays is calculated according to Lambert's cosine law (Kang, 2007).** Figure 2 illustrates the attenuation of sound intensity at 1000 Hz along a random three-segment valid ray path in Figure 1.

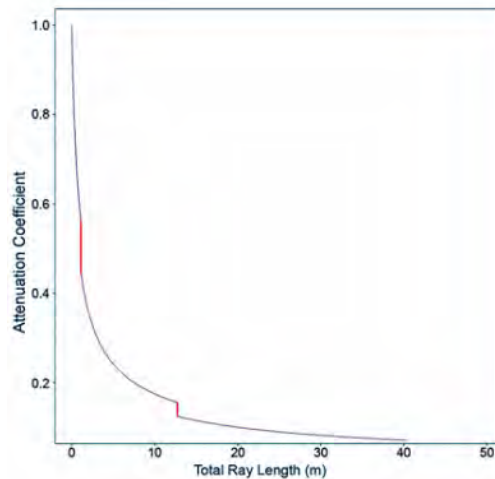

Figure 2: Attenuation of sound energy along single ray path

Blue curve depicts attenuation along propagation; red segment illustrates attenuation upon reflection

Meteorological and environmental parameters include: temperature: 23 Degree Celsius; humidity: 78%; atmospheric pressure: 101.3 Kpa; NRC of all surfaces: 0.2; and scattering coefficient: 0.2

2.3 Acoustic characters at receiver point

Final sound energy histogram at a receiver point is obtained from gross energy contributions of valid ray paths. Each ray path is connected with the geometry of noise source at one point, representing the intersection with traffic flow. Some intersection points are too closely located from another that their contribution cannot be considered independent. In that case, we applied a well-validated data clustering technique, density-based spatial clustering of application with noise (DBSCAN), to handle the intersection points. DBSCAN assembles closely agglomerated **intersection points into clusters with a controlled distance ϵ** (Chakraborty et al., 2011; Dai & Lin, 2012; Ester et al., 1996). Each cluster represents an independent vehicle (Figure 3). Contribution from direct rays, specular rays, and scattered rays are weighted and summed within the cluster. This process calculates the final sound intensity in spectrum at each receiver point. The output could then be transformed into sound pressure level or A-weighted sound pressure level.

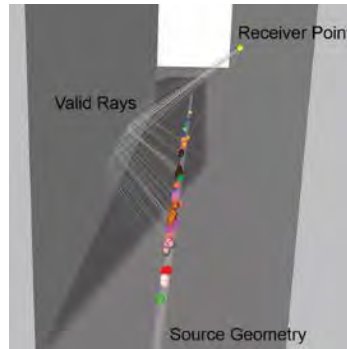

Figure 3: DBSCAN clustering technique; Clustered intersection points represented by Sphere Groups in different colour

3. PILOT STUDY AND DISCUSSION

3.1 Pilot study

This numerical model was tested with a road traffic noise simulation practice in a 200m * 200m area of Sai Ying Pun, Hong Kong. This area is representative for the complex spatial configuration in Hong Kong. Urban model was constructed with Rhinoceros 5 (Figure 4). To simplify, we assumed that surface material of buildings and ground is concrete, with NRC of 0.35 and scattering coefficient of 0.16 at all frequencies. An idealized road traffic noise was calculated with adjusted CRTN type of equation (Tang & Tong, 2004). It endowed a uniformed value: 70 dB(A) to all road segments, representing A-weighted equivalent sound pressure level per day ("L" _ "Aeq,1d"). Source geometry was set as cylinder ($r = 0.5\text{m}$) sitting along road centre line on the ground. We referred to average weather condition of March and April in Hong Kong. The parameters are: 23 Degree Celsius; humidity: 78%; atmospheric average pressure: 101.3 Kpa. Number of scattered rays generated upon each reflection was 100; and maximum reflection time was 2.

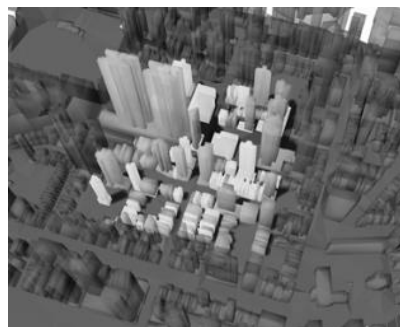

Figure 4: 3D Urban model of selected area in Sai Ying Pun, Hong Kong

A 20 * 20 point array, with an axial distance of 8m in both x- and y- axes, was fitted in with the geometry at the centre of the model area (Figure 5-a). This array was elevated 2m, 5m, 15m, 25m, 35m, and 115m above ground to examine the impact of traffic noise at different elevation. At each elevation, some points were covered by buildings; while others were exposed in urban open space (Figure 5-b). Those exposed points were valid receivers, which will be endowed acoustic characters at the end of the simulation process.

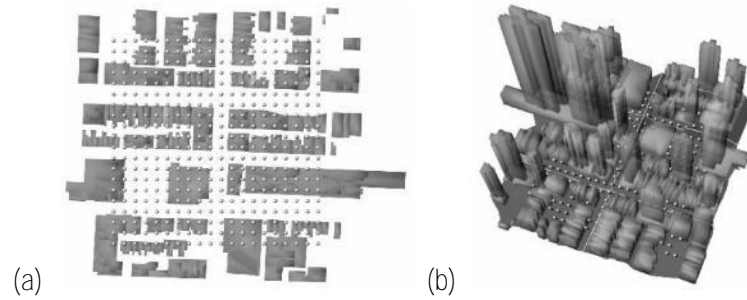

Figure 5 Receiver Array (Represented by Spheres) in Model
(a) A 20 * 20 point array in the centre of the model
(b) Point array (white balls) elevated at 5m above ground; white lines represent road traffic

3.2 Results and discussion

Simulation output were visualized as raster images, depicting sections of traffic noise impacts on respective elevations (Figure 6). Variation of traffic noise exposure was illustrated. Sound pressure level fluctuation of points on the same section became moderate while elevating the section upward. Meanwhile average sound pressure level turned moderate from ground level to the roof level of low-rise buildings (e.g. tenement buildings) (Figure 6-a, b, c), and increased afterwards (Figure 6-d,e,f). Results of Sai Ying Pun study contribute to better understanding of 3D urban acoustic environment. Being able to assess noise exposure at individual level in urban scale, our model may support population-based studies on the health impact of road traffic noise. It also suggests a potential of the model to serve as an urban planning and design tool.

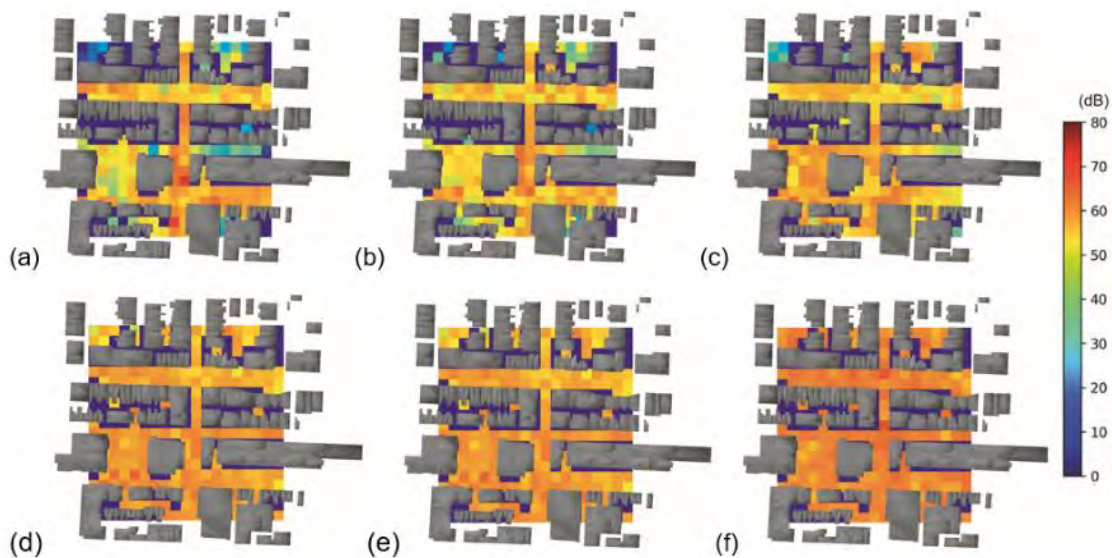

Figure 6: Acoustic sections of $L_{Aeq,1d}$ above ground at (a)2m, (b) 5m, (c)15m, (d)35m, (e)55m, (f)115m

There are several limitations in our numerical model. The time domain of propagation is not yet included, seeing that road traffic noise is expressed by time-averaged equivalent sound pressure level for calculation with CRTN model. We have neglected the wave character of sound by adopting ray tracing technique and geometrical acoustics. Compared to conventional engineering models, characters including diffraction, ground impedance, atmospheric refraction, and atmospheric turbulence are not yet considered. Validation study with lab experiment and field measurement is being scheduled.

4. CONCLUSION

In this paper we proposed a novel numerical model to simulate individual exposure to road traffic noise in high-density cities. We employed ray tracing, geometrical acoustics, and clustering technique in the algorithm. A pilot study in Sai Ying Pun, Hong Kong was conducted. Results presented the impact of traffic noise in 3D urban space

with different elevations. This model has a potential to assist population-based studies for uncovering health impacts of road traffic noise. It may also serve as a planning and design tool, and facilitate efficient knowledge sharing among planners and designers, also with other stakeholders. Lab experiment and field measurement is being scheduled.

REFERENCES

- [1] Attenborough, K., 2007. Sound Propagation in the Atmosphere. In J.C. Malcolm, ed. Handbook of Noise and Vibration Control. John Wiley & Sons, Hoboken, NJ, USA, 67-78
- [2] Basner, M., Babisch, W., Davis, A., Brink, M., Clark, C., Janssen, S., and Stansfeld, S., 2014. Auditory and Non-auditory Effects of Noise on Health. *The Lancet*, 383(9925), 1325–1332.
- [3] Berglund, B., Lindvall, T., and Schwela, D., 2000. New WHO Guidelines for Community Noise. *Noise & Vibration Worldwide*, 31(4), 24–29.
- [4] Brüel & Kjær, Noise Mapping, Prediction, Modeling and Calculation Software - Predictor-LimA Type 7810 [online]. Retrieved from: <http://www.bksv.com/Products/EnvironmentManagementSolutions/NoiseMappingandPrediction/predictor-lima-7810?tab=descriptions> [Retrieved on 19 August 2016].
- [5] Chakraborty, S., Nagwani, N.K. & Dey, L., 2011. Performance Comparison of Incremental K-means and Incremental DBSCAN Algorithms. *International Journal of Computer Applications*, 27(11), 975–8887.
- [6] Dai, B.R. & Lin, I.C., 2012. Efficient map/reduce-based DBSCAN algorithm with optimized data partition. In *Proceedings - 2012 IEEE 5th International Conference on Cloud Computing*, 59–66.
- [7] Department of Transport Welsh Office, 1988. Calculation of Road Traffic Noise, Great Britain Welsh Office & Great Britain Department of the Environment, eds., H.M.S.O., London.
- [8] Ding, Z., Li, J., Ng, F., 2014, A parallel multiple mediator model of knowledge sharing in architectural design project teams, *International Journal of Project Management*, 32(1), 54-65
- [9] Environmental Protection Department, Noise [online]. Retrieved from: http://www.epd.gov.hk/epd/english/environmentinhk/noise/noise_maincontent.html [Retrieved on 19 August 2016].
- [10] Ester, M., Kriegel, H., Sander, J., and Xu, X. 1996. A Density-Based Algorithm for Discovering Clusters in Large Spatial Databases with Noise. In E. Simoudis, J. Han, & U. Fayyad, eds. *Proceedings of the Second International Conference on Knowledge Discovery and Data Mining*. Portland, Oregon, 226–231.
- [11] GovHK, Noise [online]. Retrieved from: <http://www.gov.hk/en/residents/environment/noise/> [Retrieved on 19 August 2016].
- [12] International Organization for Standardization, 1996. Acoustics - Attenuation of Sound During Propagation Outdoors - Part 2: General Method of Calculation, International Organization for Standardization, Geneva.
- [13] International Organization for Standardization, 1993. Acoustic - Attenuation of Sound During Propagation Outdoors - Part 1: Calculation of the Absorption of Sound by the Atmosphere, International Organization for Standardization, Geneva.
- [14] Kang, J., 2007. *Urban Sound Environment*, CRC Press, London.
- [15] Krokstad, A., Strom, S. and Sørsdal, S., 1968. Calculating the Acoustical Room Response by the Use of A Ray Tracing Technique. *Journal of Sound and Vibration*, 8(1), 118–125.
- [16] Kulowski, A., 1985. Algorithmic Representation of the Ray Tracing Technique. *Applied Acoustics*, 18(6), 449–469.
- [17] Lam, K.C. and Chung, Y.T., 2012. Exposure of Urban Populations to Road Traffic Noise in Hong Kong. *Transportation Research Part D: Transport and Environment*, 17(6), 466–472.
- [18] Lam, K.C., Brown, A.L., Wong, T.W., van Kamp, I., and Chan, Y.K., 2012. Final Report for the Provision of Service for the Study of Health Effects of Transportation Noise in Hong Kong, Retrieved from: http://www.epd.gov.hk/epd/textonly/english/environmentinhk/noise/study/rpts/files/study_health_effects.pdf [Retrieved on 19 August 2016].
- [19] Lam, K.C., Ma, W., Chan, P.K., Hui, W.C., Chung, K.L., Chung, Y.T., Wong, C.Y., and Lin, H., 2013. Relationship between Road Traffic Noisescape and Urban Form in Hong Kong. *Environmental Monitoring and Assessment*, 185(12), 9683–9695.
- [20] Law, C.W., Lee, C.K., Lui, S.W., Yeung, K.L., and Lam, K.C., 2011. Advancement of Three-dimensional Noise Mapping in Hong Kong. *Applied Acoustics*, 72(8), 534–543.

- [21] Mak, C., Leung, W. and Jiang, G., 2010. Measurement and Prediction of Road Traffic Noise at Different Building Floor Levels in Hong Kong. *Building Services Engineering Research and Technology*, 31, 131–139.
- [22] Mardaljevic, J., 1995. Validation of a lighting simulation program under real sky conditions. *Lighting Research & Technology*, 27(4), 181–188.
- [23] Pai, J., 2006. An empirical study of the relationship between knowledge sharing and IS/IT strategic planning (ISSP), *Management Decision*, 44(1), 105–122
- [24] Radiance-online, Radiance - A Validated Lighting Simulation Tool - Radsite [online]. Retrieved from: <https://www.radiance-online.org/> [Retrieved on 19 August 2016].
- [25] Reinhart, C.F. and Walkenhorst, O., 2001. Validation of dynamic RADIANCE-based daylight simulations for a test office with external blinds. *Energy and Buildings*, 33(7), 683–697.
- [26] Salomons, E., van Maercke, D., Defrance, J., and de Roo, F., 2011. The Harmonoise Sound Propagation Model. *Acta Acustica united with Acustica*, 97(1), 62–74.
- [27] Tang, S.K. and Tong, K.K., 2004. Estimating Traffic Noise for Inclined Roads with Freely Flowing Traffic. *Applied Acoustics*, 65(2), 171–181.
- [28] To, W.M., Ip, C.W., Lam, C.K., and Yau, T.H., 2002. A Multiple Regression Model for Urban Traffic Noise in Hong Kong. *The Journal of the Acoustical Society of America*, 112(2), 551–556.
- [29] Van Kempen, E. and Babisch, W., 2012. The Quantitative Relationship between Road Traffic Noise and Hypertension: A Meta-Analysis. *Journal of Hypertension*, 30(6), 1075–86.
- [30] Ward, G.J., 1994. The RADIANCE Lighting Simulation and Rendering System. In D. Schweitzer, A. Glassner, and M. Keeler, eds. **Computer Graphics (Proceedings '94 SIGGRAPH conference)**. ACM, New York, 459–472.
- [31] Ward, G.J., Rubinstein, F.M., and Clear, R.D., 1988. A Ray Tracing Solution for Diffuse Interreflection. *ACM SIGGRAPH Computer Graphics*, 22(4), 85–92.

Real Coded Quantum-Inspired Evolutionary Algorithm Applied to Sustainable Building

Omar QUISPE POLANCO^a, Yvan TUPAC VALDIVIA^b

^a Universidad Catolica San Pablo, Arequipa-Peru, omar.quispe.polanco@ucsp.edu.pe

^b Universidad Catolica San Pablo, Arequipa-Peru, ytupac@ucsp.edu.pe

ABSTRACT

Nowadays, sustainable building is a relevant research area by the current global trend to apply science in order to improve the life quality of the ever-growing populations. It is hard to develop a prior complete plan to ensure the best use of materials, energy, hard-working and then less environmental pollution once a construction is finished. To help in these projects there are several approaches from different disciplines using a broad set of search techniques or heuristics combined with some computer assisted simulators and programs where the goal is to find the best match between design and sustainability.

In this work we will use a new approach of populational heuristics: the Quantum-Inspired Evolutionary Algorithm (QIEA-R) and the SBTool rating system. Although traditional evolutionary algorithms have demonstrated good outcomes when applied in several models of sustainability in buildings, there are some drawbacks that make them not good at all. To avoid these difficulties, we propose to use the QEIA-R to find the best combination of building criteria.

This algorithm uses the quantum mechanical foundations of superposition of states to improve speed and less computation to find best solutions. Also the QIEA-R can search solutions over continuous domains and, the building problems need a continuous solving approach. The effectiveness of our work will be proved using the SBTool rating system and a sustainability criterion set suitable to Arequipa City in Peru. Thus, in this work we will present a case study over the city of Arequipa. Results will demonstrate efficiency in computational time and resources, and open a new research line in the field of quantum algorithms applied in optimization of sustainable buildings.

Keywords: green infrastructure, evolutionary algorithms, quantum-inspired

1. INTRODUCTION

Sustainable Building (SB) as a research and development area have changed the way of conducting building projects all over the world. Countries are experimenting a fast population growth, and some resources are now not available at all. The need of spend less money, time, energy and resources in a building project have carried a big set of approaches in different areas. The common goal is to develop the best plan in order to have the best match among the building functionality and sustainability.

Computer Science (CS) have widely opened a research area in SB. Algorithms can speed up any kind of process, and buildings use a big set of data to be processed and help professionals to take decisions. Several CS approaches to SB have been placed promoting solutions around metrics, statistics, heating ventilating and air conditioning systems (HVAC), topography and so. Most of them use optimization methods to achieve their goals (Baños, et al., 2011). Heuristics Methods (Somayeh, et al., 2014) include a set of search algorithms, and includes the Evolutionary Algorithms (EA) which is base of our work. Almost all of these algorithms work under a discrete domain. Although some problems can be modeled under discrete domains, and heuristics and evolutionary algorithms have demonstrated good results, we found out that in SB the discrete scenarios are just a bit of the problem.

In this work we will demonstrate the efficiency of the Real Coded Quantum Inspired Evolutionary Algorithm (Abs da Cruz, et al., 2007) (QIEA-R), which have been constructed to work with continuous values. The QIEA-R takes advantage of the principles of Quantum Computing (Hey, 2002) (QC) to construct a population that simulates superposition of states. We apply this approach to a building case study over the Arequipa city in Peru. Finally, we will validate the results using the SBTool rating system.

Our motivation is to open a new branch of SB studies, promoting the use of all the SB benefits in Peru and to achieve the goal of sustainable countries. This paper is divided as follows: section 2 the related work, section 3 the QC basis, section 4 the QIEA-R algorithm, section 5 the experiments, finally in section 6 the conclusions and future work.

2. RELATED WORK

Building projects are being executed all over the world since memorial dates, human and natural resources are the main components in every project. Over the last decades, science and technological development have provided help to humans in performing projects using less energy (Rivard, 2006). Unfortunately, at the opposite site, this faster global growth has increased an unconscionable use of natural resources (Schultz, et al., 2016). Another concern is the building final product, once a construction is finished it produces pollution and needs energy to satisfied human daily needs

SB enforcement brings a new era in conducting building projects (Happio, et al., 2008). Different research areas promote the application of their techniques to spend less time, resources, pollution and energy. CS uses a good set of algorithms and programming techniques to achieve SB goals. Our approach is novel, but we present the following related works.

Multi Agents Systems in HVAC systems (Wang, y otros, 2011) are the easiest sample to understand that a building needs constantly carry energy to several power devices to ensure human wellness. Multi Objectives approaches solve problems when several objectives are needed (Yao, 2014). Genetic algorithms (Rowe, 2012) are a subset of Evolution Algorithms (Sarker, et al., 2002), which simulate Darwinism evolution theory.

In (Caldas, et al., 2003) Caldas and Norford use Genetic Algorithms (GA), their work focuses on HVAC control to achieve energy optimization, and perform a building envelope simulation to improve the lightness in rooms. They use a Pareto and non-Pareto basis approaches. One of the drawbacks of GA is the fact to define a good fitness function; another one is that GA can suffer of stagnation due to local maximums.

Shea et al. (Shea, et al., 2006) define the Multicriteria Ant Colony Optimization method (MACO) that uses a Pareto filtering. The task is to improve building envelopes for lighting performance. This Pareto approach do not search the best result among all criteria, it eliminates solutions and evolve just a few set of individuals.

Wu and Thomas (Wu, et al., 2012) use a GA putting in surface the three well-know objectives in SB which are economical aspect, energy performance and end-user comfort. They use a building simulating program called EnergyPlus. Fuzzy logic is carried out to define the best temperature of any ambient. The GA is developed using a Multi Objective approach which have three objectives functions mentioning the SB objectives.

3. QUANTUM COMPUTING

Since many years QC (Hey, 2002) is taking more and more enforcement. The reason is quite simple; the idea of faster data computing opens a new way of think about computers. Actually, we all know computers use binary bits as the minimum element to store information. Binary bits just can store 1's or 0's. In QC the bit now is represented as a Q-bit, that can represent not only 1 nor 0, but any combination of them. The common representation of the Q-bit is:

$$|\Psi\rangle = \alpha |0\rangle + \beta |1\rangle$$

Equation 1

where " Ψ " represents the state of the Q-bit, α and β are complex numbers. The Q-bit instead of the well-known binary bit, can contain more information letting computers perform more computations, improving the computation cost and breaking some barriers that binary computers cannot.

Although quantum computers are not commercially available yet, studies have demonstrated good results in simulating QC basis over binary computers (Grover). Our work promotes the evolution algorithms using a quantum inspiration where they key is the manipulation of the Q-bit.

4. THE REAL CODED QUANTUM INSPIRED EVOLUTIONARY ALGORITHM

Abs da Cruz et al. (Abs da Cruz, et al., 2007) define an EA for real numbers using a QC approach. Their work focuses in numerical optimization. The motivation of our work is to demonstrate the efficiency of the QIEA-R applied to SB, due to the need of a continuous domain. The algorithm follows these steps:

```

Algorithm 1 Real Coded Quantum Inspired Evolutionary Algorithm
1:  $t \leftarrow 1$ 
2: generate quantum population  $Q(t)$  with  $N$  individuals and  $G$  genes
3: while ( $t \leq T$ ) do
4:  $E(t) \leftarrow$  generate classic individuals while observing quantum individuals
5: if ( $t=1$ ) then
6:    $C(t) \leftarrow E(t)$ 
7: else
8:    $E(t)$  recombination with  $E(t)$  and  $C(t)$ 
   evaluate  $E(t)$ 
    $C(t) \leftarrow K$  best individuals of  $[E(t) \cup C(t)]$ 
9: end if
10:  $Q(t+1) \leftarrow$  Update  $Q(t)$  using best individuals of  $C(t)$ 
11:  $t \leftarrow t+1$ 
12: end while
    
```

Figure 1: Algorithm steps

4.1 The quantum population

In the same way a binary bit represents a binary population, the quantum population is made of Q-bits which represent the superposition of states (Hey, 2002). So the quantum population is made up of N quantum individuals $q_1 = (1, 2, 3, \dots, N)$. Each quantum individual q_1 is made up of G genes $g_{ij} = (j=1, 2, \dots, G)$ and finally each gene is associated to a function that represents a probability density. The formal representation is:

$$q_i = [g_{i1} = p_{i1}(x), g_{i2} = p_{i2}(x), g_{iG}(x)]$$

Equation 2

where $i = 1, 2, \dots, N$, $j = 1, 2, \dots, G$, and p_{ij} represents a probability density function that is the probability of observing a value for a quantum gene when is under superposition. A gene is a pulse in a continuous domain and for our case **represents a square shape**. In the Figure 2 a pulse is created, it has a center point (μ), and a length (σ). So the task is to create a set of quantum individuals, each one with a set of quantum pulses. In Table 1 shows two individuals and two genes each one.

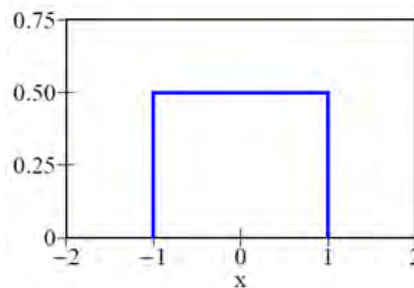

Figure 2: Quantum gene

Individual	Genes
q_1	$g_{11} = (\mu = -5, \sigma = 20)$, $g_{12} = (\mu = 0, \sigma = 20)$
q_2	$g_{21} = (\mu = 5, \sigma = 20)$, $g_{22} = (\mu = 5, \sigma = 20)$

Table 1: Example of individuals and genes

4.2 Classic individuals

The next step creates the classic individuals for each gene, which are the real values in the space. The probability density function and a random number generator are needed for this step. The authors use a line function as a probability density function. Having the random number r in the $[0, 1]$ interval, we use the line formula:

$$x_{mj} = r_{mj} * \sigma_{ij} + (\mu_{ij} - \sigma * 0.5)$$

Equation 3

Once the classic population has been created, we need validate it using an optimization function. Abs da Cruz et al. (Abs da Cruz, et al., 2007) use the QIEA-R for function optimization. In our work we define a domain with continuous values to optimize; the more the values close to a desired point, the best optimization we get. After the validation step, the evolution process begins. Abs da Cruz et al. propose 4 possible approaches to replace or update the last population: replacing the old population with the new one, replacing the old population but preserving the best one, replacing the n worse individuals with the n best individuals of the new population and replacing the n worse individuals with the n whichever new individuals.

4.3 Quantum population update

To achieve the evolution approach each quantum individual must be updated. As we are working under a continuous domain, the main criterion is to ensure the candidates to suffer modification to enclose them to the answer. For each gene the μ value must be relocated and the σ value increased or decreased. Abs da Cruz et al. use the 1/5 rule (Michalewicz, 1996), which is a heuristic to modify the individuals boundaries. If the amount of individuals that have been replaced by others of the new generation is greater than the 20%, σ is divided by a random value δ in the interval $]0, 1[$. If it is lower than the 20%, σ is incremented. Otherwise there is no change. In Figure 3 the complete algorithm schema.

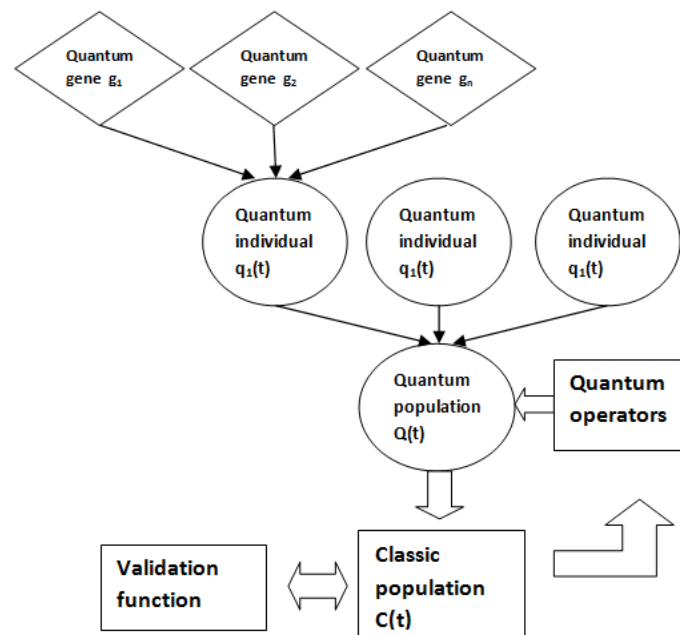

Figure 3: Algorithm schema

5. EXPERIMENTS

The novelty of this work is to use the QIEA-R in a real building case study to get the best score in sustainability using the SBTool as a rating system. We work hand by hand with a research group of architects that validates SBTool input data and score. This last due to this paper is part of a government research project.

5.1 Using the SBTool rating system

The International Initiative for a Sustainable Built Environment (iiSBE) developed the Sustainable Building Tool (SBTool) (Larsson, et al., 2012). It is a framework that can be calibrated by region depending the conditions and needs. We rate our work using the SBTool criteria. Table 2 shows some highlights of Arequipa conditions set in SBTool. As an important note, Arequipa city has the title of Cultural Heritage of Humanity by the United Nations Educational, Scientific and Cultural Organization (UNESCO). In Table 3 the SBTool criteria used is showed. This work uses these data as input for the algorithm and then brings the best rate possible.

Item	Descriptors of Condition
<i>Ecological Sensivity Classification</i>	High: Areas that contribute to regional biodiversity but lack critical habitats for at risk species. Development should generally avoid these areas.
<i>Flooding Risk Classification</i>	Location is a Medium-Low Risk Zone for flooding
<i>Site location with respect to earthquake risk classification</i>	Site is located in a High Risk Zone, with soil capacities <0.7 kg/cm ² , a period of vibration of 0.52 sec. and a high probability of liquesfaction
<i>Volcanic risk classification</i>	Location is in a High Risk Zone
<i>Availability and enforcement of urban planning regulations, including zoning of land uses, occupancy types and building heights</i>	The content or geographical coverage of regulations covering zoning of land uses, occupancy types or building heights provides a high degree of guidance for future growth
<i>Availability and adequacy of municipal water supply in the urban region</i>	The municipal system has some quality and/or supply problems
<i>Public transport system in the urban area</i>	There is no public transport system, and private services are poor.

Table 2: Arequipa city context information

SBTool Issues	SBTool Categories
A Site Regeneration and Development	A1 Site Regeneration and Development, A2 Urban Design, A3 Project Infrastructure and Services
B Energy and Resource Consumption	B1 Total Life Cycle Non-Renewable Energy, B2 Electrical peak demand, B3 Use of Materials, B4 Use of potable water, stormwater and greywater
C Environmental Loadings	C2 Other Atmospheric Emissions, C3 Solid and Liquid Wastes, C4 Impacts on Project Site, C5 Other Local and Regional Impacts
D Indoor Environmental Quality	D1 Indoor Air Quality and Ventilation, D3 Daylighting and Illumination, D4 Noise and Acoustics
E Service Quality	E1 Safety and Security, E2 Functionality and efficiency, E3 Controllability
F Social, Cultural and Perceptual Aspects	F1 Social Aspects, F2 Culture and Heritage
G Cost and Economic Aspects	G1 Cost and Economics

Table 3: SBTool manipulation data

5.2 Using the QIEA-R with SBTool input data

We follow the steps of the algorithm in Figure 1. We define a quantum individual for each SBTool criterion, each quantum individual is made up for a variable number of genes. We use the line function as probability distribution. We use the SBTool score to optimize the population. For updating we choose to replace the worst n individuals

with the n best ones. In figure 4 the evaluation step uses the SBTool as engine to get the highest score per criteria and overall score.

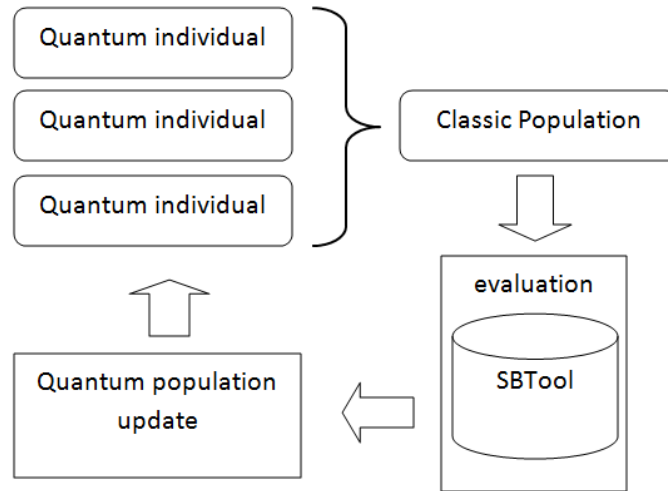

Figure 4: Algorithm steps

We encourage the use of a minimum number of genes per individual and a small number of individuals. In Table 4 we evaluate a population of 1000 individuals with a different set of genes per individual. The best score is 3.74 and the worst 3.70 meaning a big number of genes per individual are not necessary see Figure 5. So we proceed to work with different number of individuals and just one set of genes per individual. Table 5 shows a pretty similar best score using a really different number of individuals with the same number of genes. See Figure 6.

The quantum approach of superposition of states demonstrates the effectiveness of the algorithm. Having a small number of individuals is enough to reach the best result. We perform 100 iterations in every evaluation, over that number the result remains the same. The quantum algorithm converges fast.

Individuals	Genes per Individual	Overall Score
1000	500	3.74
	250	3.74
	150	3.74
	100	3.72
	50	3.72
	25	3.70
	10	3.70

Table 4: Quantum population with different genes per quantum individuals

Individuals	Genes per Individual	Overall Score
5000	20	3.74
2000		3.74
1000		3.73
500		3.73
250		3.72
100		3.72
50		3.70

Table 5: Different number of quantum individuals using a same number of genes

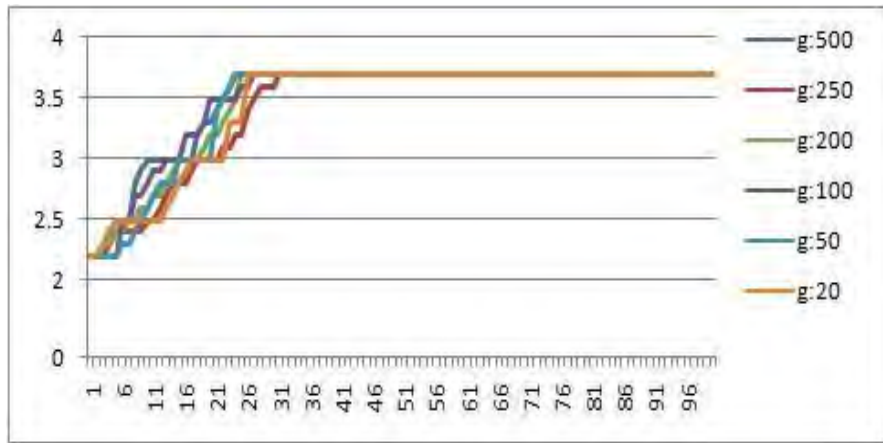

Figure 5: 1000 Individuals and a set of different number of genes

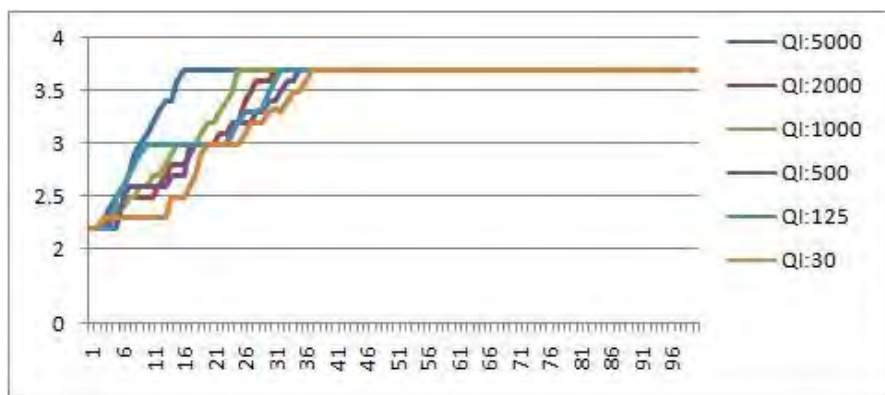

Figure 6: 20 Genes with different number of quantum individuals

5.3 Case study

We perform the design simulation of a building project. The structure is a dwelling house with a total of 120m², total built area 36.83m², no built area 83.17m², 2 floors, 3 bedrooms, 2 bathrooms, 1 dining room, 1 kitchen. Figure 7 shows the rendering of the structures. In Figure 8 a screenshot of the SBTTool results B+ that represents a Good Practice or better, and in Figure 9 the table screenshot of the weighted criteria and the project score 3.74.



Figure 7: Building rendering



Figure 8: SBTool relative performance results B+

A	Site Regeneration and Development, Urban Design and Infrastructure	10.5%	3.6
B	Energy and Resource Consumption	33.9%	3.4
C	Environmental Loadings	39.0%	4.2
D	Indoor Environmental Quality	4.3%	4.5
E	Service Quality	5.7%	3.4
F	Social, Cultural and Perceptual Aspects	4.5%	2.4
G	Cost and Economic Aspects	2.0%	4.1
Weighted project score			3.74

Figure 9: Weighted project score 3.74

6. CONCLUSIONS AND FUTURE WORK

We use the QIEA-R for a continuous SB approach. We used the SBTool as a simulator in order to get the best sustainable score in the building project. Using the benefits of the SBTool we can choose for example the best geographical point to place the building before any kind of work. Also, is possible to define a set of materials, comfort devices and so depending of the changing conditions that the algorithm can set on the march.

The effectiveness of the algorithm has been demonstrated speeding up the evolution process and using less resources. A professional approval is done under the supervision of the project expert group we work with. As a future work we will compare traditional GA and EA against the QIEA-R. Finally, the Sustainable Building research and development area will be deeply introduced to the Peruvian reality. This is one of the goals of this government-funded project. Sustainable Building is a need for everybody; we must enforce populations in every project to conduct their tasks using SB principles.

ACKNOWLEDGMENT

The authors would like to thank the San Pablo Catholic University of Arequipa Peru and the National Council for Science, Technology and Innovation (CONCYTEC) of the Peruvian government for funding this project.

REFERENCES

- [1] A critical review of building environmental assessment tools [Journal] / auth. Happio A. and Viitaniemi P.. - [s.l.] : Environmental Impact Assessment Review - ScienceDirect, 2008.
- [2] A Fast Quantum Mechanical Algorithm for Database Search [Journal] / auth. Grover L.. - 1996: Proceedings of the twenty-eighth annual ACM symposium on Theory of computing - ACM.
- [3] A Multi-Objective (Energy, Economic and Environmental Performance) Life Cycle Analysis for Better Building Design [Journal] / auth. Yao J.. - [s.l.]: Sustainability, 2014. - Vol. 4. - 10.3390/su6020602.
- [4] A Multi-Objective Optimization Model for Sustainable Building Design Using Genetic Algorithm and Fuzzy Set Theory [Journal] / auth. Wu H. and Thomas S. // The CIB joint International Conference on Management of Construction. - Montreal, Canada: The University of Hong Kong, June 2012.
- [5] A New Multiobjective Evolutionary Algorithm [Journal] / auth. Sarker R., Liang K. and Newton C.. - [s.l.] : ScienceDirect, 2002. - 1: Vol. 140. - pp. 469-482. - [http://dx.doi.org/10.1016/S0377-2217\(01\)00190-4](http://dx.doi.org/10.1016/S0377-2217(01)00190-4).
- [6] A Quantum-Inspired Evolutionary Algorithm for Optimization Numerical Problems [Journal] / auth. Abs da Cruz A., Vellasco M. and Pacheco M. // Studies in Computational Intelligence. - 2007. - pp. 19-37.
- [7] Computer Assistance for Sustainable Building Design [Journal] / auth. Rivard H.. - Montreal: Springer Berlin Heidelberg, 2006.
- [8] Error Sources in Deforestation Detection Using BFAST Monitor on Landsat Time Series Across Three Tropical Sites [Journal] / auth. Schultz M., Verbesselt J. and Abitabile V.. - [s.l.] : Selected Topics in Applied Earth Observations and Remote Sensing, 2016.
- [9] Genetic Algorithm Theory [Journal] / auth. Rowe J.. - [s.l.]: ACM, 2012. - 10.1145/2330784.2330923.
- [10] Genetic Algorithms + Data Structures = Evolution Programs [Journal] / auth. Michalewicz M.. - Cambridge: Springer, January 1996.
- [11] Genetic Algorithms for Optimization of Building Envelopes and the Design and Control of HVAC Systems [Journal] / auth. Caldas L. and Norford L. // Journal of Solar Energy Engineering. - 2003. - Vol. 125. - 10.1115/1.1591803.
- [12] Multi-agent intelligent controller design for smart and sustainable buildings [Publicación periódica] / aut. Wang Z, Yang R. y Wang L.. - [s.l.]: IEEE Systems Conference, 2011.
- [13] Multicriteria Optimization of Paneled Building Envelopes Using Ant Colony Optimization [Journal] / auth. Shea K., Sedgwick A. and Antonunnto G. // Lecture Notes in Computer Science. - [s.l.] : Springer Berlin Heidelberg, 2006. - pp. 627-636. - 10.1007/11888598_56.
- [14] Optimization Methods Applied to Renewable and Sustainable Energy [Journal] / auth. Baños R. [y otros] // Renewable and Sustainable Energy Reviews. - 2011. - p. 13.
- [15] Quantum computing: an introduction [Journal] / auth. Hey T.. - [s.l.]: Computing and Control Engineering, 2002. - Vol. 10.
- [16] Sustainable Building Design: A Review on Recent Metaheuristic Methods [Journal] / auth. Somayeh Asadi and Zong Woo Geem // Studies in Computational Intelligence. - 2014. - pp. 203-223.
- [17] Using the SBTool System as a platform for education in sustainable built environment [Journal] / auth. Larsson N. and Braganca L. // Building Sustainability Assessment. - [s.l.]: ACM, 2012.

Sustainable Neighbourhood Regeneration: Holistic Decision Support Methodology supported by a Software Tool

Paul MITTERMEIER^a, Natalie EBIG^b, Ahmed KHOJA^c

^a Munich University of Applied Science, Germany, paul.mittermeier@hm.edu

^b Munich University of Applied Science, Germany, natalie.essig@hm.edu

^c Munich University of Applied Science, Germany, hoja@hm.edu

ABSTRACT

The traditional approach to energy efficiency in building retrofitting brings poor results in terms of urban sustainability, resource efficiency and economic return. In order to fulfill the EU-targets for 2030 and 2050 and to support the necessary building-retrofit market, the European project FASUDIR was established under the framework of a FP7 R&D program. FASUDIR provides an Integrated Decision Support Tool based on a new methodology supported by a software tool that will help decision makers to select the most suitable energy retrofitting strategy to increase the sustainability (economic, social and environmental) of a whole urban district. The Decision Support Methodology developed in FASUDIR guides planners of neighbourhood retrofitting projects in a structured way through several phases of the project. The Methodology starts with the preparation phase comprised of data collection and data entry. The diagnosis phase demonstrates planners and stakeholders the current state of the neighbourhood in terms of sustainability and overall energy efficiency. The decision-making phase helps planners to create optimized energy retrofitting variants for the neighbourhood. It allows considering the neighbourhood as a global energy system by assessing heat and electricity related synergies and interactions between buildings. Based on the results the planners are able to design heat networks and to plan the inclusion of renewable energy sources taking into account smart grids and energy storages. The created energy variants can be assessed and ranked with regard to their sustainability by a MCDA approach and the use of several simulated Key Performance Indicators (LCA, cost, energy, social aspects).

Keywords: urban district regeneration, sustainability, energy, holistic decision-support, software tool, neighbourhood

1. INTRODUCTION

The current results of retrofitting interventions on building scale have shown that the effectiveness of building retrofitting can be increased significantly through considering each building as a part of a global energy system in a district [6] [7]. This follows the approach of considering all buildings located in the same district as an entity. In this case the application of retrofitting measures is not limited to single buildings only but can be applied on district level through exploiting synergies and interactions between buildings and their surrounding infrastructure and environment. While planning retrofitting concepts for single buildings is a challenging task the complexity and work intensity for planners on district scale increases significantly. While acting on district scale planners have to consider how implemented measures on single buildings may affect the implementation of measures for other buildings located in the same district. Retrofitting measures on single buildings even may have negative impacts for other buildings or the whole district sustainability performance if they are not planned proactively. For instance, the feasibility of establishing heat networks between buildings is strongly depending on the available heat demand density in an area. Thus, planners in district retrofitting projects have to assess if retrofitting measures on single buildings like improving the building envelop are more sustainable than connecting the buildings to a renewable driven heat network. In order to find the optimum solution in terms of sustainability for a whole district planners have to consider several criteria like the total impacts on the environment, the life cycle costs, the return of investment as well as social impacts of the planned measures. Moreover, in order to gather all the needed information for a sensible planning process and to achieve the most effective results planners have to cooperate with all involved stakeholders in a well-coordinated and structured way. Among others, representants of the municipalities, building owners, tenants, financing bodies and energy supplying companies have to be involved in all phases of the planning and implementation process. This presents a major challenge to planners of district retrofitting projects and can only be solved following a well-structured and thoughtful methodology which guides the planners and all involved stakeholders through the different phases of the project. To facilitate the planning on

district scale and to improve the effectiveness of the planning and implementation process of energy retrofitting measures the use of an advanced and integrated planning and decision-support tool (IDST) is indispensable.

2. FASUDIR METHODOLOGY AND DESCRIPTION OF THE INTEGRATED DECISION-SUPPORT TOOL (IDST)

2.1 The FASUDIR decision-support methodology

The execution of district retrofitting projects is a very multifaceted task for planners and all involved stakeholders. Compared to building level projects the complexity on district scale grows exponentially while the data availability declines. So, planners need a sophisticated decision-support methodology to handle the complexity in an appropriate way. Therefore, the FASUDIR Methodology divides district retrofitting projects into four main steps which planners can work off in a structured work process. The four steps are defined as followed:

- Preparation Phase
- Diagnosis Phase
- Decision-Making Phase
- Implementation Phase

2.2 Project preparation phase

The preparation phase is the foundation of each district retrofitting concept. In this phase all necessary data to create a citymodel for the use in FASUDIR is collected from several sources (GIS, CityGML, on-site inspection, owner and occupant surveys, etc.). The FASUDIR IDST supports planners in collecting the data by involving all stakeholders that may be able to provide needed data via an e-collaboration platform. Hence, planners are able to request data from different data providers in a structured data collection process. Stakeholders are able to share digital data or to respond on the requests of the planners. E.g. owners, ESCOs or representants of municipalities are able to upload geodata files on the platform which can be utilised by the planners or a data manager. Owners and tenants can fill an online-survey which asks them several for the building characterisation necessary data, that cannot be obtained from default data or on-site inspection from the outside of the buildings (heating system, average number of occupants, measured energy data, etc.) [4]. Planners use the e-collaboration platform as a supporting tool in the preparation phase. It supports them in accelerating the data collection by an improved information flow between planners and other stakeholders.

2.3 Project diagnosis phase

The next phase in the FASUDIR Methodology is called diagnosis phase. In this phase an evaluation of the current sustainability state is conducted and the useful targets for a district retrofitting project are defined. After the data entry process has been completed all necessary data to run a first simulation for assessing the current state of the whole district and all buildings in the district is available in the IDST Citymodel. The current state is analysed according to its global sustainability by the use of Key Performance Indicators (KPIs) which have been defined in the FASUDIR Methodology on building and district level [5]. To assess the current sustainability state of the district and each building the following in Table 2 listed KPIs are used:

Thus, all KPIs are calculated by the IDST based on the simulation results. Additionally, each KPI is compared to a defined benchmark from the methodology which allows evaluating the KPI result compared to a sensible average value. This allows the user of the IDST to identify the strengths and weaknesses of the district in terms of sustainability. A low KPI value in this case means that the sustainability issues which the KPI addresses must be improved. To support the visualization of the KPI results to the user the IDST provides a special KPI Analysis Tool which is used every time the user wants to check KPI results. The KPI analysis tool also is used to assess the created energy variants in the decision-making phase. **Moreover, to enable a detailed evaluation of the district's and building's results** the user has the possibility to display selected raw data of the simulation results. These for example are the direct simulation outputs which are stored in the building and district result records of the Citymodel. The user therefore is able to access and display all data that is stored in the city model databases on a map. Thus, the user also has the possibility to export the data generated in the current state evaluation for further purposes beyond the FASUDIR IDST.

2.4 Project decision-making phase

The decision-making phase is the third phase in the FASUDIR methodology. The decision-making phase enables the decision makers to define the district retrofitting project through the selection of the most sustainable retrofitting solution in terms. To achieve these objectives a structured methodological approach to fulfil all the needs has been developed. At the beginning the planners are able to create scenarios representing a district retrofitting project which are defined by setting measurable targets and objectives for the improvement of the KPIs. The target definition is based on the current state evaluation of the KPIs and is also linked to the e-collaboration platform. All involved stakeholders therefore can participate in the target definition process by giving votes on their targets and priorities.

2.5 Conception of retrofitting variants

After the main objectives for a project have been defined the planners are able to create different retrofitting variants. Therefore, it is possible to select different retrofitting measures on building and district level from a pre-defined selection list. In order to apply only useful and technically feasible retrofitting measures on buildings it is essential to know which retrofitting measures work well or may not work for the buildings or whole groups of buildings. Even though planners of retrofitting variants may have a good knowledge about the feasibility of different retrofitting measures the Methodology supports and guides them in the selection process. Therefore, the IDST provides a comprehensive tool box with several useful analysis functions that help planners in evaluating the feasibility of different solutions. The main challenge for planners in creating energy retrofitting variants for urban districts is to evaluate the impacts of different solutions onto the buildings and the energy supplying infrastructure in the district. Those synergies and interactions between buildings and the district were analysed deeply in the methodology development and can be assessed using the IDST. The provided retrofitting interventions in the IDST repository of technologies are classified according the following categories:

- Reduction of energy consumption (consumer-driven)
- Increasing the efficiency of the energy supply
- Inclusion of renewable energy production

All categories contain several traditional off-the-shelf retrofitting measures as well as new innovative ones at building and district level. On building level, it is possible to apply several envelop improvement measures (adding insulation, replacing windows, etc.), replace HVAC systems by more efficient ones, increase the efficiency of electrical appliances and to include renewable energy sources (photovoltaics, solar thermal systems, CHP, biomass fuel, etc.). On district scale, users can apply improvement measures in the fields of street lighting (LEDs), heating and cooling networks as well as renewable district energy systems (wind turbines, photovoltaic farms) and further. Moreover, planners have the possibility to assess the improvement of non-energy related measures in a scenario like increasing the green spaces in the district or improving the accessibility to public transport stations. The KPIs are simulated and assessed for each variant representing the different applied retrofitting interventions.

2.6 IDST analysis tools and functions

Following special analysis tools and functions to support the variant creation are provided within the IDST:

1. Analysis tool assessing the energetic weak points of buildings

In order to prioritize different retrofitting measures to reduce the energy consumption and to increase the energy efficiency of a building it is necessary to know which represent from an energy view the weakest points of a building. This means the FASUDIR IDST supports the users in identifying the building components or systems which cause the highest energy losses and therefore, have with high probability the greatest energy saving potential. Hence, with the Energetic Weak Points Tool the FASUDIR user is be able to plan the retrofitting measures in a way that allows exploiting the most effective energy savings.

2. Tool assessing the feasibility of heat networks

The FASUDIR IDST provides a function that allows planners to assess the correlation between different retrofitting measures and the capability of heat networks for groups or the whole district. The function in the IDST calculates

for user defined building groups or areas of the district a heat demand density map and visualizes it in 2D and 3D maps. By setting user defined thresholds the function shows the user the areas of a district or a city in which the construction of a heat network can be feasible.

3. Analysis tool for the assessment synergies and interactions between buildings

The functions show the user the time-based load curves of the electricity consumption and the electricity generation (CHP, PV, Wind) of a group of buildings or the whole neighbourhood. Moreover, it allows the user to assess how much electricity surplus is generated at which times to plan smart grids and electricity storages (charge e-vehicles, intelligent appliances).

4. Analysis Tool Assessing Solar potentials of Surface areas on Buildings and free spaces

The function shows the user for each building in the neighbourhood the suitability of roof and façade areas for photovoltaics or solar thermal systems (solar potential).

5. E-Collaboration Platform

The e-collaboration platform in the FASUDIR IDST is the central hub between the planners of a district retrofitting concept and all involved stakeholders and guests. The e-collaboration platform provides the framework to support the stakeholder involvement in each phase of the FASUDIR methodology. The platform is accessible via the main created project website of a district retrofitting project. Therefore, the e-collaboration platform enables the following features for the users:

- Online-Discussion-Forum (Citizen Participation, idea collection, etc.)
- Online Retrofitting Questionnaire (Owners, Tenants)
- Online cloud-based data storage for file exchange
- Front-page for announcements (News, Dates for Physical Workshops)

2.7 Variant assessment for holistic comprising purposes in the decision making process

After planners have created variants the IDST is able to compare the variant to identify the most suitable one according to the set priorities of the decision-makers. In the assessment step of the methodology the users are supported by a decision-support tool. In this function all gathered information, conducted upstream analysis and generated data outputs in the different steps of the variant creation are finally stored in a database. The main input of the variants in the decision-support function is in the form of the KPIs results. The KPI results afterwards are used as core criteria in a value assessment to rank the different retrofitting variants according to the preferences of different stakeholders and decision-makers. Thus, planners of retrofitting concepts have a powerful and logic feature to support the complex decision-making process in energy retrofitting projects for urban districts. In order to be able to conduct a value assessment based on a Multi-Criteria-Decision-Analysis (MCDA) approach the valid variants are ranked according to the preferences and priorities of the decision-makers. For all created retrofitting variants, the different KPIs are simulated by the IDST. To set the priorities the IDST provides a Decision Support Tool which allows the FASUDIR Users to enter their priorities from a list through a plain language entry mask. The plain language entry mask translates priorities in a weighting system. Hence, the weights for the different KPIs in the value assessment are adjusted automatically.

2.8 Project implementation phase

The implementation phase is the last phase of a district retrofitting project in the FASUDIR Methodology. In the implementation phase the best ranked variant of the district retrofitting concept has to be practically implemented. Therefore, it is the longest phase in a district retrofitting project and can last from 2 years up to 20 years or even longer depending on the motivation of the stakeholders and owners. The focus of the FASUDIR Methodology therefore is not the complex work of planning the detailed retrofitting construction process. This task should be done by a retrofitting manager who has the final responsibility for the coordination of the retrofitting construction process. However, FASUDIR supports the complex work of the retrofitting manager by the IDST and the related supporting tools. To achieve this, the IDST provides an update and monitoring function which allows updating and monitoring the current state of the district according to the already implemented retrofitting measures by the owners.

The updated current state can be compared to the targets that have been defined in the scenario. Thus, the retrofitting manager and the represents of the municipality have the possibility to check the current progress during the whole implementation phase. This is very important in order to control the retrofitting progress and to identify obstructions which have negative impacts of the retrofitting work. Based on the results the retrofitting manager is able to develop suggestions for improvements (e.g. new grants, change of the variants) and to recommend them to the stakeholders. Moreover, the achieved successes in the retrofitting project can be shown and demonstrated to politicians, stakeholders and citizens by using the IDST. Furthermore, the IDST supports the retrofitting manager in improving the communication flows between the stakeholders in the implementation phase through the e-collaboration platform. Hence, the retrofitting manager is able to contact all stakeholders in an optimized way via the internet. This facilitates the mediation between different stakeholders which is very important in the implementation process of district solutions.

3. DISCUSSION

In fact, it is very difficult to assess the uncertainties that may occur in district retrofitting concepts. However, the goal of district retrofitting concepts and the district approach in general is not to provide as detailed results and calculations as possible but to help planners and stakeholders to find the right direction for the whole district. As the data collection in a district is not as detailed as for building retrofitting concepts the uncertainties are higher on district level. However, the time effort for the data collection can be reduced by up to 80 % compared to a detailed data collection. Therefore, the Pareto principle states those, for many events, roughly 80% of the effects come from 20% of the causes. If the Pareto Principle is applied to the data collection process for buildings and districts 80 % of the accuracy can be reached with 20 % of the time and cost effort. If the planners need to have 100 % accuracy the time effort for the data collection will be increased by 80 %. FASUDIR therefore is created as a tool for high level insights and therefore takes advantage of the Pareto Principle.

4. CONCLUSION

Besides the planning of concepts, the practical implementation of the measures cannot be done by software tools as a deep interaction and communication between all involved stakeholders is necessary. Hence, the planning and practical implementation of district retrofitting projects is a task that is due to its high complexity still strongly dependent on the human intelligence of professionals and experts. However, the professional planners can take advantage of structured approaches and supporting software tools to make their work more efficient. Against this background the Decision-Support Methodology must be regarded as a stand-alone approach which is not directly coupled to tools or software. This means, that the FASUDIR Decision-Support Methodology in general is applicable without the use of the FASUDIR IDST. However, to follow all steps included in the different phases may need a lot of time and partially be not effective without using appropriate support by the IDST. Vice versa the IDST also cannot be seen as a stand-alone tool. Using the IDST in an appropriate way needs to follow the structured Decision-Support Methodology in order to achieve meaningful and resilient results. Only the joined use of the Decision-Support Methodology and the IDST ensures an efficient work flow and increases the probability for a successful completion of district retrofitting projects. The development of the FASUDIR Decision-Support Methodology and the IDST will significantly improve the currently used methods of operating in district retrofitting projects and **facilitate keeping the EU's "40-27-27" targets for the building sector.**

ACKNOWLEDGMENTS

The research leading to these results has received funding from the European Union's Seventh Programme for research, technological development and demonstration under grant agreement 609222.

REFERENCES

- [1] http://ec.europa.eu/enterprise/policies/raw-materials/files/docs/report-b_en.pdf (18.09.2015)
- [2] <http://fasudir.eu/> (23.09.2015)
- [3] Barbano, Giulia et. al: EU Context for Building Energy Retrofitting at District Scale, 2013; http://fasudir.eu/documents/FASUDIR_WP2_D2.2_EUContextForBuildingEnergyRetrofittingAtDistrictScale_GB11_Delivered.pdf (25.09.2015)
- [4] Zukowska E.; Mittermeier P.; Peyramale V.; et al.: Integration of available Resources in the IDST Approach, 2014; http://fasudir.eu/documents/FASUDIR_WP2_D2_3_IntegrationOfAvailableResourcesInTheIDSTApproach_EZ03_Delivered.pdf (14.12.2015)
- [5] Zukowska E.; Mittermeier P.; Romero A.; et al.: IDST Key Performance Indicators
- [6] http://fasudir.eu/documents/FASUDIR_WP2_D2%204_IDSTKeyPerformanceIndicators_EZ12_Delivered_To%20be%20approved.pdf (12.12.2015)
- [7] KfW-Bank: Quartiere sanieren, <https://www.kfw.de/inlandsfoerderung/Öffentliche-Einrichtungen/Energetische-Stadtsanierung/Quartierssanierung-Förderratgeber/> (12.01.2016)
- [8] Im Auftrag des Bundesministeriums für Umwelt, Naturschutz, Bau und Reaktorsicherheit (BMUB) : Energetische Stadtsanierung, <http://www.energetische-stadtsanierung.info/informationen-fuer-die-praxis/quartierskonzepte/> (12.01.2016)

Session 6.11: Processes, Design, Tools and Methodologies in SBE (4)

Evidence-Based Approach to Calibration of Whole Building Energy Model

LAM Khee-poh^a, Adrian CHONG^b, XU Weili^c

^a Carnegie Mellon University, United States of America, kplam@cmu.edu

^a National University of Singapore, Singapore, bdgkp@nus.edu.sg

^b Carnegie Mellon University, United States of America, zachong@andrew.cmu.edu

^b National University of Singapore, Singapore, zachong@andrew.cmu.edu

^c Carnegie Mellon University, United States of America, weilix@andrew.cmu.edu

ABSTRACT

A systematic procedure for calibrating building energy simulation models has been developed. The proposed method combines analysis of building plans and documentation manufacturers' specifications, data from building sensors and results from EnergyPlus simulation. This paper describes the calibration method that was developed and demonstrates the use of the calibration procedure by applying it to an office building located in Kawasaki, Japan. Data collection took place between July 2015 and February 2016. Data from the months of August November and February were used as test data and used to determine the model's CVRMSE and NMBE. These months were selected to be representative of summer, autumn and winter periods in Japan respectively. The remaining months were used for model training and to determine model inputs. This separation (training and testing data) was done to prevent bias when evaluation the model. Comparison of the simulation results with hourly measured data gave coefficient of variation of the root mean squared error (CVRMSE) values of 14%, 11% and 11% for lighting, equipment and air handling units (AHUs) energy consumption respectively, all of which are below the 30% threshold set by ASHRAE Guideline 14 (2002). In addition, the calibrated model also shows normalized mean bias error (NMBE) values less than 3% when compared with hourly lighting, equipment and AHUs energy consumption.

Keywords: BEM, calibration, model

1. INTRODUCTION

The building sector accounts for approximately 40% of total energy consumption in the United States (U.S. DOE, 2012) and the world (Sisson et al., 2009). Thus, retrofitting existing buildings provides one of the biggest opportunities to reduce energy consumption and CO₂ emissions. Over the past decade, building energy models have been increasingly used in measurement and verification (M&V) for the evaluation of energy conservation measures (ECMs). However, before any ECM can be evaluated, the model needs to be calibrated. With increasing emphasis on the integration between Internet of Things (IoT) and buildings, installation of sensors in buildings is becoming increasingly common, collecting large amounts of information that can be used for controls and retrofit analysis. Significant discrepancies between simulated and actual measured consumption of buildings has also brought about a movement to uncover these discrepancies by analyzing data collected through extensive sensor networks.

In this paper, we present the calibration of an EnergyPlus whole building simulation model using available measured data. The calibration is validated using hourly measurements. The objective of this study is to propose an evidence-based stepwise approach that is deeply related to the collection and analysis of high-resolution data for the model calibration process.

2. METHOD

2.1 Overview

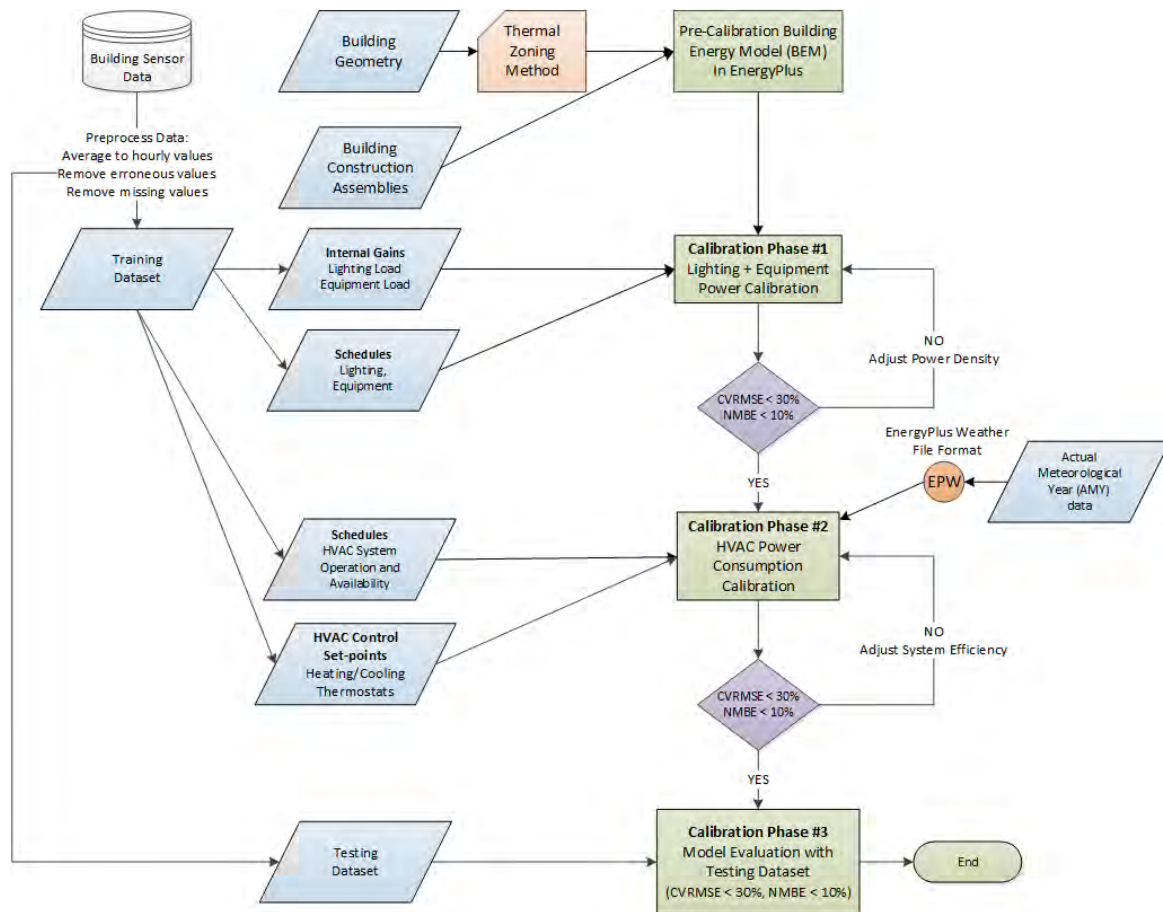

Figure 1: Overview of calibration framework

Figure 1 shows an overview of the proposed calibration framework and is based on the calibration of an EnergyPlus model. The process begins with the standard procedure of building an energy model based on construction documents, design specifications and following the guidelines for a design model Table G3.1 of ASHRAE Standard 90.1 (2010). Before any model calibration, the dataset was preprocessed by removing instances that contains **erroneous values to yield “complete” data sets. These include instances containing missing values, negative power consumption and temperature beyond reasonable values.** To over-fitting the energy model and reduce bias in the calibration process, the processed dataset is split into two sets; a training dataset for building the model and another testing dataset for validating the accuracy of the trained model.

The calibration process can be separated into three phases, (1) calibration of internal loads, (2) calibration of HVAC system, and (3) model validation with testing data (Figure 1) and can be summarized as follows:

- Calibration of internal loads (lighting and equipment power consumption)
 - Analyze hourly power consumption of internal loads to determine resolution of schedule to set for each component of the internal loads
 - Determine maximum power consumption from data collected
 - Use analysis from (1a) and (1b) to set the schedule and the design power consumption
 - Iteratively tune design power consumption until CVRMSE and NMBE for internal load energy consumption is less than 30% and 10% respectively (ASHRAE Guideline 14, 2002).

- Calibration of HVAC system
 - Identify inputs to the EnergyPlus HVAC object. For calibration of HVAC systems, it is important that actual meteorological year (AMY) weather files be used. AMY files contains hourly weather data over the time period of the calibration and should be obtained from a weather station that is closest to the building of interest.
 - Use documentation of the simulation tool to determine how the measured data could be used to derive inputs to the energy model. Two typical inputs to an EnergyPlus HVAC object are performance curves, which give the systems efficiency at off-reference conditions, and availability schedules which can be used to model the **system's operation**. **For performance curves: apply least square regression to measured data to derive coefficients that would be used as inputs to the energy models.**
 - If measured data is not available, extract required information from construction documents and design specifications
 - Iteratively tune HVAC system efficiency until CVRMSE and NMBE for HVAC energy consumption is less than 30% and 10% respectively (ASHRAE Guideline 14, 2002).

Validate the calibrated model by computing the model's CVRMSE (Equation 1) and the NMBE (Equation 2) on the testing dataset. The model is considered calibrated if CVRMSE and NMBE meets the threshold of 30% and 10% respectively (ASHRAE Guideline 14, 2002).

$$CVRMSE = 100 \times \left[\sum (y_i - \hat{y}_i)^2 / (n - p) \right]^{1/2} \bar{y}$$

Equation 1

$$NMBE = \frac{\sum (y_i - \hat{y}_i)}{(n - p) \times \bar{y}} \times 100$$

Equation 2

2.2 Building description

As an illustrative example, we apply the calibration method to the 9th floor of a building located in Kawasaki, Japan. The calibration would be demonstrated for the internal loads (lighting and equipment energy consumptions) and the air handling units (AHUs). The 9th floor of the building is mainly made up of an open floor office and can be divided into 9 zones (Figure 2). Each zone aside from the core is also installed with sensors that measure, zone temperature, lighting, plug and process loads. Ventilation is supplied to each zone (except the core and IS zone) by individual variable air volume (VAV) AHUs. No ventilation is supplied to the core zone while ventilation to the IS zone is jointly supplied by the AHUs that supplies outdoor air to the N, S and W zones. Data collection took place between July 24th, 2015 and February 24th, 2016 at 1-minute intervals. The data collected were averaged to hourly values. Data from the August 2015, November 2015 and February 2016 were separated and used to form the testing dataset while the remaining months used form the training dataset. These months were selected to be representative of summer, autumn and winter periods in Japan respectively.

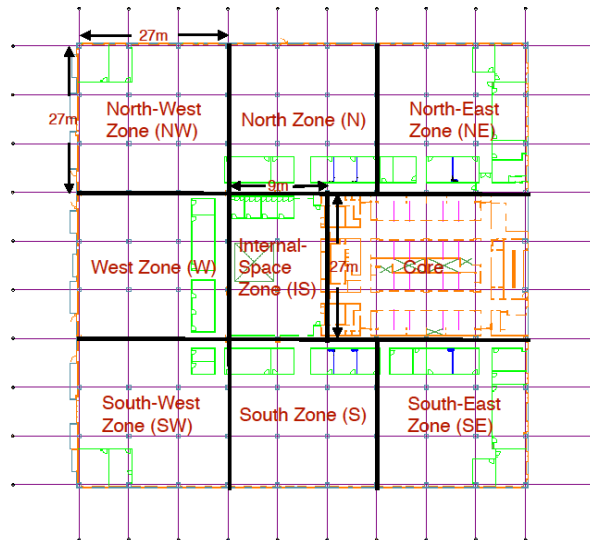

Figure 2: Insert figure of floor plan (9 zones)

3. INPUTS TO MODEL

3.1 Internal Loads

The EnergyPlus objects used for the calibration of lighting and equipment energy consumption are the “Lights” and “ElectricEquipment” objects respectively (UIUC and LBNL, 2015a). Both EnergyPlus objects are similar in that they compute energy consumption by multiplying an hourly schedule by the design power density. A first step in this process would therefore be to determine the appropriate resolution of schedule to set. This is done via data exploration of the measurements for lighting and equipment power consumption of each zone (Figure 3 and 4). Figure 3 shows four distinct trends in lighting power consumption. It can be observed that mean lighting power consumption is highest during weekdays followed by Saturday, Holidays and Sundays. Figure 3 indicates that a 24-hour schedule that represents each of the four trends (weekday, Saturday, Sunday and holidays) would be most appropriate when modeling lighting power consumption in an energy model. On the contrary, from Figure 4 it can be observed that there is a more distinct separation between the weekdays mean equipment power consumption. To better represent this difference, a 24-hour schedule for each day of the week (Monday to Sunday and Holidays) was used. The design power density was computed by dividing the maximum measured power consumption by floor area.

3.2 Air-Handling Units (AHUs)

The main components of the AHU are the variable speed fans and the cooling and heating coil. The EnergyPlus objects used to model the AHU are the “Fan:VariableSpeed”, “Coil:Cooling:Water” and “Coil:Heating:Water” objects (UIUC and LBNL, 2015a). Since the target of this model calibration is energy consumption, the focus would be on the calibration of the AHU fan. Equations 3 to 5 shows how fan power consumption is calculated by EnergyPlus (UIUC and LBNL, 2015b). f_{flow} denotes the flow fraction, \dot{m} is the air mass flow (kg/s), \dot{m}_{design} is the design (maximum) air flow (kg/s), ΔP is the fan design pressure increase (PA), e_{tot} is the fan total efficiency, and ρ_{air} is the air density at standard conditions (kg/m³). Table 1 shows the inputs to the Fan:VariableSpeed EnergyPlus object and summarizes how their values were computed using measurements of fan power and airflow rate.

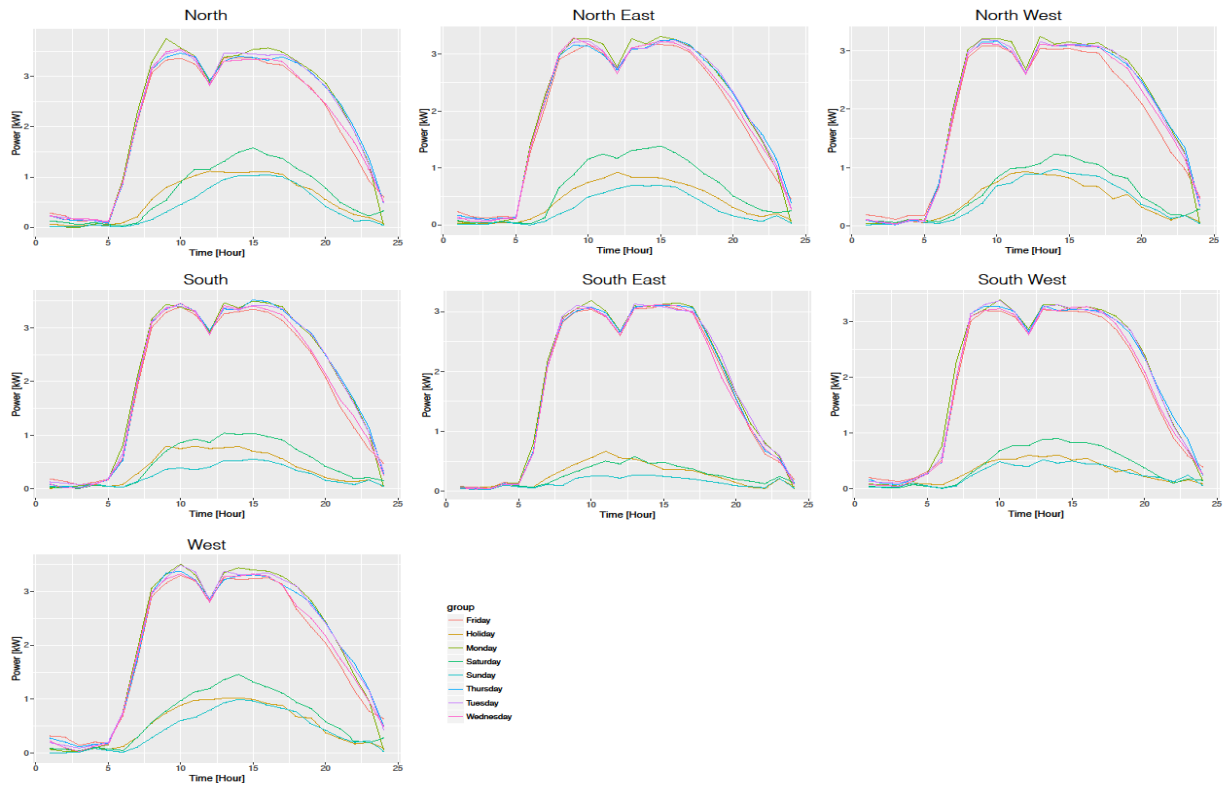

Figure 3: Plot of average (mean) lighting power consumption at different hours across different days

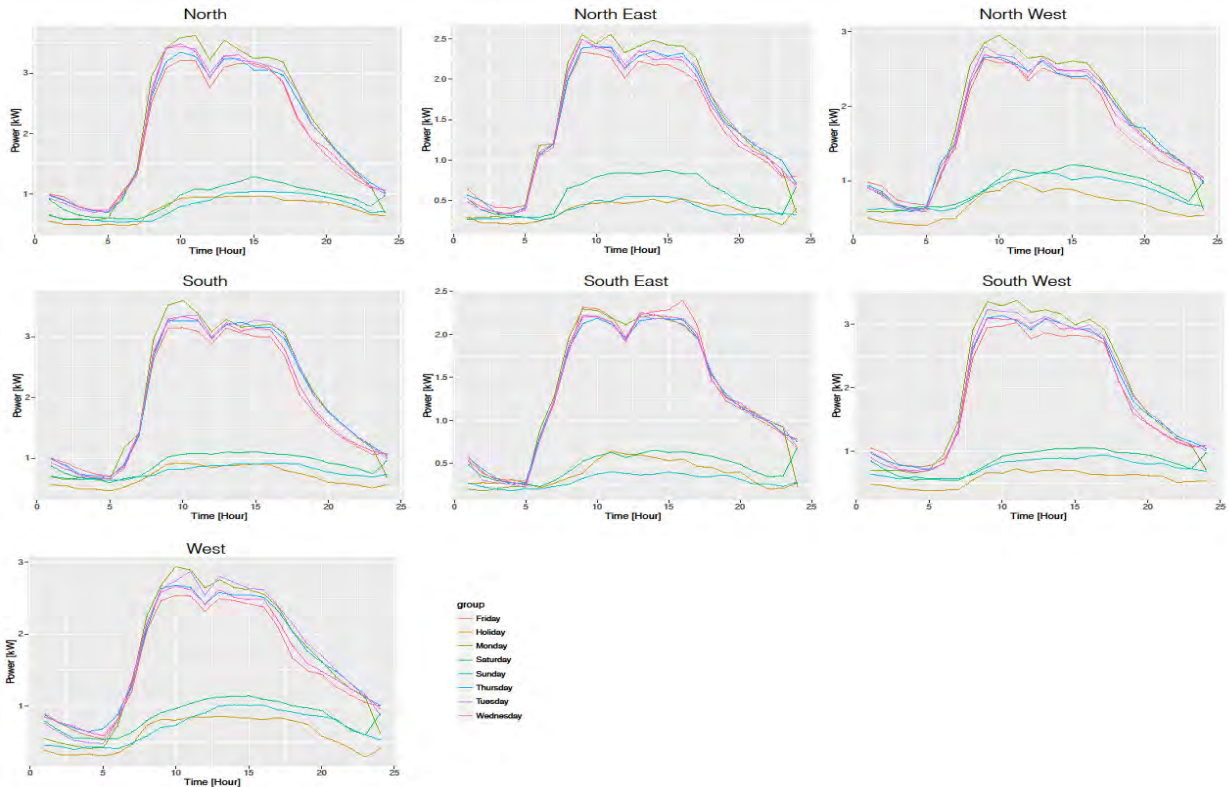

Figure 4: Plot of average (mean) equipment power consumption at different hours across different days

Parameter	Method used to compute parameter value
Fan Total Efficiency	Average fan efficiency computed from air flow measurements, fan power measurements and pressure rise from manufacturer's specification (Equation 5)
Pressure Rise (Pa)	Manufacturer's specification
Maximum Flow Rate (m ³ /s)	Maximum airflow rate that was measured
Fan Power Minimum Air Flow Fraction	Ratio of minimum measured airflow rate to maximum measured airflow rate
Motor Efficiency	Given value of 1 since motor inefficiencies are accounted for in measurements of airflow and power
Coefficients of Fan Power Curve (Equation 4)	Least square regression using measurements of air flowrate and fan power consumption. The independent variable (f_{flow}) is derived from measured air flowrate as the ratio of air flowrate to the maximum airflow rate. The dependent variable (f_{pl}) was derived from measured fan power consumption as the ratio of fan power to the maximum fan power.

Table 1: Inputs to EnergyPlus Fan:VariableSpeed object

$$f_{flow} = \frac{\dot{m}}{\dot{m}_{design}}$$

Equation 3

$$f_{pl} = c_1 + c_2 \cdot f_{flow} + c_3 \cdot f_{flow}^2 + c_4 \cdot f_{flow}^3$$

Equation 4

$$\dot{Q}_{tot} = f_{pl} \cdot \dot{m}_{design} \cdot \frac{\Delta P}{e_{tot} \cdot \rho_{air}}$$

Equation 5

4. EVALUATION OF CALIBRATED MODEL

Two approaches were used for the evaluation of the calibrated model and they are: (1) CVRMSE and NMBE, and (2) hourly time series plot of measured power consumption and predicted energy consumption. We include a graphical time series comparison of measured and predicted energy consumption to identify any possible deviations in hourly patterns that might not be captured by error indices such as CVRMSE and NMBE. Table 2 shows the CVRMSE and NMBE for the total lighting, equipment and AHU energy consumption. CVRMSE and NMBE are computed using testing data to check the model for overfitting and prevent large biases in the calibrated model. It can be observed that CVRMSE and NMBE are below the threshold of 30% and 10% respectively (ASHRAE Guideline 14, 2002). Figure 5 shows the comparison between measured lighting, equipment and AHU energy consumption and model predictions. From the plots it can be observed that there are slight overestimation and underestimation of energy consumption across the testing data. This explains the low NMBE (< 3%) for all components. Figure 5 also provides visual confirmation that predictions by the calibrated model is able to capture the trends in the observations.

Component	CVRMSE (%)	NMBE (%)
Lighting Energy Consumption	14.01	1.47
Equipment Energy Consumption	10.68	-0.005
AHU Energy Consumption	11.48	-2.35

Table 2: CVRMSE and NMBE

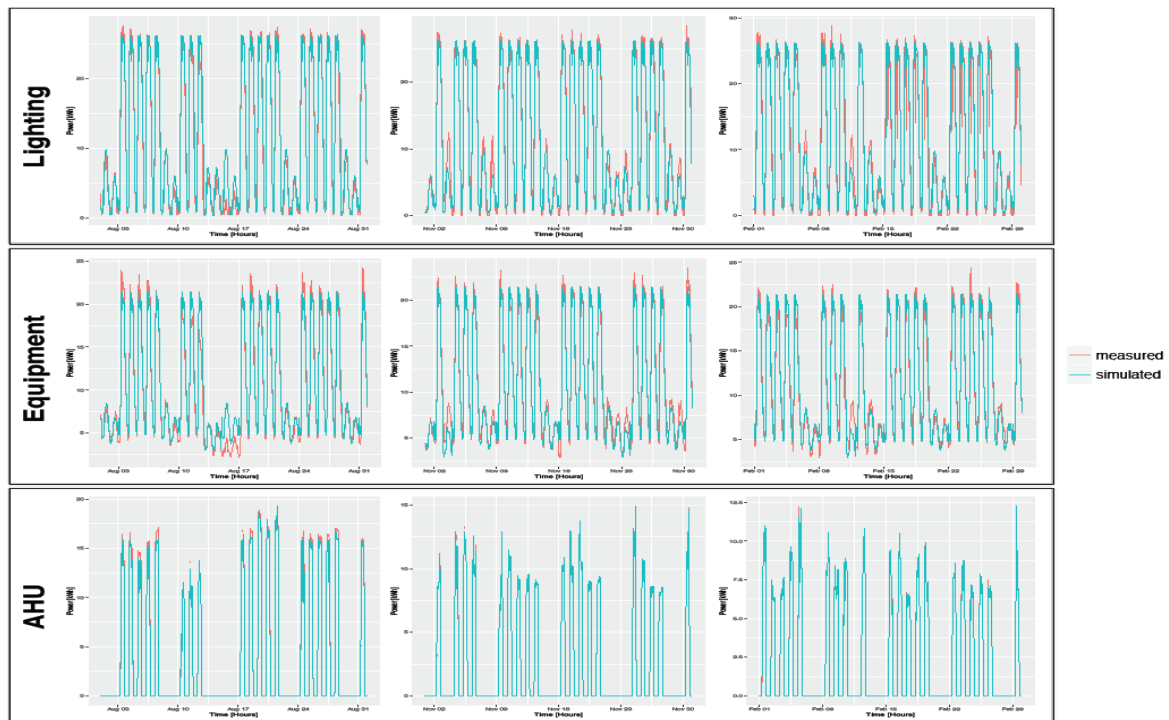

Figure 5 Comparison of measured data and model prediction using testing data

5. CONCLUSION

This study provides details on the calibration of a whole building EnergyPlus model of a building located in Japan using hourly detailed sub-metered data. The proposed stepwise method starts with the calibration of internal loads, followed by HVAC energy consumption and ends with evaluation of the models accuracy using a testing dataset to prevent overfitting and avoid large biases in the energy model.

The model's prediction was compared to hourly measured data to ensure that the model represents actual building operation more accurately as compared to calibration with monthly data which is more commonly used for the calibration of building energy models. Graphical time-series plots also shows good agreement between the model prediction and the measured data, illustrating that the model is able to capture hourly patterns in the measured data. Overall, the final model shows good agreement with the testing dataset, demonstrating the effectiveness of the proposed method. However, the calibration process is still an iterative manual process that would take considerable time and resource. For practical applications, future work is still needed in the following areas: (1) a systematic framework to sensor installation and measurements in buildings, and (2) automation of calibration process.

REFERENCES

- [1] Ashrae Guideline 14 2002. Measurement of energy and demand savings. ASHRAE Guideline. Atlanta, GA: American Society of Heating, Refrigerating and Air-Conditioning Engineers, Inc.
- [2] Ashrae Standard 90.1 2010. Energy standard for buildings except low-rise residential buildings. ASHRAE Standard. Atlanta, GA: American Society of Heating, Refrigerating and Air-Conditioning Engineers, Inc.
- [3] Sisson, W., Van-Aerschot, C., Kornevall, C., Cowe, R., Bridoux, D., Bonnaire, T. B. & Fritz, J. 2009. Energy efficiency in buildings: Transforming the market, Switzerland.
- [4] U.S. Doe. 2012. Buildings energy data book [Online]. Retrieved from: <https://www.btscoredatatbook.net/ChapterIntro1.aspx> [Retrieved on 15 October 2016].
- [5] Uic & Lbnl 2015a. EnergyPlus input output reference: The encyclopedic reference to EnergyPlus input and output, USA, U.S Department of Energy.
- [6] Uic & Lbnl 2015b. EnergyPlus engineering reference: The reference to EnergyPlus calculations, USA, U.S Department of Energy.

International LCA Data Network - Demonstration Project for an Open International Online Database Structure

Tanja BROCKMANN^a, Hildegund FIGL^b, Oliver KUSCHE^c

^a BBSR Federal Inst. for Research on Building, Urban Affairs and Spatial Development, German, tanja.brockmann@bbr.bund.de

^b IBO Austrian Institute for Building and Ecology, Austria, hildegund.figl@ibo.at

^c OK OKWORX, Germany, ok@okworx.com

ABSTRACT

The open international online database structure for LCA of building materials shall allow open access to EPD (environmental product declaration) data from all participating databases. The way these EPD data can be used, e.g. within certification schemes or for LCA at building level, nonetheless can follow national rules. This undertaking calls for a high transparency of data content and data quality.

In many European member states national EPD programmes in conformity to EN ISO 14025 were established, producing EPDs in conformity to EN 15804. In order to use EPD data for LCA at building level, the EPD data needs to be available in a database in machine readable form. The independent development of these databases brings the risk of a great variety of data formats and thus the danger of incompatibility of data. Additionally, the Product Category Rules (PCRs) differ from one programme to the other, as for some aspects EN 15804 gives only a frame.

In order to overcome these problems, a project has been launched by the German BMUB/BBSR (Federal Institute for Research on Building, Urban Affairs and Spatial Development) which shall demonstrate the concept and implementation of an open international LCA-database network for EPDs. Starting point is the already existing infrastructure around the database ÖKOBAUDAT established within the Assessment System for Sustainable Building (BNB). These existing tools have to be adapted in order to meet the challenges of an open international data network.

The project is based on various precedent projects and will be finished in August 2017. Results of the project are a conceptual framework as well as a concept for the necessary technical applications and a technical implementation on lab level for demonstration purposes.

Keywords: EPD (environmental product declaration), building materials, databases

1. INTRODUCTION

1.1 Motivation

Life cycle assessment (LCA) at building level has become a widely used methodology to assess resource consumption (e.g. primary energy) and environmental impacts (e.g. contribution to global warming) of buildings over their entire life cycle. The basic building product data for such LCA are provided in form of environmental product declarations (EPD). In many European member states, more and more EPDs are produced by manufacturers and trade associations, commonly within a national EPD programme according to EN ISO 14025 [1]. Most of the programme operators in Europe follow also the core rules for construction products laid down in EN 15804. In spite of the considerable standardisation work during the last few years, the product category rules (PCR) differ between programmes, as for many aspects EN 15804 rather provides a framework than distinct specifications. Hence, questions arise concerning the consistency of data in applying EPD in the assessment and environmentally driven optimisation of buildings.

Until now, programme operators run their own information systems for EPD data mainly in form of product lists supplemented by PDF documents. On the other hand, using EPD data in LCA at building level calls for EPD data provided in a machine readable form, which has led to different initiatives for databases in many member states. As building products are used within the European or global market, it is to emphasise that there is a great interest to use data from different EPD program operators for LCA at building level. The independent development of local databases however leads to the risk of a great variety of data formats and thus possible incompatibility of data.

A high transparency of data information (such as origin of data, validity of data, applied scenarios etc.) and data quality (e.g., verification, categorisation etc.) is needed to support a sensible use of data in subsequent LCA calculations. Furthermore, a common technical framework is required in order to facilitate data exchange.

1.2 Objectives of the demonstration project

The project launched by the German BMUB/BBSR (Federal Institute for Research on Building, Urban Affairs and Spatial Development) shall demonstrate the concepts and implementation of an international open LCA-data network structure for construction products based on EPD information. This data network structure shall allow the exchange of EPD data and offer open access to EPD data from all participating databases and tools. At the same time, the use of these EPD data (e.g. within certification schemes or for LCA at building level) nonetheless shall be able to follow national rules. This undertaking calls for a high transparency of data information and quality, which shall be ruled by a conceptual framework. Furthermore, a common basis regarding the technical framework is required, e.g. software and interfaces.

Starting point shall be the already existing infrastructure around the database ÖKOBAUDAT which had been established within the Assessment System for Sustainable Building (BNB). These existing tools have to be adapted in order to meet the challenges of an open international data network – in conceptual and technical means.

The project is based on various precedent projects and shall be finished in August 2017. Result of the project shall be a conceptual framework and a concept for the necessary developments concerning the technical applications. The achievements are meant to be a contribution to support ongoing harmonisation efforts on international level and serve as a live example how a data network for EPD data could be implemented and used in practice. The objectives are to make the stack of existing tools fit for international networking with focus on multilanguage and handling of data quality declarations as well as to identify and possibly fix any technical and procedural gaps. In the demonstration phase the data network will be on the ÖKOBAUDAT website but shall be transferred to a common website later on.

2. METHODOLOGY

2.1 Approaches to achieve the conceptual deliverables

An open data network implies a precise definition of mandatory and additional information as well as a common understanding of calculation rules, verification procedures and data quality. Working steps are:

- The conceptual framework developed for ÖKOBAUDAT [3, 4] shall be used as a starting point.
- Differences in the concepts of the cooperating data deliverers and the interpretation options in handling the normative requirements shall be analysed.
- A comprehensive conceptual framework concerning data sources, formats and other aspects of data quality shall be delivered, considering
 - Results from the ongoing UNEP-SETAC Life Cycle Initiative's GLAD network, especially working groups Nomenclature and Metadata descriptors of data quality
 - Requirements of several further database operators and application
- Based on the conceptual framework, a technical system shall be implemented.

2.2 Cooperation – working group "International Open Data Network for Sustainable Building"

In order to develop a harmonised and consistent way of using material and product relevant LCA or EPD data for **the LCA of buildings, in March 2015 a working group "International Open Data Network for Sustainable Building (InData)" was founded. The main objective of WG InData is to establish an International LCA data network structure** for construction products based on EPD information. Its members are EPD programme operators, LCA data providers, LCA database operators, LCA format developers, federal institutions and building assessment operators. The mode of operation comprises network activities and bi-lateral co-operations. Currently six countries (Austria, Belgium, Denmark, Germany, Norway, and Spain) are represented [5, 6]. The conceptual framework for the data network structure shall be elaborated together with the WG InData.

3. DELIVERABLES

3.1 InData survey

A survey has been undertaken beyond the members of the WG InData in order to find a common understanding of aim and actions of the group [7]. 20 representatives were invited to take part, 8 questionnaires from 6 member states (Germany, Austria, Belgium, Denmark, Spain and Norway) came back. The posed questions concerned conceptual approaches and status quo in the represented countries. The survey brought about that a combined nearly 4000 datasets could be delivered by five InData members (IBU, BBSR, baubook, IETCC, EPD Norway). The methodologically motivated questions lead to a decalogue [5] actually consisting of 12 commandments which will guide the future work of the working group and form the basis for the conceptual framework of the data network structure.

3.2 Conceptual framework

The essential elements which have to be covered in the conceptual framework are

- Objective of the open data network structure
- Standardisation schemes to use
- Core information, classification and meta information
- Data quality (options/ scale)

Objective of the open data network structure

The open LCA data network structure for construction products based on EPD information shall allow the exchange of EPD data and offer open access to EPD data from all participating databases and tools. This requires agreements about data format and interfaces in order to ensure compatibility. The system should offer compatibility with subsequent applications and tools such as LCA tools, building information modelling (BIM), and others. Nonetheless, national databases shall be able to maintain their identity. They can use different webpages of information, software database platforms and technology.

Standardisation schemes to use

EN 15804 shall be the common ground to start. It is not the aim to develop additional rules complementing the standards, but complementary information will be defined for classification of products (Generic, average, BIM codes, etc.).

A common approach to product categories and hierarchies is crucial. In consideration of the estimated rapid implementation of building information modelling (BIM), the building smart Data Dictionary (bsDD) shall be used as the reference.

The ILCD data format shall be used as data exchange format (See technical deliverables).

Core information, classification and meta information

All the data involved shall contain at least a common core of information which shall be oriented on EPD data according to EN 15804. All the information shall be available in English and optionally complementary in other languages. National additional information shall be possible, but will not be supported by the network structure.

It is necessary to have a common classification system for specific types of attributes, e.g. the representativeness of EPD data classified as being specific, average, representative, or generic.

Other types of attributes need additional information allowing to estimate the validity of data (e.g. background databases, sources of information, hypothesis, description of procedures and scenarios).

Data quality (options/ scale)

Data quality is a crucial point in the data network structure and shall be identifiable by the user. One option is to guarantee a high level of data quality by qualitative assessment of data as it is carried out by the ÖKOBAUDAT operators. The other option is a transparent communication on the data quality, giving the responsibility to the user of the database to decide which data they prefer and how they use it. For the second option it might be helpful to develop a classification in the sense of level of data quality. Anyhow WG InData decided to define a minimum common quality level of the data. For example, third party verification of data according to EN 15804 shall be mandatory. Competences of the EPD verifiers in the product family, in LCA and in environmental verification (and in the relevant standard) shall be prescribed.

3.3 Technical deliverables

Data format

In the course of a revision of the ÖKOBAUDAT database, its underlying data format has been revised to use the widely-adopted ILCD data format with a few extensions which allow modelling of the information in compliance to the EN 15804 standard. It has to be underlined that the data format itself does not impose any rules with regard to data quality, but merely provides a technical means of storing and transporting information in a structured way.

Multilingual data

In practice, a multilingual dataset will usually contain information in English and one other local language.

Having been designed specifically for data exchange in an international context, the ILCD data format provides built-in multi-language capabilities that allow for storing the textual meta information of a dataset such as process name, general comment, technology description, use advice etc. in an arbitrary number of languages while at the same time yielding only one single physical dataset. In past projects related to the ÖKOBAUDAT database, a set of tools has been developed or adapted in order to cover the entire data life cycle from data generation over data distribution to applications that use the data for building LCA calculations. So far these have only been used with datasets in German. In order to support international data exchange activities, these tools are to be modified in order to support processing multilingual data.

Being designed as a general-purpose tool for distribution of LCA data with native storage of the data in the ILCD data format, the underlying soda4LCA software) already provides a large set of features in order to handle multilingual data. Nevertheless, the networking features of soda4LCA were so far only used in context of one language).

The openLCA software tool which is able to create and export EPD datasets in the format described above is currently limited to a single language at a time. Emphasis within the project with regard to the openLCA software is on extending it in order to support adding information in a second language to a dataset. This would be especially useful in situations where an EPD or a generic dataset which is supposed to be shared on an international level is only available with textual information in a local language and is to be complemented with English translations of the existing textual information.

Simulating data networking on lab level

In order to identify and fix any technical issues, a data network with multilingual data is simulated on lab level. For the lab setup, at least three individual nodes are set up to simulate different data providers (Figure 1). These nodes are then populated with bi- or multilingual datasets which are either synthetically created just for the testing purposes or obtained from interested international partners who provide bilingual data for this project. Defined use cases are then executed, such as locally searching and browsing data on a node and performing a distributed search on the entire network.

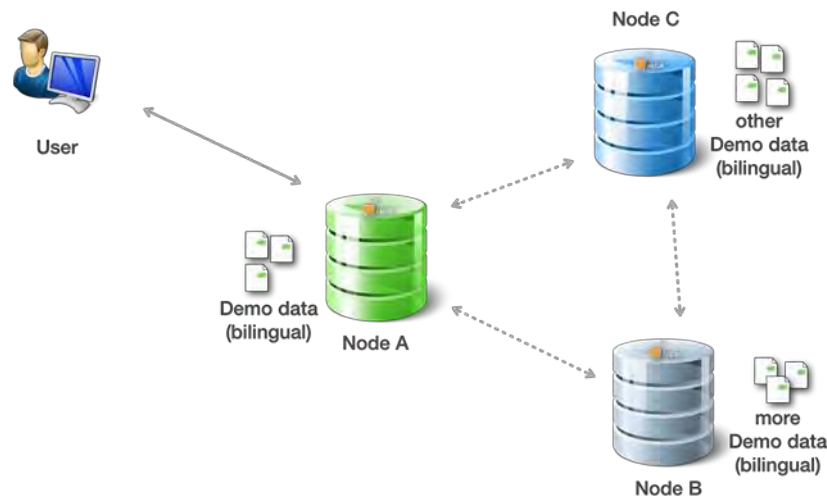

Figure 1: Lab setup for a multilingual data network

Data quality labelling

When datasets originating from different domains are to be shared among a wider audience, it is important that potential users of the dataset can easily identify the original purpose and quality scheme it has been made for as well as optionally other quality schemes it may be compliant to.

In the ILCD data format, a built-in mechanism is foreseen to indicate adherence to one or multiple compliance schemes by simply declaring any applicable compliance systems (which basically is a set rules that the data has to adhere to) within the dataset. This declaration includes a reference to a source dataset representing the compliance scheme which may in turn reference further information such as a document or web site with a more detailed.

For the application scenario of an international data network on EPDs, this mechanism can be used to declare the conformity to EN 15804 and in addition any quality schemes that impose further rules on data quality, such as the BNB system that the ÖKOBAUDAT originally was designed for and which is described in [9]. An example for the declarations that a dataset could carry is given in Figure 2. The declared quality systems can even be disjoint, as long as the dataset actually conforms to each one of them.

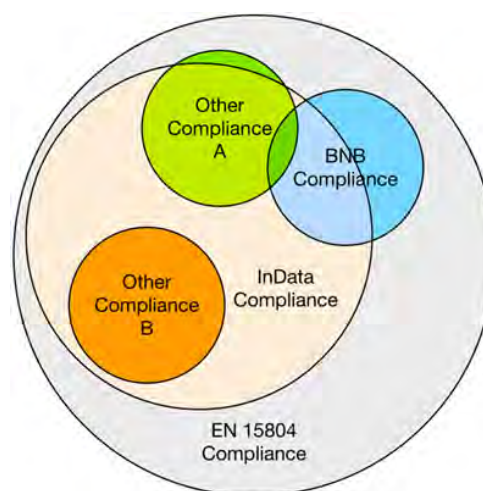

Figure 2: Relationships of different compliance schemes

With such declaration in place on dataset level, it easily can be identified which quality schemes a dataset qualifies for. A user interface for a node or for the network search interface can then allow for searching or filtering for specific quality schemes, enabling users to quickly find data that meets their requirements.

4. CONCLUSIONS AND OUTLOOK

In the paper, the development of an open network structure of LCA data for building products based on EPD information is presented. The idea behind the described developments is the vision of an open data network, where independent national databases are linked to each other with open search and use of data with a common data format. Yet, each data provider will have the opportunity to set up own national rules for the use of data in subsequently used LCA tools, or other processes. This is a great chance for the idea of a consistent and comparable establishment of LCA within the context of sustainability considerations in the construction sector.

REFERENCES

- [1] European Standard EN 15804 - Sustainability of construction works - Environmental product declarations - Core rules for the product category of construction products.
- [2] EN ISO 14025 – Environmental labels and declarations – Type III environmental declarations, principles and procedures (ISO 14025).
- [3] ÖKOBAUDAT Principles of acceptance
- [4] ÖKOBAUDAT manual
- [5] <http://www.oekobaudat.de/en/info/working-group-indata.html>
- [6] Hamburg paper
- [7] Tenorio Ríos J., Otero Sesana S.: Survey Report. International open Data Network for Sustainable Building. 08.03.2016
- [8] Kusche O, Döpmeier C, Braune A, Brockmann T, Rössig S: Extending the ILCD Format to Support Environmental Product Declarations of Construction Products. In: EnviroInfo Hamburg. Aachen : Shaker Verlag, 2013, S. 399–406. – ISSN 8440-1676
- [9] Brockmann, T., Kusche, O., Rössig, S.: Life Cycle Assessment within BNB – Online-Tool eLCA and materials database ÖKOBAU.DAT, World Sustainability Conference WSB 14, Barcelona, Spain, 28.-30. Oktober 2014
- [10] Döpmeier C, Kusche O, Brockmann T, Rössig S, Ciroth A, Lode T. Towards a Complete Tool Chain for Eco-Balancing Governmental Buildings. In: BIS-Verlag; 2014:173-180.
- [11] Kusche O, Döpmeier C, Recchioni M, Mathieux F: Creating LCA Data Exchange Networks. In: EnviroInfo 2012 Dessau. Aachen: Shaker Verlag, 2012, S. 525–532. – ISSN 8440-1248
- [12] Wolf M-A, Pennington D, Chomkham Sri K, Pant R, Pretato U, Bersani R. ILCD format - scope, development, compatibility. Ispra, November 2008.
- [13] KIT - IAI - Service-Oriented Database Application for LCA (soda4LCA). <https://www.iai.kit.edu/soda4LCA/>

Noise Impact Assessment Study on High-performance of Sound Insulation for Residential Building at Neighboring Taiwan High Speed Rail Station

LIN Wei^a, CHIANG Wei-hwa^b, HUANG Dan^c

^a Dep. of Interior Design, Hwa Hsia University of Technology, Taiwan, wellin@cc.hwh.edu.tw

^b National Taiwan University of Science and Technology, Taiwan, whch@mail.ntust.edu.tw

^c Hwa Hsia University of Technology, Taiwan, dan@cc.hwh.edu.tw

ABSTRACT

Taiwan High Speed Rail (THSR) has become a major north-south public transportation systems, a day round trip of life style is a growing trend. Due to the business district be vigorously developed which is surrounded and alone rail station, residential building also will develop and become another form of satellite communities. On security considerations facilities and transport quality in the relevant law regulation, the less than 30 meter restriction of construction regulations may be conducted. Noise Environmental impact will certainly affect the subsequent use and operation of the residential building, in order to ensure the future of indoor comfort and health indicators, the present study was to investigate the noise effect in the process of generated from high-speed rail transportation, to plan the corresponding acoustical performance of residential building construction which is in the region of surrounded location at around THSR station, thereby providing future making decisions and reference basis for the architectural design team.

Keywords: high-performance of sound insulation, indoor environmental quality, adaptable design

1. INTRODUCTION

The influence of sound on the space environment and people's emotional perception and reaction is directly mentioned that the environment is a passive energy transmission, it all the time affect the physiological, psychological, cognitive behavior of related senses. Annoying noise interference is actually more serious, when the living environment is not ideal, leading to speech message may not be a good transmission, it will cause displeasure. Sound insulation performance of buildings is usually enhanced through rigidity, resonance, quality, and critical frequency (critical frequency (fc)) and other physical factors to control its performance. Based on the law for conservation of energy, if the energy loss is caused by passive transmission in the critical frequency zone, even if the boards are double-wall or compound structure, the low-frequency sound insulation effect is still limited, especially in ventilated openings. Bao et al. suggest that mass-air-mass resonance in the low-frequency section of a double-wall structure is another type of noise reduction. Resonance effects can often be reduced by using sound-absorbing materials or by increasing damping. Even if the high-performance material made by the micro-perforation principle has been used in the present age, it is not easy to control the double-layer glass facade (low resonant frequency) structure, so the low-frequency part of the sound insulation performance is also poor. General building structure for the sound of low-frequency performance will not be able to effectively isolate the sound energy. In the case of uncertainties in the noise source and the receiving point, the control of the noise propagation path of the high-speed railway line sound source becomes important. In particular, up to 250 kilo meter per hour of high-speed rail train through close to the station may enlarge noise sound by the impact of the perturbed energy which is the main focus of this study. In Taiwan, a regulation on the correspondence between the height of vertical noise walls and the horizontal distance of land transportation has been made. The noise of LAeq (dB) will exceed the ambient volume standard value within 6 meter from the orbit side, and the L_{Amax} (dB) is still 75 ~ 80dB at 40m when the train passes through the building. In addition, the high-speed rail along the noise map, Kriging method can be drawn better results, according to the questionnaire survey pointed out that the high-speed rail from the centreline within 100 meters, is more serious noise interference in the region. To meet the residents of the feelings, the Taiwan high-speed railway L_{Amax} (dB) recommended value of 70dB is more suitable. From the above we can see, such as low-frequency diffraction, vertical and horizontal sound source and high-rise building sound source impact surface, and no consistency discussed. Taiwan high-speed railway was completed in October 2005, the driving speed of about 250km / hr, due to high-speed driving under the noise intensity will increase with the speed increase. Germany's ICE noise peak level is 85 to 93 dB compared to other national standards; France's TGV

noise peak level is 97 dB; Japan's Shinkansen has a noise peak level of 85 to 90 dB at 200 kilo meter per hour. The environmental vibration caused by high-speed railway is affected by many factors, and the distance and geological conditions are the main factors affecting the vibration level. At the same time, in order to maintain the living environment of residents in peace along the high-speed railway, high-speed railway set the maximum recommended value, After two years later, high-speed rail operated the noise nuisance petition events still emerge in an endless stream. In the research of Professor Wang found that 80 high-speed rail noise from the monitoring results, eight points of LA_{max} (dB) exceeded the time standard value, four points of the LA_{eq} (dB) also exceeded the standard, the report pointed out that the use of LA_{eq} and LA_{max} (mean) Regulation still does not adequately reflect the noise impact of the majority of the petitioners. Sound Exposure Level (SEL) and LA_{max} (mean) of the difference can be explained. The SEL system considers both the time and energy of the noise event and compresses the time of occurrence and conversion to one second to maintain the corresponding noise level. The peak-to-peak LA_{max} of the two typical high-speed TGV and Eurostar trains at different vehicle speeds differ by 4 dB (A). When converted to SEL, both are 93.8 dB (A).

In order to meet the high-speed railway station area in the special settings, the region is designated as a specific area of traffic land, land use will play a convenient transportation function as the main objective, the overall planning concept includes high-speed rail transport efficiency, enhance regional transportation condition. Specific area plans include adjacent residential areas, high-speed railway train running on both sides of the railway environment will produce noise pollution, mainly in the surrounding residents of sleep interference, followed by residents of the heart, as well as the interference of learning and work. Therefore, the control of high-speed railway noise pollution for the environment is another important task. The purpose of this study is to evaluate the impact of high-speed railway noise on high-rise buildings in Taiwan, and to explore the noise impact of high-speed rail vehicles, and to provide the basis for the application of noise protection measures and the noise control standards of exclusive high-speed railway. The purpose of this study is the following four points:

- When the high-speed railway through the station body, the noise generated by the impact of sound energy, through monitoring to explore the impact of ambient sound and the sound of the multiplication effect.
- Through the simulation analysis results, corresponding to the combination of wall structure model to provide follow-up study of reference.
- Based on field measurement survey, summarized the sound field distribution around high-speed rail station.
- The research results may provide the basic research data on the noise intensity regionalization and high-performance residential planning strategy for the around the high-speed railway stations.

2. RESEARCH METHOD

According to CNS 7183 noise level measurement method, the noise meter complies with the national standard (CNS 7129) Type 1 or the International Electrotechnical Society standard Class 1, measuring the points of the test points more than 2 minutes of the frequency (20 to 20000Hz) Pressure level, noise The analyzer is set to Fast mode. The sound field focused on monitoring through the instantaneous acoustic energy to a single high speech train, and can outline an equivalent level LA_{eq} (dB) described volatility sound energy. Record result following two evaluation indicators, including the volume of noise can process the event (equivalent) LA_{eq} (dB) and the maximum volume (Maximum) LA_{max} (dB). In frequency-weighting, this measurement method shall be weighted by A, and the measurement shall be noted with the weighted name used for field measurement. In addition, the dynamic characteristic uses the Fast (F) characteristic in principle, but the Slow (S) characteristic can be used when the sound generated by the sound source is not fluctuant. As indicated by the average sound pressure level shown in Equation (1):

$$L_{Aeq} = 10 \log \left(\sum_{n=20Hz}^{20kHz} 10^{1/10 L_{eq}} \right)$$

Equation 1

2.1 Monitoring environmental sound field in the perimeter of Hsinchu high speed rail station

The object of the study is located in the vicinity of Hsinchu High Speed Rail Station, which is located in North Taiwan. For the purpose of prohibiting the construction land from the land within 25 meter from the centre line of the outer track of the high-speed railway, the external noise of the building shall be assessed and the distance from the building wall line shall be 1.5 meter. Indoor measurements shall be made at least 1.5 meter from the interior walls or other major reflecting surfaces. All measuring positions are 1.2 meter from the ground or floor. In order to effectively understand the height of the building in the temporary high-speed railway station building level and elevation location, and the other two near the peripheral area of similar base location to assess. The measurement and measurement are three locations, one is the open space (Site 1), the other two are the commercial (Site 2) building and the high rise residential building (Site 3) respectively. The relative position of the study objects and field pictures are shown in Figure 1.

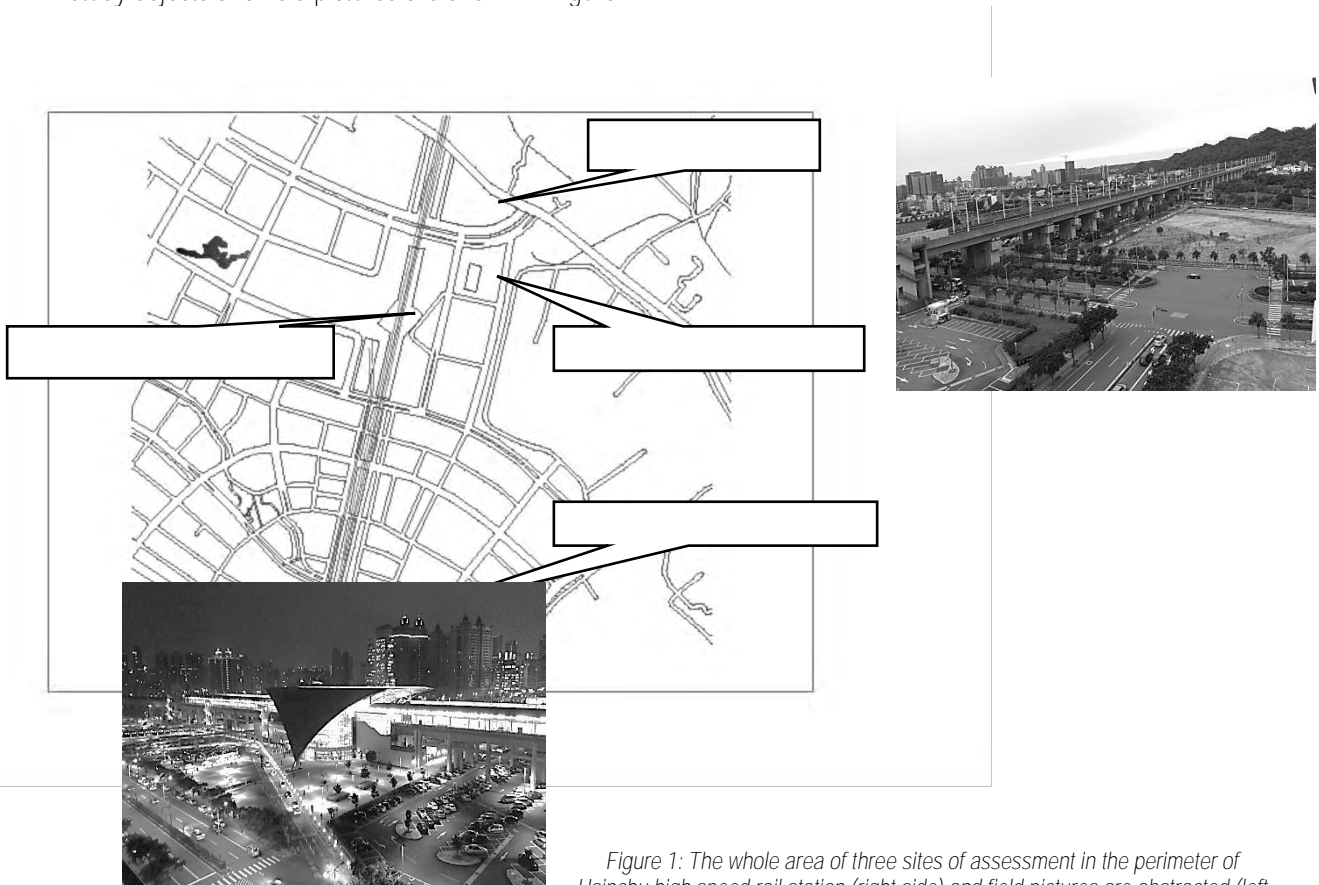

Figure 1: The whole area of three sites of assessment in the perimeter of Hsinchu high speed rail station (right side) and field pictures are abstracted (left side).

3. FIELD MEASUREMENT

This study assesses compliance with Taiwan Environmental Protection Agency land transport system noise control standards and high-speed railway environmental volume standards, the main assessment project will develop the relevant noise control program, including the identification of noise source characteristics, base noise and analysis. According to the field analysis of the data measured, the proposed improvement of the proposed program and performance recommendations for the future performance of the field noise performance test.

3.1 Results of environmental sound measurement

The site 1 (Open space) is a 30 meter distance from the station structure which outline of triangle is consisted of three roads (St. A, St. B and St. C). Site shape is shown in Table 1. The distribution of the measurement points includes a total of 18 points around the site of the horizontal dimension, and a total of 10 points in the site. The distribution of survey locations and measurement results of environmental acoustics is shown in Table 1. Around

the surrounding site, the average of LAeq (dB) is between 54.1 and 64.8 dB (A). Inside the site, the average of LAeq (dB) is 64.5.

Parameter Locations	LAm _{ax} (dB)	LA _{eq} (dB)
St. A	60.6	54.1
St. B	76.3	64.8
St. C	71.8	61.4
In Site area	64.5	57.2

Table 1. The distribution of survey locations and measurement results of environmental acoustics

3.2 Results of noise monitoring for passage trains

When the high-speed train through, the noise was generated by the value of the content of this stage of assessment. Although the noise value may be reduced by the distance of sound source which is from station body, traffic noise LAeq is between 54.1 to 64.8dB (A). However, up to speed of 250 kilo meter per hour through the car close to the high-speed rail station body and pass through the station caused by the impact of the impact of the surrounding area, will make sound noise enlarged. The distance from the centre line of the outer track 50 meter, 1.5 meter above the ground height of the noise measured by one of third octave band frequency of LAeq (dB) values is shown in Table 2. The measurement (THSR) resulted similar to the research of distribution at 1/3 octave band of LAeq (dB) of Korea high-speed railway (KTS) between the station Chunan to Chungwon, as measured in the case of the relative position and elevation measurements, measuring 107 classes of trains to speed of 150 to 300km /hr. Comparison the measurement results of LAeq (dB) between THSR700 and KTS700 are illustrated in Figure 2.

Fre q. dB (A)	63	125	160	200	250	315	400	500	630	800	1k	1.25	1.6k	2k	2.5k	3.15 k	4k
	53.4	56.4	57.7	57.9	57.8	54	52.4	58.6	53.5	59.7	60.7	66.7	68	69.7	70	75.8	70

Table 2. LAeq at 1/3 octave frequency band for High speed trains pass through

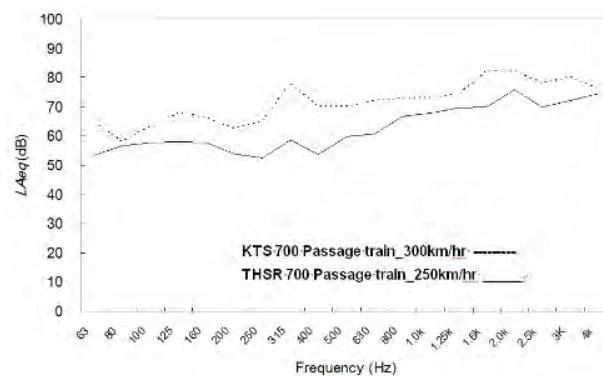

Figure 2: Measurement results of LAeq of THSR (—) in the perimeter of Hsinchu Station at 1/3 octave frequency band compared with the measurements of Korea high-speed railway (KTS) (---) between the station Chunan to Chungwon.

3.3 Horizontal distance and vertical altitude for monitoring of passage trains

The dynamic characteristic uses the fast (F) characteristic in principle which is also conducted by meet the act of environmental standard for high-speed rail traffic noise standards. The average L_{Amax} value is 75.4 dB (A) and is in line with the 85 dB (A) requirement for the maximum volume control zone III of the High Speed Railways. When using the noise meter to carry out various noise assessment parameters of the measurement analysis, select Fast or Slow time dynamic characteristics, will have different results. High-speed rail train through the maximum noise measurement, the choice dynamic characteristic of Fast than Slow module may higher than about 2dB (A). The measurement results (Figure 3) show that the distance from the high-speed train increases, may decrease sound energy L_{Aeq} (dB) with the increase of the distance of horizontal sound source. About the vertical direction, when the sound source reaches 40 meter, the sound energy will have the effect of amplification, the maximum sound L_{Amax} (dB) up to 84dB (A).

3.4 Prediction on performance of sound insulation for vertical façade

The sound pressure at the side of the curtain glass (at the window) is 56.7 dB (A), and 80 dB (A) of sound energy can be expected to be blocked under the target setting STC35 for the sound insulation of the curtain glass. In the glazing materials supplied by the curtain glass supplier, if the sound insulation performance of 6mm + 1.52PVB + 6mm cemented glass is selected, the STC is 37 (OITC = 33), the barrier performance can be effectively achieved, and the simulation result has the same performance and consistency .

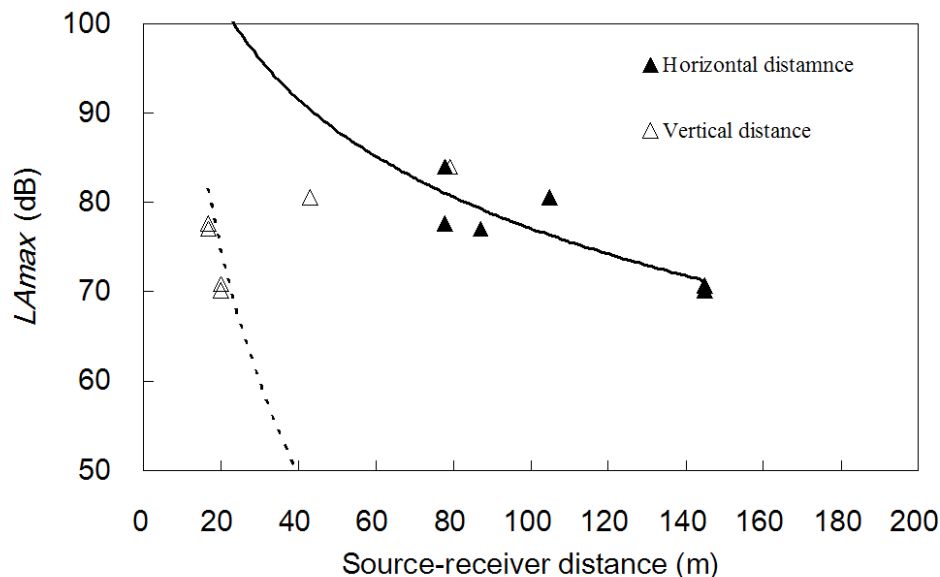

Figure 3: Measurement results of L_{Amax} (dB) shown as a function of source-receive distance of vertical distance (- -) and horizontal distance(-).

4. DISCUSSION

In the high-density urban living environment, the noise environment impact will affect the subsequent use and operation of the building after the development. In order to ensure the indoor comfort and health index of the user, the noise environment will be affected. Assessment results may provide sound performance of architectural tectonic, and provide the improvement basis for project design decisions. The study will develop a noise prevention program that will include identifying the noise source characteristics, noise and analysis within the base. According to the field data analysis and analysis, preliminary results are also abstracted. The conclusions are as follows:

- The site of the study for high-speed railway noise measurement assessment, the environmental noise L_{Aeq} (dB) value is between 54.1 to 64.8dB (A), when the high-speed railway vehicles through the station, at 50m away from the outer track centre line at the site, 1.5 meter above ground, the distribution at 1/3 octave band

of LAeq (dB) is similar as of the measurements results of Korea high-speed railway (KTS) between the station Chunan to Chungwon, the maximum sound energy LAmax is 70.1 (dB).

- It is found that when the distance between the horizontal sound source and the high-speed train passes, the acoustic energy will decrease with the increase of the distance. The LAeq sound energy is below 72dB (A) and the average maximum sound energy is 80dB (A) The following are in line with the EPD's regulatory requirements. If the sound source is away from 40 meter or more, the sound energy will be amplified, and the maximum sound LAmax (dB) can reach above 84dB (A).
- Considering the above-mentioned results, considering the indoor background noise comfort, it is recommended that the indoor background noise be NC40 _ 48dB (A), considering the maximum sound energy of 80dB (A), the sound insulation performance index STC35 (40) for the external curtain wall of this curtain will be suggested.

REFERENCES

- [1] Bao, C. and Pan, J., Experimental study of different approaches for active control of sound transmission through double walls, *Journal of Acoustical Society of America*, Vol. 102 (3), 1664-1670, (1997).
- [2] [Tsai,Hsiu-Yu](#), The study of Noise Mitigation effect of Sound Barriers in Expressways under Different Environmental Conditions, Master thesis of Systems Engineering & Naval Architecture, National Taiwan Ocean University, (2014).
- [3] Peng, [Yung-Chang](#), Characterization and Sound Field Simulation of Ground Traffic Noise, Master thesis of Systems Engineering & Naval Architecture, National Taiwan Ocean University, (2004).
- [4] Huang, [Yao-Te](#), Assessment of Noise Impact Along the Taiwan High-Speed Rail — Using Taya Township as a Case Study, Master thesis of Civil & Environmental Engineering Building, National Chung Hsing University, (2009).
- [5] Wang, Wei-Hui, Study on Noise and Vibration of High - speed Railway, Research Report, Taiwan Environmental Protection Administration, (2003).
- [6] Noise Pollution Control Act, Recommended maximum value for high speed railways, No 0960042810, Taiwan Environmental Protection Administration, (2007).
- [7] Wang, Wei-Hui, Noise and Vibration Measurement of Land Rail Transportation System, EPA-96-F105-02-251 • Chinese Society of Sound and Vibration,(2003).
- [8] Carl E. Hanson, , P.E., Jason C. Ross, P.E., and David A. Towers, P.E., High-Speed Ground Transportation Noise and Vibration Impact Assessment, Office of Railroad Development, Federal Railroad Administration, U.S. Department of Transportation, DOT/FRA/ORD-12/15, (1998).
- [9] D.Kang, ,S.J.Lee and J.W.Lee, Characteristics of High Speed Railway Noise, Proceedings of Inter-noise 2003, Jeju Korea, August 25-28, pp.2426-2435, (2003).

The Failures of Initial Commissioning, and its Impacts on Overall Building Performance

Madeline Kathleen PARROTT^a

^a British Columbia Institute of Technology, Canada, maddy.parrott@gmail.com

ABSTRACT

High-level green buildings aiming for superior targets often fall short of their predicted performance, and there is recent a push in industry to discover why.

This paper discusses the study of three green buildings in British Columbia. Each building was built to exceptional green building standards (LEED or Living Building Challenge), yet all have performance issues reported by owners and operators.

While studies exist on the green building performance gap, the majority of them focus on identifying and fixing the issues causing the gap, rather than trying to eliminate the gap in the first place. There are many design ideologies that try to eliminate the gap, but there is little information on what impact initial design and construction failures have on overall building performance.

The project will be completed by first identifying issues in design and construction that were not caught by initial commissioning. Then, using the calibrated models done in other phases of this project, the impact of each of these initial commissioning failures will be determined by varying the parameter in the calibrated model. A sensitivity analysis will be performed to see which aspects have the biggest impact on overall building performance. A comparison between the three buildings will identify what issues are common across projects, and which issues present themselves on a case-by-case basis.

This information will be invaluable for architects and designers trying to create high-performance buildings in the future. It will show which aspects of building design are extremely important, so that those steps are not glossed over in the design.

Keywords: high-performance building, commissioning, performance gap

1. INTRODUCTION

About 40% of energy usage in Canada and the US can be attributed to buildings, which presents a unique opportunity for reducing energy consumption in this part of the world. If buildings were to strive for higher energy efficiency, they would have a huge impact on North American energy consumption. Due to this, governments, designers, and owners have turned to the increasingly popular green building movement, including building certifications from programs like LEED and LBC. These certification systems reward buildings for sustainable building practices, including efforts to improve efficiency (energy and otherwise).

As green buildings and more stringent targets for buildings become more popular, the emerging problem has become that there is little proof that high performance buildings actually are high-performing. It has been shown that in many cases there are large discrepancies when you compare predicted performance to actual utility bills.

This phenomenon of buildings performing much worse than intended is known as the “performance gap” in green and high performance buildings. It reflects the disconnect between design intent and actual performance, often framed in terms of energy use, water use, occupant comfort, or other measurable outcomes.

1.1 Performance gap

There is plenty of evidence around the globe to support that most high-performance buildings do not perform nearly as well as they were intended to perform. From schools to commercial buildings, high-rise residential apartments to single family net-zero houses, it is very rare that actual performance reflects the anticipated performance. (Norford et al, 1994; Scheuer et al, 2003; Salehi et al, 2015; Fedoruk et al, 2015; Bordass et al, 2004)

While the majority of studies on buildings agree that the performance gap exists and is a significant problem within the realm of green and high-performance buildings, there is no single confirmed reason for this gap. In some cases, it is due to complicated systems that were not well understood when they were designed, so their actual functionality is much different from assumed conditions (Li et al, 2014). In other cases, the expected performance is an inaccurate number, because the assumptions used to create the original energy models are incorrect (SUN). In many studies, it has been shown that occupant behaviour and schedules can be one of the biggest contributors to variations in performance. (Salehi et al, 2015; Norford et al, 1994; Wei et al, 2015; Demanuele et al, 2010).

Performance gaps are not uncommon in green buildings. There are many different aspects of building performance, and if any of them are not designed, implemented, or used correctly, it can result in the building performing very differently than intended. Often poor design or integration of these sustainability measures end up resulting in substantially higher energy use than predicted. (Li et al, 2014; Torcellini et al; 2006; Dronkelaar et al, 2016; Demanuele et al, 2010; Wilde, 2014; Chu, 2016.)

Green and high-performance buildings often use extremely state-of-the-art ways to attempt to save energy or improve energy efficiency. Such attempts to limit energy use in buildings can be high-performance envelope assemblies, innovative mechanical systems, architectural solutions to problems like daylighting and shading, along with many others. While many of these attempts have been proven extremely effective when implemented correctly, they can have large negative effects on buildings when they are not done correctly (Salehi et al, 2015).

Designers, architects, engineers, and contractors need to have a much better understanding of how their systems work and influence all aspects of the overall building in order to use them effectively. Trying to design these types of systems in a bubble away from other key stakeholders in building design, or without fully understanding how they work, can end up doing more harm than good in the design of a high-performance building meant to be “green.”

1.2 Energy models

In the design stage of buildings, especially high-performance buildings, energy models are used as a way of seeing how all of the different aspects of the building interact with one another in terms of energy usage. Since building systems are incredibly complex, it is hard to see how one decision may affect another. Energy models help with this, by allowing iterative changes that give outputs of overall energy use, to show which parameters have the largest effect on the overall building. This helps influence decisions all across the building, from architectural form to mechanical systems to construction techniques (Harmer and Henze, 2015).

In addition, to determine how well buildings are actually performing after final construction and occupancy, utility data should be compared to the predicted performance of the building. These baseline performance targets most often come from energy models, which provide estimates for building energy use.

High performance buildings almost always use energy models to help in the design process, but the issue with energy models for new construction is that they are almost never accurate in the sense of “matching reality.” The purpose of design-stage models is to “provide relative energy use,” that is, to compare the effectiveness of various methods to be implemented in the building (Dirkes and Weaver, 2016). There are many assumptions made to complete an initial energy model, many of which may not reflect the actual usage of the building and result in performance estimates that can generally range from fairly close to wildly inaccurate (Fedoruk et al, 2015). Despite these performance estimates being generally incorrect most of the time, they are still the performance targets which are referred to throughout the life of the project. The difference between these values and actual utility bills is how the performance gap is explicitly measured.

Since using early design-stage energy models often does not reflect (even roughly) performance, a better usage of energy models is calibrated energy models. Calibrated energy models take actual building usage (from utility bills, etc.) and re-model based on actual performance. The way this is completed is by varying individual parameters one by one until the model mostly closely reflects the actual utility data or data points of those parameters. When individual energy users are determined as accurate reflections, they are combined into an overall building energy model which closely resembles the final constructed building (Salehi et al, 2015).

Calibrated energy models are the closest virtual representations of the building as-is, and can be very useful in several different ways. The process of calibrating an energy model can be very telling, highlighting which areas of

the building have the biggest impact on overall energy use and which parts of the existing model are not accurate, showing where the underlying issues are. They can also be used to analyse the effectiveness of various changes to the building (like implementing energy conservation methods), or they can be used to perform sensitivity analyses of what actually has the biggest impact on energy use. (Claridge, 2004; Demanuele et al, 2010)

Energy models are hugely powerful tools when it comes to analyzing the success or failure of high-performance buildings. The problem with energy models is that it is essential that the models are as accurate as possible to aid in diagnosing and fixing issues. If incorrect assumptions are made, energy models will not accurately reflect actual performance.

1.3 Eliminating the performance gap

Since the performance gap has come to light, there have been many strategies suggested to try and eliminate it. For the most part, these strategies fall under two categories: attempting a more integrated design process, or catching and fixing issues by using building commissioning.

1.4 Integrated design process

The integrated design process is a method of building design and construction that aims to ensure no part of a building is completed in isolation. The IDP ensures that there is much cross-disciplinary teamwork which results in a more sustainable building: all problems and issues are dealt with by a whole team, rather than an isolated individual.

The integrated design process is one such method meant to ensure that all of the various aspects of the building work together seamlessly. It is achieved by bringing together disciplines that would not normally work together in the traditional design of buildings. It emphasizes the idea of a building as a complex system where one change can have huge effects on other aspects, and tries to eliminate those effects by addressing them before the changes are made. It also strives to ensure all systems work well together rather than conflict, and prevents redundancies by allowing team members to work together (REED and GORDON). This helps to reduce the performance gap because it allows for systems to be designed properly, without inadvertently interfering or causing issues in other areas of the building. When a building team works together in all aspects of the design and construction of buildings, some

The underlying principle of the integrated design process is recurrent in almost all methodologies trying to improve design: the final design of a building should be seamless and cohesive, not a fragmented and uncoordinated approach as it is in current building practices (Fedoruk et al, 2015).

1.5 Commissioning

One way to ensure the actual performance targets of HPB's are met is through a process called commissioning. Commissioning is a quality assurance process which exists to ensure systems and buildings are meeting their designed performance requirements (Barich, 2007). It can also be used to find and correct a variety of mistakes relating to performance in existing buildings. Commissioning ensures that owners get what they pay for in buildings, and could be one of the most powerful tools for ensuring acceptable performance of green and high-performance buildings. However, commissioning is one of the least understood strategies and as such rarely gets implemented, or is used to highly varying degrees of success from building to building (Mills, 2010).

There are many different aspects of commissioning, meant to address the various stages of buildings- design, construction, and operation.

The first is initial commissioning, which covers the design and construction phases of the building. It is meant to confirm that the performance intent of the building, including requirements for code and various green building targets, have been met in the design of said building. Initial commissioning also exists as a means of confirming that the actual construction of the building and the implementation of systems accurately represents the design, which in turn guarantees that the performance targets are met, assuming the design accurately represents performance goals (ASHRAE, 2012).

After a building is completed, ongoing commissioning is the means by which the building can be checked periodically to ensure the building is continuing to meet its performance goals. Ongoing commissioning is especially useful for finding where systems have started to fail or lose efficiency. It identifies the problems, and if used properly can give clues into how to fix them (Barich, 2007).

Continuing commissioning is an extension of ongoing commissioning, but instead of a periodic check-up on the building, it is a continually monitored process of checking performance. Automated building measurements and systems are the most helpful for continuing commissioning, and can be extremely helpful in triggering alarms or alerting owners when building performance falls outside of an expected range (Harmer and Henze, 2015).

Retro- and re-commissioning are, for all intents and purposes, the same thing. Retro-commissioning refers to the commissioning process applied to a building that has never had commissioning performed. Re-commissioning looks at all the same things as retro-commissioning, but is applied to buildings that were originally commissioned but are now failing. Both types of commissioning help to narrow down the actual reason for generally identified performance issues. Retro- or re-commissioning usually occurs when building owners realize various discrepancies of building performance, and a study is undergone to determine why that is. These studies and re-commissioning projects most often utilize calibrated energy models and extensive analysis of building data, including utility or building monitoring (Schultz and Ayala-Navarro, 2012).

An overview of the types of commissioning can be seen in Table 1 below.

Type	Initial		Ongoing / continuing	Retro- / re-
Role of Commissioning	Ensure design meets performance targets	Ensure as-built building represents designed building	Ensuring building continues to perform as intended	Identify the reasons for performance issues
	QC	QC	QC/Diagnostic	Diagnostic
Why?	Helps to guarantee that architects, designers, and engineers actually realize what they're designing and know/ can prove that the specified systems/assemblies meet requirements	Assuming the design met performance targets, if the built building matches the designed building, then performance targets have been met	Makes sure that the systems continue to operate as they are supposed to, and that issues are caught and dealt with	Fixes issues in existing buildings, when obvious performance deficits have been identified by building owners or users

Table 15: Summary of commissioning

2. THE BUILDINGS

All three buildings are located in southern British Columbia, Canada. Two are located on Vancouver Island, and one is in the City of Vancouver. Each was designed to be a high performance buildings. The two Vancouver Island buildings were aiming for LEED certification- one Gold and one Platinum. The Vancouver project was aiming for full Living Building Challenge certification, a much more stringent process with higher performance targets than LEED. The design of all three buildings included an energy model to predict performance, and all three have some sort of energy monitoring systems to capture information about energy usage across the building.

2.1 Gulf islands national park reserve of canada- operations centre

The Operations Centre for the Gulf Islands National Park Reserve of Canada is located in Sidney, B.C. on Vancouver Island. It is a three storey office building for the operation and administration staff of the park. It was designed to LEED Platinum standards, with an estimated energy consumption of 75% than the baseline Model

National Energy Code reference code. There were many innovative systems proposed for this building, including an ocean based geothermal heat exchange system. Additionally, since this was a LEED project, commissioning was a required credit for achieving certification.

2.2 VanDusen gardens visitor centre

The VanDusen Gardens are a 22 hectare botanical garden located in the middle of Vancouver, BC. The Visitor Center is a mixed-use building meant as the first point of entry to the gardens. It has a shop, a café, offices, and flexible rental spaces for events, classrooms, or meetings. This building was designed to meet Living Building Challenge full certification, which involves incredibly stringent targets like creating 105% of the energy it uses and treating all its own storm, grey, and black water. The VanDusen Visitor Centre, in order to meet these very high performance targets, employed several highly unique systems to try to achieve these goals. They employed a mix of passive strategies in addition to active mechanical systems to address energy goals, and a complex water collection and recycling system to address water targets. Living Building Challenge does not require commissioning, unlike LEED, but also unlike LEED, it is a performance driven certification system that requires buildings to prove they meet the targets.

2.3 Vancouver island university- cowichan campus

The VIU project, located on Vancouver Island in Duncan, B.C. is a university building comprised of classrooms, administrative offices, a cafeteria, laboratories, and other educational spaces. It was designed to LEED Gold standards, and entered into an Energy Study Agreement with BC Hydro as part of the New Construction Program, which aimed to study how to reduce energy consumption of new buildings in BC while still providing owners with added benefits to their building, like higher productivity and occupant satisfaction. Similarly to the Gulf Islands Parks building, aiming for LEED certification meant this project was commissioned as part of the credit requirements. The measures implemented into the building to achieve high energy performance were fairly similar to the other two projects, and included a unique heat exchange system and rainwater collection and grey water recycling.

2.4 Performance issues

Since the buildings have been in operation, there have been significant gaps between predicted and actual performance. These have been determined through a variety of avenues: utility bills were higher than expected, actual energy consumption was higher than expected, occupants have reported thermal comfort issues, the full LBC certification was not achieved due to systems not working as intended, and other issues that have been discovered and fixed over the life of the buildings so far. It is these significant issues in all three buildings that inspired the need for further study.

The purpose of these projects is to determine what the underlying causes of the performance gap are, how to fix them, and how to prevent the same gap from occurring in future buildings. Using calibrated models, general discrepancies will be narrowed down into specific end-uses, identifying the reasons for the overall gap.

3. PROJECT PLAN

Many people will argue that the biggest cause of the performance gap can usually be traced to issues with either occupancy or systems that work improperly. Theoretically, both of these problems are early-stage design issues, as occupancy schedules are normally an assumption made for the energy model and it is always assumed that systems work 100% as they are intended. However, actual increased occupancy rates or inefficient systems both present themselves only after the building is handed over, because it is not until then that the discrepancy becomes apparent.

When it does become apparent, re- or retro-commissioning is performed using calibrated models to determine the problems and identify fixes. Since these measures are taken in a later commissioning step, it is rare that that initial commissioning is blamed for the failure, even if that initial step should have caught the potential mistakes.

Additionally, if a building is handed over to owners with issues to begin with, any further problems caused by anything even as small as wear and tear will only compound the difficulties further, widening the performance gap.

This would mean that had the problems been caught during initial commissioning, they could be fixed and targets adjusted accordingly, bringing predicted and actual performance closer together.

The purpose of this project is to determine the effects of the failures of initial commissioning on the overall **performance of green buildings**. **In today's construction world, many of the issues associated with initial commissioning failures are accepted as "the reality of the construction world," but it is extremely important** to recognize where this first quality assurance procedure goes wrong, and how much of an impact it has on final building performance.

If the building starts off working like it is intended, it will be much easier to diagnose problems when they arise, rather than trying to diagnose the issues of an already flawed system. This is why the focus of this paper is on the initial commissioning of the three buildings, rather than only applying retro-commissioning to identify and fix issues.

By studying the documentation of the building design and construction process, and studying the current state of the building, we will identify two main flaws in the early design process:

1. Parts of the building design that were designed improperly due to lack of knowledge or improper assumptions (ie. U-values of walls much higher than anticipated due to thermal bridging, occupancy schedules were inaccurate, mechanical systems did not function as intended)
2. Parts of the building design that were implemented improperly during construction (ie. air barrier details were installed incorrectly, vents were placed in the wrong spots, flow direction in pumps was opposite of what it should have been, specified product alternates were lower performance)

These two types of issues are those that should be caught during initial commissioning, but often aren't. We will use the documentation available as well as post-occupancy surveys to determine which types of these issues were present in each of the three buildings.

At the same time, other projects are being completed to study other aspects of the performance gap. These projects will be complete with calibrated models of each of the three buildings, to show the most accurate energy and performance breakdown of the buildings.

Using these calibrated energy models, the impacts of each of these failures in terms of total building performance will be analyzed for each building and its corresponding issues. If the impacts on overall performance are noteworthy, a sensitivity analysis will be completed to see which of them is the most critical.

The results of the sensitivity analyses will be compared across the three buildings, to see if the same issues present themselves in the different projects. This will lead to discovering the common, general issues which are prevalent across multiple building types, rather than just studying each building in isolation.

4. CONCLUSION

High-performance buildings often have issues where their actual performance does not match the performance predicted by energy models in the early design stages. Once performance gaps exist, calibrated energy models must be completed to identify and fix these issues.

Some ways to try and eliminate the performance gap in the first place is to implement integrated design processes or building commissioning, both of which can limit the discrepancy between actual and predicted performance.

This project will investigate how much of an impact the failures of initial commissioning have on overall building performance, by examining how much better a building would perform if the design and construction met the performance requirements laid out by the building owner. It will accomplish this by using existing documentation, post-occupancy surveys, and calibrated energy models to perform a sensitivity analysis to see which aspects have the biggest impact on overall performance.

REFERENCES

- [1] ASHRAE. Performance Measurement Protocols for Commercial Buildings: Best Practices Guide. N.p.: ASHRAE Publications / American Society of Heating, Refrigerating and Air-Conditioning Engineers, 2012. Print.
- [2] Barich, M., 2007. COMMISSIONING, RECOMMISSIONING, RETROCOMMISSIONING, AND CONTINUOUS COMMISSIONING. *Engineered Systems*, 24(9), pp.66-68.
- [3] Bordass, B., Cohen, R. & Field, J., 2004. Energy Performance of Non-Domestic Buildings – Closing the Credibility Gap, International Conference on Improving Energy Efficiency in Commercial Buildings. Frankfurt, Germany
- [4] Chu, Anne-Mareike. Understanding the Performance Gap: An Evaluation of the Energy Efficiency of Three High-performance Buildings in British Columbia. Thesis. University of British Columbia, 2016. N.p.: n.p., n.d. Print.
- [5] Claridge, D.E., 2004. Using simulation models for building commissioning.
- [6] Demanuele, C., Tweddell, T. and Davies, M., 2010, September. Bridging the gap between predicted and actual energy performance in schools. In *World renewable energy congress XI* (pp. 25-30). UAE Abu Dhabi.
- [7] Dirkes II, J.V. and Brad Weaver PE, B.E.A.P., 2016. Modeled Performance Isn't Actual Performance. *ASHRAE Journal*, 58(5), p.56.
- [8] Dronkelaar, C., Dowson, M., Spataru, C. and Mumovic, D., 2016. A Review of the Regulatory Energy Performance Gap and Its Underlying Causes in Non-domestic Buildings. *Frontiers in Mechanical Engineering*, 1, p.17.
- [9] Fedoruk, L.E., Cole, R.J., Robinson, J.B. and Cayuela, A., 2015. Learning from failure: understanding the anticipated–achieved building energy performance gap. *Building Research & Information*, 43(6), pp.750-763.
- [10] Harmer, L.C. and Henze, G.P., 2015. Using calibrated energy models for building commissioning and load prediction. *Energy and Buildings*, 92, pp.204-215.
- [11] Li, C., Hong, T. and Yan, D., 2014. An insight into actual energy use and its drivers in high-performance buildings. *Applied Energy*, 131, pp.394-410. Vancouver
- [12] Mills, E., 2010. Building commissioning: A golden opportunity for reducing energy costs and greenhouse-gas emissions. Lawrence Berkeley National Laboratory.
- [13] Norford, L.K., Socolow, R.H., Hsieh, E.S. and Spadaro, G.V., 1994. Two-to-one discrepancy between **measured and predicted performance of a 'low-energy' office building: insights from a reconciliation based on the DOE-2 model**. *Energy and Buildings*, 21(2), pp.121-131.
- [14] Salehi, M.M., Cavka, B.T., Frisque, A., Whitehead, D. and Bushe, W.K., 2015. A case study: The energy performance gap of the Center for Interactive Research on Sustainability at the University of British Columbia. *Journal of Building Engineering*, 4, pp.127-139.
- [15] Scheuer, C., Keoleian, G.A. and Reppe, P., 2003. Life cycle energy and environmental performance of a new university building: modeling challenges and design implications. *Energy and buildings*, 35(10), pp.1049-1064.
- [16] Schultz, A.L. and Ayala-Navarro, A., Energy Efficiency Improvement of an Institutional Facility through Retro-Commissioning (RCx)—A Case Study.
- [17] Torcellini, P., Pless, S., Deru, M., Griffith, B., Long, N. and Judkoff, R., 2006. Lessons learned from case studies of six high-performance buildings. Golden, CO, National Renewable Energy Laboratory.
- [18] Wei, S., Jones, R. and de Wilde, P., 2014. Driving factors for occupant-controlled space heating in residential buildings. *Energy and Buildings*, 70, pp.36-44.
- [19] Wilde, P., 2014. The gap between predicted and measured energy performance of buildings: A framework for investigation. *Automation in Construction*, 41, pp.40-49.

Heating and Cooling Loads of a Poultry Shed in Central Coast, NSW, Australia

ZHOU Yu^a, Asal BIDARMAGHZ^b, Guillermo NARSILIO^c, Lu AYE^d

^a The University of Melbourne, Australia, yzhou13@student.unimelb.edu.au

^b The University of Melbourne, Australia, bia@unimelb.edu.au

^c The University of Melbourne, Australia, narsilio@unimelb.edu.au

^d The University of Melbourne, Australia, lua@unimelb.edu.au

ABSTRACT

Space heating and cooling comprises 40% of the global final energy use. With more energy efficient technologies in heating and cooling, up to 10% of global energy consumption could be saved. In agriculture, poultry sheds are used to shelter poultry (broilers and layers) for the production of meat and eggs, sources of animal protein for most people. The range of acceptable indoor air temperature for poultry sheds is 15°C to 25°C for mature birds, and higher temperatures are required for young birds depending on the stage of growth. It is recognised that the costs of heating, cooling and ventilating poultry sheds constitutes a significant portion of the chicken farm operating costs. Various aspects can be considered to reduce these costs considerably. The potential improvements include better thermal performance of building envelopes, energy efficiency of HVAC systems and operational schedules or timing of the production cycle. This paper aims to reduce the cooling and heating energy consumption by identifying the most suitable operational plan. The heating and cooling demand cycles of a poultry shed in the Central Coast region has been investigated in detail by using building energy simulation software tools. This paper reveals that the operational schedule (i.e. begin dates of the cycles of production) has profound influence on energy consumption. The optimised operational schedule can save an average of 12% of overall energy expenditure and 20% on heating.

Keywords: building energy simulation, energy use, poultry shed

1. INTRODUCTION

The global annual energy consumption is about 13,000 Mtoe (-544 EJ), resulting in nearly 50 Gt CO₂-e Greenhouse Gas (GHG) emissions. It is widely accepted that our future energy sources could not highly rely on fossil fuel such as oil and gas since these resources are finite, and more importantly the majority of GHG emission (65%) comes from them. To provide our next generations with a sustainable energy future, alternative approaches must be adopted as soon as possible.

Space heating and cooling comprises a significant part (40% - 50%) of the overall final energy use, resulting in 20 Gt CO₂-e GHG emissions. By using advanced technologies for space heating and cooling, up to 1,509 Mtoe of global annual energy consumption could be reduced by 2050. In order to develop sustainable buildings and improve energy efficiency in existing buildings, several approaches can be considered, which include improving the thermal performance of the building envelope, increasing the energy efficiency of HVAC system and determining the most suitable operational schedule.

The agriculture sector constitutes a significant part of Australia's economy. In year 2014/15; the overall sector was worth \$51 billion, comprising 3% of Australia's total gross domestic product (GDP). However, when considering all the add-on processing industries, the overall contribution of the agriculture sector rises to 12% of the GDP. Among these industries, nearly 600 million chickens are raised every year for producing meat and a typical shed provides about 200,000 chickens annually, which means there are currently around 3,000 poultry sheds for chicken meat production in Australia. The overall costs of heating and cooling for chicken farms are estimated to be \$80 million per year.

To raise chicken/ broiler efficiently, poultry sheds are designed to meet the specific requirement for chickens during different growth stages. The indoor temperature is a vital factor for the chicken to grow properly in an effective timeframe. Within each growing cycle, the indoor air temperature requirement changes from 33°C at the beginning to 21°C in the end, which results in a unique heating/cooling load cycle depending on the start date. Since outdoor

air temperature changes throughout the year, a considerable amount of energy is sometimes needed to maintain the required indoor air temperature (i.e. to reach 33°C in winter).

Researchers have conducted building simulations for poultry sheds for heating/cooling load cycles in recent years. Kharseh and Nordell (2011) estimated the heating and cooling loads for a typical poultry shed in Syria in order to design a geothermal cooling and heating system for the shed. However, the assumption made for the chicken is not enough to describe the heat generation due to the growth of chicken, which may result in an inaccuracy of the heating and cooling loads. El Mogharbel et al. (2014) developed a 3D computational simulation model for the heating system of a poultry shed in East Lebanon, with various factors taken into consideration. However, this model is based on the solar assisted heating system only. At the same time, no annual data and cooling loads has been reported. Rojano et al. (2015) developed a 3D model using a CFD commercial software package, Fluent. In their study, the heat and mass transfer within a poultry shed in the US is analysed in detail. However, the aim of their work is to analyse temperature, humidity and air quality in the shed. Hence, no heating and cooling loads were reported. Besides, owing to the complexity of this 3D model computational time is long, thus a detailed model for annual heating and cooling loads is unlikely to be feasible. Hamilton et al. (2016) developed a thermodynamic model for the thermal analysis of a poultry shed in Australia. This model contributes to a theoretical analysis of chicken growth, heat generation, and water consumption during the cycle. Validation based on measured data was also made on the model. However, no models were derived in this article and there were no direct data for heating and cooling loads. From the review of the literature, it follows that limited knowledge is available to derived sheds load cycles, particularly of local settings.

Due to the different agricultural standards encountered among countries (i.e. construction materials, operational schedules) and the various climate conditions of the poultry sheds, it is essential to analyse the heating/cooling demands for local conditions, in the case presented herein, for Australia. The aim of this paper is to estimate the heating/cooling load for a specific poultry shed in NSW, Australia, as representative of current practice in the area. The estimated costs base on the current HVAC system is also reported. An optimisation of growing cycle start date for the minimum cost is investigated.

2. BUILDING SIMULATION MODELS

EnergyPlus is widely used for building energy performance simulations. In this paper, an EnergyPlus model was developed for a poultry shed in Central Coast, NSW. Other details of the methodology employed are included in this section.

2.1 Simulation parameters

The poultry shed investigated in this investigation is located in the Central Coast Region, NSW, Australia (approximately at 33°23'49"S and 150°24'09"E). **Climate data are essential for the building simulation. A typical meteorological year (TMY) data generated by an algorithm based on 20 years of recorded dataset is widely used to predict the long term performance of buildings. In this paper, the TMY file generated by Meteonorm 7.1 based on recorded climate data from 1990-2010 is utilised. An average error of 6% in year sum comparing with the actual climate can be expected by using this method of hourly data generation.**

Time/Days	Weight/kg	Metabolic Weight/w	Power/W	Population of Chicken	Size of Shed	Required Temperatue/°C
1	0.04	0.09	0.68	40,000	Small	33.0
7	0.16	0.25	1.82	40,000	Small	30.7
14	0.42	0.52	3.82	40,000	Small	27.5
21	0.84	0.88	6.43	40,000	Large	24.8
28	1.39	1.28	9.36	40,000	Large	22.0
35	1.97	1.66	12.13	40,000	Large	21.0
42	2.43	1.95	14.21	30,000	Large	21.0
49	2.74	2.13	15.55	20,000	Large	21.0
56	2.90	2.22	16.23	10,000	Large	21.0

Table 1: Poultry shed simulation parameters

As shown in Table 1, there are two building models to meet the different space requirements as chickens grow. The small area within the shed is for the first three weeks of growth with dimensions of 18 x 18 x 3m³. Later, the bigger chickens are redistributed into a larger space within the shed, with dimensions of 18 x 160 x 3m³. The building is constructed with 75mm 'Coolroom' walls (thickness: 0.075m, thermal conductivity: 0.039 W m⁻¹·K⁻¹, density: 16 kg m⁻³, specific heat: 340 J kg⁻¹·K⁻¹) with no windows. A chicken usually attains 2.8 to 3kg at the age of 8 weeks. The mass of chicken for the first 35 days is provided by our industry partner (Ground Source Systems Pty Ltd) while the following 21 days data is generated through a quadratic function. Heat produced by a living creature is proportional to the metabolic weight, which is the unit of 0.75 power of kg. The heat rate generated by an adult chicken is 160 kcal d⁻¹ w⁻¹ (7.75 W w⁻¹).

2.2 Operational schedules

In Australia, it usually takes about 55 to 60 days for a recently hatched chicken to develop fully for the market. Meat broilers reach the mass of harvest at the age of 5 weeks, and partial harvest of chicken happens up to four times in one batch on a chicken farm due to the different demand for light and heavy chicken meat. After that, there are 5 to 14 days for clean-up and preparation for the next batch. The simulation in this paper is based on the operational schedule shown in Table 1.

As shown in Table 1, during the first 21 days, chicks are kept in a small area with controlled temperature inside the shed to save energy. At the 22nd day of each batch, the shed is expanded to the full area. At the 35th day, the average mass of a chicken reaches about 2 kg, meeting the requirement for the market. The first harvest happens in the midnight of the 35th day, when one-fourth of the overall population, which is 10,000 chickens, are taken away. Later, in every following week chickens are taken away at different stages in order to suit the demand of the market. The partial harvesting significantly decreases the internal heat gain, hence influencing the heating and cooling loads. The final harvest happens at the end of the eighth week, followed by two weeks of clean-up and preparation for the next batch.

3. TITLE HEATING/ COOLING LOADS AND COSTS ESTIMATION

By utilising 'Ideal Air Load' option in EnergyPlus, the hourly heating and cooling loads were estimated. The algorithm applied is the third order backward difference method. Estimation of costs based on the current HVAC system has also been conducted.

3.1 Heating and cooling loads for different starting dates

In order to determine the heating and cooling loads for the different starting dates, 52 batches starting at different weeks for one year were investigated. The first week starts at 3rd of January, the first working day in a year in Australia. As an example, Figure 1 and Figure 2 describe a typical eight-week batch starting at the 19th of December. The indoor temperature requirement is set every day to meet the temperature requirement for raising broilers. During this batch, the heating load decreases as a result of increasing heat generated by the chickens. After that growth stage, the cooling load significantly increases during the following first five weeks. After each harvest, the internal gain (heat produced by chicken) reduces, which results in a reduction of cooling loads.

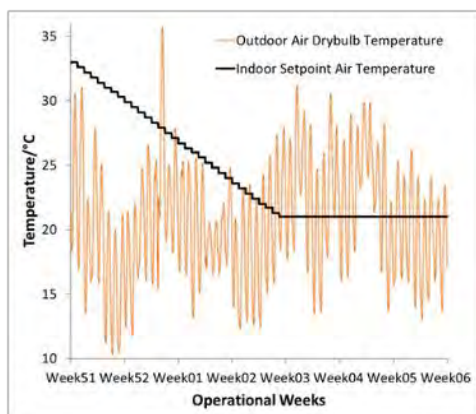

Figure 1: Indoor and outdoor air temperature

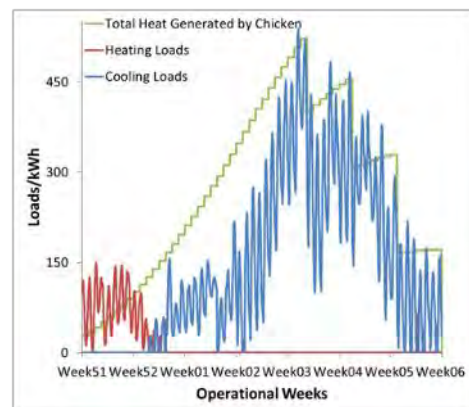

Figure 2: Hourly heating and cooling loads

After hourly heating and cooling loads for 52 starting weeks were acquired, the overall energy consumption for each batch was obtained by summing up the heating and cooling loads. As shown in Figure 3, at the beginning of the year (summer), raising a batch requires much more cooling than heating (nearly eight times higher). Later, as the outdoor air gets colder, the heating loads increase while the cooling loads decrease. At the middle of July (winter), the heating load reach the peak (105,108kWh) for one batch, while the minimum cooling load, 23,366kWh, appears in the 24th week. After the coldest periods of the winter, the heating load begins to reduce together with the boost of cooling demand. The highest cooling demand happens at the end of the year, corresponding to the minimum heating demand of only 11,575kWh for one batch.

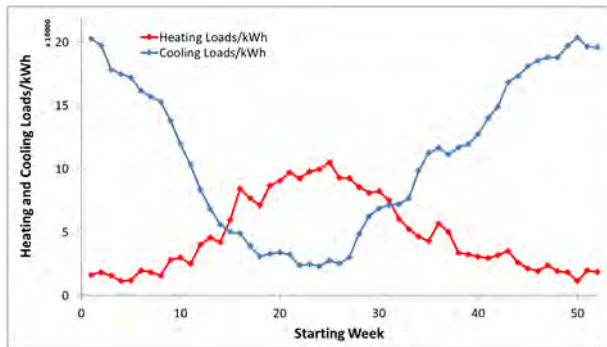

Figure 3: Loads for different starting weeks

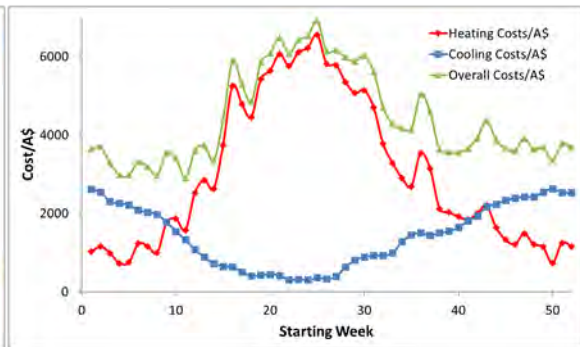

Figure 4: Costs for different starting weeks

3.2 Estimation of costs

Chicken sheds are typically equipped with gas heaters for heating and evaporative coolers for cooling in NSW. The gas heaters were assumed to have an efficiency of 0.85. It was hard to determine the operating efficiency of evaporative coolers because their performance highly relies on the relative humidity and ambient air temperature. However, it is known that evaporative cooling usually saves around 75% of the cost compared with standard air conditioning. This paper assumed one-fourth of the cost of air conditioners with COP of 2.5 as estimation. The prices of energy applied for the analysis are 12.9c/kWh for electricity and 5.3c/kWh for gas.

Figure 4 shows the heating and cooling costs for the different starting week. Corresponding to the loads, the heating cost rises from AU\$ 722 to more than AU\$ 6,500 in the mid-year while the cooling cost reduces from AU\$ 2,614 to AU\$ 301. After winter, the heating cost decreases and the cooling cost increases. Since the evaporative cooler is cheaper to operate, the cooling cost is much less than heating in the year total, despite the nearly doubled cooling load's peak. The results also show that raising a batch in winter costs much more than in summer. The most cost-effective period for starting a batch is from late September to early April.

4. OPERATIONAL OPTIMISATION

As fully-grown chickens generate large amounts of heat, i.e. 40,000 chickens in a shed could generate heat up to 600kW, raising a batch in summer consumes a large amount of energy for cooling. In winter, due to the low outdoor temperature and the relatively high initial temperature requirement (33°C on the first day), the heating loads could also be large. By avoiding raising chicks in the coldest time of winter as well as adult chickens during the hottest weather in summer, a suitable yearly operational schedule reduces the heating loads in winter and the cooling loads in summer.

A typical batch takes eight weeks duration. It is almost impossible for a shed to run six whole batches in one year due to the time required for cleaning and preparation. In this paper, five batches were considered for one year. Assuming a minimum break of one week for cleaning and preparation, the possible intervals between each batch are one to six weeks. Assuming at least a one week break between the last batch and the first one, there are overall 3,248 possible operating schedules. In this paper, the costs of all of the 3,248 possible schedules have been estimated using a Matlab code developed.

Figure 5 shows that the annual costs for all operating schedules resemble the normal distribution pattern, with an average of AU\$ 22,126 and the standard variations of AU\$ 852, which is calculated with the Maximum Likelihood

Estimation (MLE). MLE is a method that estimates parameters of statistical models based on given data. The distribution has also passed the Kolmogorov-Smirnov test in Matlab, a hypothesis test for normal distribution, at a 1% significance level.

In statistics, for the normal distribution, the three standard deviation (sigma) rule treats the values within the region of the distance of three times of the standard deviation to the mathematical expectation as a practical certainty. By starting at 5th, 14th, 28th, 39th and 48th week of the year, the most economical schedule costs only AU\$ 19,514, which is out of the three-sigma region (AU\$ 19,570 to AU\$ 24,681). This result reveals the significance of the optimisation because it is improbable for a farmer to operate the chicken shed with the minimum cost if the optimised schedule identified is applied.

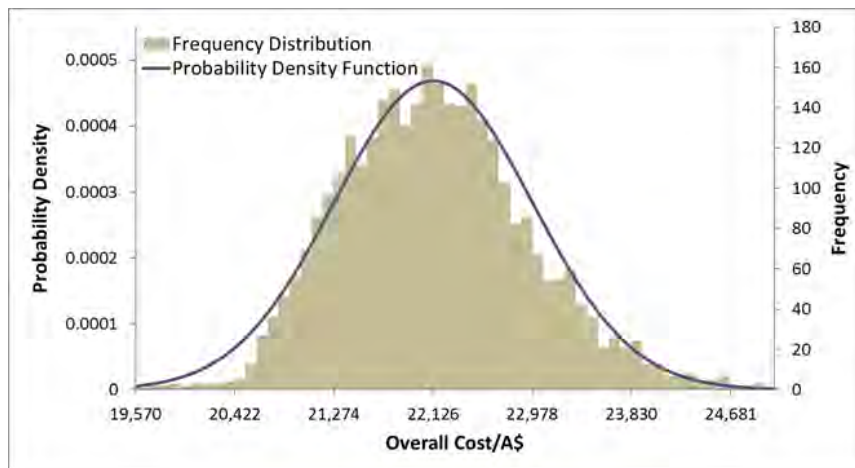

Figure 5: Costs distribution for all operating schedules

More specifically, the optimised schedule costs are AU\$ 11,972 for heating and AU\$ 7,542 for cooling. Although the cooling cost is 5.5% higher than average, this schedule nevertheless consumes 11.8% lower than the overall average and saves more than 20% on heating. Since gas heaters produce GHG emissions, adopting this schedule would also reduce the GHG emissions. For the typical poultry shed investigated, approximately 10 t CO₂-e would be reduced annually, equivalent to the removal of two cars or the planting of more than 600 trees per year.

5. CONCLUSION

This paper investigated the heating and cooling load cycles of a typical poultry shed in Central Coast Region, NSW, Australia by using EnergyPlus simulation engine. The simulations considered the chicken growth rate and metabolic heat generation, operating schedules, building envelop materials, orientation and climate conditions.

The two vital factors that influence the energy consumptions for heating and cooling the chicken shed are internal gains from the metabolic heat of chickens and the climate conditions. The energy consumption could be reduced by changing the operating schedules. By evaluating the heating/cooling load profiles for batches starting at 52 different weeks throughout a year, the relationship between energy consumption and operating schedule has been discussed. The results reveal that the period from late September to early April is the most economical time for starting a batch.

Considering the estimated cost based on the current HVAC system, an operational optimisation for the minimum cost is suggested. The results show that operational optimisation would significantly reduce the heating/ cooling loads as well as the costs for heating and cooling. By applying the lowest cost schedule, on average 20% of the heating cost and 12% in total cost could be saved.

ACKNOWLEDGEMENTS

The authors would like to thank Mr. Brad Donovan from Ground Source Systems Pty Ltd and Mr. Brad Brown for kindly providing information regarding the poultry house.

REFERENCES

- [1] Australian Bureau of Statistics,2016. 7215.0 - Livestock Products, Australia, March 2016.
- [2] Australian Chicken Meat Federation (ACMF),2013. Growing Meat Chickens.
- [3] Australian Government. Dept. of the Enviroment,2015, National Greenhouse Accounts Factors, in Australian National Greenhouse Accounts.
- [4] Bender, D.A.,2009, A dictionary of food and nutrition. OUP Oxford.
- [5] Egg, J., B.C. Howard, J. Bass, N. Otte, and K. Hassman,2011, Geothermal HVAC. [electronic resource]: green heating and cooling. McGraw-Hill's **AccessEngineering**. New York: McGraw-Hill, [2011].
- [6] El Mogharbel, O., K. Ghali, N. Ghaddar, and M.G. Abiad,2014. Simulation of a localized heating system for broiler brooding to improve energy performance. International Journal of Energy Research, 38(1): p. 125-138.
- [7] Fuller, H., N. Dale, and C. Smith,1983. Comparison of heat production of chickens measured by energy balance and by gaseous exchange. The Journal of nutrition, 113(7): p. 1403-1408.
- [8] Hamilton, J., M. Negnevitsky, and X. Wang,2016. Thermal analysis of a single-storey livestock barn. Advances in Mechanical Engineering, 8(4).
- [9] Hollander, M., D.A. Wolfe, and E. Chicken,2013, Nonparametric statistical methods. John Wiley & Sons.
- [10] IEA,2007. Renewables for Heating and Cooling.
- [11] IEA,2011. Technology Roadmap Energy-efficient Buildings: Heating and Cooling Equipment.
- [12] International Energy Agency,2015, KeyWord Statistics 2015. International Energy Agency, 31-35 rue de la Fédération, 75739 Paris Cedex 15 France.
- [13] Ison, N., J. Rutovitz, and S. Harris,2011. NSW Business Energy Prices To 2020. Sidney, Australia: Institute for Sustainable Futures, University of Technology, Sydney prepared for the NSW Office of Environment and Heritage.
- [14] Kharseh, M. and B. Nordell,2011. Sustainable heating and cooling systems for agriculture. International Journal of Energy Research, 35(5): p. 415-422.
- [15] Meteotest,2016. Meteonorm Handbook.
- [16] **National Famer's Federation,2016. NFF Annual Review 2014-15.**
- [17] NFF,2012. Farm Facts.
- [18] Pachauri, R.K., et al.,2014, Climate change 2014: synthesis Report. Contribution of working groups I, II and III to the fifth assessment report of the intergovernmental panel on climate change. IPCC.
- [19] Rojano, F., P.-E. Bournet, M. Hassouna, P. Robin, M. Kacira, and C.Y. Choi,2015. Modelling heat and mass transfer of a broiler house using computational fluid dynamics. Biosystems Engineering, 136: p. 25-38.
- [20] Shannon, D. and W. Brown,1970. A calorimetric estimate of the efficiency of utilisation of dietary energy by the growing cockerel. British poultry science, 11(1): p. 1-6.
- [21] U.S. Dept. of Energy,2016. Energyplus Engineering Reference.

Session 7.11: Processes, Design, Tools and Methodologies in SBE (5)

Measuring Sustainability in Buildings Using Construction Materials Database Based on Life Cycle Information in Turkey

İlker KAHRAMAN^a, Hudai KARA^b

^a Yaşar University, Turkey, ilker.kahraman@yasar.edu.tr

^b Metsims, Turkey, hudai.kara@metsims.com

ABSTRACT

There has been an increase in demanding environmental performance information of building materials and systems (components) from policy makers, due not only to high resource use but also environmental impacts such as climate change, and from the designers of sustainable or high performance buildings through certification systems. Such information requires life cycle impact dataset with multiple impact indicators and are proposed to be used to assess the sustainability of a whole building. Turkish Construction Materials Life Cycle Database is formed including data from Turkish Life Cycle Inventory Database as well as data from products with Environmental Product Declarations. The database includes product and sector specific primary data sets as well as generic data reflecting Turkish manufacturing conditions. Data quality requirements for the database is very high, i.e. mainly primary data.

This database will be introduced and its relevance to Turkish green building sector will be discussed. The use of the database within the context of assessing the environmental impacts of a real building will be demonstrated. The database's relevance to the development of green building assessment schemes in Turkey as well as to the established assessment schemes will be discussed. Potential benefits of using the database in the Urban Regeneration in Turkey to assess at least greenhouse gas emissions and its **contributions to Turkey's** commitment for Kyoto Protocol II for reducing such emissions will also be speculated.

Keywords: life cycle, construction materials, database.

1. INTRODUCTION

Life Cycle Assessment studies are becoming more important in assessing sustainability of buildings due to the **sector's huge impacts on climate change and resource use such as materials, energy and water. Over 40% of carbon emissions, 50% of resource use is attributed to the sector.** Embodied energy and carbon, which refers to energy and emissions during manufacturing of materials, becomes important part of building life cycle. Although its effects are reduced over the building life cycle due to long life of buildings, its effects are immediate, i.e. when a built is constructed, and will be even more prominent when energy efficient and/ or passive houses becoming more prominent. As such, demolition of a building is also relevant. As the awareness of the topic in the built environment has been increasing and the environmental concerns have been paid more attention to, the construction sector is led to Kyoto Protocol. The EU regulations are also focusing on resource efficiency and energy performance through Energy Performance of Buildings Directive 2002/ 91/ EC.

Several building assessment schemes have been developed in the built environment and construction sector. The well-known schemes are British BREEAM, American LEED, German DGNB. Turkish Green Building Council (**ÇEDBİK**) **also develop the first local scheme for new homes.** Each scheme has its own set of methodologies, some common some differs among them, to assess sustainability in a building context. To make such assessment more measurable and comprehensive, Life Cycle Assessment (LCA) is becoming an important element of these assessment schemes.

Embodied energy demand of a building is about one fourth of a total building energy demand. This ratio, however, increases for well insulated homes and for passive houses. As such embodied energy and carbon are becoming an important indicator for the sustainability of buildings. A cradle-to-grave LCA study can present the energy demand, carbon emission for climate change and other midpoint and endpoint impact indicators of a whole building from raw material extraction to manufacturing, construction and the end-of-life phases.

Construction materials with environmental indicators such as embodied energy and carbon is becoming widely available thanks to ISO 14025 Environmental Product Declaration (EPD) for products. An EPD is third-party (external) verified and registered document that communicates transparent and comparable information about the life-cycle environmental impact of products. LCA is always needed to obtain all the indicators required by EPDs.

Database containing life cycle environmental impacts of construction materials manufactured in Turkey have been developed to facilitate the assessment of environmental impacts of buildings. Compliant to international standards and called Turkish Construction Materials Life Cycle Database, it contains not only branded product specific but also generic datasets relevant to Turkey taken from Turkish Life Cycle Inventory Database (TLCID)]. So far with over 200 high quality datasets and growing with daily additions, it is comprehensive enough to become an important element of assessment schemes developed in Turkey. Such database is also useful for international green building assessment schemes that requires calculation of LCA as part of assessment, for example LEED and BREEAM. More importantly for Turkey, the Database will facilitate the calculation of carbon footprint for any Urban Regeneration project to be registered for the Kyoto Protocol II commitments. This paper demonstrates the use of this database to assess the environmental impacts of a multi-storey residential building reflecting the local conditions and makes the assessment relevant to Turkey.

2. METHODOLOGY

A four-storey residential building with 1200 square meter area constructed in Turkey was used for the case study (Figure 1). All the materials and assembly information of the building was taken from an earlier PhD study. The building is divided into the following components:

- Foundation
- Structure
- Coverings
- Internal Walls
- External Walls
- Profiles
- Glazing
- Roof



Figure 79: Architectural details of the buildings design used for the study

Building inventory involving all the above components was gathered from the design and insulation reports. The functional unit was considered as the entire building with 1200 gross sq. meters. The system boundary was determined to include the raw materials extraction from the nature, transportation from/ to raw material treatment, transportation to production site, manufacturing, fuel and energy consumptions. Datasets for Turkish electricity mix and natural gas mix is part of the Database taken from the TLCID database.

Many combinations area available for the types of components to use. For example, a flat-roof with tile covering but no insulations which was part of the assessment is shown in Figure 2. The following materials are required to assemble 1 m² of such roof:

- 12 kg ceramic tiles
- 2 kg cement based adhesives
- 0.1 kg geotextile felt
- 0.8 kg polymeric modified bituminous water proofing membrane
- 154.14 kg screed for inclined purposes (7 cm)
- 364 kg concrete slab (15 cm)
- 12.6 kg steel reinforcement
- 5 kg gypsum plaster (5 cm)

The rood component shown in Figure 2 can be modified to include insulation materials with various thicknesses such as XPS, EPS, Rockwool, Glasswool etc. Other sections of the component can also be modified per the architectural design requirements. Such flexibility is available for all components of the building highlighted above. Such flexibility gives the designer to do life cycle design study at an early stage of the design and find the best compromise between building cost, environmental impacts and life cycle cost.

All the inputs were inserted into SimaPro LCA software tool with Turkish Construction Materials Life Cycle Database. All environmental impacts are assessed in accordance with EN 15978 norm per total amount and per

square meter. Only building materials stage A1-3 (Figure 3) is considered in this study. The other stages can easily be included to complete the full life cycle assessment. For the use phase, energy consumption figures from energy certificates can be used and match with the latest Turkish energy specific impacts from the Database.

Inventory for all other remaining building components were also collected to complete the assessment. Indicators per square meter is calculated.

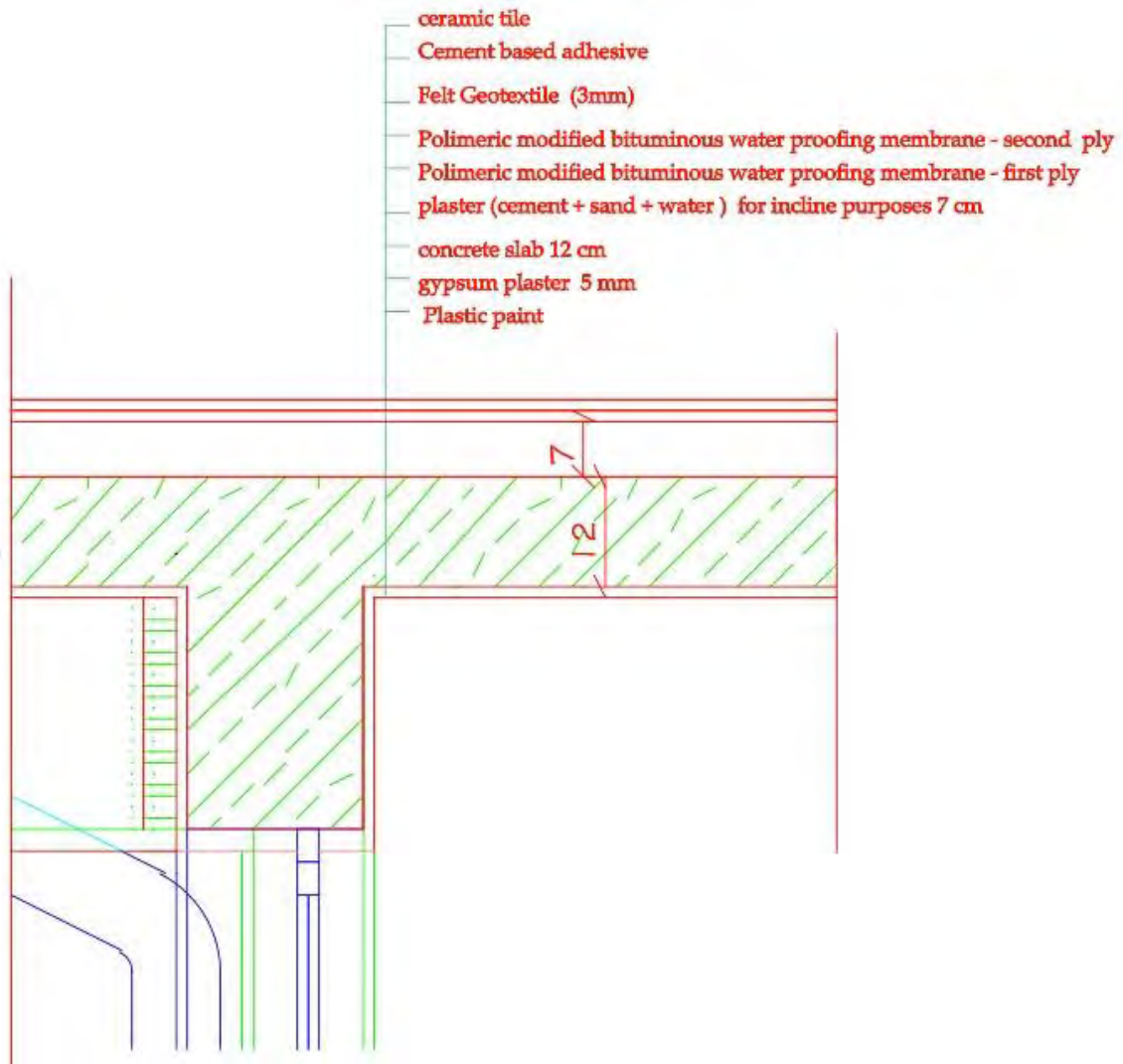

Figure 80: Design detail of flat roof component without any thermal insulation

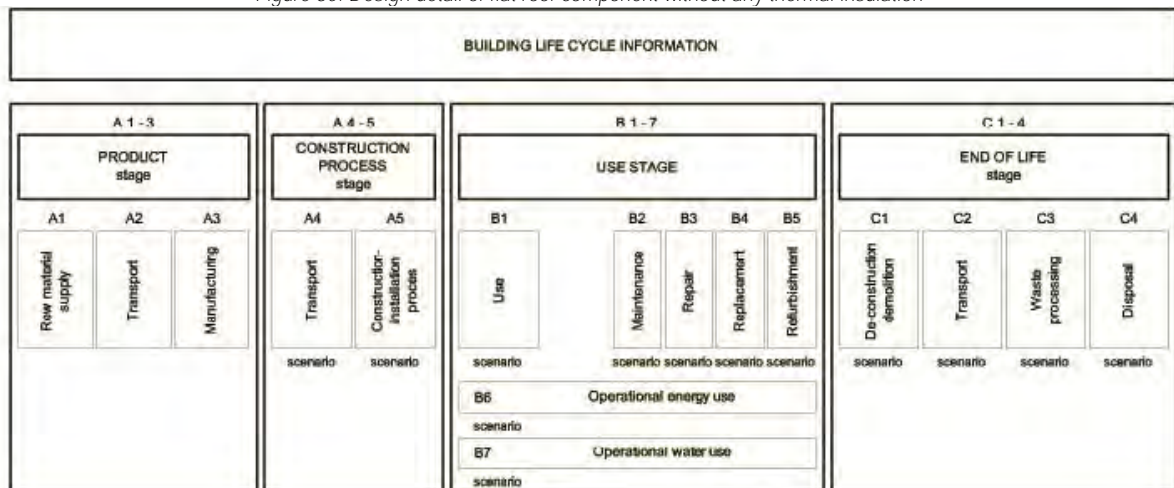

Figure 81: Different stages of the building life cycle assessment according to EN 15978

Figure 4 represents a system boundary flow from raw materials extraction to end of life stage over a buildings life time in compliance with EN 15978 standard. This LCA study focuses on the Global Warming Potential (GWP) and Energy Demand (CED) because of construction materials use, i.e. embodied carbon and energy demand of the construction materials.

The GWP impact is calculated using IPCC 2013 GWP 100a ver. 1.2 methodology that contains the climate change factors with a timeframe of 100 years. For embodied energy, Cumulative Energy Demand ver. 1.09 methodology is used.

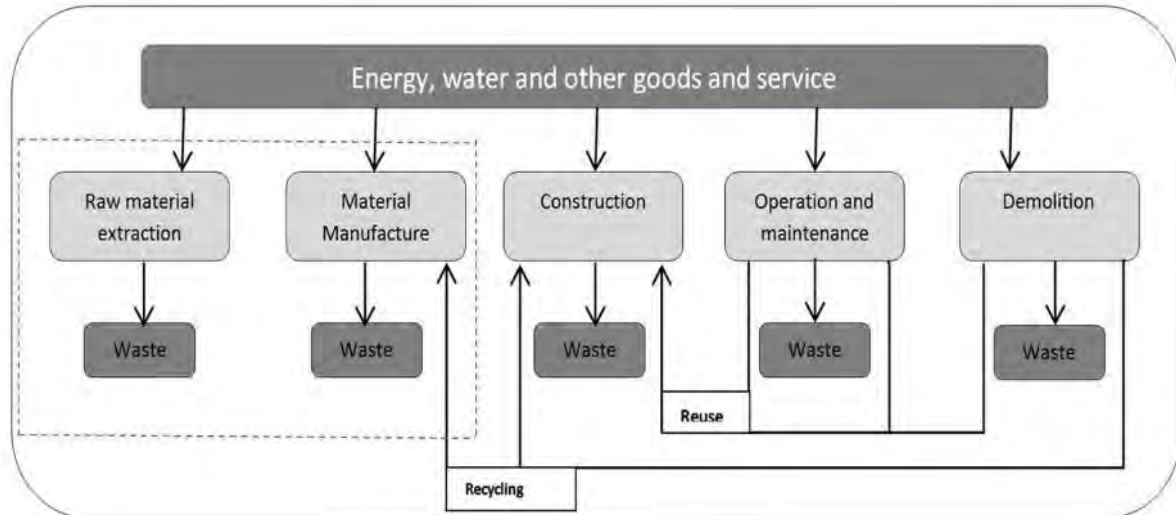

Figure 82: System boundary across the building life cycle

3. RESULTS

The GWP impact of all building components for 1200 square meter building are shown in Figure 5. As seen, structure and foundations are two building components with about 29% and 28%, respectively, the dominant embodied carbon impacts among all building parts. The total carbon impact of the building due to materials use (A1-3) is 476 913 kg CO₂ eq. The values and relative contributions of each building components per one square meter of the building is shown in Figure 6. GWP per square meter is about 397 kg CO₂ eq.

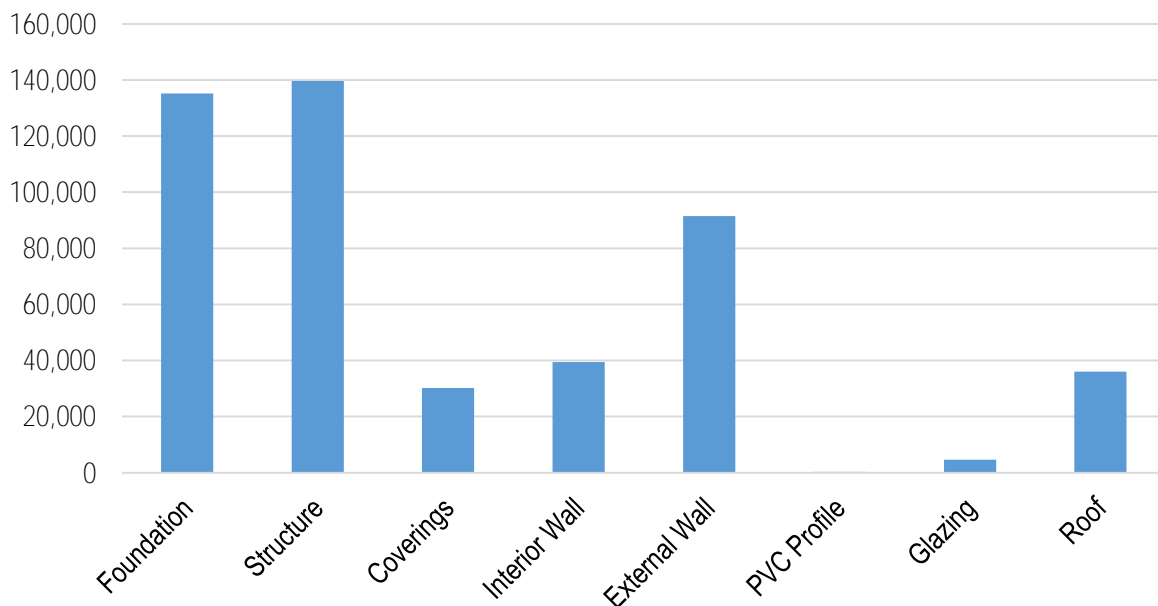

Figure 83: GWP of each building component and their relative contributions to climate change

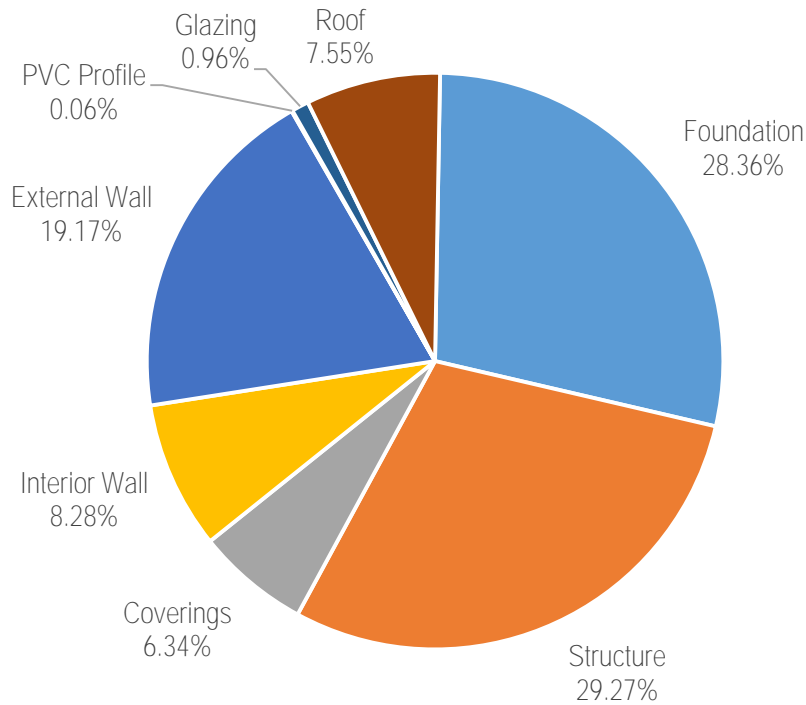

Figure 84: GWP distribution among building components per square meter

When the embodied energy consumption of building was examined, it was found that fossil energy sources are the most prominent (Table 1). Total embodied energy consumption of the building is $5.25\text{E}+06$ MJ. Per square meter this is calculated to be $4.38\text{E}+03$ MJ. of which only small fraction of about 315.2 MJ is coming from renewable primary energy resources.

Although this paper is focusing on the embodied carbon and energy, other relevant environmental impacts at building level can also be calculated. This is also the requirement of the EN 15978 building life cycle assessment norm. This is done using a CML-IA baseline methodology (ver. 4.02). The results of the methodology are presented in Table 2.

Parameter	Unit	Building Level	Per sqm
Use of renewable primary energy excluding resources used as raw materials	[MJ]	$3.78\text{E}+05$	315
Use of renewable primary energy resources used as raw materials	[MJ]	0	0
Total use of renewable primary energy resources	[MJ]	$3.78\text{E}+05$	315
Use of non-renewable primary energy excluding resources used as raw materials	[MJ]	$4.88\text{E}+06$	4064
Use of non-renewable primary energy resources used as raw materials	[MJ]	0	0
Total use of non-renewable primary energy resources	[MJ]	$4.88\text{E}+06$	4064
Use of secondary material	[kg]	0	0
Use of renewable secondary fuels	[MJ]	0	0
Use of non-renewable secondary fuels	[MJ]	0	0

Table 16: Whole building LCA results for embodied energy

Parameter	Unit	Building Level	Per sqm
Global Warming Potential	[kg CO ₂ eq.]	4.70E+05	391.9
Ozone Depletion Potential	[kg CFC11 eq.]	2.10E-02	0.0
Formation potential of tropospheric ozone photochemical oxidants	[kg ethane eq.]	1.11E+02	0.1
Acidification Potential	[kg SO ₂ eq.]	1.49E+03	1.2
Eutrophication Potential	[kg PO ₄ ³⁻ eq.]	5.00E+02	0.4
Abiotic depletion potential for non-fossil resources	[kg Sb eq.]	6.39E-01	0.0
Abiotic depletion potential for fossil resources	[MJ eq.]	4.88E+06	4062.7

Table 17: Whole building LCA results for environmental indicators (CML-IA baseline method ver.4.02)

4. CONCLUSIONS

Turkish Construction Materials Life Cycle Database is developed in compliance to international standards and European EN 15804 construction product norm. The Database contains high quality product specific datasets for Turkish construction materials as well as Turkish electricity and natural gas mix. Therefore, any study conducted using the Database will be highly relevant to Turkey and the results will be more precise contrary to studies using generic databases.

Environmental impacts evaluations of four-storey residential building using life cycle information from materials can be calculated to measurable indicators such as climate change effects. Embodied energy and carbon area two indicators that refers to carbon emissions, climate change effects and resource use due to construction materials. Besides, other environmental indicators are also available to measure if necessary such as acidification, eutrophication and so on.

Existing or future green building assessment schemes in Turkey will be able to utilize the Database. Such schemes will be more valuable when environmental indicators per square meter area provided to the end users is communicated. The Database also provides the opportunity to bring life cycle assessment to non-LCA experts such as architects, green building designers and other engineers.

The Database will open the way to conduct environmental impact assessment of any type building using Turkish specific datasets. As such, measuring carbon impacts from the so called Urban Transformation projects in Turkey **will be an excellent opportunity to achieve Turkey's Kyoto II commitments. By doing so, future carbon burden on the industrial sectors will be minimized.** This is a life-time opportunity not to be missed by the policy makers and all other stake holders.

REFERENCES

- [1] Roadmap to a single European transport area. (2011). Brussels: European Commission, p.571.
- [2] Buyle, M., Braet, J., Audenaert, A. (2013). Life cycle assessment in the construction sector: A review. *Renewable and Sustainable Energy Reviews*. 26, pp. 379-388.
- [3] The International EPD System. (2016). What is an EPD? Available: <http://www.environdec.com/en/What-is-an-EPD/>. Last accessed 26/07/2016.
- [4] Turkish Life Cycle Inventory Database, Turkish Centre for Sustainable Production Research and Design (SÜRATAM), [Online], Available: <http://www.surdurulebiliruretimmerkezi.org/>, 2014-2016.
- [5] **Kahraman, I 2013, 'A Sustainable Building Assessment Model** Proposal for New Residential Buildings in Turkey, PhD Thesis, Dokuz Eylül University Graduate School of Natural And Applied Sciences, Izmir, TURKEY.
- [6] Khasreen, M.M., Banfill, P.F.G. & Menzies, G.F., 2009. Life-Cycle Assessment and the Environmental Impact of Buildings: A Review. *Sustainability*, 1(3), pp.674–701. Available at: <http://dx.doi.org/10.3390/su1030674>.
- [7] European Standard. EN 15978 Sustainability of construction works - Assessment of environmental performance of buildings - Calculation method, European Committee for Standardization, November, 2011, pp. 21.

When Digital Fabrication Provides Environmental Benefits: Study of Complex Structures

Isolda AGUSTÍ-JUAN^a, Guillaume HABERT^b

^a Chair of Sustainable Construction, ETH Zürich, Switzerland, agusti@ibi.baug.ethz.ch

^b Chair of Sustainable Construction, ETH Zürich, Switzerland, habert@ibi.baug.ethz.ch

ABSTRACT

The construction sector is the responsible of significant environmental impacts worldwide, such as 40% of natural resources consumption and 40% of total waste generation. Consequently, a change in design and construction is needed to improve sustainability aspects in construction. Digital fabrication represents a feasible solution for the low levels of innovation, efficiency and sustainability present in the sector. Initial sustainability assessments of 3D printing have clearly revealed the potential of digital technologies to achieve environmental benefits compared to conventional processes. However, digital fabrication in architecture presents new formal, technological and material challenges where further demands must be met. Advances in computer-aided design and robotic additive fabrication challenge architects to design and construct non-standardised complex building structures. Nevertheless, complexity has been often considered a negative factor in sustainable construction, responsible of an increase of material, labour and waste in the projects. This paper investigates the environmental potential of digital fabrication methods applied to complex concrete structures. Furthermore, this research studies how formal and structural complexity in architecture influences the environmental performance of a project. With this objective, the Life Cycle Assessment (LCA) method was used for the evaluation of an innovative robotic construction process applied to a wall structure and its comparison with a conventional element with the same function. The results of the assessment demonstrated that digital fabrication becomes a feasible construction technique for non-standard complex structures. In the case study evaluated, digital fabrication provided environmental benefits compared to conventional techniques for the construction of complex structures.

Keywords: life-cycle assessment, digital fabrication, complexity

1. INTRODUCTION

The construction sector is one of the least sustainable industries in the world. Specifically, buildings are responsible for 40% of global energy consumption, 38% of global greenhouse gas emissions, 12% of global potable water use, and 40% of solid waste generation in developed countries (UNEP, 2012). Faced with these environmental problems, the sector has an impressive potential improvement. However, commitments to sustainability in building construction remain weak and fragmented. A change in how we design, construct or use the buildings and their environment will establish a situation of improvement in not only environmental, but also economic and social aspects. Over the last 15 years, the advances in Computer-Aided Design software have enabled the conception of innovative and complex forms in architecture. Architects such as Frank Gehry & Associates or Zaha Hadid have demonstrated the potential of employing digital technologies for the design of high complex structures (Dunn, 2012). However, this shift in the design process has new formal and technological challenges where further demands must be met.

The construction sector is a traditional industry, which requires the implementation of innovative construction processes to face this increased structural complexity in architecture. Contrarily, digital technologies are broadly used in the manufacturing industry and technologies such as 3D printing have become an essential part of modern product development (Hague et al., 2003). The increasing impact of digital technologies in the society has fostered novel research in digital construction processes applied to building systems (Willmann et al., 2016). Digital fabrication processes allow on-site mass-customised construction of complex and unique architectural forms and structurally optimised structures, which would suppose elevate costs in conventional construction. Digital fabrication aims to radically change traditional construction processes with the implementation of innovative methods that potentially reduce material and labour costs, time and improve the efficiency in construction. However, the attempt to implement digital fabrication technologies in the construction sector presents many potential challenges and benefits, such as sustainability issues, that should be analysed.

Over the last years, several studies have addressed sustainability aspects in the building industry (Passer et al., 2012). Specifically, the Life cycle assessment (LCA) methodology is nowadays internationally applied within the sector for evaluating the environmental impacts of construction materials and buildings (Ortiz et al., 2009). However, scarce conclusive environmental assessments of large-scale digital fabrication processes are present in literature. Most published studies related to sustainability aspects in digital fabrication focus on small-scale additive processes. For instance, Kreiger and Pearce (2013) found that distributed manufacturing through 3D printing can reduce the cumulative energy demand by 41–64 % compared to large-scale production. Similarly, Faludi et al. (2015) highlighted the reduction of waste and energy consumption with 3D printing compared to traditional CNC milling. Finally, Gebler et al. (2014) assessed 3D printing technologies from an environmental, social and economic perspective. However, few of these studies were quantitative, consequently, applied research on the environmental implications of digital technologies, particularly at the architectural scale, is required.

Digital design and robotic fabrication developments facilitate an increased complexity in architecture, which implications need to be evaluated. The potential of these new construction processes to improve sustainability in construction is promising (Rahimi et al., 2009), but complexity aspects may affect the environmental performance of the projects. Therefore, the aim of this paper is to understand in which boundary conditions we can expect an environmental benefit from digitally fabricated architecture. Consequently, this research analyses the potential environmental opportunities of additive robotic fabrication compared with traditional construction techniques. Specifically, the paper presents the life-cycle assessment of the case study of a novel robotic fabrication approach applied to a complex concrete wall compared with a conventional structure with the same functional and structural performance.

2. METHODOLOGY

The method selected for the evaluation of the case study is the Life Cycle Assessment (LCA) framework present in the ISO 14040-44: 2006 standards (ISO, 2006a; ISO, 2006b). LCA has been commonly used in many industrial sectors to evaluate and compare the environmental load of processes and products during their life cycle. Furthermore, over the past 20 years, LCA has become a widely used methodology for evaluating the impact of materials, construction elements and buildings (Chen et al., 2010; Damineli et al., 2010; Purnell and Black, 2012). LCA method was applied in this paper to compare the difference in environmental impacts between digital fabrication and conventional construction processes. Specifically, we performed a life cycle evaluation introducing variability on the functional unit with an increased complexity on the structural element. Specifically, we varied the type of formwork in the conventional structure and the volume of concrete and steel in the digitally fabricated to understand in which type of projects digital fabrication brings environmental benefits. The LCA method was implemented in the software SimaPro 8 using the Ecoinvent v3.1 database (Weidema B. P., 2013) and the Recipe Midpoint (H) v1.12 impact method (Goedkoop et al., 2009). The selected impact categories were climate change (kg CO₂ eq.), ozone depletion (kg CFC-11 eq.), human toxicity (kg 1.4-DB eq.), terrestrial acidification (kg SO₂ eq.), freshwater eutrophication (kg P eq.), terrestrial ecotoxicity (kg 1.4-DB eq.), freshwater ecotoxicity (kg 1.4-DB eq.), water depletion (m³), metal depletion (kg Fe eq.) and fossil depletion (kg oil eq.).

3. CASE STUDY: MESH MOULD

The case study selected for the evaluation is Mesh Mould, a research project from Gramazio Kohler Research, ETH Zürich. This novel construction system is based on the combination of the formwork and reinforcement in a single element. This element is a mesh robotically fabricated in a process of bending and welding steel wires (Hack et al., 2015). Mesh Mould combines two labour intensive processes, installation of formwork and reinforcement, which are responsible for over 50% of the overall economic cost of conventional concrete structures (Robert, 2007). The project studies the potential of these bespoke formworks for non-standard concrete structures, which can be efficiently fabricated on-site. The robotic approach simplifies the building process, while allowing a higher architectural complexity. As a result, the structure is no longer restricted to planarity or single curvature and it can be geometrically complex and individually adapted to the forces that act upon the mesh (Hack et al., 2013). Figure 1 shows one of the recent prototypes of Mesh Mould project.



Figure 1: Robotically fabricated metal Mesh Mould structure

3.1 Definition of system boundaries and functional unit

The case study was focused on the analysis of the production and construction phases of a wall constructed with this system. The cradle-to-gate analysis performed included material extraction and transport, building materials and digital technologies production and robotic fabrication (EN 15978 modules: A1-A3, A5). Operation and end-of-life stages were excluded from the case study evaluation due to the early state of research. The functional unit of the case study was 1 m² of reinforced concrete wall with a specific structural performance. In the current evaluation, two systems were compared: a 1 m² Mesh Mould wall designed and constructed with digital fabrication techniques and 1 m² of a conventional reinforced concrete wall system.

3.2 Data collection

The materials and the energy consumption for the fabrication of a wall with the Mesh Mould process and a conventional reinforced concrete wall are studied in the following section. Thereafter, the scenarios for both wall systems are summarised for the later environmental comparison.

Mesh Mould wall

The concrete in the Mesh Mould wall is more demanding than in the conventional technique. Beside the structural performance, the behaviour of the concrete influences the protrusion rate through the outer perimeter and the roughness of the surface. In response to these criteria, the Institute for Building Materials (IFB) at ETH Zürich developed a special concrete mixture with an optimised filling process (Hack *et al.*, 2015). Based on the increased amount of Portland cement (500 kg/ m³), which nearly duplicates the amount in ordinary C25/ 30 concrete, the compression strength of the ETHZ IFB concrete is higher (Habert *et al.*, 2012). Consequently, an improved scenario with concrete reduction was analysed. The reinforcing steel is formed by metal wires with a diameter of 3 mm form the three-dimensional mesh of the Mesh Mould wall. The steel used was B500A, with the same tension yield strength $f_{yk} = 500 \text{ N/ mm}^2$ as a conventional reinforcement, but less ductile material. For the standard Mesh Mould scenario, **we assumed the same steel fraction as a conventional reinforced wall**, $\rho_{MM} = 0.7\%$ of the wall volume (CEN, 2004). Based on the previous value, we established a realistic range with the minimum and maximum reachable reinforcement content.

Additionally to the materials, the embodied energy of the digital fabrication technologies was included in the Life Cycle Inventory (LCI) of the Mesh Mould wall. This included the production of **the “In-Situ Fabricator” construction robot** and a customised tool for welding, bending and cutting the mesh (NCCR Digital Fabrication). Specifically, the tool has an approximate mass of 10 kg and it is mainly composed by aluminium. The service life assumed for the robot and the tool was a period of 10 years. Finally, the energy consumption during construction was calculated based on the operation time and power supply of the robot. The tool head had a theoretical building speed of 10 h for a prototype mesh of 1 m². The construction robot is electrically powered by lithium-ion batteries with a total capacity of 5.1 kWh, which enable the robot to operate for 3–4 h without being plugged in (Dörfler *et al.*, 2016). As a result, the total energy demand E_{MM} for the construction of the wall with the Mesh Mould technique was 17 kWh.

Based on the previous data collection, three scenarios were analysed:

- Best scenario: The optimal performance of the Mesh Mould wall was characterised by the minimal reinforcement steel volume fraction $p_{MM,min}=0.5\%$ and the thickness of the wall was reduced to $t_{MM,min} = 0.1$ m, the limit given by the calculation of the slenderness criteria.
- Reference scenario: Wall thickness of $t_{MM} = 0.2$ m and reinforcement volume fraction of $p_{MM}=0.7\%$, same parameters as a conventional wall.
- Worst scenario: The buckling failure might request a wall thickness of $t_{MM} = 0.2$ m and additional complications with the mesh could lead to a reinforcement steel content of up to $p_{MM,max} = 1.5\%$.

The LCI of the reference scenario of Mesh Mould wall is summarized in Table 1.

Flow	Unit	Amount
Construction robot production	p	$1.14 \cdot 10^{-4}$
Bending/Welding tool, production	p	$1.14 \cdot 10^{-4}$
Concrete ETHZ IFB, production	m ³	0.2
Reinforcing steel, production	kg	11
Electricity, medium voltage, market	kWh	17

Table 1. Life cycle inventory of a mesh mould wall construction process (1 m²).

Conventional concrete wall

A reinforced concrete wall with a thickness of 0.2 m was taken as a reference. The concrete used was C25/ 30, characterised by its strength compression of $f_{ck} = 25$ N/ mm². The reinforcement steel was an ordinary, highly ductile B500B, with a tension yield strength $f_{yk} = 500$ N/ mm². A steel fraction of 0.7% of the volume of the conventional reinforced wall was assumed. The formwork chosen for each scenario varied according to the complexity of the wall. On the one hand, a traditional three-layered laminated board formwork was selected for the straight wall. On the other hand, the double-curved wall was constructed with a free form polystyrene formwork. This system is composed by polystyrene blocks covered by a 5 mm layer of epoxy resin. Moreover, the data inventory included the energy demand for hot-wire cutting the formwork, 30% of waste polystyrene produced, and the landfill deposition after use in the data inventory. The energy demand of the formwork production was calculated based on the speed (1500 mm/ min) and power (600 W) of a 2-axis wire-cutting machine.

Two scenarios were investigated for the conventional reinforced concrete wall:

- Standard scenario: Straight wall of thickness $t_{wall} = 0.2$ m, where the formwork is reused 10 times.
- Complex scenario: Double-curved wall of thickness $t_{wall} = 0.2$ m, constructed with non-reusable polystyrene formwork.

4. RESULTS

The range of environmental impacts product of the material dependent Mesh Mould scenarios compared with the complexity dependent conventional wall scenarios are illustrated in Figure 2.

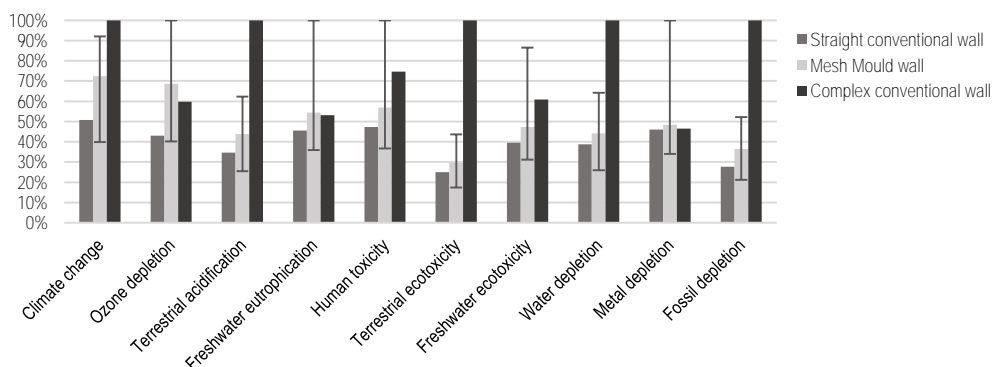

Figure 2: LCA comparison of the Mesh Mould wall with a standard and complex conventional wall. Error bars represent the best and worst scenarios of the Mesh Mould wall

The previous figure demonstrates that the optimisation of the Mesh Mould wall, with 50% of thickness reduction, leads to less concrete usage and decreases 33% of CO₂ emissions compared to the reference scenario. Furthermore, the results show the importance of an efficient steel usage. The environmental emissions of Mesh Mould grow 30% average, compared to the reference scenario, with the maximum steel content. In general, the results indicate that the best scenario of the Mesh Mould wall is responsible for lower environmental impacts than a conventionally constructed straight concrete wall. Specifically, the best scenario of the Mesh Mould wall reduced the emissions by 3-13% depending on the indicator. However, a less optimised Mesh Mould wall (worst scenario) is clearly less environmentally performant than a conventional straight wall.

The results graphically depicted in Figure 2 prove that the reference Mesh mould system brings currently environmental benefits compared to the double-curved concrete wall constructed with conventional techniques. Only in three midpoint categories, the reference scenario of Mesh Mould shows greater impacts than the complex conventional scenario, but the difference is negligible (1-9%). This result is mainly due to the use of polystyrene formwork for the construction of complex walls, which increases the impacts. Finally, we observe that the worst scenario of the robotically fabricated wall can still environmentally compete with the complex conventional wall in categories such as Terrestrial acidification and Fossil depletion. Consequently, the complexity is a key factor to consider during the comparison with conventional construction since the environmental impact of the Mesh Mould process does not grow with the uniqueness and complexity of the architectural form.

5. DISCUSSION & CONCLUSION

In this paper, we evaluated the environmental potential of an innovative digital fabrication process for the construction of high complex concrete structures. The LCA performed allowed its comparison with conventional construction. Furthermore, we analysed how formal and structural complexity in architecture influences the environmental performance of a project. Complexity is an architecture characteristic, which costs and value creation has been often discussed. In the last few years, technological advances challenged architects to design increasingly complex architectural structures. However, complexity has been often considered a negative factor in sustainable construction, responsible of an increase of material, labour and waste in the projects.

The Mesh Mould system allowed higher structural complexity while simplifying the construction process. The study demonstrated that robotic fabrication becomes a feasible construction technique for non-standard structures. But most important, the results highlighted the importance of digital fabrication to achieve environmental benefits in complex structures. Contrary to conventional construction, the impact of the Mesh Mould process did not change with an increase of the uniqueness and complexity of the architectural forms. Therefore, the environmental potential of this digital fabrication process increased proportionally to the required effort relative to the conventional technique. The study demonstrated that the current Mesh Mould system can environmentally compete with conventional structures when both have a high degree of formal and structural complexity. Simultaneously, the results highlighted the need for improvement to compete at a lower degree of complexity. The digitally fabricated wall required material optimisation (thickness reduction) to achieve environmental benefits compared to a standard reinforced concrete wall.

ACKNOWLEDGMENTS This research was supported by the National Competence Centre for Research, NCCR Digital Fabrication, which was funded by the Swiss National Science Foundation (project number 51NF40_141853).

REFERENCES

- [1] CEN. 2004. Eurocode 2: Design of Concrete Structures-Part 1-1: General Rules and Rules for Building. EN 1992-1-1
- [2] Chen, C., Habert, G., Bouzidi, Y., Jullien, A. and Ventura, A., 2010. LCA allocation procedure used as an incitative method for waste recycling: an application to mineral additions in concrete. *Resources, Conservation and Recycling*, 54(12), 1231-1240.
- [3] Damineli, B.L., Kemeid, F.M., Aguiar, P.S. and John, V.M., 2010. Measuring the eco-efficiency of cement use. *Cement and Concrete Composites*, 32(8), 555-562.
- [4] Dörfler, K., Sandy, T., Gifftaler, M., Gramazio, F., Kohler, M. and Buchli, J., 2016. Mobile Robotic Brickwork. In: Reinhardt, D., Saunders, R. & Burry, J. (eds.). *Robotic Fabrication in Architecture, Art and Design 2016*. Cham: Springer International Publishing.
- [5] Dunn, N., 2012. *Digital fabrication in architecture*. London: Laurence King Publishing Ltd.
- [6] Faludi, J., Bayley, C., Bhogal, S. and Iribarne, M., 2015. Comparing environmental impacts of additive manufacturing vs traditional machining via life-cycle assessment. *Rapid Prototyping Journal*, 21(1), 14-33.
- [7] Gebler, M., Uiterkamp, A.J.S. and Visser, C., 2014. A global sustainability perspective on 3D printing technologies. *Energy Policy*, 74, 158-167.
- [8] Goedkoop, M., Heijungs, R., Huijbregts, M., De Schryver, A., Struijs, J. and van Zelm, R., 2009. ReCiPe 2008: A life cycle impact assessment method which comprises harmonised category indicators at the midpoint and the endpoint level. Den Haag.
- [9] Habert, G., Arribe, D., Dehove, T., Espinasse, L. and Le Roy, R., 2012. Reducing environmental impact by increasing the strength of concrete: quantification of the improvement to concrete bridges. *Journal of Cleaner Production*, 35, 250-262.
- [10] Hack, N., Lauer, W., Gramazio, F. and Kohler, M., 2015. Mesh Mould: robotically fabricated metal meshes as concrete formwork and reinforcement. *Ferro*, 11, 347-359.
- [11] Hack, N., Lauer, W., Langenberg, S., Gramazio, F. and Kohler, M., 2013. Overcoming Repetition: Robotic fabrication processes at a large scale. *International Journal of Architectural Computing*, 11(3), 285-300.
- [12] Hague, R., Campbell, I. and Dickens, P., 2003. Implications on design of rapid manufacturing. *Proceedings of the Institution of Mechanical Engineers, Part C: Journal of Mechanical Engineering Science*, 217(1), 25-30.
- [13] ISO. 2006a. 14040: Environmental management—life cycle assessment—principles and framework.
- [14] ISO. 2006b. 14044: Environmental management—life cycle assessment—requirements and guidelines.
- [15] Kreiger, M. and Pearce, J.M., 2013. Environmental life cycle analysis of distributed three-dimensional printing and conventional manufacturing of polymer products. *ACS Sustainable Chemistry & Engineering*, 1(12), 1511-1519.
- [16] Ortiz, O., Castells, F. and Sonnemann, G., 2009. Sustainability in the construction industry: A review of recent developments based on LCA. *Construction and Building Materials*, 23(1), 28-39.
- [17] Passer, A., Kreiner, H. and Maydl, P., 2012. Assessment of the environmental performance of buildings: A critical evaluation of the influence of technical building equipment on residential buildings. *The International Journal of Life Cycle Assessment*, 17(9), 1116-1130.
- [18] Purnell, P. and Black, L., 2012. Embodied carbon dioxide in concrete: Variation with common mix design parameters. *Cement and Concrete Research*, 42(6), 874-877.
- [19] Rahimi, M., Arhami, M. and Khoshnevis, B., 2009. *Crafting Technologies*. *Times Journal of Construction and Design*, 30-34.
- [20] Robert, H., 2007. Think formwork—reduce cost. *Structure magazine*, 14.
- [21] UNEP. 2012. *Building Design and Construction: Forging Resource Efficiency and Sustainable Development*.
- [22] Weidema B. P., B.C., Hischer R., Mutel C., Nemecek T., Reinhard J., Vadenbo C. O., Wernet G., 2013. Overview and methodology. *Data quality guideline for the ecoinvent database version 3*. St. Gallen.
- [23] Willmann, J., Knauss, M., Bonwetsch, T., Apolinarska, A.A., Gramazio, F. and Kohler, M., 2016. Robotic timber construction—Expanding additive fabrication to new dimensions. *Automation in Construction*, 61, 16-23.

Sustainable Building Design for Enhancement of Street Ventilation and Air Quality Improvement

Karl AN^a, Simon WONG Sze-ming^b, Jimmy FUNG Chi-hung^c

^a The Hong Kong University of Science and Technology, AECOM Environment, Hong Kong SAR, karlanlok@ust.hk

^b AECOM Environment, Hong Kong SAR, simon.sm.wong@aecom.com

^c The Hong Kong University of Science and Technology, Hong Kong SAR, majfung@ust.hk

ABSTRACT

Air pollutants from traffic in highly dense urbanized cities such as Hong Kong have negative impacts on human health. Without adequate ventilation, these pollutants would accumulate within street canyons formed by high rise buildings, an issue of great concern to the public. To create a healthy, liveable environment, collaborative efforts from environmental scientists, architects/town planners and developers are required to develop innovative building designs that reduce pollutant accumulation within street canyons. One recent design approach is the use of the **'Dragon Hole': a large void around the center of tall buildings that extends from pedestrian level to around half of the building height.**

To assess the effectiveness of the Dragon Hole design concept in Hong Kong, we conducted a sensitivity study of the level of pollutant accumulation within the street canyons due to changes in building permeability by varying the **size and location of the 'Dragon Hole'**. **Computational Fluid Dynamics (CFD) with the Shear-Stress-Transport $k - \omega$ turbulence model** was used to model an idealized urban area with traffic emissions, and six cases with different **permeability of the "Dragon Hole" building varying from 0% to 30% were investigated. Model validation was carried out by comparison with the wind tunnel experiment data from the Tokyo Polytechnic University.** The amount of pollutant accumulation at the source canyon was calculated and pollutant concentration profiles plotted under different cases within the source street canyon. Some discussion and recommendations will be presented for **adoption of 'Dragon Hole' design in Hong Kong and similar cities.**

Keywords: sustainable neighbourhood, adaptive design, air ventilation, pollutant dispersion, CFD turbulence model

1. INTRODUCTION

Pollutants accumulated within street canyons due to traffic emission have raised concern from the public living in high-density cities (WHO, 2008). Apart from controlling the pollutant emission amount, sustainable building designs have been suggested as another way to solve the pollution problem within urban regions (Yuan et.al, 2014). The **"Dragon Hole" building design, with a large void extending from pedestrian level to around half of the building height**, is an innovative building design not only beneficial for maintaining building connectivity, satisfying visual and geomantic concerns, but also for providing air ventilation corridors and possibly avoiding pollutant accumulation.

Computational fluid dynamics is a capable technique for understanding momentum and mass transport mechanisms within urban areas. Extensive studies have been conducted in understanding the wind flow patterns within both idealized and real cities by applying various turbulence models (Baskaran and Kashef, 1996; Blocken et al., 2009, 2015). Ng et al. aided in the development of Technical Circular No.1/06 for the industrial assessment of air ventilation performance in Hong Kong, in which air ventilation assessment has been implemented as a prerequisite for urban development and renewal. In addition, there are well established guidelines (Franke et al., 2004; AIJ, 2007) for carrying out robust CFD studies of urban wind environment. However, there are comparatively fewer studies on pollutant dispersion by application of the CFD technique compared to wind flow simulations. Most research has applied $k - \epsilon$ family turbulence models (Cheng et al., 2008; Salim et al., 2011) which produce less satisfactory predictions compared to the more computational costly unsteady models. Furthermore, the industrial applications of CFD in prediction of pollutant accumulation are still limited due to uncertainties in the choice of turbulence models and methodologies.

This study aims to put forward a sustainable building design to enhance air ventilation and quality, at the same time conducting a parametric study to explore the relationship between building permeability of the innovative “Dragon Hole” building design and level of pollutant accumulation. Furthermore, the study demonstrates the usage of a relatively robust and industrially affordable turbulence model in carrying out assessment of pollutant dispersion via the CFD technique.

2. METHODOLOGY

2.1 Model geometries

An idealized urban area in Figure 1 is formed by five surrounding sub-sites, each consists of 16 identical building blocks with length and width of $2W_s$, height $6W_s$, where $W_s = 10m$ being the width of streets. The sub-sites semi-circled the simplified “Dragon-Hole” building located at the upwind region. The targeted building has a width of $3W_s$, length of $11W_s$ and height of $12W_s$, with an opening extending from pedestrian level to a height of $6W_s$. Six different cases (Cases A to F) with varying width of opening corresponding to building permeability of 0%, 5%, 10%, 15%, 20% and 30% respectively are evaluated in this research on the pollutant removal and air ventilation performance within the street canyons by the use of ANSYS CFD package. Line sources representing traffic emissions releasing NO_2 tracer gas of 1ppm concentration with exit velocity of 0.5m/s are located at the main streets. The prevailing wind in this study is kept perpendicular to the permeable building in order to achieve the maximum performance of the “Dragon Hole” in each study case.

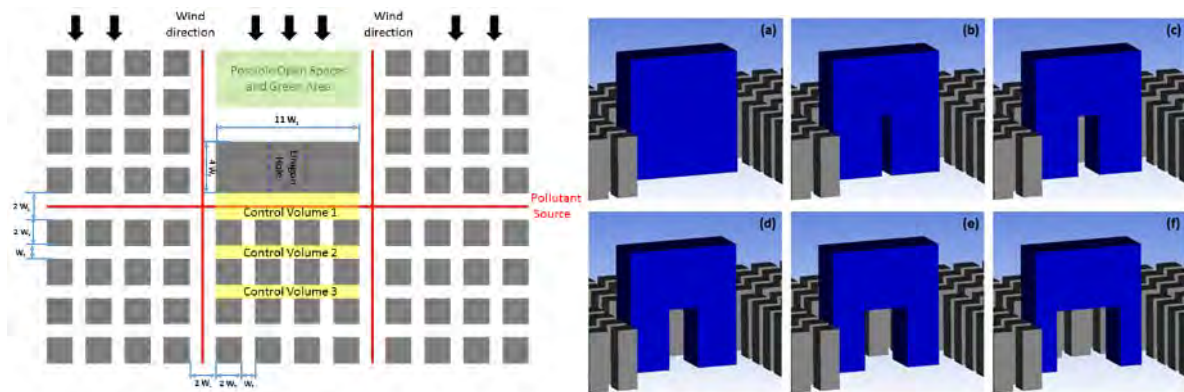

Figure 2: (Left) Top view of CFD model; (Right) geometries of different cases

2.2 Turbulence model description

The SST $k - \omega$ turbulence is a two equation eddy viscosity turbulence model which employs Wilcox's $k - \omega$ model at the near wall regions and switches to a $k - \epsilon$ formulation outside the boundary layer through the application of two blending functions. These combined features have proved beneficial in the prediction of adverse pressure gradient and flow separation. Detailed formulation of the SST $k - \omega$ model has been documented in Menter, 1993. Therefore, only the main closure equations and its eddy viscosity definition are provided here. In addition to the typical Reynolds averaged Navier-Stokes equation, the k and ω closure equations are defined as:

$$\frac{\partial k}{\partial t} + u_j \frac{\partial k}{\partial x_j} = \frac{\partial}{\partial x_j} \left[\left(\nu + \frac{\nu_t}{\sigma_k} \right) \frac{\partial k}{\partial x_j} \right] + P_k - \beta_* k \omega$$

Equation 1

$$\frac{\partial \omega}{\partial t} + u_j \frac{\partial \omega}{\partial x_j} = \frac{\partial}{\partial x_j} \left[\left(\nu + \frac{\nu_t}{\sigma_\omega} \right) \frac{\partial \omega}{\partial x_j} \right] + \alpha S^2 - \beta \omega^2 + 2(1 - F_1) \sigma_{\omega 2} \frac{1}{\omega} \frac{\partial k}{\partial x_j} \frac{\partial \omega}{\partial x_j}$$

Equation 2

with eddy viscosity definition $\mu_t = \frac{\rho a_1 k}{\max(a_1 \omega, S F_2)}$, where $a_1 = 0.31$ and S is the strain rate magnitude. The other model constants α , β , σ_k and σ_ω are blended across different regions through the blending functions F_1 and F_2 by $\varphi = F_1 \varphi_1 + (1 - F_1) \varphi_2$ where φ_1 and φ_2 being the corresponding constants for the inner and outer regions respectively. The default values of the SST $k - \omega$ model are more suitable for aerodynamics applications

rather than urban flow problems. As pointed out by Richards and Hoxey, a smaller value of β_* is often observed in field measurements of atmospheric boundary flows. Therefore, a reduced value of $\beta_* = 0.03$ is applied in this study. There is also modification in the diffusion constant of the outer region for the SST $k - \omega$ model as Poroseva and Iaccarino emphasized the importance of turbulence diffusion in unbounded flows and suggested to set $\sigma_\epsilon = 1.5$ for the $k - \epsilon$ model. The value of β_1 in the inner region is chosen to satisfy the ratio $\beta_*/\beta_1 = 1.27$ based on isotropic turbulence calibration. For the value in outer region, the relationship $\beta_2 = (C_{\epsilon 2} - 1)\beta_*$ where $C_{\epsilon 2} = 1.92$ should be satisfied. Furthermore, the simulations are carried out with a turbulent Schmidt number value of 0.7.

2.3 CFD model parameters and setup

The computational domain is rectangular in shape with size in compliance with the minimum recommendations documented in available CFD guidelines (Franke, 2006; Tominaga et al., 2008; Mochida et al., 2002; Shirasawa et al., 2003). There are approximately 18 million rectangular structured grids for each of the cases with the near wall meshes relatively fine to maintain a reasonable small dimensionless wall distance value. Other settings of the model are stated in Table 1 which followed those recommended in the COST Action C14 (Franke et al., 2004) and the Architectural Institute of Japan (AIJ) guidelines (Tominaga et al., 2008; AIJ, 2007).

The inflow wind and turbulent kinetic energy profiles for the CFD simulation cases adopted from Yuan et al., 2014 are shown in Figure 2. For the SST $k - \omega$ turbulence model, apart from the inflow TKE profile, another inflow specific dissipation rate profile defined as $\omega = \epsilon/C_\mu k$ (ϵ is the turbulent dissipation rate, k is the turbulent kinetic energy and $C_\mu = 0.09$) is required for closure.

Normalized concentration (C_+) defined as $C_+ = c/c_0$ where c is the simulated result of the averaged concentration of NO_2 and c_0 is the reference emission concentration is adopted as the indicator to analyse the effects of different "Dragon-Hole" building permeability on pollutant dispersion within street canyons. From the definition of C_+ , one can observe the smaller the value of C_+ the less the accumulation of pollutants within the street canyon while the higher the C_+ value, the higher is the pollution level.

	CFD model
Grid Expansion Ratio	1.2 in horizontal / vertical directions
Inflow Boundary Condition	Inflow Profiles adopted from Yuan et al., 2014
Outflow Boundary Condition	Zero gradient condition
Lateral and Top Boundary Conditions	Symmetric boundary condition
Turbulence Model	SST $k - \omega$ model with modified model parameters
Solving Algorithm	<ul style="list-style-type: none"> ➤ Pressure Velocity Coupling – SIMPLEX; ➤ Green Gauss node based gradient scheme for diffusion term; ➤ Second Order Upwind scheme for advection terms
Convergence Criteria	Scaled Residual dropped below 1×10^{-5} (Franke et al., 2006; Casey and Wintergeste, 2000)

Table 1: Summary of settings in the CFD model

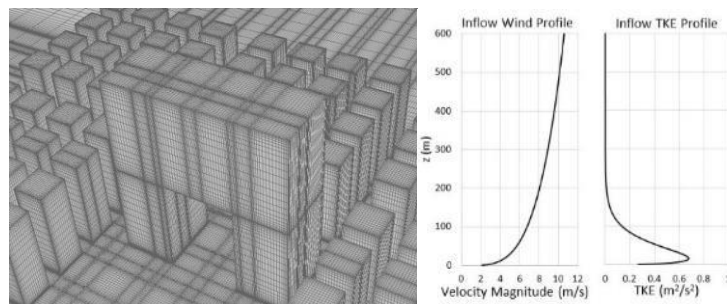

Figure 2: (Left) Mesh of the CFD model; (Right) Inflow velocity and turbulence kinetic energy profiles

3. MODEL VALIDATION

Wind tunnel experiment data under isothermal condition is available from an experiment on flow and tracer gas dispersion around a single block building conducted in the wind tunnel (cross section at measurement part: 1.2 m × 1.0 m) of Tokyo Polytechnic University (Tanaka et al., 2006). The wind tunnel experiment has been described in detail on the webpage of Architectural Institute of Japan, therefore, only the main features are presented in this paper. As illustrated in Figure 3, the model building has a dimensions of 0.2m in height, 0.1m for both width and depth (H:W:D = 2:1:1) situated in a turbulent boundary layer with power law index of approximately 0.25. A small area gas source was set on the floor 0.25H away from the leeward side of the model building releasing ethylene (C₂H₄) as a tracer gas at a volume flow rate of 5.83x10⁻⁶m³/s.

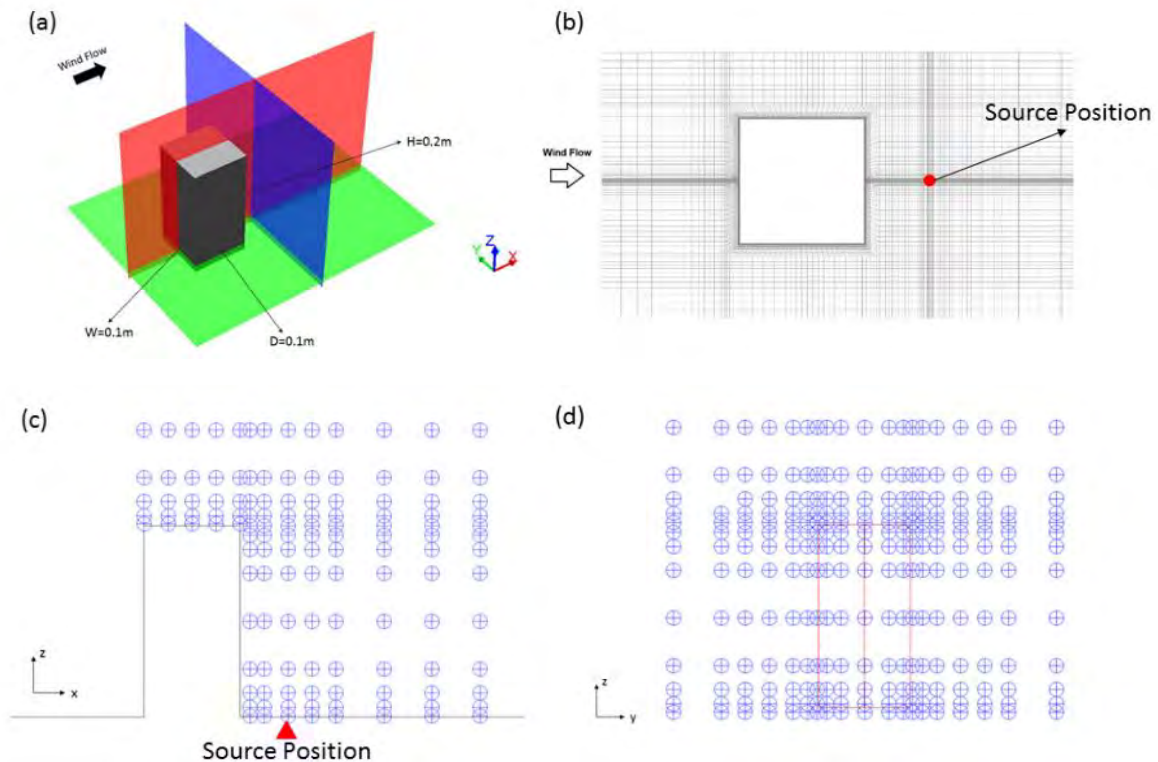

Figure 3: (a) Geometry; (b) Mesh; (c) X-Z measurement locations; (d) Y-Z measurement locations

Result Data from the CFD model simulation are compared with the experimental data on the X-Z, X-Y and Y-Z planes at measurement locations shown in Figure 3. As pointed out in Section 2.2 above, the default parameters for the SST k- ω turbulence model has been set to achieve best application for the aerodynamic flows while this set of model constants is not capable to produce best simulation results in match with experimental data for urban flow and dispersion problems.

By applying the set of modified model constants stated in Section 2.2 together with a turbulent Schmidt number value of 0.77, the CFD results from the SST model generally match well in both shape and magnitude with the experimental wind data downwind from the building obstacle as illustrated in Figure 4. The CFD simulation predicts relatively better within the near wake region compared to the far wake. In the far wake region, the velocity deficit from CFD simulation has a slower recover rate compared to the wind tunnel experiment.

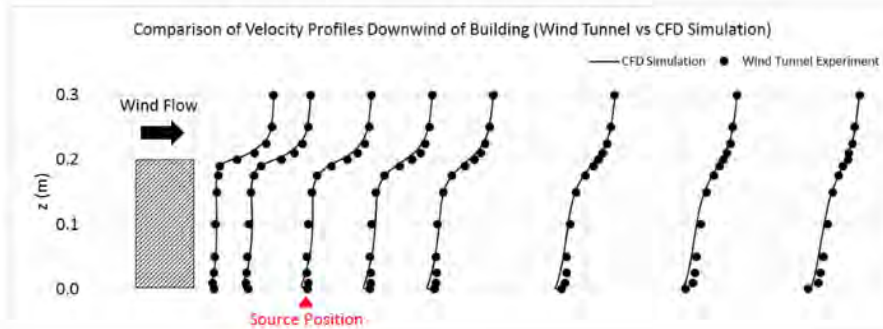

Figure 4: Comparison of wind velocity profiles between CFD and experiment downwind of building

Similar to the wind field prediction, a rather promising result between the wind tunnel experiment data and CFD simulation results has been achieved for the pollutant concentration prediction. From Figure 5, it is observed the pollutant concentration profiles are well predicted on the X-Y plane. There are a few test points (around 10% of the total amount of test points) in which the SST model over-/under-predicts the wind tunnel experiment with a percentage difference of several tens. It is noticed that the over-/under-prediction phenomenon of pollutant concentration by steady state CFD models has also been reported in previous studies (Gromke and Ruck, 2012; Yuan et al., 2014). However, the CFD results are able to achieve good correlation with experimental data with value of around 0.8 and 0.7 on the X-Z and Y-Z plane respectively. **In addition, majority of the test points' values** achieve an approximate deviation of +/-20% compared to wind tunnel experiment. Furthermore, Willemssen (2002) reported that wind tunnel experiment conservatively could have a standard error of 20% in measurement. Therefore, it is also worthwhile to take note that wind tunnel data also includes uncertainties to some extent.

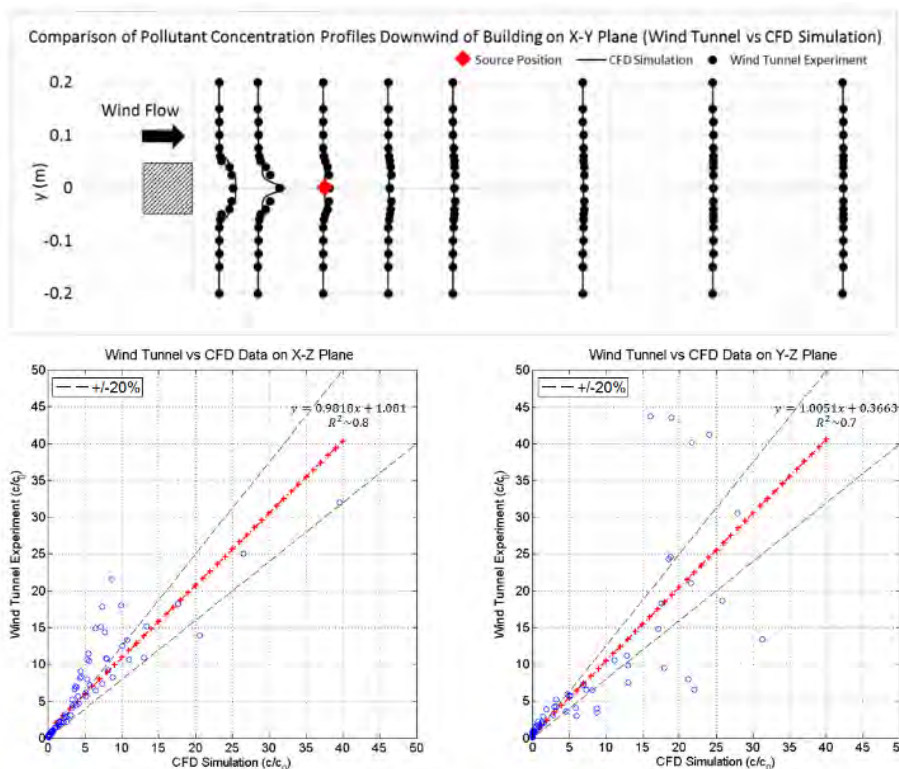

Figure 5: Comparison between CFD and wind tunnel on pollutant concentration (Upper) profiles on X-Y plane; (Lower-Left) data on X-Z plane; (Lower-Right) data on Y-Z plane

To summarize, the SST $k - \omega$ turbulence model with modified model parameters generally produce relatively robust predictions in both the wind field and pollution concentration field which is appropriate for application to urban and industrial flow/dispersion problems. Nevertheless, it is inevitable that there are locations with certain discrepancies between the simulation results and the real physical situation which might be due to the eddy viscosity hypothesis of steady models and the over-production of turbulence levels in stagnation regions behind bluff body by the SST $k - \omega$ model.

4. RESULTS AND DISCUSSION

This study has investigated the effectiveness of “Dragon-Hole” design buildings with different permeabilities in reducing pollutant trapping within downwind street canyons bounded by three control volumes (See Figure 1). From the comparison plots in Figure 6, showing the total amount of accumulated pollutant of the studied cases, the results reveal there is a 12% difference in total pollutant accumulated for Case B compared to the impermeable case (Case A) in which it is discovered that a 5% building permeability design (Case B) is far from sufficient in carrying away pollutants within the Control Canyon C1. For Cases C and D with increased permeability, more satisfactory results are achieved. There is more than 50% decrease in NO₂ for these two cases as compared to Case A. The reduction in pollutants within Control Canyon C1 becomes even more observable (i.e. reduced down to about 20% of the total amount of pollutants trapped in Control Canyon C1 in Case A) when the permeability is **increased to more than 20% (Case E and Case F)**. The first point to be mentioned is that the “Dragon-Hole” building design is effective in removing pollutants trapped within an immediate downwind canyon, provided that at least 10% building permeability is achieved for the permeable building.

By referring to the pollutant accumulation at further downstream canyons (Control Canyons C2 and C3), Cases B, C and D result in an increased NO₂ accumulation compared to the impermeable case (Case A), with amount trapped in Control Canyons C2 and C3 of Case C being twice the impermeable case. However, a significant drop is observed in Cases E and F compared to the impermeable case. Furthermore, when considering the volume averaged concentration of NO₂, Case A, B and C slightly exceed the NO₂ limit of **200µg/m³** documented in current AQO guideline. Case D (15% permeability design) bordered the requirement limit within Control Canyons C2 and C3. Meanwhile, Cases E and F (with more than 20% permeability) maintained a low NO₂ concentration level in all Control Canyons. The second point to note is that if a “Dragon-Hole” building design is to be adopted, it is necessary to maintain building permeability of 20% or above to alleviate pollutant accumulation within urban areas.

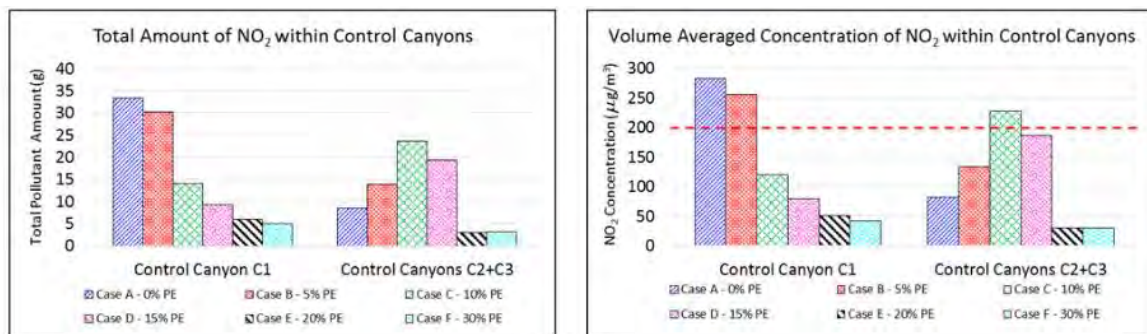

Figure 6: (Left) total amount; (Right) volume averaged concentration of NO₂ within control canyons

Normalized concentration profiles in Figure 7 show horizontal and vertical distribution of NO₂ within the source canyon. From the horizontal concentration profiles, low concentration of pollutants behind the “Dragon-Hole” opening at pedestrian level is observed and the pollutant concentration starts to rise at locations departing from the opening location. In general, Cases C, D, E and F maintains a relatively lower horizontal concentration level as compared to Cases A and B. On the other hand, from the vertical concentration profiles, it is shown that above the height of $z/H_B = 0.5$ (i.e. the height of “Dragon-Hole”), the NO₂ concentration decays to almost zero for Cases B to F, while there still appears to be a small amount of pollutant above that elevation in Case A. In addition, Cases C to F acquired vertical concentration profiles of faster decay rate and smaller pollutant magnitude compared to Cases A and B, indicating pollutant removal effectiveness would be enhanced by an increment of building permeability. In summary, “Dragon-Hole” building permeability of more than 20% produces best performance among all cases.

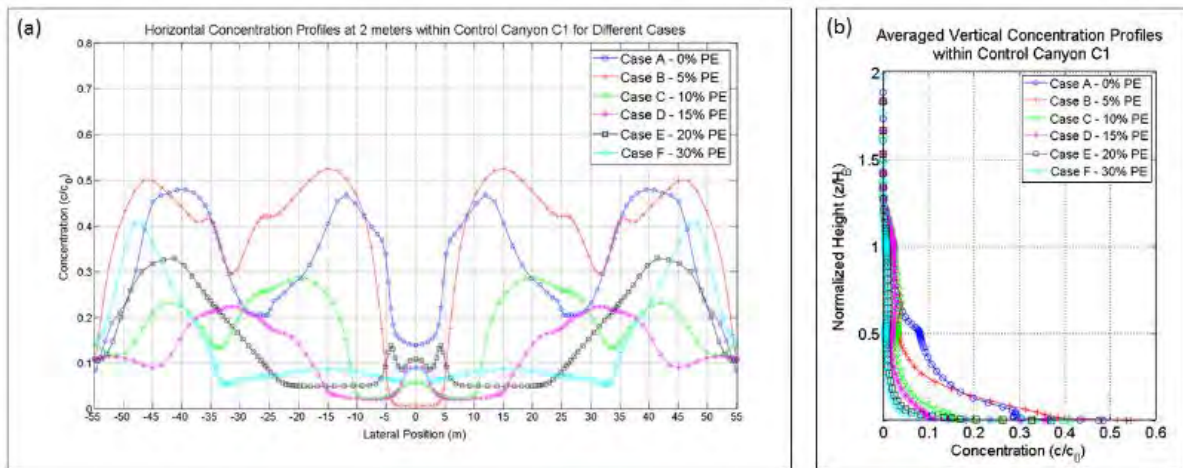

Figure 7: (a) Horizontal concentration profiles at 2 meters; (b) Vertical concentration profiles

5. CONCLUSIONS

This paper has demonstrated the usage of a well validated and industrially affordable turbulence model in carrying out assessment of pollutant dispersion within an idealized urban area via CFD technique. A parametric study has **been conducted to investigate the relationship between building permeability of the “Dragon Hole” building design and the effectiveness of pollutant removal within street canyons.**

There is evidence that the “Dragon-Hole” building design concept is effective in reducing pollutant accumulation provided that a sufficient opening size is achieved. This result accords with the requirement of maintaining at least 20% building permeability to maintain good ventilation performance, as stated in the Sustainable Building Guideline. Moreover, it is shown that a low permeability of less than 5% would not be sufficient to disperse pollutants trapped within street canyons.

Environmental scientists and modellers may follow the methodology in this paper when performing pollutant dispersion assessments via CFD technique to acquire a cost effective and robust result. Meanwhile, **developers/architects may take into consideration the “Dragon-Hole” concept during the building design stage.**

ACKNOWLEDGMENTS

This research was supported by RGC grant no: 16300715 and AECOM Environment. The authors would like to express their appreciation to Mr. Josh Lam, Managing Director of AECOM Environment, for his suggestions on earlier versions of the paper manuscript.

REFERENCES

- [1] World Health Organization, Air quality and health e fact sheet No. 313 [online]. Retrieved from <http://www.who.int/mediacentre/factsheets/fs313/en/2008>.
- [2] Yuan, C., Ng, E., Norford, L. K. 2014. Improving air quality in high-density cities by understanding the relationship between air pollutant dispersion and urban morphologies. *Building and Environment* 71: 245-258.
- [3] **Baskaran, A., Kashef, A., 1996. Investigation of air flow around buildings using computational fluid dynamics techniques. *Engineering Structures* 18, 861-73, 75.**
- [4] Blocken, B., Persoon, J., 2009. Pedestrian wind comfort around a large football stadium in an urban environment: CFD simulation, validation and application of the new Dutch wind nuisance standard. *Journal of Wind Engineering and Industrial Aerodynamics* 97, 255-70.
- [5] Blocken, B., 2015. Computational Fluid Dynamics for urban physics: Importance, scales, possibilities, limitations and ten tips and tricks towards accurate and reliable simulations. *Building and Environment* 91: 219-245.
- [6] Ng, E., 2009. Policies and technical guidelines for urban planning of high-density cities – air ventilation assessment (AVA) of Hong Kong. *Building and Environment*. 44 (7), 1478–1488.

- [7] Franke, J., Hirsch, C., Jensen, A.G., Krüs, H.W., Schwartzman, M., Westbury, P.S., Miles, S.D., Wisse, J.A., Wright, N.G., 2004. Recommendations on the use of CFD in Wind Engineering, In Van Beek, J.P.A.J. (Ed.), Proc. Int. Conf. on Urban Wind Engineering and Building Aerodynamics: COST C14 – Impact of Wind and Storm on City life and Built Environment, Rhode-Saint-Genèse.
- [8] AIJ (Architectural Institute of Japan), 2007. AIJ guidebook for practical applications of CFD to pedestrian wind environment around buildings.
- [9] Cheng, W.C., Liu, C.H., Leung, Y.C., 2008. Computational formulation for the evaluation of street canyon ventilation and pollutant removal performance. Atmos Environ 42: 9041–9051. CODASC (2008) Concentration Data of Street Canyons. Internet database. Karlsruhe Institute of Technology (KIT).
- [10] Salim, M. S., Buccolieri, R., Chan, A., Sabatino, S. D., Numerical simulation of atmospheric pollutant dispersion in an urban street canyon: Comparison between RANS and LES. Journal of Wind Engineering and Industrial Aerodynamics 99(2-3), 103-113.
- [11] Menter, F.R., 1994 Improved Two-Equation $k-\omega$ Turbulence Models for Aerodynamic Flows. AIAA Journal, 32(8), 1598-1605.
- [12] Richards, P., and Hoxey, R., 1993. Appropriate boundary conditions for computational wind engineering models using the $k-\epsilon$ turbulence model. Journal of Wind Engineering and Industrial Aerodynamics, 46-47:145–153.
- [13] Poroseva, S., and Iaccarino, G., 2001. Simulating separated flow using the $k-\epsilon$ model. Annual Research Briefs, Center for Turbulence Research, Stanford University.
- [14] Franke, J., 2006. Recommendations of the COST action C14 on the use of CFD in predicting pedestrian wind environment. Journal of Wind Engineering 108, 529-32.
- [15] Tominaga, Y., Mochida, A., Yoshie, R., Kataoka, H., Nozu, T., Yoshikawa, M., 2008. AIJ guidelines for practical applications of CFD to pedestrian wind environment around buildings. Journal of Wind Engineering and Industrial Aerodynamics 96, 1749-61.
- [16] Mochida, A., Tominaga, Y., Murakami, S., Yoshie, R., Ishihara, T., Ooka, R., 2002. Comparison of various $k-\epsilon$ models and DSM applied to flow around a high-rise building-report on AIJ cooperative project for CFD prediction of wind environment. Wind and Structure 5, 227-44.
- [17] Shirasawa, T., Tominaga, T., Yoshie, R., Mochida, A., Yoshino, H., Kataoka, H. 2003. Development of CFD method for predicting wind environment around a high-rise building, part 2: the cross comparison of CFD results using various k- models for the flowfield around a building model with 4:4:1 shape. AIJ Journal of Technology and Design 18, 169-74.
- [18] Casey, M., Wintergerste, T., 2000. Quality and trust in industrial CFD: best practice guidelines. ERCOTFAC.
- [19] Tanaka, H., Yoshie, R., Hu, Cheng-Hu., 2006. Uncertainty in Measurements of Velocity and Concentration around a Building. The 4th International Symposium on Computational Wind Engineering, Yokohama, Japan, July 16-19. 549-552.
- [20] Gromke, C., Ruck, B. 2012. Pollutant concentrations in street canyons of different aspect ratio with avenues of trees for various wind directions. Boundary-layer Meteorology. 144(1), 41-64.
- [21] Willemsen, E., Wisse, J. A. 2002. Accuracy of assessment of wind speed in the built environment. Journal of Wind Engineering and Industrial Aerodynamics 90(10), 1183-1190.
- [22] HKPD (Hong Kong Planning Department), 2006. Hong Kong planning standards and guidelines. The Government of the Hong Kong Special Administrative Region.

Applicability of Maturity Assessment for Sustainable Construction

Helmuth KREINER^a, Marco SCHERZ^b, Christian STEINMANN^c, Alexander PASSER^d

^a Graz University of Technology - Institute of Technology and Testing of Building Materials - Working Group for Sustainability Assessment, Austria, helmuth.kreiner@tugraz.at

^b Graz University of Technology - Institute of Technology and Testing of Building Materials - Working Group for Sustainability Assessment, Austria, marco.scherz@tugraz.at

^c HM&S IT-Consulting GmbH, Austria, chst@hms.org

^d Graz University of Technology - Institute of Technology and Testing of Building Materials - Working Group for Sustainability Assessment, Austria, alexander.passer@tugraz.at

ABSTRACT

Due to multi criteria related decision making processes during the construction of sustainable buildings, the operationalization of holistic building performance is becoming increasingly challenging. The realization of sustainability aspects in current construction practice calls for - next to precise stakeholder requirements - an integrated and life cycle oriented approach. Current challenges regarding the operationalization of holistic planning and construction processes are mainly caused by vague stakeholder requirements and by the current lack of appropriate methods for the required life cycle processes management. The holistic quality of the expected technical and functional performance of a building is closely and strongly related to the fulfillment of all processes **(technical and organizational), which occur over the building's life cycle. In this context comprehensive sets of sustainability criteria and possible interdependencies between these criteria increases the risk of disregarding crucial life cycle processes and can lead to wrong decisions.** This article presents the application of maturity assessment method based on a systemic approach, in order to achieve the expected building performance and stakeholder satisfaction simultaneously.

Causal loop analyses of several sustainability criteria aid visualization of different optimization strategies' tradeoffs and synergies. Depending on the building's predefined quality targets, relevant construction processes can be identified – through a systemic perspective. Management and assessment of these processes during the planning and construction phase is based on maturity assessment method. Thereby, a number of "basic" and "generic" practices (assigned to each process) are evaluated and thus define the capability level for each process. The final aggregation of each process's evaluated practices leads to a specific "maturity level" which indicates the fulfillment level of the previously defined sustainability targets on the validation date.

Maturity assessment based on a systemic approach is an appropriate method to ensure the holistic management of life cycle processes for sustainable construction.

Keywords: sustainable construction, maturity assessment, process optimization, systemic approach, design process, green building management

1. INTRODUCTION

Sustainable construction implementation is driven forward by harmonized International and European standards (ISO EN) and voluntary instruments, such as the ISO 14000 series – environmental management or building sustainability rating system. In 2008 the ISO 15392 – Sustainability in building construction – General principle already created the basis for a common understanding of sustainability in the construction industry. Whereas an increase of building performance can only be reached with the implementation of sustainable targets in early design stages and with their assessment after completion. Accordingly, in each project stage numerous processes are interacting. Therefore, two approaches are necessary to evaluate their influence - a systemic approach and a maturity assessment approach.

In the following contribution a "process" represents a set of interrelated or interacting activities that transform inputs into outputs. Whenever the processes quality has **strong influences on the product's quality, it makes sense to focus on the capabilities and the maturity of the processes.** Processes on a higher capability level are more reliable to deliver the expected results, are less prone to risks and to a certain degree, are well predictable within **time, budget and quality.** Processes on a lower capability level are often performed "ad-hoc", are not well planned

and often don't deliver the expected results or need some reworking in order to satisfy the needs. Time, budget and quality are at risk. Additionally, the amount of hidden flaws and problems – which will be detected in the future – is hard to estimate, but probably significantly higher compared to processes on higher capability levels.

The quality premises and the associated ideas about process capability are an integral part of the industrialization in our world: it is not only used in mass-production, it is also used for individual projects (like development of software and systems in different industrial sectors) but also for service oriented business (like banking, insurance, health, communications, etc.).

In this case the application of maturity assessment methods in the construction industry can help to optimize construction processes, because the capability of the performed processes indeed has big influences on the quality and sustainability of the building respective construction. This optimization concerns two important conditions of a successful project progression. On the one hand it is possible to prevent insufficiently planned processes and inform the stakeholders in an early project stage, and on the other hand it is a first important step towards risk management, which could minimize claims after the projects.

2. METHODS

When operationalizing maturity assessment in sustainable construction, first, stakeholders integration in the planning process must be dramatically increased. Further, a methodology for holistic consideration of synergies and trade offs that probably occur in life cycle oriented planning processes must be provided. In this article, on the one hand causal loop analysis is applied to identify crucial life cycle processes based on specific stakeholders goals. On the other hand, the subsequent assessment in how each sustainability process is embedded within the integral planning process is implemented by maturity assessment method. By combining these methods, the fulfillment level of life cycle processes can be highlighted, and strengths and weaknesses can be visualized. First approaches concerning maturity assessment in sustainable construction are currently developed in the research project **“UNAB-Sustainable Designprocess and Integrated Facades” at the Technical University of Graz. This paper presents the project's intermediate results.**

2.1 Systemic approach

Assessment of building sustainability using building certification systems (e.g. BREEAM, LEED, CASBEE, DGNB/OGNI, etc.) is increasing. Due to multi criteria assessment, dynamic stakeholder goals and enlarged system boundaries decision making, especially in early planning stages, are getting increasingly complex. Using building certification methods the holistic life cycle oriented consideration of sustainability criteria is operationalized by a full set of criteria with appropriate weighting. **This method allows impacts' quantification and identification of the individual optimization potential for single assessment criteria.** However, because of sustainability criteria interaction, trade offs and synergies may occur by implementing technical measures. Acknowledgement of these system interdependencies is of high importance for a balanced improvement, which is claimed by the sustainability concept of CEN/TC 350 requirements. Depending on the individual stakeholder preferences, different criteria groups must also be optimized within the planning process. Therefore, building certification systems are only partly suitable for holistic building improvement. They do not permit an optimization approach covering both estimation of single measure influence on overall building sustainability and stakeholder objectives by highlighting their system interdependencies. By applying causal loop analysis based on the assessment concept of building certification, the improvement potential and furthermore the identification of appropriate processes in order to achieve high building sustainability can be transparently visualized.

2.2 Maturity assessment

The achievement degree of the expected outcomes and a company's processes efficiency can be assessed on the basis of capability levels (CL). The description of the next higher capability level (CL) can be used as a guideline to improve the process.

The characterization of capability levels is generic to all kinds of processes.

CL 0: A process on SPiCE Capability Level 0 is considered as an incomplete process, which is not capable to achieve its expected outcome. By definition, a process, which is not done at all, gets also a CL 0 rating.

CL 1: A process on SPiCE Capability Level 1 is called a performed process, because it (obviously) is performed and it achieves its expected outcomes. There is no word about how good or fast the process is done or which means were used to get it done or whether the process was planned appropriately or not.

CL 2: A process on SPiCE Capability Level 2 is called a managed process. It builds upon a performed process (CL 1) so it achieves its expected outcomes. Beyond that, the process is planned in a proper way: the expected outcomes are defined and described, the activities and tasks are defined and assigned, and estimates about effort and cost are aggregated. During the execution of the process, the activities are monitored and controlled to assure adherence to the plan. Additionally, quality assurance activities are performed, to ensure the correct application of **the processes and to ensure the process's results quality** – so that they fulfill the defined expectations.

CL 3: A process on SPiCE Capability Level 3 is called a defined process. It builds upon a managed process (CL 2) so it achieves its expected outcomes, is planned, monitored, controlled, and quality assured. Beyond that, the process is derived from the set of standard processes of the organization. So the organization needs to have done this process several times before, **learned from doing it and consolidated these experiences into a “standard process description”**. Typically, an organization provides templates, methodology descriptions, rules for estimation and other resources to be able to perform the process routinely. On the other hand, it is expected that the process – whenever it is performed – also provides valuable feedback to the organization to answer the following questions: Did the standard process work out as expected? Were the process descriptions comprehensible? Were the rules for estimating appropriate? Which things can be improved? The answers to these questions are used to maintain **the organizations' set of standard processes**.

CL 4: A process on SPiCE Capability Level 4 is called a quantitatively controlled process. It builds upon a defined process (CL 3) so it achieves its expected outcomes, is planned, monitored, controlled, quality assured, derived from standard processes, and provides feedback. Beyond that, quantitative measures are used for planning, monitoring, and controlling the process and statistical methods are used for estimating and managing quality **aspects of the process's results**.

CL 5: A process on SPiCE Capability Level 4 is called an optimizing process. It builds upon a quantitatively controlled process (CL 4) so it achieves its expected outcomes, is planned, monitored, controlled, quality assured, derived from standard processes, provides feedback, and is managed using statistical techniques. Beyond that, the results from statistically managing the process execution are used to predict potential improvements, which are piloted and then after evaluation deployed to the organization again.

3. RESULTS AND DISCUSSION

A systematic procedure was developed in order to apply maturity assessment for sustainable construction (Fig.1). Based on stakeholder defined goals and on building certification system DGNB/ÖGNI, functional requirements for both are determined. Causal loop analysis highlights systemic behavior of base practices in order to optimize technical measures that are suitable for the improvement and achievement of the pre-defined stakeholder goals. Furthermore, the cause and effect chain is modeled for each base practice. Possible interdependencies within the optimization process are highlighted.

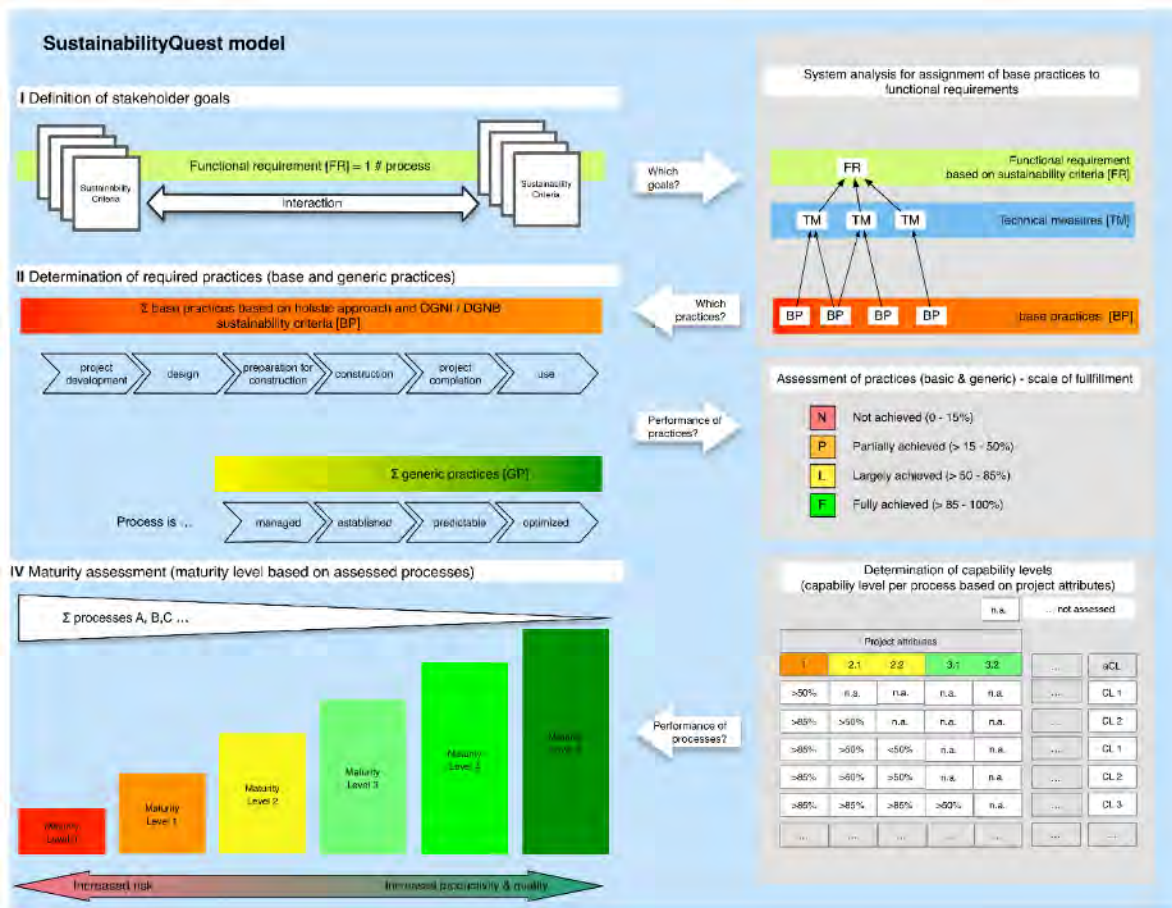

Figure 85: Assignment of processes

Figure 2 exemplarily pictures the sequence of several base practices for stakeholder goal “slender design of building envelope”. These sequences of base practices may vary when modifying stakeholder requirements.

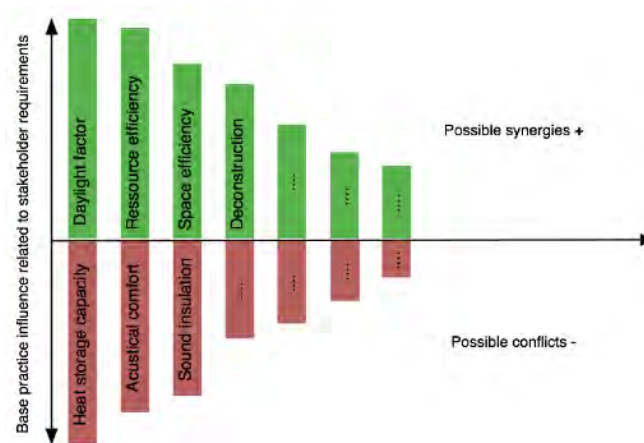

Figure 86: Synergies and conflicts for stakeholder requirement “slender design of building envelopes”

The process model approach allows stressing base practice influence as well as synergies and conflicts for several stakeholder requirements and provides therefore important information for integral planning processes. System interdependencies induced by implementing base practices can support decision makers during the integral planning process.

After identifying major practices to be implemented with regard to predefined and prioritized stakeholder goals, the fulfillment of these practices by consideration of all life cycle stages that are relevant for selected base practices is evaluated. Next to base practice, the fulfillment of generic practices is also assessed. For visualizing the optimization potential, the practices based on the assessment method from SPiCE must be assessed. Each practice will be assessed and rated using the N-P-L-F scale. Finally, the **determination of the processes' achieved capability levels can be conducted. Base practices result in the process attribute "process implementation", which is equivalent to SPiCE Capability Level 1. The other process attributes are the results of the generic practices' assessment, which make up SPiCE CL 2 to 5. Due to SPiCE's rating and aggregation mechanism, the capability level calculation for each process attribute is possible.** Based on pre-defined project attributes (assigned to different capability levels) and their scale of fulfillment according to the pictured evaluation algorithm in Fig. 1, capability levels for processes can be identified. Finally, the performance of all necessary processes is aggregated to a specific maturity level depending on the performed clustering.

The assessment result is usually displayed as a capability level profile, which is compared to a maturity level. The maturity level is a target capability level profile, so it is set up as a collection of processes, which each need to fulfill a defined capability level to satisfy the defined maturity level.

In a joint meeting with the decision makers, it is possible to identify optimization potential based on the assessment results in respect to pre-defined objectives and the expected maturity level. Thus, necessary countermeasure can be implemented in the early project stages. Using the following approach, it is possible to show the interactions on **the stakeholders' specified target requirements in reasonable time.**

4. CONCLUSION

This paper presents a new methodological approach for maturity assessments application for sustainable construction. Results clearly demonstrate that the combination of cross loop analysis and maturity assessment method allows the holistic management of life cycle processes regarding sustainable construction. Synergies and **conflicts' visualization when implementing construction measures shall support decisions makers (investors, architects, planners, etc.)** in the early planning stages of construction projects. By applying SustainabilityQuest model, sustainable construction processes can be monitored based on a systemic perspective. Alterations or deviations from the agreed quality goals can be covered in a timely manner and thus lower project risks.

ACKNOWLEDGMENTS

The analysis and results described here are part of a current research project **“UNAB - Sustainable design process & integrated façades”** at Graz University of Technology, Austria. The authors would like to acknowledge all the participants of the UNAB project. A summary and a list with all the members can be found in TUGonline. Finally, the authors are grateful to be financially supported by the Zukunftsfonds Steiermark.



REFERENCES

- [1] CEN: ÖNORM EN 15643-1 Sustainability of construction works - Assessment of buildings, Part 1: General Framework, ASI (2010)
- [2] CEN: ÖNORM EN 15643-2 Sustainability of construction works - Assessment of buildings, Part 2: Framework for the assessment of the environmental performance, 2011
- [3] CEN: ÖNORM EN 15643-3 Sustainability of construction works - Assessment of buildings, Part 3: Framework for the assessment of the social performance, 2012
- [4] CEN: ÖNORM EN 15643-4 Sustainability of construction works - Assessment of buildings, Part 4: Framework for the assessment of economic performance, 2012
- [5] Crosby, Philip B. 1979. Quality is free: the art of making quality certain, McGraw-Hill
- [6] Cole, Raymond J ; Howard, Nigel: Building Environmental Assessment Tools: Current and Future Roles (1990)
- [7] Cole, Raymond J.: Environmental Issues Past, Present & Future: Changing Priorities & Responsibilities for Building Design. In: SB11 Helsinki, 2011
- [8] Dale, Barrie. 1999. Total quality management. John Wiley & Sons, Ltd.
- [9] ISO 14000 series – Environmental management
- [10] ISO 15392 – Sustainability in building construction – General principle
- [11] ISO/IEC 33001:2015. Information technology - Process assessment - Concepts and vocabulary (former: ISO/IEC 15504-1)
- [12] ISO/IEC 33020:2015 Information technology - Process assessment - Process measurement framework for assessment of process capability (former ISO/IEC 15504-2)
- [13] ISO/IEC 33003:2015 Information technology - Process assessment - Requirements for process measurement frameworks (former ISO/IEC 15504-2 and 15504-7)
- [14] ISO/IEC 33004:2015 Information technology - Process assessment - Requirements for process reference, process assessment and maturity models (former ISO/IEC 15504-2 and 15504-7)
- [15] Kreiner, H., Passer, A., Wallbaum, A., 2015. A new systemic approach to improve the sustainability performance of office buildings in the early design stage. In: Energy and buildings. 109, p. 385-396
- [16] König H. et.al. A life cycle approach to buildings – Principles, Calculations, Design tools 2010
- [17] Spiring, Fred A. 1995. Process capability: A total quality management tool, Journal Total Quality Management, Vol. 6, p21-34
- [18] UNAB - Sustainable Designprocess & Integrated Facades https://online.tugraz.at/tug_online/fdb_detail.ansicht?cvfanr=F34029&cvorgnr=2265&sprache=2
- [19] Vester, Frederic: Die Kunst vernetzt zu denken: Ideen und Werkzeuge für einen neuen Umgang mit Komplexität, 2008 — ISBN 9783423330770
- [20] Wilms, F.E.P.; Wirkungsgefüge-Einsatzmöglichkeiten und Grenzen in der Unternehmensführung, 1 ed., Haupt Verlag, 2012.

Development of a Rotatable Outdoor Testbed and the Testing of an Integrated Auto-dimming Lighting and Automated Blind System in the Tropics

ZHOU Jian^a, TAN Tian-chong^b, GAO Chun-ping^c, Selvam VALLIAPPAN^d, Alice GOH^e, Alvin SEOH^f, Sushanth BABU^g, Adrian LAMANO^h, ZHANG Zheⁱ, Jatin SARVAIYA^j, WAN Man-pun^k, Yann GRYNBERG^l, Nakul NAPHADE^m

^a Energy Research Institute@NTU (ERI@N) Nanyang Technological University, Singapore, zhoujian@ntu.edu.sg

^b Built Environment Research and Innovation Institute (BERII) Building and Construction Authority (BCA), Singapore, tan_tian_chong@bca.gov.sg

^c Built Environment Research and Innovation Institute (BERII) Building and Construction Authority (BCA), Singapore, gao_chun_ping@bca.gov.sg

^d Built Environment Research and Innovation Institute (BERII) Building and Construction Authority (BCA), Singapore, selvam_valliappan@bca.gov.sg

^e Built Environment Research and Innovation Institute (BERII) Building and Construction Authority (BCA), Singapore, alice_goh@bca.gov.sg

^f Built Environment Research and Innovation Institute (BERII) Building and Construction Authority (BCA), Singapore, alvin_seoh@bca.gov.sg

^g Energy Research Institute@NTU (ERI@N) Nanyang Technological University, Singapore, sushanth@ntu.edu.sg

^h Energy Research Institute@NTU (ERI@N) Nanyang Technological University, Singapore, adrianlamano@ntu.edu.sg

ⁱ Energy Research Institute@NTU (ERI@N) Nanyang Technological University, Singapore, zhe.zhang@ntu.edu.sg

^j Energy Research Institute@NTU (ERI@N) Nanyang Technological University, Singapore, jatin@ntu.edu.sg

^k Energy Research Institute@NTU (ERI@N) Nanyang Technological University, Singapore, mpwan@ntu.edu.sg

^l Energy Research Institute@NTU (ERI@N) Nanyang Technological University, Singapore, ygrynberg@ntu.edu.sg

^m Energy Research Institute@NTU (ERI@N) Nanyang Technological University, Singapore, nakulnaphade@ntu.edu.sg

ABSTRACT

To drive the research and development of energy-efficient building technologies in the tropics, an advanced rotatable testbed, BCA SkyLab, was developed in Singapore in collaboration with Lawrence Berkeley National Laboratory (LBNL). As world's first high-rise rotatable testbed for the tropics, this facility is an outdoor testbed sitting atop a 7-storey building, with a rotatable platform that can simulate various orientations of building. The testbed allows testing and evaluation of performance of various technologies in the tropical urban environment, including lighting, air-conditioning, facades, shades and control systems. Performance in visual comfort and potential in deeper energy savings of an integrated auto-dimming lighting with automated blinds system was investigated in the SkyLab. This system was installed and tested together with a conventional baseline system in the two cells in the SkyLab. This integrated system uses auto-dimming control based on outdoor illuminance level through the Digitally Addressable Lighting Interface (DALI), and the automated blinds incorporates a two-section daylight-redirecting design to introduce maximum daylight while minimising Daylight Glare Probability (DGP). The system performance of energy savings and visual comfort were investigated with an innovative control algorithm developed in-house. It was found that the automated blinds effectively eliminated glare discomfort, and with the automated blinds working in conjunction with the auto-dimming, up to 74% of lighting energy savings is achievable without compromising the illuminance level at the working plane.

Keywords: auto-dimming, automated blinds, daylight redirecting

1. INTRODUCTION

Lighting system with automatic dimming is gaining popularity as a green building technology. Studies have shown high potential for lighting energy savings by automatic dimming system when sufficient daylighting is available. Galasiu et al. (2007) reported 10-20% savings by using daylight-linked dimming over one year in an office building located in Burnaby, Canada. Fernandes et al. (2014) found that daylighting-based dimming controls integrated with set point tuning can reduce lighting energy by about 20%, compared to the recommended 12 W/m² in ASHRAE 90.1-2007 for day-lit zones in New York Times Headquarters Building. Delvaeye et al. (2016) reported that 46% of lighting energy savings can be achieved by an open loop system with Digitally Addressable Lighting Interface (DALI) control in a one-year measurement conducted in a classroom in Belgium. These studies used either T5 or T8 fluorescent lamps. Switching from fluorescent lighting (e.g., T5 and T8) to LED could also bring energy savings, as some studies showed. A study conducted in an eight-story office building in the UK (Department of Energy & Climate Change, 2014) reported 30% of electricity savings due to replacement of T5 lighting with LED lighting and

upgraded BMS system. Richman et al. (2011) conducted a laboratory evaluation of LED and T8 lamp products, and reported that 3-24% of lighting energy savings can be achieved by LED depending on fixture type, compared to T8.

Window blinds system is usually used in conjunction with indoor lighting system to modulate daylight and reduce glare. The lighting and blinds systems may operate independently or as an integrated system. Lee et al. (1998) performed a full-scale test bedding of an automated Venetian blind with T8 dimmable lighting system in two unoccupied, private offices in Oakland, California. For an office with Southeast-facing façade, 1 – 22% lighting energy savings can be achieved by the dynamic system (automated blinds plus auto-dimming lighting), compared to fixed blinds partly closed at 15° with auto-dimming lighting. Daily lighting energy savings of 22-86% were obtained with the dynamic system compared to a static system (fixed blind set at any tilting angle plus non-dimmable lighting). Lee et al. (2009) conducted another experimental study in an 88.4-m² window system testbed facility located at Lawrence Berkeley National Laboratory (LBNL). A system consisting of automated daylight-redirecting blinds and auto-dimming lighting saved 69% of lighting energy comparing to a system with manually-operated Venetian blind and non-dimmable lighting. These savings are based on an average daytime of 6 am – 6 pm. Mettananta & Chaiwiwatworakul (2014) reported that more than 24% of lighting energy savings can be obtained from a system consisting of auto-dimming lighting and automatic vertical blinds in a laboratory room with North-west facing façade in Thailand. Chaiwiwatworakul et al. (2009) reported a lighting energy saving of 80% in an office building in Thailand, which is equipped with an automated blinds system and an auto-dimming ballast lighting system with an optimized operation scheme developed through simulations.

Lighting energy savings by daylight-responsive auto-dimming and automated blinds system can be affected by a few factors: 1) daylight availability affected by location and orientation, and 2) shading configurations including type, material, control strategies, etc. This study investigates the performance of an integrated system consisting of auto-dimming lighting and automated blinds. The automated blinds system is a split system with the top part featuring daylight re-directing functionality and the bottom part for glare control. Experiments were conducted in the newly established BCA SkyLab facility, which is a rotatable outdoor test bed subjected to the tropical climate in Singapore. The facility has two side-by-side, identically configured test compartments with interior simulating an office environment facilitating well-controlled comparative studies. The results shall provide new insights into the operational characteristics and energy savings potentials of an integrated auto-dimming lighting and auto blind system in the tropical context.

2. METHODOLOGY

2.1 Configuration of the BCA SkyLab test facility

The test facility is constructed on an outdoor 360° rotatable platform enabling tests to be carried out at any orientation under the exposure to real weather conditions. In addition, it adopts a plug-and-play concept, allowing quantitative assessment of technologies in individual or combined configurations. The facility is situated atop a 7-storey-tall building to avoid shadow casted by neighbouring buildings. The facility has two configurable test compartments (the reference cell and the test cell) side-by-side and a control room located behind the test compartments. The two compartments are identical in dimensions (8.41 m L × 5.54 m W × 3.47 m H) and orientation, enabling comparative studies of the performance of design solutions and technologies in the test cell against a baseline setup in the reference cell. The control room holds the Building Management System (BMS), data acquisition system (DAQ) and other monitoring systems.

The exterior walls are built from 257-mm-thick aluminium composite panel and plasterboards with insulations. The U-value of the exterior wall is 0.2 W/m²K. One of the sidewalls is a full-height window façade. The window is made of double-pane low-E glazing with aluminium frame and thermal block insulation. The window façade has a U-value of 1.54 W/m²K and a shading coefficient of 0.30. The roof is made of 100-mm-thick concrete slab and 50 mm of ultra-foam insulation. The floor is carpeted. There are 4 typical office work stations in each cell. A thermal dummy (0.3 m in diameter and 1.1 m tall) made from galvanised steel sheet is put at the seat position of each work station. Each thermal dummy is providing up to 180 W of sensible heat. Each cell is served by a fan coil unit (FCU) with an indoor temperature set point of 22°C. Indoor relative humidity is maintained at 65%. Figure 1 (a) shows the schematics of the experimental setup.

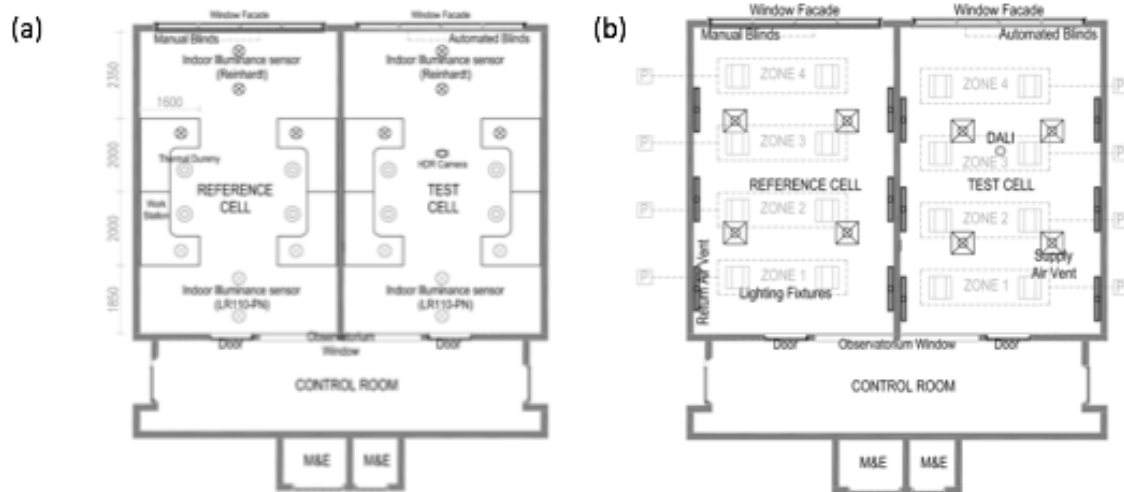

Figure 1: Experimental Setup. (a) Cell Arrangements; (b) Ceiling Installations

2.2 Lighting system

Each cell is fitted with 8 lighting fixtures. The lighting fixtures are mounted on the false ceiling at the height of 3.47 m from the finished floor. Each lighting fixture is 0.60 m long and 0.60 m wide. Two representative types of lighting are covered in this study: T5 fluorescent lamp and LED. The electrical power drawn by each lighting fixture is 51.75 W (T5) and 46.00 W (LED), at their respective maximum outputs. The lighting power density in the cell is 7.9 W/m² for T5 and 6.1 W/m² for LED.

Prior to the experiments, a lighting distribution test was carried out in both cells with all lighting fixtures set to maximum output. The test was conducted at night time with all windows blocked by papers to minimize external lighting disturbances. Illuminance measurements were made in a pre-defined grid of 1.07 m x 1.07 m per grid point covering the entire cell at the working plane height (height of work desk table top, 0.73 m above the floor) with a portable handheld lux-meter (Tenmars TM 202 Lux/FC). The test was conducted twice, once with T5 and once with LED. The average horizontal illuminance level at working plane height is 540.8 Lux with T5 lamps and is 538.9 Lux with LED. It is in compliance to the recommendation in SS531: Part1: 2006 (2013) of above 500 Lux at the working plane. The uniformities of illuminance in task area and surrounding area also conform to the recommendations in SS531: Part1: 2006 (2013) (task illuminance shall not be less than 0.7 and that of the immediate surrounding areas shall be not less than 0.5).

DALI dimming control (Lutron) was installed to provide auto dimming functionality to the lighting system. The DALI control system provides 4 settings: OFF, 25%, 100% and daylight responsive. The first 3 settings are manual overrides and the daylight responsive setting provides the auto dimming function. A daylight sensor is mounted on the ceiling 3.5 m away from window façade to detect the daylight conditions, providing the control feedback to the DALI system. The eight lighting fixtures in each cell are divided into 4 control zones as shown in Figure 1 (b). Zone 1 and zone 2 are individually controlled whereas zone 3 and zone 4 are controlled as one zone.

2.3 Blinds system

Conventional manual blinds, were installed inside of the reference cell. In the test cell automated daylight-redirecting blinds are installed. Both blinds systems are of Venetian type. The automated blinds were divided into two sections: the upper one-quarter-height portion consists of mirror-finish daylight-redirecting slats (50 mm wide, reflectivity: 0.91) and the lower three-quarter-height portion consists of mat-finish slats (25 mm wide, reflectivity: 0.56). The conventional manual blinds have the same mat-finish slats for full height. An in-house developed control algorithm was applied to control the automated blinds. The algorithm controls the lower portion such that the DGP of the person sitting at the work station closest to the wind façade will not exceed 0.35. The upper portion is controlled to allow maximum daylight penetration below the maximum threshold of 1,200 Lux of daylighting at the working plane. The manual blinds system is set at a predefined position (close/ open/ retracted) manually depending on experimental need.

2.4 Instrumentation

In each cell, horizontal illuminance at working plane height is measured by 8 illuminance sensors (4 further away from the window façade have a range of 0-10,000 lux (LR-110 PN), and the other 4 closer to the window façade have a range of 0-150,000 lux (Reinhardt)). One illuminance sensor (Reinhardt) is placed on the top of the roof to measure the outdoor horizontal illuminance at rooftop level. Glare in the test cell is measured using a High Dynamic Range (HDR) camera setup. Zonal lighting power is monitored by power meters (PowerLogic iEM3155). All sensors are reading and data-logging at 1-min intervals through the central DAQ of BCA SkyLab, apart from the HDR camera which used a 5-min interval due to the heavy processing power demand of imaging data. The sensor setup is shown in Figure 1 (b). Before the experiments, all the sensors and instrumentations have gone through systematic calibration and verification. The lux sensors have also been subjected to zero offsetting with their sensing elements closed using the factory-provided covers. Further, sensor signal noise is analysed by comparing the $2 \times$ standard deviation of readings and noise-to-signal ratio with the documented accuracy of the sensors. The analysis ensures that the sensor signal noise does not exceed the documented accuracy range.

2.5 Experimental setup

Four tests were designed to study the performance of T5 vs LED, auto-dimming system, automated blinds system and the combined system. Each test runs from 9:00 am - 6:00 pm per day, following a typical office working schedule, for 3 days in May and Aug 2016. Table 1 summarizes the configurations of the four tests. Test 1 and Test 2 are conducted at blinds retracted condition to isolate the lighting energy savings potential of the auto-dimming system and the LED lighting. In Singapore, buildings are recommended to minimize façade exposure to the East and West orientations (Building and Construction Authority, 2010) and, thus, the North represents a typical façade orientation setting in Singapore. Test 3 and Test 4 study the integrated system consisting of auto-dimming lighting and automated blind. Test 4 has the same settings as Test 3 except that the façade orientation changes to East to investigate its impacts on energy savings potential of the integrated system.

Tests	Reference Cell	Test Cell	Façade Orientation
Test 1	Lighting: T5, Auto-dimming: No Blinds: Retracted	Lighting: T5, Auto-dimming: Yes Blinds: Retracted	North
Test 2	Lighting: T5, Auto-dimming: Yes Blinds: Retracted	Lighting: LED, Auto-dimming: Yes Blinds: Retracted	North
Test 3	Lighting: T5, Auto-dimming: No Blinds: Close	Lighting: LED, Auto-dimming: Yes Blinds: Automated	North
Test 4	Lighting: T5 Auto-dimming: No Blinds: Close	Lighting: LED, Auto-dimming: Yes Blinds: Automated	East

Table 1: Test cases

3. RESULTS

3.1 Auto-dimming lighting control

Table 2 summarises the lighting energy consumptions and energy savings achieved in the Test cell compared to the Reference cell. In Test 1, about 56.80% of lighting energy savings is achieved. Test 1 was conducted with both cells using T5 lighting fixtures and, thus, the energy savings obtained from this test reflects the energy savings due to auto-dimming.

	Lighting Energy Reference Cell(1)	Lighting Energy Test Cell (2)	Lighting Energy Savings (1) – (2)	Lighting Energy Savings [(1) – (2)]/(1) x100%
Test 1	9.90 kWh	4.28 kWh	5.62 kWh	56.80%
Test 2	3.52 kWh	2.06 kWh	1.46 kWh	41.52%
Test 3	9.79 kWh	2.51 kWh	7.28 kWh	74.35%
Test 4	9.87 kWh	3.66 kWh	6.21 kWh	62.92%

Table 2: Measured lighting energy consumption and savings

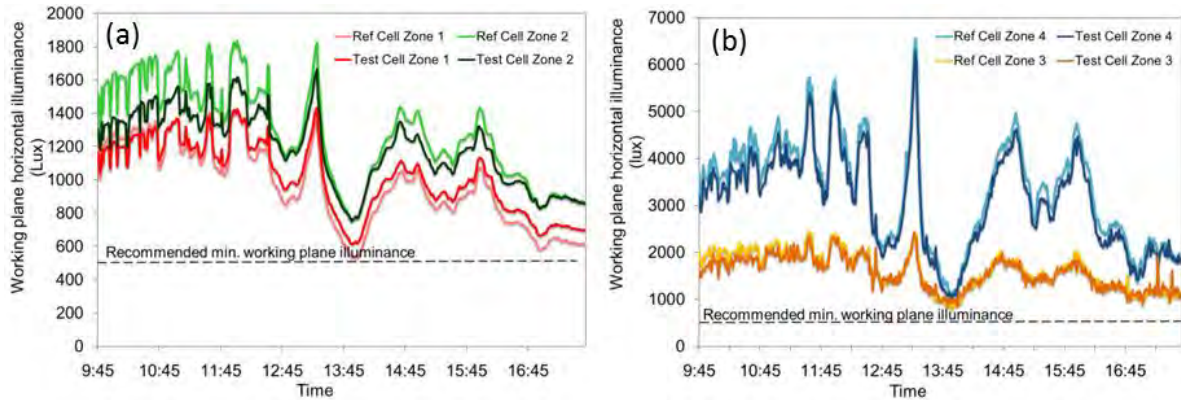

Figure 2: Working plane illuminance at each lighting zone for 1 day of Test 1

The horizontal illuminance at working plane in all lighting zones is maintained at over 500 lux during testing period, as depicted in Figure 2 (a) and Figure 2 (b). The high illuminance in zone 4 could be largely attributed to daylight penetration through windows.

3.2 T5 fluorescent lamp vs LED

Test 2 shows that about 42% of lighting energy savings is achieved by LED, compared to T5 lighting. Since this test is conducted with auto-dimming enabled in both cell, this saving by LED is achieved on top of the saving by auto-dimming. This could be due to the difference in dimming effects between LED and T5 as the two types of lamp has different lighting efficacy. The horizontal illuminance at the working plane is maintained at over 500 lux during testing period, in both cells.

3.3 Combined system

There is substantial lighting energy savings potential in an integrated system with auto-dimming lighting, automated blinds and LED. About 74% lighting energy savings was attained when the façade is facing North (Test 3). The working plane horizontal illuminance in both cells are maintained at above 500 lux as shown in Figure 3 (a) and Figure 3 (b), suggesting that the savings are obtained without compromising working plane illumination. The illuminance of zone 3 and zone 4 in test cell is higher than that in reference cell, indicating daylight penetration from automated blinds in test cell.

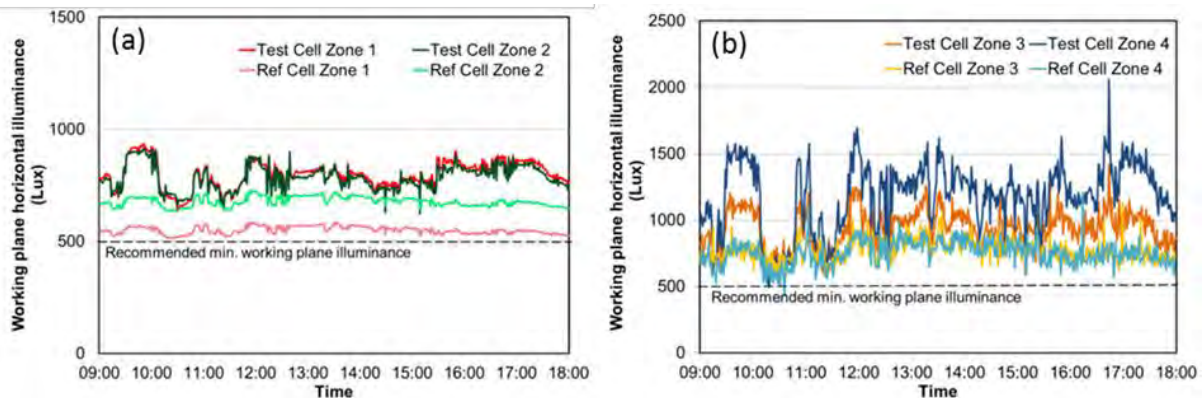

Figure 3: Working plane illuminance at each lighting zone for 1 day of test 3

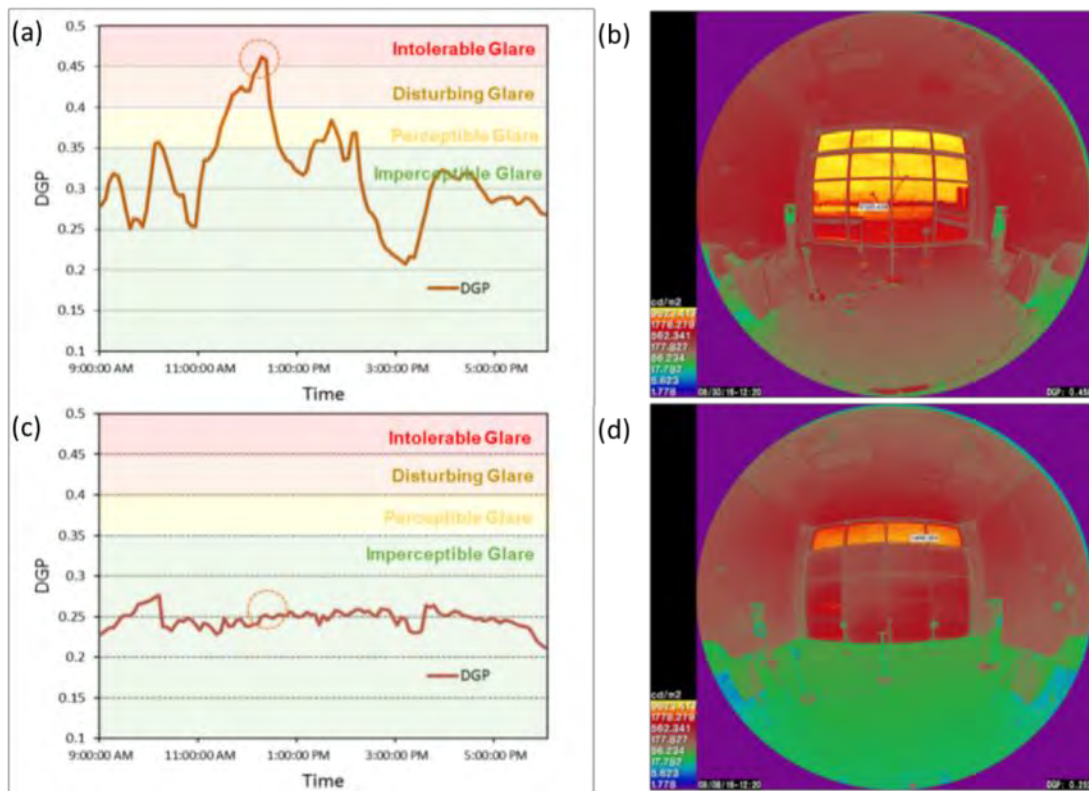

Figure 4: (a) DGP Profile of Test 1 (Blinds Retracted); (b) HDR Image at 12:20 pm during Test 1; (c) DGP Profile of Test 3 (Automated Blinds); (d) HDR Image at 12:20 pm during Test 3

While maintaining adequate horizontal illumination at the working plane (at above 500 lux), the integrated system maintains the Daylight Glare Probability (DGP) to be below 0.35 during the testing period, as shown in Figure 4 (c). It indicates that the automated blinds have successfully controlled glare according to the glare level classification in Jakubiec & Reinhart (2012). The DGP profile of Test 1 (blinds retracted) is shown in Figure 4 (a) for comparison. In Test 1, DGP exceeds 0.35 (threshold for perceptible glare) at certain time of the day and reaches a maximum of 0.46 (intolerable glare) at 12:20 pm. DGP at the same time of the day in Test 3 is 0.24.

The impact of facade orientation is examined by running the same test but with façade orientation adjusted to facing East (Test 4). The Test cell consumes significantly more lighting energy in Test 4 compared to Test 3 (see Table 2), suggesting that the East façade orientation has less daylight availability (and potential for dimming) than the North orientation. This could be due to the fact that although there is ample amount of daylight available in the morning in the East orientation, the East-facing façade is under the shadow of the lab itself in the afternoon and, thus, less daylighting potential **compared to North on a daily basis. This is reflected in the system's ability to save** lighting energy consumption. The same integrated system saves only about 63% of lighting energy in Test 4, lesser than the 74% in Test 3. However, the integrated system is still able to maintain the DGP at below 0.35 and working plane horizontal illuminance at above 500 lux during daytime in Test 4. Visual comfort is not compromised in both orientations.

4. DISCUSSION

Current results suggest that more lighting energy savings can be achieved if more daylighting is available. This matches with the observations in some previous studies, e.g., Lee et al. (1998), Lee et al. (2009), Chaiwiwatworakul et al. (2009), etc. Taking weather conditions, building orientation and sky view condition into account in evaluating the performance of auto-dimming and automated blinds is important. This paper provides the first report on the performance of an integrated lighting and daylighting control system in a rotatable testbed in tropical region.

An outdoor rotatable test facility with plug-and-play capability provides a highly flexible test bed for various green building technologies. The BCA SkyLab allows the test bedding of individual technology or a number of technologies simultaneously as an integrated system, leading to new scientific insights on the performance and characteristics of green building technologies.

5. CONCLUSION

This study investigates the lighting energy performance and visual comfort of several lighting and daylighting technologies: LED, auto-dimming lighting and automated blinds in a rotatable test facility, BCA SkyLab, in Singapore. The interior of the facility simulates a typical office environment. Compared to non-dimmable lighting, auto-dimming lighting shows about 57% savings in lighting energy consumption. LED lamps provide about 42% of lighting energy savings compared to T5 fluorescent lamps. An integrated system consisting of LED lamps, auto-dimming lighting control and automated blinds achieves up to 74% of lighting energy savings compared to a base system consisting of T5 lamps, non-dimmable lighting control and manual blinds. The energy savings potential **increases with daylight availability. In Singapore's tropical climate, the integrated system shows excellent capability** to provide visual comfort while achieving significant lighting energy savings, demonstrating the value of an outdoor rotatable test facility in R&D.

Future work can include evaluating thermal performance of the integrated system, testing its performance in other building orientations with longer durations, as well as further integration with air-conditioning control to optimise the energy performance of the system.

ACKNOWLEDGEMENT

This study is financially supported by the Government of Singapore through Building & Construction Authority (BCA) Green Buildings Innovation Cluster (GBIC) R&D Scheme grant no. GBIC-R&D/DCP02.

REFERENCES

- [1] American Society of Heating, Refrigerating and Air-Conditioning Engineers, 2007. Standard 90.1-2007, Energy Standard for Buildings except Low-Rise Residential Buildings, Atlanta: ASHRAE.
- [2] Bodart, M. and De Herde, A., 2002. Global energy savings in offices buildings by the use of daylighting algorithm developed in-house. *Energy and buildings*, 34, 421-429.
- [3] Building and Construction Authority, 2010. Building planning and massing. ISBN 978-981-08-5313-6
- [4] Chaiwattworakul, P., Chirattananon, S. and Rakkwamsuk, P., 2004. Application of automated blind for daylighting in tropical region. *Energy Conversion and Management*, 50, 2927–2943.
- [5] Delvaeye R., Ryckaert W., Stroobant, L., Hanselaer, P., Klein, R., and Breesch H., 2016. Analysis of energy savings of three daylight control systems in a school building by means of monitoring. *Energy and buildings*, 127, 969-979.
- [6] Department of Energy & Climate Change, 2014. Energy and carbon saving case study: LED lighting, URN 14D/296.
- [7] Fernandes L.L., Lee, E.S., DiBartolomeo, D.L. and Mcneil, A., 2014. Monitored lighting energy savings from dimmable controls in The New York Times Headquarters Building. *Energy and Buildings*, 68, 498-514.
- [8] Galasiu, A.D., Newsham, G.R., Suvagau, C. and Sander, D.M., 2007. Energy saving lighting control systems for open-plan offices: a field study. National Research Council Canada.
- [9] Jakubiec, J.A. and Reinhart C.F., 2012. The adaptive zone—a concept for assessing discomfort glare throughout daylight spaces *Lighting research and technology*, 44, 149–170.
- [10] Lee, E.S., DiBartolomeo, D.L., Vine, E.L. and Selkowitz, S.E., 1998. Integrated Performance of an Automated Venetian Blind/Electric Lighting System in a Full-Scale Private Office. Proceedings of the ASHRAE/DOE/BTECC Conference, Thermal Performance of the Exterior Envelopes of Buildings VII, Clearwater Beach, Florida, December 7-11, 1998.
- [11] Lee, E.S., Selkowitz, S.E., DiBartolomeo, D.L., Klems, J.H., Clear R.D., et al., 2009. High Performance Building Façade Solution. PIER Final Project Report. LBNL-4583E.
- [12] Mettananta, V. and Chaiwattworakul, P., 2014. Automated vertical blinds for daylighting in tropical region. *Energy Procedia*, 52, 278 – 286.
- [13] Richman E.E., Kinzey B.R., Miller N.J., 2011. Laboratory Evaluation of LED T8 Replacement Lamp Products. Pacific Northwest National Laboratory. PNNL-20404.
- [14] Shen, E., Hu, J. and Patel M., 2014. Energy and visual comfort analysis of lighting and daylight control strategies. *Building and Environment*, 78, 155-170.

- [15] Standards Council of Singapore, 2013. SS 531: Part1: 2013 - Code of practice of lighting of work places- part 1: indoor. Singapore: SPRING Singapore.

Poster Session

A BIM Based Integrated BIPV Design System

YOU QI ^a, OUYANG Antao^b, BAI Yang^c

^a China Smart Construction Group, Mainland China, angelayou@csc-group.cn

^b China Smart Construction Group, Mainland China, 454700797@qq.com

^c China Smart Construction Group, Mainland China, 34377625@qq.com

ABSTRACT

As one type of decentralized renewable energy system, BIPV has been widely adopted to reduce carbon emissions. BIPV design incorporates original structural analysis, power matrix design, photovoltaic panel design, etc. Factors that influence BIPV design process also include total installed capacity, construction material costs, electricity price returns, investment payback period and enterprise income. The iterative design process is time consuming and very complicated. Nowadays, Building Information Modelling (BIM) is the most promising technology for enhancing the performance and quality of construction. Ever since its gestation, BIM has promised endless prospects for people, organizations, products and processes in the construction industry. Yet there is limited use of BIM on BIPV system. In this paper, the author proposes a BIM based integrated BIPV design system and presents how the system can be used to facilitate the design process in a real project. The author finds that the system is intelligent and efficient, which can help designer make better design decisions before construction and save valuable time.

Keywords: BIM, BIPV, renewable energy

1. INTRODUCTION

There is unprecedented interest and research in renewable energy technologies driven by the insecurity of supply, increasing cost, and environmental degradation issues associated with fossil energy resources, among which solar energy is the most abundant, inexhaustible and clean one. The building sector is the biggest single contributor to total energy consumption which consumed 40% or more of the total energy usage in many countries. One of the most promising renewable energy technologies is Building-integrated photovoltaic (BIPV)(Kim et al. 2015).

BIPV module is a semiconductor device that converts solar energy directly into useful electricity. Photovoltaics (PV) are seen to be generally of benign environmental impact, generating no noise or chemical pollutants during use. It is one of the most viable renewable energy technologies for use in an urban environment, replacing existing building cladding materials. (Tsoutsos et al. 2005)

Nowadays, Building Information Modeling (BIM) is the most promising technology for enhancing the performance and quality of construction. BIM is a technology that is used to integrate a three-dimensional building model with building information through the life cycle of the building. (Anon n.d.)

There are studies using BIM on BIPV research. For example, Xuan applied BIM technology for modeling and analyzing the tilt angle of a BIPV panel (Xuan 2010). Dixit et al. developed an API program in Autodesk Revit to calculate insolation which was compared with the measured insolation (Dixit & Yan 2012). Gupta et al. developed a conceptual framework for PV simulation using an open BIM standard format (Kuo et al. 2016).

Although the emerging BIM technology has provided a better design platform in a 3D digital space, there is still a lack of study on a BIM based integrated BIPV design system. To address this challenge, this study proposed a BIM based integrated BIPV design system which has the potential to facilitate BIPV design process and help designers make more informed decisions. This system is developed based on BIM software Revit and Dynamo. While the majority of BIPV systems are interfaced with the available utility grid, BIPV may also be used in stand-alone, off-grid systems. This study focuses on the available unity grid BIPV system design.

This paper is structured as follows: Section 2 describes the traditional 2D based BIPV design procedure. Section 3 presents the concept of BIM integrated BIPV system. Section 4 discussed BIM integrated BIPV design system through case studies. Section 5 presents the conclusions and highlights the future work.

2. 2D BASED BIPV DESIGN PROCEDURE

BIPV systems should be approached to where energy conscious design techniques have been employed, and equipment and systems have been carefully selected and specified. Design considerations for BIPV systems must include the building's use and electrical loads, its location and orientation, the appropriate building and safety codes, and the relevant utility issues and costs (Steven Strong n.d.). The 2D based unity grid system BIPV design procedure is as follows:

- Azimuth angle selection

Azimuth is the array's east-west orientation in degrees. In most of the solar PV energy calculator tools, azimuth value of zero is facing equator in both northern and southern hemispheres. The modules on an array are faced to **south in order to get the most out of the sun's energy. In the southern hemisphere, it is the opposite.**

- Inverter selection

An inverter is used in the system where AC power output is needed. For grid connected systems, the input rating of the inverter should be same as PV array rating to allow for safe and efficient operation.

- PV panel selection

The limiting factors sizing grid-connected PV panels are the available space (often a roof), the investment costs and the regulatory frameworks including subsidy and promotion programs.

- Solar PV panel mounting system selection

The shape and size of which will vary with the mounting system manufacturer. PV panel mounting system should endure wind loads that are required by local standards.

- Panel column calculation

Panel column is determined on the width of the roof and the panels on each group which has to meet the requirement of the distance

- Panel row calculation

Panel row is determined on the width of the roof and the panels on each roof which has to meet the requirement of the distance.

- PV panel calculation

The total number of PV panels is calculated by adding all PV panels.

- PV panel grouping

Grouping of PV panel is determined on the characteristics of PV panel and inverters.

- Installed capacity calculation

Installed capacity is determined on the PV panel numbers and characteristics.

- 2D architectural drawing generation

3. THE CONCEPT OF BIM INTEGRATED BIPV SYSTEM

BIM technology deals with the generation and management of the virtual representation of a building in a virtual environment. In a BIM -Based BIPV design process, designers can apply BIM technology to explore different design concepts in a short time and make more informed decisions. The following are BIM the concept of BIM integrated BIPV system.

3.1 Data collection and BIM model creation

In the study, BIM software Autodesk Revit was used to create a BIM model of the BIPV factory house and intelligent BIM component models. After the building environment information and the 2D CAD drawings of the BIPV house were collected, the CAD files were imported into Revit as a reference to create a BIM model and building environment information was set into the BIM model.

Besides the general building components, the corresponding BIM models of the BIPV components were created, including PV panel models, inverters, mounting stackers.

3.2 Integrated BIPV BIM model generation

Autodesk Dynamo extends BIM with the data and logic environment of a graphical algorithm editor which allows users to generate algorithms to analyze data, read and edit data from Revit, create geometry in Dynamo or edit the geometry in Revit files (Anon n.d.). In the study, a large assortment nodes of Dynamo were built to create the integrated BIPV BIM model.

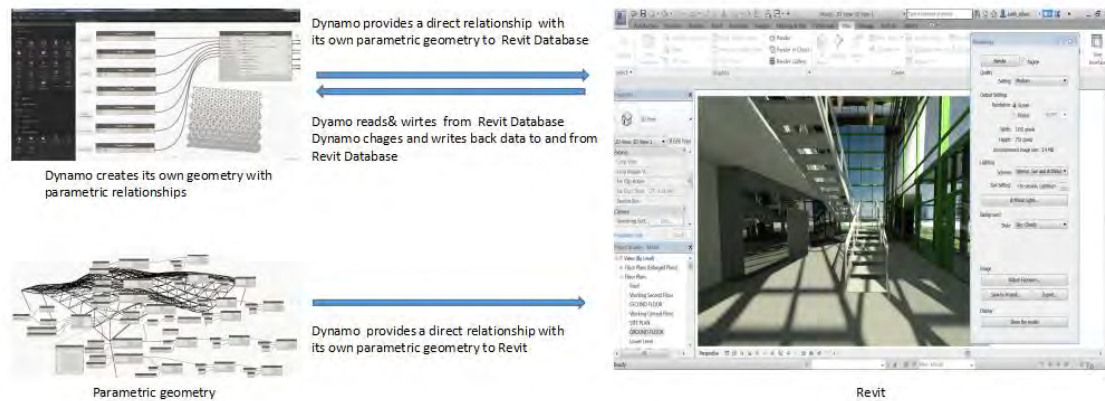

Figure 1: Revit and Dynamo

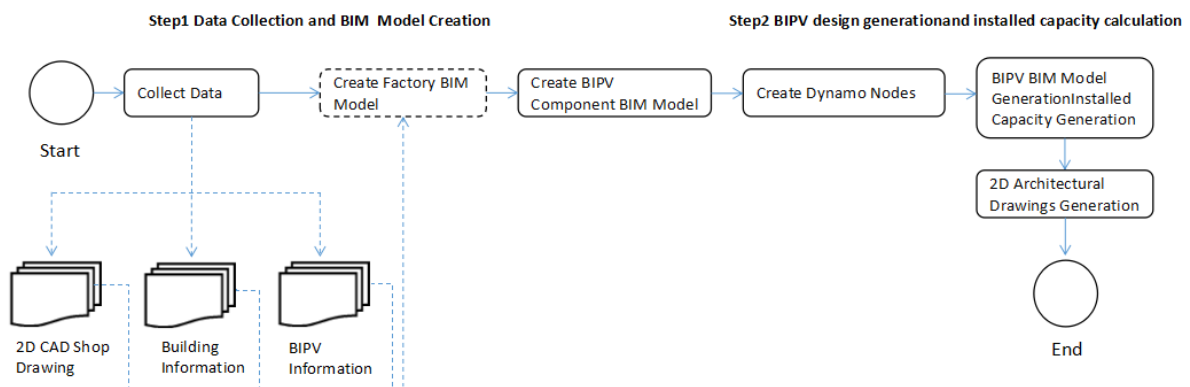

Figure 2: BIM based integrated BIPV design process

3.3 Architectural drawing generation

The traditional plan, section, and elevation, as well as other reports were generated using automation and customization features of BIM software.

4. CASE STUDY

4.1 Data collection and BIM model creation

Table 1 listed the basic information of the factory building. The BIM model of the factory building was created through the 2D CAD drawings of the factory as shown on Figure 3.

Location	No.1 Yonghe Road,Zencheng District,Guangdong Province,China
Coordinates	Latitude23.1167 N; Longtitude 113.2500E
Altitude	13.4 meters
Operation Hours	Monday to Friday 8:00-17:00

Table1: Basic information of the BIPV factory building



Figure 3: BIM model of the factory building

Besides the BIM model of the factory building, The following BIPV component BIM models were modeled such as multiple sorts of PV panels,inverters and mounting stacks.BIM models of PV panels and inverters are digital representations of real products with real parameters. Table 2 lists the product type of the modeled products. Figure 4 -Figure 7 lists four real product BIM models. Figure 8 -Figure 9 show real parameters which are input into BIM models of the components.

Product	Product Type
PV Panel	CHSM5409M CHSM5612M CHSM6612P SYO255M XHSM6610M
Inverter	EHE-N250KTL EHE-N500KTL EHE-N1000KTL SG-250K3

Table2: Product type



Figure 4: CHSM5409M BIM



Figure 5: CHSM5612M BIM



Figure 6: EHE-N250KTL BIM Model



Figure 7: CHSM5612M BIM

Parameter	Value
Constraints	
Default Elevation	1219.2
Materials and Finishes	
surface material	Glass
battery sheet material	125 pv battery
backlight surface material	Poly vinyl fluoride
border material	LV6061_welding
Electrical	
Voltage	
Wattage	
Electrical Engineering	
Pmax	180.00 W
short circuit current	5.43 A
open circuit current	22.30 V
maximum power point current	5.03 A
maximum power point voltage	17.80 V
short circuit current	10.00 A
Electrical - Loads	
KP	-0.4800%
KC	0.0620%
KV	-0.3550%
Dimensions	
width	554.0
length	1200.0

Figure 8: PV panel CHSM5409M parameters

Parameter	Value
Constraints	
Default Elevation	1219.2
Electrical	
Voltage	
Wattage	
Electrical Engineering	
Imppt	580.00 A
Isc	725.00 A
MPPTVmax	820.00 V
MPPTVmin	450.00 V
Voc	880.00 V
	535.00 A
Electrical - Loads	
Pmax	275000.00 W
CURRENT OUTPUTmax rate	98.0000%
Output rate	250000.00 W
Dimensions	
Width	1200.0
Depth	800.0
Height	2120.0

Figure 9: Inverter EHE-N250KTL parameters

4.2 BIPV BIM model generation

The nodes of Dynamo built to create the integrated BIPV BIM model is shown on Figure 10 -Figure 12. In the nodes, the user can select tilt angle inverter, mounting bracket, PV panel, PV panel orientation and group panel number through pre-defined options and determine other parameters in nodes to generate integrated BIPV BIM models as shown on Figure 13 and Figure 14. The visualization feature of the BIM model allows the designer to better understand the design effect and make more informed decisions and compare different design schemes.

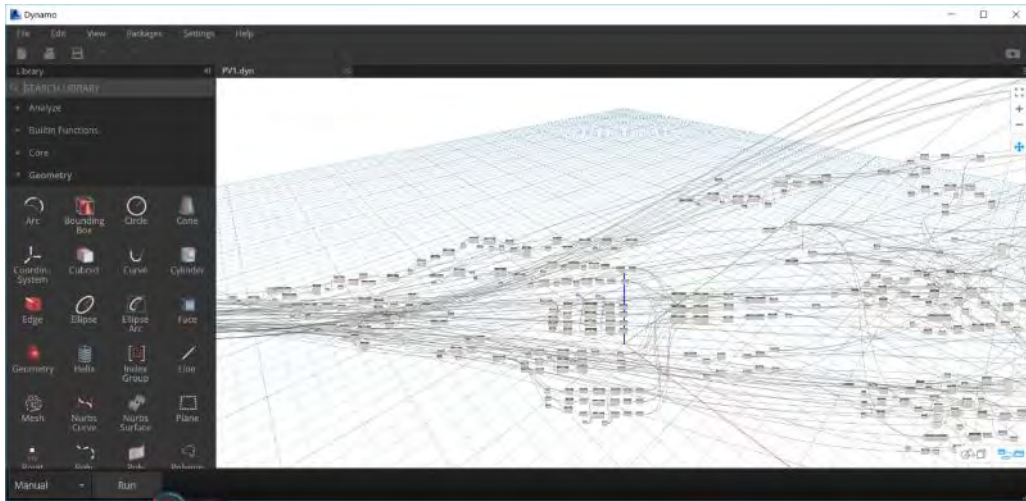

Figure 10: BIPV dynamo nodes

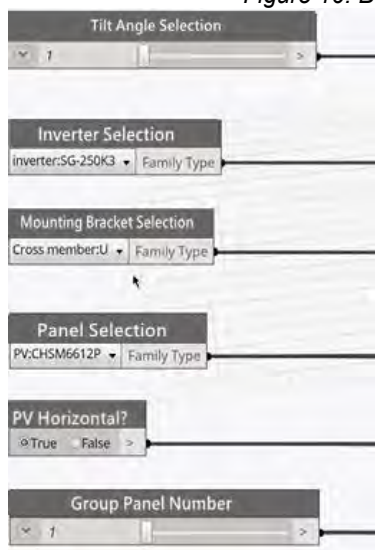

Figure 11: Dynamo nodes to select PV components

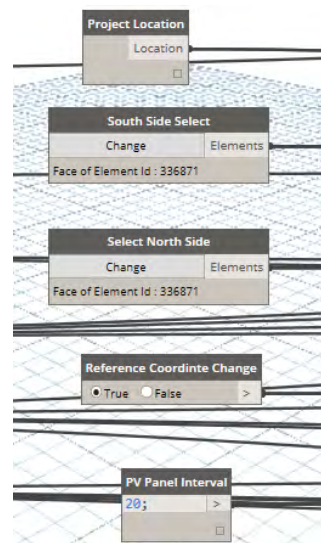

Figure 12: Dynamo nodes to calculate BIPV configuration

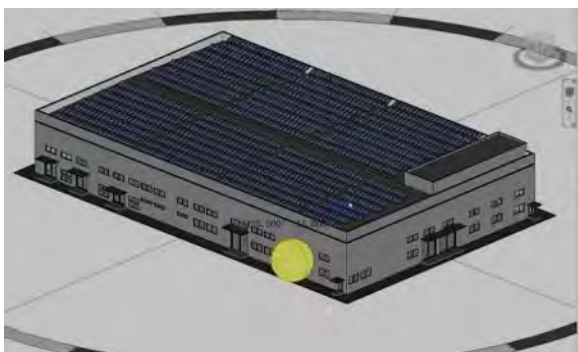

Figure 13: BIPV BIM model A

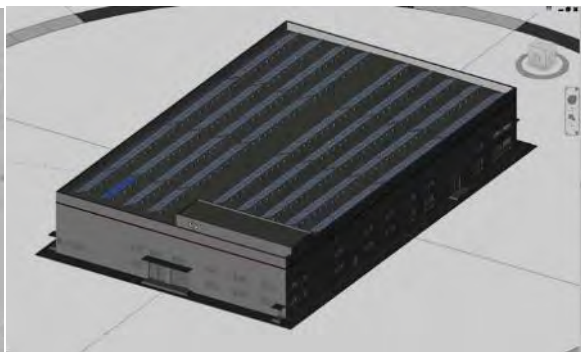

Figure 14: BIPV BIM model B

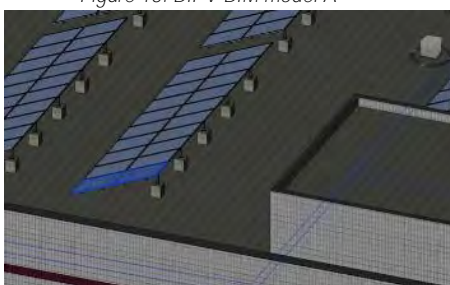

Figure 15: Partial enlarged BIPV BIM model A

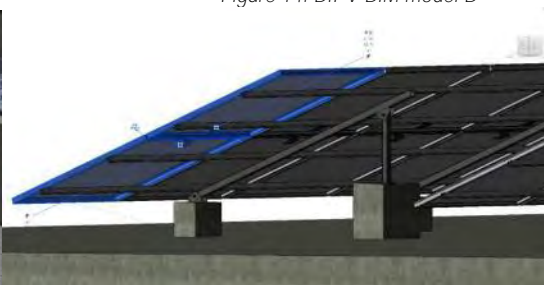

Figure 16: Partial enlarged BIPV BIM model B

4.3 2D architectural drawing generation

2D architectural drawings of the BIPV integrated factory building such as plan, section, and elevation were generated through BIM model automatically.

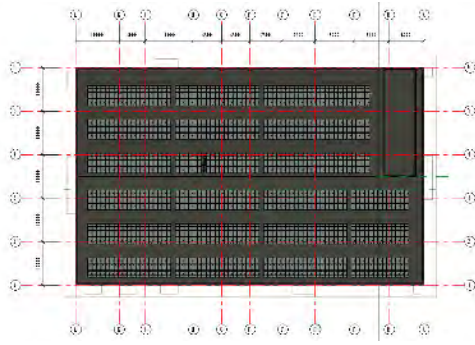

Figure 17: Plan of the factory building roof



Figure 18: Section of the factory building

5. CONCLUSIONS AND FUTURE WORK

This study proposed a BIM based BIPV design system. In this paper, BIM models of a factory building and BIPV components were built using Revit. Information such as building location, building orientation, building area and real product parameters were contained in the BIM model. A series of dynamo nodes were built to analyze data, read and edit data from the Revit BIM model and generate integrated BIPV BIM models of the factory. Finally, the traditional plan, section, elevation, as well as other reports are generated using automation and customization features of BIM software. The model-based approach increases efficiency of BIPV design process and the designer could visualize a completed building along with all its components to make better design decisions before construction which helps to save overall time and the cost of the project.

In the future, more BIPV BIM component models will be added to the system to provide more options for designers and the cost of the components will be included in the BIM model for cost estimation of the BIPV system.

REFERENCES

- [1] Anon, DYNAMOBIM. Available at: <http://dynamobim.org/> .
- [2] Anon, National BIM Standard - United States TM Version 2.
- [3] Dixit, M.K. & Yan, W., 2012. BIPV prototype for the solar insolation calculation. 2012 Proceedings of the 29th International Symposium of Automation and Robotics in Construction, ISARC 2012, pp.2–5.
- [4] Kim, H.-R. et al., 2015. Investigating the Effect of Roof Configurations on the Performance of BIPV System. Energy Procedia, 78, pp.1974–1979.
- [5] Kuo, H.-J. et al., 2016. A verification study for energy analysis of BIPV buildings with BIM. Energy and Buildings.
- [6] Steven Strong, BIPV Whole Building Guide.
- [7] Tsoutsos, T., Frantzeskaki, N. & Gekas, V., 2005. Environmental impacts from the solar energy technologies. Energy Policy, 33(3), pp.289–296.
- [8] Xuan, X.D., 2010. Application of Building Information Modeling in Building Integrated Photovoltaics. Advanced Materials Research, 171-172(1), pp.399–402.

Design Strategies for Sustainability and Integration of Water Treatment Works – Case Study of Sha Tin Water Treatment Works, Hong Kong

Aletta CHIU^a, Bevis W L MAK^b, Edward W K LEE^c

^a Water Supplies Department, Government of the HKSAR, Hong Kong SAR, aletta_cm_chiu@wsd.gov.hk

^b AECOM Asia Company Ltd., Hong Kong SAR, bevis.mak@aecom.com

^c AECOM Asia Company Ltd., Hong Kong SAR, edward.lee@aecom.com

ABSTRACT

Hong Kong as an international finance centre is a fast-paced and high density community, where the development of sustainable built environments faces numerous challenges. In-situ reprovisioning of Sha Tin Water Treatment Works – South Works is an example demonstrating how the built environment of the water treatment works is enhanced despite the challenges.

Sha Tin Water Treatment Works, comprising the South Works and North Works, is the largest treatment works in Hong Kong meeting about 30% of the total fresh water demand in the territory. The South Works was commissioned in 1964 with a treatment capacity of 364,000 m³ per day while the North Works was commissioned in stages since 1973 increasing the treatment capacity to 1,227,000 m³ per day. Due to the aging of plant and equipment which are approaching the end of their service life, the South Works requires major renovation and replacement to meet the growing demand.

Achieving sustainable reprovisioning of the South Works, building solutions including but not limited to onsite green building planning and massing, hydro power generator, ice storage system and Thermal Vision Based Security Surveillance (TVBSS) system enhancing energy saving and minimizing light pollution to neighbourhoods, etc. which have been considered in the design, will be discussed in this paper.

Keywords: sustainable development, green building, energy efficient

1. INTRODUCTION

Sha Tin Water Treatment Works (STWTW) is the largest water treatment works in the Government of the Hong Kong Special Administrative Region (HKSAR). It was commissioned in 1964 with three subsequent expansions bringing the total nominal treatment capacity to 1,227,000 m³/day. The 52 years old plant and equipment in the South Works are approaching the end of their service life and require major renovation and replacement.

The challenge is to complete the in-situ reprovisioning of the South Works together with major common facilities for both the South Works and North Works within the site, which is already fully utilised. It is also necessary to maintain continuous operation, maintenance and security of the North Works during the South Works upgrading.

In the last 50 years, economic development was the driving force globally to create a better world. 50 years on, the focus has shifted to sustainable development, ensuring that our descendants can enjoy a continuous growth in a healthy manner.

As the design of overall site layout is dictated by water treatment process train, modern treatment technologies were incorporated to enhance site utilisation and resolve the congested site condition. Apart from providing the state-of-the-art treatment technology, the project also aimed at developing an integrated building design which respects the existing surrounding landscape environment and its adjacent land users. The paper will be focused on the sustainable building development and energy efficient design.

2. BUILDING PLANNING AND MASSING

STWTW is located in a natural valley surrounded by two major country parks, namely, Lion Rock Country Park to the South and Kam Shan Country Park to the west. Although there are no direct pedestrian connections to these parks with STWTW, the design layout of buildings is to ensure a coherent green environment that responds to its surrounding open space.



Figure 1: Layout Plan of STWTW with Reprovisioned Administration Building and South Works Treatment Process Precinct

Buildings to be reprovisioned in the STWTW are strategically subdivided into two realm, i.e. Administration Building (See Figure 1 area highlighted in purple) and the water treatment process precinct of South Works (See Figure 1 area highlighted in orange). Each individual realm is characterized by its unique site features.

2.1. Administration building

The administration building encompasses new laboratory space, administration offices, control room for plant operations and training facilities. Sustainability and performance are primary motivators in the design of the building. The design is less about creating a building and more about the concept of tucking the laboratory and control facility into the adjoining hillside to take full advantage of the benefits of a green roof and energy conservation. The shape and form of the building is highly influenced by the unique site characteristics. Horizontal roof surfaces and the terraced building mass allow the building to have a low profile, minimizing the visual impact on the site. It will effectively blend into the hillside.

The building has a modern architectural expression, with glass, metal and stone used throughout the exterior. The design attempts to maximize the amount of day light entering into the building, thereby creating quality workspaces with views that provide the staff with a sense of connection to the outdoors. Sunshades and glass technologies allow this building to perform in a highly efficient manner. The exterior of the building is expressed with clean lines and patterns, with a minimal amount of features.

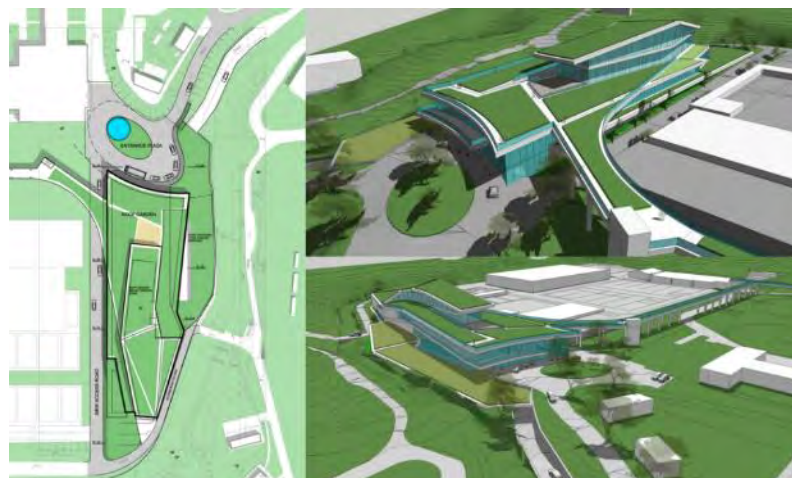

Figure 2: Design of administration building cum Mainland East Laboratory

Key elements of the design are:

- The design of the new building will have a distinct identity.
- The laboratories are designed with standard modules to create consistency and provide flexibility for future reconfiguration.
- The Control Room is located on the third level for clear viewing of the treatment facility.
- Circulation patterns are organized throughout the building to allow visitors to appreciate the various functional components.
- Upper levels are connected by ramps terminating at the Roof Garden and Observation Platform Walkway.
- The roof of the ramps will provide a look-out oriented towards Amah and Lion Rock. The entrance is low and set back to preserve views to Lion Rock.
- Light-filled workspaces are provided for the laboratory and supporting staff.
- The building is integrated into the landscape.

2.2. Treatment process precinct

In line with the administration building, the treatment process precinct of South Works is situated in a large area surrounded by green mountains with a lot of vegetation.

Integrating – The development of buildings aims at creating a complex of different water treatment process units which are designed with simple massing and harmonized with the natural landform. Each building within the process precinct is designed to height fits for its function in order to reduce environmental impact caused by excessive building height. In addition, extensive greenery is provided to the ground, roof and the elevations of the buildings. It helps to blend the buildings with the nature.

Simple – It is aimed at adopting a simple and modern style. The facade of buildings is designed to be precast concrete cladding with fair-faced concrete finish. With the introduction of green features on the elevations and the roof, the monotonic appearance of a linear and long building is dissolved and giving interesting elevations. A different colour is assigned to each individual building. The strong contrast between the light grey wall colour and the colour wall gives a remarkable identity to each of the building.



Figure 3: Design of treatment process precinct

Real Materials – Recycled materials such as structural steel, fair-faced concrete panel, stone, recycled plastic, recycled pavers, environmentally friendly paint etc. are extensively used throughout the treatment plant as far as practicable. The materials proposed are durable, environmentally friendly and less maintenance is required.

Quality of workplace – In the building design, different aspects such as view, capture of daylight, ventilation, spatial arrangement etc. are considered. It is aimed at providing a healthy and comfortable work place for the users of the development.

3. SUSTAINABILITY AND ENERGY

In terms of sustainability, the building design follows the Hong Kong Building Environmental Assessment Method (BEAM) managed by the Hong Kong Green Building Council and BEAM Society.

In the sustainability design, one of the key factors is maximization of natural lighting. In this regard, the solar time throughout the year has been checked and used in the building design. The application of the concept of solar time for passive solar design, and the angular relationship between the sun, the building and any shading devices and obstructing bodies is considered. The degree difference in the altitude of the sun at solar noon between winter and summer combined with local climatic data was used to determine at what time of the year solar gain will be beneficial for thermal comfort in winter, and when it should be blocked with shading in summer.

Rainwater harvesting system is incorporated to form part of the sustainable design. It is simply the collection of rainwater for use that would otherwise go down the drain. An extensive green roof system is implemented on the Administration Building. A water management system with the extensive green roof system can collect rainwater and become a part of the landscape feature. Leaves and other debris would be filtered out before the collected rainwater to be conveyed to a storage tank. The collected rainwater is eventually pumped through distribution system for irrigation purpose.

In the design of the Administration Building, ice storage system is incorporated as an energy management tool that transfers energy use from peak-hours to non-peak hours. As a result, air conditioning can be provided more efficiently, by using lower electricity costs at non-peak time when the energy demand is low at night, to freeze water into ice. The ice is then melted during the day-time to reduce the consumption of electricity at higher costs to meet the air conditioning demands during peak time.

STWTW treats raw water from 5 different sources during the day and throughout the year. Under the existing pumping/transfer pattern, the draw-off from the High Island Reservoir can be at a head of over 25 m when reaching the STWTW. Currently, the excess energy is dissipated by using the Energy Dissipating Chamber. Recognizing the steady draw-off from the High Island Reservoir and the significant potential energy associated with this route, a Hydro Power Plant is proposed to recover the energy from the excessive static head which is now wasted in the energy dissipation chamber.

The design of water turbine generator system for electricity generation is based on the maximum and minimum water power available under different flow and available head. The Hydro Power Plant serves as a base load generating plant to supplement the 380V utility supply at STWTW and is operated for parallel connection with the grid of CLP Power Hong Kong Limited through a unit power converter for automatic synchronization.

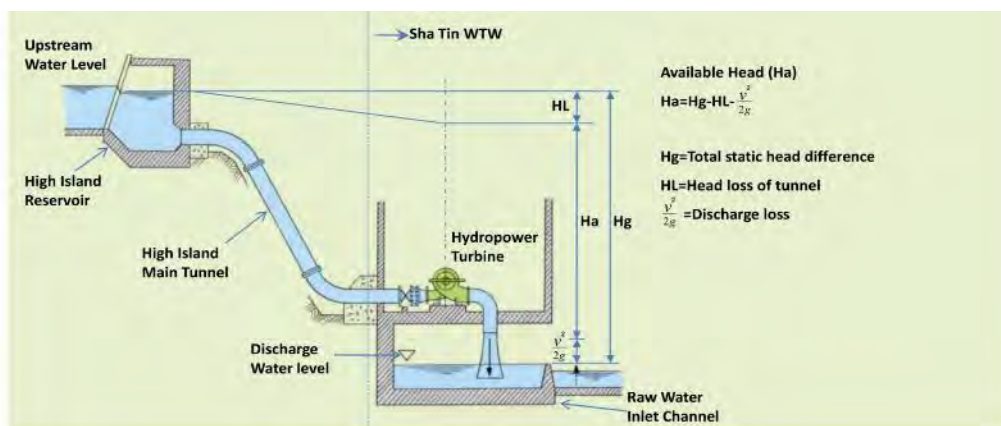

Figure 4: Available head for hydro power plant

4. OUTDOOR LIGHTING AND GREENING

STWTW requires enhanced security measures including outdoor area lighting and security lighting. Security precautions in STWTW is essential in order to prevent theft, unauthorised entry and safeguard premises against vandalism. In the installation, lighting is designed to fulfil two basic functions for (a) outdoor area lighting; and (b) security lighting.

Outdoor area lighting is designed to give a level of illumination appropriate to the use of the area. The lighting should normally be sufficient for normal conditions and if necessary, should be capable of providing an adequate level of illumination at the security fence line when used without the security lighting.

Traditionally, and for those being installed in the present STWTW, fixtures are of High Intensity Discharge (HID) type, either of High Pressure Sodium (HPS) or Metal Halide (MH) lamp. They are always known to have poor energy efficiency, shorter lamp life and poor light level uniformity. Furthermore, they are not considered as Green Power product.

For security lighting, it must be designed to meet the requirements laid down by the Security Bureau of HKSAR. The lights should be strategically located with the required minimum illumination level, using existing buildings whenever possible, but otherwise using poles. The lights should be focused to cover, as far as is practical, the entire security fence line.

However, the excessive light level emitted from the existing STWTW induces light pollution to the residential area in close proximity to the treatment works.

In visiting and reviewing the lighting scheme for open areas at STWTW, due considerations are given to the avoidance of light pollution, over-illumination, but with the minimum level of "lux" or illumination attained to meet safety and security needs on site, particularly at the boundary fence of the works. The approach or principle adopted in engineering the design basis for the lighting scheme in STWTW is "Green Power, Energy Saving, & No Light Pollution".

The context of Light Pollution is not limited to just over-illumination, but also means light intrusion or trespassing, glare disturbances. In other words, it means "suitability" or "appropriateness" of lighting arrangements to meet safety and security needs, but not to cause interferences or disturbances to others.

The application of LED to replace SON floodlight has most of the advantages to be adopted. It is noted that LED in today's lighting market has established its proven ground with good performance, reliability, energy efficiency and easier adaptation. Green and saving energy is achieved by means of using LED, each installation coupled with individual solar panel and wind turbine, and adopting dual mode operating regimes in outdoor area lighting under two open area zones, the essential and idling.

The use of state-of-art thermal network camera complemented with conventional cameras and an intelligent lighting network control system, coupled with Thermal Vision Based Security Surveillance (TVBSS) system as the basic security system is proposed, which is used to further control and dim down lightings in essential open areas and service roads for energy saving and to mitigate the effects of any light pollution caused by public lighting in the works.



Figure 5: Thermal Vision Based Security Surveillance (TVBSS) system

The cameras of TVBSS system do not capture objects under visible light as for conventional cameras. They detect invisible thermal radiation emitted from the objects, and movement of any objects in the field covered by the camera, regardless of darkness, brightness, smoke or fog in the environment. They provide an effective means to detect the movement of any objects under surveillance that would trigger further actions, and greatly enhance the effectiveness of the surveillance system. It will not only provide reliable security surveillance and tracking trespasser in a dark environment, but also further help dim down lightings in essential open areas and service roads etc. to only one-quarter of normal power in normal dark hours, at a minimum of 25 lux illumination. This is a strategic approach to enhance energy saving and to minimize light pollution in open areas in the new STWTW.

A triple-control illumination system is applied for open area lighting and security lighting, viz. a 3-step dimming to 1) none or minimum illumination overnight; 2) to a mid-lighting level which is regarded as a minimum environment for safe walking and patrolling in sensing movements by TVBSS system or by manually setting; and 3) the highest

intensity level for safe work and inspections. Different precincts within STWTW have different lighting requirements and hence different energy consumptions. Hence, zoning for lighting will help energy saving at the precincts that lighting in dark is not a prerequisite. The two different zones of open area lighting of STWTW are i) essential zone including all roads and major buildings; and ii) idling zones including plant area such as filters and water tanks. The criteria and operating regimes recommended for lighting designs over different open area zones and security lighting are summarized at below Table 1. Moreover, energy saving is achieved through the use of LED lighting.

Location / Zone		Base lighting in dark hours	Triggered by TVBSS / Manual Override	Full Intensity during Work/ Inspections on Manual Demand
Open Area Lighting	Essential Zones	25	75	150
	Idling Zones	0	75	150
Security Lighting	Boundary Walls & Fencing	25	75	150
	Security Gate House	75	150	N/A

Table 1: Triple-Control Illumination System Illumination Levels (LUX)

The total greenery areas for the reprovisioned STWTW is not less than 30% of its total site area. The greening strategy aims at creating an attractive environment which is coherent with the building layout for staff and visitors. The site landscape is organized on a linear framework which aligns with the grid form of the building roofs to provide logically connected outdoor space for staff, low-maintenance and robust greenery around the treatment process precinct. The design brings the landscape features into the site which provides woodland areas, green roofs and boundary evergreen planting with native species adding a natural quality to the space.

5. CONCLUSION

This paper summarizes the designs regarding to the sustainable building development of the reprovisioning of STWTW. Having the administrative building and treatment process precincts imbedded in creating a synergy and coherent relation with the topological character, the buildings and landscape features as a whole integrate with the surrounding environment and the adjacent land users.

The sustainable designs, including green roof system, natural lighting system, rainwater harvesting, ice storage system, hydro power generator, and the thermal network camera system, enhance energy saving and minimize the environmental impact to the neighbourhoods.

REFERENCES

- [1] The Government of the Hong Kong Special Administrative Region, Hong Kong Planning Standards and Guidelines (HKPSG)
- [2] CIBSE, 2012. SLL Code for Lighting
- [3] The Government of the Hong Kong Special Administrative Region, 2012. Code of Practice for Energy Efficiency of Building Services Installation

Low-Carbon Transport Development Strategy of Coping with Climate Change-the Case of Pingtung County

CHUNG Shih-yen^a, CHANG Kuei-feng^b, CHEN Ming-chang^c, KUO Wu-wei^d, CHEN Yu-jia^e

^a Pingtung County Government, Taiwan, a001719@oa.pthg.gov.tw

^b Pingtung County Government, Taiwan, a001811@oa.pthg.gov.tw

^c Pingtung County Government, Taiwan, a000080@oa.pthg.gov.tw

^d Pingtung County Government, Taiwan, a001549@oa.pthg.gov.tw

^e Pingtung County Government, Taiwan, a001842@oa.pthg.gov.tw

ABSTRACT

Pingtung County is located at the southern extremity of Taiwan. In order to cope with the impact of climate change, Pingtung County government is actively promoting the development of public transport systems, reducing of greenhouse gases caused by private transport emissions, and minimizing the impact on the environment.

Pingtung County government is not only actively seeking rail construction plan from the Center Government but also planning to expand the public transport coverage by building regional transit center, hierarchical bus network and bicycle sharing system.

The regional transit center is including one for main hub (Pingtung), two for secondary hubs (Chaozhou, Fangliao), and three for Sightseeing function hubs (Donggang, Shueimen, Hengchun). The hierarchical bus network is including main line bus, branch line bus, suburban bus, tourist bus, and Demand Responsive Transit System bus. The bicycle sharing system provides the last mile feeder service.

In order to increase public transport usage, Pingtung County Government also provides high quality, high technology, and intimately services by building bus shelters, bus information system, and executing bus service quality evaluation plan and overall marketing plan.

However, those policies will not be completed quickly. Therefore, we will determine the priority of policies by citizen demands and available resources, and promote those policies progressively to achieve the vision of transportation development of Pingtung County.

Keywords: climate change, public transport, development

1. INTRODUCTION

2016 marks a milestone in railway development in Pingtung County. The elevated railway has been constructed and TRA Rapid Transit Systematization is expected in the near future. However, the problems related to bus service in Pingtung County remain unsolved despite advances in railway infrastructure. Bus service quality has seen slow progress due to challenges incurred by "convenience of private vehicles" and "deficits in bus service operation", which has in turn caused a decrease in ridership. In light of the status quo, the prospect of TRA Rapid Transit Systematization does not seem as promising as expected. The increase of bus ridership by improving the operation of Pingtung's bus service has become an issue of concern, particularly when TRA Rapid Transit Systematization is being carried out.

There are a great number of measures to increase bus ridership. Generally, these measures can be categorized into the push-pull strategy, where the push strategy, based on the price mechanism and use management, is intended to curb the growing rate of private vehicle ownership and reduce the demand for the use of private vehicles, while the pull strategy, which works by improving the service quality of mass transportation, is adopted to lower the market share of private vehicles. In terms of improving bus service quality, several aspects should be taken into consideration, including the appropriateness of bus routes, frequency of bus runs, the comfort level of bus waiting areas, the provision of bus schedule information, etc. With a focus on the bus route network, this study aims to examine the current layout of the network. It is expected that the research results will serve as a reference to design a network that meets the demands of both the public and bus service operators, thereby raising the willingness of the public to take buses. Accordingly, the objectives of this research project are set as follows:

identifying the drawbacks of urban and county highway bus routes in order to bridge the rural-urban gap and to enhance the performance of mass transportation; raising the willingness of the public to use mass transportation systems and to cut down on the use of private vehicles; integrating the railway and bus systems to shorten travel time; and more effectively utilizing transportation resources, restricting the consumption of transportation resources, and enforcing the policies of energy saving and the reduction of carbon emissions.

2. CURRENT STATUS OF THE TRANSPORTATION NETWORK IN PINGTUNG

The mass transportation system of Pingtung County is mainly composed of the railway and highway transportation system. The "TRA Kaohsiung-Pingtung Chaozhou Rapid Transit Systematization Construction Project" for the railway system was completed in June 2016 when the rapid transit service along the section north to Chaozhou was put into operation. Currently, the railway system of Pingtung County consists of the Pingtung Line and the South Link Line, with the former connecting the Pingtung, Fengshan, and Kaohsiung areas, and the latter heading towards Taitung County. The Pingtung Line starts at Kaohsiung Port Station and ends at Fangliao Station with a total length of 68.2 kilometers; the Kaohsiung-Chaozhou section features an electrified double-track railway, while the Chaozhou-Fangliao section is non-electrified and single-tracked. The South Link Line, running from Fangliao to Taitung, covers a total length of 98.2 kilometers, and is still a non-electrified and single-track railway. The ridership of the Pingtung Line and the South Link Line is 11.542 million and 7,500 in 2013, respectively. In 2014, the ridership of the Pingtung Line was 11.539 million, and it was 9,000 for the South Link Line, indicating a slight growth for the latter and a drop (-0.02%) for the former.

The highway transportation system includes intercity freeway transportation as well as city-township buses and urban buses. There are four freeways in use, and bus routes, except for a small number of cross-county routes, are mostly city-township buses. There are a total of 56 bus routes, and there are 21 routes for urban buses that only run within a single administrative area.

The ridership of the 46 intra-county bus routes dropped from 2.917 million in 2010 to 2.63 million in 2012, and increased annually until it dropped to 3.405 million in 2015 from its high of 3.482 million in 2014. However, this was an increase of 0.775 million in comparison with 2012, with an annual growth rate of 5.14%. The ridership of urban buses increases from 0.302 million in 2011 to 0.502 million in 2015, with a noticeably high average annual growth rate of 13.45% for these five years as shown in Figure 1.

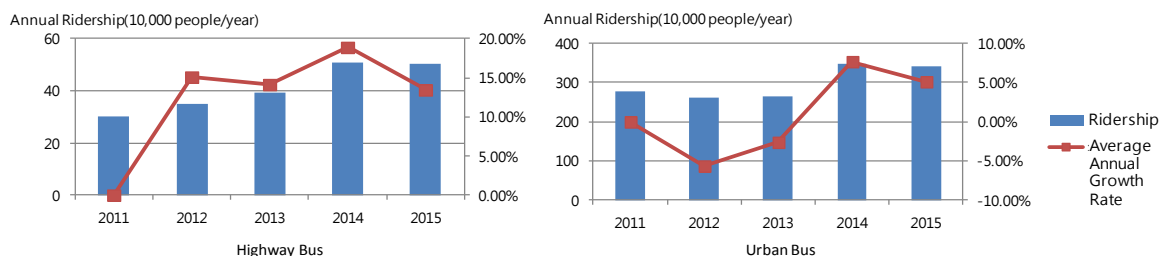

Figure 1: Annual ridership of highway bus and urban bus (unit: 10,000 people/year)

3. PROBLEMS IN BUS SERVICE

Although the overall ridership of the mass transportation in Pingtung County has seen growth since 2011, it can be noted from Figure 1 that there was a slight drop in 2015. Possible reasons are as follows:

- The bus routes are arranged based on the highway network, and mostly radiate out from more densely populated areas to the less populated ones. Since the layout of bus routes was designed with the entire county in mind, one single bus is principally assigned for one route without adequate bus transfer facilities. This has caused over-length of the bus routes, the low frequency of bus runs, and inefficiency of transportation.
- There is no clear hierarchy for the bus routes. Except locals who are used to taking buses, tourists from outside the county, or locals who take buses less often, are incapable of differentiating the bus routes; they would rather use private vehicles instead.

- Long distances and low traffic volumes in remote areas mean low profitability from bus operation; few bus service companies are willing to invest in the bus operation in such areas, which in turn causes inconvenience in seeking medical services and education, as well as in purchasing daily necessities for the locals.

4. PROPOSAL OF SOLUTIONS

In order to build a low-carbon transportation environment for Pingtung County, the promotion of public transportation use should be prioritized in order to reduce the use of private vehicles. To address the abovementioned problems in the public transportation of Pingtung County, the following solutions are proposed, which include: establishing regional transfer centers, designing a hierarchical bus network, and formulating a public transportation improvement project.

4.1 Establishing regional transfer centers

To enhance bus operation efficiency and to provide comfortable space for passengers, it is necessary that appropriate regional transfer facilities be established to better integrate the bus routes. First of all, highway bus transfer stations with comfortable waiting areas should be set up. As for the locations of the stations, an investigation should be conducted to understand the demand of the public for mass transportation, including their demand for the arrangement of bus routes that connect with railway stations, the frequency of bus runs within the administrative area where they live, and their bus transfer needs.

4.1.1 An analysis of the demand concerning bus run frequency and bus transfers

4.1.1.1 Prediction of the demand for the frequency of bus runs at railway stations

According to the prediction results regarding the demand for the frequency of bus runs at railway stations on weekdays in the "Series of the Fifth Taiwan Area Comprehensive Transportation Planning Research - Study to Review the Intercity Transportation System Demand Model, as well as Update the Parameters (1/3)", there are a total of 18 bus stations adjacent to railway stations in Pingtung County, among which the top three bus stations in terms of ridership are Pingtung Station, Chaozhou Station, and Fangliao Station. If we divide Pingtung County into northern, central, and southern Pingtung, these three stations can be identified as the railway transportation centers for these three regions, respectively.

4.1.1.2 An analysis of the characteristics concerning the frequency of highway bus runs

According to the Origin-Destination (O-D) data in regard to urban buses and county highway buses, suggestions based on the frequency of bus runs, origins and destinations, as well as the distribution of transfer locations and the quantity of transfers in each administrative area can be proposed as a reference for the location selection of bus transfer stations.

Based on the data of origins and destinations in rides that use IC-Cards or ticket machines, the frequency of bus runs in each administrative area was analyzed. The results show that Pingtung City ranks at the top in the average daily number of bus runs, followed by Neipu Township, Hengchun Township, Wandan Township, Chaozhou Township, and Ligang Township, with Pingtung City and Ligang Township categorized as the northern Pingtung area; Chaozhou Township, Neipu Township, and Wandan Township as the central Pingtung area; and Hengchun Township as the southern Pingtung area.

When it comes to the average number of transfers on a daily basis, there are 136 persons making a transfer in Pingtung City, 10 persons or more in Wandan, Chaozhou, and Neipu, and 9 persons in Hengchun and Ligang, indicating that, except for Pingtung City, where a large number of bus routes converge, there are a lot fewer transfer spots in the townships, which accounts for the low number of transfers.

4.1.2 Location selection of regional transfer centers

4.1.2.1 Criteria for the selection

In the bus transfer system of Pingtung County, Pingtung Station still serves as the main bus transfer station. However, with the "TRA Kaohsiung-Pingtung Chaozhou Rapid Transit Systematization Construction Project" being implemented, it is necessary to re-examine the current status and design a suitable mass transportation network upon which to establish bus transfer centers. The criteria to select the locations for the transfer centers include: Being near railway transportation systems; Serving the purpose of bus transfer for tourism or leisure activities; Being on main arteries that connect with administrative areas.

4.1.2.2 The selection result

After the initial selection process, the chosen sites include: seven locations with railway systems (Pingtung Station, Gueilai Station, Linluo Station, Sishih Station, Zhutian Station, Chaozhou Station, and Fangliao Station) and five sites that facilitate tourism activities, or are on the main arteries with easy access to administrative areas (Ligang Station, Gaoshu Station, Shueimen Station, Donggang Station, and Hengchun Station). However, not all these sites meet the criteria for a transfer center. On account of this, second selection phase was conducted with the criteria listed below:

- **The importance of Pingtung's life circle hierarchy system**
- The size of the hinterland around the site
- The width of the road in front of the site
- The degree of difficulty to acquire the land lot for the site
- The number of bus routes in use
- How many varieties of transportation means are available at the site?
- Whether or not the establishment of the transfer center can facilitate tourism activities

In accordance with the above seven criteria, six sites were chosen, including one main transfer center (Pingtung Station), two secondary transfer centers (Chaozhou Station and Fangliao Station), and three transfer stations for tourism purposes (Donggang Station, Hengchun Station, and Shueimen Station). See Figure 2.



Figure 2: Six transfer centers in Pingtung country

4.2 Hierarchical bus network

In consideration of the fact that Pingtung is geographically a long and narrow county, the layout of the transportation system is in a north-south direction and the bus routes radiate out from densely-populated areas to the less populated ones. Based on the railway systems, the highway network, and the development characteristics of tourist spots in Pingtung County, the overall "radiating-patterned" bus transportation network can be hierarchically categorized into seven levels: bus stations near railway systems, cross-region expressway buses, main artery buses, sub-arterial road buses, regional buses, tourist shuttle buses, and Demand-Responsive Transit (DRT). Definitions of these seven levels of bus service are listed in Table 1.

Type	Definition
Bus stations near railway systems	Routes under the Rapid Transit Systematization project
Cross-region expressway bus	Running on cross-county/ city expressways
Main artery bus	Meant for transportation service on main arteries, including highways with high traffic volumes
Sub-arterial road bus	Subsidiary to main artery buses and principally running on sub-arterial roads that connect with peripheral areas or tourist spots, such as cross-township buses
Regional bus	Running within the same township or city; only part of the routes connect with adjoining townships. The routes with this type of bus service are under the jurisdiction of the local government, such as urban buses, shuttle buses, circuit buses, etc.
Tourist shuttle bus	Providing bus service between transfer centers and tourist spots, satisfying the needs for tourism
DRT	Providing bus service for remote areas without bus routes; DRT service offers access to mass transportation stations or major tourist spots near the remote areas.

Table 1: The hierarchical bus network in Pingtung county

With the planning of cross-county expressway bus routes, the adjustment of bus routes in keeping with the Rapid Transit Systematization project, the establishment of new bus routes to areas without bus service, the planning of a more complete network that connects tourist spots, and the provision of DRT service for remote or mountain areas, the result will be as follows: three new cross-region expressway bus routes; improving six main artery bus routes; 44 sub-arterial road bus routes, including the adjustment of one Rapid Transit Systematization bus route; 27 regional bus routes, including the adjustment of one route and the establishment of five new routes; five tourism bus routes (originally three plus two new routes); and 21 DRT routes (10 of which are new).

The overall number of routes will increase from the originally 88 (county highway: 56; urban bus: 19; tourism bus: 2; DRT: 11) to 108 (cross-region expressway: 5; main artery: 6; sub-arterial road: 44; regional bus: 27; tourism bus: 5; DRT: 21). The added 20 bus routes cover the areas from northern Pingtung to northern Kaohsiung and from central Pingtung to Fengshan, thereby providing a more convenient public transportation service.

4.3 Formulating a public transportation improvement project

Prioritized policies, based on the available resources and the needs of the public, will be formulated to establish regional transfer centers and the hierarchical bus network. To encourage the public to use mass transportation systems, bus waiting sheds, step entrance buses and electric buses, the real-time bus information system, the bus service quality evaluation program, and a comprehensive marketing plan are among the strategies to increase ridership with high-quality, technologically advanced, attentive, and publicly attractive services.

- Subsidies for bus operation deficits in remote areas: Safeguarding the rights of mass transportation for residents in remote areas, expanding passenger population via long-term operation;
- Shuttle bus service for large-scale events: Alleviating traffic congestion during events by encouraging event participants to take buses;

- Replacing old buses with new ones: Promoting the use of accessible buses, electric buses, and double-decker buses to enhance the quality of bus rides;
- Setting up bus waiting sheds: Improving the bus waiting environment, thereby raising the willingness to take buses;
- The real-time bus information system: Providing the information of bus arrival, thereby shortening waiting time without the sense of uncertainty in waiting for the buses;
- The bus service quality evaluation program: Supervising bus service operators to continue improving the bus service quality;
- Promoting the marketing plan to maximize ridership: Launching various price or non-price based marketing measures.

5. CONCLUSION AND SUGGESTIONS

5.1 Conclusion

- The reduction of motor vehicle use is the first step to building a low-carbon transportation environment. Vehicles of high passenger capacity, including railway systems such as MRT, LRT, and Monorail, and highway transportation systems such as BRT and BUS, are more preferable to transportation means of low capacity. Given the mass transportation environment and roadway conditions of Pingtung County, the promotion of low-carbon transportation should start with the establishment of an improved and better-integrated mass transportation network.
- Pingtung County is one of Taiwan's strongholds for agriculture and fishery industries. Its mass transportation systems greatly differ from those of urban commercial areas, and users of mass transportation in Pingtung are used to the current transportation systems and routes. To eliminate the impacts arising from the adjustment of routes and to enhance transportation efficiency, strategies including establishing transfer centers, categorizing the routes, adjusting part of the routes, establishing new routes for a more complete transportation network, and improving the bus waiting areas are proposed to achieve a low-carbon transportation environment.
- After route integration, there are 108 bus routes of six types, which replace the original 88 bus routes that only included county highway and urban bus routes, thereby more fully satisfying various transportation needs.

5.2 Suggestions

- Profitability is often a challenge in the early operation phase for new bus routes, and deficits are mostly inevitable. For the sustainable operation of bus service, competent government authorities should provide subsidies to cover the deficits. After a certain period of operation, reviews should be conducted to determine the adjustment of the routes, the frequency of bus runs, or the cancellation of the routes.
- To encourage the public to use mass transportation systems instead of private vehicles, it is imperative to provide safe and comfortable waiting areas and space in the bus. The priorities of the government's competent transportation authorities should be placed on the use of passenger-friendly buses, the establishment of transfer centers, and the provision of real-time bus information.

REFERENCES

- [1] Bogotá., 1998. TransMilenio.
- [2] Kaohsiung City Government, 2010. The Multifunctional Transfer Center with the Integrated Mass Transportation Systems of Kaohsiung County, Kaohsiung City, and Pingtung County.
- [3] Kaohsiung City Government, 2012. The Planning and Design of Transfer Centers for the 30-Minute Life Circle in the Greater Kaohsiung Area.
- [4] Pingtung County Government, 2016. Project for the Integration and Planning of Mass Transportation Systems in Pingtung County.
- [5] Taichung City Government, 2000. Research on the Planning of Urban Bus Routes with High Potential Ridership and the Privatization of Rights of Management for Bus Routes.

Potential for Decreasing of Organizational Environmental Impacts Through Improvement of Property Energy Efficiency: A Case Study of Czech Ministry of Labour and Social Affairs

Antonín LUPÍŠEK^a, Vladimír KOČÍ^b, Kateřina SOJKOVÁ^c, Kristina ZAKUCIOVÁ^d, Jiří TENCAR^e, Miloš LAIN^f, Miroslav URBAN^g, Jiří CÍGLER^h, Vladimír HORYNAⁱ

^a Czech Technical University in Prague, University Centre for Energy Efficient Buildings, Czech Republic, antonin.lupisek@cvut.cz

^b University of Chemistry and Technology, Prague, Czech Republic, vlad.koci@vscht.cz

^c Czech Technical University in Prague, University Centre for Energy Efficient Buildings, Czech Republic, katerina.sojkova@fsv.cvut.cz

^d University of Chemistry and Technology, Prague, Czech Republic, k.zakuciova@gmail.com

^e Czech Technical University in Prague, University Centre for Energy Efficient Buildings, Czech Republic, jiri.tencar@cvut.cz

^f Czech Technical University in Prague, University Centre for Energy Efficient Buildings, Czech Republic, milos.lain@fs.cvut.cz

^g Czech Technical University in Prague, University Centre for Energy Efficient Buildings, Czech Republic, miroslav.urban@fsv.cvut.cz

^h Czech Technical University in Prague, University Centre for Energy Efficient Buildings, Czech Republic, jiri.cigler@cvut.cz

ⁱ Czech Technical University in Prague, University Centre for Energy Efficient Buildings, Czech Republic, jiri.cigler@cvut.cz

ABSTRACT

The paper presents potential for decreasing of organizational environmental impacts of public organizations on **case study of Czech Ministry of Labour and Social Affairs. It analyses actual organisation's environmental impacts** and sets several variants for their reduction by eight to twenty-three percent. The highest potential for improvement laid in renovation of windows and in increasing the efficiency of cooling of two big server rooms. On the other hand, the potential for reduction of **organisation's environmental impacts related to optimization of office operation** was found in most of the observed environmental indicators only small or medium.

Keywords: corporate social responsibility, energy saving, life cycle assessment

1. INTRODUCTION

1.1 Corporate social responsibility of public organizations

Corporate social responsibility (CSR) slowly but steadily becomes a standard element of operations of public organizations in Czechia and some ministries act as front runners and behave as a shining example for the other public bodies in the country. This paper presents one example of efforts on the case study of Czech Ministry of Labour and Social Affairs (hereafter referred to as MPSV, official abbreviation in the Czech language).

1.2 Motivation

The practical motivation to undergo the presented work was demand from the MPSV to improve its overall efficiency and reduce environmental impact of its operations. The research motivation was general lack of information on how significant is contribution of operation of historical building stock to the environmental impacts of such institution.

1.3 Objectives

The main objectives of the presented paper are i) to analyse overall environmental impacts of operation of the MPSV; ii) to present potential for reduction of the impacts by technical and managerial measures; and iii) to compare the improvement potential coming from possible energy savings in the ministerial buildings with various non-building-related measures.

2. METHODS

2.1 Analysis of overall environmental impacts of operation of the Czech Ministry of Labour and Social Affairs

The analysis of the environmental impacts of the operation of the MPSV was based on life cycle assessment (LCA) methodology with use of GaBi 6 software. It was divided into the two areas: i) impacts resulting from operation of the main building; ii) impacts resulting from operation of the offices and sourcing of office supplies.

The study analysed the six impact categories:

- Global warming and climate change;
- Acidification;
- Eutrophication;
- Photochemical ozone creation;
- Abiotic resource depletion;
- Primary energy consumption.

The following paragraphs describe the boundary conditions and inventory analysis of the two areas.

Operation of the main building

The MPSV resides in an old building in Prague historical conservation area (see Figure 1). The building of MPSV **was built in 1920's and the building envelope has not changed since then. External walls of thickness of 60 cm are made of full bricks without any additional thermal insulation; hung sash windows are original; some parts of roofs are thermally insulated.** The building has central heating system; source of heat is gas boiler house in adjacent complex of buildings. The heat is delivered by hot water piping with 90/ 70°C temperature gradient; the nominal input heat power is 901 kW. The building does not have a central cooling system; there are only several cooling units in selected offices and there are large cooling systems in two datacentres (running central registers of the Ministry).

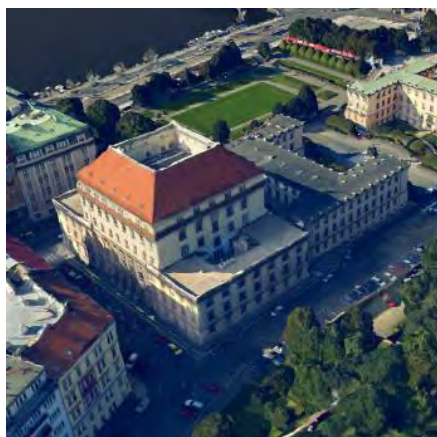

Figure 1: Residence of MPSV in Prague (Source: Mapy.cz)

The main source of the environmental impacts of buildings' operation is the energy consumption. The energy consumption has been further categorized and analysed based on data from invoices for the past 3 years delivered by MPSV and from own measurements in situ. The main consumption of electricity goes with cooling of server rooms (473 MWh/year), running of servers (429 MWh/year), electricity consumed from sockets in offices (213 MWh/year), lighting (71 MWh/year), water heating (46 MWh/year) and other consumption (32 MWh/year). Consumption of heat was 912 MWh/year.

Besides energy, in the building was yearly consumed in average 6,230 m³ of fresh water and 30 l of detergents.

Operation of the offices and sourcing of office supplies

As inputs to the LCA of offices operations were included consumption of printing and copy paper (1,327 kg/year), office consumables (modelled separately by included mass of paper, metal, plastics, PVC, polypropylene, inks and toners), office furniture (chairs and tables purchased in 2014 modelled as typical office set), and computers and laptops.

2.2 Potential for reduction of the impacts by technical and managerial measures

The potential was based on proposed energy saving measures and estimated energy savings potentials:

- M1: Complete renovation of all windows resulting in reduction of the U values of glazing from approx. 2.6 W/m²K to 1.0 W/m²K by replacement of the outer single glazing by double glazing and new window gaskets (yearly energy saving potential 250 MWh and additional 125 MWh respectively)
- M2: Replacement of lights and reduction of number of lamps in spaces where actual number is not necessary (potential of yearly savings 19 MWh)
- M3: Increase in efficiency of the data centres by installation of units using freecooling in winter season and improvement of cold distribution in the server rooms by division into cool and warm aisles (potential of yearly savings 76 MWh)
- M4: Utilization of exhaust heat for hot water pre-heating (13.3 MWh/year)
- M5: Removal of flow water heaters for hot water preparation in toilets (savings 25 MWh/year)
- M6: Adjustment of hot water circulation by switching of the circulation pump between 7 PM and 6 AM and reduction of water consumption by installation of faucet aerators (energy saving potential 2 MWh/year)
- M7: Installation of model-based predictive control of the heating system (potential to save 108 MWh of heat yearly)
- M8: Operational measures – i) reduction of operational temperatures in most of spaces as a result of complete renovation of windows (due to improved airtightness and warmer surfaces) and ii) replacement of old refrigerators by new ones; iii) replacement of old reading lamps by new with LEDs (approx. saving potential 32 MWh/year).

Measure		Heat	Electricity	Natural gas
		[MWh]	[MWh]	[MWh]
M1	Windows renovation	-375.0		
M2	Lighting		-19.0	
M3	Increasing efficiency of data centres cooling		-339.0	
M4	Utilization of exhaust heat for hot water pre-heating	+60.5	-46.2	-27.6
M5	Removal of flow water heaters		-25.0	
M6	Adjustment of hot water circulation			-2.0
M7	model-based predictive control	-107.5		
M8	Operational measures		-32.0	

Table 1: Energy saving potentials of proposed measures

Measures can be combined; however, some measures contraindicate others. The following possible combinations of measures were further analyzed:

- Var.1: M1, M2
- Var.2: M1, M2, M3
- Var.3: M1, M2, M3, M4
- Var.4: M1, M2, M7
- Var.5: M1, M2, M3, M7
- Var.6: M1, M2, M3, M4, M7, M8
- Var.7: M1, M2, M3, M5, M6, M7, M8

2.3 Comparison of the improvement potential coming from possible energy savings in the buildings with various non-building-related measures

The values of environmental indicators coming from the LCA in the first step (Section 2.1) set the reference level. Various scenarios of improvement were combined from the possible reduction of the impacts resulting from work described in Section 2.2. For these scenarios were calculated and analysed respective environmental impacts.

3. RESULTS

3.1. Results of analysis of overall environmental impacts of operation of the Czech Ministry of Labour and Social Affairs

The overall environmental impacts of operation of MPSV are presented below in Table 2 and Chart 1 shows contribution to environmental impacts by areas of investigation. As can be seen, in most environmental categories, impacts related to operation of the MPSV building dominates above office operation and sourcing of office supplies. Therefore, it also provides higher potential for impacts reduction.

Impact category	Unit	Value
Abiotic Depletion (elements)	[kg Sb-Equiv.]	6
Abiotic Depletion (fossil)	[GJ]	14 674
Acidification Potential	[kg SO ₂ -Equiv.]	7 284
Eutrophication Potential	[kg Phosphate-Equiv.]	616
Global Warming Potential	[kg CO ₂ -Equiv.]	1 383 924
Photochem. Ozone Creation	[kg Ethene-Equiv.]	471
Primary energy consumption	[GJ]	18 477

Table 2: The overall environmental impacts of operation of MPSV

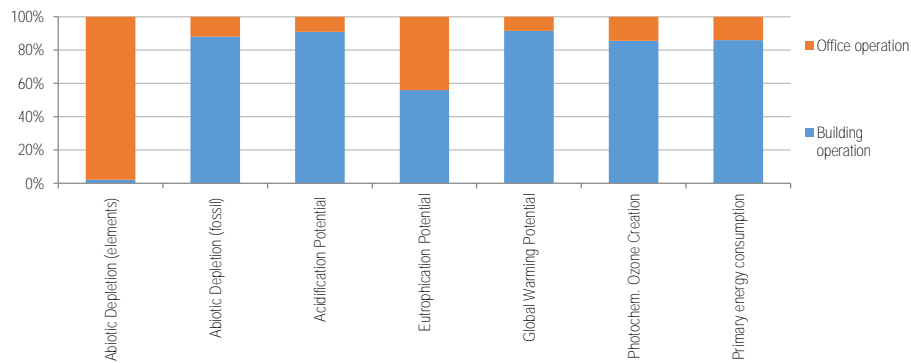

Chart 1: Ratio of the two areas (building operation; office operation and sourcing of office supplies) on the environmental impact categories

Impact category	Impact	Share of the main contributors of office operation and sourcing of office supplies on the environmental impacts [%]				
		Office supplies	Furniture	PC + Notebooks	Printing paper	Other
Abiotic Depletion (ADP elements) [kg Sb-Equiv.]	5.90	2	0	97	0	0.3
Abiotic Depletion (ADP fossil) [GJ]	1 759	18	60	13	4	3.6
Acidification Potential (AP) [kg SO ₂ -Equiv.]	660	15	47	27	5	4.8
Eutrophication Potential (EP) [kg Phosphate-Equiv.]	272	3	12	76	6	4.0
Global Warming Potential (GWP 100 years) [kg CO ₂ -Equiv.]	117 092	12.6	66	19	1	0.9

Photochem. Ozone Creation Potential (POCP) [kg Ethene-Equiv.]	68.4	12	54	27	5	2.8
Primary energy demand from ren. and non ren. resources (net cal. value) [GJ]	2 962	15	59	10	9	7.3

Table 3: The environmental impacts of office operation and sourcing of office supplies and share of the main contributors

3.2. Potential for reduction of the impacts by technical and managerial measures

Chart 2 summarizes the potential for reduction of the environmental impacts by combinations of building operation saving measures outlined in section 2.2. From the proposed combinations, the variants 2, 3, 5, 6 and 7 have high potential to decrease the environmental impacts.

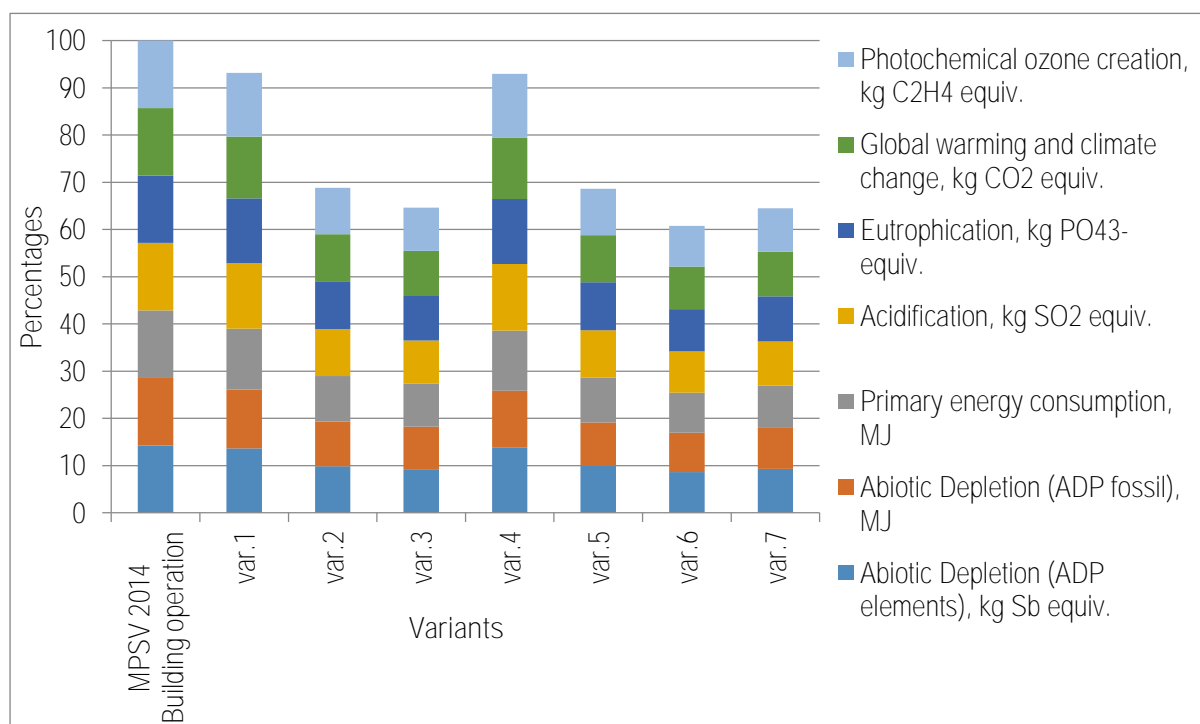

Chart 2: Environmental impacts saving potential of proposed measures compared to current state

4. CONCLUSIONS

The paper analyses actual organisation's environmental impacts and sets several variants for their reduction by eight to twenty-three percent. The highest potential for improvement laid in renovation of windows and in increasing the efficiency of cooling of two big server rooms. On the other hand, the potential for reduction of organisation's environmental impacts related to optimization of office operation was found in most of the observed environmental indicators only small or medium.

ACKNOWLEDGEMENTS

This work has been supported by the Ministry of Education, Youth and Sports within National Sustainability Programme I, project No. LO1605 and by the national grant "Efektivní řízení úřadu MPSV", reg. No.: CZ.1.04/4.1.00/D4.00005.

A Preliminary Study on the Performance of Indoor Environment with Green BIM Tools - Taking Light Environment and Thermal Environment as an Example

CHEN Nien-tsu^a, CHEN Ying-sheng^b, TSAY Yaw-shyan^c, LIN Chuan-hsuan^d

^a Department of Interior Design, Tungfang Design Institute, Taiwan, elenick37@hotmail.com

^b Department of Architecture, National Cheng Kung University, Taiwan, ethan6889@gmail.com

^c Department of Architecture, National Cheng Kung University, Taiwan, tsayys@mail.ncku.edu.tw

^d Department of Architecture, National Cheng Kung University, Taiwan, visdr207@gmail.com

ABSTRACT

This study plans to review and evaluate the interior design strategies corresponding to indoor light, and heat by introducing Green BIM tool into the indoor space planning and design stage, and takes an office space in Tainan as the practical operation object of interior design. According to the user requirement, with the assistance of Green BIM tool, the optimum design proposal meeting the Eco-Efficiency concept is proposed. The evaluation and analytical items involved in the Green BIM proposed in this study will be determined according to actual requirement, including heat insolation, and illumination analysis. Autodesk Revit was used as the main software tool to discuss how the Green BIM tool assists green design strategy in the present practical application of interior design for finding out optimum design program.

Keywords: green BIM, interior design, optimum design

1. INTRODUCTION

1.1 Background and motivation

The information society is a common adjective of a modern society, mainly due to the rapid development and progress of **“Information Communication Technology (ICT)”**, as well as for people's desire of receiving information. In terms of the construction industry, it can enhance productivity.

More specialization at each stage of the construction industry should be able to improve the quality and efficiency, but if the integration is neglected, the low productivity would be caused. This is one of the main reasons that the **development and application of “Building Information Model (BIM)” in the construction of the industry has become one of the most popular issues in the global engineering and academia.** In addition, BIM software has been also **widely used in “Project Delivery Integrated (IPD)”**, a popular architectural project delivery model in recent years.

Green BIM stresses that **due to local climatic conditions to analyze “Building Performance Analysis (BPA)” from the beginning of the design with BIM as the basic tool, and through the “design” and “assessment” of the decision cycle to result in the “Optimum Design” program for environmental benefits.** The selected program via BPA will **affect building performance in the whole building life cycle, and the ultimate goal is lifting the overall “Eco-Efficiency (EE)”**, lowering the environmental loads and costs, so that to improve environmental quality.

After the completion of a new building, roughly determine the environmental performance of the overall construction, but it still has a gap with which of the use stage. Therefore, whether the environmental performance can be remained or better after finish interior design and decoration needs to check.

1.2 Purpose

In this study, the indoor light environment and thermal environment were reviewed and evaluated by using the Green BIM tool at the beginning of the interior design. An office space in Tainan City was taken as the research object, and the analysis results of the light and thermal environment will be used as reference for interior design and decoration in the future. In addition, to ensure that the interior decoration to take into account the environmental quality and energy saving.

2. OBJECTIVES, METHODOLOGY AND PROGRESS

2.1 Objectives

The object of this study is a narrow type of office space, which the area is about 125 m³, in the 12th floor (top floor) of the mixed residential and commercial building on Dongmen road of Tainan City. The office space has a special sloping roof of about 7 meters high occupies a half of the space and near the south windows which are the closed-type of glass curtains (shown as in Figure 1). However, four roof openings have a chance to carry out thermal buoyancy ventilation. Because the office located in the top floor, the roof affected by the solar radiation is serious, how to isolate the radiation is need to be considered more when proceeding interior design and decoration. The plan and section of the office space are shown as in Figure 2.

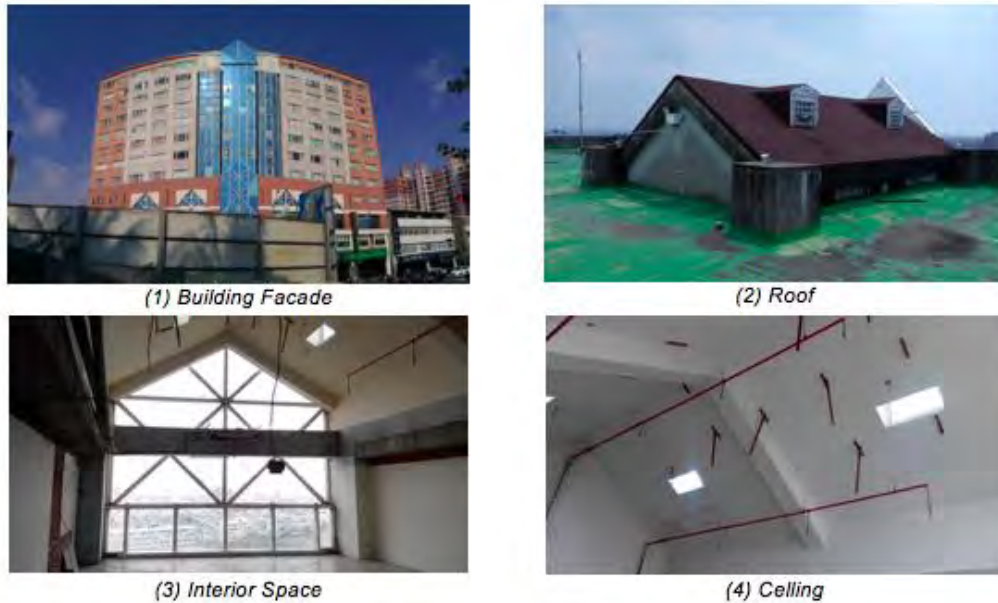

Figure 1: Photos of the research object



Figure 2: The plan and section of the research object

2.2 Methodology and progress

Most of the researches about Green BIM for design decisions of green building were utilized the analysis software of Autodesk Inc to carry out related issues. In terms of building types, there are residential space, school space, office space, transportation space, library space, etc. This research takes the case study method, which is to investigate and analyze a specific object in the research object group, and to clarify its characteristics and its formation process. The software used in the study is mainly for “Autodesk Revit (2016 Edition)”. Via the settings of the current situation include meteorological information, drawing information, 3D model establishment and parameter setting, etc., the performance analysis of indoor light and thermal environment in the office space were conducted, and then in accordance with the results of the virtual performance analysis, the current environmental problems and performance of the office space also were clarified. The results of the study will be reference for the following decision of interior design and decoration.

In this study, the use of BPA in Autodesk Revit carried out, and it mainly includes solar load analysis (insolation) and lighting analysis (illumination). The date for analyzing first was set October 7 (fall), and its sunrise and sunset

times are 5:53 am and 5:41 pm, a total of about 9.8 hours. The analysis of illumination was only aimed at the lighting environment under natural lighting. In the study, the time of analyzing illumination is respectively set at 7:00 am, 12:00 noon and 5:00 pm to compare the differences.

3. RESULTS

3.1. Analysis of thermal environment

The distributions of insolation from the external and internal surfaces of the office space respectively are shown in Figure 3 and Figure 4. As shown in Figure 3, the cumulative amount of insolation is up to 6069 Wh/m², in particular on the roof. In Figure 4 (1) - (3), the cumulative value, average value and peak value of insolation are presented respectively. From the results, the higher insolation area (yellow and green areas) is mainly concentrated in the south side of the windows within the range of about 1/5 room depth (about 3.5m). As shown in Figure 4 (3), when the sun is the largest, the range of the higher insolation will be up to about room 1/4 depth (about 4.2m). Therefore, in the future, in addition to the design considerations of shading and heat insulation, the heat removal in this area should be strengthened.

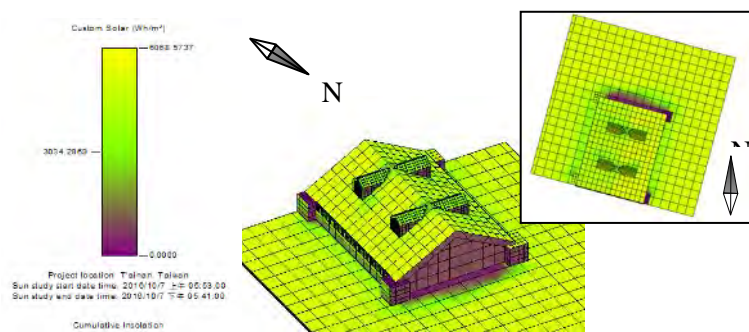

Figure 3: Distribution of cumulative insolation on the roof

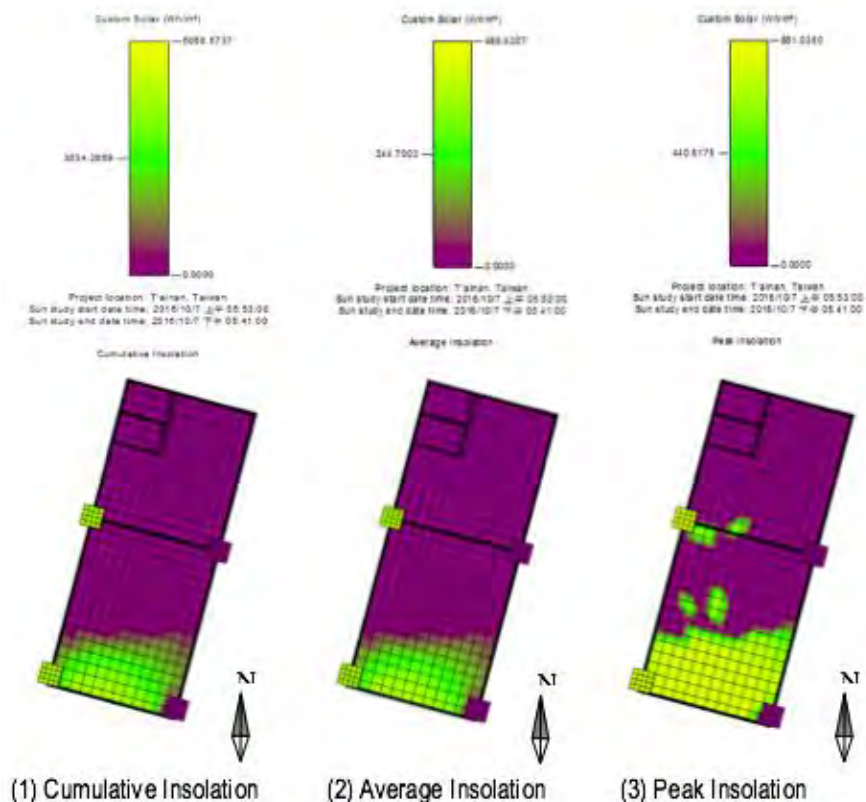

Figure 4: Distribution of Insolation on the plan

3.2. Analysis of light environment

Indoor illumination distribution of office space is as shown in Figure 5. If the 500Lux above the office lighting requirements for the standard, at 7:00 am, the south side of the windows extend inward about 1/4 room depth (about 4.2m) can rely on natural lighting, to noon can be more than half, at 5:00 pm, only the local area near the windows can reach this standard. More details about distributions of illumination in the office space are shown in Figure 6 - 8.

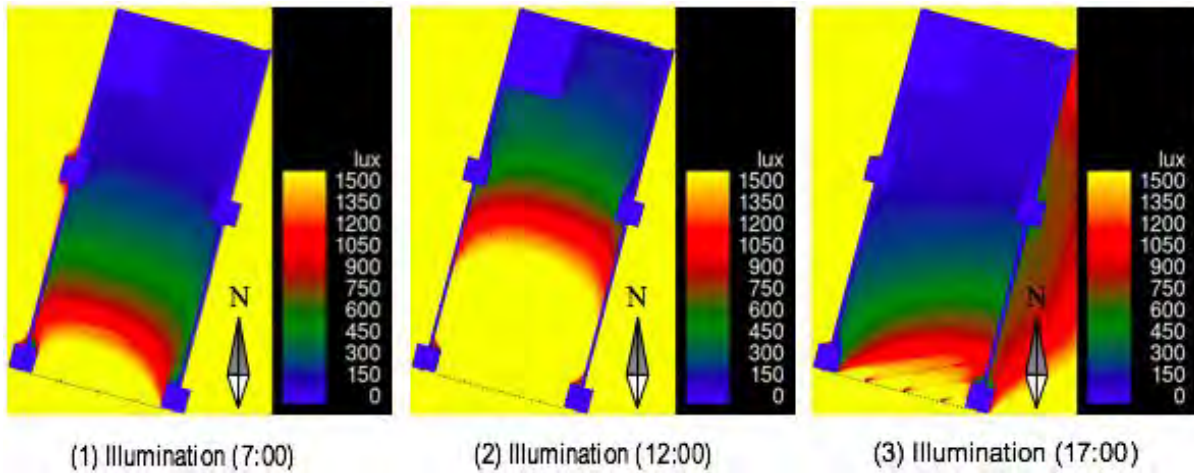

Figure 5: Distribution of illumination on the plan

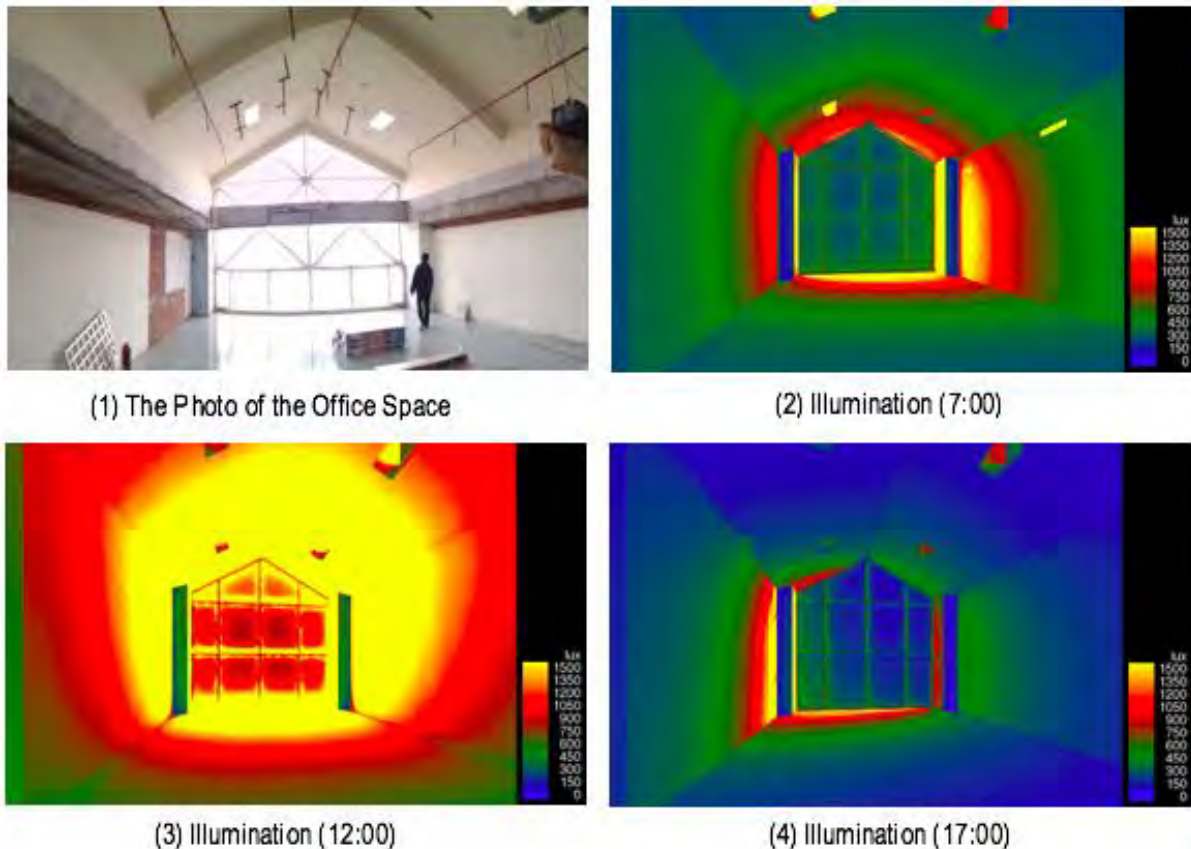

Figure 6: Distribution of illumination in the office space near windows

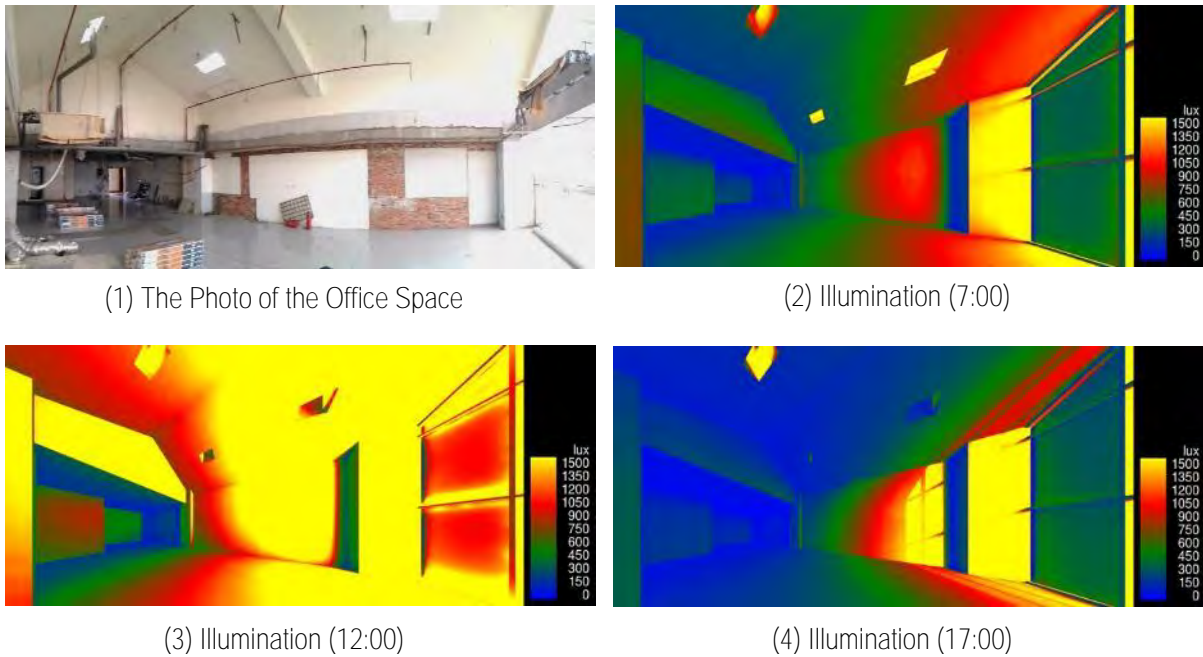

Figure 7: Distribution of illumination in the central of office space

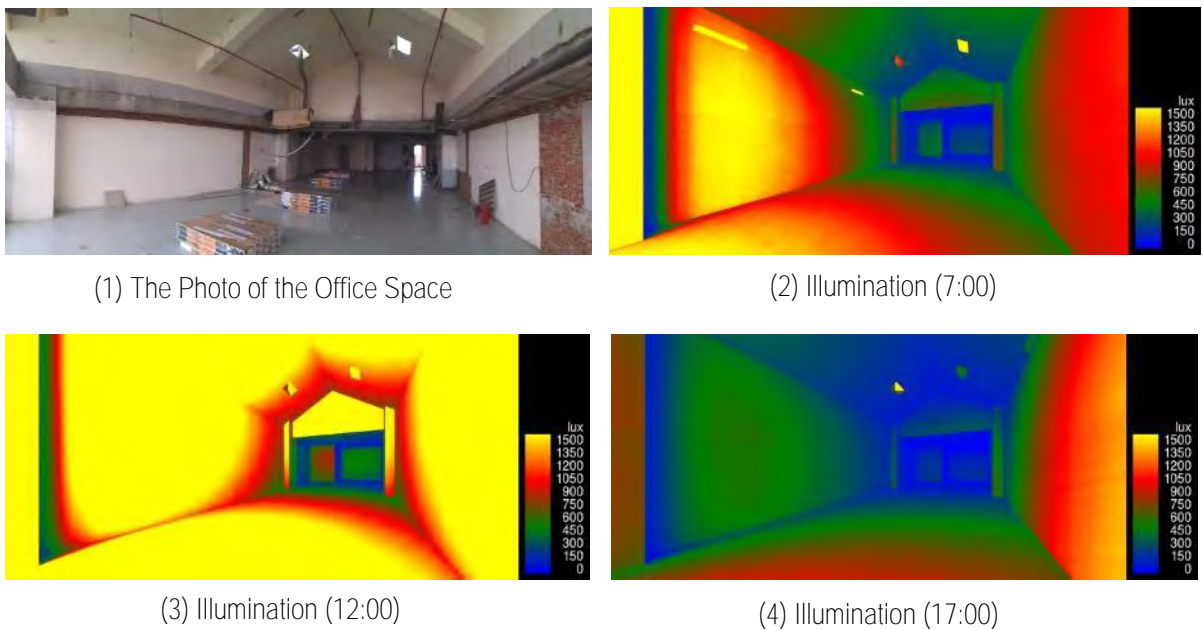

Figure 8: Distribution of illumination in the office space near the door

4. CONCLUSION AND RECOMMENDATION

In this study, the Green BIM tool was conducted for BPA before interior design and decoration. BPA spent time limited, so that it did not affect the progress of the design. In addition, it can help design decisions and improve environmental performance. The results show that the area, within about 1/4 room depth, near the south side of the windows, should be paid attention to the heat removal. The buoyancy ventilation strategy can be considered, but also strengthening sunshade and heat insulation in the area near the south windows should be necessary. In terms of Light environment, artificial lighting is needed for areas outside the region near the windows to supplement

the indoor illumination. Lamp circuit configuration with parallel window surface also can be utilized for saving energy by switch control.

This study also can be aimed at different seasons for BPA, or other factors, for example: acoustic environment, airflow environment, etc., so that interior design decisions can be based on BPA to obtain the most optimum program.

REFERENCES

- [1] Chen, S.Y., and Chiu, H.T. 2014. Green BIM. Retrieved from: <http://www.ils.org.tw>
- [2] Lai, L.C. 2011. BIM Thermal Simulation and Analysis for Open Building - MEGA House Case Study. Thesis (M.D.). Taiwan University of science and technology.
- [3] Lien, C.C. 2012. Electric Consumption Analysis of Governmental Building Using the Ecotect Software. Thesis (M.D.). Taipei University of Technology.
- [4] Lin, Y.C., and Liu, T.C. 2010. Discussion on analysis and research of green thermal effectiveness of a elementary school building with computer simulation - A case study of Chin-Te Elementary in Taichung City. Horticulture NCHU, 35(1), 111-122.
- [5] Liu, K.S. Chiang, C.M., Chen N.T., Lin, W.C. 2010. A Study on the Module of Built Environment Efficiency (BEE) Adapted Life Cycle Cost (LCC) for Existing Buildings in Taiwan - Taking the Factors of Indoor Health as an Example. Journal of Architecture, (73), 125-141.
- [6] Teng, T.F., Chen, C.W., Lin, K.L., and Chien, N.Y. 2012. The Application of BIM to Energy Efficient Design —A Case Study of Taipei MRT Wanda Line Station LG05. MRT technology Biquarterly, (47), 47-54.
- [7] Wu, Y.H. 2014. The Study on PV Panels and Indoor Illuminance Level Optimizing by BIM Platform – Taking Beitou Library as an Example. Thesis (M.D.). Taipei University of Technology.

Study on the Energy Efficiency of the Climatic Based Passive Design by Meinong Tobacco Barns in Kaohsiung

LI Yen-yi^a, CHUNG Po-ren^b, LIN Hisn-I^c, TZENG Ping-chieh^d

^a ShuTe University / TSSBE (iSBE-Taiwan), Taiwan, hamaLee@gmail.com

^b Graduate School of Architecture, National ChengKung University, Taiwan, benjamin6686@gmail.com

^c ShuTe University / TSSBE (iSBE-Taiwan), Taiwan, sabrina85722@gmail.com

^d Bureau of Public Works, Kaohsiung City Government, Taiwan, pctzeng@kcg.gov.tw

ABSTRACT

There were lots of local buildings in rural area in Taiwan, which were over 40 years but still can afford the daily livings. These cultural and typical types of buildings in some cultural small town represent for the unique building styles, and to arise the issue for the revival of the cultural building for more sustainable attitude. This study is based on the requirement of this topic and following the policy of Kaohsiung City Government to renovate a traditional Tobacco Barns into more sustainable Kaohsiung LOHAS House.

The Tobacco Barns is a traditional house which combines the local industry of tobacco drying and a house living space, and this type of building is very popular and unique in Meinong district in Kaohsiung. This study conducted the processes from local climate data analysis, which is based on the local elementary school. The energy issue is the main target to verify the new possibility of the decisions to deal with the material and openings from eight orientations. The AutoDesk-Ecotect analysis was adopted to make the integrated analysis processes which will be in the same model and analysis methodology. The factors including heat load of transfer, indoor predicted temperature and daylighting situation were considered to make the comparison of the energy efficiency by the local common renovated material and opening styles. The suggestions were conducted by the methodology and for the further comparison of different design proposal with results of maintenance evaluation and energy saving fee to let the house owner do the decision making.

In this study, through the collection of relevant literature, data integration and analysis, the results showed the cross analysis with four material of wood, rammed earth wall, concrete and bricks structure, with different opening rate is 20%, 50%, 80%, and with horizontal shading monolayer bilayer depth by 0, 0.4, 0.6, 1.0, 1.8 ratio. The simulations of thermal environment and light environment were both verified to make the calculation of the estimated efficiency. The results can be used and references in this area for who wants to make the renovation.

Keywords: opening rate, shading form, shade depth ratio, EUI energy dissipation value

1. INTRODUCTION

For urban and rural renewal, old buildings can be revitalized through renovation. But when re-planning and redesigning buildings, reinforcing appearance-related structures, improving indoor spatial functions and outdoor landscape arrangement, we need to pay attention to evaluations and analyses of rebuilding costs and energy efficiency when examining whether the rebuilding process meets the concept of sustainable construction. The purpose of this study, thus, is to investigate the energy consumption efficiency of rebuilding and regeneration and material use strategy; the research subject case study is a tobacco building in the Meinong area. By contrasting the formation of traditional settlement type of tobacco building, the research scope is expanded to the whole area and region. The regeneration movement of the tobacco building has been examined for the purpose of conducting an architecture design study.

2. RESEARCH METHOD

Architecture theory is developed herein from the design of manual modules via a computer simulation analysis based on the comparison of heat transfer of various materials in the thermal environment, as well as the consideration of the indoor window opening conditions and the exterior architecture structure. The relationship between these factors is quite complicated. Thus, due to the limitations of conditional factors, previous studies have been taken into consideration to classify simulation factors for later analyses of the key ones. This section first explains the simulation case, the structure of simulation process, limitations and conditions.

2.1 Establishment of simulation case

In principle, the site of architecture simulation was selected in Meinong, Kaohsiung City at latitude and longitude of $\lambda=190^{\circ}54'$ and $\varphi=22^{\circ}90'$, respectively, and sea level of 543 meters (Figure 1) for this study. The architecture type is a four-ping tobacco leaf baking room located at the north orientation with an 85° angle of incidence; thus, the main chickened structure of the tobacco building is used as the basis for the main simulation test. Values in different orientations are then simulated for the purpose of comparison.



Figure 1: Site map/ aerial image

2.2 Analysis method

For the analysis of the experimental simulation, 132 sets of architecture types were set up; the simulation conditions were established by using the main structure of the tobacco building as the center. Different amounts of sunlight were acquired according to the different orientations of architecture. This study uses eight orientations: north (N), northeast (NE), east (E), southeast (SE), south (S), southwest (SW) and northwest (NW) for the simulation. The values acquired in the simulation include: the thermal environment of architecture materials, window opening ratio, shield format and shield depth. Through statistical analysis, the relationships among four different types of construction materials have been defined, as well as the changes in the thermal environment have been analyzed by using combinations of shield types (Figure 2).

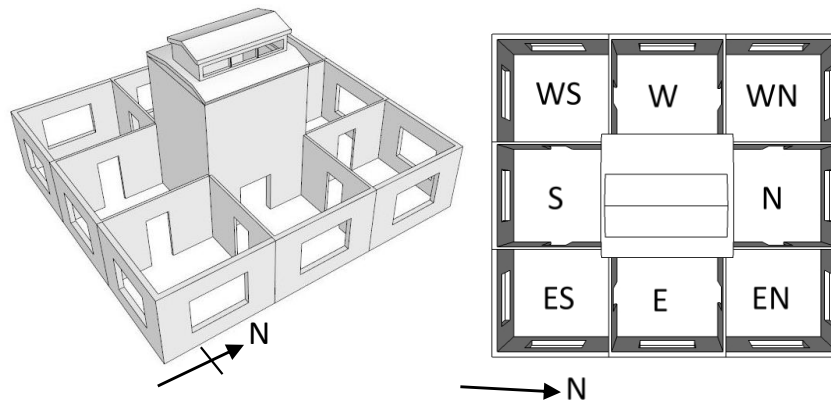

Figure 2: Orientations of architecture in the simulation

2.3 Integrated evaluation and analysis method

This study focuses on the discussion of energy consumption in different spatial orientations; ECOTECT, a computer simulation, is adopted for the presentation. Unlike the single consideration of construction materials or window opening ratio, this study concerns the close relationships among architecture orientation, building envelope and energy consumption. For example, natural lighting, shield and depth are impacted by the changing conditions. Therefore, they all play an important role in energy-saving. We discuss the design application of architectural space via analysis of the amount of sunlight reflection, the thermal environment of various spatial orientations, window opening ratio, the use of responsive materials, and EUI (energy use intensity). Suggestions for improvement are also proposed according to the simulation results and analyses of the design of the architecture rebuilding.

3. INTEGRATED COMPARISON AND ENERGY CONSUMPTION SIMULATION ANALYSIS

Via computer simulation, this study analyzes influential factors of architectural space, including the relationships among suitable construction materials, window opening ratio, shield format, depth ratio, amount of sunlight and thermal environment. The simulation of eight orientations helps us to ascertain the relationship between orientations and thermal environment, and to analyze the impact on the annual EUI of an indoor air conditioning system.

3.1 Total EUI comparison with an opening ratio of 20%

The results below are found after comparing and analyzing EUI in different orientations. (Table 1)

This study uses a fixed width and length ratio of window opening to discuss EUI in different orientations, and finds that EUI is reduced with the increased depth and that the decrease ratio is also reduced along with the increase of depth ratio. Wooden and rammed earth structures as construction materials are proven to provide the best energy saving effectiveness since these two have window opening ratios falling within the range of low energy consumption; concrete structures, due to higher heat capacity and difficulty of heat dissipation, have EUI of air conditioning systems within the middle range of energy consumption; and some spaces of bricked structure also reach the middle energy consumption range due to spatial orientations. (Figure 3)

Construction Materials/Shield Format		EUI %		
		Low	Middle	High
Wooden	Single Layer	100	--	--
	Double Layers	100	--	--
Rammed Earth	Single Layer	100	--	--
	Double Layers	100	--	--
Concrete	Single Layer	25.5	75.5	--
	Double Layers	25.5	75.5	--
Bricked	Single Layer	66.7	33.3	--
	Double Layers	62.5	37.5	--

Table 1: EUI comparison of an opening ratio of 20%

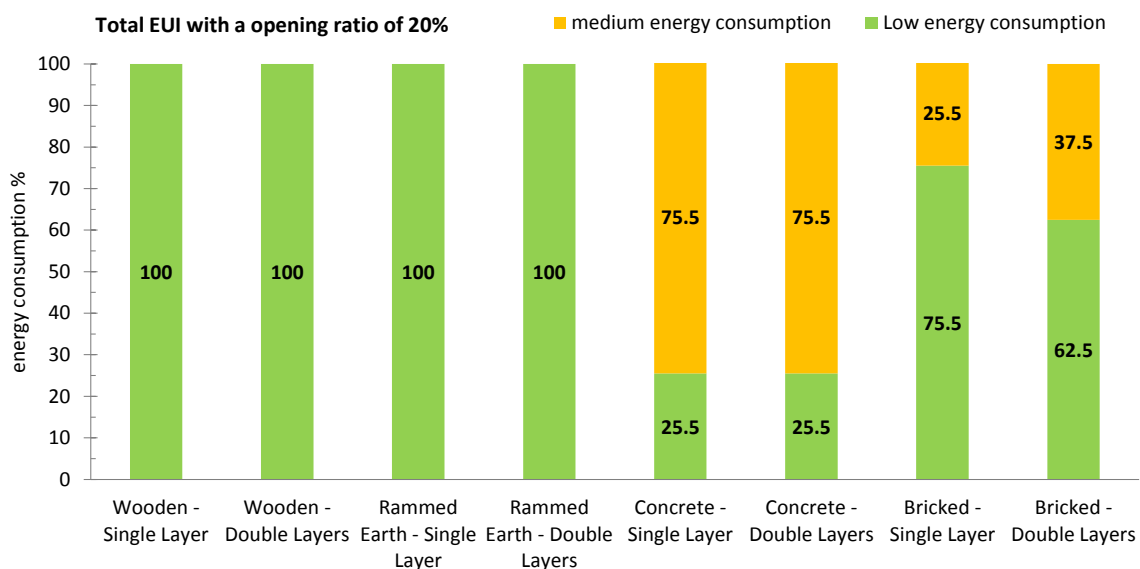

Figure 3: Total EUI comparison with an opening ratio of 20%

3.2 Comparison of total EUI with an opening ratio of 50%

The results below were garnered after comparing and analyzing EUI in different orientations. (Table 2)

From Table 2, the EUI diagram at a window opening ratio of 50%, the structure with 50% more concrete belongs to the range of high energy consumption. Both single and double layered vertical shield structures have no impact on energy consumption. Wooden structures have the optimal EUI with significant impact of reduced EUI after the installation of double layered horizontal shield structure; rammed earth structures fall within the range of middle energy consumption with the same effectiveness after the installation of double layered horizontal shield structure; and bricked structural space falls within all ranges of energy consumption, from low to high. Therefore, other combined bamboo structures shall be considered for orientation selection to achieve the balance of spatial use and dynamic energy of an air conditioning system, as well as to form composite-structured architecture. (Figure 4)

Construction Materials/Shield Format		EUI %		
		Low	Middle	High
Wooden	Single Layer	62.5	37.5	--
	Double Layers	50	50	--
Rammed Earth	Single Layer	20.8	79.2	--
	Double Layers	22.9	77.1	--
Concrete	Single Layer	--	39.6	60.4
	Double Layers	--	41.7	58.3
Bricked	Single Layer	12.5	81.25	6.25
	Double Layers	12.5	83.4	4.1

Table 2: EUI comparison of an opening ratio of 20%

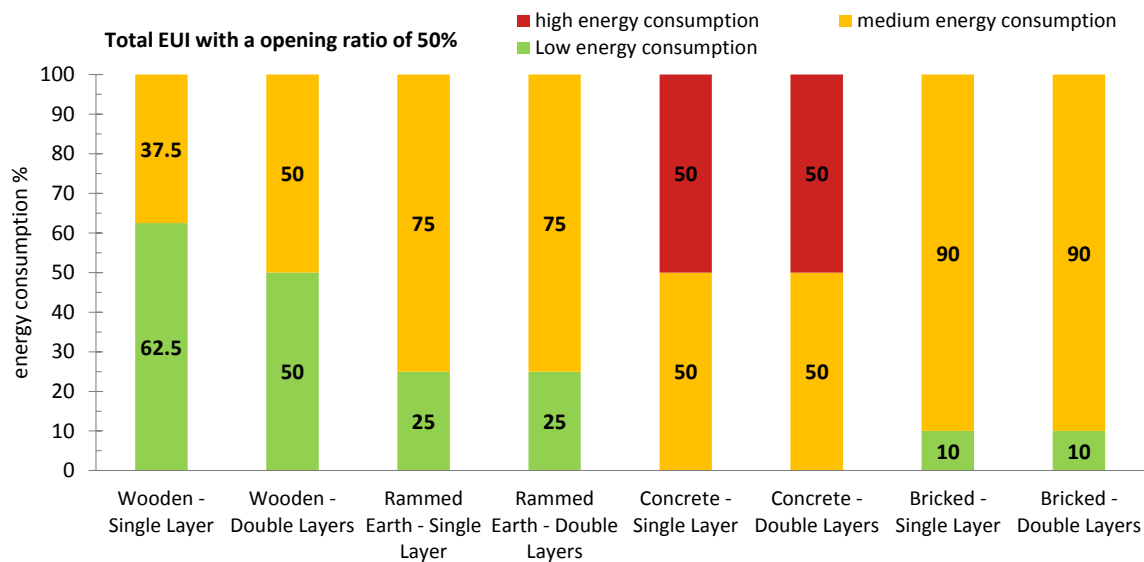

Figure 4: Total EUI comparison with an opening ratio of 50%

3.3 Total EUI comparison with an opening ratio of 80%

The results below were found after comparing and analyzing EUI in different orientations. (Table 3)

As shown in Table 3, with the EUI diagram at a window opening ratio of 80%, due to large window openings, structures with various construction materials exhibit high EUI to reach a high energy consumption range. Wooden structures, due to small heat capacity, maintain low energy consumption in some spaces, while rammed earth and wooden structures have the same coefficient of energy consumption ratio. Because of the slow speed of heat dissipation, concrete structures normally have higher EUI, with 75% falling within the range of high energy consumption. Although bricked structures have higher heat capability, they easily dissipate heat. Hence, EUI coefficient is relatively constant with the only impact of single window opening and double window openings being at the energy consumption ratio of 1:1. The design of large window opening with a ratio of 80% is shown in a bar diagram; even when a double-layered shield panel is installed on the exterior window opening, the energy consumption coefficient still remains constant. That proves that even with the use of large window aperture in architectural space, there is no need to use the design of double layered shield panels (Figure 5).

Construction Materials/Shield Format		EUI %		
		Low	Middle	High
Wooden	Single Layer	10.4	37.5	52.1
	Double Layers	10.4	37.5	52.1
Rammed Earth	Single Layer	10.4	37.5	52.1
	Double Layers	10.4	37.5	52.1
Concrete	Single Layer	--	25	75
	Double Layers	--	25	75
Bricked	Single Layer	--	50	50
	Double Layers	--	50	50

Table 3: EUI comparison of a window opening ratio of 80%

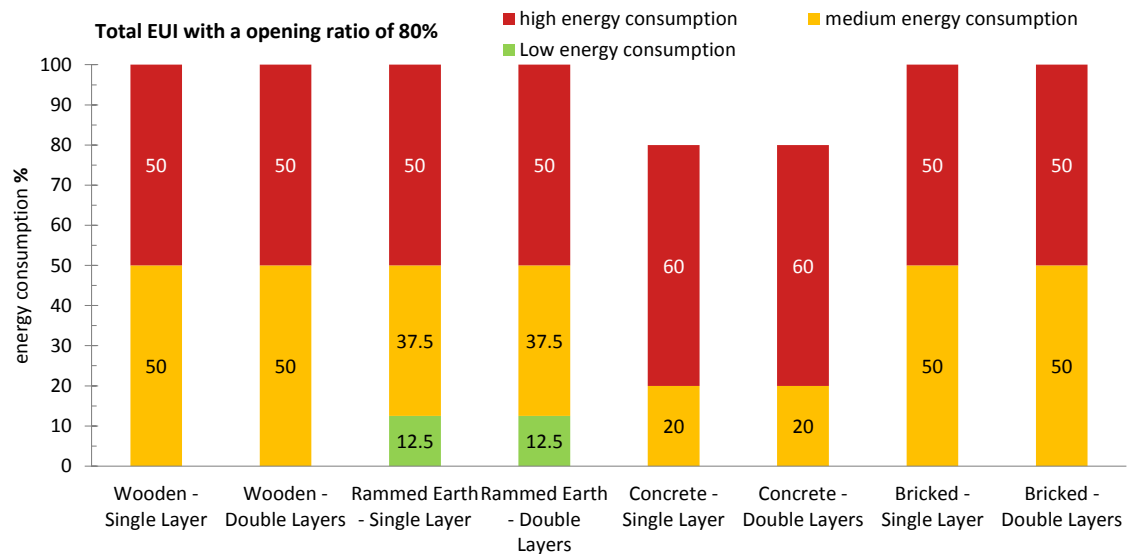

Figure 5: Total EUI comparison with an opening ratio of 80%

4. CONCLUSION

This study, after experimental simulation and analysis, examines the relationship of annual EUI of indoor spaces in different orientations corresponding to the motives and purposes of this study. Concrete conclusions and suggestions below are acquired for the reference of future studies on energy conservation of buildings.

The wooden spatial structure with a window opening ratio of 20% consumes less energy than the basis value of 30 kWh/m².yr while at an opening ratio of 50%, energy consumption variance is determined by single or double openings. At a ratio of 80%, the increase of EUI also falls within the range of basis value and only Space N maintains lower energy consumption than the basis value.

The wooden and rammed earth structures at an opening rate of 20% consume lower than 30 kWh/m².yr, and at a ratio of 50%, the EUI still falls within the basis range, while space in the N orientation has EUI lower than the basis value, indicating the significant variance of EUI due to the angle relationship in different orientations. At a ratio of 80%, EUI values in the ES and WS orientations both exceed the basis range. As a result, for spaces with double window openings, sunlight and west orientation should be considered in terms of design.

The concrete spatial structure at an opening ratio of 20% has EUI within the basis range, but at a ratio of 50%, the ES and WS orientations have EUI exceeding the basis range due to sunlight exposure and west orientation. At a ratio of 80%, a double-opening design significantly exceeds the basis value of 30 kWh/m².yr. This indicates the impact of opening design of space on the EUI of an air conditioning system.

The bricked structure is found to exhibit a significant level of change for the EUI of an air conditioning system. At an opening ratio of 20%, single and double designs of opening have relative impacts on EUI; at a ratio of 50%, the

EUI is found to fall within the basis range, and only the N orientation falls below the range of 30 kWh/m².yr. At a ratio of 80%, due to large window opening, single or double openings become an important factor related to EUI.

REFERENCES

- [1] A.J. Marszal, J.S. Bourrelle, E. Musall, P. Heiselberg, A. Gustavsen, K. Voss, Net Zero Energy Buildings – Calculation Methodologies versus National Building Codes, EuroSun Conference, Graz, Austria, 2010.
- [2] W. Miller, L. Buys, Anatomy of a sub-tropical Positive Energy Home (PEH), Solar Energy doi:10.1016/j.solener.2011.09.028,2011.
- [3] P. Hernandez, P. Kenny, From net energy to zero energy buildings: defining life cycle zero energy buildings (LC-ZEB) Energy and Buildings 42 (6), pp.815–821,2010.
- [4] W. Gilijamse, Zero-energy houses in the Netherlands, in: **Building Simulation '95, Madison, Wisconsin, USA, 1995.**
- [5] R. Hyde, Climate Responsive Design, New York,2000.
- [6] T.V. Esbensen, V. Korsgaard, Dimensioning of the solar heating system in the zero energy house in Denmark, Solar Energy 19 (2), pp.195–199,1977.

Sustainable Midfield Concourse Development at Hong Kong International Airport

Kevin POOLE^a

^a Airport Authority Hong Kong, Hong Kong SAR, kevin.poole@hkaairport.com

ABSTRACT

Buildings in Hong Kong account for **about 90% of our electricity consumption and 60% of Hong Kong's greenhouse gas emissions**. Using energy more efficiently would help reduce greenhouse gas emissions. Through incorporating sustainable design features, new green buildings have an opportunity to significantly reduce energy demand, while delivering comfortable, healthy internal environments. Situated to the west of Terminal 1 and between the two runways, the newly commissioned Midfield Concourse (MFC) is a major project recently delivered at Hong Kong International Airport (HKIA). The five-level concourse has a total floor area of 105,000m² and is connected to Terminal 1 by an extension of the automated people mover (APM) system. There are 20 new aircraft parking positions that help increase the passenger handling capacity by over 10 million passengers per year. Focusing on the MFC project as a case study, this paper describes how the early consideration of sustainable design principles and a systematic evaluation and prioritisation of the possible combination of passive design strategies and low-energy active design techniques can help take forward innovative ideas and sustainable design initiatives through the different stages of a project in delivering an energy efficient high-performance building. **The MFC serves as testament confirming HKIA's commitment to being a green airport. Adopting a similar green design strategy for the planned Expansion of HKIA into a Three-Runway System will bring similar sustainability benefits for HKIA and Hong Kong.**

Keywords: energy use, sustainable design, innovative ideas

1. INTRODUCTION

1.1 Background

Buildings account for about 40% of energy use worldwide (Zuo and Zhao, 2014; WBCSD, 2009). In Hong Kong, the main energy used in buildings is electricity and these buildings are responsible for about 90% of our electricity **consumption and 60% of Hong Kong's greenhouse gas (GHG) emissions (Environment Bureau, 2016)**. Energy saving and green building transformation has a great potential in contributing to Hong Kong's **GHG emissions reduction target**.

While significant energy savings can be achieved in existing buildings by behaviour changes of occupants, new green buildings can contribute by significantly reducing energy demand in the first place by incorporating sustainable design features, while delivering comfortable, healthy internal environments. However, sustainable building design is a complicated process that involves a large number of design variables, each with a range of feasible values (Wu et al., 2016). Besides, planning and construction of new buildings are often carried out under tight programmes, requiring rapid information turnaround amongst the relevant design team members and quick decision-making. A good decision-making framework and relevant design tools are required by building designers for a systematic evaluation and prioritisation of the possible sustainable design initiatives, including options for incorporation into the design, while taking into account the fundamental factors of investment cost, maintenance and operational requirements in building construction.

1.2 Objectives

Sustainable design initiatives may be categorised into different aspects such as energy use, water use, indoor environmental quality, material and site aspects. The energy use of buildings would be most relevant with respect to achieving GHG emissions reduction. Focusing on the newly commissioned Midfield Concourse (MFC) at Hong Kong International Airport (HKIA) as a case study, this paper discusses the energy use aspect and describes how the early consideration of sustainable design principles and a systematic evaluation and prioritisation of the possible combination of passive design strategies and low-energy active design techniques can help take forward

innovative ideas and sustainable design initiatives through the different stages of a project in delivering an energy efficient high-performance building.

It is hoped that the experience gained from the MFC project as illustrated in this paper may help promote a better understanding of the green building design process and encourage more widespread implementation and development of high-performance buildings.

2. MIDFIELD CONCOURSE AS CASE STUDY

Situated to the west of Terminal 1 and between the two runways, the MFC is a major project delivered at HKIA. The 105,000m², five-storey MFC commenced construction in December 2011 and began operation since December 2015. The construction period included extension of the automated people mover (APM) system from the existing Terminal 1. To enhance the airport operations, there are 20 new aircraft parking positions provided at MFC, increasing the passenger handling capacity by over 10 million passengers per year.

2.1 Green airport design strategy

The MFC has been designed as an exemplar sustainable building that contributes to HKIA's pledge to be one of the world's greenest airports. The MFC project team understands that the early building design phases play a crucial role in determining life cycle performance in terms of resources and energy consumption. At the project design stage, the optimisation potential is still large at relatively low cost. In the latter planning and construction phases, the change possibility rapidly decreases, with simultaneously increasing costs (Kovacic and Zoller, 2015).

Various sustainable design initiatives including innovative ideas and green design options were therefore evaluated early in the initial scheme design stage through the development of a project-specific **"Green Airport Design Strategy"**. **The Strategy was prepared in order to identify opportunities for incorporating elements in the design that would enhance environmental efficiency and minimise the project's impact on the environment over its whole life cycle.** The Strategy put emphasis on three key pillars of green building design, namely the inclusion of reduced resource use, the maximisation of operational efficiency, and the enhancement of health and wellbeing for the building occupants as illustrated in Figure 1.

2.2 MFC green design process

Figure 2 illustrates the systematic approach adopted in deriving the consideration of green design initiatives in the MFC project.

Researchers have emphasised the importance of setting sustainable target values early in order to drive the green design process forward (Russell-Smith et al., 2015). However, a challenge that often arose was how best to set the sustainable design targets. In the MFC project, this was achieved via undertaking relevant benchmarking studies early, reviewing existing green design practices at HKIA and overseas airports to provide a comparison between relevant data sets. Through the use of passive and active design measures, the design team targeted to reduce CO₂ emissions or annual energy consumption by at least 20% over the baseline situation that was established based on the Performance-based Building Energy Code (EMSD, 2007).

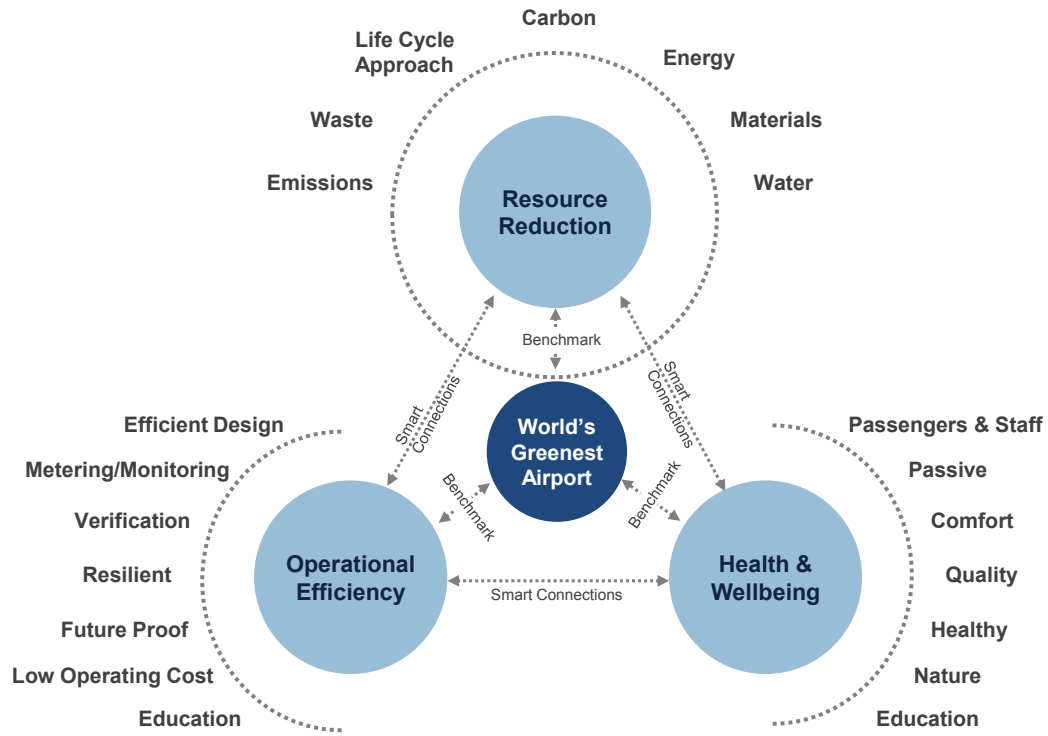

Figure 1: Pillars of green buildings emphasised in MFC design

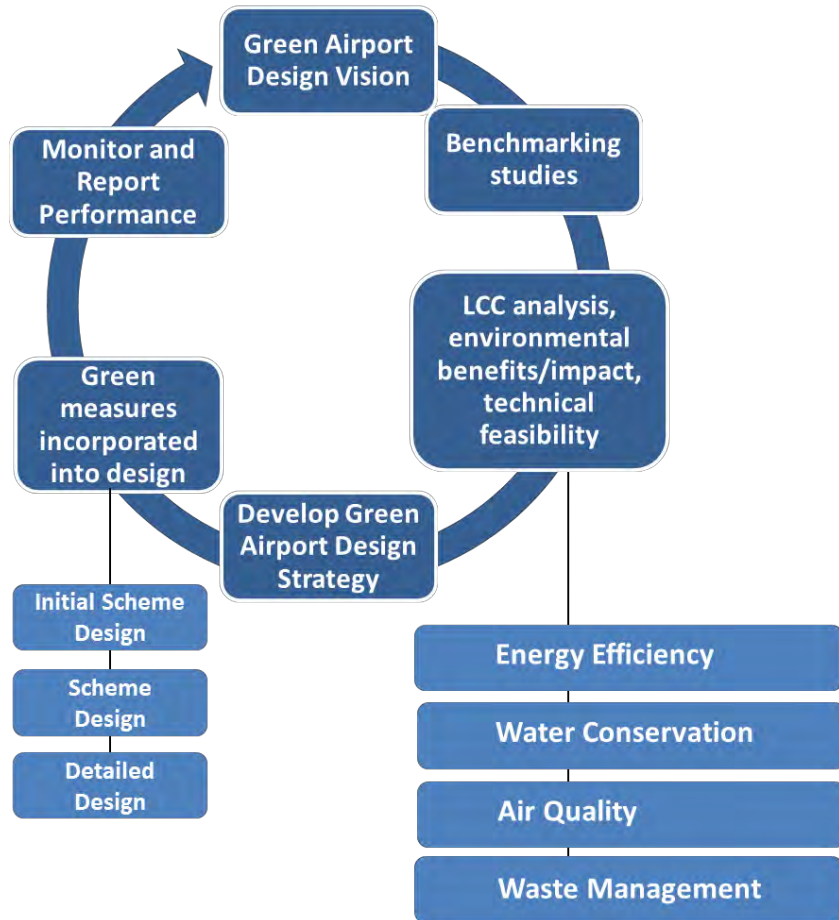

Figure 2: MFC green design process

2.3 Life cycle cost analysis

Researchers have pointed out that an integrated planning process that considers life cycle costs (LCC) and optimisation can significantly reduce the follow-on costs in the design and construction process (Kovacic and Zoller, 2015). The LCC and benefit methodologies currently used in the building and construction industry are mostly implemented for economic evaluation of specific, mostly technological aspects. Although the LCC methodology is well developed and standardized, it is still facing numerous difficulties in practice. Lack of reliable data and data accessibility are some of the most common problems. To overcome these obstacles, the combined approach of considering both LCC and life cycle assessment is advocated by some researchers (Kovacic and Zoller, 2015).

In the MFC project, the team considered, where possible, the 25 year LCC and also considered the environmental benefits and impact of the green design initiatives as advocated by researchers. The LCC analysis was found particularly useful in facilitating a systematic evaluation of the options for passive and active energy design in the MFC project. For example, the 25 year LCC for alternative roof light design options, including (i) conventional skylights (Baseline option); (ii) conventional skylights with light diffusing system; (iii) conventional skylights with light shelf; (iv) conventional skylights with automated solar shading; and (v) north-facing skylights were compared and the results revealed north-facing skylights to be the preferred primary option having the lowest 25 years LCC, while not requiring maintenance beyond that of normal skylights. There are also additional benefits in that the design of the north-facing skylights could be integrated with the requirement for smoke ventilators, and also photovoltaic cells inclined to capture the optimum sunlight for power generation. Figure 3 illustrates the design of the north-facing skylights.



Figure 3: Design of north-facing skylights located on roof along the true east west axis of MFC

3. PASSIVE AND ACTIVE DESIGN STRATEGIES

There are two basic design paradigms of strategies and technologies applied to buildings - passive design and active design (Balaban and Oliveira, 2016). In passive design, natural elements such as air flow and sunlight are used to provide a comfortable indoor environment while reducing energy demand for mechanical and electrical systems such as air conditioning and artificial lighting. On the other hand, active design is the use of state-of-the-art systems and newer technology to improve energy efficiency.

This section presents further details regarding the design process undertaken in evaluating and prioritising the possible combination of passive design strategies and low-energy active design techniques.

3.1. Passive design methodology

Passive design techniques were adopted and have embedded energy use reductions into the MFC design from the outset. The MFC focussed primarily on the use of natural daylight, both to reduce energy consumption associated with artificial lighting and to improve the internal environment, allowing passengers and staff views and connections to the outside environment.

3.1.1 Reducing artificial lighting demands

Energy modelling undertaken at the initial scheme design stage indicated that lighting energy could account for almost 30% of energy consumption in the baseline situation. The design of a good natural daylight system will optimise the amount of daylight entering the space, decreasing energy bills and increasing occupant connectivity with the outdoors.

The MFC was designed to be oriented along the north-south axis, providing two long façades through which daylight is introduced through vertical glazing. Due to lower annual solar heat gains on east façades in Hong Kong, it was found possible to increase the glazed area on the east elevation in order to admit more daylight, at a relatively low solar heat gain penalty. Hence, the east facade features taller glazing to maximise daylight and views whereas the west façade glazing has been reduced in height and provided with external shading devices (see Figure 4). Performance is further enhanced by incorporating the afore-mentioned skylights on the roof by orientating them to face true north. The skylights block the majority of direct sunlight from the south but allow diffused light to enter from the north. These strategies work in parallel with intelligent daylight and occupancy controls to optimize performance.

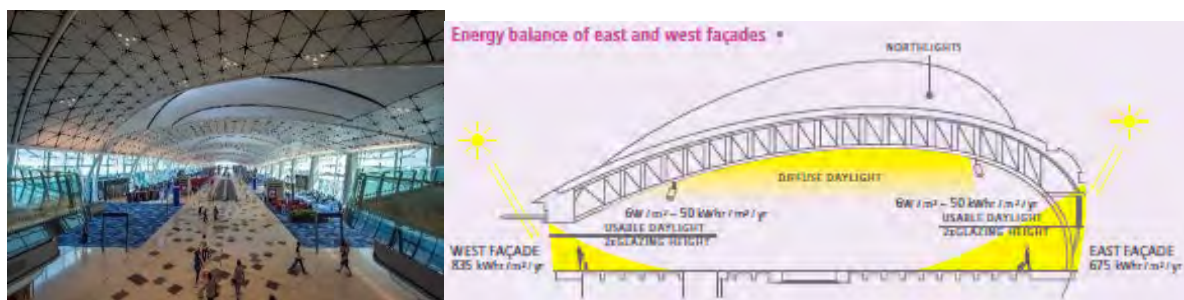

Figure 4: Energy balances of east and west façades at MFC

3.1.2 Reducing solar heat gain

In addition to adopting an optimised façade design, a shading hierarchy was followed to reduce solar heat gain and these involved the following steps:

- Step 1 - Reducing window to wall ratio: ASHRAE Standard 90.1 recommends a maximum window to wall ratio of 40% as a starting point. This target was used in the lower floors. At the departure concourse level, a more conventional window to wall ratio of approximately 60-80% was adopted; however, due to reduced floor to ceiling heights, the overall area of glazing is significantly less compared to Terminal 1 and many international airports.
- Step 2 - Adopting high performance glazing: High performance glazing is a highly effective method to reduce solar gain and it is a permanent solution which requires no additional maintenance compared to traditional façades. The use of glass with low solar heat transmission but high visual light transmission also maximises natural daylight benefits while minimizing heat gain.
- Step 3 - Incorporating external shading systems: the use of external shading devices and overhangs to block direct solar heat gain from specific orientation and solar angles.
- Step 4 - Using opaque façade elements: the MFC has a relatively large roof area compared to the volume of the building. To mitigate solar heat gain, thermal insulation is used in the roof to reduce the U-value to below $0.3\text{W/m}^2\text{K}$, while a relatively light roof covering reduces internal gains further.

3.2. Active design methodology

In addition to the passive design strategies, low energy active design techniques are required for delivering energy in the most efficient way. The energy modelling process revealed that the artificial lighting and also air conditioning systems consume a large portion of the total energy demand. Therefore, a number of innovative and effective energy saving methods have been adopted in the MVAC and lighting systems.

3.2.1 Best practice cooling solutions

Several best practice air conditioning solutions have been incorporated into the MFC, with the following elements **exceeding the requirements of Hong Kong's Building Energy Codes:**

- Variable air volume (VAV) system: VAV systems are used for conditioned air delivery. Air handling units (AHUs) are provided to allow quick response to the dynamic cooling loads in predetermined zones. Each VAV system is controlled by its own CO₂ sensor and room temperature sensor to modulate the fresh air and recirculated air supply appropriately to maintain the indoor environmental requirements.
- Binnacle air delivery system: Binnacle air delivery systems are used in the departures level which has large floor to ceiling heights and ties in with the AHU systems. The binnacle system allows only the lower occupied zones to be conditioned.
- Free cooling: The flow of external fresh air delivered into the building is increased when the external air temperature and RH are lower than the pre-determined values to provide free cooling to the indoor spaces, reducing the work load of the chillers and achieving energy savings.
- Variable chilled water flow: As the MFC is a long and narrow building, chilled water needs to be pumped for large distances. Variable water pumping systems are adopted and these save energy by reducing the flow of chilled water when demand is low.
- Water cooled chiller system: Water cooled chillers offer significant energy savings compared to air cooled equivalent. Five variable speed water cooling towers are provided at MFC for chiller cooling to serve the building loads.
- Water recycling system: The MFC employs two water recycling systems. Grey water is recovered from washing basins, cleaner's sinks, showers and kitchen drainage and treated by the on-site grey water treatment plant; and condensate water is recovered from air conditioning system. Water recycled from both systems is used to offset the use of potable water for cooling tower make-up.

3.2.2 Active design of renewable technologies and transportation systems

Approximately 1,200m² of photovoltaic (PV) panels are installed at MFC, providing around 120kWp of clean power to offset the use of grid electricity. The PV panels are mounted on sloped south-facing areas of the roof skylights. This gives the panels an improved performance when compared to horizontal mounting.

While maintaining timely, efficient and comfortable transportation, several green initiatives have been included to minimise energy consumption from MFC transportation:

- Regenerative power: The APM train system incorporates regenerative power from the braking function. Lifts are also equipped with a regenerative unit that distributes the captured power to the building power supply;
- On-demand escalators: Horizontal transportation systems such as moving walkways and escalators are controlled to only operate when in use, as detected by motion sensors.

3.3. Energy modelling

Detailed building energy consumption modelling was performed to allow comparative analysis of building designs and technologies. With consideration of the various passive and active design technologies incorporated, the energy performance of the established MFC design was compared with the baseline situation established following **the EMSD's Performance-based Building Energy Code**. As illustrated in Figure 5 below, the simulation results indicate that the MFC can achieve beyond the targeted annual energy consumption reduction of 20%.

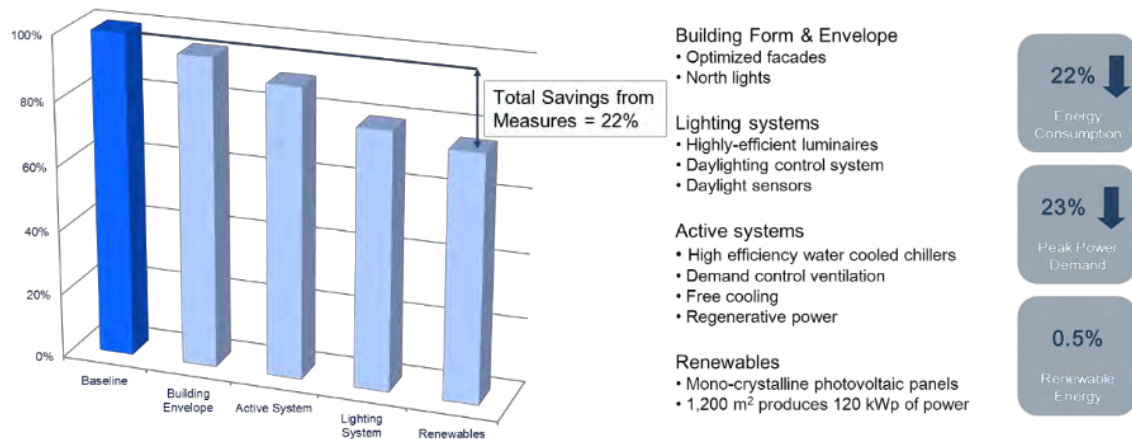

Figure 5: Energy saving from MFC green design initiatives

3.4. Commissioning, operation and maintenance

It is essential that the MFC building systems function efficiently to allow optimal performance. To support this objective, an extensive commissioning process was adopted on the project. Further to this, operations and maintenance staff were trained to use the systems effectively so as to realize all benefits. The benefits of extensive commissioning and staff training include reduced energy use, lower operating costs, fewer contractor call-backs, better building documentation, improved occupant well-being and productivity, and verification that the systems are able to perform in accordance with project requirements and expectations

4. CONCLUSION

Focusing on the MFC project as a case study, this paper describes how the early consideration of sustainable design principles and a systematic evaluation and prioritisation of the possible combination of passive design strategies and low-energy active design techniques can help take forward innovative ideas and sustainable design initiatives through the different stages of a project in delivering an energy efficient high-performance building. The MFC serves as **testament confirming HKIA's commitment to being a green airport. Adopting a similar green design strategy for the planned Expansion of HKIA into a Three-Runway System will bring similar sustainability benefits for HKIA and Hong Kong.**

REFERENCES

- [1] Balaban, O. and Oliveira, P.D., 2016. Sustainable buildings for healthier cities: assessing the co-benefits of green buildings in Japan. *Journal of Cleaner Production*, 1-11.
- [2] EMSD, 2007. Performance-based Building Energy Code. Electrical and Mechanical Services Department, 2007 Edition.
- [3] Environment Bureau, 2016. Latest Development on the Work on Combating Climate Change [online]. Retrieved from: <http://www.legco.gov.hk/yr15-16/english/panels/ea/papers/ea20160523cb1-928-3-e.pdf> [Retrieved on 26 September 2016].
- [4] Kovacic, I. and Zoller, V., 2015. Building life cycle optimization tools for early design phases. *Energy*, 92, 409-419.
- [5] Russell-Smith, S.V., Lepech, M.D., Fruchter, R. and Meyer, Y.B., 2015. Sustainable target value design: integrating life cycle assessment and target value design to improve building energy and environmental performance. *Journal of Cleaner Production*, 88, 43-51.
- [6] WBCSD, 2009. Energy Efficiency in Buildings – Transforming the Market. The World Business Council for Sustainable Development, 2009.
- [7] Wu, M.H., Ng, T.S. and Sktmore, M.R., 2016. Sustainable building envelope design by considering energy cost and occupant satisfaction. *Energy for Sustainable Development*, 31, 118-129.
- [8] Zuo, J. and Zhao, Z.Y., 2014. Green building research – current status and future agenda: A review. *Renewable and Sustainable Energy Reviews*, 30, 271-281.

The Use of Recycled Aggregates for Full Depth of Sub-base in Pavement Construction in Hong Kong

HUI Hok-tung^a

^a Highways Department, Government of the HKSAR, Hong Kong SAR, sernd2.rnd@hyd.gov.hk

ABSTRACT

Thousands of tons of inert construction & demolition (C&D) wastes are being generated from construction activities in Hong Kong daily. The inert portion of the C&D wastes, including broken rocks, concrete and soil, are delivered to the two fill banks in Hong Kong, which only have limited stockpiling spaces. In addition to the efforts made by the construction industry in minimizing the generation of C&D surplus, recycling of these inert C&D materials can surely alleviate the burden on the fill disposal facilities. Recycled aggregates can be derived from these inert C&D wastes for use in many areas of construction. One of the common applications of recycled aggregates is to be used in the sub-base layer for pavement construction. In the past, recycled sub-base was used with the presence of a capping layer of virgin aggregates to avoid the phenomenon of cementation, which may affect the performance of the sub-base layer. By addressing the cementation problem in recycled aggregates together with other measures to do away with the capping layer of virgin aggregates, the construction industry is encouraged to use recycled aggregates more extensively, which not only helps alleviating the capacity pressure at the fill banks, but also minimizes the use of natural resources by reducing the use of virgin aggregates. This paper discusses the latest research studies by Highways Department in collaboration with The Hong Kong Polytechnic University on the use of recycled aggregates for full depth of sub-base material in pavement construction, the quality control of recycled aggregates, and the implementation as an alternative for sub-base construction in local distributors and feeder in the Hong Kong road network.

Keywords: waste management, sub-base, road, recycled aggregates

1. INTRODUCTION

The construction industry in Hong Kong generated over 55,000 tonnes of C&D wastes daily (Environmental Protection Department, 2015). Currently, major portion of inert C&D wastes are going to the two public fill banks in Hong Kong (Environmental Protection Department, 2015), namely Tuen Mun Area 38 and Tseung Kwan O Area 137, for temporarily stockpiling for later reuse for reclamation or earth-filling projects. Potential ways of reusing the C&D waste were also explored by Highways Department for consuming the C&D waste generated by the local construction industry. One of the options is to reuse the C&D materials as recycled aggregates in sub-base in pavement construction. The use of recycled aggregates in sub-base could also reduce the use of virgin material which helps conserving natural aggregates in our environment.

2. THE USE OF RECYCLED AGGREGATES AS SUB-BASE

2.1 Recycled aggregates and sub-base

Aggregates are granular materials used in construction, commonly used in mixing of concrete and as sub-base materials for pavement construction. Aggregates could come from natural sources or be derived from C&D wastes including crushed concrete rubbles, ceramic tiles and crushed bricks (Poon & Chan, 2007). In Hong Kong, recycled aggregates can be used in both concrete and sub-base materials for pavement construction (Civil Engineering and Development Department, 2006). The sub-base layer forms the upper layer of the pavement foundation. Within a flexible pavement structure, the sub-base is also treated as a structural layer to spread the loading from the surface down to the subgrade (Highways Department, 2013) Typical cross-sections of concrete and bituminous pavement with sub-base layers extracted from Highways Department Standard Drawings H1101 and H1102 are shown in the Figure 1 and Figure 2 below respectively:

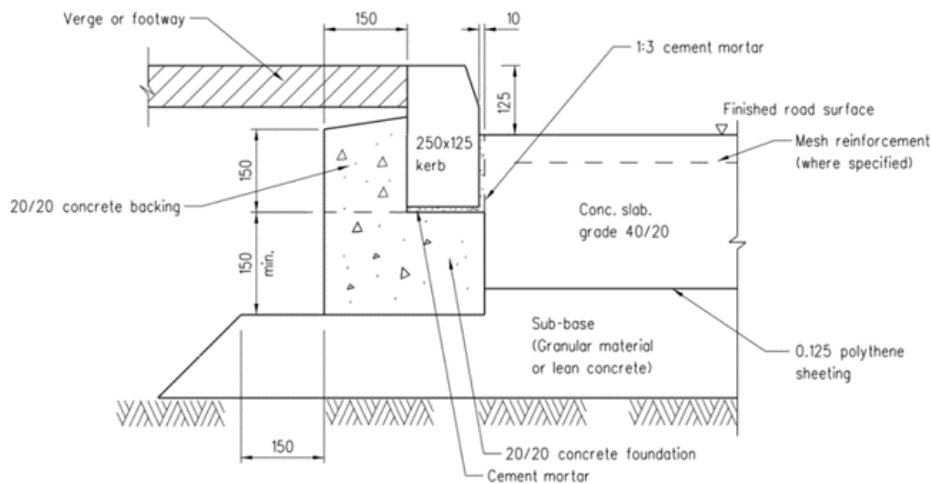

Figure 1: Typical cross section of concrete carriageway (Highways Department standard drawing)

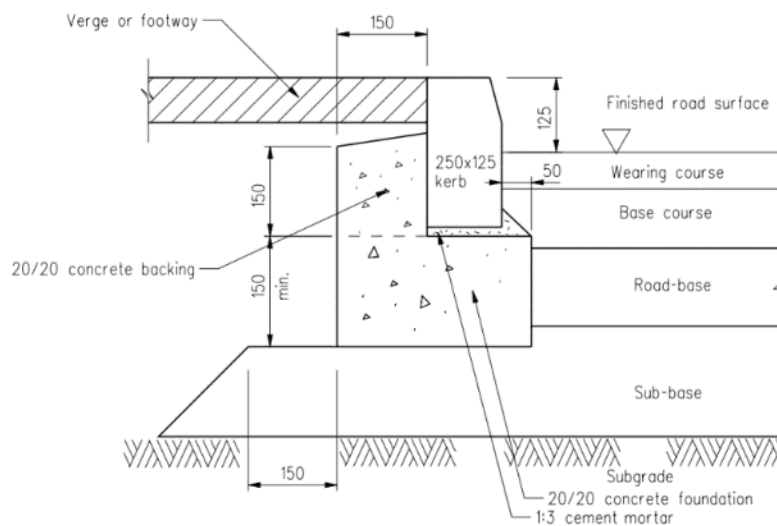

Figure 2: Typical cross section of bituminous carriageway (Highways Department standard drawing)

2.2 Previous study and practice in Hong Kong

Early laboratory tests and site trials revealed that the phenomenon of cementation may occur in recycled aggregates in sub-base layer in the presence of water. Cementation process happens when the unhydrated cement fines in recycled aggregates react with water under humid condition (Hiller et al., 2011). In the process of cementation, part of the sub-base layer would be hardened. It may increase the stiffness and bearing capacity of sub-base, but it may also affect the performance of the sub-base layer, particularly the drainage problem and the cracking problem in asphalt. As cementation happens in the recycled subbase over time, cracks on the recycled subbase may develop afterwards when the layer is subject to thermal expansion and contraction. The cracks in the sub-base layer may propagate upwards to the roadbase and eventually to the pavement surface as reflective cracking. In order to avoid cementation of recycled aggregates, a layer of virgin aggregates were used as a capping layer on the recycled aggregates layer at an approximate 4:6 thickness ratio. By adding this layer of virgin aggregates, the performance of the sub-base with recycled aggregates was satisfactory. This specification was then incorporated into the General Specifications for Civil Engineering Works (2006 Edition) as an option to allow the use of recycled aggregates as sub-base. Under this specification, the sub-base consists of two types of materials, a layer of recycled aggregates and a layer of virgin aggregates as capping layer (Civil Engineering and Development Department, 2006). However, this involves more working sequences in the laying and testing works. Moreover, the properties of the recycled aggregates vary a lot and make the quality control more difficult. These factors could be the reasons to explain the uncommon usage of this specification.

3. LATEST DEVELOPMENT

3.1 Recycled aggregates for full depth of sub-base

To promote the use of recycled aggregates in sub-base, Highways Department simplified the laying and testing working by avoid using two layers in sub-base when using recycled aggregates, i.e. to use full depth of recycled aggregate without the virgin aggregates capping layer. We also minimized the uncertainties in recycled material quality to reduce the risk of non-compliance. Collaboration studies were carried out with Hong Kong Polytechnic University and Highways Department in 2012 and 2014 to investigate the use of full depth recycled sub-base in Hong Kong road networks.

3.2 Minimize cementation in sub-base

Two layers of sub-base were specified in the General Specifications aimed to eliminate the cementation of recycled aggregates. Researches in the past found that cementation is caused by dicalcium silicate (C_2S) in cement (Hiller et al., 2011). C_2S in concrete hydrates and provides strength to concrete gradually for a long time. Therefore, if concrete is crushed as C&D waste into recycled aggregates and is used as sub-base, cementation will occur in the sub-base layer. Laboratory tests found that finely crushed concrete with size less than 0.15mm contains the most C_2S which contributes mostly to cementation in sub-base with recycled aggregates. It was found that by controlling the fine content in the gradation of recycled aggregates, cementation in sub-base could largely be minimized. Moreover, by controlling the fine content, it will compensate the possible extra fines generated during transportation and compaction of the recycled aggregates. Therefore, recycled aggregates can then be used in full depth of sub-base layer without the virgin aggregate capping layer.



Figure 3: Core taken from early site trial indicating significant cementation occurred in recycled sub-base layer

3.3 Minimize uncertainties in material quality

C&D Wastes typically contains crushed concrete, crushed rock, steel, wood, plastics, paper, foam, brick, ceramics, glass, etc. Among these constituents of C&D wastes, only crushed concrete and crushed rock are most suitable to be used as recycled aggregates. We can ensure the quality of recycled aggregates by removing other unwanted constituents from the C&D waste. However, it is impractical and expensive to totally remove these unwanted constituents. Therefore, we have to determine the acceptable percentage of these unwanted constituents to be used in sub-base.



Figure 4: Typical C&D waste

One of the common unwanted constituents in C&D waste is steel. Steel can be removed by magnet effectively unless it is embedded inside crushed concrete. As steel has high resale value, the industry usually has good incentive to remove steel from C&D waste before it becomes recycled material. The amount of steel in recycled aggregates is limited to 1% by weight.

Other light weight materials in C&D waste, such as plastic, foam, wood, papers, etc, must also be removed as far as practicable. These elements occupy space but cannot sustain loading, they may introduce weak points in pavement when they become part of the sub-base layer. There are numerous ways to remove these light weight unwanted constituents that had been using in the recycled industry, namely sieving, washing, wind blowing and manual pick. Sieving can effectively sort out those larger size unwanted constituents; Washing can separate the unwanted constituents by their density (i.e. less dense constituents will float on surface of water while dense constituents will sink to the bottom of the tank); Wind-blowing can remove light weight unwanted constituents; Lastly, manual picking, which is a rather low cost but effective technique. Manual picking had also been implemented at the Construction Waste Sorting Facilities operated by CEDD. The amount of light weight unwanted constituents can be practically limited to 0.3% by weight.



Figure 5: Wind-blower for sorting light weighted unwanted constituents in C&D Waste at the sorting facility in Tseung Kwan O Area 137



Figure 6: Manual picking unwanted constituents in C&D Waste at sorting facility in Tseung Kwan O Area 137

Another unwanted constituents are bricks. Bricks are weaker than crushed concrete and rock. They are susceptible to further breaking. If they become part of the sub-base layer, they may affect the stiffness and gradation of the sub-base and affect the performance of the pavement. However, bricks in C&D waste usually have similar size and density with crushed concrete or crushed rocks, which makes them difficult to be separated by the abovementioned methods. The only practical way to remove bricks is by handpicking from large size sieves. Therefore, it is necessary to set a practical limit to the amount of bricks without affecting sub-base performance. To determine this limit, we tested the engineering properties of recycled aggregates in laboratory and verify their performance by site trials and computer simulation. Results show that the limit of the amount of bricks in recycled materials can be proposed to 20% by weight (Wang, 2015). Similar limits are adopted in other overseas standards.

Glass, tiles and ceramics in C&D waste also have similar size and density to crushed concrete and rock. They can also be removed manually if they are in large pieces. However, they may be difficult to be identified for smaller size as they have similar colour with crushed concrete and rock. Nevertheless, according to the past statistics, glass, tiles and ceramics only contribute to a small portion in local C&D waste and their effect to the sub-base should not be a concern. These kind of miscellaneous inorganic materials are limited to 1% by weight in the recycled aggregates.

3.4 Addition of recycled glass cullet in sub-base

To promote the use of recycled glass, our collaboration research with the Hong Kong Polytechnic University also investigated the feasibility and performance of sub-base materials with recycled glass cullet. Laboratory tests and site trials indicated that it is feasible to use crushed recycled glass cullet as replacement of the fines in the sub-base materials. It was reported in study that the use of glass cullet increases the stability of the sub-base due to the angularity of the glass cullet (Poon, 2013). A study performed by the Texas Tech University College of Engineering also concluded that the use of glass cullet in sub-base do not affect the engineering properties of the sub-base layer by limiting the glass cullet content up to 20% of the total mass of sub-base (Nash et al. 1995). Most specifications in the US indicate that the replacement percentage of glass cullet in sub-base is between 5% and 20% of the total mass, and the replacement percentage is limited to 10% of the total mass in Australia (Poon, 2013). Limit of 10% by total mass is finally adopted for recycled glass cullet used in sub-base.

4. CONCLUSION

With the findings from laboratory tests, sites trials, computer simulations and exchanging views with trades addressing the factors that hinder the use of recycled aggregates as sub-base, Highways Department published the Particular Specifications for the laying sub-base with full depth of recycled aggregates in 2015, which also allows the option of using of recycled glass cullet as fines replacement. Project proponents can incorporate the Particular Specification into their works contracts. Currently, the particular specifications of full depth recycled sub-base are already included in the recently awarded term contract of Highways Department (Contract No. 02/HY/2015). We are confident that the use of recycled aggregates in sub-base will become more popular in future.

REFERENCES

- [1] Civil Engineering and Development Department (2006), General Specification for Civil Engineering Works. [online]: Civil Engineering and Development Department: p. 9.3, p.16.5. Available at: http://www.cedd.gov.hk/eng/publications/standards_handbooks_cost/stan_gs_2006.html [Accessed 12 Sep 2016]
- [2] Environmental Protection Department (2015). Monitoring of Solid Waste in Hong Kong. [online]: Environmental Protection Department, p. 10. Available at: <https://www.wastereduction.gov.hk/sites/default/files/msw2014.pdf> [Accessed 12 Sep 2016]
- [3] Highways Department (2013). Guidance Notes on Pavement Design for Carriageway Construction. [online]: Highways Department, p. 10. Available at: http://www.hyd.gov.hk/en/publications_and_publicity/publications/technical_document/guidance_notes/pdf/GN042.pdf [Accessed 12 Sep 2016]
- [4] Highways Department Standard Drawing, [online]. Highways Department, viewed 19 Sep 2016 <http://www.hyd.gov.hk/en/publications_and_publicity/publications/technical_document/hyd_standard_drawings/section1.html>.
- [5] Hiller, J. E. et al. (2011). Report RC-1544A Efficient Use of Recycled Concrete in Transportation Infrastructure. [online] Michigan: Michigan Technological University, p. 12. Available at: http://www.michigan.gov/documents/mdot/RC1544A_533313_7.pdf [Accessed 8 Sep 2016]
- [6] Nash, et al., (1995). Use Of Glass Cullet In Roadway Construction. Texas Tech University College of Engineering Research Reports. [online] Texas: Texas Tech University College of Engineering. Available at: http://txdot.texas.gov/business/contractors_consultants/recycling/glass_cullet.htm [Accessed 18 Sep. 2016].
- [7] Poon, C.S., Chan, D. (2007). A Review on the Use of Recycled Aggregate in Concrete in Hong Kong. In: Sustainable construction materials and technologies, 11-13 June 2007 Supplementary proceedings. Coventry: UW Milwaukee CBU, p144-155.
- [8] Poon, C.S. (2013). Final Report. Hy(S)Q/069/2011 Collaboration Research on the Performance of Use of Recycled Sub-base. Hong Kong: PolyU Technology & Consultancy Company Limited, p. 8.
- [9] Poon, C.S. (2013). Final Report. Hy(S)Q/069/2011 Collaboration Research on the Performance of Use of Recycled Sub-base. Hong Kong: PolyU Technology & Consultancy Company Limited, p. 10.
- [10] Wang, Y. (2015). Final Report. Hy(S)Q/051/2013 Collaboration Research on Use of Full Depth Recycled Sub-base in Hong Kong Road Networks. Hong Kong: PolyU Technology & Consultancy Company Limited, p.13.

Decision Making Process Assisted by Life Cycle Assessment: Greenhouse Gas Emission

Ludimilla de Oliveira ZEULE^a, Laís David VINHAL^b, Sheyla Mara Baptista SERRA^c, Douglas BARRETO^d

^a Federal University of São Carlos, Brazil, milla_zeule@hotmail.com

^b Federal University of São Carlos, Brazil, laiscruzeiro@yahoo.com.br

^c Federal University of São Carlos, Brazil, sheylabs@ufscar.br

^d Federal University of São Carlos, Brazil, dbarreto@ufscar.br

ABSTRACT

The concept of sustainability has been spreading in the construction industry, introducing tools and methods that may assist in the process of decision making and allowing improvements in management techniques as much as in production processes. Thus, this research aims the selection of materials by means of the proposition of a decision making method – the Choosing by Advantage (CBA) assisted by the Life Cycle Assessment (LCA). It was adopted a commonly employed component in temporary facilities of construction sites in the construction industry, the tiles. The adopted tiles were composed by recycled material (polyethylene – aluminum) and by non – recycled materials (galvanized steel). It was applied a multi-criteria methodology, in which the CBA method proposes the analysis of the best type of tile according to sustainability parameters – ecological, economic and social. In this study, LCA complements the CBA **by means of the evaluation of environmental impacts, where the factor “Carbon Dioxide Equivalent (Emission CO_{2eq})” was examined as a factor generated by the transportation of the tiles from the factory to the authorized reseller.** By means of the implementation of the decision making method, it was verified the feasibility regarding the application of the LCA as a support tool to the CBA method for the selection of materials that cause less impact as a positively complementary methodology. It is concluded that the adopted methodology assists in the dissemination of sustainability in the stage of execution, according to a systemic approach based on sound information.

Keywords: decision making method, life cycle assessment, carbon dioxide equivalent emission

1. INTRODUCTION

Abraham et al. (2013) considered that the construction industry sector frequently experiences issues regarding decision making processes. The complexity of the decisions to be taken by designers and others involved consists in the selection process of the building system as much as in the process of material selection. According to the authors, these issues demand a group of approaches called Multi-criteria Decision-Analysis (MCDA).

Models of multi-criteria decision may present the capacity of systematically formulate and compare different options against other vast sets of projects criteria, providing a versatile tool to deal with complex tasks regarding the decision making process (MILANI et al. 2011).

Even considering the building frequency of temporary facilities and their cycle (mounting process, usage, disassembly process and reutilization), studies regarding the sustainable development of the project process of this system in the construction site are not abundant. Arslan and Cosgun (2008) verified that, in order to improve the performance of emergency or temporary facilities, industry may need to explore the environmental aspects of these buildings throughout their existence phases.

This research aimed to verify the combined applicability of two methods in order to assist the decision making process in the selection of tiles for construction site facilities, considering the environmental impact category of **global warming and the “Carbon Dioxide Equivalent Emission (CO_{2eq})” factor** generated by the transportation of the tiles from the factory to the authorized reseller. In order to accomplish this analysis, the decision making system Choosing by Advantage (CBA) assisted by the Life Cycle Assessment (LCA) was employed.

2. MULTI-CRITERIA METHODS

The multi-criteria methods, as the decision making studies are designated, have been highly utilized in the solution of problems, since they may clarify to the decision maker the possibilities of choices. When a project staff chooses

an alternative, the approach may not be always overt, and rarely a formal method of decision making is employed (ARROYO, TOMMELEIN, BALLARD, 2015).

Milani et al. (2011) utilized the MCDA assisted by the life cycle assessment to the selection of composite materials and the considered criteria were cost, mechanical and thermal properties and environmental impact. In the research, it was compared a pure plastic gear with a polyethylene terephthalate (PET)/ alternative aluminum powder composite, one of the results highlighted that the performance of the composite material and the attributes of cost are modified during the project process.

In addition to economic and structural factors, due to global changes, other factors may also be part of corporate responsibility, as issues oriented to natural environment and society. Regarding sustainability, one alternative is to perform modifications in the production processes of companies in order to reach ecologically sustainable options.

2.3 Choosing by advantage (CBA)

The CBA system, according to Suhr (1999) is based on four principles: 1) the decision makers must learn and skillfully utilize tangible methods, 2) the decisions must be based on the importance of the advantage, 3) the decisions must be anchored on relevant facts and 4) different types of decisions demand different methods of decision making.

The difference of CBA, when compared to other methods, is the systemic analysis reconsidering the decision. Suhr (1999) indicates that the difference between sound methods and unsound methods are the weighting rating given to wrong items, for example: advantages and disadvantages, pros and cons, criteria and objectives. In advance, CBA is a system that compares the advantages of the alternatives.

The CBA method for moderately complex decisions divides the process of Decision Making in five phases: 1) stage-setting, 2) innovation phase, 3) decision making phase, 4) reconsideration phase and 5) implementation phase (SUHR, 1999). This article emphasis Phase 3, the decision making phase.

3. LIFE CYCLE ASSESEMENT (LCA)

LCA is a tool utilized to assess the potential environmental impacts of a product system throughout its life cycle. This tool may be divided into four phases: definition of objective and scope; analysis of Life Cycle Inventory (LCI); Life Cycle Impact Assessment (LCIA) and interpretation of results (ABNT, 2009).

Onwards the results obtained by LCA it is possible to recognize the aspects that may cause more impact throughout the life cycle and, according to NBR ISO 14.040 (ABNT, 2009), by means of the interactivity among the phases of the LCA, it may be possible to achieve the completeness and consistency of the research and of the results.

According to Passuelo et al. (2014) there is a lack of studies about the LCA of construction materials in Brazil, what determines the necessity of studies that relate the practice of LCA in the local scenario in order to transform this object into a management tool applicable to the Brazilian reality.

4. RESEARCH METHOD

The employed research procedure was based on three available methods:

- Five stages of Phase 3 – Decision Making of the CBA (SUHR, 1999) ;
- Proposal of the authors Arroyo, Tommelein, Ballard (2015), suggesting the complementation of Phase 3 – Decision Making process with two more stages considered in Phase 2 – Innovation of CBA (SUHR, 1999), making the decision making procedure more comprehensive, embodying seven stages; and
- LCA as a tool disclosed by technical standards, allowing the evaluation of environmental impacts caused by materials and systems of products– NBR ISO 14.040 (ABNT, 2009), in order to assist the decision making process regarding environmental aspects.

Figure 1 exemplifies how the method was composed in order to be applied in this research.

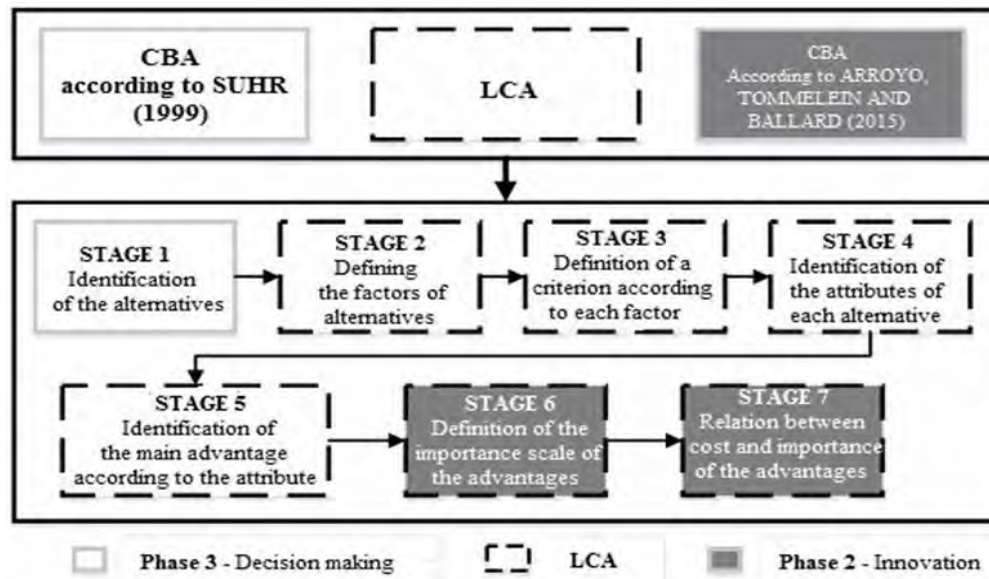

Figure 1: Participation of cba and lca in the method: Authors, 2016

This research was focused on the “Carbon Dioxide Equivalent Emission (CO_{2eq})” of the analyzed tiles, which was the factor chosen to be studied on Stage 2 of Phase 3, regarding the Decision Making method CBA aggregated to the LCA which assisted the decision making process until the last stage.

For the effective application of the LCA, it was utilized a software in order to manipulate the data, as well as a database of life cycle inventories. The employed software was the Open LCA® and the ELCD 2.0 (ELCD, 2016) database; both were chosen because of the free availability.

In this research, it was analyzed the transportation stage of the tiles from the factory to the authorized reseller. Therefore, the data collection considered the calculation of the average distance between the factory and the cities in which the tiles were resold; the distances found are analyzed in Table 1. This analysis was made by means of a direct contact with the manufacturer of the tiles.

The analyzed tiles were constituted by: recycled material of long life package (polyethylene – aluminum); metallic corrugated in galvanized steel and; metallic trapezoidal in thermo-acoustic galvanized steel. Thus, by means of the software, the data provided by the manufacturers were compiled in order to obtain the CO_{2eq} emission regarding the category of global warming. In order to achieve the CO_{2eq} emission data caused by the transportation of the tiles, it was utilized the method consolidated by the Intergovernmental Panel on Climate Change (IPCC) (IPCC, 2013).

5. CASE REPORT

The selection of the tiles for the application of the method concerns the fact that the tile is one of the required components in temporary facilities of construction sites, and during the transportation process, the emission of greenhouse gases occurs.

The typology of the three analyzed tiles were: 1) tile containing recycled substances of long life package (polyethylene – aluminum); 2) corrugated galvanized steel tiles ; 3) thermo-acoustic trapezoidal galvanized steel tiles, aiming to compare the different variety of tiles available on the market, which are employed in temporary facilities of construction sites.

5.1 Characterization of the tiles

The tiles presenting recycled material of long life package are composed by plastic (low density polyethylene LDPE) and aluminum of the packages, with an external layer of virgin aluminum, which is not part of the residues of the long life packages, adhered to the tiles in order to improve the thermal performance. The measures of these tiles were 2, 20 of length, 0, 92 of width, 6mm of thickness and 14 kg per unit.

The corrugated tiles constituted of galvanized steel are not painted metallic tiles, manufactured from a steel sheet covered by a thin layer of protection composed by pure zinc (galvanized sheet). The function of the zinc is to avoid the corrosion process. The tiles used in this research were corrugated and natural (no painting), they presented width of 1,10m, length of 2,20m, thickness of 0,50mm and weight of 9, 9 kg per unit.

Trapezoidal tiles manufactured in galvanized steel are not painted metallic tiles produced by two steel sheets (sandwich tiles), coated by pure zinc (galvanized sheet). In order to be designated as thermoacoustic, it must be filled with an insulating material as Expanded Polystyrene (EPS) or Polyurethane (PU), for example, thus characteristics that may improve the thermal and acoustic performance will be developed. The tiles applied in this study presented the shape of a trapezium, width of 1,10m, length of 2,20m, thickness of 0,50mm and a layer of EPS with 50mm of thickness, each piece weighted 21kg.

5.2 Application of the method

The research was developed considering the stages described in frame 1.

Stage 1	Identification of the alternatives – The alternatives chosen to the application of the CBA method were the three types of tiles specified in item 5.1, utilized in temporary facilities of building sites.
Stage 2	Definition of factors - The “Carbon Dioxide Equivalent Emission (CO_{2eq})” factor was analyzed. Therefore, in Stage 2 the LCA was integrated in order to assist the CBA decision making method, in which the potential category of global warming was analyzed with regard to the transportation process. This factor was investigated regarding the transported distance and the weight of the tiles from the factory to the authorized reseller.
Stage 3	Definition of a criterion regarding the factor – The criterion adopted to analyze the potential factor of global warming was: lower emission of CO _{2eq} . According to the principle of sustainability, lower emissions of CO _{2eq} are related to a lower contribution to the global warming effect.
Stage 4	Report of the attributes of the alternatives –In Table 1 the attributes of the alternatives were expressed, in other words, the quantity of CO _{2 eq} emitted by the transportation of the tiles to the reseller.
Stage 5	Decision of the main advantage – The main advantage indicated by the decision maker regards the tile presenting a lower CO _{2 eq.} emission.
Stage 6	Definition of the importance scale of the advantages – In this research, as a single factor was analyzed (“CO_{2 eq} emission”), consequently it was evaluated by a maximum punctuation of 100 points.
Stage 7	Relation between cost and importance of the advantages – After the attribution of the scores to the advantages, a calculation was made and the total of the importance of the advantages was obtained. The value of each alternative was also obtained, in other words, the price of each tile (unit) per square meter was achieved, a graphic lofA x R\$ was schematized,

Table 1 exhibits important data as the average distance traveled by the truck in order to transport the tiles from the factory to the sales area, considering that this resale may be direct as it is the situation of the metallic tiles in galvanized steel or may be performed indirectly, as the recycled tiles, which the manufacturer transports the product to another specific sales area.

Types of Tiles	Recycled material Polyethylene-aluminum	Corrugated Galvanized Steel	Thermo-acoustic Trapezoidal Galvanized Steel
Distance and Lorries			
Average transportation distance from factory to resale	1.225 km	535 km	535 km
Lorry utilized in the transportation	Truck 22 tonnes or Truck 14 tonnes	Truck 25 tonnes or Truck 12 tonnes	Truck 25 tonnes or Truck 12 tonnes

AUTHORS, 2016
Table 1: Distance data

According to the metadata of ELCD 2.0 (ELCD, 2016) the utilized methods were prepared according to the weighted average of the trucks in accordance to the emission standards EURO, in other words, EURO 0 to EURO 4. The valid cargo considered to the transport was 17,3tonnes and 27t, due to the types of trucks utilized and **detailed on Table 1, and, mainly, for being modules that represent “process systems” and for considering the early life of the diesel.**

6. RESULTS

Due to the fact that tiles present the function of covering the facilities, a reference unit of coverage of 50m² was adopted in order to perform the calculation. In addition, an analysis was made regarding the sensibility of the disclosed data. Thus, the calculation was performed considering the average distance and a distance of 100km (standard), in order to make it possible to analyze the interference of the characteristics of the tiles, as the transported weight and volume.

In order to quantify the CO_{2eq} emission level, it was employed the Life Cycle Impact Assessment (LCIA) method developed by IPCC, which utilizes the Global Warming Potential (GWP) in order to transform the emissions of greenhouse gases into emissions of CO_{2eq}, considering a time line of 100 years (IPCC, 2013).

The modules adopted as reference to the calculation of CO_{2eq} **emission were “Lorry transport, Euro 0, 1, 2, 3, 4 mix, 22 t total weight, 17,3t maxpayload - RER”, a more decisive module when compared to the “Articulated lorry transport, Euro 0, 1, 2, 3, 4 mix, 40 t total weight, 27 t maxpayload – RER”, according to Table 2.**

TILES	IPCC 2013 - GWP 100a (CO _{2eq})					
	Distance of 100km			Real Distances		
	Tonnes x km	Max. 27 tonnes	Max. 17,3 tonnes	Ton x km	Max. 27 tonnes	Max. 17,3 Tonnes
Polyethylene – aluminum Recycled material	42,0	0,00492	0,00819	514,5	0,06023	0,10018
Metallic Corrugated	24,8	0,00281	0,00468	132,6	0,01547	0,02573
Metallic thermoacoustic	52,6	0,00609	0,01014	281,4	0,03293	0,05477

AUTHORS, 2016

Table 2: Global warming according to real and standard distances with the maximum cargo weight of the truck

According the real distances, the module which contributed the most for the category of to this analysis, the average distance directly affected the results, as the longer distance refers to the recycled tile (1225 km), followed by the metallic tiles presenting the same distance (535 km). In this case, as the distance for the metallic tiles was equivalent, the predominant factor for the result of the emission level was the weight, as in order to cover 50m² it is necessary 0,526 tonnes of thermoacoustic tiles and 0,248 tonnes of corrugated metallic tiles.

However, when the standard distance of 100 km was adopted, the transportation of the thermoacoustic tile was the most critical. In order to perform this analysis, it was observed that the weight of the tiles was decisive for the results, as to cover 50m², the thermoacoustic tiles own a higher weight of 0,526 ton/ m², followed by the recycled tiles, 0,420 ton/ m² and the corrugated metallic tiles, 0,248 ton/ m². Henceforth, Table 3 exhibits the results of the joint application of the CBA method assisted by the LCA, where it may be seen six of the seven stages briefly explained on the research method.

ANALYZED FACTOR	ALTERNATIVES					
	POLYETHYLENE - ALUMINUM RECYCLED TILE		CORRUGATED METALLIC TILE – GALVANIZED STEEL		THERMOACOUSTIC METALLIC TILE – GALVANIZED STEEL	
Carbon Dioxide Equivalent Emission – according to the average distance Criterion: Lower CO _{2eq} emission	Attributes: 1,00	0	Attributes: 0,26	50	Attributes: 0,55	0
	Advantage:		Advantage: lower CO _{2eq} emission		Advantage:	
Carbon Dioxide Equivalent Emission – according to the distance of 100km Criterion: Lower CO _{2eq} emission	Attributes: 0,82	0	Attributes: 0,47	50	Attributes: 1,01	0
	Advantage:		Advantage: lower CO _{2eq} emission		Advantage:	
TOTAL IofA		0		100		0

AUTHORS, 2016

Table 3: Results of the application of cba assisted by Ica.

In order to conclude the selection of the tile, the economic aspect was considered. Stage 7 of the research method presents a graphic containing the cost of the tiles according to the Importance of Advantage (IofA).

The values of the tiles were calculated referring to 1m². The polyethylene – aluminum recycled tile costs R\$ 16,58/m², the corrugated metallic tile in galvanized steel costs R\$ 16,54/m² and the thermoacoustic metallic tile in galvanized steel with EPS costs R\$ 44,64/ m². Thus, the graphic presented by Figure 2 illustrates the relation between Importance of Advantage and costs/ m² of the tiles.

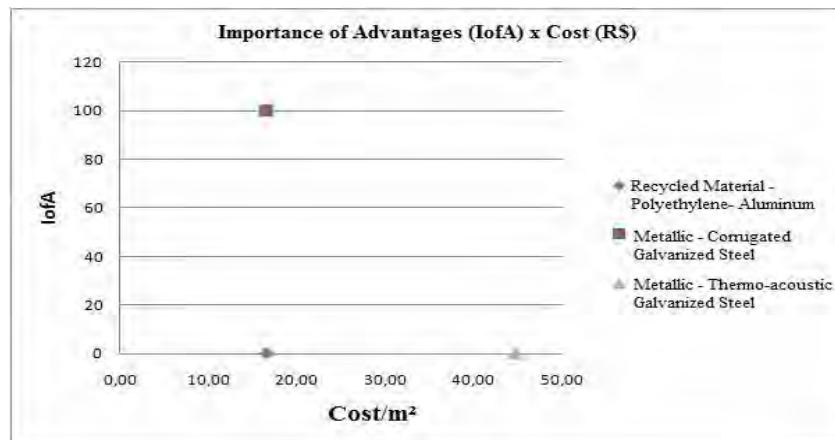

Figure 2: Graphic of the relation between the importance of advantage x cost of the tiles: Authors, 2016.

Therefore, after the implementation of the method, it was possible to identify that the most convenient tile regarding the factor of greenhouse gas emission was the corrugated metallic in galvanized steel, which emitted less CO_{2eq}, and presented a reasonable market price. However, it is emphasized that other factors must be assessed in order to complete the process of material selection.

7. CONCLUSION

According to the performed evaluations, the possibility of achieving several results was verified, what presents a direct dependency with the unit of reference. In this work, the application of LCA allowed to determine the quantity of emitted CO_{2eq}, by means of the category associated to global warming. However, the necessity of analyzing other categories of environmental impact that may relate other ways of emission not contemplated by the category of global warming is existent.

Brazil does not own an implemented database that represents the reality in all levels of the country, thus, it justifies the use of an international database. The ideal is the performance of an adaptation of the information presented by the database as reference. However, the objective of this research was to demonstrate the contribution that LCA may provide to the decision making methods, because LCA effectively contributes by facilitating the choice made by the decision-maker.

Characteristics as volume and weight, in addition to the average distance traveled by the vehicle and the utilized vehicle must be considered in order to analyze the transportation process of the tiles. These factors must be simultaneously studied as they directly affect the emission levels, enabling a critical examination by the decision maker at the moment of the analysis according to the unit of reference.

Thus, the accuracy of the method adopted in this research was validated. The LCA verified the CO_{2eq} emission and the method of decision making verified the advantages of the tiles by means of the principle that when the CO_{2eq} emission level is lower, consequently the transport causes less social and environmental impacts.

It is important to emphasize that the result obtained with regard to the CO_{2eq} factor, does not characterize the ideal tile for the selection of the material to be utilized in temporary facilities in construction sites, since this analysis must be made by considering other factors that may characterize the environmental, social and economic impacts. Thus, the decision making process in the sector of construction industry requires attention aiming the improvement of this area.

ACKNOWLEDGMENTS

To FINEP, project CANTECHIS (Technologies for Sustainable Construction Sites for Habitations of Social Interest), for support for this research. To the researchers of the Technological Research Institute of São Paulo (IPT).

REFERENCES

- [1] ABRAHAM, K.; LEPECH, M.; HAYMAKER, J. 2013. Selection and Application of Choosing by Advantages on a Corporate Campus Project. In: Proceedings IGLC-21, July 2013 – Fortaleza, Brasil.
- [2] MILANI, A. S.; ESKICIOGLU, C.; ROBLES, K.; BUJUN, K.; HOSSEINI-NASAB, H. 2011. Multiple criteria decision making with life cycle assessment for material selection of composites. *eXPRESS Polymer Letters*, vol.5, n.12, p.1062–1074.
- [3] ARSLAN, H.; COSGUN, N. 2008. Reuse and recycle potentials of the temporary houses after occupancy: Example of Duzce, Turkey. *Building and Environment*, v. 43, n. 5, p. 702-709.
- [4] ARROYO, P.; TOMMELEIN, I. D.; BALLARD, G. 2015. Selecting globally sustainable materials: A case study using Choosing by Advantages. *Journal of Construction Engineering and Management*, v. 142, n. 2, p. 05015015, 2015.
- [5] SUHR, J. 1999. *The choosing by advantages decisionmaking system*. Westport, CT: The Greenwood Publishing Group/Quorum Books.
- [6] ABNT. ASSOCIAÇÃO BRASILEIRA DE NORMAS TÉCNICAS. 2009. NBR ISO 14040 – Gestão ambiental - Avaliação do ciclo de vida – Princípios e estrutura. Versão corrigida 21/07/2014, 21 p. Rio de Janeiro.
- [7] PASSUELO, A. C. B.; OLIVEIRA A. F. de; COSTA, E. B. da; KIRCHHEIM, A. P. 2014. Aplicação da avaliação do ciclo de vida na análise de impactos ambientais de materiais de construção inovadores: estudo de caso da pegada de carbono de clínqueres alternativos. *Ambiente Construído*, Porto Alegre, v. 14, n. 4, p. 7-20, out./dez. 2014. ISSN 1678-8621
- [8] ELCD. European Life Cycle Database. Versão 2.0 access by open LCA nexus. Available on :<https://nexus.openlca.com>. Access in: may. 2016.
- [9] IPCC. INTERGOVERNMENTAL PANEL ON CLIMATE CHANGE. 2013. Summary for Policymakers. Working Group I Contribution to the IPCC Fifth Assessment Report Climate Change 2013: The Physical Science Basis. Cambridge, UK: Cambridge University Press.

Building Life Cycle Assessment: Investigation of Influential Factors in a Helpful Decision Tool

Marie-Lise PANNIER^a, Patrick SCHALBART^b, Bruno PEUPOORTIER^c

^a Mines ParisTech PSL Research University, France, marie-lise.pannier@mines-paristech.fr

^b Mines ParisTech PSL Research University, France, patrick.schalbart@mines-paristech.fr

^c Mines ParisTech PSL Research University, France, bruno.peuportier@mines-paristech.fr

ABSTRACT

A building life cycle assessment tool was developed and linked with an energy simulation tool, allowing to take into account the strong interactions between the energy and the environmental performance of buildings. This life cycle assessment tool was then extended at the urban level to evaluate the environmental impacts of a district including many buildings, streets, public spaces and technical network. Building and neighbourhood design alternatives can thus be compared, providing assistance in the decision process. However, the reliability of LCA tool is essential to guide the decision maker towards sustainability. A methodology is presented here to investigate the most uncertain inputs. Factors affecting the building energy performance, the building lifetime and the choice of the electricity mix **were identified as the most influential factors which could alter the results' robustness.**

Keywords: life-cycle assessment, building energy simulation, sensitivity analysis

1. INTRODUCTION

Because of its high environmental impact, the built environment has been identified as a key sector to face today's energy and environmental challenges. The quantitative and multicriterial life cycle assessment (LCA) methodology, according to ISO 14040, is particularly adapted to study and helping to reduce these impacts. By comparing their environmental impacts, several projects corresponding to the same functional unit can then be ranked according to their performances.

In order to guide the decision towards the most sustainable alternative of a building or district project, robust LCA tools are necessary. Such tools should take into account the specificities of the building sector. Therefore, it was decided to link a building and district LCA simulation tool with a dynamic building energy simulation (DBES) tool.

During a project, the LCA practitioner has to make a lot of choices which can affect the results' robustness, i.e. the ranking of different project alternatives. Quantification methods like sensitivity analysis (SA) can be used to investigate the influence of uncertainties. The objective of the study presented hereunder is to identify the most influential factors met in building LCA. Uncertain factors are therefore described and a SA method is applied in the case of a family house.

2. LCA OF BUILDINGS AND DISTRICTS

LCA has been applied to the building sector since the 1990s. It was first used for buildings only and was then extended to the district level during the 2000s. However, when assessing the environmental performances, the buildings and districts specificities should be considered.

2.3 Specificity of the built environment

Contrarily to most industrial products, a building is generally constructed only once: it is unique. LCA practitioners have therefore little resources and time for a study. Dedicated LCA tools make such studies simpler if they are linked to a graphic modeller and an energy simulation tool.

When conducting a building LCA, all life cycle stages must be considered: e.g. construction, use phase, renovation, and end-of-life. Due to the long building lifetime, the use phase is predominant and contribute to 80 % of the energy consumption in conventional buildings. This part is reduced to 50 % in low energy buildings.

Some choices made during the energy assessment of a building (e.g. the insulation type or thickness) influence not only its energy performance but also its environmental one: some insulation material having better thermal properties may have higher environmental impacts. Both energy and environmental assessment should be conducted together in order to estimate the global benefit of a choice.

Dynamic phenomena must also be considered. Meteorological phenomena and occupants' behaviour cause dynamic variations of the building energy load. The electricity production mix is also not static during the year. [5] showed that choosing an annual or a dynamic LCA could have a large influence on impacts evaluation.

At the neighbourhood level, interactions between buildings and with networks occur. For example buildings can shade each other. The entire district is affected by urban heat island phenomena.

Dedicated tools have been developed to assess the environmental performances of the built environment and take into account the sector specificities.

2.4 Description of the building and district LCA tool used in this study

Due to the importance of the energy consumption in the use stage as well as the links between the energy and the environmental performances, a building and district LCA simulation tool (novaEQUER) was linked to a DBES tool (COMFIE).

In COMFIE buildings are divided into thermal zones. For each of them, the temperature, and the heating and cooling loads are calculated by solving thermal equations. LCA can then be performed using novaEQUER. Building materials, thermal results, energy type, but also water consumption, transportation and waste produced during the use stage are taken into account. The LCA can be either annual (e.g. static) or dynamic (hourly load and hourly electricity production mix allocated to different uses). Twelve environmental indicators are calculated (Table 1).

Environmental indicator	Legend	Unit
Cumulative energy demand	(CED)	GJ
Water consumption	(W)	m ³
Abiotic depletion potential	(APD)	kg Sb equiv.
Non radioactive waste creation	(NRW)	t equiv.
Radioactive waste creation	(RW)	dm ³
Global warming potential	(GWP 100)	t CO ₂ equiv.
Acidification potential	(AP)	kg SO ₂ equiv.
Eutrophication potential	(EP)	kg PO ₄ ³⁻ equiv.
Damage caused to ecosystems	(BD)	PDF.m ² .yr
Damage caused to human health	(HD)	DALY
Photochemical oxidant formation	(POP)	kg C ₂ H ₄ equiv
Odour	(O)	Mm ³

Table 1: Environmental indicators used in novaEQUER

In order to simplify the use of the tool, a dedicated graphic modelling tool (Alcyone) allows describing the geometry of all buildings in a district. When assessing the performance of a building, the others are considered as shading objects for a higher precision of the simulation results. Another module in novaEQUER concerns the district LCA. All buildings LCA results are included and the public space, technical networks and streets are described.

NovaEQUER is a commercially available software. It is used by consultants or architects in the eco-design process at building or district scale.

3. RELIABILITY OF LCA AT THE BUILDING LEVEL

If buildings and districts LCA tools are used in decision-making processes, they have to provide reliable results. Otherwise, they may lead to decisions that are not the most sustainable. However during an LCA study, practitioners are facing many choices, and uncertainties in the input can affect the results robustness.

Results of different LCA tools were compared in research projects in order to investigate their robustness. Eight European tools were compared within the network PRESICO. The results were similar and the scattering was +/- 10% of the mean value between the tools when evaluating the GWP during the entire life cycle of a wooden construction. In another project, two French building LCA tools were compared. It highlighted methodological differences in the tools as well as differences due to life cycle inventory databases.

Uncertainty quantification methods can be set up in order to analyse the results' robustness of a building LCA tool when comparing project alternatives. With uncertainty analysis (UA), uncertainties are propagated through the model, enabling to understand the uncertainty level in the outputs due to the input uncertainty level. The Monte Carlo method is often used to do this. As a result, probability distributions are obtained for each output. Another method, the SA, aims at better understanding influence of uncertain factors in ranking them, according to their contribution to the output uncertainty. SA is also called key issue analysis or uncertainty importance analysis in LCA. A simple and quick SA method is presented hereunder after having introduced uncertainty sources met in building LCA.

3.1 Uncertainty in building LCA

Five uncertainty sources that were identified in building LCA are described below.

- Hypotheses about the building: During the DBES and LCA simulation a lot of hypotheses must be done. **They concern the building envelope and systems, the occupant's behaviour or the building and its components lifetime.** These hypotheses are uncertain and a range of values around a reference value is considered.
- Long term evolution: Buildings have a long lifetime and the long term evolution of the context is largely unknown (e.g. change in the electricity production or materials end of life processes). Prospective scenarios, describing a large range of possible futures, can be used to model this type of uncertainty.
- Modelling methodology: Some aspect may be modelled in different ways in LCA. For instance regarding recycling, two allocation methods can be used: the cut-off or the avoided burden method. In the avoided burden approach an environmental benefit is considered because recycling avoids a standard production. This benefit is split between the construction stage and the end of life. In the cut-off approach, the benefit is only accounted for in the construction phase whereas no avoided impact is allocated to end of life, supposed to be in a far future so that the benefit is uncertain.
- Life cycle inventory (LCI): The way to inventory all emitted and extracted substances to the environment for building materials or processes also leads to uncertainty. Data availability and quality are drivers of this LCA phase. The choice of marginal or average data for the inventory does not give the same image of a product or process. Additionally, simplifications of the inventory are sometimes conducted, e.g. gathering many substances in a single VOC (volatile organic compounds) group, which leads to the reduction of some substance effects (e.g. dioxins are more toxic than the average of VOCs).
- Life cycle impact assessment (LCIA): The aggregation of substances into environmental impact categories is uncertain. Indeed, effects of substances alone or of interactions between substances are not always well known. And the effect of substances may vary with the time and the emission location.

3.2 Sensitivity analysis: The Morris screening method

Uncertainty and sensitivity assessment requires a large number of simulations to ensure convergence of the results. At least one thousand simulations in UA or thousands of simulations in global SA are required. The Morris method, which belongs to the screening techniques, has the advantage to be quick and simple. The aim is to rank the input factors according to their influence. It gives also information about the linearity and the presence of interactions.

Screening techniques allow a fast exploration of the model behaviour. Instead of considering all possible values of all input factors, only a few sets of values are kept thanks to a discretisation into a finite number of levels. So, it is not necessary to specify the probability distribution for each factor; only an upper and a lower limit are required. Then an OAT (One-step-At-a-Time) method is repeated r times. Each OAT can be considered as a trajectory in the space of input factors, for which each input is varied while keeping the others constant. Elementary effect (EE) can be estimated for each input like in Equation 1, where j is the factor index, i the repetition index, f the considered model and Δ the jump between two discretized values.

$$EE_j^i = \frac{f(x_1^i, \dots, x_j^i + \Delta x_j^i, \dots, x_d^i) - f(x_1^i, \dots, x_j^i, \dots, x_d^i)}{\Delta}$$

Equation 1

The average EE is calculated as in Equation 2: the higher this average, the higher is the influence of the factor j . By calculating the absolute value, the compensation of two opposite EE is avoided.

$$\mu_j^* = \frac{1}{r} \sum_{i=1}^r |EE_j^i|$$

Equation 2

The standard deviation is calculated as in Equation 3. A large standard deviation indicates the presence of non-linearities or interactions between the input factors.

$$\sigma_j = \sqrt{\frac{1}{r-1} \sum_{i=1}^r (EE_j^i - \mu_j^*)^2}$$

Equation 3

To have an overview of the influence of each factor, σ_j is drawn as a function of μ_j^* in a Morris graph. So three input types can be identified: inputs having negligible effect (small σ_j and μ_j^*), inputs having large effect without interactions (small σ_j and large μ_j^*) and inputs having non linear effect or interaction effects (large σ_j).

4. CASE STUDY AND RESULTS

4.1 Description of the case study

The Morris method was applied on a case study to investigate the influence of uncertain input factors. A single family house from the INCAS platform in Chambéry (France) was chosen. It is a concrete house of 90 m² (living area) corresponding to the performance of the passive house standard and using electric air heating. COMFIE and novaEQUER were used respectively to perform DBES and LCA. The statistical software R was used to conduct the SA.

In this first study, a set of 22 uncertain factors were investigated (see Table 2). The uncertainty due to some factors, **like the waste production or the occupants' transportation during the use phase, was not taken into account in this first step.** The variation intervals were chosen to describe the uncertainty on these factors are given in Table 2. In some cases, the variation occurs around a reference value (+/-), e.g. for factors influencing the energy performance. Because the house is already built and its characteristics well known, a quite low uncertain range was chosen for most of these factors. The reference scenarios correspond to hourly mean values for a housing with four main rooms.

Most of the ranges were found in the literature, others were assumed. Regarding thermal bridges a high uncertainty range was considered because the literature gives a wide range of values for each thermal bridge type. Two French electricity production mixes, implemented in novaEQUER were investigated: a static one considering an annual average and a dynamic one which varies hourly and for each type of use. In order to take into account uncertainty

due to LCI and LCIA, different types of concrete were considered (a normal concrete and a prestressed) and different time horizons were investigated for the GWP.

Uncertain factor	Variation range	
Climate and site	Outdoor temperature	+/- 0,5 °C
	Global horizontal radiation	+/- 10 %
	Albedo (ground reflection)	+/- 15 %
Scenario	Indoor temperature setpoint	+/- 0,5 °C
	Occupancy	+/- 10 %
	Internal gain	+/- 10 %
	Ventilation	+/- 10 %
Envelope	Windows thermal resistance	+/- 5 %
	Windows solar factor	+/- 5 %
	Insulation material thickness	+/- 0,5 cm
	Concrete thickness	+/- 0,5 cm
	Thermal bridges	+/- 50 %
	Material loss rate (during construction)	0 to 10 %
Lifetime	Building lifetime	40 to 120 yr.
	Windows lifetime	11 to 59 yr.
	Painting lifetime	8 to 36 yr.
Climate and site	Factory to site materials transportation	15 to 135 km
	Site to landfill materials transportation	5 to 45 km
Context	Water network efficiency	50 to 100 %
	Electricity production mix	Static or dynamic
LCI data	Concrete type	Normal or prestressed
LCA method	IPCC time horizon	20 yr. or 500 yr

Table 18: Investigated uncertain factors and variation range

4.2 Results

2300 simulations of the model were necessary to identify the most influential input factors using the Morris screening. It took about 2h40 minutes with a six cores computer. A Morris graph plotting the standard deviation of the effect, σ_j versus the average absolute effect, μ_j^* (Equation 2) and (Equation 3) was obtained for the twelve environmental indicators calculated in novaEQUER, (Figure 1 for CED and GWP).

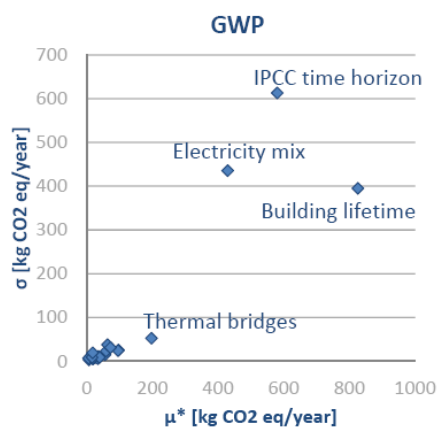

Figure 1a: Morris graphs for the CED

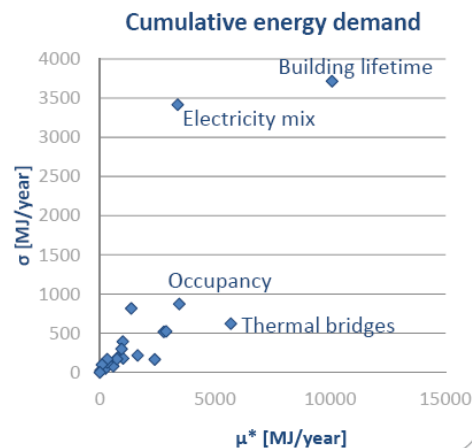

Figure 1b: The GWP

For the GWP (Figure 1a), the drivers identified by their large μ^* are the IPCC time horizon, the type of electricity mix. Although the results are given per year, the building lifetime influences largely the results. It is due to interactions between this factor and others like the windows or the painting lifetimes. A hypothesis in novaEQUER stipulates that the building components are not replaced if the replacement occurs in the last 10 % of the building lifetime.

For the CED (Figure 1b), the building lifetime and the electricity mix are input factors having a strong influence. The most influential factors for the energy performance are also prominent on heating load (e.g. thermal bridges). This confirms the influence of the building energy performance. The occupancy has also a high influence. Indeed, if there are more inhabitants, more hot water will be consumed, resulting in a variation of the energy demand to heat the water.

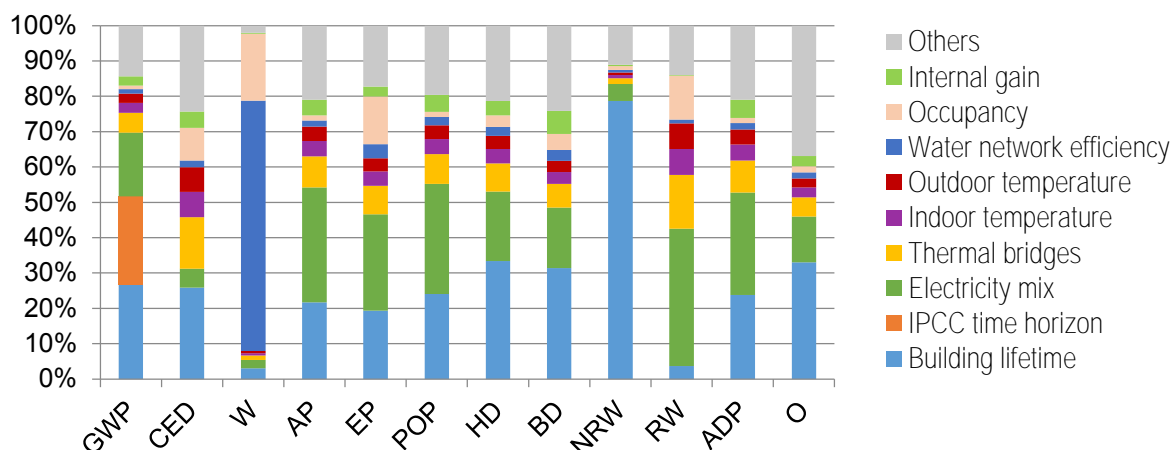

Figure 2: Contribution of uncertain factors to the global uncertainty

Figure 2 summarises the influence of the investigated factors on the twelve environmental indicators. For each factor j , the relative influence on the output uncertainty I_j^* is calculated considering the Euclidian distance to Morris graphs origins, as in Equation 4. The most influential factors for GWP and CED also have a large influence on the other environmental indicators.

$$I_j^* = \frac{d_j^*}{\sum a_j^*} \quad \text{with} \quad d_j^* = \sqrt{\mu_j^{*2} + \sigma_j^2}$$

Equation 4

5. DISCUSSION

Some factors influencing the energy performance (temperatures, thermal bridges, occupancy) are also drivers of the environmental performance. These results confirm the strong influence of energy issues in building LCA. The chosen electricity production mix type has also a strong influence for most of the twelve indicators calculated in novaEQUER because static and dynamic mixes do not have the same carbon contents. For water consumption, the water network efficiency is identified.

In this first study, a limited set of uncertain factors was considered. For instance the influence of factors like transportation of occupants or waste creation during the use phase, as well as the uncertainty due to methodological choices, was not taken into account. Uncertainties in the LCI and LCIA steps were also poorly represented. In a next step, these sources of uncertainty have to be investigated in order to have a better idea of the LCA drivers. Improving the knowledge on the most influential factors could lead to reduced output uncertainty.

Only one alternative of the project was considered but the final aim is to investigate the results robustness, i.e. to look at the possible change in the alternatives ranking. Furthermore, the case study concerns a single house but the method, can be used for a district. Finally, no temporal evolution of the building or its context was considered. In the simulation, the same electricity production mix was used during the entire lifetime. No degradation of the performance due to material wear was taken into account. However, this type of change can influence the environmental performance.

In order to evaluate more precisely the contribution of each uncertain factor, sensitivity indices, like Sobol indices, should be calculated but their computation time can be high when considering many factors. Therefore, it is preferable to conduct first a Morris screening to determine the most influential factors. Then, sensitivity indices can be calculated after having excluded less influential inputs of the model.

6. CONCLUSION

The simulation tool presented in this paper enables to assess the environmental performance of complex systems like buildings and districts. Because different alternatives can be easily compared, it provides a design aid to progress towards sustainability in the building sector.

In order to orient the decision towards more sustainable alternatives, it is necessary to investigate the robustness of building LCA tools. A Morris screening was performed to rank uncertain factors based on their relative influence on the output uncertainty. In this first study, a few uncertain factors were investigated. In this case study, the most influential ones are the electricity production mix, the building lifetime as well as some contributors to the energy efficiency. The results confirm the influence of the energy performance in the environmental performance. In a next step, the influence of more factors will be determined. Then UA analyses will be carried out on comparative LCA to **investigate the results' robustness: the ranking of different uncertain alternatives of a project will be studied**. Lastly this work will be extended to districts.

ACKNOWLEDGEMENTS

This work was performed in the frame of the research Chair ParisTech VINCI **"Eco-design of buildings and infrastructure"**. **A collaboration is organized with ICARE at HUST in Wuhan.**

REFERENCES

- [1] EN ISO 14040, « Environmental management - Life cycle assessment - Principles and framework », 2006, p. 33.
- [2] Peuportier B., 2008, Eco-conception des bâtiments et des quartiers - Presses des Mines, p. 336.
- [3] Sharma A., Saxena A., Sethi M., Shree V., and Varun, 2011, Life cycle assessment of buildings: A review, *Renew. Sustain. Energy Rev.*, 871–875.
- [4] Peuportier B., Thiers S., and Guiavarch A., 2013, Eco-design of buildings using thermal simulation and life cycle assessment, *J. Clean. Prod.*, 73–78.
- [5] **Roux C. and Peuportier B., 2013, 'Evaluation of the environmental performance of buildings using dynamic life cycle simulation', paper presented at BS 2013, Chambéry, August.**
- [6] Peuportier B. and Polster B., 2000, Logiciel EQUER - Simulation du cycle de vie des bâtiments. Mines **School of Paris, Centre d'Energétique, p. 48.**
- [7] Peuportier B. and Blanc I., 1994, « COMFIE - Manuel des utilisateurs ». p. 91.
- [8] Frischknecht R., et al., 2007, The ecoinvent Database: Overview and Methodological Framework, *Int. J. Life Cycle Assess.*, p. 9.
- [9] Guinee J. B., et al. 2001, Life cycle assessment: An operational guide to the ISO standards, Ministry of Housing Planning spatial and Environment (VROM) and Center of Environmental Science (CML), Den Haag and Leiden, p. 710.
- [10] Solomon S., et al., 2007, « Climate Change 2007 : The physical science basis, Contribution of Working Group I to the Fourth Assessment Report of the Intergovernmental Panel on Climate Change, Cambridge University Press.
- [11] Goedkoop M. and Spriensma R., 2000, The Eco-indicator 99: A damage oriented method for life cycle impact assessment, PRé Consultants, p. 49.
- [12] **Heijungs R. and Huijbregts M. A. J., 2004, 'A Review of Approaches to Treat Uncertainty in LCA', paper presented in iEMS, University of Osnabrück.**
- [13] Björklund A. E., 2002, Survey of approaches to improve reliability in LCA, *Int. J. Life Cycle Assess.*, 64–72.
- [14] Peuportier B., 2005, Towards sustainable neighbourhoods, the eco-housing project, paper presented in IV International Conference « Climate change - energy awareness - energy efficiency », Visegrad.
- [15] Lebert A. (coordination), ARMINES - CES, BYCN, CSTB, Fédération maisons de qualité, et IZUBA Energies, 2014, Project ANR BENEFIS, ANR, p. 237.

- [16] Morris M. D., 1991, Factorial sampling plans for preliminary computational experiments, *Technometrics*, 161–174.
- [17] Feist W., 1993, *Passive Houses in Central Europe*, Dissertation, University of Kassel.
- [18] **Munaretto F., 2014, Etude de l'influence de l'inertie thermique sur les performances énergétiques des bâtiments**, Thesis (PhD), Mines School of Paris.
- [19] **Vorger E., 2014, Etude de l'influence du comportement des occupants sur la performance énergétique des bâtiments**, Thesis (PhD), Mines School of Paris.
- [20] INIES online database, <http://www.base-inies.fr/inies/>.

Track 9: Transforming SBE Policies for People

Session 1.12: Regenerating Urban Space in Neighbourhoods

Cultivating a Village Impulse in the Midst of Warsaw, the Jazdów Settlement of Finnish Houses

Dariusz ŚMIECHOWSKI^a

^a Academy of Fine Arts in Warsaw, Poland, dariusz.smiechowski@gmail.com

ABSTRACT

A unique low-footprint settlement with small wooden houses in the **Warsaw's centre has escaped vanishing and enters its new phase.**

It has been perceived in contrasting ways – either as a living structure, a peaceful green enclave challenging the mainstream life, or as an un-modern, shameful village-like insert, occupying expensive land that would be attractive for potential prestigious investment.

The Jazdów's history dates back to the beginnings of Warsaw. Through ages, its prevailing functions related to residential, gardening and curative purposes.

Today's Jazdów Settlement, situated on the former garden and hospital grounds, is a remnant of the larger estate **started in 1945 when housing was scarce for those engaged in Warsaw's reconstruction. The Finnish-made pre-fabricated houses were part of war restitution to the Soviet Union, and brought to Poland to help emergency needs.**

In 2013, the settlement avoided destruction initiated by the previous district authority (tenants pushed-out, homes demolished, eco-niche endangered). Now it has a chance for preservation and balanced development, taking a role of the socio-cultural hub, with limited residential function retained. Some houses are being adapted. Land-cultivation and eco-development impulses are expressed.

There is a chance here to build a transferable model for civic-management. The process of forming a partnership of organizations and individuals (most remaining tenants included) as well as a broader neighbourhood within the institutions in a larger area is led by such values as cooperation and openness.

The research of civic-managed areas across Europe is pursued, with the involvement of sociologists, architects, landscape architects, activists.

Keywords: sustainable neighborhood, generated structures, civic-management

1. UNIQUENESS OF JAZDÓW SETTLEMENT

The Jazdów Settlement in Warsaw is hard to be defined in clear urbanistic categories. It's few hectares' territory is part of a long green stretch of the Vistula Escarpment. The enclave is situated within the complex of city's remarkable parks and is considered as something between an urban village and an inhabited park.

From the point of view of sustainability, its wooden houses, other historic buildings and rich vegetation have formed a niche, where substantial urban interventions should be strictly limited. On the other hand, as being part of the central district of Warsaw, close to the Parliament, government buildings and embassies, it bears the risk of becoming an attractive plot for investment of stereotypically prestigious character. Those who would like this area to be developed in a more intensive way, have their arguments against its village-like features, describing the Finnish houses settlement as being shameful, un-modern, while occupying expensive municipal land. Clear ownership rights, like in a case of Jazdów, are quite rare in Warsaw where much of property, nationalized after the World War II, tends to be claimed back by previous owners or speculators. On the other hand, those who would like to protect the Jazdów's nature and buildings, describe its values as "priceless", non-material. Many even

propose that the existing landscape should be saved “just as it is”, without major changes in its structure and specific atmosphere.

1.1 The place's history, character, atmosphere

The character of the Jazdów Settlement's landscape has been shaped by the morphology of the Vistula Escarpment, the land-cultivation and curative impulses. The identity of Jazdów has always been bound with the core of the history of Poland.

Jazdów dates back to the times of the Dukes of Mazovia's presence (12th-15th Centuries), their castle situated on the cliff, securing a strategic river-crossing nearby to the east. Bona Sforza, the queen of Poland (in the years 1518-1557) had her manor in Jazdów, with an Italian garden. She is famous for introducing a number of vegetable species that are basic attributes of Polish kitchen. In the 18th Century, Jazdów became part of one of the largest urban east-west axial layouts of Warsaw (Stanislas Axis), with sophisticated geometrical compositions, parks, **gardens, residencies. On the today's site of the Jazdów Settlement**, there existed a village (relocated to the main line of the Stanislas Axis around 1780). To this day, the Polish Parliament has the address at Wiejska (Village street).

From 1794, army barracks and hospital brick buildings were developing in the area. In the end of the 19th Century the romantic Ujazdowski Park was laid out on the site of the former military drill square between the main avenue (part of the Royal Route and Calvary Road - Aleje Ujazdowskie) and the hospital grounds. The dominant hospital function remained here till 1944, in its last years serving the war victims. Some of the hospital buildings are still on their positions (three of them among the Finnish houses; one still used as day-care department of the Nowowiejski mental hospital). **In the history of the area's military and curative usage, local gardens served self-sufficiency**, but during the war and until 1951 they were partly used as a provisional burial ground. From the summer 1945, first inhabitants were moving to Finnish prefab houses assembled fast in free spaces of the former hospital site. **Their tenants were mostly architects and builders employed in Warsaw's reconstruction. The new settlement, being a council estate, planned as temporary (for some 5 years), but much of it has survived to this day.** What is remarkable is that the single-family houses from the war period, having the size of huts (about 50-60m² area each) served tenant families well enough to spend most of their lives here. Compared to all other council flats in Warsaw, they were so different; not easy to maintain but very much appreciated and often arising jealousy among those who looked at them as an example of luxurious location in the most attractive city district.

The houses were ready-made, but many of them have undergone transformations. Some were extended according to family needs, in spontaneous but modest variations. Features of this green enclave may be associated with **generated structures of which Christopher Alexander writes in the context of living processes. “ALL the well-ordered complex systems we know in the world, all those anyway that we view as highly successful, are GENERATED structures, not fabricated structures”.**

The houses themselves were, literary speaking, “fabricated structures” in respect to their primary design, but after decades and transformations, they play a subtle role in a generated landscape, where nature has got a dominant role. The houses' special feature is that they could have been called “sustainable”, if this term were used in the time of their construction. This is for many reasons, not only because organic materials were used, but also for their modesty and flexibility to adjust to needs of their users. **To continue the Alexander's language, the Jazdów Settlement, as a whole, would most probably arise “more from the process than from an imagined design”.** There was never any carefully detailed lay-out plan for the Settlement. Some houses were situated in line but mostly in clusters. Modest hedges, low fences and more organised paths came later, when inhabitants felt it necessary to achieve some privacy and protection from intruders. They also wanted to care for their gardens much better than the municipal services could.

One can feel all grades of spaces here – from public to private. Similarities can be found between the Jazdów Settlement and habitats of a similar history in Poland. Comparison can also be made of the atmosphere of Jazdów to the Finnish examples – like Puu Käpylä, the first larger area of wooden prefabricated houses (1926), based on the garden-city models. The other Finnish reference are the same types of prefabricated houses as in Jazdów that are still in a good condition in locations in Finland.



Figures 1 and 2: The landscape characters of Puu Käpylä in Helsinki and Jazdów Settlement in Warsaw.

1.2 Contemporary planning and ideas versus the identity of the Jazdów Settlement

When Poland was recovering from many years of annexation and from 20th Century wars, this part of Warsaw was to play its role in renewal efforts.

Two years before the time Poland gained its independence in 1918, there was a concept drawn for the general plan of Warsaw, in which a large complex of major Polish state administration buildings was proposed on the Warsaw Escarpment in the area of Jazdów. The competition for the Ministry of Foreign Affairs headquarters followed (1926). The entries presented gravely visions exchanging the hospital buildings with monumental edifices. The competition results were met already then with strong criticism in professional circles, as showing the proposed solutions as inadequate for the area. Anyway, the Parliament complex, developing next door, seemed to be a kind of neighbourhood good enough to give way to situate similar functions here. Although there have been **a few major urban ideas or interventions (including decisions now and then to remove the Finnish houses)**, a “real” urban plan for the area has never been elaborated. The French and German embassies (1967-71; 2005-2007) **were supposed to be first to start the “cleaning” of the site (to build the embassies, tens of houses were removed)**. The years 1971-74 marked a major change on the map as the motorway crossing the escarpment and cutting through Jazdów was built, dividing the area and causing removal of another number of Finnish houses.

From the beginning of the Polish transformation in 1989, the area started to draw attention again – as a valuable potential ground for investment. With the end of the communist era, there came the time for independent **architectural and planning practice**. Andrzej Kiciński – architect and urban planner, proposed the formation of the National Park of Art and Culture in the area of Jazdów, as an expression of the idea of the “Agora of Polish Democracy”. **The concept was to preserve some of the characteristic features of the area (small scale, new buildings scattered among greenery)**. Any residential function was excluded though in the concept (the houses meant to be removed). In the year 2012 the municipality decided to take down all the houses and four of them were taken away from their sites for a start (they were later found in pieces in other places in Poland, advertised for sale). The demolition caused protests of inhabitants supported by active citizens. In result, workshops were organised within the framework of public consultations on the future of Jazdów.

The recommendations of the consultations were promising both for the development of citizen-democracy in Poland and the future of the Settlement playing an important socio-cultural role in Warsaw. In 2015, the newly elected district authorities decided, that no more Finnish houses would be demolished, no more tenants removed and that there would be a possibility to enliven empty houses with various activities. First agreements with non-governmental organisations having socio-cultural and ecological profiles, were signed for the period of one year (the time contested by new tenants as too short). In spite of the new decision, promising a new perspective, no clear future for Jazdów, from the point of view of planning, has been inscribed. Nothing is stabilized from the formal longer-term point of view. Aside of actual policies of the district authority, there is an undercurrent of contradictory opinions **among urban planners and architects concerning the Settlement’s future**. The non-governmental organisations are often felt as associated with city-activists who often protect vulnerable areas from over-investment.

The local plan has been in its design phase for years now. Its latest concept has been very simplistic, technocratic, taking neither the genius loci, nor any wider civic-**society's needs into** consideration. It just followed the general **Study, in which Jazdów's destiny is administrative functions, eventually joined by services. In order to be able** to get a realistic input into the local spatial development plan, the architectural and urban design competition has been prepared but not launched. The competition would not solve the problems which are being successfully dealt with on the **grass-root level and according to the public consultations' results, with the perspective that a bottom-up plan could be prepared.**

1.3 The potential gathered in Jazdów over last years

In 2012, as the process of displacement of tenants was pursued and houses started to be taken down, an important role was played by the Finnish ambassador, who even called upon sentimental bondage with his father supposedly working in the factory in which the houses were prefabricated. The working group was co-organised and hosted **by the embassy and the Jazdów's tenants association, to discuss the future of the Settlement, or at least just save** a few houses, where cultural activities would take place. Wider interest arised later on as many houses and gardens opened for activities (exhibitions, talks, meetings, concerts). The openness and inventiveness widened when the Open Jazdów (Otwarty Jazdów) initiative was non-formally established, with many of the houses and gardens coming back to life for a few months of summer. During the following season, the Social Dialogue Square was created in the centre to host music shows, film screenings, etc. Garage sales were organized. An apiary was **situated around one of the houses and the Queen Bona's gardens were in a way re-started.** Some houses and their gardens started to partially re-used. That year was marked by much pressure from the side of organizations **and enthusiasts but there was little activity on the municipality's side.**

Social process once triggered, is encroaching larger and larger areas in and around the Jazdów Settlement. There has been a large potential gathered of activities like workshops, study visits, architecture education activities for youth. Diploma works were made on the re-usage of Finnish houses by students of the situated nearby Interior Design Department of the Academy of Fine Arts. There were landscape architecture workshops of the Warsaw University of Life Sciences. The Faculty of Architecture of the Warsaw Technical University students had their surveying practices and workshops. The results of Polish – Finnish interdisciplinary design workshops on the themes connected **with the visions of the future for Jazdów were shown during the exhibition "Warsaw under Construction". These are just some initiatives, but there have been many more –** adding to the potential gathered for civic-management and bottom-up planning.



Figures 3 and 4: The multilateral communities – the Polish- Finnish working group in 2013 gathered to protect the Jazdów Settlement; the 2015 development of city-gardening (photo: Motyka i Stońce).

The public interest and debate has influenced at least the moods on the side of the official administration body (ZGN; Real-Estate Management Administration) and better relationship with the district authorities developed. The change of approach and increased visibility, meant more tolerance and the change of policy. Cultural and socially-oriented activities are being more and more imprinted in the physical space.

The generated structure, as described by Christopher Alexander, is continuing to develop as a process. Although during last few years not much has changed in Jazdów in respect of its basic structure, there are many examples of spontaneously planned and realised interventions. Some houses got new users, their surroundings got new

community gardens, some garden spaces that were “semi-privatized” are becoming still more open. There are projects realized, but until there is a more clear urban development plan, it is not possible for the new tenants (non-government organisations) to invest much in the renovations.

2. THE PERFORMANCE OF JAZDÓW SETTLEMENT

The Jazdów Settlement's everyday users can be recognized as groups having differentiated interests and rhythms of activity (residential, educational and socio-cultural, curative, gardening, recreational, administrative). There are 27 Finnish wooden houses, 7 of them still inhabited by the tenant population of about 20 persons. Inhabitants of the council flats (Finnish houses) are more or less integrated into the local community as a whole. There has never been any solid survey done, nor any research on the technical performance of the Settlement. Basic city services are in place, with the exception for heating and hot water. These were left to be solved by inventive users, usually adopting traditional wood or even coal burning stoves and electric devices. Some houses have been additionally insulated, although a larger number of them are just left as they used to be from the time they were erected – with **a thin layer of fibreboards in the walls. The present purpose of efforts to overcome the Jazdów Settlement's crisis** of becoming dysfunctional, is to fill all the existing structures and gardens with activities and not to lose the all-time inhabitants.

2.1 Striving for sustainability versus temporary status

The brick buildings in the Jazdów Settlement's area are listed (remnants of the former hospital). It does not mean they are under a real protection, being maintained in a proper way, but at least they cannot be demolished in the **face of law. The Finnish houses are devoid of any conservator's protection. Some of them have been cared for by their tenants, some neglected. They are “poor by their nature” and it has always been like this with wooden** structures in the Polish history. There is scarcity of timber structures, especially in Warsaw. On the other hand, the Finnish houses have their own extraordinary chance as they can be understood more as belonging to the organic and non-urban world and thus being a rarity. The other advantage is that they are characterized by natural dynamism of changes, mobility, diversity – the features looked for, when sustainability is striven for.

2.2 Election of study case

The danger of neglect and destruction on one hand and the grass-root efforts to protect the Jazdów Settlement on the other, brought many like-minded individuals and organizations together. Most of inhabitants feel connected with new initiatives but there are also some that protect their privacy still more. Both strategies are set for survival. Now, there are tens of organizations either using the houses and gardens or preparing to use them for their statutory aims. The topics tackled are such as: sustainability and ecological lifestyle (low footprint; assessment methods and optimization in planning), heritage protection, city-activism, continuation and development of therapeutic character and functions of the area (development of city-gardening), cultural and educational initiatives (with a possibility to cooperate with local schools and kindergartens, with the hospital, neighbouring embassies and public institutions), sports, scouting, cooking with refugees or folk music. There are possible exchanges and coalitions with similar territories (areas or enclaves protected and developed by local communities). There is also a collaboration developing among the institutions within the city district of Ujazdów, in which the Open Jazdów (Otwarty Jazdów) as the Partnership for the Jazdów Settlement is an active member.

3. THE PARTNERSHIP FOR THE JAZDÓW SETTLEMENT

In the last years, the activities of the community that gathered in and around Jazdów had a character of a coalition. In 2015, the Partnership for the Jazdów Settlement was formed as an informal group of interest, gathering the interested individuals, institutions and organizations, with the hope to work with many issues concerning the everyday management in a grass-root way and hopefully in cooperation with the municipality. There are a few working groups: Environment and Building, Social Economy, Civic-management, Culture and Education. The Partnership has a chance to work out a model of such management and advocacy for the Settlement that would fit most its character and enhance the community spirit. The initiatives would not have a chance to develop this way without one person – a dedicated young inhabitant (Andrzej Górz).

3.1 Research into urban autonomies, to work out the governance model

The Jazdów Settlement has a chance for experimenting a certain autonomy, not having to depend on questions of land ownership. Uncertainty concerning the future plans of the land-owner (**“the city”**) is an understandable problem though. The fact that the land belongs to the municipality (meaning everybody) may be treated as disadvantage on one hand, but an advantage on the other (as far as there is dialogue, understanding and will to work out a common set of values). For the city administration and services, such a kind of settlement has always **been an uneasy case to deal with. The routines are often not in tune with the area’s specific character and this is** not only the problem of Jazdów. It has been suggested by the Partnership for the Jazdów Settlement that all projects concerning public space improvements or just changes within the public spaces in this area were postponed until a general concept or the awaited local plan are worked out. To find the best civic-management model, the study supported by the European Culture Foundation has been launched. Its goal is to research the similar cases in Europe in order to develop a practical formula for cooperative, cross-sectoral, community-based management for the Jazdów Settlement. The research phase is to choose and analyse the best practices of creating and functioning of community managed entities (the best if having a special legal status compared with such as those of cooperative housing, trade cooperatives, allotments, etc.). The development phase is to bring together partners from the municipality of Warsaw and other foreign as well as Polish partners, to tailor two solutions: the model of management for the Jazdów Settlement and the regulations for the City of Warsaw that would allow for collaboration between the municipality and the Jazdów Settlement, to sustain Jazdów in the long term.

The study is to find out what experiences are possible to share between similar places-initiatives (specially of a certain level of an urban autonomy). The criteria were set to compare the Jazdów Settlement with other places of similar character:

- inhabited (a least to some extent); - physical space larger than one building; - diversity and accessibility; - growing out of civil society initiatives; - the property status regulated; - the managing organization diversified, multi-sectoral; - the activity agenda accessible to all, with a character of public mission; - transparent (everybody may participate or follow the processes); - sharing-economy elements included;
- an ecological agenda (self-sustenance, renewable energy, ecological education).

3.2 Jazdów as a possible expression of citizen democracy

A few inhabitants of the Jazdów Settlement were not representative enough to be recognized as a citizen group to **have a strong, valid voice. They seemed easy to be dealt with, when the “clean-up” policy was implemented.** Scared and unable to react, while the steps of the municipal authorities were offensive and consequent. There were losses as some houses were taken down and a number of inhabitants have left the place. Fortunately, some of them proved to be able to stay. It seemed natural that a larger community would soon gather around those endangered as the place itself having this particular character proved to be needed by a larger population. In result a shared feeling of ownership, as well as strength of togetherness have developed.

3.3 Conclusion: would the model of Jazdów be transferrable?

The partnership model for a unique generative structure like the Jazdów Settlement is aimed at sustainability in everyday practice. Active communities characterized by openness and diversity have a chance to perform as hubs of urban knowledge and experience. If only they are allowed to survive and – still more – supported to develop, their feedback, or rather their mission, may be to influence the basic city policies and help with their implementation, as well as transfer the achieved results further on. Multilevel urban governance, and especially the community governance methods may be enhanced if civic-managed areas are allowed to flourish. The research in civic-management and experiences of the Jazdów Settlement shows that citizen empowerment may still become stronger through the art of working together in a challenging situation of a village-like settlement in the middle of the city. It is possible that small communities (autonomous to a certain extent) and municipalities may come to agreements in order not to govern in a schematic way but to cooperate, allow for a free flow of exchanging ideas, knowledge, experiences.

REFERENCES

- [1] Alexander C., 2002, The process of creating life, The Center for Environmental Structure, pp. 171-180.
- [2] Latkowska A., Pogoda I., Rokita Z., Sienkiewicz M., **Wilczyńska A., Zielińska E. 2014, Konsultacje społeczne w sprawie przyszłości i form funkcjonowania terenu Osiedla Jazdów**, Raport z warsztatów i prezentacja koncepcji wypracowanej przez uczestników (Public Consultations concerning the future and performance of the **Jazdów Settlement's area**. Report from workshops and presentation of the concept worked out by participants), The City of Warsaw [online]. Retrieved from: http://issuu.com/miastodwa/docs/jazd__w_-_raport_finalny [Retrieved on 13 October 2016].
- [3] Pracownia Etnograficzna (Association) 2015, The website on Finnish Houses in Warsaw [online]. Retrieved from: <http://domkifinskie.etnograficzna.pl/> [Retrieved on 13 October 2016].
- [4] Grisel M. & van de Waart F. 2011, Multilevel Urban Governance or the Art of Working Together, European Urban Knowledge Network.

Productive Transforming of the Urban Traffic Space

ZHANG Yukun^a, HAN Dan^b, ZHANG Rui^c

^a Tianjin University, Mainland China, zyk.tj@163.com

^b Tianjin University, Mainland China, 616842764@qq.com

^c Tianjin University, Mainland China, zhangrui_tianjin@hotmail.com

ABSTRACT

The development of productive transforming of urban transport land has got more and more attention. And We divide it into three categories, the first one is three-dimensional and efficient use of transport land to conserve land resources; The second is the fuse of traffic space and its other neighbouring urban functions to achieve efficiency multi-functional mixed land use; And finally, it is the integration of traffic space with urban productive space directly that not only can achieve efficient use of mixed land, but also provide a more direct way for the sustainable city. Currently, the research and practice for the first two phases have been fruitful, but the research of the last one is still in its initial stage or under exploration.

The paper attempts to analyze the technologies of transport production. If divided from transport space's type, these technologies can be divided into three types. The spaces on two sides of the road and especially the large-area road buffered region or idle land can carry out more types of energy production technologies, including renewable energy utilization and agricultural cultivation. Finally, we analyzed New York landscape architects Starr Whitehouse's three concepts of the Brooklyn-Queens Expressway to show three categories of transport production.

Keywords: traffic space, productive, energy, agriculture

1. INTRODUCTION

Transport is an important link that connects the multiple functions of land use. However, the environment created **by urban transport, as the process space that connects the beginning and ending of people's daily life, is often neglected by people in planning and constructions. Everyone will contact and feel the "third space" of a city**—the influences of the urban transport environment on citizens are non-neglected. In *The Death and Life of Great American Cities*, there is one paragraph that perfectly expounds on this opinion. A city sidewalk by itself is nothing. It is an abstraction. Streets and their sidewalks, the main public places of a city, are its most vital organs. The massive energy consumption and land waste have a serious effect on the environment of urban traffic. The urbanization of China has consumed as many as 40 percent of cement and over 50 percent of steels in the world. As the basic infrastructure of urbanization, urban traffic has emerged as one of those sectors consuming the most energy in China. The automobile powered by the gas and diesel have contributed about half of the emission of carbon monoxide and nitrogen dioxide in the atmosphere. The development of electric vehicles in recent years can relieve the pollution caused by urban traffic to a certain extent. However, it should be noted that the electricity is still used as the source of secondary energy in China. China is heavily reliant on the burning of coal, which will result in more pollution. Hence, the key to easing the pollution in the urban environment should lie in the development of renewable energy. Due to the mind-set that building more roads can help to deal with traffic congestion, the area of the land used for urban traffic has been on the increase. It turns out that traffic congestion has become an increasingly more serious issue. Many experts on urban transport in the USA and Europe believe that most of the space for urban road in China has not been fully utilized. If some appropriate actions can be taken, the traffic capacity will be increased by 30 to 50 percent.

In a word, the environment of urban traffic is faced with many problems, including the urban structure lacking the connectivity, the constraint on urban vitality, the huge energy consumption and the low efficiency of land use. With the purpose of solving those problems, further efforts can be made to combine urban traffic with production city. It can fully realize the urban potential for production, which will also provide a new solution to the urban sustainable development.

2. ANALYSIS OF PRODUCTIVE

The developmental process of the human society has undergone the separation from traditional production functions from the city. To change the problems by the current city's emphasis consumption and enable the city to achieve more sustainable development, the concept of productive is being emphasized once again and returns to city. Such a production is not limited to agricultural production, yet it includes richer connotations.

By absorbing experience from foreign theories and combining the author's conclusions and thoughts, Professor Zhang Yukun of Tianjin University of China attempts to set up a theoretical system of "production city" that has richer connotations. "Production city" is a multiple-layer urban-town system that takes green production as the main characteristic and integration; by using the basic means of reservation, replacement, superposition, integration and reconstruction, attempts to establish a perfect industrial structure within the most appropriate region, which provides new thinking for a city's sustainable development. Such urban planning concept emphasizes the active "production" functions of a city, and incorporates the "saving" function that is traditionally considered as passive into the "production city" theoretical system. It is thought that "saving" is also a type of "production" from a certain perspective.

The intensive utilization of land and space can be referred to as a production function of the space. To a certain extent, the integration of urban transport and architecture can realize the spatial production of urban traffic system. But in most cases, the compensation has been confined to the urban traffic or the area surrounding the transportation junction featured by the frequent change of means of traffic. The majority of the linear urban road can not directly combine with architecture space, but there is still some potential for production function. If the urban roads which have been neglected can be fully utilized for the production of space, it will create huge benefits for the sustainable development of the city.

3. CLASSIFICATION OF PRODUCTION OF TRANSPORT SPACE

The productive urban transport can be divided into three types: From the perspective that saving is a type of production, the efficient land use of transport is productive; secondly, the complex land use of urban transport space improves the efficiency of land use; the third type is directly integrating the space of productive functions and transport spaces, which has become a completely new means of reforming the transport space.

3.1 Efficient land use of transport itself

As early as the Renaissance, Leonardo da Vinci proposed the thinking of "the system of pedestrian and roadway 3-dimensional dividing". German planner, Ludwig Hilberseimer, proposed the 3-dimensional transport plan that different planes divide the human traffic and vehicle traffic. In the current day that emphasizes green traveling, people are trying to use the complex transport space to improve the utilizing efficiency. Comprehensively utilizing the urban road space and especially the urban road underground space is one of the important means of efficiently utilizing urban road space.

The TransGlide 2000™ Bicycle Transit System is a new strategy in bicycle transport. This technology increases the efficiency of the bicycle by providing an environment within which bicyclist can ride comfortable, making the bicycle a faster, safer, less expensive, and more convenient mode of transport in urban areas. STS's Transglide 2000™ bicycle transit system has many advantages. (Figure 1)



Figure 1: The TransGlide 2000™ bicycle transit system (<http://www.bikeplans.com/gallery.html>)

3.2 The mixed-function land use of transport

One of the urban transport's roles lie in connecting various functional spaces within the city, so that people can come and go more conveniently and effectively. The current cities attach unprecedented attention to transport, yet the wide and dense roads bring more trouble to the crowds that go through the city. This is because these traffic facilities cut the city's continuity, forcing various functional relations in the city to be more distant instead of being denser. An increasing number of architects, planners and landscape designers have already noticed the problems existing in the urban transport and thought about the new urban transport space. They attempt to establish closer relations between the urban transport and the architectures & landscape with various urban functions. They even integrate these two into one. The urban transport space can be carried out smoothly and safely. It can also be abundant, interesting, comfortable and enjoyable. In the 3-dimensional urban spatial coordinates, the transport space can be inserted with the architectural space through various dimensions and stacked up.

The student of British Bartlett School of Architecture, Alex Sutton, proposed a new concept in his graduation work— In the future, airports do not need to be constructed in the suburbs and airplanes can take off over the street. The future airport should be one part of the city. (Figure 2) Such a designing that transport fundamental facilities will be dissolved into cities attracts full attention and affirmation from people. It can be seen that the integration of urban transport and a city's other functions is very necessary.



Figure 2: Concept of future airport (Alex Sutton, 2016)

3.3 The combination of transport and production

If the concept of productive space is introduced into the transport space, it will achieve the sustainable development of urban transport to a larger extent and bring unexpected social, economic and ecological benefits.

Solar Serpent is a case involving the land use of transport for energy production. Developed by the Mans Tham who is a Swedish architect and urban planner, it is a device which can provide energy for the expressway by making use of solar power. In 2010, the design was unveiled at the Summit Conference of Major Cities of the World held in the University of California, Berkeley. Because the traditional solar power generation occupies a large area of land, the limitation of land resource has become a major constraint on the utilization of solar power. If the upper space of the expressway stretching for about 800 kilometers can be utilized for solar power generation on a large scale, it will save the land greatly. Moreover, Solar Serpent also has many advantages. Firstly, the most

direct advantage of utilizing renewable energy is to reduce the emissions of harmful gases. Besides, when the transport system carries out energy production, using the spaces over and onee both sides of the road may have **some indirect advantages of this transport system's** energy conservation. For example, setting up the solar PV panel up the road can effectively block the radiation of sunshine on the road, lengthen the life of the road and lower the costs of maintaining the road. It also plays a certain role of promoting **the transport tool's energy conservation on the road. The solar panels on the road can block solar radiation for driving automobiles and prevent the AC's** energy consumption caused by rising temperature within the vehicle in summer.

If a city can carry out agricultural production, it can not only solve the pressure on agricultural production brought **by the rural population's migration, but also make the urban life more comfortable and ecological, which alleviates** the urban problems brought by urban expansion and prevent reverse-urbanization phenomenon to some extent. The urban transport land use is a type of land that accounts for a high proportion in urban land. It needs to take the transport greening and buffered land as affiliated land. If we can fully utilize the scattered land for agricultural production in these cities, it not only can solve the grain problem to some extent, but also plays a certain ecological role in the urban transport. It also brings more attractive landscape outcomes for urban residents' **traveling.**

4. TECHNOLOGIES OF TRANSPORT PRODUCTION

Energy harvesting technologies from road infrastructure is a new research territory that encompasses technologies that capture the wasted energy occurred at pavements, accumulate and store it for later use. Eventually, the paths of gathering energy still depends on various scientific technology, such as nano-science, electrical science, machinery and environmental engineering. These technologies can be applied into transport panning and transport infrastructure facility construction. New technology will bring new thoughts for transport planning. It is also necessary for urban planning designers to get to know and master these technologies.

We can find out that these technologies can be divided into asphalt solar collectors combined with pipes; photovoltaic applications (PV); piezoelectrical and thermoelectrical generators; induction heating and; phase change materials and nano-materials. **If divided from transport space's type, these technologies can be divided into three types: on two sides of the road, on the road's surface and over the road. If fact, the spaces on two sides** of the road and especially the large-area road buffered region or idle land can carry out more types of energy production technologies. (Table 1) These technologies are not restricted by the transport space and only utilizes transport land efficiently. Therefore, they are not enlisted in the statement, including renewable energy (solar energy utilization, wind energy utilization, biological energy and other renewable energy) and agricultural cultivation.

Traffic Space	Energy Harvesting Technologies
Side Space	PV-Noise Barriers Piezoelectric Sesnsors PV-V2G
Surface Space	Induction Charging Nanomaterials Phase Change Materials TNO PV Canopies
Upper Space	Asphalt Solar Collector/Hydronic PV Bridge Roofs

Table 1: Comparing the energy harvesting technologies applied to different traffic space

5. CASE ANALYSIS

Brooklyn-Queens Expressway(BOE) was completed in the 1950s. A lower groove was used to change the twisting lines at the upper layer, which could ease the traffic congestion at that time. The BOE which was built had divided the physical surrounding into two parts. It also formed an unnatural boundary between them by splitting and even damaging the surrounding environment. The existing roads which connected sidewalk and pedestrian overpass were not wide enough to satisfy the needs. In addition, the overly high speed of those vehicles on the road would

pose a hazard to human safety. With the automobile exhaust and noise pollution of BOE spreading to those communities around, it had affected the life of local residents.

New York landscape architects Starr Whitehouse came up with three concepts to improve the Brooklyn-Queens Expressway, the first concept called Maximum Green, the second one Connections, and the last one Green Canopy. **These three concepts explain the transport space's production from three aspects. (Table 2)** In Concept 1, maximum green is one designing of utilizing transport and mixed-function land use, fully utilize the road's buffered space and carry out greening or grow agricultural plants. In Concept 2, connotation is a highly-efficient utilization of the transport space and a transport designing of carrying out 3-dimensions on limited land area. It adds more relations on the original roads to alleviate the division of transport on the city's original fabric. In Concept 3, green canopy is the designing of integrating transport and production, which achieves the integration by combining the PV panel and green integration. As shown in the survey, the transformation elements in the first two concepts have been recognized. The Concept 3 has won the most support from the community. In other words, the community can well accept the combination of urban traffic environment and production city. Instead of broadening the road to improve the environment on the two sides of the road, BOE Enhancement Project has resorted to increasing the area of green land and creating more connections. A variety of methods have been employed to make the urban transport more public and human-centered. It has combined the urban transport with the community more effectively. What is worth mentioning is that Green Canopy has successfully introduced production function into the transformation of urban traffic environment. Hence, it has solved those problems faced by the base quite well.



Concept	Benefits	Drawbacks
 <p>Concept1 Maximum Green</p>	<ul style="list-style-type: none"> ● Slow traffic ● Shortens crossing distances by 11 feet ● Adds 6500 square feet of pedestrian space ● Adds nearly 1 acre of plantings and 412 new trees ● Employs innovative storm water capture and reuse system ● Optional to reduce noise at street level. 	<ul style="list-style-type: none"> ● Limited noise reduction ● Does not increase accessibility ● Parking would be substantially limited and would require heavy enforcement
 <p>Concept2 Connections</p>	<ul style="list-style-type: none"> ● Reconnects severed cross streets ● Increases connectivity for neighborhood ● Slows traffic ● Adds plantings,trees,and storm water management system ● Optional to add up vines ● Potential for solar cells income 	<ul style="list-style-type: none"> ● Limited noise reduction on Hicks Street ● Expense of each bridge
 <p>Concept3 Green Canopy</p>	<ul style="list-style-type: none"> ● Visually screens the highway ● Adds 100000square feet of vines ● Reduces noise by 9 decibels at street level ● Potential for income from photovoltaic panels ● Reconnects severed cross streets ● Slows traffic and manages storm water 	<ul style="list-style-type: none"> ● High cost ● Major construction on Hicks Street

Table 2: Comparative analysis of three concepts

6. CONCLUSION

The research on the transport space's production can determine the transport system's green production from the quantitative perspective, which plays a certain role in promoting the society, economy and environment. Besides, it also has many research values and meanings.

The power generation for urban traffic system is of significant meaning to easing the shortage of power supply. With the drain of conventional fossil energy, new energy should be found to satisfy the growing demand for urban energy. As a type of new energy which is not exhaustible, the renewable energy has the advantages of huge

reserve and clean production. Hence, the renewable energy can be utilized in the traffic system so as to reduce the use of fossil energy and air pollution. The electricity produced can integrate with the urban power grid, thus **satisfying those urban residents' need for electricity. The agricultural production of traffic system can infuse new vitality to the dense urban space with the simple function.** To a certain extent, it can also ease the over-concentrated function of urban space, tackle the traffic congestion and reduce the urban pollution. The plants can also improve the urban micro-climate and ecological environment by absorbing the carbon dioxide through the photosynthesis. All of those functions must be realized based on the urban traffic system. The greatest advantage is that it can achieve the intensive utilization and production without occupying a large area of urban land. For the urban planning, it is necessary to consider various production measures and functions at the beginning of the planning, carry out overall planning and coordination of various urban spaces, including production, transport, living and entertainment. It is also necessary to analyze the space that sunshine can radiate and the land space with fertile soils, so as to reach the aim of achieving resource, energy and production to the largest extent. The aim and **procedures of the transport system's green production have reforming changes and meanings, which make people consider more influence factors and involved aspects in the urban planning.**

REFERENCES

- [1] Elkind, Ethan, 2009. In Our Backyard: How to Increase Renewable Energy Production on Big Buildings and Other Local Spaces. UC Berkeley/UCLA Schools of Law, Bank of America Policy Paper, Berkeley .
- [2] Xun-chu Xu, 2005. Urban road and traffic planning. Chinese Building Industry Press, Beijing.
- [3] Forman R T T, 2003. Road Ecology: Science And Solutions. Ecology.
- [4] Bill Holdsworth, 2003. Solar energised roads and infrastructures. Refocus, 4(3),58-60.
- [5] Sharma P, Harinarayana T, 2013. Solar energy generation potential along national highways. International Journal of Energy & Environmental Engineering, 4(1),1-13.
- [6] Zhao H D, Ling J M, Fu P C, 2013. A Review of Harvesting Green Energy from Road. Advanced Materials Research, 723,559-566.
- [7] Kreminski R, Hirsch A H, Boand J, 2011. Assessment of Colorado Department of Transportation Rest Areas for Sustainability Improvements and Highway Corridors and Facilities for Alternative Energy Source Use. Cost Effectiveness.
- [8] Andriopoulou S, 2012. A review on energy harvesting from roads. Teknik Och Teknologier.
- [9] Kirkegaard J F, Hanemann T, Weischer L, et al., 1967. Toward a Sunny Future? Global Integration in the Solar PV Industry. Surgical Clinics of North America, 47(1),49-60.
- [10] Sharma P, Harinarayana T., 2012. Enhancement of energy generation from two layer solar panels. International Journal of Energy & Environmental Engineering, 3(1),1-9.
- [11] Ong S, Campbell C, Denholm P, et al., 2013. Land-Use Requirements for Solar Power Plants in the United States. Office of Scientific & Technical Information Technical Reports.
- [12] Sieyoung. Bicycle Bridge Design as Green Road. IFLA (International Federation of Landscape Architecture) - APR (Asia Pacific Regional).
- [13] **Jaffery S H I, Khan H A, Khan M, et al., 2012. 'A study on the feasibility of solar powered railway system for light weight urban transport', paper presented at the Proceeding of World Renewable Energy Conference, Denver, May.**
- [14] **Castaneda S M, Mori J D., 2011. 'Sustainable "Green" Transportation Systems: Integrating Renewable Energy Technologies into Automated Fixed Guideway Systems', paper presented at the 13th International Conference on Automated People Movers and Transit Systems, Paris, France, 22-25 May.**

Nature-based Urban Space Transformation

Kristin BARBEY^a

^a Karlsruhe Institute of Technology, Germany, kristin.barbey@berlin.de

ABSTRACT

Climate change and climate impacts require in consequence of their anthropogenic causes a changed handling of space and nature. The objective of this research project is to develop a consistent Integrative Spatial Concept towards a Nature-orientated, Climate-friendly Metropolis 2050, looking for the best place to implement most efficiently the different measures of Climate Protection and Adaptation in the urban and regional context. The Concept of Interacting Strategies: Nature Development and Urban Restructuring and Energy Transformation and The Principles of Connecting and Interacting within a participative process present a path of spatial sustainability in an ecological, aesthetical and sociopolitical regard. The Project Nature is the content base of the Integrated Spatial Conception Climate Protection and Adaptation and the objective of all spatial decisions.

The special challenge in the realization of spatial strategies for Climate Protection and Adaptation and in the success of the transformation is about The Principles of Connecting, Cooperating and Interacting. The upcoming tasks will only be accomplished through a common Societal Act of Solidarity.

Finally the paper questions the transfer of the presented local and regional strategies to the mega-urban level and demands a new Transdisciplinary Thinking considering the entire body of a Megacity.

Keywords: Integrative Spatial Concept Climate Protection and Adaptation, Project Nature

1. INTEGRATIVE SPATIAL CONCEPT CLIMATE PROTECTION and ADAPTATION

Out of the overview of already established concepts in European metropolitan regions and due to the analysis of recent research results in climate change and spatial development, forestry and energy science, space and water management, planning theory and nature philosophy, The Concept of Interacting Strategies:

Nature Development and Urban Restructuring and Energy Transformation on every spatial level and scale: Region and City and District and Quarter and House is developed, including the essential theoretical basis for the spatial conception. (Barbey 2014, 50) Within the conception of The Integrative Spatial Concept, the question of the theoretical basis for spatial design and decision-making processes is fundamentally important as well as the definition of priorities and the consideration of spatial effects within the integrative setting of different strategies with the aim to achieve spatial sustainability even in an aesthetical sense. (Barbey 2012, 7-9)

1.1 The project nature

The content basis of the spatial concept, developed in this research project, is the Project Nature. The recognition of the anthropogenic responsibility for global warming and the related climate impact as observed by the IPCC 2007 and 2014 demand the change of the previous form of anthropogenic spatial use (e.g. CO₂ emissions → atmosphere) in expression (e.g. CO₂ emissions) and development (e.g. land use). Climate change and climate impacts require in consequence of their anthropogenic causes a changed handling of space and nature. (Barbey 2014, 50) The content basis of the spatial concept: the Project Nature, starts with the basis of the climate change problem: the way of handling nature. The anthropogenic (man-made) causes of climate change besides natural effects of loss of genetic diversity, species and ecosystems results in a major part on the ignorant way to treat nature: nature has to take up a central position within the discourse and the conception of future spatial development perspectives. (Barbey 2012, 8)

The Project Nature signifies the theoretical background and conceptual basis of the spatial concept and represents within the setting of the Spatial Strategies Climate Protection and Adaptation, the strategic objective for the spatial decision. All represented spatial strategies (Nature Development and Urban Restructuring and Energy Transformation) are orientated according to the Project Nature. In the process of the Integrated Spatial Conception, the orientation on the strategic aims of the Project Nature is of primary importance for the development of future

decisions in dealing with space. The Project Nature includes the qualification of ecological potentials, the stabilization of ecosystems and the renewal of existential space substance. The principle of the ruthless use of natural resources (e.g. CO₂ emissions → atmosphere), as the actual cause of the expected damaging effects of anthropogenic climate change, must be turned into the principle of saving, protecting and developing nature. It is the fundamental project to secure the human existence and maintain decent living conditions as well as to sustain actively Climate Protection and Adaptation. Climate protection, climate adaptation and energy transformation have to be placed on every spatial level and scale. To develop a Nature-orientated, Climate-friendly Metropolitan Region the following strategies are essential: Nature Development and Urban Restructuring and Energy Transformation. The Concept of Interacting Strategies: Nature Development and Urban Restructuring and Energy Transformation has to be developed in the local and regional context on all spatial levels: Region and City and District and Quarter and House. (compare Barbey 2014, 50)

The Project Nature is inspired by the German philosopher Gernot Böhme, who explains in “Die Natur vor uns” (“Nature ahead of us”): **The challenge to mitigate climate change and to adapt to its impacts lies ahead of us, as well as “to recognize the state of nature as a common task”. “This signifies not only the conservation of nature as something given, but rather the establishing [or development] of nature, even a state of nature, [...] that provides a humane existence in foreseeable future. [...] Nature lies ahead of us: as a challenge”, “Nature has become finally [...] a project.” (Böhme 2002, 10-26-28)**

The process of urban development, which usually begins by the setting of building - and Infrastructure into the open space, should now start from the consideration of the natural conditions (invers). Urban development should be orientated, adapted and integrated to the natural, climatic, and geographical conditions of the site in the local and regional context. The globally accepted philosophy of sustainable development does not provide a profound response to the quintessence of the essential question of our century: the human relation to nature. The fundamental philosophical and ethical basis for a changed handling in respect of nature is needed to give a contemporary societal orientation by a forward-looking explication of the human relation towards nature. **Essential aspects of “the respecting appreciation in contrast to the annexation or exploitation of nature” are mentioned e.g. by the German philosophers Martin Seel and Jürgen Habermas, who describes “the immediate aesthetical perception of nature as the essential premise of the potential appreciation of nature”. (Habermas 1997,99)**

1.2 Aesthetical principles

With the intention of combining ecological and aesthetical aspects in the spatial qualification of the metropolitan area, aesthetical principles are defined in addition to the mentioned ecological principles of the Project Nature, which are in the consideration of the integrative spatial concept of adequate relevant importance. These aesthetical principles orientate the design and the decision making process of the spatial setting to a substantial aesthetic level and represent basically the spatial principles of Concentration and Protection as well as the paradigm of the 21st century towards a sustainable development related to a changed handling of space and nature: Ressource Saving and Energy Efficiency. (Barbey 2014, 50)

2. NATURE-ORIENTATED, CLIMATE-FRIENDLY METROPOLITAN REGION

Applying this content basis and reflecting the particular site-specific consideration such as natural geographical and urban spatial, climatic and energetic parameters, the Integrative Spatial Concept is developed for the metropolitan region Rhine-Neckar with a view to achieving a Nature-orientated, Climate-friendly Metropolitan Region Rhine-Neckar 2050 (Figure 1). This research project is an exemplary attempt to develop a consistent spatial concept relating to the Metropolitan Region Rhine-Neckar (5.640 km², 2,4 Mio. inhabitants, the warmest region in the south-west of Germany with projections of increasing heat, rain and flood events, dense polycentric urban structure of cities as Heidelberg, Mannheim and Ludwigshafen and villages in a diverse open space and landscape structure, important universities and highly industrialized urban poles situated in a beautiful Rhine-valley landscape framed by hilly Palatinate and Odenwald forests, confluence of Rhine and Neckar) and the City of Mannheim (145 km², 300.000 inhabitants) looking for the best place to implement most efficiently the different measures. As an informal planning instrument, the Integrative Spatial Concept could be the basis for discussions and civic participation with the intention to support the spatial realization of the climate protective and adaptive transformation. (compare Barbey 2014, 50-51)

The design and the decision making process of the spatial concept is furthermore based on the results of different regional studies and some interesting aspects in existing urban and regional concepts. Combining the knowledge and database of transdisciplinary regional research (climatic, demographic and spatial development, forestry and energy science, space and water management, planning theory and

<i>Nature Development 1</i>	<i>Forest transformation and forest development</i>	<i>Climate Adaptation and Protection</i>
<i>Nature Development 2</i>	<i>Protection & development of open space</i>	<i>Climate Adaptation</i>
<i>Nature Development 3</i>	<i>Development of inner-city green space</i>	<i>Climate Adaptation</i>
<i>Nature Development 4</i>	<i>Room for the river</i>	<i>Climate Adaptation</i>
<i>Nature Development 5</i>	<i>Groundwater protection</i>	<i>Climate Adaptation</i>
<i>Nature Development 6</i>	<i>Organic farming</i>	<i>Climate Protection & Adaptation</i>
<i>Urban Restructuring 1</i>	<i>Development of the inner-city</i>	<i>Climate Protection & Adaptation</i>
<i>Urban Restructuring 2</i>	<i>Development of the existing building stock</i>	<i>Climate Protection & Adaptation</i>
<i>Urban Restructuring 3</i>	<i>Energetic urban renewal</i>	<i>Climate Protection</i>
<i>Urban Restructuring 4</i>	<i>Climate-friendly and water-sensitive urban development</i>	<i>Climate Protection & Adaptation</i>
<i>Energy Transformation 1</i>	<i>Spatial concentration of wind turbines</i>	<i>Climate Protection</i>
<i>Energy Transformation 2</i>	<i>Urban concentrated use of photovoltaic</i>	<i>Climate Protection</i>
<i>Energy Transformation 3</i>	<i>Use of regional potentials → geothermal energy</i>	<i>Climate Protection</i>
<i>Energy Transformation 4</i>	<i>Use of regional and local potentials → bioenergy</i>	<i>Climate Protection</i>
<i>Energy Transformation 5</i>	<i>Use of regional potentials → hydraulic energy</i>	<i>Climate Protection</i>
<i>Energy Transformation 6</i>	<i>Expansion of public transport & climate neutral mobility</i>	<i>Climate Protection</i>
<i>Energy Transformation 7</i>	<i>Expansion of the electricity network and energy storage</i>	<i>Climate Protection</i>

Table 1: Spatial strategies, principles and synergies climate protection & adaptation

nature philosophy) as well as discussing and verifying the most efficient position (even in an aesthetical sense) for every measure in the local and regional context (compare Barbey 2012, 7-8-9), the spatial concept shows, which appropriate strategies for climate protection and adaptation should be placed where and at which place such measures could be concentrated to advance Climate Protection and Adaptation and to realize the processes Nature Development and Urban Restructuring and Energy Transformation actually on a grand scale. The catalogue of strategies, which could be considered as a kind of Roadmap 2050 Climate Protection and Adaptation for the Metropolitan Region Rhine-Neckar, is considered to be forward-looking. (compare Barbey 2014, 51)

2.1 Recommendation for actions in metropolitan regions

In the sum of the interactive strategies Nature Development and Urban Restructuring and Energy Transformation, for which the effects can be approximately valued on the results of recent scientific reports, 50% energy can be saved, 70% CO₂ emissions can be reduced and 100% of the electricity demand can be covered by renewable energies in 2050. The Integrative Spatial Concept shows the potentials of Climate Protection and Adaptation, the focus of strategies and the combination of measures and their interacting effects and synergies. It represents concentrated activity of priority action areas as well as challenges of local and regional interaction. It locates the objectives Climate Protection and Adaptation and formulates the idea Nature-orientated, Climate-friendly Metropolitan Region 2050 as a common task for local stakeholders and the metropolitan society with a concrete time frame. In the general view of the integrative spatial concept a self-evident picture is developed within the implementation of the different measures. The conception of the spatial setting of the strategies in the plan seems partly self-evident, which is caused by the exact consideration of the site-specific geographical reference and about the Where and How of the integration of measures in the spatial context. The spatial effects of the strategies serve besides Climate Protection and Adaptation to substantial improvement of ecologic and spatial aesthetic qualities. (compare Barbey 2014, 51)

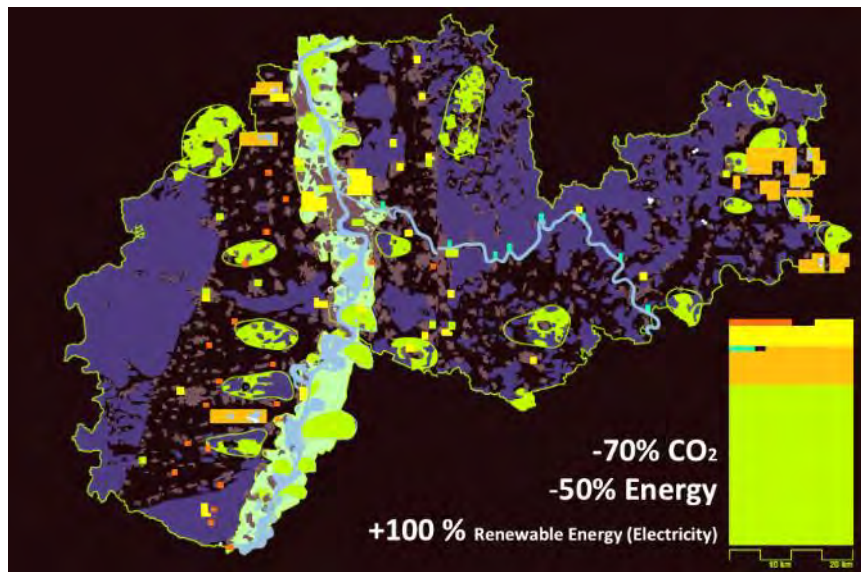

Figure 1: Nature-orientated, climate-friendly metropolitan region 2050
legend: green: new forests, orange: wind energy, yellow: photovoltaics, turquoise: hydroenergy red: geothermal energy

The strategies are located within the conceptual designing and decision-making process in Figures 1 and 2 according to the analyzed specific characteristics and abilities of the particular spaces and describe the spatial potentials for Climate Protection and Adaptation in metropolises and metropolitan regions. The overall view of the integrative concept shows the synergetic principle of the interaction of Nature Development and Urban Restructuring and Energy Transformation for Climate Protection and Adaptation. This approach is explicitly oriented to the spatial possibilities and geographical as well as natural conditions of the sites and the existing urban building stock. In the setting of the measures the spatial aesthetic principles mentioned above, have been applied under the title: Concentration and Protection or rather keeping free, which will be explained here with a few examples:

The principle of emphasizing the natural characteristics: The Rhine valley is emphasized as landscape-park with new forests and retention areas. The Palatine and the Odenwald forests are kept free of energy-related interventions. They are protected and presented as specific natural treasure of the metropolitan region.

The principle of integration in the environmental context: New forests are integrated in the sparsely wooded Rhine valley, in the Kraichgau, in the landscape along the Rhine and as urban forest in the cities and additional forest in the Odenwald forest.

The principle of spatial concentration of structural, natural and energy-technical interventions as well as the continuance of existing potentials: Five wind parks are concentrated and connected to existing wind parks and existing networks. According to the priority positioning of the strategy *Nature Development*, the construction of wind energy plants in the Palatine forest and Odenwald forest is a taboo – environmental and landscape protection play the major role in decision-making.

The spatial characterized choice of location (choice of the adequate location, by weighing up climate protection, climate adaptation and spatial aesthetics): Industrial and commercial areas have the greatest potentials for generating solar power compared to other urban space typologies, because of their large roof structures, as well as façade surfaces. In these areas the energy yield is the highest. For this as well as for aesthetic and practicable reasons (simplified realization of civic power plants), an urban concentrated use of photovoltaics is recommended.

Table 2: Examples of spatial aesthetic principles and their application (Barbey 2014, 51-52)

3. NATURE-ORIENTATED, CLIMATE-FRIENDLY METROPOLIS

The regional strategies: Nature Development and Urban Restructuring and Energy Transformation are transferred to the local level: Green Metropolis and Inner City Development and Energy Efficiency and Energy Generation and the concept Nature-orientated, Climate-friendly Metropolis Mannheim 2050 (Figure 2) is developed to show in addition to the regional (Figure 1), the urban spatial potentials of Climate Protection and Adaptation. Only in the

interaction of integrated regional and local urban strategies the spatial ambition: Nature-orientated, Climate-friendly Metropolitan Region 2050 could be realized. (Barbey 2014, 52)

3.1 Recommendation for actions in metropolises

The following recommendations for actions in Metropolises are derived from the conception Nature-orientated, Climate-friendly Metropolis Mannheim 2050 (Figure 2):

1. Consideration of the natural green space as starting point in urban planning processes and as basis of future urban development:

Establishment of a continuous green space system to develop a resilient spatial structure, which connects the different quarters of the city

Development of the individual urban districts as nature based objects on the ground of the natural green space

2. Development of the individual urban districts as functional clusters of Climate Protection and Climate Adaptation:

Interaction of the concepts Green Metropolis and Inner City Development and Energy Efficiency and Energy Generation, which in total creates a Nature-orientated, Climate-friendly and Water-sensitive Metropolis 2050

3. Nature-orientated, Climate-friendly and Water-sensitive urban development including in every quarter: Concept of Green Metropolis and Concept of Inner Urban Development and Concept of Energy Efficiency and Energy Generation with the aim to develop Spatial Qualities and Spatial Sustainability in the City. (Barbey 2014, 52-53)

4. PRECONDITIONS FOR CLIMATE PROTECTION AND ADAPTATION

The Concept of Interacting Strategies

The Concept of Interacting Strategies Climate Protection and Adaptation:

Nature Development and Urban Restructuring and Energy Transformation and The Principles of Connecting, Cooperating and Interacting must be developed on the essential level of preparation: Climate Policy – Spatial Concept – Climate Economics, on the level of realization: City – Energy Providers – Entrepreneurs – Citizens – Planners – Universities and on the spatial level: Quarter and City, Metropolis and Metropolitan Region, Metropolitan Regions and Nations, Metropolitan Regions Global

Metropolises and Metropolitan regions are important global players towards Climate Protection and Adaptation. Only in the global network of metropolises and metropolitan regions and their interacting spatial strategies, the essential effects of climate protection and climate adaptation can be developed on a global level and the aims of Climate Protection and Adaptation can be reached. (compare Barbey 2012, 340-341)

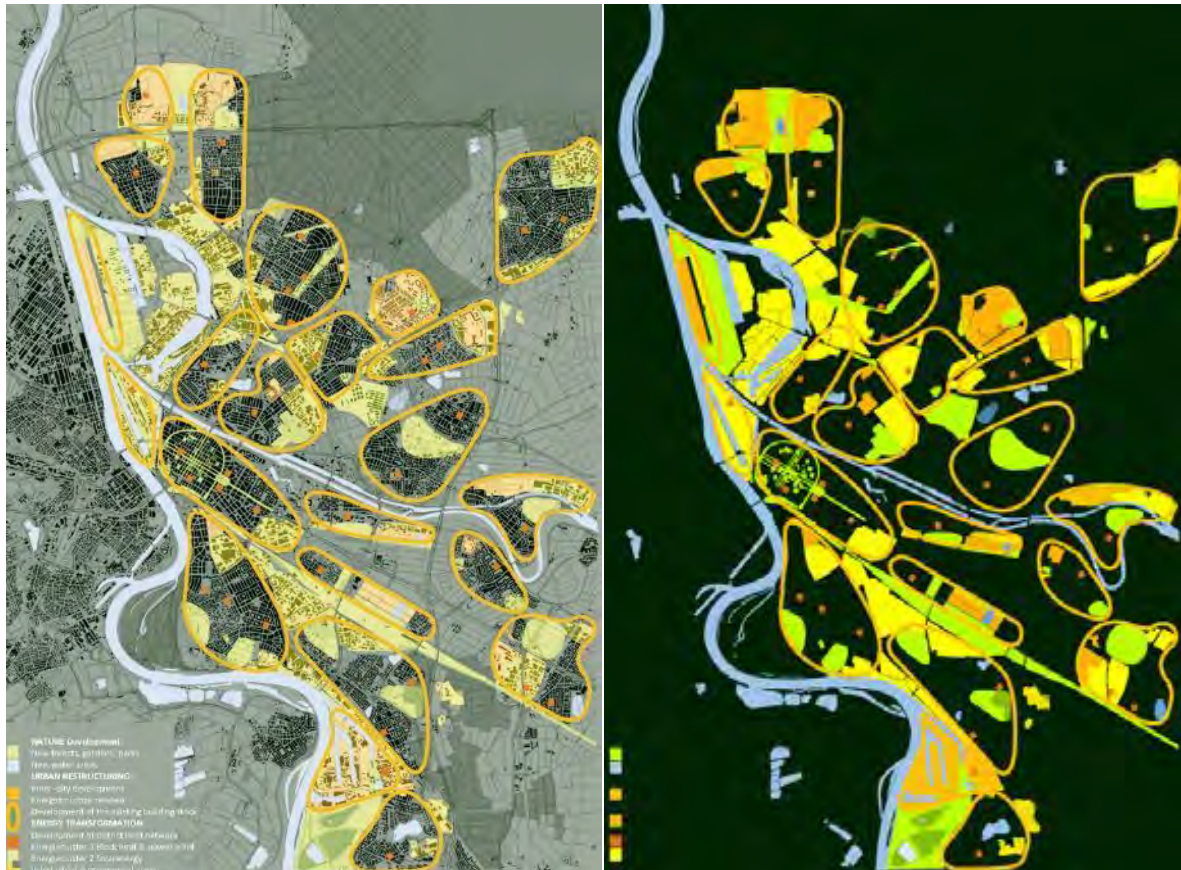

Figure 2: Nature-orientated, climate-friendly and water-sensitive metropolis 2050

Legend: nature development / green metropolis: green: new forests, gardens, parks, blue: new water areas urban restructuring / inner city development: orange: inner-city development, energetic urban renewal, orange line: development of the existing building stock energy transformation / energy efficiency and energy generation: development of district heat network, red: energy cluster 1 block heat and power plant, yellow: energy cluster 2 solar energy in industrial and commercial areas

Political commitment Climate Protection and Adaptation

First experiences in the implementation of the mentioned international examples point to the essential role of political commitments for the spatial implementation of the formulated political aims. Political commitments have to be represented in spatial concepts with a concrete time horizon of realization. They have to correspond to the space and its specific conditions. (Barbey 2014, 53)

The Principles of Connecting, Cooperating and Interacting

The special challenge in the realization of spatial strategies for Climate Protection and Adaptation and in the success of the transformation is about The Principles of Connecting, Cooperating and Interacting. The upcoming tasks will only be accomplished through a common Societal Act of Solidarity. The Concept of Interacting Strategies Climate Protection and Adaptation on the societal level points to the potential to realize appropriate strategies as well as to achieve an appropriate impact of Climate Protection and Adaptation by the societal network of a cooperating citizens and stakeholders. (Barbey 2014, 53) The Interaction of political commitment and civic participation is a key condition to realize Climate Protection and Adaptation. Politicians, citizens, entrepreneurs, planners, architects, engineers, economists, sociologists and artists have to work together to create intelligent solutions for a sustainable urban development. The consistent Integrative Spatial Concept Climate Protection and Adaptation could be the basis for discussions and civic participation with the intension to support the spatial realization of the climate protective and adaptive transformation.

4. CHANCES

Nature Development – Urban Restructuring – Energy Transformation

are qualification processes, which can lead to an improvement of existing qualities.

Nature Development → Chance of ecological (+ aesthetic) Qualification

Urban Restructuring → Chance of aesthetic (+ ecological) Qualification

Energy Transformation → Chance of sociopolitical (+ ecological) Renewal

In connection and interaction of these strategies a development path of sustainable spatial development will be developed in an ecological, aesthetic and sociopolitical regard. (Barbey 2014, 53)

5. NATURE-ORIENTED, CLIMATE-FRIENDLY MEGACITY 2050?

The presented Integrative Spatial Concept sets an example of a possible path towards a Nature-based, Climate-friendly Metropolitan Region 2050. Every mentioned Spatial Strategy and Principle for Climate Protection and Adaptation is generally applicable in every City and Metropolitan Region in Europe and beyond. In addition the described Process of Conception is generally transferrable to every City and Metropolitan Region in the world, always supposing that the selection, the dimension and the combination of strategies are well adapted to the site-specific spatial, energetical, climatical and cultural conditions. After focusing Spatial Strategies Climate Protection and Adaptation on the level of the Metropolitan Region and the Metropolis, the open question is now: will it be possible to transfer the presented strategies even to the level of Megacities? The overview of existing social and ecological problems in Megacities demands the creation of new ideas and new planning strategies - the responsible view towards a Nature-orientated, Climate-friendly Megacity challenges certainly an Integrative, Transdisciplinary Thinking to figure out possible solutions at the local mega-urban level, considering imperatively the entire body of a Megacity. The fundamental question of all mega-urban development is the Project Nature, i. e. the consideration of the natural conditions. The urban development and restructuring of Megacities must be orientated, adapted and integrated to the natural, climatic and geographical conditions of the local and regional context. The essential question of our century: The Human Relation to Nature is drastically present facing existing and future societal and environmental phenomena of mega-urban development worldwide. A changed handling in respect of Nature and Humanity is needed to give liveable perspectives on a global level.

REFERENCES

- [1] Barbey, Kristin 2012, Metropolregion im Klimawandel – Räumliche Strategien Klimaschutz und Klimaanpassung. (Metropolitan Regions and Climate Change - Spatial Climate Protection and Adaptation Strategies.) Thesis (PhD), Karlsruhe Institute of Technology. <http://digibib.ubka.uni-karlsruhe.de/volltexte/1000029071>
- [2] Barbey, Kristin 2014, Integrated Spatial Concept Climate Protection & Adaption. Journal of Heat Island Institute International, Vol. 9-2, 50-53. http://www.heat-island.jpg/web_journal/Special_Issue_7JGM/32_barbey.pdf
- [3] Böhme, Gernot 2002, Die Natur vor uns, Naturphilosophie in pragmatischer Hinsicht.. (Nature ahead of us, The philosophy of nature regarded pragmatically.) Zug.
- [4] Habermas, Jürgen 1997, Die Herausforderung der ökologischen Ethik für eine anthropozentrisch ansetzende Konzeption. (The challenges of the ecological ethic for an anthropocentric conception.) Naturethik, Grundtexte der gegenwärtigen tier- und ökoethischen Diskussion, edited by Angelika Krebs, Frankfurt am Main.

Historic Relationship Between Urban Dwellers and the Tomebamba River

Pablo OSORIO^a, Mateo NEIRA^b, M. Augusta HERMIDA^c

^a Universidad de Cuenca, Ecuador, pablo.osorio@ucuenca.edu.ec

^b Universidad de Cuenca, Ecuador, mateo0719@gmail.com

^c Universidad de Cuenca, Ecuador, augusta.hermida@ucuenca.edu.ec

ABSTRACT

Accessibility to water sources has played a decisive role in the location and growth of human settlements, fulfilling a key role in the historical development of cities, as in the case of Cuenca, where the Tomebamba River defined its foundation place. Recent urban development has weakened the relation between cities and their rivers, and it is urgent to rediscover the potential of rivers and their banks in the urban fabric, not only as generators of urban biodiversity, but as a public space that contributes to social resilience and builds urban identities. This paper studies the historic relationship between urban dwellers and the river, in 1.5km of the Tomebamba River that runs in front of the Historical Centre of Cuenca, through uses and perceptions of its users. A series of semi-structured interviews were explored using discourse analysis, word frequency, and spatial visualization, to reveal perceptions associated with places and space morphologies, and how they have changed through time. The results shows that historical use of this city place was related to production and leisure, having a strong relation to the river as a water source, whereas now production is no longer related to the river; instead, newcomers have occupied the space, promoting new uses in the river margins, having little to no relation with the water, modifying landscape perceptions and building new urban identities.

Keywords: urban regeneration, riverbanks, landscape perceptions.

1. INTRODUCTION

1.1 Background of the research

The construction of identity related to resilience can be understood through human-environment relationships. By studying and exploring human behaviors, perceptions and spatial configurations, one can suggest socio-environmental improvements and better urban regeneration strategies (Cheshmehzangi & Heat, 2012). In this context, the study of the relationship of the city with its rivers is important because accessibility to water resources has played a key role in the location and growth of human settlements, being significant to the historical development of cities and the definition of the urban landscape.

Despite its importance, in many cities around the world the relationship between rivers and their cities has weakened (Novotny, 2009) so it is urgent to rediscover the potential of rivers and streams in the urban fabric (Beja da Costa, 2009) and its role as a public space capable of strengthening social resilience, understood as the ability of a group or community to recover or respond positively to a crisis (Maguire & Hagan, 2007).

1.2 Purpose of the research

In the case of Cuenca, rivers have played a key role in its development. This paper studies the historic relationship between urban dwellers and the river, in 1.5km of the Tomebamba River that runs in front of the Historical Centre of Cuenca, through uses and perceptions of its users. The end goal of this work is to define the interrelation between morphology and perception, and the way it generates urban identities.

1.3 Location of the study area

Cuenca is located at the south of Ecuador, in the Andes Mountains, 470km, at 2.530 meters above sea level. Four rivers run through the city: Tomebamba, Yanuncay, Tarqui and Machángara. The Tomebamba River has its headwaters in the Cajas National Park, a moorland and wetland ecosystem that contributes to the water recharge, providing high quality water for cities in the Andean Highlands and parts of the coastal plain (Buytaert et al., 2006; Serra & Hermida, 2017).

Cuenca and its predecessor settlements, Guapondelig and Tomebamba, have always maintained a close relationship with water. The Spanish foundation took place in the Inca and Cañari city, north of the Tomebamba River. In 1947 the city expanded south, with the implementation of architect Gilberto Gatto Sobral Urban Plan. Since then, Cuenca has experienced expansive growth, passing from 288,29ha in 1950 to 7.248,23ha in 2010 (Hermida et al, 2015). Geographical corridors marked by rivers and streams determined this growth.

In 1982, through the Urban Development Plan of the city, local government showed interest in riverbanks (Jaramillo, 1982) situation that resulted, years later, in the generation and improvement of linear parks adjacent to the rivers. However, these spaces have not been resolved as part of a comprehensive network of urban green.

2. THEORETICAL REVIEW

The importance of urban spaces for identity has been acknowledged since the 60's (Bernardo & Palma-Oliveira, 2016). Identity refers to the distinction between certain elements from the whole, its recognition as a separate entity (Lynch, 1960). However identity can also refer to the relationship between elements with another. Urban identity is made up of different components; socio-economic structure, socio-cultural structure, built environment and urban image (Murzyn-Kupisz & Gwosdz, 2011; Yaldiz et al. 2014). The first two can be analysed through perceptions and uses of space, while the last two can be summarized as spatial morphology. Accordingly, the identity in an urban environment is defined by space and the activities and events that take place.

Morphology refers to the relationships between different elements; it is based on the idea that "the way things are assembled matter" (Hillier, 1996). The morphology of a city is reflected in a hierarchy of different sub-centres or groups along various scales, from the city to the suburbs, organized around different economic functions (Batty, 2008). Urban morphology provides us with valuable information about the structural characteristics of a city; it gives insight into the structural origins and impacts of historical change on the chronological processes concerning the construction and reconstruction of a city (Ariza-Villaverde et al. 2013). Morphology can be studied through road network connectivity, buildings, and diversity of land uses, which provide information on urban patterns influenced by the growth of the city under various urban plans and regulations and different socio-economic contexts.

The urban environment is characterized by the embodiment of certain kinds of identities in space, while space is dematerialized into non-discursivity and therefore into identity and culture (Hillier, 1996). Consequently the relationship between human behaviour and perception with the urban environment can be studied; this relationship is linked to memory, culture, knowledge and emotions and generates urban identity.

3. METHODOLOGY

Historical maps, which identify changes in patterns of use and connectivity, were consulted to analyse the spatial morphology in relation to the Tomebamba River over time. References and historical texts, poems, and songs about the Tomebamba River, that provided important information regarding uses through history, were also reviewed. Semi-structured interviews were explored using discourse analysis, word frequency, and spatial visualization, to reveal perceptions associated with places and space morphologies, and how they have changed through time. The historical perception had two types of informants: town historians and elders (70-85 years old) who lived their childhood, adolescence and youth by the Tomebamba River. The current perception was also obtained with two types of informants: residents and users of the Tomebamba River, which are not necessarily the same people. The interviews were digitized, enabling their explorations through discourse analysis, word frequency and spatial visualization with Atlas.ti by QGIS. The information obtained from interviews and its relation to the analysis of changes in the spatial morphology of the city over time, allowed looking at the historical and spatial context of the city in connection with activities linked to the River, providing knowledge to understand the relationship between uses and the configuration of the city over time.

4. RESULTS AND DISCUSSION

4.1 Cuenca in the twentieth century

During 1900-1910, the axis of the Tomebamba River was the division between the consolidated and the expansion area of the city, called El Ejido. Two bridges served as entrances from the south and east of the city, basically intended for the use of pedestrians and carriages. In 1912, with the arrival of the first car, the planning and

inhabiting of the city changed (Carpio, 1976). In this period, the river was perceived by people as a means of sanitation of the city, sewage was transported by canals passing through the streets and flowed into the Tomebamba river (Vega, 1997). In addition, the height and abundant river flow were used by the population for productive purposes (Morales, 2011). From colonial times until the first decades of the twentieth century, the mills on the banks of the Tomebamba River started emerging and gaining importance in grinding wheat for flour production. The banks were not considered as public spaces for leisure and recreation, yet close to them, on the south bank of the river, facilities such as the hospital, the morgue and the nursing home, all of them public, had been installed (Albornoz, 2008). In this same bank the slaughterhouse had been built and used the river for the evacuation of its waste (Jamieson, 2003).



Figure 3. Map of Cuenca, 1930. Source: Albornoz. B. 2008.

Between 1910 and 1930 (Figure 1), the connectivity between the northern and southern riverbanks increased, with the construction of two new bridges: Mariano Moreno and Centenario (García & González, 2016). The buildings near the river began to have greater value so many of them were renovated and changed their traditional colonial style, to make way for the Republican style; this happened in parallel with economic growth in the region, given by the export of *toquilla* straw hats, also known as Panama Hats (García & González, 2016). Each of these houses had secondary accesses that directly linked to the Tomebamba River. By 1930 the canals that moved sewage into the river were concealed and at the same time, the number of hydraulic mills that were used for grinding wheat increased, transforming the area into the seed of the industrial region of Cuenca (Vega, 1997).

Since 1950, the southern area of the Tomebamba River began to urbanize consolidating and increasing the connecting of the middle terrace to the lower one. Along the northern bank, streets emerge to join the east-west ends of the city (Carpio, 1976). A great river flooding, precisely on 1950, caused the destruction of three of the five bridges that crossed the Tomebamba. According to Carpio the local traffic was affected for several years. Together with bridges, the slaughterhouse was destroyed and later relocated downstream. Despite this event, the educational facilities, parks, public squares and hospital were maintained and augmented in the southern area of Tomebamba River (Albornoz, 2008). By 1970 the green areas along the riverbanks became public spaces (Albornoz, 2008). Traditional building systems were replaced and consequently the materiality of the buildings in the area changed, allowing taller buildings of three or more levels (Carpio, 1976).

4.2 Cuenca in the twentieth-first century

In this century, the largest investments were aimed at roads and automobile connectivity; underpasses were built on the southern riverbank. For non-motorized mobility three new footbridges were constructed and, on the northern bank, infrastructure for pedestrians and cyclists was built. The use of the Tomebamba River as a production site was significantly reduced due to the disappearance of the mills. Traditional uses, such as "bathing" in the river and "trout fishing" were almost none and the presence of the washerwomen was maintained, although in a lesser degree (García & González, 2016. Novillo, 2010); meanwhile, in view of the magnitude of the problem of contamination of the riverbeds by the discharge of wastewater, the public company in charge of water treatment of the city designed plans for its management. The slope formed between the intermediate terrace (Historic Center) and the lower terrace, traditionally known as "El Barranco" does not lose its iconic character, it remains a quaint place suitable for cultural, artistic and sporting activities, also extending its use for night activities; with the presence of commercial premises, hotels, bars, restaurants, nightclubs, among others. Due to the expansion of the city, the Tomebamba River is no longer a limit and has become part of the central urban area, where walking, wandering and sightseeing are daily activities for both locals and tourists that visit the city.

4.3 Perceptions

In-depth interviews offer another look at the changes in the uses and perceptions that have occurred in the Tomebamba River over time. Keyword counts were made on the transcriptions of the interviews using Atlas.ti that revealed diachronic differences in the relationships of citizens with the river. One hundred keywords that relate to four dimensions of the study were selected: uses of the Tomebamba river (26 words), perceptions (42 words), natural environment (11 words), and built environment (21 words). Different variations of these words between interviews that referred to the mid-twentieth century and the twenty-first century were recorded based on their relative frequency. As seen in Figure 2, there are differences in the presence of words in the two analysed historical moments.



Figure 2: Comparison between mid-twentieth century and early twenty-first century.

There are words that show important differences between the two sets of interviews (Figure 3). In the mid-twentieth century: swimming, fishing, eating and washerwomen, while in the twenty-first century: walking and sports. The frequency of words indicates that uses of the Tomebamba River during the twentieth century were related to the water, with the exception of the word eating, while uses in the twenty-first century relate to the riverbanks. The word eating refers to picnics that were done frequently in the riverbanks in the twentieth century and is returning slowly today.

The words associated with pleasure, dislike, safety and environmental sensations also show important differences. In the previous century words that refer to positive perceptions, such as beautiful and like, and others that refer to negative perceptions like rubbish, horrible and danger, stand out. The latter refers to the dangers related to natural phenomena such as flooding, not criminal activity. The words that predominate today are safety and noise. The first refers to the concern of criminal activities along the river that have been reported by respondents, and the second to motorized traffic taking place in the adjacent streets.

Four words contain the main contrasts in relation to the natural environment of the river. In the previous century words like flooding, stones and deep-water predominate, clearly linked to water and, particularly, with the riverbed. In contrast, today the word riverbank predominates. This opposition expresses a difference in the use of the river,

before more related to water, and now more closely linked to the banks. In fact deep-water and stone refers to the practice of 'getting into the river', jumping from a high stone to deeper water areas.

The words that show more contrast in relation to the built environment are mills, vado, parks, commerce and pedestrian paths. In the twentieth century words like mills and vado were more present. The word mill refers to the use of the river as a means of production, providing energy by spinning stone mills that were used to grind wheat, barley and corn. The word vado is related to a representative place that connected the two riverbanks and was part of the road that transported people to the south of the country. Currently the words parks, commerce and pedestrian paths are present, all referring to activities that take place on the riverbanks or on the immediate environment, and even though parks and pedestrian paths existed in the previous century, its presence in the imagination of people is intensified today.

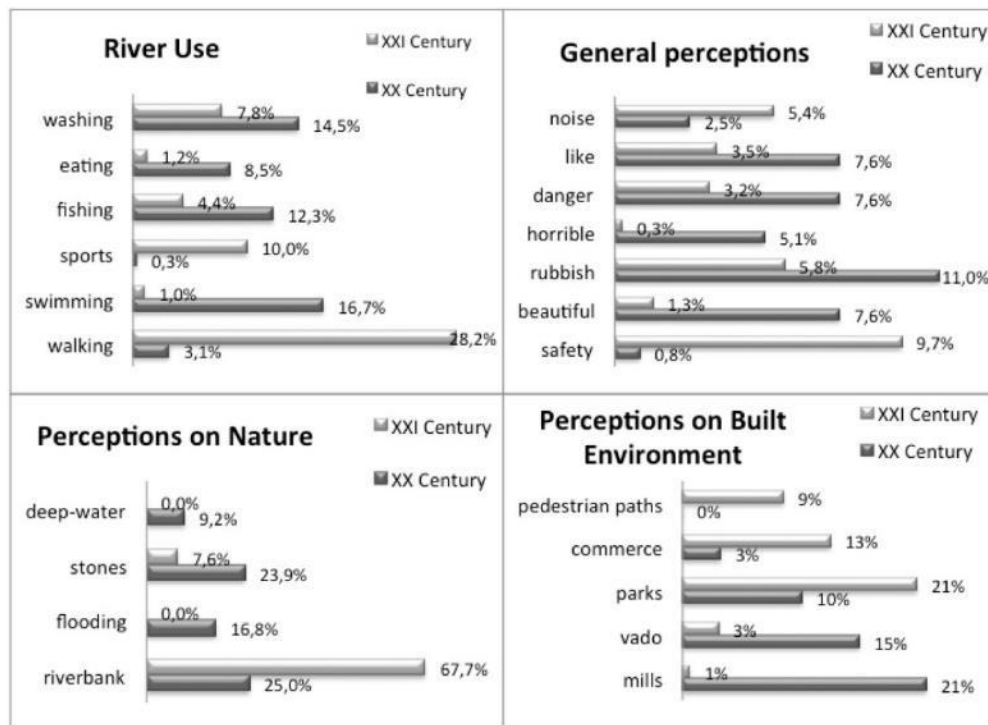

Figure 3: Relative word frequency comparison: mid-twentieth and early twenty-first century.

5. CONCLUSIONS

The identity relationship of a city with its main river is close-knit, and the city of Cuenca is no exception. In both periods the river frames the city and becomes a highly valued element by its inhabitants. Access, parallel roads, bridges and green spaces that have been built around and on the river have contributed to greater relationship and sense of belonging of the city inhabitants. Therefore, we can say that the way in which the space around the river is 'built' is crucial to the way we relate to it and contributes in the construction of identity of the place. The main changes in perception regarding the river arise precisely through the uses it allows, and the uses that we allow ourselves in relation to it. In the mid-twentieth century the identity of the river was determined mainly by water because of three considerations: first, water was a means of production that provided hydraulic power to move mills and generate electricity, and as a means of getting rid of solid and liquid of city; secondly, the river was a fun space for bathing and collective games; and lastly, there is the consideration of the river as a barrier, as a boundary separating the productive zone from the inhabited area, the rural from the urban. In contrast, at the beginning of the twenty-first century the identity of the river is determined mainly in the use given to its banks as a social meeting place between different people and for economic exchange. The changes that public spaces, like the Tomebamba River, undergo cannot be understood isolated from its context. The production system of the city has changed from a subsistence agricultural model to one based on services and high value-added production. Public spaces are places of encounter and exchange of ideas and have a potential to increase the social capital and productivity of a city, a subject worth exploring in future research.

REFERENCES

- [1] Albornoz, V. B., 2008. Planos e Imágenes de Cuenca. Municipalidad de Cuenca, Cuenca.
- [2] Ariza-Villaverde, A. B., Jiménez-Hornero, F. J., & Ravé, E. G. De. 2013. Multifractal analysis of axial maps applied to the study of urban morphology. *Computers, Environment and Urban Systems*, 38(1), 1–10.
- [3] Batty, M. 2008. The size, scale, and shape of cities. *Science*, 319(5864), 769–771.
- [4] Beja da Costa, A. 2009. Design strategies for urban water systems: A case study of Sao Cristóvão in Rio de Janeiro. *Water and Urban Development Paradigms*, 197-205.
- [5] Bernardo, F., & Palma-Oliveira, J.-M. 2016. Urban neighbourhoods and intergroup relations: The importance of place identity. *Journal of Environmental Psychology*, 45, 239–251.
- [6] Buytaert, W., Céleri, R., De Bievre, B., Cisneros, F., Wyseure, G., Deckers, J., & Hofstede, R. 2006. Human impact on the hydrology of the Andean páramos. *Earth-Science Reviews*, 79(1-2), 53–72.
- [7] Carpio, V.J. 1976. Las Etapas de Crecimiento de la ciudad de Cuenca, Ecuador. *Revista Geográfica* (84): 77 – 101
- [8] Cheshmehzangi, A., & Heat, T. 2012. Urban Identities: Influences on Socio-Environmental Values and Spatial Inter-Relations. *Procedia - Social and Behavioral Sciences*, 36(June 2011), 253–264.
- [9] García, G. y González, M. 2016. Fotografía histórica y contemporánea, Herramientas para la valoración del Patrimonio, El caso el Barranco (Cuenca). Trabajo de grado, Arquitectura, Universidad Estatal de Cuenca.
- [10] Hermida, A., et al., 2015, La densidad urbana como variable de análisis de la ciudad. El caso de Cuenca-Ecuador, *Revista Eure*, Vol. 41, N. 124.
- [11] Hillier, B. 1996. *Space Is the Machine*. Press Syndicate of the University of Cambridge. London.
- [12] Jamieson, R. 2003. De Tomebamba a Cuenca, Arquitectura y arqueología colonial. Ecuador: Universidad Estatal de Cuenca
- [13] Jaramillo, C. 1982. Evolución histórica de la ciudad de Cuenca. *Revista del Instituto Geográfico Militar* (26), 117-137.
- [14] Lynch, K. 1960. *The Image of the City*. The M.I.T Press, 1–103.
- [15] Maguire, B., & Hagan, P. 2007. Disasters and communities: Understanding social resilience. *The Australian Journal of Emergency Management*, 22(2), 16–20.
- [16] Morales, P. E. 2011. Dinámica cultural del barrio de todos santos desde 1950 hasta nuestros días. Trabajo de grado, Licenciatura en la Especialidad de historia y geografía, Cuenca.
- [17] Murzyn-Kupisz, M., & Gwosdz, K. 2011. The changing identity of the Central European city: The case of Katowice. *Journal of Historical Geography*, 37(1), 113–126.
- [18] Novillo, V. M. 2010. Estudio histórico y cultural de cuenca en el siglo xx (1920- 1980), a partir de la producción literaria de g. h. mata. Trabajo de grado, Licenciatura en Ciencias de la Educación en la especialidad de historia y geografía, Cuenca.
- [19] Novotny, V. 2009. Sustainable urban water management. *Water and Urban Development Paradigms*, (May), 19–31.
- [20] Serra-Llobet, A, Hermida, M.A. 2017, **Opportunities for green infrastructure under Ecuador's new legal framework**, *Landscape and Urban Planning*, Volume 159, March 2017, Pages 1–4.
- [21] Vega, M. 1997. El Río Tomebamba en la Historia de Cuenca. Cuenca: CIDAP
- [22] **Yaldiz, E., Aydın, D., & Siramkaya, S. B. 2014. Loss of City Identities in the Process of Change: The City of Konya-Turkey. *Procedia - Social and Behavioral Sciences*, 140, 221–233.**

Transformation from River Channelisation to River Revitalisation

Richard LEUNG Wah-ming^a, Ivan NG Yu-ting^b, Stanley CHAN Chi-wai^c, Alex WU Yat-fei^d

^a Drainage Services Department, Government of the HKSAR, Hong Kong SAR, rwmleung@dsd.gov.hk

^b Drainage Services Department, Government of the HKSAR, Hong Kong SAR, ytnng02@dsd.gov.hk

^c AECOM Asia Company Ltd., Hong Kong SAR, stanley.chan@aecom.com

^d AECOM Asia Company Ltd., Hong Kong SAR, alex.yf.wu@aecom.com

ABSTRACT

River channelisation is a conventional approach of resolving flooding problem in view of its outstanding hydraulic performance. Such design, however, has a negative impact on the city landscape and also leads to degradation in the ecology and subsequent decline in ecological habitats and overall biodiversity. With a vision of providing sustainable drainage services and pursuing a higher standard in environmental and ecological preservation, the Drainage Services Department (DSD) of the Government of the Hong Kong Special Administrative Region has incorporated environmentally friendly design in its drainage improvement projects in Ho Chung River, Upper Lam Tsuen River and Kai Tak River. Indeed, incorporation of environmentally friendly drainage design in a densely developed area like Hong Kong is a great challenge. In this paper, the improvement of ecology, enhancement of biodiversity and the characterised features of the abovementioned rivers achieved in the drainage improvement projects will be discussed. Looking ahead, by adopting the concept of manifesting and revitalising water bodies into drainage improvement works and development of new development areas, the community will be further benefited from the improved environment. In the revitalisation of Tsui Ping River at Kwun Tong as well as the drainage planning of new development areas, DSD will adopt new standards in the planning and construction of drainage facilities with a view to providing a better environment for the public.

Keywords: channelization, blue infrastructure, community empowerment, ecological enhancement, flood protection, green infrastructure, revitalisation, water friendliness

1. INTRODUCTION

From 1970s to 1980s, there was a need for new towns development through urbanisation of rural areas to cope with the increase in population and to improve the living environment by decentralising the population from the over-crowded urban districts. Once served the purpose for natural land drainage, natural rivers and waterways flowing through these development areas have to be modified in a form of new man-made (engineered) channels.

As a result of modification of land use, change of drainage characteristics and pattern, and increase in impervious areas, the quantity and peak stormwater runoff within these urbanised areas would be increased. As the surface runoff was no longer able to infiltrate into the ground, substantial rapid surface flows would occur which would not only cause imminent inundation to local areas, but also create secondary flooding due to overflow from those under-capacity rivers and waterways.

To improve the situation, the Hong Kong Government decided to develop flood control strategy to increase the drainage capacity of the concerned waterways. Channelising natural rivers and waterways such as concretising, straightening, deepening and widening were typical solutions to enhance the drainage capacity.

Although the flooding situations were improved through extensive drainage improvement works, this type of channelisation works has led to degradation in the existing ecology and subsequent decline in ecological habitats and overall biodiversity. In addition, the robust and flood-proofing-tight engineering facilities also discouraged the public from accessing and enjoying these valuable natural resources.

In late 1990s, the Hong Kong Government took a first step forward to restore the ecology within the channels by applying green elements into the drainage improvement works. This was a significant step shifting from sole flood control focus onto two-dimensional consideration of flood management and riparian ecology.

Since then, the Hong Kong Government has been continuing to improve the drainage networks by adopting the concept of river revitalisation with holistic consideration on functional, environmental, ecological and aesthetic

aspects, with an aim to creating the world's built, natural and social environments. This is also a "transformation" from two- to multi-dimensional management strategy to achieve the goal of sustainable drainage services provision.

2. RIVER CHANNELISATION

Hong Kong was experiencing continuously flooding in various areas from 1970s to 1980s, the Government understood that the early constructed drainage systems were insufficient to drain the substantial surge of runoff due to rapid urbanisation. Therefore, the government conducted the Territorial Land Drainage and Flood Control Strategy Study – Phase 1 (TEL I) in 1988. The study identified the levels of protection against flood on drainage requirements. This study also developed a drainage masterplan for New Territories to cater for the future new town developments.

In 1991, Territorial Land Drainage and Flood Control Strategy Study – Phase 2 (TEL II) was conducted to identify and manage flooding black spots. It also developed a strategy to manage drainage system along private areas to improve the overall drainage operation and management to enhance the drainage functionality and reduce the consequents of flooding. In 1995, Territorial Land Drainage and Flood Control Strategy Study was moved into Phase 3. In this phase, the cost effectiveness and impacts on environment for drainage projects were reviewed. These studies were not just forming the backbone for the stormwater design standards, but also leading the way on identification of flood protection levels and determination on the extent and degree of associated drainage improvement works.

To alleviate the potential flood risk, one of the solutions was to straighten, widen and deepen the existing natural meandering rivers, and channelised to rectangular or trapezoidal concrete-lined canals in order to increase the hydraulic conveyance. **However, these treatments would degrade the riparian ecology and waterway's health** without environmental benefits being taken into consideration.

In addition, some of the long-existing rock channels or open nullahs in urban areas were decked to create additional lands for development as well as to mitigate odour issue due to cross connection to sewer. These additional lands were generally for constructing open spaces, such as parks and roads. While the properties of these drainage facilities were changed entirely as they were transformed to underground culverts, the entire ecosystem was destroyed.

2.1 Case Study: Sheung Yue River

Sheung Yue River is also known as River Beas which is located in northern side of New Territories. In the 1990s, the areas alongside Sheung Yue River were frequently experiencing severe flooding during wet season. In late 1990s, DSD decided to conduct improvement works to enlarge its hydraulic capacity and hence reducing the flooding risk.

The original alignment of the river was being straightened to improve the flow path along the river as well as to increase the width of the river to enlarge the cross section. Additional to these works, it also concretised the banks to increase the conveyancy of the channel to provide additional capacity of the river.

As the river was trained and straightened to improve the hydraulic capacity, these works destroyed some of the habitats and increase the flow velocity within the river which some of the fauna and flora were disappeared from the river.



3. ECOLOGICAL IMPROVEMENT FOR CHANNELS

In late 1990s, flooding situations alongside the rivers have been greatly improved after completion of a series of drainage improvement works. With a vision of providing sustainable stormwater drainage services and pursuing a higher standard in environmental and ecological preservation, the Hong Kong Government adopted the sustainable development approach and started to implement greening elements into drainage improvement works to enhance the ecology in the channelised waterways. Most of these works were mainly adopted for ecology enhancement which provided some environmentally friendly elements to allow aquatic fauna to breed and live healthy within the channel. During this stage, some early revitalisation initiatives were taken on board including:

- Using gabion and geo-fabric reinforced grass lining to stabilise river banks;
- Leaving channel beds unlined to provide natural substrate that supports aquatic flora and fauna;
- Leaving embankment unlined to promote vegetation growth;
- Retaining meanders as wetland habitats, and creating by-pass channels to preserve natural river and stream channels;
- Creating shallow ponds for aquatic planting along drainage channels to provide habitat for wetland fauna;
- Creating wetland habitats and reed beds adjacent to drainage channels; and
- Providing habitat enhancement measures to enhance the habitat complexity.

In 2005, DSD published the Practice Note No. 1/2005 – Guidelines on Environmental Considerations for River Channel Design. This Practice Note recommended a design framework, with an objective to produce a river channel design as environmentally friendly as possible, for use in the project planning and design stages. It covered the essential environmental aspects to be considered in conjunction with requirements/standards with respect to other design aspects.

3.1 Case Study: Ho Chung River

In order to provide a better balance between the needs of reducing flood risks and conserving the river ecology, a number of ecological features has been adopting in the drainage improvement works at Ho Chung River. For example, the flow deflectors formed with big boulders not only provide potential refuges for fish during spates, they also enhance the habitat complexity to create more diverse micro-habitats. In the sections where concrete retaining walls have to be adopted due to land constraints, the fish shelters can provide hiding spaces so that aquatic animals may protect themselves by moving inside.

To address the needs for re-provisioning of an original Fung Shui Weir while reducing the potential effects of obstructing the upstream movement of fish and other aquatic animals, the construction of fish ladder not just provides easier pathways for upstream migration, its appearance also follows the general pool and riffle pattern at the immediate upstream natural section. Such integration of ecological enhancement features and engineering techniques has demonstrated that engineers and conservation groups can work together to find out more sustainable solutions to address our social needs on flood control, where drainage improvement works in natural streams are inevitable.



3.2 Subtitle Case Study: Upper Lam Tsuen Rive

Lam Tsuen River valleys area, including upper Lam Tsuen River had suffered from flooding threat and these valleys had been listed as flooding black spots. Therefore, drainage improvement works was conducted in Upper Lam Tsuen River with primary aim to reduce the flood risk of the river course. During construction, various measures have been adopted in order to minimise the negative impacts brought out by the works done to the surroundings, including translocation of *Paramesotriton hongkongensis* (Hong Kong Newts) and conducting ecological monitoring.

After the completion of the project, some beautification works were conducted to preserve the natural environment. As a result, the concept of sustainable development can be implemented.



4. RIVER REVITALISATION

The 2015 Policy Address stated “We will adopt the concept of revitalising water bodies in large-scale drainage improvement works and planning drainage networks for new development areas so as to build a better environment for the public.” and “... this is aimed at promoting greening, biodiversity, beautification and water friendliness in addition to achieving efficient drainage, with a view to building sustainable drainage facilities and providing a better living environment.”. From this onward, the concept of river revitalisation has further been formally materialised with an aim to changing the culture of the community with water friendliness.

In the same year, DSD promulgated the Practice Note No. 1/2015 – Guidelines on Environmental and Ecological Considerations for River Channel Design. This version is an update based on DSD’s Practice Note No. 1/2005 and all items summarised in previous section are relevant. In addition, blue-green infrastructure concept is particularly introduced. This concept aims at improving the sustainability and resilience of Hong Kong’s drainage systems to meet the contemporary public aspirations for natural environment, to protect local culture and rural lifestyle.

With the prime objective of flood protection in mind, to revitalise a river, it will not only restore ecological value or enhance the environment, but also provide additional social and economic benefits to the surrounding community. The potential benefits arising from river revitalisation are summarised in above figure.

Looking ahead, by adopting the concept of manifesting and revitalising water bodies into drainage improvement works and development of new development areas, the community will be further benefited from the improved environment. In the end of 2015, DSD commissioned a consultancy study on revitalisation of water bodies to assess the feasibilities and benefits could be provided by revitalisation of water bodies. All these works were aimed to moving Hong Kong from a flood resistance city to a flood resilience city and enhancing the sustainability of the overall development in Hong Kong.

In the revitalisation of Tsui Ping River at Kwun Tong as well as the drainage planning of new development areas, DSD will adopt new standards in the planning and construction of drainage facilities with a view to providing a better environment for the public.



4.1 Case Study: Tsui Ping River

King Yip Street nullah was constructed more than 50 years ago. Riding on the opportunity of the transformation of Kowloon East into an attractive alternative Core Business District (CBD2) to sustain the economic growth of Hong Kong, DSD will adopt an integrated approach to transform King Yip Street nullah into a blue-green infrastructure “Tsui Ping River” with environmental, ecological and landscape upgrading, including enhancement of drainage capacity, provision of riverside walkways and landscaped decks, and improvement of pedestrian facilities in the adjacent area. The scope of the revitalisation of Tsui Ping River comprises but not limited to the following main items:

- Beautification of existing nullah by provision of attractive waterscape design, water retention features to retain water during low tide;
- Provision of landscaped walkways along Tsui Ping River to enhance walkability;
- Provision of landscaped decks over Tsui Ping River;
- Modification and face-lifting of Kwun Tong Road Footbridge; and
- Pedestrian path enhancement in the vicinity of Tsui Ping River.



4.2 Case Study: Kai Tak River

Kai Tak River has been continually modified since 1920s to suit the development needs in the vicinity. Experiencing about a century of transition, it is geographically and historically bonded with the surrounding districts, witnessed the development of Hong Kong. In order to improve the drainage capacity of Kai Tak River and to mitigate the flooding risk to surrounding areas, DSD is carrying out improvement works since 2011 at upstream and midstream sections of the river. With this opportunity, landscaping measures and ecological features have been incorporated **into the river channel design to revitalise it as a “green channel corridor” via the following solutions:**

- Placing boulders at the river bed to slow down the river flow at local spots for fish gathering and enhance the appearance to be more natural;
- Inclusion of fish shelters alongside river bank for providing a refuge to prevent fish and other aquatic organisms from being swept away during periods of high water flow, in order to enable a sustainable ecological environment;
- Beautification works at river wall; and
- Planting shrubs and plant alongside the river banks.



4.3 Case Study: Tung Chung River Park

Tung Chung River is identified as an ecologically important stream with important ecological functions. With the extension of Tung Chung New Town, the Government is planning to restore the existing man-made river channel at the downstream, and develop a **3.3-hectare of land adjacent to the river as Hong Kong's first river park** where the public can get close to the river for enjoyment.

In order to balance the impact to the habitat and enjoyment of the public, passive designs, such as boardwalks, viewing decks and footpaths are envisaged. Native vegetation will be preserved as far as possible to maintain the existing habitat. The river park will set as an example for the public to treasure rivers as a crucial social and ecological resource to nurture water friendly culture.

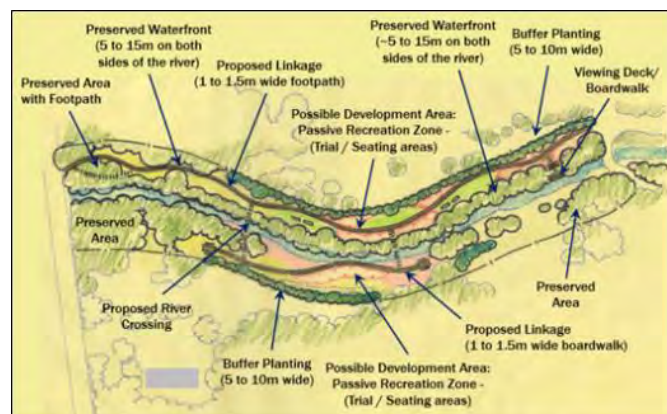

5. CONCLUSION

For Hong Kong, it comes a long way from river channelisation to river revitalisation, from flood protection to ecological enhancement, from isolation to water friendliness and public enjoyment. The ultimate goal is to create, **enhance and sustain the world's built, natural and social environments. The transformation of channelisation to revitalisation demonstrated the agility to embrace change and adaptation of the Government and the society in response to the request of building a sustainable environment.**

Looking forward, river revitalisation is an overwhelming and irresistible trend, not just in the Hong Kong context, but worldwide, and as one of the core subjects in water management for sustainable development. The below table shows the concept for developing a strategy for revitalisation from different aspects.

	Urban Waterfront	Ecosys Restoration	River Restoration
Strategy	<ul style="list-style-type: none"> - Analysis of the Overall Economic Benefits - Analysis of Direction for Waterfront Development - Investment and Financing Strategy - Mechanisms of Implementation and Operation Mode - Sustainable Development Strategy 	<ul style="list-style-type: none"> - Feasibility Study/ Benefit Analysis - Mechanisms of Implementation and Operation Mode - Policy Assessment 	<ul style="list-style-type: none"> - Feasibility Study/ Benefit Analysis - Integrated Water Resources Management Program - Policy Assessment
Planning	<ul style="list-style-type: none"> - Urban Spatial Structure/ Development Strategy - Waterfront City Planning - Waterfront Landscape Planning - Ecotourism Planning 	<ul style="list-style-type: none"> - Ecological Environment System Planning/ Design - Development of Water Ecology Strategy - Operation and Maintenance Program 	<ul style="list-style-type: none"> - Overall Design of River - Watershed Pollution Survey/ EIA - Drainage Planning - Flood control and Drainage Scheme - Water Recycling Scheme
Design	<ul style="list-style-type: none"> - Architecture and Urban Design Strategy - Green Space and Waterfront Open Space Design - Waterfront Landscape Design - Waterfront Transportation Design 	<ul style="list-style-type: none"> - Environmental Remediation Technology Program - Design of Natural River - Water Sensitive Urban Design 	<ul style="list-style-type: none"> - Physical Design Parameters - Water Purification Process Design - Hydraulic Structures/ Slope Revetment Design
Engineering	<ul style="list-style-type: none"> - Cost and Contract Management - Construction Management/ Value Engineering - Later Stage Management/ Optimization 	<ul style="list-style-type: none"> - Project Feasibility Analysis - Cost and Contract Management - Construction Management/ Value Engineering - Later Stage Management/ Optimization 	<ul style="list-style-type: none"> - Project Feasibility Analysis - Cost and Contract Management - Construction Management/ Value Engineering - Later Stage Management/ Optimization

By adopting the concept of manifesting and revitalising water bodies into drainage improvement works and development of New Development Areas, the community will be further benefited from the improved environment. In revitalisation of river as well as the drainage planning of new development areas in the future, the Government could consider adopting new standards in the planning and construction of drainage facilities with a view to providing a better environment for the public.

REFERENCES

- [1] Binnie Manusell Consultants (1993), Territorial Land Drainage and Flood Control Strategy Study – Phase 2, Report to Drainage Services Department, Hong Kong Government.
- [2] Drainage Services Department (2015), DSD Practice Note No. 1/2015 – Guidelines on Environmental and Ecological Considerations for River Channel Design, Drainage Services Department, The Government of HKSAR, http://www.dsd.gov.hk/EN/Files/Technical_Manual/dsd_TechCirculars_n_PracticeNotes/DSDPN_201501.pdf (Accessed 27 September 2016).
- [3] Mott-MacDonald (1990), Territorial Land Drainage and Flood Control Strategy Study – Phase 1, Report to Drainage Services Department, Hong Kong Government.
- [4] Scott J. L. (ed.) (2015), Going the Extra Miles, Drainage Services Department, The Government of HKSAR, pp 109-157, http://www.dsd.gov.hk/EN/Files/publications_publicity/Publications/2014book.pdf (Accessed 27 September 2016)
- [5] The Government of HKSAR (2015), 2015 Policy Address, The Government of HKSAR, Paragraph 181.

Session 2.12: Process of Urban Regeneration

Energy Benchmarking Tool for Low-Carbon Transformation in Hong Kong: A Scientific Approach and Its Practical Applications

Jason JZ YANG^a, Alvin TY LO^b, Karen HY CHEUNG^c, Cary WH CHAN^d, Benny KM CHOW^e, Paul SK SAT^f

^a Arup, Hong Kong SAR, jason.yang@arup.com

^b Arup, Hong Kong SAR, alvin.lo@arup.com

^c Hong Kong Green Building Council Ltd., Hong Kong SAR, karen.cheung@hkgbc.org.hk

^d Hong Kong Green Building Council Ltd., Hong Kong SAR, cary.chan@hkgbc.org.hk

^e Hong Kong Green Building Council Ltd., Hong Kong SAR, benny.chow@hkgbc.org.hk

^f Hong Kong Green Building Council Ltd., Hong Kong SAR, paul.sat@hkgbc.org.hk

ABSTRACT

World energy consumption has increased rapidly in recent years and shows no indication of slowing. In Hong Kong, this situation is more critical due to its high demand in urban energy consumption and scarcity of natural resources within its jurisdiction. To push Hong Kong to the very forefront of the fight against climate change and form a **low-carbon urban transformation, energy benchmarking is one of the most effective ways to set up industry's best practice and achieve sustainable development.**

While there exist a few benchmarking programmes worldwide, such as ENERGY STAR Portfolio Manager in the US, NABERS in the Australia, they are limited to benchmarking the existing buildings without customised improvement advice to enhance energy efficiency. Hong Kong, with its extremely high-density urban form, starts to develop its own benchmarking tools in recent years for the unique built environment, some early attempts include HK BESTOO developed by Hong Kong Green Building Council (HKGBC) and Energy Utilisation Indexes and Benchmarks developed by Electrical and Mechanical Services Department (EMSD).

In order to accelerate the low-carbon urban transformation, a more comprehensive benchmarking system is needed to evaluate and improve the whole building energy performance. It will surpass the existing benchmarking programmes around the world by assessing the building to the system-level details and provide ratings based on **different building system types. Additionally, the world's first "What-If" Function will provide the building owner with tailor-made suggestions to improve the building energy performance.** This paper reviews the state-of-the-art methods in building energy benchmarking and proposes a new benchmarking system specifically catering to **Hong Kong's unique built environment to promote the low-carbon urban transformation in Hong Kong.** This project was initiated by the HKGBC with the aim to improve building energy performance in Hong Kong. Arup was appointed as the consultant to undertake studies.

Keywords: low-carbon, urban transformation, energy benchmarking

1. INTRODUCTION

In Hong Kong, buildings account for 60% of carbon emission and 90% of electricity use (HKPC, 2016). Focusing on making buildings more energy efficient with the initiative of the HKGBC is the key to grasping the opportunity **of meeting Hong Kong's carbon reduction target** without going into the current fuel mix debate. As shown in Figure 1, in order to fit in the roadmap of the overall carbon reduction target, 52% of the reduction in electricity in the building sector needs to be achieved by 2030, as compared to the level of 2005 (HKGBC, 2014). According to the Buildings Department, there are around 2,459 existing office/commercial buildings in Hong Kong. With proper strategies, retrofitting and optimising these existing buildings can bring large reduction to the entire building sector, **almost half of the target. Along with Hong Kong's high-density building context,** comes the large variation in building functions and base building provision. Simply comparing the Energy Utilisation Index (EUI) may miss the underlying factors and opportunities for improvement in energy efficiency. Among current available policies and strategies, benchmarking is likely the best tool to push the baseline of existing buildings and drive the market to meet this long-term target for Hong Kong. In the latest Energy Saving Plan from the Hong Kong Government also emphasises the importance of energy benchmarking as the first stage of the energy saving and green building

transformation (Environment Bureau, 2015). This paper focuses on the benchmarking of Central Building Services Installation (CBSI) of Commercial Buildings (Office/ Retail) (HK BESTCOM).

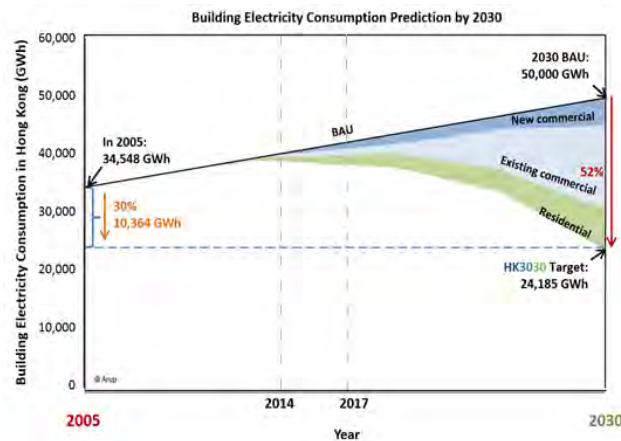

Figure 1: Impact of carbon reduction in Hong Kong's building sector

1.1 State-of-the-art methods and existing rating programmes worldwide

Originally, the word “benchmark” was used exclusively in topography to precisely define a reference point in terrain or geological analysis. When the term was first used in building industry, it referred to energy benchmarking, specifically assessing the energy performance of buildings of similar type. Many research projects have been conducted since the emergence of energy benchmarking in building industry. Broadly, the existing energy benchmarking methods can be put into four categories (Sartor et al., 2000):

Points-based Rating System: A system provides standards and guidelines to measure how efficient and environmentally friendly a facility is. A good example is the USGBC's Leadership in Energy and Environmental Design (LEED) rating system. However, the scoring system for building energy efficiency can be misleading, which requires a careful review of the points-based rating mechanism (Turner and Frankel, 2008).

Hierarchical and End-use Metrics: It is a process of categorising the whole building level energy use and gradually looks into the underlying systems and components level to capture the performance data. This approach requires segmented data that are usually not readily available, which requires the sub-metering of the system and component loads, following the hierarchical process (Sartor et al., 2000).

Statistical Approach (Regression): Statistics for a population of similar buildings are used to generate a benchmark against which the building Energy Utilisation Index (EUI) is compared. This data-driven methods provide an efficient method to compare building energy performance (Chung, 2011) (Hong et al., 2015). This method can effectively normalise the EUIs by removing the effect of building characteristics (Chung, et al., 2006). US Environmental Protection Agency's **ENERGY STAR Portfolio Manager Programme**, for example, accounts for the differences between buildings through the use of regression models and normalisation methods that are used to generate a ranking score based on energy efficiency ratios (ENERGY STAR, 2011).

Simulation Model-based Approach: It calculates energy benchmarks based on an idealised model of building performance. Modelling approach in benchmarking has the advantage of flexibility, able to be tweaked to account for a wide range of factors that contribute to variation in energy use. A disadvantage is the gap between the calibration of simulation modelling and actual building operation (Sartor et al., 2000).

Globally, several building benchmarking programmes have been developed based on some the above methods. **The US EPA's ENERGY STAR Portfolio Manager Programme and National Australian Built Environment Rating System (NABERS)** are based on historical energy consumption data and adopts statistical approach (Hicks and Neida, 2000) (Hicks and Clough. 1998). **ASHRAE's Building Energy Quotient (bEQ) rating system** adopted the simulation model-based approach for its “As Designed” evaluation method. For Singapore, the benchmarking reporting is conducted annually. However, there is some preliminary analysis and normalisation for chiller ages, data centre area, etc. (BCA, 2016).

1.2 Challenges in benchmarking programmes in Hong Kong

Though many building benchmarking programmes are available, they may hold certain limitations in the case of the benchmarking programme in Hong Kong. Existing programmes such as ENERGY STAR Portfolio Manager Programme and NABERS are based on local building context and are not globally compatible, especially in Hong Kong, where buildings are unique in their complex mixed-use nature. More studies were conducted identifying other energy performance factors beyond the current limitation of existing benchmarking programmes (Olofsson et al., 2004) (Signor et al., 2001).

Based on the literature review, it can be concluded that the statistical approach is adopted by a majority of the benchmarking programmes. However, a tailor-made methodology for building energy benchmarking in Hong Kong **should be developed based on Hong Kong's building context and associated factors. On top of that**, more innovative functions shall be created to accelerate the retrofit of existing buildings and drive the low-carbon transformation in Hong Kong.

2. METHODOLOGY

2.1 General considerations

In order to develop a new benchmarking programme for Hong Kong based on the statistical approach, it is essential to understand the benchmarking process. Through extensive research on various studies to conduct building benchmarking (Matson and Piette, 2005) (Pérez-Lombard et al., 2009), it can be concluded that a qualifying building energy benchmarking process should contain at least four steps illustrated in Figure 2. This process should not be treated as a purely statistical process, but rather an integrated process supported by both solid engineering reasoning and statistical analysis.

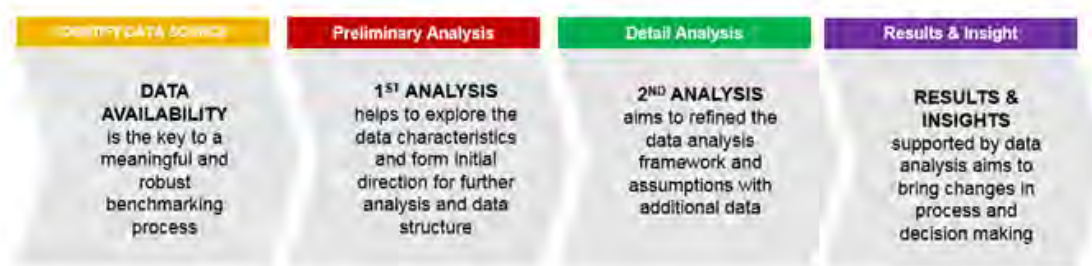

Figure 2: Basic steps of building energy benchmarking process

The process of benchmarking is to normalise, or in other words, to eliminate variation in buildings' inherent characteristics before evaluating their energy use. There are some fundamental rules that should be clarified before this method could be applied to the real database. The building energy consumption depends on many parameters. These parameters include physical constraints (system type, area, operation pattern, etc.) and performance factors (lighting power density, system efficiency, etc.). These physical constraints explain the basic characteristics of a building, while the performance factors are performance related, which describe how efficiently a building performs given its physical constraints. Though the performance factors are directly related to the energy consumption, they **are not parameters that explain buildings' physical variations and therefore should not be used for normalisation.** Instead, the performance factors could be used for energy use prediction and optimisation.

Before going into the details of methodology, it is necessary to visualise the process of the benchmarking tool from **the users' (building owners and management company) perspective in order to optimise** its attributes. Based on the characteristics of the two types of parameters, a new benchmarking tool can be developed containing two major functions: i) A Basic Tool for building normalisation supported by statistical analysis; ii) An Advanced Tool **based on performance factors with "What-If" Function, which serves the purpose of the retrofit optimisation process.** Two functions can be integrated as shown in Figure 3 to form a feedback system and help make decisions for energy efficient retrofitting.

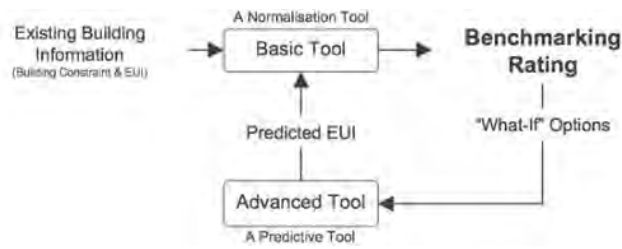

Figure 3: The integrated benchmarking system

2.2 Data processing

Data Collection and Filters

The database for the energy benchmarking was established with the support from Electrical and Mechanical Services Department (EMSD). Data sets were initially collected and analysed for the purpose of the development. Due to the variation of data quality, a filtering process was designed to remove outliers inappropriate for the benchmarking tool. Certain data sets were filtered out to ensure that the remaining can represent the energy use pattern of typical buildings in Hong Kong.

Categorisation

Through the preliminary analysis, the distinctive difference in EUI is found for buildings with centralised system of air handling unit (AHU) or fan coil unit (FCU) and decentralised systems (Figure 4). This is mainly due to the difference in energy use by air-side systems. For AHU and FCU system, the fan energy for distributing the conditioned air is on account of the building owner and tenant respectively. For the decentralised system, all the energy associated with air-conditioning is consumed by the tenant. So it is necessary to divide the buildings into three categories based on these system types.

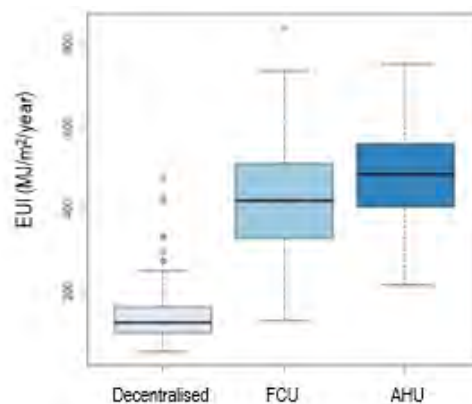

Figure 4: EUI for commercial buildings with different air-conditioning systems

2.3 Basic tool development

Regression Analysis

For the Basic Tool, the main focus was to develop a multivariate regression model for each of the category, namely FCU, AHU and Decentralised buildings. In order to make sure the regression equations represent the effect of the most significant features affecting the building energy performance, the development process includes: i) Reviewing available variables as building constraints; ii) Perform regression iterations by including different variables and transformations; iii) Review statistical indicators and determine the best regression model.

The statistical indicators adjusted R-Squared and t-scores are both investigated during the process. Since the regression model is not a prediction tool, adjusted R-Squared alone can be misleading because it is affected by the characteristics of the database and chosen variables. So the t-scores were also investigated to make sure the level of uncertainty associated with regression parameter estimates are minimised for the statistical analysis.

Rating System

After the regression model is developed, a rating scale for the building energy performance can be established based on the Energy Efficiency Ratio (EER):

$$EER = \frac{EUI_{measured}}{EUI_{normalised}}$$

Equation 1

With the above ratio, a building can find out its relative performance against other buildings from the percentile ranking shown in Figure 5. If a building's $EUI_{measured}$ is lower than $EUI_{normalised}$, the EER value and percentile value will be lower, indicating the building is more energy efficient when compared to the market norm. For example, if the corresponding percentile is 20th, its energy performance is better than 80% of the similar buildings.

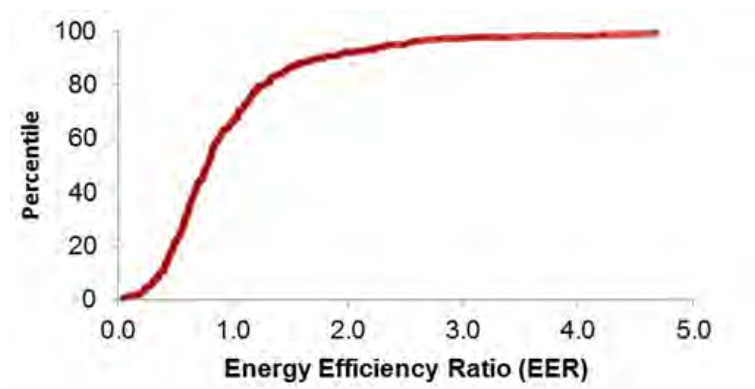

Figure 5: Distribution density and cumulative distribution function for the rating system

2.4 Advanced tool development

The Advanced Tool provides opportunities for strategic planning and future improvement before actual implementation, which overcomes the limitation that the existing benchmarking tools only provide the rating based on the normalised building EUI. The “What-If” Function focuses on three major systems: air-conditioning, lighting and lifts. To achieve that, the correlation between the change of performance factors and the relative energy saving for that particular system should be understood, and then the energy saving for the whole building can be predicted. Among the three systems, the air-conditioning system is the most sophisticated with many possible configurations. Series of energy models were simulated to allow user to choose from as many as 12 systems with different heat rejection types, chiller types (constant speed vs variable speed), chilled water supply loops and oil-free chillers. For each case, a range of average rated coefficient of performance (COP) values was simulated. All the simulation results form a large matrix of energy consumption for a typical building. Once the “What-If” Function knows which case the existing system belongs to, the relatively more efficient systems will show up in the “What-If” Function as improvement options. The “What-If” Function for lighting is based on the calculation of the change in lighting power density, operation hours and occupancy sensors. For lifts, the “What-If” Function focuses on lift system type with different efficiencies.

3. DEVELOPMENT OF THE ONLINE PLATFORM

The outcome of the study is a comprehensive online platform for commercial buildings (office/retails) in Hong Kong (<http://hkbest.hkgbc.org.hk>) as part of HKGBC Benchmarking and Energy Saving Tool Series to target the key energy consuming sectors. The Free Benchmarking Tool gives a general rating for the user and the Recognition Scheme is a paid service that offers detailed rating output and Advanced Tool with “What-If” Function. It is also a certified rating process with the engagement of an authorised assessor to provide professional advice.

4. CONCLUSION

Traditionally, a one-dimensional index was used to describe energy efficiency, comparing a building's energy use over time against itself. This provides little insight into improvement actions for individual buildings. In response, this paper introduced a new approach to transform Hong Kong into a low-carbon urban development. The outcome of the study is an integrated benchmarking system developed for Hong Kong's unique building context to evaluate the building energy performance and provide optimal retrofit measures with a "What-If" Function. This benchmarking programme has been developed to support decision making by revealing high-level information such as each building's market position in terms of energy use, energy-saving potential for the key energy consuming building sectors and the local market's performance compared to the rest of the world. This allows building owners to understand the real energy performance against similar buildings through a verified assessment process. The successful launch of the tool is a milestone for Hong Kong to achieve its long-term energy-saving target.

ACKNOWLEDGEMENT

This is a consultancy study commissioned by the HKGBC and the project with funding support by the Construction Industry Council. The project team is indebted to the Construction Industry Council, the HKGBC, EMSD and other organisations that have contributed to the collection of building data together with excellent advice and insights in the process of the development.

REFERENCES

- [1] BCA, 2016. Building Energy Benchmarking Report 2016. Retrieved from: https://www.bca.gov.sg/GreenMark/others/BCA_BEER_Abridged_FA_2016.pdf [Retrieved on 3 January 2017].
- [2] Chung, W, 2017. Review of building energy-use performance benchmarking methodologies. *Applied Energy*, 88(5), pp. 1470–1479.
- [3] Chung, W., Hui, Y.V. and Lam, M.Y., 2006. Benchmarking the energy efficiency of commercial buildings. *Applied Energy*, 83(1), pp. 1–14.
- [4] ENERGY STAR, 2011. Energy Star performance ratings – technical methodology. Retrieved from: https://www.energystar.gov/ia/business/evaluate_performance/Technical_Description_Hospitals_Nov_20_11.pdf [Retrieved on 15 July 2014].
- [5] Environment Bureau, 2015. Energy Saving Plan for Hong Kong's Built Environment 2015–2025+. Retrieved from: <http://www.enb.gov.hk/sites/default/files/pdf/EnergySavingPlanEn.pdf> [Retrieved on 3 January 2017]
- [6] Hicks, T. W., and B. von Neida, 2000. An evaluation of America's first ENERGY STAR buildings: The class of 1999, Proceedings of 2000 ACEEE Summer Study on Energy Efficiency in Buildings, August 20-25, California, 20-25 August.
- [7] Hicks, T., and D. Clough. 1998. The ENERGY STAR building label: Building performance through benchmarking and recognition. Paper presented at Proceedings of the ACEEE 1998 Summer Study on Energy Efficiency in Buildings.
- [8] Hong Kong Green Building Council, 2014. Market drivers for transformation of green buildings in Hong Kong. Retrieved from: https://www.hkgbc.org.hk/ebook/HKGBC_Roadmap/index.html [Retrieved on 11 August 2016].
- [9] Hong, T., Piette, M.A., Chen, Y., Lee, S.H., Taylor-Lange, S.C., Zhang, R., Sun, K. and Price, P. (2015) 'Commercial building energy saver: An energy retrofit analysis toolkit', *Applied Energy*, 159, pp. 298–309.
- [10] Matson, N. E., and M. A. Piette. 2005. Review of California and national methods for energy performance benchmarking of commercial buildings. Retrieved from: <http://escholarship.org/uc/item/48h3s3d2> [Retrieved on 10 August 2016].
- [11] Olofsson, T., A. Meier, and R. Lamberts. 2004. Rating the energy performance of buildings. *Int. J. Low Energy Sustain Build*, 3, 1-18.
- [12] Pérez-Lombard, L., J. Ortiz, R. González, and I. R. Maestre, 2009. A review of benchmarking, rating and labeling concepts within the framework of building energy certification schemes. *Energy and Buildings*, 41 (3): 272-8.

- [13] Sartor, D., M. A. Piette, W. Tschudi, and S. Fok, 2000. Strategies for energy benchmarking in cleanrooms and laboratory-type facilities. Proceedings of 2000 ACEEE Summer Study on Energy Efficiency in Buildings, August 20-25, California, 20-25 August.
- [14] Signor, R., F. S. Westphal, and R. Lamberts, 2001. Regression analysis of electric energy consumption and architectural variables of conditioned commercial buildings in 14 Brazilian cities. Paper presented at Seventh International IBPSA Conference, Brazil, 13-15 August.
- [15] The Hong Kong Productivity Council (HKPC), Carbon Manager, Retrieved from: <http://carbon-manager.hkpc.org/website/eng/intro.asp>. [Retrieved on 01 September 2016].
- [16] Turner, C., M. Frankel, and U. S. G. B. Council. 2008. Energy performance of LEED for new construction buildings. New Buildings Institute Washington, DC.

Sustainability Indicators for the Assessment of the Energy System

Lisa ANDES^a, Thomas LÜTZKENDORF^b, Jürgen KOPFMÜLLER^c, Christine RÖSCH^d

^a Institute of Sustainable Management of Housing and Real Estate (OEW), Karlsruhe Institute of Technology, Germany, lisa.andes@kit.edu

^b Institute of Sustainable Management of Housing and Real Estate (OEW), Karlsruhe Institute of Technology, Germany, lisa.andes@kit.edu

^c Institute for Technology Assessment and Systems Analysis (ITAS), Karlsruhe Institute of Technology, Germany, juergen.kopfmueeller@kit.edu

^d Institute for Technology Assessment and Systems Analysis (ITAS), Karlsruhe Institute of Technology, Germany, christine.roesch@kit.edu

ABSTRACT

The discussion about sustainability in the construction and real estate sector was so far mainly focused on the contribution of individual buildings, quarters or cities to sustainable development. Several sustainability assessment systems have been developed and applied, which include technical, environmental, economic and social aspects.

Energy production and consumption has a major impact on sustainable development. Hence, the amount and impact of resource usage and environmental degradation associated with the construction sector and occurring within the life cycle of buildings are depending on the characteristics of the existing energy system. Private households shift to being consumers and producers of energy, thus becoming a more important part of the complex energy system. Furthermore, nature and amount of energy usage influence life cycle costs of buildings, affordability of housing, or external costs caused by the energy systems.

Due to the high relevance of sources and the efficiency of energy use for realising sustainable development, as well as increasing interdependencies between buildings and energy generation and usage, energy systems become accordingly relevant as a distinct object of sustainability assessment.

This article will concentrate on the question which criteria and indicators are appropriate to describe and assess the sustainability of energy systems. Two basic approaches will be outlined: firstly, the development and use of checklists or indicator sets, providing orientation for the collection and interpretation of data raised, and a basis for context-specific selections of indicators, by investigating each indicator separately. Secondly, the development and use of indicator systems, which provide a fundament for a finally aggregated assessment result. Methodological and conceptual questions associated with these two approaches that are discussed in this article can also be transferred to other subjects of assessment.

The article is based on preliminary results of an ongoing research project in Germany, financed by the German Helmholtz Association.

Keywords: energy measurement and verification, sustainability assessment, indicator sets and systems

1. INTRODUCTION

The focus of sustainability-related debates in the construction sector is presently shifting from individual buildings to much more complex subjects of investigation, in particular urban residential districts and entire cities. The latter should no longer be considered being the mere sum of all buildings. Due to their close interconnections, they also have to be an assessment objective of a scientifically-based system analysis as spatial units. Sustainability assessment systems such as DGNB, LEED and BREEAM provide criteria especially for cities and urban quarters, which focus on an evaluation of the ecological, economic, socio-cultural, technical performance as well as the quality of the planning. They examine all relevant topics and issues of sustainability, including the supply of energy. Beyond the rather crude way of addressing energy issues in these existing tools, energy systems, as increasingly relevant subjects of sustainability assessment particularly in urban contexts, have to be analysed in a more comprehensive and integrated way. Main reasons for this are:

- The energy system, similarly to other basic supply systems, has to be understood as a socio-technical system, in which technical and social elements and realities interact in various ways.
- Options, opportunities and challenges of integrated solutions for the generation of renewable electricity and heat are becoming more diverse and complex, e. g. due to new actors. For instance, buildings are no longer only consumers in the energy market, but also producers ("prosumer"). Developing integrated solutions gains more and more importance for local energy supply and grid operation. The current trend in implementing such approaches promotes decentralization of the energy system towards a "smart" network based on many small regional and local units that provides innovative network and system implemented out in compliance with the principles of sustainable development.
- In order to protect ecosystems, a more environmentally sound energy generation and usage is required, in addition to a more efficient usage of materials based on the idea of a circular economy. Resource use and environmental degradation are strongly influenced by the direct use (e.g. heating and lighting in buildings) and indirect use of energy (e.g. included in building materials to newly construct, restore and maintain buildings). In principle, the energy supply sector can be regarded as an up-streamed branch of the construction industry; therefore, it should be carefully analysed how a transformation of the energy supply towards more sustainability affects the sustainability of the construction industry.
- Official international and national objectives and target values, and according political decisions, such as the Agenda 2030 and the Sustainable Development Goals at the global scale or National Sustainability Strategies, clarify and reinforce the key role of energy for social and economic development in line with the objectives of environmental protection.

In Germany, this led to a discussion about the sustainability of energy supply and the sustainability assessment of future options to design the national energy system. The national federal German energy concept from 2011 is based on the three classical energy policy goals energy supply security, affordability and environmental compatibility. One key statement of this article is that ensuring energy system sustainability requires considering additional assessment criteria beyond the three classical ones mentioned above, such as health compatibility, equitable distribution, low risk, or societal participation. To check the degree to which these requirements and goals are met, suitable tools are needed to describe, assess, and steer the energy system. In addition to technical functionality, these tools have to focus on interrelationships between energy technologies and the natural environment, the economy and the society. Suitable assessment criteria and indicators and their flexible use in terms of a checklist will be discussed in the following.

2. ENERGY SYSTEMS AS OBJECTS OF ASSESSMENT

A system can be defined as a "set of elements with certain properties, of their interdependencies, and of their interactions with the environment". Energy systems are commonly understood to be technical systems for the supply of energy. Active elements of these systems are technical facilities to produce primary energy carriers as well as systems to convert, store, transport, and use energy. Passive elements of the system are the energy carriers used. The attributes of these elements are of technical (e.g. capacities, efficiencies, availabilities, calorific values), economic (e.g. energy costs, plant and operation costs), and ecological character (e.g. emissions, consumption of resources). Implementation of the necessary transformation processes to meet goals, such as the **German 'Energiewende', however, requires the energy system to be understood as a socio-technical system**, in which technical and social elements and realities interact in various ways. The energy system is an open system interacting with overall economy, the environment, and the society, which represent corresponding systems. The state of this socio-technical system is characterized by certain attribute values at a certain time. System boundaries have to be chosen as a function of the object and perspective of assessment. When defining the system to be assessed, geographical conditions have to be specified. The existing technical system and the corresponding systems are determined by the geographic area in which they act and interact. Moreover, the time horizon has to be specified (hourly, annual or perennial assessment).

When deciding on detailed goals or action strategies, it is therefore important to not only consider the supply side, technologies, and infrastructures, but also the demand side and in particular the consumer and user behaviour of private and public actors involved as well as their interests, needs, and their rights of disposal. Moreover, the **society's acceptance of existing or new system elements, its participation in decision processes, and the handling of existing or expected conflicts** have to be assessed.

3. ASSESSMENT CRITERIA AND INDICATORS – SET OR SYSTEM?

Assessment of sustainability is based on criteria and indicators. Indicators essentially serve to facilitate the representation of complex situations. They can be used as orientation aids in decision, control, and communication processes. Indicators initiate and support discussion, learning, and awareness building processes.

Indicators may be grouped in sets and systems. A set of indicators is a compilation of indicators used in a certain assessment context. This list can be complemented any time. A system of indicators essentially consists of a defined set of indicators and other components adapted to the assessment object. Local and spatially superordinate (national or international) indicator systems mainly differ in their basic understandings of contents, measurement variables used, reference values, and in the goals and addressees of indicator use. Use of internationally established indicator systems allows for a regular comparison of developments in different countries. Frequently, indicator systems serve to determine a fully aggregated index. This approach is associated with both advantages and drawbacks (easy communication of information versus information loss and problem of determining weighing factors). While the number of indicators in indicator systems is adapted at longer intervals only, a set of indicators can be adapted continuously.

Indicator systems are used in scientific and politico-institutional contexts on various spatial and political levels, e.g. on the supranational level of the European Union. Here, key indicators have been selected for ten areas. These key indicators are further detailed by so-called operative and describing indicators. As an example, the area of climate change and energy is outlined in Table 1. Every two years, the indicator system is used to assess changes as a function of time.

Area	Key Indicator	Operative Indicators	Describing Indicators
Climate change and energy	<ul style="list-style-type: none"> Primary energy consumption 	<ul style="list-style-type: none"> Energy dependence; share of renewable energies in gross end energy consumption 	<ul style="list-style-type: none"> Domestic gross energy consumption of fuels Electricity production from renewable energy sources Share of renewable energy sources in fuel consumption of traffic Co-generation systems

Table 1: Energy-related indicators of the EU Sustainable Development Strategy (EU SDS).

4. ADDITIONAL CRITERIA AND INDICATORS NEEDED FOR THE ASSESSMENT OF ENERGY SYSTEMS

Chapter 40 of Agenda 21 adopted by the United Nations Conference on Environment and Development (Rio de Janeiro, Brazil, 1992) already requested development and use of measurement parameters or criteria to assess national and international development processes. As in other sectors, the information obtained with the help of indicators in the energy sector mainly serves to analyze and evaluate the success or failure of measures taken (e.g. in the context of the 'Energiewende') and to determine trends. This information is the basis of consulting services and decision-making. Development and use of suitable indicators depend on normative or methodological goals as well as on the target group addressed (experts, politicians, public, energy consumers and so on).

Requirements to be met by indicators for the analysis of the energy system are listed in Table 2. They have to be considered when determining additional indicators.

Scientific Requirements	Representativeness and adequacy as regards ecological, economic, and social contexts; reproducibility of results; reproducibility of aggregation and of selection criteria; data quality; transparency of methods, assumptions made, or uncertainties of data
Functional Requirements	Sensitivity to changes in the course of time, suitability for determining trends, early warning, international compatibility, sensitivity to economic, ecological, and social interactions
Requirements from the User's Perspective	Goal orientation, addressee-adequate concentration of information, political controllability, understandability by politics and the public, consensus in society on the suitability of an indicator for presenting relationships and on the interpretation context
Practical Requirements	Data availability, possibility of regular updates, acceptable data supply expenditure

Table 2: Requirements to be met by energy-related indicators.

From the goals, such as the preservation of the ecosystem, saving of resources, maintenance of capital, securing health, comfort, and social solidarity, assessment criteria can be derived to support the development and specification of suitable indicators. Such criteria are listed in the left column of Table 3.

5. APPLICATION EXAMPLE: “ENERGY-TRANS” PROJECT

Within the framework of the ENERGY-TRANS Helmholtz Alliance, sustainability indicators were developed to assess the energy system in Germany with the participation of the authors of this article. The project was aimed **at defining indicators to better study the energy system from the society's demand and user side and to better analyze the interfaces between technical and social factors that decisively affect the required system transformation process.** The set of indicators proposed by the Alliance included generally accepted techno-economic and ecological indicators, such as energy consumption, energy efficiency, emission rates, or the share of renewable energy sources in energy production. Such indicators are also used in the monitoring report of the federal government. In addition, the Alliance proposed other indicators, such as areas needed for energy plants or the extent of internalizing external costs in the energy system, and indicators to better represent the socio-technical characteristics of the system. The latter describe the interaction and active participation of citizens in the transformation of the energy system or possibilities of participation in decision processes when planning infrastructure projects in the energy sector.

The left column of Table 3 lists criteria for a systematic assessment of the energy system on the national level as well as topics and indicators discussed in literature. This list does not claim to be complete and may be extended. It is to serve as a checklist or selection menu for a first assessment. The right column lists the indicators developed in the ENERGY-TRANS project, thus illustrating how the catalogue can be complemented.

criteria	indicators ENERGY-TRANS
overall economy („macro level“)	<ul style="list-style-type: none"> • Use of Primary Energy, Final Energy Productivity of the German Economy, Final Energy Productivity of the German Industry, Final energy consumption of private households per capita, Final Energy Productivity of Trade, Commerce and Services; Specific Energy Consumption of Households for Heating (Temperature Adjusted), Final Energy Consumption in the Transport Sector, Modal Split in the Transport Sector
energy transformation sector	<ul style="list-style-type: none"> • Share of Renewable Energy on Gross Final Consumption of Energy, Installed Capacity of Renewable Energy Power Plants
emissions	<ul style="list-style-type: none"> • Energy-related Greenhouse Gas Emissions, Energy-related Emissions of Acid-forming Gases
health risks	<ul style="list-style-type: none"> • Energy-related Emissions of Particulate Matter, Energy-related Emissions of Cadmium, Energy-related Emissions of Mercury,
environmental risks	<ul style="list-style-type: none"> • Amount of High-Level Radioactive Waste which has not been transferred to a safe final disposal place, Energy-related Hazardous Solid Wastes,

causally determined economic factors	<ul style="list-style-type: none"> • Energy Import Dependency, Volume of publicly financed loans for energy-related investments, Market Share of the Four Biggest Electricity Companies in Total Electricity Production • Share of Employees in the Renewable Energy Sector on Total Employees, Gender Pay Gap in the Highest Salary Group in the Energy Sector, Relation of technician salary to manager salary in the big energy suppliers, Not used renewable electricity due to management measures
affordability	<ul style="list-style-type: none"> • Monthly energy expenditures of households with a monthly net income less than 1,300 Euros
support to developing countries	<ul style="list-style-type: none"> • Share of Development Aid Expenses for Energy-related Projects on Total GDP
stock of energy resources (deposits, potential of renewable energies)	Not covered
avoided environmental damages	<ul style="list-style-type: none"> • Added Value Creation from Energy Efficiency Measures in Households,
external benefits	<ul style="list-style-type: none"> • Added Value Creation from the Renewable Energy Sector
external costs (damage costs)	Not covered
internalization of external costs	<ul style="list-style-type: none"> • Degree of Internalization of energy-related external costs
research and development	<ul style="list-style-type: none"> • Number of University Graduates in the Field of Energy Sciences, Federal Expenditures for Energy Research, Number of German Patents in the Field of Renewable Energy and Energy Efficiency, Number of Start-ups in the Renewable Energy and Energy Efficiency Sector, Relation between Costs saved for Imported Conventional Fuels and Investments in RE Technologies
competition for land	<ul style="list-style-type: none"> • Area under Cultivation of Energy Crops
acceptance by the general public/ society	<ul style="list-style-type: none"> • Acceptance of Grid Extension for Achieving 100% Renewable Energy Supply, Acceptance of Renewable Energies in the Neighborhood, Share of Population Satisfied with Opportunities to Participate in Decision Making for power transmission grids, Share of Tourists Who Perceive Energy Power Technologies as Being Disruptive in the Vacation Region Share of Population living in Regions with the Objective to shift to 100% Renewable Energy
tourism	Not covered
demographic factors	<ul style="list-style-type: none"> • Share of Households Buying Renewable Electricity
transport structure	<ul style="list-style-type: none"> • Number of Electric Vehicles
efficiency of energy use	<ul style="list-style-type: none"> • Share of Installed Smart Meters Mandatory for Large Electricity Consumers
grid infrastructure (e.g. investments in the energy transport infrastructure)	Not covered
spatial distribution of power plants (e.g. degree of centrality vs. de-centrality of energy generation plants)	Not covered
ownership situation	<ul style="list-style-type: none"> • Number of Energy Cooperatives Engaged in Renewable Energy Plants, Share of Households Producing Renewable Electricity
supply reliability and quality of voltage	<ul style="list-style-type: none"> • SAIDI (System Average Interruption Duration Index) of Electricity

power generation technologies (e.g. installed generation capacity, efficiency, conversion and distribution losses, level and pace of innovation, type of conversion technology)	Not covered
compliance	<ul style="list-style-type: none"> • Share of regulatory tools in the planning of power transmission grids which fulfil participation requirements

Table 3: „Checklist“ for a systematization of the valuation object „energy system“

Based on this comprehensive list of indicators, indicator systems can be compiled for specific assessment tasks. This compilation may also include further information, methods, and algorithms for analysis and assessment of the indicators. In this way, the assessment method can be adapted flexibly to the respective contexts. Practical implementation is being discussed at the moment.

6. OUTLOOK

Apart from the selection of suitable indicators and their analysis and evaluation with appropriate methods, interactions among these indicators and the goals defined are important, but have hardly been considered systematically so far. Interaction analyses are required to identify and study existing or potential target conflicts and to determine indicators of higher or lower relevance (due to the number and intensity of interactions with other indicators). This will help more adequately develop problem solution strategies. The highly suited cross-impact analysis method has not yet been applied systematically in most of the indicator-based studies in the energy and other sectors. Here, there is a considerable need for analysis and research in the future.

REFERENCES

- [1] Drosdowski, T., 2015. Theorie der Haushaltsenergieproduktion und die Transformation des Energiesystems, Osnabrück.
- [2] Bundesregierung, 2011. Der Weg zur Energie der Zukunft: sicher, bezahlbar und umweltfreundlich, Berlin.
- [3] Bundesministerium für Wirtschaft und Energie (BMWi), 2015. Ein gutes Stück Arbeit - Die Energie der Zukunft: Vierter Monitoring-Bericht zur Energiewende, Berlin.
- [4] AGECC - UN Secretary General's Advisory Group on Energy and Climate change. Energy for a Sustainable Future: Report and Recommendations, New York.
- [5] German Advisory Council on Global Change (WBGU), 2003. World in Transition: Towards Sustainable Energy Systems, Berlin [u.a.].
- [6] Expertenkommission zum Monitoring-Prozess „Energie der Zukunft“, 2015. Stellungnahme zum vierten Monitoring-Bericht der Bundesregierung für das Berichtsjahr 2014, Berlin, Münster, Stuttgart.
- [7] Chr. Rösch (2017). Ethics of Sustainability—An Analytical Approach. In: The Ethics of Technology (Ed. Sven Ove Hansson), Rowman & Littlefield International, Ltd., London, pp 17-35.
- [8] Rebhan, E., 2013. Energiehandbuch: Gewinnung, Wandlung und Nutzung von Energie, Berlin [u.a.].
- [9] Ropohl, G., 2009. Allgemeine Technologie: Eine Systemtheorie der Technik, Karlsruhe.
- [10] Grunwald, A., Poganietz, R.-W., 2010. Auf dem Weg zu einer nachhaltigen Energieversorgung: Beiträge von TA und Energiesystemanalyse, in: Institut für Technikfolgenabschätzung und Systemanalyse (ITAS) (Ed.), Technikfolgenabschätzung, Theorie und Praxis. Auf dem Weg zu einer nachhaltigen Energieversorgung - Beiträge von TA und Energiesystemanalyse, 4–11.
- [11] Grunwald, A., Kopfmüller, J., 2012. Nachhaltigkeit: eine Einführung, 2. aktualisierte Auflage, Frankfurt, New York.
- [12] Opschoor, H., Reijnders, L., 1991. Towards sustainable development indicators, in: Onno Kuik, H.V. (Ed.), In Search of Indicators of Sustainable Development, 7–27.
- [13] Heiland, S., Tischer, M., Döring, T., Pahl, T., Jessel, B., 2003. Indikatoren zur Zielkonkretisierung und Erfolgskontrolle im Rahmen der Lokalen Agenda 21, Berlin.
- [14] eurostat. Climate change and energy – Eurostat [online]. Retrieved from: <http://ec.europa.eu/eurostat/web/sdi/indicators/climate-change-and-energy> [Retrieved on January 2017].

- [15] Vereinte Nationen (UN), 1992. AGENDA 21 Konferenz der Vereinten Nationen für Umwelt und Entwicklung, Rio de Janeiro.
- [16] Hofer, P., AG, P., Scheelhaase, J., Wolff, H., 1998. Nachhaltige Entwicklung im Energiesektor?: Erste deutsche Branchenanalyse zum Leitbild von Rio, Heidelberg.
- [17] Deutsches Institut für Wirtschaftsforschung (DIW), Fraunhofer Institut für Systemtechnik und Innovationsforschung (ISI), 1997. Energie-Effizienz-Indikatoren: Statistische Grundlagen, theoretische Fundierung und Orientierungsbasis für die politische Praxis, Berlin.
- [18] Coenen, R., 2000. Konzeptionelle Aspekte von Nachhaltigkeitsindikatorensystemen, Karlsruhe.
- [19] Rösch, K.-B. Bräutigam, J. Kopfmüller, V. Stelzer, P. Lichtner (2017): Indicator System for the Sustainability Assessment of the German Energy System and its Transition. Journal: Energy, Sustainability and Society DOI: 10.1186/s13705-016-0103-y.
- [20] Diekmann, J., Eichhammer, W., Neubert, A., Rieke, H., Schломann, B., Ziesing, H.-J., 1999. Energie-Effizienz-Indikatoren: Statistische Grundlagen, theoretische Fundierung und Orientierungsbasis für die politische Praxis, Heidelberg.
- [21] Friedrich, R., Krewitt, W., 1997. Umwelt- und Gesundheitsschäden durch die Stromerzeugung: Externe Kosten von Stromerzeugungssystemen. Berlin, Heidelberg.
- [22] Weimer-Jehle, W., 2006. Cross-impact balances: A system-theoretical approach to cross-impact analysis. Technological Forecasting and Social Change 73 (4), 334–361.

Creating Methods, Procedures and Tools for a More Sustainable Neighbourhood Development – Experiences from Germany

Maria BALOUKTSI^a, Thomas LÜTZKENDORF^b, Jürgen KOPFMÜLLER^c, Volker STELZER^d

^a Karlsruhe Institute of Technology, Germany, maria.balouksi@kit.edu

^b Karlsruhe Institute of Technology, Germany, thomas.luetzkendorf@kit.edu

^c Karlsruhe Institute of Technology, Germany, juergen.kopfmueeller@kit.edu

^d Karlsruhe Institute of Technology, Germany, volker.stelzer@kit.edu

ABSTRACT

Cities constitute essential parts of the built environment. Although being crucial “engines” of socio-economic growth, they cause significant environmental loads. Therefore, they have a major role to play in sustainable development. Their design and adaptation to future requirements should always follow the sustainable development principles. This is an ongoing process that must be actively managed. However, which methods and procedures can support such a process? Since cities are complex entities, in urban transformation processes, the district/neighbourhood level has been proved as appropriate for implementing sustainability principles. Thus, the paper focuses on the district-scale sustainable development and deals with issues related to the management of the process, including: a) the identification of local actors having a direct influence on the district’s development, the selection of the object of assessment and the determination of the district’s current state, followed by b) the formulation of goals and the investigation of possibilities on how to act towards these goals. This also presupposes the analysis of relevant actors regarding their motives, property rights and possibilities for action. Through this analysis, the importance of a flexible indicator system adjustable to the district’s local conditions for the definition of goals, indicators and target values and the monitoring of progress based on this system are highlighted. The main result is a detailed analysis of the relevant actors and actor constellations as well as the development and application of indicator systems. The difference between sustainability assessment systems, as a basis for certification, and indicator sets/systems, as “tools” supporting sustainable district development, is also discussed. Specific experiences from Germany are considered in connection with the subject of “living laboratories” and the research project “Urban Transition Lab 131” focusing on a specific city district in Germany.

Keywords: sustainable neighbourhood, urban transformation, indicator set

1. INTRODUCTION

The UN predicts that by 2030, almost 60 per cent of the world’s population will live in urban areas (UN, 2014a). Given the current urbanisation trends, sustainable development challenges – and therefore, opportunities to be grasped – will be increasingly concentrated in cities. According to the latest progress report of the UN-HABITAT II (UN, 2014b) the current urbanization model is unsustainable in many respects and new conditions need to be defined to achieve inclusive, people-centred and sustainable global development. Cities, although being crucial “engines” of social and economic growth, have not succeeded in suitably addressing emerging and existing challenges, such as urban sprawl, congestion, air pollution, greenhouse gas emissions, social inequalities and poverty. In this sense, sustainability-related efforts in both science and policy arenas are broadening from building level (micro-scale) to neighbourhood and city level (meso- and macro-scale). A number of recent initiatives already attempt to address the common challenges in cities by providing recommendations and global targets for sustainable urban development. For example, “sustainable cities and human settlements” (Goal 11) is one of 17 Global Sustainable Development Goals (SDG) that make up the UN 2030 Agenda for Sustainable Development and it paves the way for fully transformative urban commitments and principles. At the same time, the outcome document of Habitat III (Parnell, 2016) will be the New Urban Agenda (NUA) providing guidelines and policy recommendations for sustainable urban development for the next two decades.

However, accomplishing sustainable urban development is a highly challenging task due to its complex and continuously-evolving nature. Many cities struggle to meet their sustainability commitments and determine detailed targets. Breaking down the “city” into smaller, more manageable urban units (i.e. neighbourhoods), and systematically involving local people and institutions (e.g. homeowner associations, business communities, residents’ groups, etc.) in their transformation and improvement process as “co-creators” and “change agents” is

expected to facilitate a transition to urban sustainability. The neighbourhood level, as an intermediate level of analysis and action between the city level and that of individual buildings, has increasingly been proved as a promising level for developing and implementing sustainable urban interventions (Berardi, 2013). Within a neighbourhood, different types of community groups and social networks are formed and maintained providing in principle more opportunities for interaction and active participation in collective decisions and actions. Additionally, compared to the city scale, people residing in the same neighbourhood are more likely to share similar daily living experiences and exhibit a higher level of motivation to influence their immediate living environment.

However, the neighbourhood-scale sustainable development is an ongoing process that requires continual engagement, monitoring, assessment and revision. The paper focuses on issues related to the understanding and management of the process, including: a) the analysis of the current state and problems of neighbourhoods, including the identification of local actors having a direct influence on their development, b) the creation of an appropriate set of indicators to monitor and assess performances, and finally c) the planning of a future strategy including the formulation of targets and the investigation of possibilities to act towards these targets.

2. SWIFTING TOWARDS A PROCESS-BASED APPROACH

Over the last decades, several sustainability assessment systems and tools have been developed for urban districts and neighbourhoods, mostly as a result of an attempt to expand and adapt already established sustainability assessment and certification systems of buildings, in order to better address the complexities of the urban scale (Sharifi and Murayama, 2013). This involves moving beyond dealing solely with issues related to the performance of single buildings and incorporating issues related to e.g. the quality of urban design and environment (e.g. design of public spaces, etc.) as well as to the way how people move, work and live within a place. However, these systems and tools are usually suited for assessing districts that are newly designed or in a planning phase, and thus mainly support planners and developers to consider the sustainability model at the master planning stage. Most of them are based on a performance- or outcome-oriented approach (absolute assessment of the performance), providing rating and/or certification based on the assessment result (level of sustainability at a particular point in time), but failing to reflect the dynamic and constantly changing nature of an existing neighbourhood. Therefore, they are still too inflexible to fully support the sustainability transformation and improvement processes of existing districts (Lützkendorf and Balouktsi, 2016a). In this case, it makes more sense to shift towards a more process-oriented approach and conduct “distance to target” assessments, namely measure the distance(s) between the current and the desired status (both short-term and long-term target).

Often, local authorities are not willing to support/allow for an absolute sustainability assessment for the area they represent to avoid the risk of stigmatisation and other substantial disadvantages a poor performance/score may cause. A neighbourhood of bad reputation may discourage potential investors and developers from engaging in its improvement processes and from covering (part of) the occurring development costs. However, there are cases where the developers or investors are the ones initiating the development process of an existing neighbourhood seeking to make profits through e.g. higher property values and higher market demand. In this context, receiving a sustainability certificate can be a long-term sub-target for an improvement process to attract more renters and homeowners. Hence, as a compromise, the two approaches can be combined to maximize the benefits. Another reason why most of today's sustainability assessment systems can be considered as inflexible is that they usually use a “fixed” set of indicators. However, the sustainable development of an existing neighbourhood is a process driven by various types of stakeholders with different ambitions and interests, as well as different possibilities and capacities to act, compared to the planning of a new neighbourhood, where the main decision-maker is the developer. Having a “flexible” indicator set, capable of reflecting and adapting to the varying and time-evolving local interests/needs within the area and responding to emerging issues, would be an advantage – mainly because different perspectives can be considered within one system. In this case, different indicators can be used for assessing the same issue as a way to map the perspectives of different actors and to identify causes and/or effects of this (Lützkendorf and Balouktsi, 2016b). In process-oriented approaches, contrary to certification systems providing a fully aggregated version of the assessment result, the risk of double-counting is not present.

3. BASIC STEPS FOR SUPPORTING SUSTAINABLE NEIGHBOURHOOD DEVELOPMENT

3.1 Initiation phase

Initiation of a development process can occur in one of two ways (or their combination): top-down or bottom-up. Top-down initiation results from decisions made at the highest level, e.g. by local authorities as a response to specific problems or a hotspot of problems, or by researchers in collaboration with local authorities as a way of testing new approaches (e.g. urban living laboratories – see 4.2). On the other hand, bottom-up initiation usually begins as an attempt of a local interest group (e.g. property owners association) to harness a specific opportunity serving their interests (e.g. urban improvement districts – see 4.1). This is identified as Step 0 in Figure 1. To **adequately manage the process, the composition of a committed “core team” (CT) is required, mainly consisting of a coordinator and key prime consultants/experts.** The CT has usually a facilitating and steering role. As the responsibilities increase along the process, the CT evolves to engage a broader variety of local skills and **experience (local stakeholders/representatives) and build the “overall team” (OT).** Involving local actors as active consultants in the process empowers them to enjoy greater influence over what happens in the neighbourhood and generates a sense of ownership of the goals and long-term commitment to their implementation. A number of action steps are suggested in the following to help understanding and improving the organisation and planning of the development process itself.

3.2 Moving along the process

The spatial boundaries of a neighbourhood cannot always be defined in a consistent way; they must be adapted to the issues investigated and the indicators applied. It may be a territorially defined administrative unit of a city, an area of study/application whose demarcation is made from a contextual perspective, or an area the residents identify themselves with, and thus develop a higher sense of responsibility. A different boundary line can be drawn for each specific topic. Therefore, the initial selection of the boundaries of the area of intervention should be rough (not specified in an exact/fixed way based only on the administrative geography) to permit layering and overlapping, so as to adapt to the different goals and issues under examination (Step 1 – Figure 1). Having selected the location and an approximate area of intervention, it is important to describe and analyse its profile including basic statistics and background information about the residents, places, services, infrastructures and activities which make up the area (Step 2 – Figure 1). At this point, appropriate profile indicators (a term also used in ISO 37120:2014) should be selected for describing essential characteristics of the area investigated. No targets can be defined as reference **lines for these indicators on the district level, as they “cannot be influenced” (at least not directly) by interventions** of local actors and serve only information purposes (e.g. total number of households, percentage of unemployed people, etc.). **However, some of them may give “early warnings” of problems to occur in future. In this case,** strategies can be developed for fighting the consequences of these developments observed with the help of profile indicators. As part of the neighbourhood profile, it is also important to identify the main local actors operating or living in the area (i.e. homeowners, business owners, lobbies, associations and unions, local institutions), as well as their interrelationships.

The next step would be to develop a flexible indicator set to reflect the goals and aspirations for the neighbourhood improvement project and support the assessment of the progress towards sustainable development. The third step **in the system’s development is an extensive review of other relevant indicator sets and systems to obtain an insight** into what has already been put into practice and will best suit the special characteristics of the neighbourhood under investigation. This is the so-called **“top-down” or “expert-led” approach that is mainly driven by expert knowledge** (Step 3 – Figure 1). Achieving compliance with national or international standards is also critical (e.g. with ISO 37120:2014). Furthermore, it is essential that existing national or regional sustainability strategies are taken into account if available.

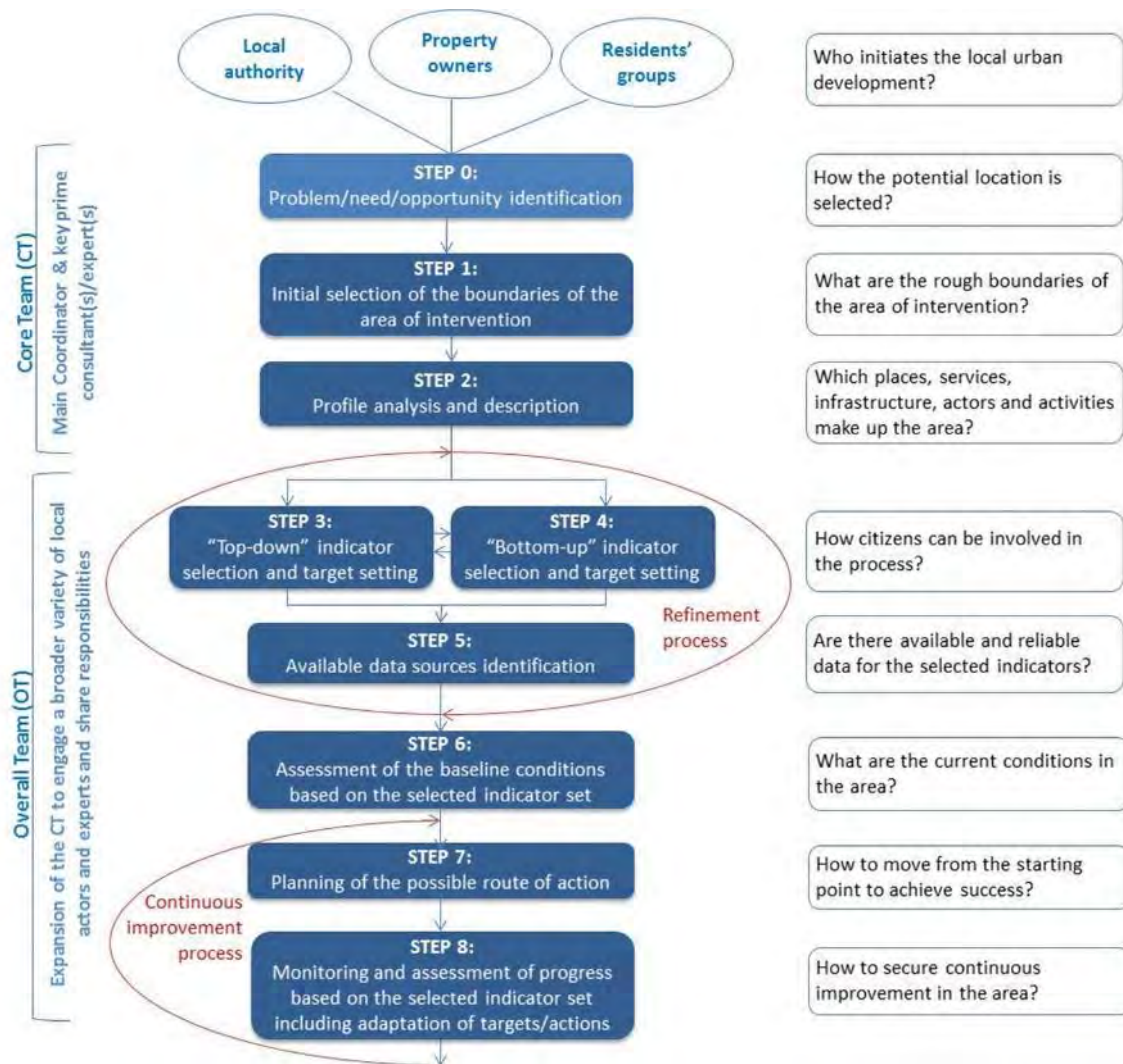

Figure 1: Basic steps for supporting sustainable neighbourhood development process

After utilising a top-down approach to select core problem areas and an initial set of core indicators, the needs and desires of stakeholders should be identified and accommodated through a bottom-up approach (Step 4 – Figure 1). To trigger and extract these, multiple interactive work sessions with local actors and residents should be organized, with experienced facilitators (e.g. researchers who have a good knowledge of both environmental and social sciences) guiding them through a “vision” process. Some of the specific issues and concerns of the people may already be reflected in the list of the selected core indicators. The rest should then be translated into context-specific indicators and targets. The iterative nature of the community-science interaction in the form of different participatory processes allows for a more diversified understanding that combines scientific and local knowledge. Finally, available data sources should be identified for the assessment of the selected indicators (Step 5 – Figure 1). In cases where data are not available in sufficient quality, the indicator set should be refined and supplemented with consequential indicators (alternative indicators to be used instead of a core or context-specific indicator) or new mechanisms for data generation should be suggested. This is possible only in cases where several indicators exist that can be used to assess the same criterion/thematic area. For example, the energetic quality of residential buildings (criterion) can be described and assessed in several ways; e.g. in terms of the energy demand, energy consumption, specifications for envelope and building services, etc. Therefore, it is possible to adapt the selection of the indicators to the available data and information.

Before starting the planning of a future improvement strategy, the baseline performance of each of the selected indicators should be identified through a first assessment (Step 6 – Figure 1). This will form the basis for setting specific short-term and long-term targets (intended result) per indicator taking into account, among others, current political and scientific debates, regional and national action plans and existing targets in other comparable areas/regions. Once the targets have been set, the next step is to identify the measures of intervention needed to

meet them and the stakeholders able to act related to each specific problem, thus to plan the possible route of action by assigning specific responsibilities and tasks to specific stakeholders (Step 7 – Figure 1) This should result in a clear road map. It is also important to convince **“passive” actors to accept the planned changes, as well as to consider any risks that might jeopardize the plans** (e.g. target conflicts, unwillingness to cooperate, etc.). For example, a tenant can be considered as a passive actor in the case of an energy modernization of a residential building. In any case, the possible measures of intervention should be made transparent, as far as possible, regarding their specific advantages and disadvantages for each affected party. Last but not least, establishing suitable mechanisms for monitoring and assessing the progress regarding the extent to which the various targets (short-, medium or long-term) are achieved is essential for securing continuous improvement in the area (Step 8 – Figure 1). In this way, an understanding can be gained on how effective the plans are and what adaptations of targets and actions are required for progress towards sustainable development.

4. INSTRUMENTS

A broad range of instruments is imaginable, currently under discussion or even tested, that may help to implement the process described above or particular steps of it. In the following, two examples are outlined addressing different facets of urban district development.

4.1 **“Urban improvement districts” as a new financial framework**

The process of sustainable neighbourhood development is usually associated with substantial financial expenditure and cannot be supported by a top-down strategy alone. Therefore, it is essential to ensure the necessary financial resources for the implementation of the concept by creating incentives for local actors and mobilizing private capital to complement public funds. State and private actors have the common goal to stabilize or revitalize neighbourhoods. One stimulus for the land and property owners can be that an improvement in the quality of the site/location can have a direct and positive effect on the real estate value of their properties through improved performance. Therefore, the traditional methods of urban development (government-driven action) and private-driven initiatives in this field can be seen as two sides of the same coin – there is a place for public–private **partnerships, like “Urban Improvement Districts” (UID), in neighbourhood transformation processes. UIDs, e.g. in form of business, housing and neighbourhood improvement districts (BID, HID, NID) (Kreutz, 2009), offer a framework for pooling initiatives to support sustainable neighbourhood development and mark an “in-between position” between the private and public domains. UID’s are legally defined areas in which the improvement processes are realised on the basis of private initiative, including the participation and self-organisation of local stakeholders to implement the necessary measures, and the use of financial resources of private stakeholders, e.g. landowners in the case of HID’s. To this end, in many of these models a task manager is assigned, who cooperates with both the (local) private stakeholders and the municipal authority. UID’s are financed by a tax which is levied by the municipality and collected from all land owners in the area. The authors believe that a process-based sustainability assessment can be effectively combined with the UID’s framework. UID can provide the organizational and financial framework for the implementation of sustainability measures identified as a result of an analysis of the present situation.**

4.2 **“Living labs” as a new form of collaboration and co-creation**

There is a basket of living labs around the world focusing on sustainable urban development and including actors from all sectors of society, academia, government and industry, in combination with the community (Salter and White, 2014). Many of them have universities as the driving force for their development and implementation. Living labs distinguish themselves from other innovation approaches in development processes by supporting the participation of multiple stakeholders beyond consultation and towards joint decision-making, focusing on the idea of empowerment and co-creation. Such a process is now being supported and moderated in the research project **“Urban Transition Lab 131” by a scientific team appointed by “KIT Centre Humans and Technology” of the Karlsruhe Institute of Technology (KIT), in collaboration with the city of Karlsruhe and many other parties at urban district level. The development of a methodological, transdisciplinary basis and the selection of indicators by the KIT project team are still on-going. Bottom-up indicators will be further developed and agreed on, together with the actors involved in the urban transition lab. This will be achieved by carrying out specific surveys of certain groups of actors in the district. In this context, the residents’ general understanding of sustainability has to be investigated. In addition, “fact sheets” will be created for the description and communication of appropriate bottom-up and top-**

down indicators, while, in consultation with the municipal administration and other influential stakeholders, the data collection for each individual indicator will be pushed forward. An initial presentation of such “fact sheets” has already been provided (Lützkendorf et al., 2016). Here, the problem of data protection has been proved to be a challenge. One approach is the active provision and release of data through the residents and businesses in the neighbourhood on a voluntary basis - as a form of participation.

5 CONCLUSIONS AND OUTLOOK

Sustainable development of a neighbourhood is a long-term, ongoing process. It is possible and advisable to carry out this process in close interaction with local actors. It is necessary to develop mechanisms that bring together experts and community members to develop indicators that stimulate and measure the progress towards sustainability. In this case, the instrument of “living labs” supports the process by fostering collaboration and co-creation (co-design). Such collaborative actions can provide a flexible indicator set that reflects local values, necessary actions and possibilities to act. The current discussions about the further development of ISO 37120 also point in this direction. Once the final list of indicators best suiting the characteristics of the neighbourhood is acknowledged and widely accepted, the indicators need to be clearly and precisely described and documented. **The development of a “factsheet” for each indicator that contains all necessary information is necessary.** Within the context of the further development of such factsheets, their purpose should not only be to identify and list all possible data sources and alternative calculation procedures for each indicator, but also to identify the acting stakeholders and their options/opportunities for action to implement specific measures to achieve progress. Besides the growing political commitment worldwide towards the inclusion of local actors in the sustainable neighbourhood development process, it is also important to find solutions to better mobilise capital required for investments in the process. One approach, among others, for this, is the model of Housing Improvement Districts (HID). In the near future, more new models of public-private partnerships should be tested in the context of neighborhood sustainability transformation processes, as a precondition to become more familiar with the new roles and tasks that are associated with it.

REFERENCES

- [1] Berardi, U., 2013. Sustainability assessment of urban communities through rating systems. *Environment, development and sustainability*, 15(6), 1573-1591.
- [2] Kreutz, S., 2009. Urban Improvement Districts in Germany: New legal instruments for joint proprietor activities in area development. *Journal of Urban Regeneration & Renewal*, 2(4), 304-317.
- [3] Lützkendorf, T. and Balouktsi, M., 2016a. Sustainability Assessment Systems for New and Existing Neighbourhoods. In M., Albiez, G., Banse, K.C., Lindeman and A., Quint, ed., *Designing Sustainable Urban Futures: Concepts and Practices from Different Countries*, 1st ed. Karlsruhe: KIT Scientific Publishing, pp. 27-42
- [4] **Lützkendorf, T. and Balouktsi, M., 2016b. “Assessing a sustainable urban development: typology of indicators and sources of information”, paper presented at the Sustainable Building Regional Conference, Thessaloniki, 17-19 October**
- [5] Lützkendorf, T., Balouktsi, M., Kopfmüller, J. and Albiez, M., 2016. Supporting urban district development by accompanying sustainability assessment. In *SBE16 Hamburg – Strategies, Stakeholders, Success factors*. Hamburg: ZEBAU Verlag.
- [6] Parnell, S., 2016. Defining a global urban development agenda. *World Development*, 78, 529-540.
- [7] Salter, R. and White, S., 2014. Collaborative Research in the Real World – Review of Living Laboratories. *Low Carbon Living CEC*. Available at: <http://www.lowcarbonlivingcrc.com.au/> [Retrieved on 15 Aug. 2016].
- [8] Sharifi, A. and Murayama, A., 2013. A critical review of seven selected neighborhood sustainability assessment tools. *Environmental Impact Assessment Review*, 8, 73-87.
- [9] United Nations (UN), 2014a. *World Urbanization Prospects: The 2014 Revision, Highlights (ST/ESA/SER.A/352)*. New York: United Nations. Available at: <https://esa.un.org/unpd/wup/> [Retrieved on 05 Sep. 2016].
- [10] United Nations (UN), 2014b. *Progress to date in the implementation of the outcomes of the second United Nations Conference on Human Settlements (Habitat II) and identification of new and emerging challenges on sustainable urban development*. New York: United Nations, pp. 2. Available at: <http://unhabitat.org/> [Retrieved on 05 Sep. 2016].

How Can We Assess the Achievement of The Sustainable Development Goals? – A Review of Indicators and Their Application at the City Level

Roland ZINKERNAGEL^a

^aLund University, Sweden, roland.zinkernagel@iitee.lu.se

ABSTRACT

This paper focuses on the assessment of the UN Sustainable Development Goals (SDG) and the use of indicators to assess performance at the city level. Although indicators need to reflect the particular local conditions and requirements, the SDGs can provide guidance to local governments on how to assess progress towards sustainable development, both at global and local level. A challenge is that there is no common definition of sustainable cities and often indicators are failing to include the entire spectrum of sustainability, in effect they tend to be dominated by assessing the environmental/ ecological performance.

In this paper the use of indicators to evaluate the progress of sustainability in cities will be reviewed. The results of the review will be used to compare existing indicators used to assess sustainable development in cities to the indicators suggested by the UN SDGs.

Keywords: sustainable neighbourhood, indicators, sustainable development goals

1. INTRODUCTION

In the autumn of 2015 the UN introduced the Sustainable Development Goals (SDGs) in order to be able to provide guidance at global, national, regional and local level towards a more sustainable world (UN, 2015). The 17 goals cover all three different aspects of sustainable development as defined by the Brundtland commission. They comprise of 168 targets and 239 different indicators in order to be able to follow up progress towards reaching the Sustainable Development Goals (UN-1, 2016). The indicators are currently still under development, at the moment several of the indicators are still being discussed (UN-2, 2016). The need for indicators has been identified by the United Nations in order to make it possible to measure progress and to make sure that no actor is left behind (UN, 2015).

This paper focuses on the assessment of the SDGs and the use of indicators to assess performance at the city level. Although indicators need to reflect the particular local conditions and requirements, the SDGs can provide guidance to local governments on how to assess progress towards sustainable development, both at global and local level. So far, there has been done very limited research on the application of the Sustainable Development Goals on local level.

In this paper the use of indicators to evaluate the progress of sustainability in cities will be reviewed. The results of the review will be used to compare existing indicators used to assess sustainable development in cities to the indicators suggested by the UN SDGs.

2. INDICATORS FOR THE EVALUATION OF SUSTAINABILITY PERFORMANCE OF CITIES

Indicators are a useful and efficient tool to collect information on performance and can be used as one foundation for local policy making (Miller, 2005). The Programme of Action for sustainable development, which was adopted at the United Nations conference on Environment and Development in Rio de Janeiro in 1992, asked for the development of indicators for sustainable development in order to be able to take grounded decisions that foster a self-regulating, integrated and holistic sustainable development (UN, 2007; UNSD, 1992). Ever since, many sets of indicators have been developed to assess the development of sustainability, including sustainability in cities. The ISO 37 120 standard on global city indicators (International Organisation for Standardization, 2014) and the indicators suggested to assess progress towards the SDG being two recent examples on global level. Both build on experiences made from earlier indicator systems, such as the UN Habitat Urban Indicators (UN Habitat, 2004) and the Millennium Development Goals and their associated indicators (UN, 2008). Many cities and regions have

also been developing own indicators to measure progress towards global as well as local goals and targets (Astleithner et al., 2004; Tanguay et al., 2010; Neumann et al., 2015; Vázquez et al., 2015).

2.1 What are sustainability indicators?

Indicators are a useful tool to assess the current status (Wilson et al., 2007; Kitchin et al., 2015; King, 2016). Giving feedback and performance assessment is the most important role that indicator systems have, the emphasis is on locating the problem (Fitz-Gibbon, 2002; Science for Environment Policy, 2015). An indicator shows that a certain condition exists or certain results have or have not been achieved (OECD, 2008; Astleithner et al., 2004; Horsch, 1997), using the same indicator several times makes it possible to see trends and development directions. This needs to be connected to a realistic target that should be achieved within a defined time (OECD, 2008). Indicators are non-subjective tools and measure variables over time and/ or space and are seen as decision support instruments. They do not need to be quantified, measurement can be on the basis of qualitative scales (Astleithner et al., 2004).

9 Frameworks and criteria for selecting indicators

Research has developed frameworks in order to be able to group indicators and find causal relationships between the indicators or alternatively frameworks that make it possible to structure reality and facilitate the identification of crucial intersections where indicators would be most meaningful. The development and use of a conceptual **framework based on causal networks will aid the selection process as it “facilitates the identification of the most relevant indicators for a specific domain, problem and location” (Niemeijer and de Groot, 2008). Similarly Hak (Hák et al., 2016) and Singh (Singh et al., 2009) consider the use of conceptual frameworks advantageous for indicator selection. Alternatively, system dynamics modelling can be used as a framework to reflect the complex nature of sustainable development (Dahl, 2012). Most commonly used examples of frameworks are the Pressure-State-Response model and its derivatives (Niemeijer and de Groot, 2008) or conceptual frameworks such as policy-based or conceptual approaches (Hák et al., 2016).**

Furthermore, indicators can be grouped according to the type of development they measure. Costa (Costa, 2015) groups them into reflective (a manifestation of what is being observed), causal (where an action influences the outcome of the indicator) or composite (where the outcome of the indicator is a result of several correlating factors) indicators. Based on an approach focusing on an evaluative scheme, indicators can be grouped according to what they are measuring, i.e. inputs, processes, outputs or outcomes (Luederitz, in press).

There are quite a number of selection criteria that have been identified and certainly there are a lot more that are being used in the field. The criteria that are most commonly found in research are that they should be policy relevant, that they should be reliable and measurable, that indicators should be wide in scope and that they should be simple (Böhringer and Jochem, 2007; Ness et al., 2007; Wilson et al., 2007; Science for Environment Policy, 2015; Niemeijer and de Groot, 2008). There is however a plethora of selection criteria that spans from analytical soundness to process orientation to the ideal number of indicators used.

As **Niemeijer points out “there is considerable room for improvement in the indicator selection process” (Niemeijer and de Groot, 2008).**Click here to insert your content.

3. RESULTS

3.1 How have cities used sustainability indicators?

A literature search was conducted using search terms such as city development, indicators, sustainability assessment and related words in different combinations in order to get an overview how city development has been assessed and what schools of thought exist to structure indicator development. The literature search revealed that research has focused mostly on selection criteria, i.e. which characteristics the indicators should fulfil in order to provide useful information to the policy maker or whoever might be using the data derived from the indicators (**Böhringer and Jochem, 2007; Ness et al., 2007; Wilson et al., 2007**). **The research that did investigate in cities’ selection criteria for choosing indicators did however show that usually indicators are selected by political prioritisation, perceived importance and/ or data availability (Keirstead and Leach, 2008; Shen et al., 2011;**

Lehtonen et al., 2016). There is an implementation gap between the scientific discussion on indicator selection criteria and the application of these criteria on practical level in cities.

However, cities have been and are using indicators to a larger or lesser degree. Indicator use for the assessment of economic efficiency, of living standards or pollution are but a few examples. Environmental indicators have been used in cities increasingly in parallel to the increasing environmental degradation that went along with an increasing industrialisation (Munn et al., 1988). Social indicators have been used since the first half of the 18th century although they have been continuously refined and contextualised since then (Cobb and Rixford, 1998). It is worth noting **that the use of indicators has been changing over time, in line with an increasing trend to incorporate 'New Public Management' ideals into public administration**, i.e. the ideals of cost-efficiency, decentralisation, customer-orientation and empowerment. The desire towards economic efficiency is reflected in the choice and use indicators in the public sector (Astleithner et al., 2004).

With the introduction of the sustainability concept and its application to city development comes the urge to develop sustainability indicators as described above. A challenge is that there is no common definition of sustainability or sustainable cities (Huang et al., 2015). Despite the three decades that have passed after the Brundtland **commission's report are indicators failing to include the entire spectrum of sustainability, even though they are** meant to assess the sustainability of a city; in effect they tend to be dominated by assessing the environmental/ecological performance (Tanguay et al., 2010; Böhringer and Jochem, 2007). Luederitz carried out a cluster analysis of scientific literature on the sustainability performance of urban neighbourhood development and came to the conclusion that none of the 21 papers covered all of the three sustainability aspects or at least not to a significant degree (Luederitz et al., 2013).

The literature review has shown that a lot of research in the field of assessing urban sustainable development has been done comparing different indicator systems, i.e. groups of indicators that collectively describe a state or condition. Examples of indicator systems are the Ecological Footprint, Environmental Sustainability Index, Dashboard of Sustainability, Welfare Index, Genuine Progress Indicator, Index of Sustainable Economic Welfare, City Development Index, Emergy/ Exergy, Human Development Index, Environmental Vulnerability Index, Environmental Policy Index, Living Planet Index, Environmentally-adjusted Domestic Product, and Genuine Saving. This list is however not exhaustive and could be extended. Similarly to the use of individual indicators, research has assessed the varying usefulness of indicator systems but not the extent that cities actually have used the different indicator systems.

Shen (Shen et al., 2011) uses the International Urban Sustainability Indicators List (IUSIL), which consists of 115 indicators formed into 37 categories, in order to analyse and compare different sets of sustainability indicators chosen in various cities around the world. Comparability across cities is argued to be important to create a common **baseline and be able to apply successful tools and measures. At the same time Shen also realises that "there is no single set of indicators that suits equally to all cities"** (Shen et al., 2011). Similarly, a varying understanding of what sustainability is will lead to different indicators being selected, and in turn that means that the selection of indicators will influence the sustainability statues that the indicators give (Wilson et al., 2007).

Mori analyses 14 indicators systems and some applications of composite indices regarding their coverage of the triple bottom line, if they cover a global or local perspective and whether they follow the perspective of weak or strong sustainability and concludes that none of the systems satisfies the requirements necessary to reach sustainability (Mori and Christodoulou, 2012).

For the purpose of this paper global or international indicator systems were analysed and compared to the structure of the UN Sustainable Development Goals. This made it possible to see to what extent indicator systems cover the same or similar aspects as the SDG. The indicator systems that were chosen in this research were selected on the grounds of their coverage, i.e. they need to cover at least the three most common aspects of sustainability (environmental, economic and social aspects), need to be developed for a larger geographical area and have been widely used. The following indicator systems were chosen: SDG indicators, ISO 37 120, UN habitat urban indicator guidelines, European Common Indicators, Better Life index, Sustainable city index UN Commission for Sustainable **development's Indicators for sustainable development**, Urban Sustainability indicators.

Name of indicator system	SDG indicators	ISO 37 120	Better Life index	CSD indicators of SD	UN Habitat Urban indicator guidelines	European Common Indicators (ECI)	Urban sustainability indicators
Year of introduction/ most recent version	2015	2014	2011	2007	2004	2004	1998
Number of indicators	239	94	24	49	38	10	15
Actual use in cities	No numbers available yet	30 cities have reported at least some indicators	Reporting mostly on country level	No information on use in cities	Different versions are used by 200+ cities	Tested by 42 cities	No information on use in cities

Table 1: Overview over analysed indicator systems

In lacking input on the factual use of sustainability indicators by cities it was decided to use the application of the above indicator systems as an approximation. Table 1 shows how many cities have been using the indicator systems. The UN Habitat indicator guidelines have been most frequently used. They have been introduced more than ten years ago and while this might be used as an argument for their extensive use it is worth noting that other, older indicators have been less popular up to the degree that there is no information to be found. Many indicators, especially European ones have been developed through different EU financed projects. Even though the intention is to ensure the use of them after the end of these projects it seems that this is not happening. Either new indicators are being developed (building on the experience of the previous ones) or they are being replaced by other indicator systems. In the case of the UN Habitat Urban indicator guidelines, they have been incorporated in the Millennium Goal Indicators, which in turn have been incorporated in the Sustainable Development Goal indicators. What becomes obvious is that indicators in the field of sustainable city development (Goal 11 of the SDGs) and water and sanitation (Goal 6 of the SDG) have been equally important already in the UN Habitat indicators.

When analysing the most commonly used indicator sets (UN Habitat urban indicator guidelines, ISO 37120 Smart City Data, European Common Indicators) and the topics that they cover it becomes possible to get an indication which indicators are most commonly used by cities. This analysis reveals that indicators within Goal 11 are most popular (49 indicators). The indicator that can be found in all three indicator sets is the one on air quality, i.e. levels of PM10 and PM2.5. Also aspects of waste management are frequent as are indicators on settlements on hazardous locations. The second most used indicator group is the one represented by Goal 6 (18 indicators) where indicators on access to safe drinking water, wastewater management and availability of sanitary facilities can be found in all three indicator sets. Indicators under Goal 16 (15 indicators) are the third most popular. The indicator on victims of homicide can be found across the indicator sets as well as indicators on the percentage of women in public institutions/ city government and participation rate in municipal elections. Areas that are not at all covered are the ones associated with Goals 2 (zero hunger), 10 (reduced inequalities) and 14 (life below water). The results of this analysis go in line with the findings of the literature review that sustainability indicator sets tend to be dominated by indicators on the environmental performance (Tanguay et al., 2010, Böhringer and Jochem, 2007).

Figure 1 visualises the diversity and to which extent different indicator systems include all aspects of sustainability, following the structure of the SDGs. The extent to which indicator systems has been increasingly covering all aspects of sustainability becomes obvious when considering the time of introduction of the respective indicator set. At the same time it also becomes obvious that some indicator sets, in this case the ISO 31 120 standard on Smart City Data, are specialising on certain aspects in order to attempt to fully cover this topic. Even when disregarding the fact that the SDGs have by far the most number of indicators it becomes obvious that they are the ones that most holistically cover all aspects of sustainable development.



Figure 1: Comparison of indicator sets regarding their coverage of sustainability aspects

3.2 Usefulness of SDGs at local level

One of the SDGs, goal 11, is specifically addressing cities and human settlements, setting the target to make them inclusive, safe, resilient and sustainable. This is the result of experiences with the implementation of the millennium goals as well as the lobbying to recognise cities as an important driver for transformation as well as the importance of a **bottom-up approach for global change (UCLG, 2015)** (“SDGs: Sustainable Development Knowledge Platform,” n.d.). Despite a specific goal focusing on the urban perspective, all goals are relevant for cities, and so are their respective indicators. Of the 239 indicators 215 are considered to be relevant on local level, see Figure 2 below.

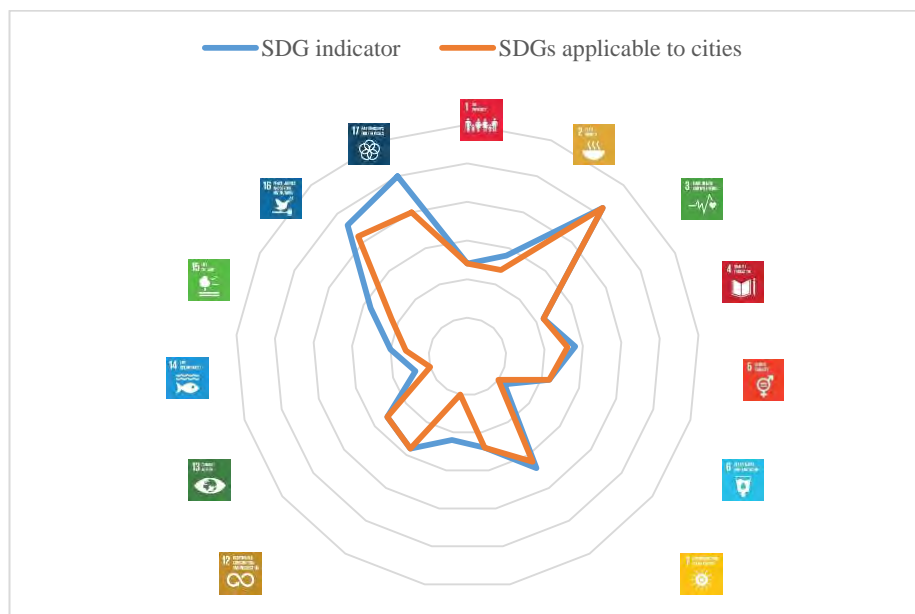

Figure 2: Comparison of SDG indicators and their relevance in a local context

Research regarding the implementation of the SDGs on local level is still limited. One example is the study by Simon (Simon et al., 2016) who tested collecting data on the SDGs for five cities. The focus of that study is on Goal 11, and makes suggestions on how the usefulness of the SDGs can be maximised on the local level. United Cities and Local Governments produced a non-scientific guide for local governments on important aspects to consider when implementing the goals locally (UCLG, 2015).

A comparison between the commonly used indicators and the ones suggested within the SDG framework identifies which topics are most common across the indicator systems. These indicators cover air pollution, waste management, sanitation and drinking water, education and safety and security. This goes in line with findings from **the literature review i.e. that environmental aspects de facto dominate 'sustainability assessments'**. The types of indicators that are not included in systematic sustainability assessments are opinion-based indicators, alternatives to GDP as a measure of wealth or indicators based on an ecosystem approach, as suggested by Vazquez (Vázquez et al., 2015).

4. DISCUSSION

Cities are using indicators to be able to identify changes over time, to assess performance and for decision makers to be able to make the appropriate policy decisions, yet it is not sure if the use of indicators actually benefited the **city's development**. The literature review revealed that there is a gap between the academic view on which criteria to use when selecting indicators and the practical approach of cities. This is furthermore illustrated by the lack of scientific evaluation of the use of indicators in cities and the impact they might have had on cities developing towards sustainability.

The UN Sustainable Development Goals are an attempt to define a holistic target situation. As the comparison of the SDG indicators with other indicator systems showed, the SDG indicators indeed cover sustainability aspects to the largest extent of all indicator systems. It is clear that this is not least due to the fact that the SDG indicators are by far the largest in number of all the analysed indicator sets, at the same time it becomes also clear that the purpose of the sustainable development goals is to be applicable in a large variety of global contexts.

SDG indicators are to a large extent relevant also on the local level. The apparent exception here are most of the indicators under goal 10, reduced inequalities. These indicators are aimed at the national or international level, such a migration policies or international trade. Locally adapted indicators would need to be developed to sufficiently reflect this goal.

Using the SDG structure for sustainability assessment at local level would make it possible to receive a broad and combined picture of sustainability performance. Cities need to be able to choose and prioritise amongst the indicators according to the local conditions. This is a consequence of the approach that the UN has chosen by developing goals that need to be usable in a global context. Although it is interesting to be able to see how peer cities perform it will however in practice be very difficult to do direct comparisons as different aspects will be more or less important, both from a sustainability perspective but also on a political and managerial position. Tracking changes over time in one city is considered more valuable for cities to progress towards sustainable development.

REFERENCES

- [1] Astleithner, F., Hamedinger, A., Holman, N., Rydin, Y., 2004. Institutions and indicators - The discourse about indicators in the context of sustainability. *J. Hous. Built Environ.* 19, 7–24. doi:10.1023/B:JOHO.0000017704.49593.00
- [2] Böhringer, C., Jochem, P.E.P., 2007. Measuring the immeasurable - A survey of sustainability indices. *Ecol. Econ.* 63, 1–8. doi:10.1016/j.ecolecon.2007.03.008
- [3] Cobb, C.W., Rixford, C., 1998. Lessons learned from the history of social indicators. *Redefining Progress*.
- [4] Costa, D.S.J., 2015. Reflective, causal, and composite indicators of quality of life: A conceptual or an empirical distinction? *Qual. Life Res.* 24, 2057–2065. doi:10.1007/s11136-015-0954-2
- [5] Curtis, S., 2016. Cities and Global Governance: State Failure or a New Global Order? *Millenn.* - *J. Int. Stud.* 44, 455–477. doi:10.1177/0305829816637233
- [6] Dahl, A.L., 2012. Achievements and gaps in indicators for sustainability. *Ecol. Indic.* 17, 14–19. doi:10.1016/j.ecolind.2011.04.032
- [7] Fitz-Gibbon, C.T., 2002. Evaluation in an Age of Indicators: Challenges for Public Sector Management. *Evaluation* 8, 140–148. doi:10.1177/1358902002008001741
- [8] Hák, T., Janoušková, S., Moldan, B., 2016. Sustainable Development Goals: A need for relevant indicators. *Ecol. Indic.* 60, 565–573. doi:10.1016/j.ecolind.2015.08.003

- [9] Horsch, K., 1997. Indicators: Definition and Use in a Results-Based Accountability System [WWW Document]. Harv. Fam. Res. Proj. URL <http://www.hfrp.org/publications-resources/publications-series/reaching-results/indicators-definition-and-use-in-a-results-based-accountability-system> (accessed 5.27.16).
- [10] Huang, L., Wu, J., Yan, L., 2015. Defining and measuring urban sustainability: a review of indicators. *Landsc. Ecol.* 30, 1175–1193. doi:10.1007/s10980-015-0208-2
- [11] International Organisation for Standardization, 2014. Sustainable development of communities — Indicators for city services and quality of life [WWW Document]. URL https://share.ansi.org/ANSI%20Network%20on%20Smart%20and%20Sustainable%20Cities/ISO%2B37120-2014_preview_final_v2.pdf (accessed 12.20.16).
- [12] Keirstead, J., Leach, M., 2008. Bridging the gaps between theory and practice: a service niche approach to urban sustainability indicators. *Sustain. Dev.* 16, 329–340. doi:10.1002/sd.349
- [13] King, L.O., 2016. Functional sustainability indicators. *Ecol. Indic.* 66, 121–131. doi:10.1016/j.ecolind.2016.01.027
- [14] Kitchin, R., Lauriault, T.P., McArdle, G., 2015. Knowing and governing cities through urban indicators, city benchmarking and real-time dashboards. *Reg. Stud. Reg. Sci.* 2, 6–28. doi:10.1080/21681376.2014.983149
- [15] Lehtonen, M., Sébastien, L., Bauler, T., 2016. The multiple roles of sustainability indicators in informational governance: between intended use and unanticipated influence. *Curr. Opin. Environ. Sustain., Sustainability governance and transformation 2016: Informational governance and environmental sustainability* 18, 1–9. doi:10.1016/j.cosust.2015.05.009
- [16] Luederitz, C., in press. Learning through evaluation - a tentative evaluative scheme for sustainable transition experiments.
- [17] Luederitz, C., Lang, D.J., Von, W., 2013. A systematic review of guiding principles for sustainable urban neighborhood development. *Landsc. Urban Plan.* 118, 40–52. doi:10.1016/j.landurbplan.2013.06.002
- [18] Miller, C., 2005. New civic epistemologies of quantification: Making sense of indicators of local and global sustainability. *Sci. Technol. Hum. Values* 30, 403–432. doi:10.1177/0162243904273448
- [19] Mori, K., Christodoulou, A., 2012. Review of sustainability indices and indicators: Towards a new City Sustainability Index (CSI). *Environ. Impact Assess. Rev.* 32, 94–106. doi:10.1016/j.eiar.2011.06.001
- [20] Munn, R., Alcamo, J., Fedorov, V., 1988. Evaluating the Performance of Air-Quality Models in a Policy Framework. *Syst. Anal. Model. Simul.* 5, 493–510.
- [21] Ness, B., Urbel-Piirsalu, E., Anderberg, S., Olsson, L., 2007. Categorising tools for sustainability assessment. *Ecol. Econ.* 60, 498–508. doi:10.1016/j.ecolecon.2006.07.023
- [22] Neumann, H.-M., Jakutyte-Walangitang, D., Vielguth, S., Züger, J., Airaksinen, M., Huovila, A., Bosch, P., Rovers, V., Jongeneel, S., Pangerl, E., 2015. Overview of the Current State of the Art [WWW Document]. URL <http://nws.eurocities.eu/MediaShell/media/D1.2%20Overview%20of%20the%20Current%20State%20of%20the%20Art.pdf> (accessed 12.20.16).
- [23] Niemeijer, D., de Groot, R., 2008. A conceptual framework for selecting environmental indicator sets. *Ecol.-Indic.* 2008.
- [24] OECD, 2008. Handbook on constructing composite indicators. OECD.
- [25] Rivera, M., 2013. Political Criteria for Sustainable Development Goal (SDG) Selection and the Role of the Urban Dimension. *Sustainability* 5, 5034–5051. doi:10.3390/su5125034
- [26] Science for Environment Policy, 2015. Indicators for sustainable cities (In-depth report). European Commission DF Environment by the Science Communication Unit.
- [27] SDGs: Sustainable Development Knowledge Platform [WWW Document], n.d. URL <https://sustainabledevelopment.un.org/sdgs> (accessed 9.27.16).
- [28] Shen, L.-Y., Jorge, O., Shah, M.N., Zhang, X., 2011. The application of urban sustainability indicators - A comparison between various practices. *Habitat Int.* 35, 17–29. doi:10.1016/j.habitatint.2010.03.006
- [29] Simon, D., Arfvidsson, H., Anand, G., Bazaz, A., Fenna, G., Foster, K., Jain, G., Hansson, S., Evans, L.M., Moodley, N., Nyambuga, C., Oloko, M., Ombara, D.C., Patel, Z., Perry, B., Primo, N., Revi, A., Niekerk, B.V., Wharton, A., Wright, C., 2016. Developing and testing the Urban Sustainable Development Goal's targets and indicators – a five-city study. *Environ. Urban.* 28, 49–63. doi:10.1177/0956247815619865
- [30] Singh, R.K., Murty, H.R., Gupta, S.K., Dikshit, A.K., 2009. An overview of sustainability assessment methodologies. *Ecol. Indic.* 9, 189–212. doi:10.1016/j.ecolind.2008.05.011

- [31] Tanguay, G.A., Rajaonson, J., Lefebvre, J.-F., Lanoie, P., 2010. Measuring the sustainability of cities: An analysis of the use of local indicators. *Ecol. Indic.* 10, 407–418. doi:10.1016/j.ecolind.2009.07.013
- [32] UCLG, 2015. The sustainable development goals - what local governments need to know.
- [33] UN Habitat, 2011. The economic role of cities, The Global Urban Economic Dialogue Series.
- [34] UN (United Nations), 2015. Transforming our world: the 2030 Agenda for Sustainable Development. Resolution adopted by the General Assembly on 25 September 2015;
- [35] UN (United Nations Centre for Human Settlements), 2001. Cities in a Globalizing World: Global Report on Human Settlements 2001. Earthscan.
- [36] UN (United Nations, Department of Economic and Social Affairs, Population Division), 2014. World Urbanization Prospects: The 2014 Revision, Highlights.
- [37] UN Habitat (United Nations Human Settlement Programme), 2004. Urban Indicators Guidelines – UN-Habitat.
- [38] UN-2 (United Nations Inter-Agency Expert Group on Sustainable Development Goal Indicators), 2016. 4th Meeting of the Inter-agency and Expert Group on Sustainable Development Goal Indicators (IAEG-SDGs) [WWW Document]. URL <http://unstats.un.org/sdgs/files/meetings/iaeg-sdgs-meeting-04/9.%20Refinement%20of%20Indicators%20plenary.pdf> (accessed 12.20.16).
- [39] UN (United Nations Publications), 2007. Indicators of Sustainable Development: Guidelines and Methodologies. UN Economic and Social Affairs.
- [40] UN-1 (United Nations Statistics Division), 2016. SDG Indicators — SDG Indicators [WWW Document]. URL <http://unstats.un.org/sdgs/indicators/indicators-list/> (accessed 12.20.16).
- [41] UN (United Nations Statistics Division), 2008. Revised MDG monitoring framework including new targets and indicators, as noted by the 62nd General Assembly, and - OfficialList2008 [WWW Document]. URL <http://mdgs.un.org/unsd/mdg/Resources/Attach/Indicators/OfficialList2008.pdf> (accessed 1.10.17).
- [42] UN (United Nations Sustainable Development), 1992. United Nations Conference on Environment and Development, Agenda 21.
- [43] Vázquez, P., Río, J.A. del, Cedano, K.G., Martínez, M., Jensen, H.J., 2015. An Entangled Model for Sustainability Indicators. *PLOS ONE* 10, e0135250. doi:10.1371/journal.pone.0135250
- [44] Wilson, J., Tyedmers, P., Pelot, R., 2007. Contrasting and comparing sustainable development indicator metrics. *Ecol. Indic.* 7, 299–314. doi:10.1016/j.ecolind.2006.02.009

Session 4.12: Healthy Building, Human Comfort & Wellbeing

Healthy Buildings and Energy Performance – A Balancing Act

Eriko TAMURA^a, Mark RICHARDSON^b

^a Arup, Hong Kong SAR, eriko.tamura@arup.com

^b Arup, Hong Kong SAR, mark-a.richardson@arup.com

ABSTRACT

The world is seeing a rapid move towards Healthy Buildings. This is in part based on recent research and insights relating productivity to building design and in part due to a changing society which is becoming more health conscious. As such designers, property developers, building operators and building users are concerned about implications to building design, initial and operational costs, operation and maintenance, etc. A key consideration is the impact on energy performance, where in recent years building design has generally pushed towards energy reduction; healthy building design may challenge this. In this paper, experience from designing high grade offices and other high performance buildings is used to frame the discussion and highlight the challenges and opportunities that high quality built environment design and implementation can offer.

This paper offers key insights to practitioners when applying these principles in a range of development contexts. Consideration is given to a building environment which is challenged by poor external air quality, a working culture that favours longer hours in smaller spaces and low energy prices. It concludes by highlighting a number of initiatives which where feasible are quantified based on effect, difficulty of implementation and long term practicality.

Keywords: energy saving, high-performance building, healthy building

1. INTRODUCTION

The building industry has been under a great pressure to reduce energy consumption and greenhouse gas emission to slow global warming. In 2015, the government of Hong Kong SAR issued Energy Saving Plan for Hong Kong's Built Environment 2015-2025+, which set out a target for energy intensity reduction of 40% by 2025 using 2005 as the baseline. Buildings account for 90% of total electricity consumption in Hong Kong and the statutory requirements and regulations for both new and existing buildings have been reinforced regularly. In the course of pursuing high-energy performance building envelope performance improved. Curtain wall systems with high window-to-wall ratios (WWR), require high energy performance glazing with darker colour is typically required to comply with a statutory requirement in Hong Kong.

Globally there is a growing awareness of the impact a built environment can make on physical and psychological health, indicated by sick building syndrome, absenteeism, etc. Following this trend, a building certification system, the WELL Building Standard® was launched to quantify health and well-being of the built environment. This is additional to sustainability focused green building certification systems such as Leadership in Energy and Environmental Design (LEED®) or the Building Environmental Assessment Method (BEAM) Plus in Hong Kong.

Through technical studies for a notional commercial office building incorporating healthy building concepts while maintaining a high energy performance, challenges and opportunities to design have been identified. This paper summarises the findings.

2. DEFINITION OF HEALTHY BUILDING

In the context of building design, this paper focuses on air and light as the factors which have a direct impact to the physical and psychological health of building occupants. The term of healthy, health or well-being in this paper means a performance which minimises harm to physiological and psychological health.

2.2 Air quality

Air pollution increases the risk of strokes, heart disease, lung cancer, and both chronic and acute respiratory diseases – it is estimated that outdoor air pollution caused 3.7 million premature deaths worldwide in 2012. **Particularly in Hong Kong, industrial air pollution and road site pollution from busy traffic threaten people's health.** To enhance the energy performance of buildings, envelope air tightness is required to be higher with less infiltration, therefore ventilation of interior spaces requires mechanical ventilation. A healthy building may mean that indoor air has better air quality than outdoor air in some polluted cities.

10 Light environment

It is an established science that sunlight at different times of day effects human circadian rhythms, although the exact mechanism is not fully understood. However, in a highly controlled built environment, such as office buildings, where occupants may spend nearly half of the day under artificial light, this connection to the natural condition is lost and occupant health can suffer.

3. AIR

3.1 Air pollutants and impact on health

The first step to achieving a better indoor air quality (IAQ) is to identify the pollutants, source of the pollutants and limit of contamination of specific pollutants. Air pollutants are known to cause various health issues, for instance, particulate matters are recognised to cause respiratory and cardiovascular disease.

3.1.1 Criteria

Various organisations advise the maximum allowable concentration of air pollutants including: Environmental Protection Department, HKSAR (EPD); World Health Organization (WHO); U.S. Environmental Protection Agency (EPA); and the WELL Building Standard. The recommended or required values for critical air pollutants for a commercial office building in an urban area by various organisations are summarised in Table 1. In Hong Kong, The EPD has established a voluntary scheme, IAQ Certification Scheme, in which two classes of certification level are quantified: **Good Class and Excellent Class**. The Good Class is classified as 'IAQ that provides protection to the public including the young and the aged', being entitled to obtain one credit in the local green building certification system, BEAM Plus.

Pollutant	Source	Unit	Maximum Concentration				
			EPD [4]		WHO [5] [6]	EPA [7]	WELL* [2]
			Excellent	Good			
CO	Outdoor Tobacco smoke, vehicular exhaust, Industrial activities, construction activities / heating equipment	ppm	1.7 (8hr)	8.7 (8hr)	90 (15min) 50 (30min) 25 (1hr) 10 (8hr)	35 (1hr) 9 (8hr)	9 (8hr)
PM _{2.5}		µg/m ³	N/A	N/A	10 (1yr) 25 (24hr)	12 (1yr) 35 (24hr)	15 (1yr)
PM ₁₀		µg/m ³	20 (8hr)	180 (8hr)	20 (1yr) 50 (24hr)	150 (24hr)	50 (24hr)
NO ₂		ppm	0.021 (8hr)	0.080 (8hr)	N/A	0.100 (1hr) 0.053 (1yr)	N/A
		µg/m ³	40 (8hr)	150 (8hr)	40 (1yr) 200 (1hr)	N/A	
O ₃	Indoor VOC-NO ₂ interaction	ppm	0.025 (8hr)	0.061 (8hr)	N/A	0.070 (8hr)	0.051
		µg/m ³	50 (8hr)	120 (8hr)	120 (8hr)	N/A	N/A
HCHO	Indoor Pressed wood product, paper product	ppm	0.024 (8hr)	0.081 (8hr)	N/A	N/A	0.027
		µg/m ³	30 (8hr)	100 (8hr)	0.0001 (30min)		N/A
TVOC	Indoor Coated furniture, paints	ppb	87 (8hr)	261 (8hr)	N/A	N/A	N/A
		µg/m ³	200 (8hr)	600 (8hr)			500
CO ₂	Indoor Respiration	ppm	800 (8hr)	1,000 (8hr)	N/A	N/A	800

Table 1: Recommended values by various Institutions (Under the WELL Building Standard, all the criteria shown in the table are prerequisite to achieve any certification level. N/A: not available, duration in the bracket indicates the value is the mean in the duration)

3.2 Energy vs air quality

For the pollutants from outside of the building identified in Table 1, air purification or filtration will be effective and for the pollutants produced indoors, adequate outdoor fresh air supply is fundamental, provided that the outdoor air quality is of sufficient quality. For a grade A office building in Hong Kong, with centralised air conditioning, filtration of outdoor air is applied. Different types of filtration are investigated in terms of pollutant removal, implications to energy consumption and maintenance, etc. as shown in Table 2. The figures are based on typical systems installed in Hong Kong.

Minimum efficiency reporting value (MERV) rated filters are categorised based on their filtration levels of dust or particulate matters. MERV 13-16 filters are typically applied for superior commercial buildings. The higher the rating is, the higher the pollutant removal efficiency as well as pressure drop are. When every AHU in a commercial office building (with recirculation) has a MERV 14 filter, energy consumption by AHUs is estimated to increase by approximately 7% when compared to a MERV 13 filter. A desktop study to estimate the PM_{2.5} concentration in the same office building suggests that when MERV 13 filters are installed, the PM_{2.5} and PM₁₀ values of indoor air will not exceed the values recommended by WHO. This study used actual outdoor PM_{2.5} recorded in a business district of Hong Kong Island where 1-year mean level of PM₁₀ is around 23 µg/m³, which is higher than the recommended value by WHO (20 µg/m³). For this case, considering the energy penalty and the effectiveness at achieving a good level of PM, MERV 13 filters can be considered.

On the other hand for other pollutants mainly generated indoors such as HCHO and VOC, activated carbon filters and catalytic ionizers were investigated. As the filtration or purification mechanism of those filters is a chemical reaction, the pressure drop associated with the filtration is smaller than MERV filters. However, electricity input is required for operation and activation of the filter.

Mechanism	Fibre (MERV filters)		Activated Carbon	Catalytic Activated Carbon	Catalytic Ionizer
	MERV13	MERV14			
Major target pollutants	PM	PM	HCHO TVOC	NO ₂ HCHO TVOC	HCHO TVOC Germs
Filtration efficiency	90% PM ₁₀ 85% PM _{2.5} 50% ultra-fine PM	95% PM ₁₀ 90% PM _{2.5} 85% ultra-fine PM	~80% NO ₂	~95% NO ₂	99% TVOC 95% HCHO
Implications to energy	Pressure drop ~120Pa	Pressure drop ~150Pa	Pressure drop ~100Pa	Pressure drop ~50Pa	<45W
Maintenance frequency	Yearly replacement	Yearly replacement	Washing 2/half year	Weekly washing	2 years
By-products	Nil	Nil	Nil	Nil	O ₃

Table 2: Types of air filters for primary air handling units and air handling units

3.3 Design options and strategy

When health is given a higher priority in building design, it starts to become apparent that traditional variable air volume (VAV) systems, which combine fresh air delivery with maintaining temperature and humidity set points have limitations. The limitations primarily arise locally within offices at high pollution zones (e.g. printing rooms) or in high and variable occupied rooms (e.g. meeting or seminar rooms). As such the use of dedicated outdoor air system (DOAS) responding to multiple local sensors show significant advantages for air quality.

Feedback from building management teams often includes multiple complaints regarding meeting room air quality when served by VAV systems. This generally occurs as CO₂ levels are measured once per floor in a return air plenum, accounting for only the number of people per floor. Fresh air then makes up a set percentage of the delivered air per floor. Total delivered air volume to each space is a function of room temperature and as such when meeting rooms become heavily occupied, CO₂ levels increase faster proportionally than heat gains and fresh air is underserved. Computational simulation of a typical office, based on ASHRAE fresh air volumes plus

30%, highlight that meetings rooms served by VAV systems will have CO₂ levels higher than 1,000ppm, i.e. higher than 'Good Class' by EPD (Table 1). Figure 1 below shows VAV performance compared to DOAS. The adoption of DOAS overcomes this and requires pollution sensors in each zone of concern.

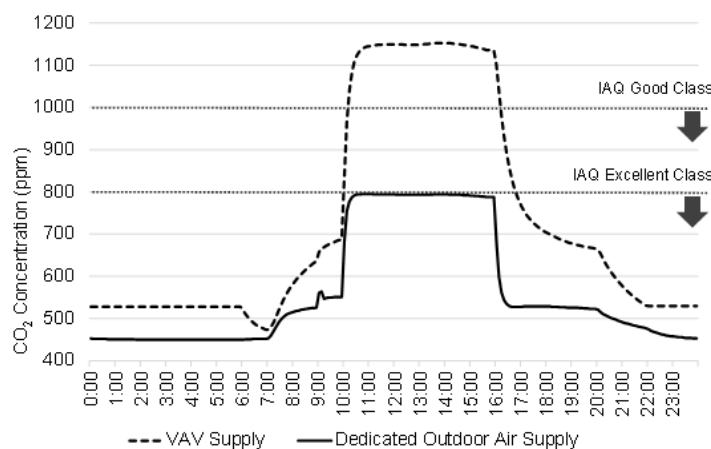

Figure 1: Comparison of fresh air supply systems regarding CO₂ concentration

4. LIGHT

Research has shown that light has a strong relationship with human circadian rhythm, regulating human body clocks and human health. Although the science still leaves uncertainties including the combined effect of different colours, intensities, spectra and experience of light, it is well established that daylight is the best light for human health.

4.1 Natural light and artificial light

The British Standard Code of Practice for Daylighting summarises the benefit of daylight as follows: 1. Regulation of the circadian system; 2. Mood; 3. Seasonal Affective Disorder (SAD); and 4. Ultraviolet radiation. WHO suggest that disruption of circadian rhythm can increase the risk of heart disease. Daylight has variations in light intensity, spectral wavelength distribution and direction throughout the day, all of which are believed to have effects on the circadian rhythm. However, the eyes' biological reaction to light is also affected by the surrounding environment such as a phenomenon known as The Purkinje Effect: when illuminance level is low, human eyes are more sensitive to blue lights.

Due to higher energy efficiency, LED are getting more popular. For a typical office building, lighting power can be reduced by 2-7% compared to T5 fluorescent tubes. By understanding the benefits of natural light or daylight to human health, there is a trend for artificial lighting to mimic daylight in terms of colour temperature variation, directional variation over time and spectral distribution. Improved LED technology in the past few years is reducing issues associated with the technology such as flickering and inconsistent colour, etc. LED has flexibility in control including colour, intensity and daylight spectrum matching. These characteristics of LED enable an artificially lit environment for human health.

4.2 Quality and quantity of light in a space

Major building elements which affect the quality and quantity of light through building façade are identified in Table 3. Glazed curtain wall buildings with high WWR are still favoured for commercial office buildings, maximising the view out from the rental space. When occupants are angled towards a glazed façade, occupants are given access not only to the views but also to daylight. Daylight is commonly measured by the average daylight factor (ADF). In general, higher VLT and WWR directly contribute to higher ADF.

Building Element	Glazing	Shading Device	External/ Internal Blinds
Parameters	• Visual Light Transmittance (VLT)	• Depth	• Configuration

	<ul style="list-style-type: none"> • Shading Coefficient, in relation with VLT (SC) • Colour Rendering Index (CRI) • Window-to-Wall Ratio (WWR) 	<ul style="list-style-type: none"> • Orientation (horizontal/ vertical) • Material 	<ul style="list-style-type: none"> • Control (automatic/ manual) • Colour • Material
--	--	--	---

Table 3: Building elements and parameters to affect quality and quantity of light

Fabric heat gain through building envelope is affected by building orientation, WWR, SC of glazing, U-values of opaque area and density of opaque area, etc. These parameters must be optimised to control heat transfer through the building envelope while achieving targeted VLT and CRI of glazing to ensure the quality of daylight.

4.2.1 Criteria

Lighting criteria under various green building certification systems and standards are compared and highlighted in Table 4. Green building certification systems such as BEAM Plus and BREEAM tend to set the daylighting requirement relative to surrounding environment. This allows flexibility to achieve design criteria. On the other hand, the SLL Code for Lighting and WELL suggest lighting performance of a lit space to suit activities and the visual comfort of occupants.

Source	BEAM Plus	SLL	BREEAM	WELL
VLT	N/A	N/A	N/A	60% (>2.1m from floor) 50% (≤2.1m from floor)
WWR	N/A	N/A	N/A	20-60%
CRI	Ref: SLL	80 for office space	N/A	Ra ≥ 80 R9 ≥ 50
Illuminance (basis for assessment)	Ref: SLL	500 lux for writing, typing, etc.	300 lux	300 lux
ADF	≥ 1.0%	N/A	≥ 1.5%	N/A

Table 4: Requirements and suggested criteria for façade and lighting design of office by different organisations

4.3 Air-conditioning energy vs lighting energy

Glazing with a higher VLT allows higher quantity and quality of daylight to the indoor space which reduces energy consumption and cooling load by artificial lights. At the same time, a higher SC associated with a higher VLT increases solar heat gain, resulting in higher air-conditioning energy. By balancing VLT and SC, the maximum energy saving can be obtained. Various sets of glazing properties are tested using computational simulation to understand the combined energy saving of lighting energy and air-conditioning energy.

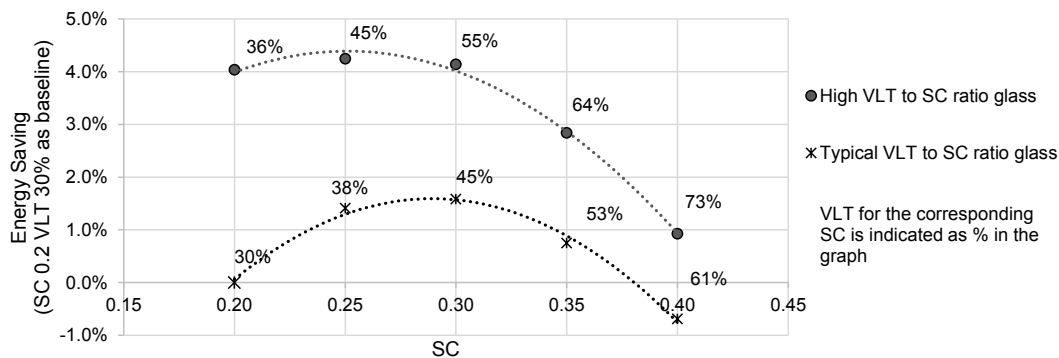

Figure 2: Combined energy benefit comparison for different glass properties: Lighting energy and air-conditioning energy

In Figure 2, the energy saving is obtained as summation of lighting energy saving and air-conditioning saving against the baseline glazing. Lighting energy saving here indicates higher daylight availability, thus better lit environment for human health. Under the climate of Hong Kong, for a typical open plan office building, VLT and SC can be balanced around 45% and 0.25 to 0.30, respectively to achieve the maximum energy saving.

4.4 Design Options and Strategy

The analysis presented in the previous section showed that the balanced point of VLT and SC of glazing can be identified by modelling lighting energy and air-conditioning energy consumption. With the presence of shading devices, daylight enhancing features such as light shelves and the surrounding built environment, the balanced point will vary even under the same climatic condition. These parameters are necessary for the assessment to choose the optimised glazing for a given architectural design.

5. CONCLUSION

Among various parameters which are known to affect human health, this paper highlighted backgrounds and design considerations to achieve a good indoor air environment and light environment. Through literature reviews, desktop studies and computational simulations, challenges and opportunities were identified. For a building, target performance can be set for energy and health based on the function of the space, referring to the global benchmarks. To meet the target, design should be assessed regarding the two performance indicators at the same time because design parameters can affect the two indicators with different magnitude. Globally, there is on-going research regarding building design and human health in science, medical and building industries. It is important for a building design practitioner to understand the science behind a healthy building concept and to establish a clear objective and target for a design to meet building owners' and users' expectations.

REFERENCES

- [1] BEAM Society Limited, 2012. BEAM Plus for New Buildings Version 1.2. Hong Kong.
- [2] BRE Global, 2016. BREEAM International New Construction 2016. Watford.
- [3] British Standards Institution, 2008. The British Standard 8206-2:2008 Lighting for Buildings: Code of Practice for Daylighting. London.
- [4] Delos Living LLC, 2016. The WELL Building Standard® v1 with May 2016 addenda. New York.
- [5] Environment Bureau in collaboration with Development Bureau, Transport and Housing Bureau, Hong Kong SAR, 2015. **Energy Saving Plan For Hong Kong's Built Environment 2015-2025+**. Hong Kong.
- [6] Indoor Air Quality Management Group, Environmental Protection Department, HKSAR Government, 2003. A Guide on Indoor Air Quality Certification Scheme for Offices and Public Places. Hong Kong.
- [7] The Society of Light and Lighting, 2012. The SLL Code for Lighting 2012. Norfolk.
- [8] U.S. Environmental Protection Department, Hazardous Air Pollutants [online]. Retrieved from: <https://www.epa.gov/haps> [Retrieved on 23 September 2016].
- [9] World Health Organization Regional Office for Europe Copenhagen, 2000. Air Quality Guidelines for Europe Second Edition. Copenhagen.
- [10] World Health Organization, 2006. WHO Air quality guidelines for particulate matter, ozone, nitrogen dioxide and sulphur dioxide Global Update 2005. Geneva.
- [11] World Health Organization, Ambient (outdoor) air quality and health Fact sheet [online]. Retrieved from: <http://www.who.int/mediacentre/factsheets/fs313/en/> [Retrieved on 23 September 2016].

Significance of Sky Gardens for Healthy High-Rise Living of Urban Children and Old Adults

Tony IP^a

^a Ronald Lu & Partners (Hong Kong) Ltd., Hong Kong SAR, tonyip@rlphk.com

ABSTRACT

A new typology of sky gardens has been driving design of residential high-rises, which aims at offering communal green spaces at high levels for enhancement of social interactions and neighbourhood place-making while improving environmental conditions simultaneously. However, criticisms have been found that these communal green spaces are merely as gimmicky features and of a low occupancy rate. Indeed, children and old adults spend most of their time in residence. Are these gardens designed for their daily living?

This paper is an attempt to evaluate the effectiveness of these sky gardens contributing to social integration and health development of children and old adults in high-density high-rise contexts. Having reviewed policies, regulations and guidelines in Hong Kong and Singapore, the study investigates the desirable provisions of communal green spaces and amenities in support of a healthy living environment; and co-relates their applicability to the contexts of high-rise residential developments. Case studies of forty residential high-rises in Hong Kong and Singapore map out diverse spatial, functional and landscaping design of sky gardens. Qualitative comparative analysis identifies **key design attributes to children and old adults' enjoyment and their everyday life.**

The findings inform that the current designs of sky gardens follow nominal prescriptive requirements of the **government's green incentives which emphasize environmental performances**, but are less likely deliberated from **users' perspectives with respect to social and psychological benefits. Seldom of them pay attention to creating** children and elderly friendly communal spaces at high levels. Sense of safety and lack of active facilities at existing sky gardens are observed. Recommendations are made to the criteria of the green incentives not only appealing for residential high-rises with nominal amount of green but also qualifying the green to be liveable and enjoyable by daily frequent users comprising children and old adults.

Keywords: policy and regulation, inclusive eco-design, sustainable neighbourhood

1. BACKGROUND

The higher we live from the ground level, the more disconnected we feel from the natural world and even from each other within a community. The population of Hong Kong is expected to remain on an ageing trend, which urges for more health and recreational facilities. On the other hand, urban children are growing up detached from the natural environment and lacking face-face social interaction. How can we improve this situation in high-density high-rise contexts?

Meanwhile, a new typology of sky gardens has been driving design of residential high-rises and offering communal green spaces at high levels for enhancement of social interactions and neighbourhood place-making while simultaneously improving environmental conditions. Children and old adults spend most of their time in residence and are the most frequent users of sky gardens during the daytime.

This study is an attempt to evaluate the effectiveness of these sky gardens contributing to social integration and health development of children and old adults in high-density high-rise contexts. Having reviewed regulations and advisory guidelines in Hong Kong and Singapore, this study investigates the desirable provisions of communal green spaces and amenities in support of a healthy living environment; and co-relates their applicability to the contexts of high-rise residential developments. Case studies of residential high-rises in Hong Kong and Singapore map out diverse spatial, functional and landscaping design of sky gardens. Qualitative comparative analysis **identifies key design attributes to children and old adults' health and wellbeing.**

2. DEFICIENCIES IN HIGH-RISE URBAN LIVING

A study on residents' behaviour in a high-rise apartment concluded that there was a high degree of anonymity and social isolation, including pervasive ignorance about neighbours and little inclination to establish friendly relations with neighbours over forty years ago (Zito, 1974). These phenomena are not uncommonly found in residential high-rises nowadays. Six types of fears are found in **high-rise residence, including a fear of neighbours' suicides**, a fear of fire, a fear of collapse of the building due to earthquake, a fear of the building to be attached in the post-911 era, a fear of crime due to fear of strangers, and a fear of becoming ill due to spread of communicable diseases (Robert, 2007). Furthermore, children in high-rises have fewer chances to go outside to play. They are either to be kept indoors under over-protection or left relatively unsupervised outdoors far away from residences. Children have difficulty developing friendships in their living environment and result in behavioural problems or poorer social skills (Fowler, 2008).

3. COMMUNAL GREEN SPACES IN URBAN LIVING

Pleasant communal green spaces could encourage social interaction among neighbours are important to urban dwellers in high-rise living. Recent research findings have given an important message that we need adequate levels of nearby green spaces in urban living.

Psychological performance

Urban dwellers have a strong request for pleasant communal activity spaces and greenery (Chien & Wang, 1999; Huang, 2006). Urban green spaces with the natural setting can provide some peace and quiet away from the hustle and bustle of the city, and contribute to health and wellbeing (Baur & Tynon, 2010). Natural elements such as trees facilitate social interactions amongst neighbours (Kuo et al., 2002). The mental and physical health benefits are associated with time spent exposed to green spaces (McCurdy et al., 2010).

Social performance

Community treasures the value of communal green spaces. Pleasure-derived leisure experiences are found in a garden. The garden serves as a social arena for group gathering or a quiet, contemplative space to enjoy its peace and beauty (Connell, 2004). Community garden as a potential useful strategy to improve individual health and strengthen neighbourhoods, where each community member has a duty to maintain and foster vegetation of the garden, can enhance social connections, reciprocity, mutual trust, collective decision-making, civil engagement **and community building through people's interactions among their neighbours and planning vegetation** (Amulya, 2009).

Environmental performance

Cooling of the urban environment is of a priority in urban and building design for a subtropical region. Urban microclimate can be improved through urban greening and permeable building fabrics (Levermore & Smith, 2008). Effective landscape design creates thermal comfort and energy efficiency. Vegetation is a real tool for control of microclimatic conditions in external areas (Picot, 2004). Consideration in selection of trees commonly used in the landscape comprises solar transmissivity range in summer and winter, periods of foliation and defoliation, and maximum expected height (Brown & Gillespie, 1995).

Ecological performance

People living in cities are increasingly disconnected from the nature world, witnessing an extinction of experience (Goddard et al., 2009). Urban green spaces have considerably benefits that maximize the biodiversity of urban ecosystems and minimize the extinction of species and the extinction of the human experience of wildlife. The importance of urban green spaces with natural structures is to maintain high ecological diversity (Sandstrom et al., 2006).

Children-friendly urban environment

Biophobia may be developed due to people's fear of living things and unexpectedness from nature. It is not uncommonly observed at urban children especially for those living in metropolitan areas. Contact with nature can evoke negative feelings such as fear, scary, disgusting and uncomfortable; for instance, children raised in urban areas are afraid of being in the woods and were disgusted by the dirtiness of the outdoors (Collado et al., 2015).

Neighbourhood shared spaces and greenery are essential for children's healthy development. Findings of various studies revealed that children in the city become nature-deficit disorder with physical inactivity, social and psychological ramifications and increased chronic disease trend. In Lee and Min's research (2006), children's neighbourhood environment plays a key role in shaping their personality.

Children having more daily contact with nature are able to cope better with adversity. Urban children spending more time in nature enhance environmental attitudes and ecological behaviours. Activities with nature such as **picking fruits, planting seeds or taking care of vegetables improve children's pro-environmental attitudes.** (Collado et al., 2015) Garden activities should also be organized in a way that children have an opportunity to freely use **and shape the environment's affordances, and a well-designed children's garden is recommended (Laaksoharju, 2012).**

The elderly-integrated neighbourhood

Aging population poses strong demands on recreational facilities. They are the major daytime users of green spaces and amenities in or adjacent to their living premises. Gardens facilitate their daily activities including doing exercises, playing chess, reading newspapers, chatting with their friends and neighbours and playing with their grand children. Delvin and Zaff (1998) researched that elderly people prefer garden apartments than high-rises and have a greater sense of community there. Kweon et al. (1998) revealed that green common spaces benefit the social integration of inner-city older adults. Such strong social integration among older adults could also indirectly lessen public expenditure on individual elderly services.

4. SKY GARDENS DEVELOPMENT IN HONG KONG AND SINGAPORE

Sky garden is a micro-environmental design for improvement of wind environment in urban districts. It is also a recreational garden space for communal use. Vertical landscaping and open spaces at the intermediate or high levels of the high-rise are not only for benefits of microclimate but also fostering neighbourhood (Yeang, 2002).

The Hong Kong government issued 'green incentives' for sky gardens in domestic buildings in 2001, including Gross Floor Area (GFA) exemptions and relaxation of the allowable overall building height in regard to provision of sky gardens. Figure 1 illustrates a typical high-rise residential development where podium and sky gardens are for communal use and roof gardens are within the private premises of duplex units at the uppermost storeys.



Figure 1: Podium garden, sky garden and roof garden at a residential development in Hong Kong.

Policies on promoting sky-rise greenery are also found in Singapore. In 2009, the Singapore government announced a target of adding 50 hectares of sky-rise greenery by 2050 and its intermediate target of 30 hectares by 2030. These targets were written in the sustainable development blueprint which was developed by the Inter-ministerial Committee on Sustainable Development.

Two governments' emphases of purposes of sky gardens are fundamentally different from each another in accordance with their incentives and guidelines. These differences also drive the as-built sky gardens in diverse **typologies**. **Hong Kong's sky garden is relatively environmental driven while Singapore's is socially-oriented**. **Hong Kong's requirements restrict locations and numbers of sky gardens, and more prescriptive details there**. For instance, sky gardens are at least at ten storeys apart from each other or podium garden unless under exceptional circumstances where strong environmental justifications are requested. **Doorstep green communal spaces scattered at various storeys or seamlessly integrated with common circulations to facilitate incidental neighbours' interactions** are observed in Singapore but not Hong Kong. Table 1 summarizes detailed comparison of **governments' incentives of two cities**.

	Hong Kong	Singapore
Government Policy	Joint Practice Note (JPN) issued by Buildings Department, Planning Department and Lands Department.	Circular to Professional Institutes issued by Urban Redevelopment Authority. (Circular No. URA/PB/2009/12-DCG)
Year	First issued in 2001; revised in 2011	First introduced in 1997; revised in 2009
Sky Garden Objectives	Sky gardens provide natural ventilation, greenery and recreational garden space for communal use.	Sky gardens serve as quality communal spaces; and contribute towards the overall greenery and environmental quality.
Configuration	The minimum headroom is 4.5m and it is open-sided on at least two opposite sides for cross ventilation.	The proposed depth should be at least 5m.
Quantities	The maximum number of sky gardens provided is equal to or less than the number of residential storeys divided by 15. Such garden can be split into multi-levels but it occupies not less than one-third of the area of the floor plate.	Flexibility of quantities and configurations. Areas of a 45 degree projection line and a meaningful size of 5m in depth. No maximum number of sky gardens is specified
Locations	Locations of sky garden are recommended to be determined by wind tunnel test or computation fluid dynamic modelling but it is not compulsory. The first sky garden is located at not more than 10 storeys where more than one sky garden is provided and where there is podium garden.	No specific requirement.
Openness	Open-sided above safe parapet height on at least two opposite sides to provide cross ventilation	At least 40% of the perimeter should be open and 60% for additional GFA exemption.
Height	A clear height should not be less than 4.5m. There is no concern from Planning Department on the overall building height.	The guideline, which states areas of a 45 degree projection line for GFA exemption and a meaningful size of 5m in depth, implicitly defines the min. headroom is 5m.
Connectivity	It is accessible from the common area only.	One set of communal access via a lift or staircase serves the sky garden. If the sky garden is less than 60% of the floor plates, it should serve a minimum of 2 strata units to ensure its communal use in nature.
Greenery	Not less than 15% of the garden area is to be planted with greenery.	Lushly landscaped with a suitable variety of plants is required. The greenery should be enjoyed by the building users and be visible from the surrounding environment.
Incentives	GFA exemption for sky gardens if the above requirements are complied. However, floor height of sky gardens may not be exempted if the overall building height is capped under the OZP or the land lease.	GFA exemption: Flexibility of quantities and configurations. Areas of 45 degree projection line and a meaningful size of 5m in depth. No maximum number of sky gardens is stated. Additional floor height allowance for predominant sky gardens.

Table 1: Governments' incentives and guidelines on sky gardens in Hong Kong and Singapore

5. DISCUSSION ON EFFECTIVENESS OF SKY GARDENS IN HIGH-DENSITY HIGH-RISE RESIDENTIAL DEVELOPMENT FOR URBAN CHILDREN AND OLD ADULTS

To exemplify the benefits to promote health and well-being in urban living, case studies of forty residential high-rises in Hong Kong and Singapore map out diverse functions, configurations, connectivity and amenities of sky gardens.

Design intents of sky gardens commonly found in Hong Kong are to increase of the overall building height; demarcate zones of residential units in different sizes and property values; add value to refuge floors; offer extended areas of and/ or circulation to clubhouse areas; increase of greenery; and enhance building permeability. Most of study cases of sky gardens in Singapore that offer unique, pleasant, well-equipped communal green spaces that may outstand from other garden spaces at podium or street level; moreover, they are promoted as key marketing selling points for adding property values.

The most popular amenities in sky gardens are tea leisure area, sitting area, viewing platform, Taichi square, foot massage trail and strolling path. However, apart from good accessibility in connection with clubhouse, the developers may be lack of confidence on the performance of sky gardens and are unwilling to allocate management-intensive recreational facilities in sky gardens, in which discrete locations at high levels incur safety and security concerns. Structures and fire services provisions restrain spatial configuration of sky gardens, in particular sky gardens as refuge floors. It results in narrow spaces as illustrated in Figure 2 and Figure 3.

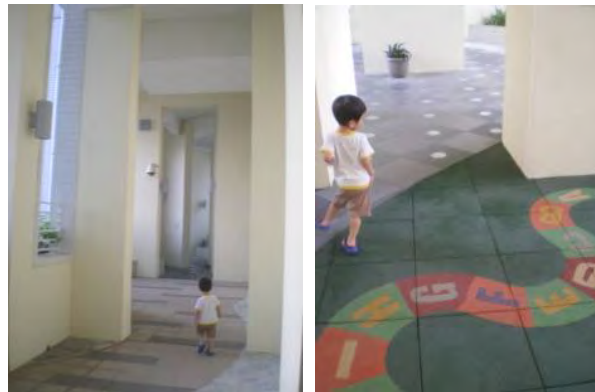

Figure 2 and 3: Spatial quality with 4.5m headroom but narrow spaces in a sky garden in Hong Kong.

Design of children and old adults friendly sky garden

Healthier and more active lifestyles, day-to-day interactions between human and the built environment are encouraged. Daily activities in green spaces, including 5-min green exercises, gardening, walking and even viewing of nature, can offer psychological and physiological benefits to urban dwellers. The respective contributing factors to promote health and wellbeing are summarized in Figure 4.

Indeed, children and old adults are the frequent users of sky gardens or communal green spaces during the daytime; meanwhile, childhood experiences with nature affect environmental attitudes and ecological behaviours. Key design considerations of advocating friendliness for children and old adults are as follows:

- Vegetation volume and multi-dimensional vegetation of rich in species enhance the level of naturalness.
- Communal green spaces indirectly help supervising children and old adults in impoverished urban neighbourhoods, and enhance their time exposed to nature and outdoor activities.
- Activities with nature, such as picking fruits, planting seeds or taking care of vegetables, nurture positive, ecologically responsible attitudes. Meanwhile, **garden-based activities help to develop children's ability to cope with adversity and zone of proximal development**; and to foster their environmental attitude and ecological behaviours.
- A safe, secure and spacious environment but offering a feeling of adventure and semi-wildness simultaneously is an ideal. Children are able to freely use and easily modify materials in building their own world. Special features like water features and recreation amenities catch their attention.

- Children are encouraged to see, touch and live with flora and fauna rich in diversity and learn to appreciate native species and eco-systems. As one step further than sustainable design that minimizes adverse environmental impacts, biophilic design advocates positive effects on the natural environment and enhances quality of habitats for human and wildlife.
- Design of soft landscapes shall consider native or non-invasive species of plants, vivid vegetation structures, appropriate soil depths and substrate compositions, and features that attract or facilitate bio-habitats.
- Sky gardens are scattered at multi-levels and close to living areas of residences to stimulate intimate touch with greenery in daily life. Doorstep gardens are recommended and residents are encouraged to maintain the vegetation and even plant their own vegetation there to enhance the ownership of communal green spaces and develop a deep affinity with nature. More importantly, children are allowed to play outdoors with neighbouring children under better supervisions with their parents. Old adults have more chances to stay outdoors.

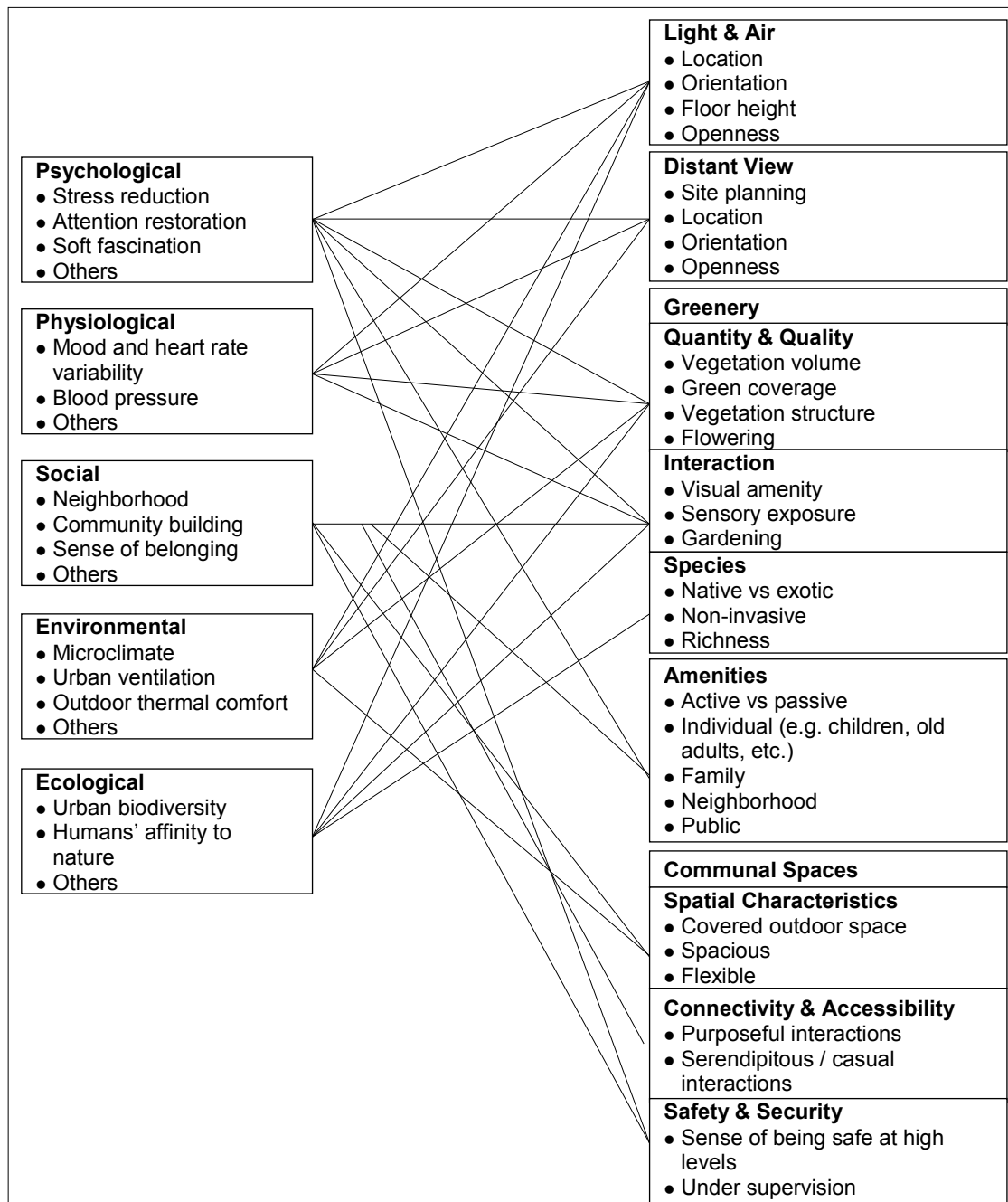

Figure 4: Contributing factors to promote health and well-being of urban living with sky garden

6. CONCLUSION

The higher we live from the ground level, the more disconnected we feel from the natural world and even from each other within a community. Quality urban living environment not only furnishes residents with convenient accessibility and adaptable conditions but also embodies welcoming communal amenities, enjoyable greenery and intimate human-nature interactions. Sky gardens improve environmental, social and ecological performances in urban living, and supplement deficiencies and needs in high density, high-rise residential developments, especially in Asian cities like Hong Kong and Singapore. With better understanding of typology of sky gardens, their benefits to the environment include improved human thermal comfort and urban microclimate; social cohesion by providing a community green space, provision of a place for individuals to escape from the busy city life, improved community integration for all age groups and improved health and well-being; and an awareness of and intimate contact with nature. Furthermore, the criteria of the green incentives shall not only appeal for residential high-rises with nominal amount of green but also advocate the green communal spaces to be liveable and enjoyable by daily frequent users comprising children and old adults.

REFERENCES

- [1] Amulya, J., Bardwell, L., Buchenau, M., Litt, S. J., Marshall, J. A., and Teig, E., 2009. Collective efficacy in denver, colorado: strengthening neighbourhoods and health through community gardens. *Health & Place*, vol.15, pp.1115-1122.
- [2] Baur, J.W.R., Tynon, J.F., 2010. Small-scale urban nature parks: why should we care? *Leisure Sciences: An Interdisciplinary Journal*, vol.32, pp.195-200.
- [3] Brown, R.D., Gillespie, T.J., 1995. *Microclimatic Landscape Design – Creating Thermal Comfort and Energy Efficiency*, New York: J. Wiley & Sons.
- [4] Chien, H.T., Wang, M.S., 1999. Environmental behaviour analysis of high-rise building areas in Taiwan. *Building and Environment*, vol.34, pp.85-93.
- [5] Collado, S., Corraliza, J.A., Staats, H., and Ruiz, M., 2015. Effect of frequency and mode of contact with **nature on children's self**-reported ecological behaviours. *Journal of Environmental Psychology*, vol.41, pp.65-73.
- [6] Connell J., 2004. The Purest of Human Pleasures - The characteristics and motivations of garden visitors in Great Britain. *Tourism Management*, no.25, pp.229–247.
- [7] Corraliza, J.A., Collado, S., and Bethelmy, L., 2012. Nature as a moderator of stress in urban children. *Procedia – Social and Behavioural Sciences*, vol.38, pp.253-263.
- [8] Delvin, A.S., Zaff, J., 1998. Sense of community in housing for the elderly. *Journal of Community Psychology*, vol.26, no.4, pp.381-398.
- [9] Fowler E. P., 2008. Faulty Towers: Contrary to Popular Belief, High-rises are Not the Answer for Higher Density Living. *Alternative Journal*, no.34, vol.1, pp.24-26.
- [10] Goddard, M.A., Dougill, A.J., Benton, T.G., 2009. Scaling up from gardens - biodiversity conservation in urban environments. *Trends in Ecology and Evolution*, vol.25, no.2, pp.90-98.
- [11] HK Government, 2001. Joint Practice Note No.1 – Green and Innovative Buildings, Buildings Department, Lands Department and Planning Department, HKSAR.
- [12] Huang, S.C.L., 2006. A study of outdoor interaction spaces in high-rise housing. *Landscape and Urban Planning*, vol.76, pp.193-204.
- [13] Kuo, F.E., Sullivan, W.C., Taylor, A.F., 2002. Views of nature and self-discipline - evidence from inner city children. *Journal of Environmental Psychology*, vol.22, pp.49-63.
- [14] Kweon, B.S., Sullivan, W.C., Wiley, A.R., 1998. Green common spaces and the social integration of inner-city older adults. *Environment and Behaviour*, vol.30 pp.832-858.
- [15] Laaksoharju, T., Rappe, E., and Kaivola, T., 2012. Garden affordances for social learning, play, and for building nature-child relationship. *Urban Forestry & Urban Greening*, vol.11, pp.195-203.
- [16] Lee, J., Min, B., 2006. **Children's neighbourhood place as a psychological and behavioural domain**. *Journal of Environmental Psychology*, no.26, pp.51–71.
- [17] Levermore, G., Smith, C., 2008. Designing urban spaces and buildings to improve sustainability and quality of life in a warmer world. *Energy Policy*, vol.36, pp.4558-4562.
- [18] McCurdy, L.E., Winterbottom, K.E., Mehta, S.S., Roberts, J.R., 2010. Using nature and outdoor activity to **improve children's health**. *Curr Probl Pediatr Adolesc Health Care*, no.5, pp.102-117.

- [19] Picot, X., 2004. Thermal comfort in urban spaces: impact of vegetation growth – case study: Piazza della Scienza, Milla, Italy. *Energy and Buildings*, vol.36, pp.3239-334.
- [20] Robert, G., 2007. The Consequences of Living in High-Rise Buildings. *Architectural Science Review*, vol.50, no.1, pp.2-17.
- [21] Sandstrom, U.G., Angelstam, P., Mikusinski, G., 2006. Ecological diversity of birds in relation to the structure of urban green space. *Landscape and Urban Planning*, vol.77, no.1, pp.39-53.
- [22] Yeang, K., 2002. *Reinventing the skyscraper: a vertical theory of urban design*. Chichester: Wiley-Academy.
- [23] Zito, J.M., 1974. Anonymity and neighbouring in an urban, high-rise complex. *Journal of Contemporary Ethnography*, vol.3, pp.243-263.

Radon Infiltration in Rented Accommodation

Torben Valdbjørn RASMUSSEN^a

^a Danish Building Research Institute, Aalborg University, Denmark, tvr@sbi.aau.dk

ABSTRACT

Indoor radon levels were measured in 221 homes located in 53 buildings, including 28 multi-occupant houses and 25 single-family terraced houses. The homes consisted of rented accommodation located in buildings recorded as being constructed before 2010 and after the year 1850. The radon level in homes was measured and the buildings were registered for a series of variables describing upgrades, facilities, building components, construction characteristics and used materials. In addition, the radon level was measured in the basement in 9 of the buildings. The mean year value of the indoor radon level was 30.7 (1–250) Bq/m³. The indoor radon level exceeded 100 Bq/m³ in 5.9% of the homes, all located in single-family terraced houses. The investigated variables explained 5.9% of the variation in indoor radon levels, and although associations were positive, none of these, besides homes in single-family terraced houses, were statistically significant. However, a number of the variables seem to characterise homes with a low radon level. Approx. 75% of homes exceeding 100 Bq/m³ indoor radon level had levels between 100 and 200 Bq/m³ and 25% had indoor radon levels exceeding 200 Bq/m³. The risk of indoor radon levels exceeding 100 Bq/m³ in homes in multi-occupant houses was found to be very low, but the risk was highest on the ground floor in a building constructed with slab on ground.

Keywords: indoor environmental quality, radon, variables

1. INTRODUCTION

Radon-222 develops from the radioactive decay of radium-226 and has a half-life of 3.8 days. This gas seeps through soil into buildings, and if it is not evacuated, there can be much higher exposure levels indoors than outdoors, which is where human exposure occurs. In this way, radon affects occupants through the indoor climate.

The World Health Organization recommends states to introduce requirements for the maximum concentration of radiation from natural sources in the indoor air. These recommendations are the result of the World Health Organization's evaluation of radon as being responsible for 3-14% of lung cancer incidents, depending on the average radon exposure in different countries. Results show radon to be the second-largest cause of lung cancer (tobacco smoking is still the primary cause). Radon exposure must be taken seriously in the struggle against radon-induced lung cancer due to the large number of people who are exposed daily in buildings and especially in residential buildings. If people spend their whole life in a house with an average radon concentration in the indoor air that exceeds 200 Bq/m³, their risk of getting lung cancer is higher than 1%. This is far too high and higher than what in other contexts is acceptable for a single-factor risk. Therefore, it is crucial to ensure a low radon level in the indoor air and to prevent radon from infiltrating into buildings. It is recommended that indoor radon levels in homes should be below 100 Bq/m³.

In a national survey of radon in over 3000 Danish dwellings, the population-weighted average annual radon concentration was 59 Bq/m³, which is more than twice the mean concentrations measured in the Netherlands and the UK, somewhat higher than the mean concentrations measured in Canada and the USA and about half the mean concentrations in Finland and Sweden.

In this study, radon levels in rented accommodation were measured in the winter of 2013/14 and again in the winter of 2014/15. The paper shows how well 221 homes for rented accommodation perform with respect to the recommendations for indoor radon levels, and to identify the association between indoor radon in these homes and floor level, multi-occupant houses, single-family terraced houses, and basements. The number of homes with radon levels exceeding 100 and 200 Bq/m³ was determined.

2. MEASUREMENTS

Measurements were carried out in 221 homes for rented accommodation and in 9 basements. Families and building owners were invited to participate in a radon monitoring programme. The programme took place in the heating periods of 2013/2014 and 2014/2015 between November and May. 196 homes were located in 28 multi-occupant houses and 25 homes were located in single-family terraced houses. 221 families agreed to participate, and radon levels were monitored in their homes. The selected municipalities are located in regions where other studies have shown a 1-30% chance of finding detached single-family houses with radon levels exceeding 200 Bq/m³. Three detectors (Gammadata Mattek AB, Uppsala, Sweden) were distributed to each participant by mail in sealed aluminum-coated envelopes and returned after the integration period in a prestamped envelope. Each participant was asked to fill in a questionnaire regarding the date when exposure started and ended, as well as type of room in which the detector was placed. Participants were instructed regarding placement of the detectors (>25 cm from a wall and away from strong draughts and heat) and also instructed to clean and ventilate their homes as they usually would, so that representative levels were obtained. Information regarding year of construction, basement, crawl space, building and roof materials was gathered from the Danish Building and Housing Register. Information gathered from the Danish Building and Housing Register was used to make sure that homes represented typical rented accommodation in Denmark. In addition homes were registered for a series of variables describing the characteristics of the building where the accommodation was located. Registrations were carried out on site.

3. DWELLINGS

Homes were either rented accommodation located in buildings privately owned by land-lords or social housing owned by the Danish association of non-profit rented accommodation. Buildings were multi-occupant houses and single-family terraced houses. The buildings represented the building technique and commonly used building materials used in Denmark from 1850 until today.

Buildings were grouped into three types, Type A, Type B and Type C. Type C included both multi-occupant houses and single-family terraced houses.

3.1 Type A

Multi-occupant house built between 1850 and 1920. Buildings were constructed with a solid brick wall founded on masonry foundations. Sometimes single natural stones might be included in the foundations and outer walls. Suspended floors were timber floor constructions.

3.2 Type B

Multi-occupant house built between 1920 and 1960. Buildings were constructed with solid brick walls or cavity walls founded on cast-on-site concrete foundations. Suspended floors were timber floor constructions or reinforced concrete suspended floors cast on site. Solid floors against the ground were made of concrete.

3.3 Type C

Multi-occupant house or single-family terraced house built in the period from 1960. Buildings were constructed with load-bearing concrete constructions as prefabricated elements above the ground. Foundations and load-bearing basement walls were made of concrete cast on site. Suspended floors were made of reinforced concrete usually as prefabricated concrete elements. Solid floor against the ground were made of concrete cast on site.

4. EQUIPMENT

The detectors were closed passive etched track detectors, made from CR39 plastic film placed inside an antistatic holder (Gammadata Mätteknik AB, Uppsala, Sweden). During the integration period, alpha and its decay products cause damage to the film. Gammadata Mätteknik is ISO 17025 and ISO 14001 certified as well as EMAS (European Eco-Management and Audit Scheme) registered. Measurement methods are accredited according to standards of SWEDAC (Swedish board of Accreditation and Conformity Assessment) and accepted in 18 European countries by the European Cooperation for Accreditation of Laboratories (EAL).

5. RESULTS

Radon was measured for a median duration of 90 days (min–max: 60 – 194 days). A single representative indoor radon concentration for each home was calculated as the arithmetic average of the three measurements and used in all statistical analyses.

Table 1 shows the distribution of the determined mean year values of the radon concentration grouped according to floor level in intervals of 50 Bq/m³. The minimum value was 1 Bq/m³, the maximum value was 250 Bq/m³. The standard variation was 38.3 Bq/m³, the median value was 18 Bq/m³ and the mean value was 30.7 Bq/m³. The ratio of homes with a mean year value of the radon concentration ranging between 100 Bq/m³ and 200 Bq/m³ was 4.5%. The ratio of homes with a mean year value of the radon concentration exceeding 200 Bq/m³ was 1.4%. The ratio of homes with a mean year value of the radon concentration exceeding 100 Bq/m³ was 5.9%.

Floor	0-50	51-100	101-150	151-200	>200	Number of homes
Ground floor	58	18	7	3	3	88
1st	50	0	0	0	0	51
2nd	38	0	0	0	0	38
3rd	30	0	0	0	0	30
4th	6	0	0	0	0	6
5th	8	0	0	0	0	8
Number of homes	190	18	7	3	3	221
Ratio in %	86.0	8.1	3.1	1.4	1.4	100

Table 1: The number of homes grouped according to the determined mean year values of the radon concentration is shown by their location, as the floor number, and in intervals of 50 Bq/m³.

Table 2 shows the distribution of the determined mean year value of the radon concentration in homes grouped in intervals of 50 Bq/m³ for homes located on the ground floor in multi-occupant houses.

	0-50	51-100	101-150	151-200	>200	Number of homes
Home over basement/crawlspace	42	5	0	0	0	47
Ratio in %	89.4	10.6	0	0	0	100
Home with floor on ground	9	7	0	0	0	16
Ratio in %	56.3	43.7	0	0	0	100

Table 2: The number of homes grouped by the determined mean year value of the radon concentration in intervals of 50 Bq/m³. Homes were located on the ground floor in multi-occupant houses.

Table 3 shows the investigated variables that homes were registered for describing the characteristics of the building where the accommodation was located.

Figure 1 shows the mean year value of the radon concentration for homes in a building with a basement that had not been fire protected. The mean year value of the radon concentration of the indoor air of the homes was 30.2 Bq/m³ determined with a standard variation of 37.4 Bq/m³ and a variation coefficient of 124%. Homes located in a building without a fire protected basement numbered 120.

Figure 2 shows the mean year value of the radon concentration for homes in a building with a basement that had been fire protected. The mean year value of the radon concentration of the indoor air of the homes was 17.4 Bq/m³ determined with a standard variation of 8.6 Bq/m³ and a variation coefficient of 50%. Homes located in a building with a fire protected basement numbered 62.

Variables	Radon [Bq/m ³]	Std.var. [Bq/m ³]	Var. [%]	Number of homes
Suspended floors of concrete	15.7	8.8	56	63
Suspended floors partly of concrete and partly of timber floor constructions	29.6	8.5	29	8
Suspended floors of steel and brick materials	26.3	40.7	155	26
Suspended floors of timber floor constructions	32.9	37.4	114	97
Bathroom with no outer walls	27.5	30.9	113	164
Bathroom with outer wall	7.5	2.6	34	8
Staircase connecting basement with home	20.3	19.4	96	144
Staircase without entrance to basement	36.3	21.9	60	28
Other entrance to home than staircase	50.0	67.4	135	24
Building without elevator	28.6	31.4	110	156
Building with elevator	11.3	6.4	56	29
Building without garbage chute	33.7	37.7	112	100
Building with garbage chute	18.4	20.9	114	94
Air change by grate mounted exterior wall	33.5	21.0	63	40
Air change without grate mounted exterior wall	25.8	34.9	135	139
Building without heat recovery	27.1	30.4	112	171
Building with heat recovery	7.5	2.6	34	8
Original floor construction in basement	26.2	30.2	115	170
Upgraded floor construction in basement	16	7.4	46	8
Floor drain in basement floor	18.2	12.8	67	105
Basement floor without floor drain	38.2	44	115	64
Visible gaps in suspended floors	26.2	18.1	69	90
Expected airtight suspended floors	22.1	30.9	140	45
Pipes drawn outside service shaft	26.2	35.4	135	104
Pipes drawn inside service shaft	25.2	19.0	76	66
Exterior basement walls of masonry	22.9	11.6	51	52
Exterior basement walls of concrete	17.6	21.3	121	105
Exterior basement walls of leca materials	55.7	52.1	93	37
Basement without fire protection	30.2	37.4	124	120
Fire protected basement	17.4	8.6	50	62
Cavity walls with thermal insulation	31.1	38	122	139
Cavity walls without thermal insulation	21.0	18.2	86	78
Retrofitted exterior walls	15.6	14.4	92	48
Original exterior walls (No retrofitting)	31.0	36.8	119	91
Windows with frames of plastic	26.0	40.9	157	97
Windows with frames of wood	26.6	18.2	69	97

Table 3: Mean year value of the radon concentration in Bq/m³, together with the standard variation in Bq/m³, the variation coefficient in per cent and the number of homes located in a building with the specific characteristic.

Other variables describing buildings with accommodation with a low radon level was: (radon concentration of the indoor air/standard variation/variation coefficient/number of homes)

- a building with an upgraded basement floor (16 Bq/m³/7.4 Bq/m³/46%/8)
- a building with homes with gaps around pipes going through the horizontal partition that was sealed and therefore the suspended floors were expected to be sufficiently airtight (22.1 Bq/m³/30.9 Bq/m³ /140%/45)

- a building with homes with suspended floors of concrete (15.7 Bq/m³/ 8.8 Bq/m³/56%/ 63)
- a building with homes with suspended floors partly of concrete and partly of timber floor constructions (29.6 Bq/m³/8.5 Bq/m³/29%/8)
- a building with an elevator (11.3 Bq/m³/6.4 Bq/m³/56%/29)
- a building with homes with a forced mechanical ventilation system connected to a heat recovery unit (7.5 Bq/m³/2.6 Bq/m³/34%/8).

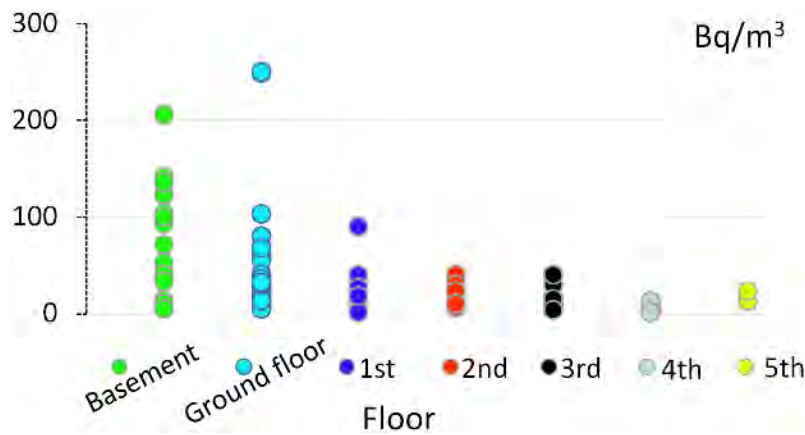

Figure 1: Mean year value of the radon concentration for homes in a building with a basement that has not been fire protected. Homes are located on the ground floor, 1st, 2nd, 3rd, 4th and 5th floors.



Figure 2: Mean year value of the radon concentration for homes in a building with a basement that has been fire protected. Homes are located on the ground floor, 1st, 2nd, 3rd, 4th and 5th floors.

6. DISCUSSION

This study found a mean year value of the indoor radon level of 30.7 Bq/m³ ranging between 1 and 250 Bq/m³. In total, 5.9% (13 of the 221) homes had indoor radon levels exceeding 100 Bq/m³, all located in single-family terraced houses. The investigated variables explained 5.9% of the variation in indoor radon levels, and although associations were positive, none of these besides homes in single-family terraced house were statistically significant. However, the fact that the basement floor had been upgraded, that the basement was fire protected, that gaps around pipes going through suspended floors was sealed, that suspended floors was of concrete, that suspended floors were partly of concrete and partly of timber floor constructions, the presence of an elevator and forced mechanical ventilation connected to a heat recovery unit was observed to be variables of interest determining low radon levels in homes. Unfortunately the number of homes located in a building with these specific characteristics was limited and therefore not concluded to characterise homes with a low radon concentration in rented accommodation.

The mean year value of the radon level of 30.7 Bq/m³ is somewhat lower than the population-weighted average annual radon concentration of 59 Bq/m³ for all Danish homes. The population-weighted average annual radon concentration of 59 Bq/m³ was based on 1-year measurements in 3012 single-family homes and 101 multifamily (apartment buildings) in Denmark, and measurements form the basis of a radon map covering Denmark.

The present study found the indoor radon level exceeded 100 and 200 Bq/m³ in 10 (4.5%) and 3 (1.4%) homes, respectively. Approx. 75% of homes with indoor radon levels exceeding 100 Bq/m³ had levels between 100 and 200 Bq/m³ and 25% had indoor radon levels exceeding 200 Bq/m³. Significant differences in indoor radon levels were found in homes located in multi-occupant houses. The risk of indoor radon levels exceeding 100 Bq/m³ in homes in multi-occupant houses is very low, but if there is a risk, it is most likely to be found in the lowest accommodation in a building with a slab on ground. A risk of indoor radon levels exceeding 100 Bq/m³ was found in homes in single-family terraced houses.

The high levels in homes in single-family terraced houses may be explained by the possible deterioration of their radon protection due to the development of micro-cracks in individual materials, cracks in joints between building components, fissures associated with aging of the homes, alterations in air change rates, or some form of construction alterations made by home owners, which may penetrate the radon barrier.

The municipalities selected in the present study were previously characterised as having the highest levels of residential radon concentration indoors in Denmark (1–30% of homes with levels over 200 Bq/m³). Measurements showed that the soil type was the main determinant of indoor radon levels. The present study did not include measuring radon levels in soil. The homes in this study were located on clayey/sandy to clayey soil, with 2–18% sand and gravel content, and although radon variation in these soils can be expected, this is not described at each specific home location.

The present study has several limitations including power constraints, which may affect the ability to detect associations. Furthermore, information on many other variables such as the specific radon protection measure used, interior wall and ceiling materials, radon ground concentrations, radon diffusion resistance, air permeability of the soil, air pressure differences, and air change rates in all homes were not acquired in the data acquisition process. These variables are all important in relation to the variation in radon levels indoors. More work is justified, and a more comprehensive study utilising an extended model including these variables should be considered in relation to the variation in indoor radon concentration in Danish homes.

7. CONCLUSION

This study found a mean year value of the indoor radon level of 30.7 Bq/m³ ranging between 1 and 250 Bq/m³. In total, 5.9% (13 of the 221) homes had indoor radon levels exceeding 100 Bq/m³, all located in single-family terraced houses. Approx. 75% of homes exceeding 100 Bq/m³ indoor radon level had levels between 100 and 200 Bq/m³ and 25% had indoor radon levels exceeding 200 Bq/m³. Significant differences in indoor radon levels were found in homes located in multi-occupant houses. The risk of indoor radon levels exceeding 100 Bq/m³ in homes in multi-occupant houses is very low, but if there is a risk, it is most likely to be found in the lowest accommodation in a building with a slab on ground. A risk of indoor radon levels exceeding 100 Bq/m³ was found in homes in single-family terraced houses. None of the other investigated variables explained the variation in indoor radon levels in homes. However, the fact that the basement floor had been upgraded, that the basement was fire protected, that gaps around pipes going through suspended floors were sealed, that suspended floors were of concrete, that suspended floors were partly of concrete and partly of timber floor constructions, the presence of an elevator and forced mechanical ventilation connected to a heat recovery unit were not significant variables characterising homes with a low radon concentration in rented accommodation, but seen to be variables that need to be further studied.

ACKNOWLEDGMENTS

This study was supported by the Danish association of private land-lords of multi-occupant houses and the Danish association of non-profit rented accommodation.

REFERENCES

- [1] Nazaroff, W.W., (1992). Radon transport from soil to air, *Rev. Geophys.*, 30, 137– 160.
- [2] Brunekreef, B. and Holgate, S.T., (2002). Air pollution and health, *The Lancet*, 360, 1233–1242.
- [3] Zeeb, H., Shannoun, F. (ed)., (2009). WHO Handbook on indoor radon – a public health perspective. World Health Organization. Geneva. 94 p.

- [4] Andersen, C.E., Bergsøe, N.C., Brendstrup, J., Damkjær, A., Gravesen, P. og Ulbak, K., (1997). Radon-95: En undersøgelse af metoder til reduktion af radonkoncentrationen i danske enfamiliehuse. Forskningscenter Risø, Risø-R-979(DA), 108 sider, www.risoe.dk
- [5] Andersen, C.E., Ulbak, K., Damkjaer, A. and Gravesen, P., (2001a). Radon in Danish Dwellings, Copenhagen, National Institute of Radiation Hygiene.
- [6] UNSCEAR, (2000). United Nations Scientific Committee on the Effects of Atomic Radiation. Sources and Effects of Ionizing Radiation. Report to the General Assembly with Scientific Annexes, Vol. I: Sources New York: United Nations.
- [7] Christensen, G., (2011). The Building and Housing Register, *Scand. J. Public Health*, 39, 106–108.
- [8] Andersen, C.E., Ulbak, K., Damkjaer, A., Kirkegaard, P. and Gravesen, P., (2001b) Mapping indoor radon-222 in Denmark: design and test of the statistical model used in the second nationwide survey. *Sci. Total Environ.*, 272, 231–241.
- [9] Greve, M.H. and Breuning-Madsen, H., (1999). Soil mapping in Denmark. European Soil bureau, Research Report No. 9.

A Case Study on Industrial Building IEQ Control and Operation Performance Analysis

ZHANG Wei^a, WANG Hui^b

^a Bulter (Shanghai) Inc., Mainland China, wayne.zhang@bluescope.com

^b BlueScope Building System (Xi'an) Co., Ltd., Mainland China, lisa.wang2@bluescope.com

ABSTRACT

This is a case study on IEQ control in a green industrial plant, which obtained both China Green Building Label—3 Star level and US LEED Gold Certificate. This paper focuses on three parts of IEQ control in industrial buildings, which are indoor temperature, air quality and noise. All green building products in this plant are discussed in the paper, such as, high reflection roof panels, enhanced building insulation, natural ventilation, fume& particulates collectors, acoustical inner panels and practical effects.

After years of operation, all the collected data indicates the significant of building a green industrial plant on **reducing outdoor environmental pollution, improve IEQ and protect people's health. Also it could** provide more economic benefits.

Keywords: green industrial building, building thermal insulation, IEQ control

1. PROJECT BACKGROUND

The development of green building mainly focuses on residential buildings and commercial buildings in china. Industrial buildings, which consume the largest part of total building energy consumption, have received little concerns. Building a high-performance green building in industry should consider not only the building itself, but also the manufacturing process and people health in the building.

This project is built strictly by owner, consulting company, design institute, GC and subcontractor under the direction of US LEED rating system. Based on US LEED Life-cycle concept, it begin with the feasibility research, pre-design decisions, continued through location selection, design, construction, operations and maintenance, refurbishment, and renovation. This project obtains LEED Platinum for office building and LEED Gold for workshop, which provides a typical study case for green building research in industrial area.

2. PROJECT INTRODUCTION

The project is located in Xi'an Hi-Tech industrial zone with a office building, 2 workshops and auxiliary buildings. Total structure area is 52000m², which separated by office building of 9,000 m² and workshop of 43,000 m². This paper focuses on the performance of workshops.

Workshops in the project are light-steel structure systems, one floor with large indoor space. Products in the plant are metal building components. Manufacturing process includes metal cutting, welding, metal forming, punching, coating, etc. (Figure 1).



Figure 1: Project aerial view

The project is located in temperate continental monsoon climate area. The annual average temperature is 13.1~13.4°C, 35~41°C in summer, and -1~8°C in winter.

3. PROJECT TARGET

The aims of building the project are to achieve both US LEED Gold Certification and China Green Building 3-star Label. Green building strategy is realized throughout the entire process from feasibility research, pre-design stage, design, construction, to operations and maintenance.

Considering the particularity of industrial buildings, indoor environmental quality (IEQ) is the main issue. To address a well-performing IEQ, suitable and practical design decisions are necessary in the early phase to ensure successful implementation. Based on the building aims, every single element that affect to IEQ control is considered in project design to provide a comfortable and energy-saving indoor environment, such as temperature, particulate matter and noise indoor.

4. IEQ CONTROL EFFORTS AND ITS EFFECTS

4.1. Indoor temperature

4.1.1 Indoor temperature control in winter

Gas radiation heating system is installed in workshops for winter heating due to the characteristics of manufacturing process, which is little human is needed for manufacture. The system can be programmed and activated individually by occupants with different comfortable sensation.

Area of heating load in workshop No.1 is 16788m².40 sets of heating equipment (thermal power: 51kw, 230V/50Hz) are equipped. Total thermal power in No.1 workshop is 2040kw.

Area of heating load in workshop No.2 is 18345m².44 sets of heating equipment (thermal power: 51kw, 230V/50Hz) are equipped. Total thermal power in No.2 workshop is 2244kw.

4.1.2 Indoor temperature control in summer

Production equipments in workshops have little thermal radiation during metal forming, punching, and cutting. Therefore, indoor heat load in summer mainly comes from outdoor. With no AC system in workshops, following green strategy presents how a passive green building works to provide a comfortable working environment:

- Close most of the louvers in the lower part surrounding the workshop buildings to block hot air.
- Install fans for particular workstations to enhance ventilate.
- High-performance roof panel is installed on the top of workshops. With extremely good performance on sunlight reflection and emission, the roof panel can reflect over 94% (SRI=94) of sunlight and heat to avoid the island heat effect in hot weather, and keep indoor temperature comfortable.
- Enhanced thermal insulation performance of building envelope via using high thermal resistance material. The heat transfer coefficient is 0.262 for roof and 0.270 & 0.386 for walls.

Roof K ₁ =0.262					
Structure Layers	Thickness (mm)	Unit Weight (kg·m ⁻³)	Thermal Conductivity λ (W·M ⁻¹ ·K ⁻¹)	Thermal Resistance R (m ² ·K·W ⁻¹)	Heat Transfer Coefficient K (W·m ⁻² ·K ⁻¹)
MR-24®Metal Roof Panel	-	-	-	-	$R_1 = R_i + \sum R + R_e$ $= 0.11 + 3.66 + 0.04 = 3.81$ $K_1 = 1/R_1 = 0.262$
Thermal Insulation Layer	150	12	0.041	3.66	
Air	-	-	-	Inner Surface R _i =0.11 Outer Surface R _e =0.04	

Table 1: Heat transfer coefficient (workshop roof)

Wall 1(Height: 2.1m) $K_2=0.270$					
Structure Layers	Thickness (mm)	Unit Weight ($\text{kg}\cdot\text{m}^{-3}$)	Thermal Conductivity λ ($\text{W}\cdot\text{M}^{-1}\cdot\text{K}^{-1}$)	Thermal Resistance R ($\text{m}^2\cdot\text{K}\cdot\text{W}^{-1}$)	Heat Transfer Coefficient K ($\text{W}\cdot\text{m}^{-2}\cdot\text{K}^{-1}$)
Aerated Concrete Steam Pressure Plate	50	-	0.190	0.21 (correction factor:1.2)	$R_2=R_i+\sum R+R_e$ $=0.11+2.44+0.21+0.91+0.04=3.71$ $K_2=1/R_2=0.270$
Flyash Brick Wall	200	-	0.176	0.91 (correction factor:1.2)	
Thermal Insulation Layer	100	12	0.041	2.44	
Air	-	-	-	Inner Surface R_i =0.11 Outer Surface R_e =0.04	

Table 2: Heat transfer coefficient (masonry walls)

Wall 2(Metal Wall) $K_3=0.386$					
Structure Layers	Thickness (mm)	Unit Weight (kg/m^3)	Thermal Conductivity λ ($\text{W}\cdot\text{M}^{-1}\cdot\text{K}^{-1}$)	Thermal Resistance R ($\text{m}^2\cdot\text{K}\cdot\text{W}^{-1}$)	Heat Transfer Coefficient K ($\text{W}\cdot\text{m}^{-2}\cdot\text{K}^{-1}$)
Metal Wall Panel	-	-	-	-	$R_3=R_i+\sum R+R_e$ $=0.11+2.44+0.04=2.59$ $K_3=1/R_3=0.386$
Thermal Insulation Layer	100	12	0.041	R =2.44	
Air	-	-	-	Inner Surface R_i =0.11 Outer Surface R_e =0.04	

Table 3: Heat transfer coefficient (metal walls)

4.1.3 Natural ventilation

Harmful factors in workshops include particulate matter, heat, waste gas, etc. 3 kinds of natural ventilation systems are performed in workshops, which work together as a circle to improve indoor environmental quality.

Indoor carbon dioxide, industrial emissions and other harmful gases exchange with fresh air through unpowered roof ventilators.

The ventilation tower has better ventilation capacity than natural unpowered roof ventilator. Two roof ventilation towers with 201m and 75m long are installed for each workshop. As for heavy pollution area, painting room and the steel plate flame cutting area for instance, down slope ventilation towers are added to enhance ventilation.

The rain louvers with manual rotary switch are located in the lower part surrounding the plant building, which can be closed in winter.

4.1.4 Results of indoor temperature control

To confirm the actual effect on indoor temperature control by using high-performance building envelope, efficient operation management policy and green building design, 5 thermometers distributed in 2 workshops and outdoor (Figure 2).

Data from 5 thermometers (Testo 608, $\pm 0.5^\circ\text{C}$) are collected 3 times a day at 11:00, 14:00 and 16:00. As Figure 3 and Figure 4 show, both in winter and summer, indoor temperature are lower than design values. The temperature difference between indoor and outdoor increases with the rise of outdoor temperature, which further

indicates the effect of indoor temperature control in large space workshops by using high-performance building envelop, effective heating system in winter and efficient operation management policy.



Figure 2: Thermometers distribution map

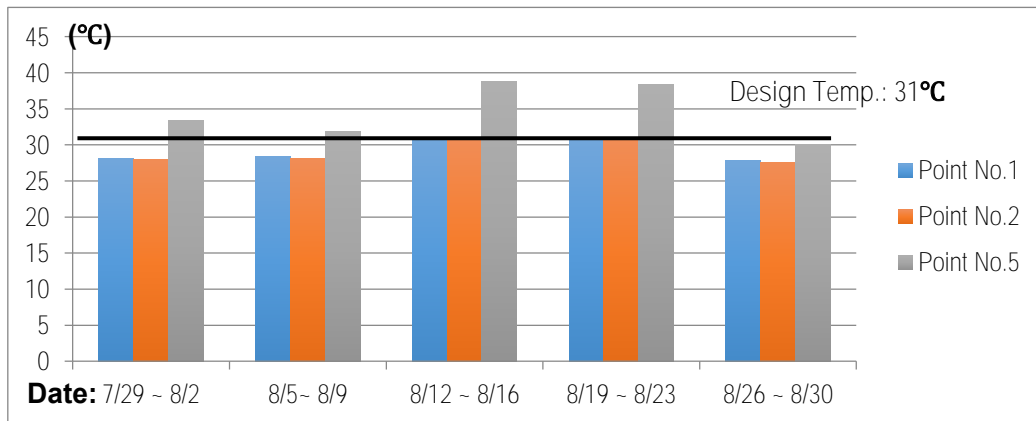

Figure 3: Temperature statistics in summer

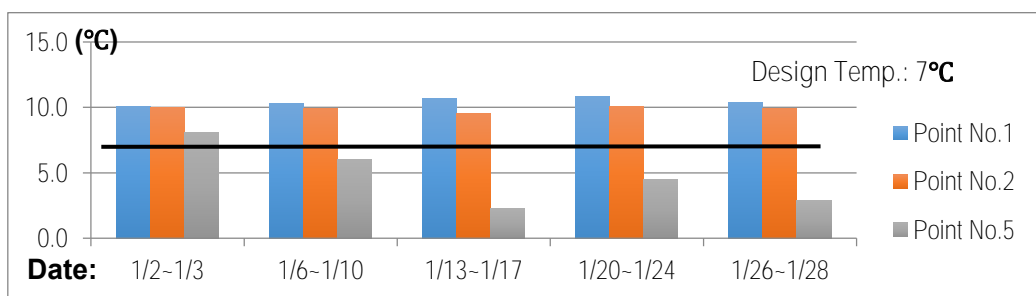

Figure 4: Temperature statistics in winter

4.2 Indoor emission

The concentration of harmful substances which generated by blasting dust, welding fumes, painting organic wastes is emitted up to standard after treatment. Workers entering the area must wear personal protective equipments.

4.2.1 Welding fumes control

Welding fumes collectors are installed to match welding stations. Collectors start automatically with welding guns. Collectors can move flexibly with their mechanical arms during welding. Meanwhile, training welder for efficient work to reduce the usage amount of welding rod.



Figure 5: Welding fume collector

4.2.2 Shot-blasting dust control

The dust-handling system in shot-blasting cleaning unit is applied with "whirlwind + pulse opposite-blowing flat bag" level-2 dust removal method. The filtration efficiency of filtration reaches to 99%. The treated effect complies with particulate level 2 emission of China National Standard.

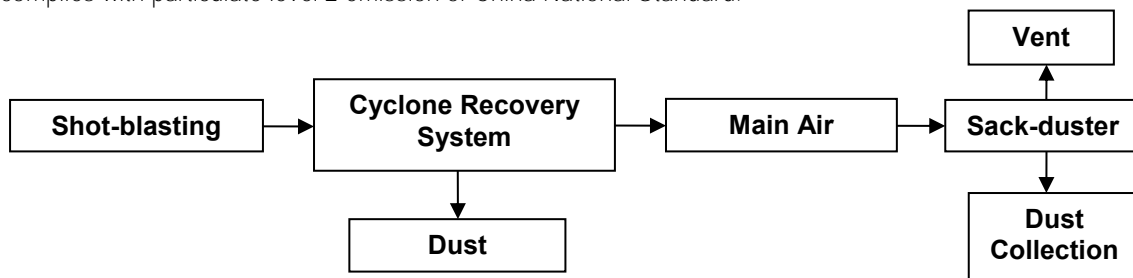

Figure 6: Shot-blasting dust control flow chart

4.2.3 Painting organic wastes control

The mist spray and organic wastes that generated from the painting room is collected with vacuum suction, and go through three layers of filtration which are labyrinth filter, glass fiber filter and double activated carbon fiber filter. The efficiency of paint mist filtration is 99%, and the rate of organic waste adsorption is 95%.

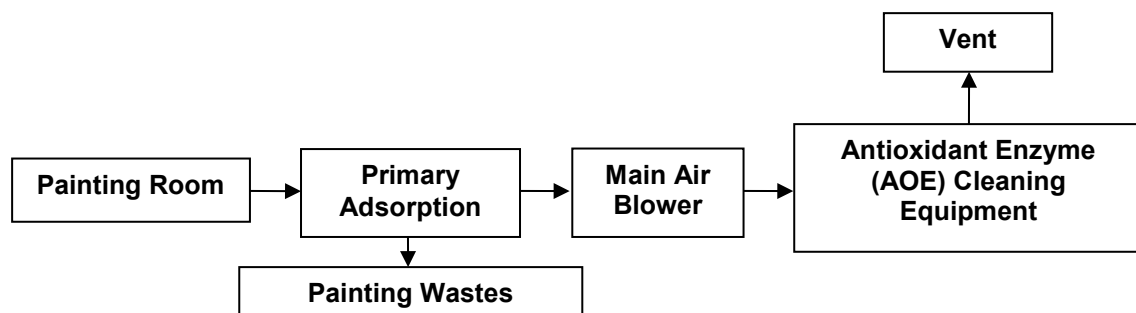

Figure 7: Painting wastes collection flow chart

Indoor emissions are reduced effectively. Testing report on manganese and its inorganic compound, indoor particulate matter, benzene and its inorganic compound shows that indoor emissions in workshops are much lower than national standards requirement.

4.3 Indoor noise

Indoor noise in the project comes from production equipments, welding and ventilation equipments. Required noise level is 85dB according to national standards.

Separating high-noise equipments and building shockproof ditch on equipment foundations are effective to lower noise from production equipments; Non-electric ventilations are placed on workshops instead of electric fans to lower noise from engine; Setting manual welding reverse machines to lower noise from welding process.

Furthermore, perforated acoustic panels are installed on the ceiling of workshops to reduce noise diffusion and indoor noise. Wearing earplug is necessary for people inside workshops.

No.	Test Point	Indoor Noise Record[dB(A)]					AVG.[dB(A)]	
1	Outdoor	South Gate	45.18	46.68	41.2	42.66	41.62	43.468
2		West Gate	47.26	45	53.6	74.4	70.2	58.092
3	Cladding Workshop	Rack and Pallet Area Gate	68.36	65.62	69.9	82.68	81.56	73.624
4		Downspout Line	80.48	73.92	69.98	71.06	68.62	72.812
5		Pressing Machine	85.56	83.58	62.24	64.46	62.18	71.604
6		10m Bending Machine	73.66	74.5	62.84	63.38	62.9	67.456
7	Frame Workshop	Welding Station	101.2	81.06	91.04	93.56	84.12	90.196
8		Drilling and Cutting	83.46	78.94	71.66	71.96	75.3	76.264
9		Press-brake Shear	84.1	70.16	67.74	66.04	67.78	71.164

Table 4: Indoor noise record

5. ECONOMIC ANALYSIS

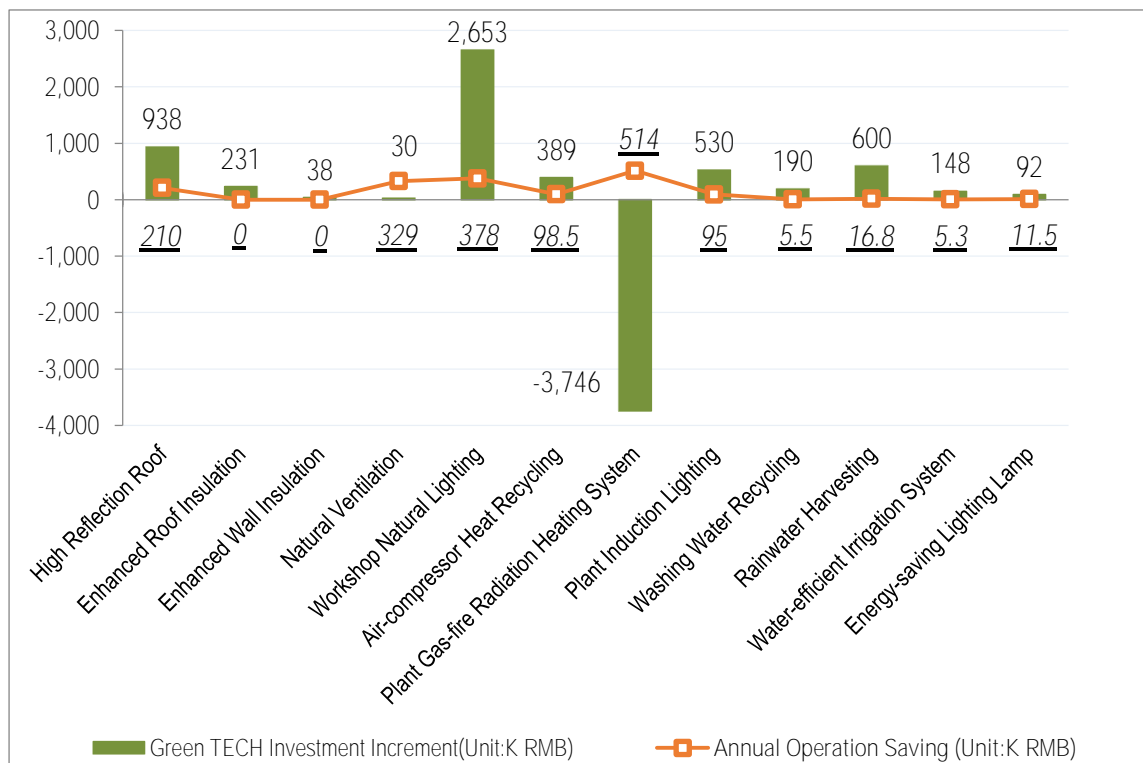

Figure 8: Investment increment and recovery period

Over twenty kinds of green technologies are presented in the project with a RMB 11,874 K increment of green investment. Figure 8 shows green investment increment of main green tech. and their annual saving ability during operation phase. Skylight panels on the top of workshops for natural lighting cost RMB 2,653 K. Compare with electric lighting, annual saving on indoor lighting is RMB 329 K. Gas-fire radiation heating system saves RMB 3,746 K due to the saving on municipal heating system investment. Compare with municipal heating fee, annual saving during operation is RMB 514 K.

Annual saving on operation phase is RMB 3,531 K in this project. The payback period is 3.4 a. Annual water saving amount is 7,360 T; electricity saving is 1,562,815 KW.H; natural gas saving is 76,072 m³; ground saving is 0.3 hm².

6. DISCUSSION AND CONCLUSION

Indoor environment requirements of the industrial project are discussed in this paper with indoor temperature, indoor particulate matter and indoor noise. After years of operation, the collected data indicates that the gas radiation heating system, high-performance heat insulation envelope structure of workshop buildings and reasonable ventilation system ensure the comfortable temperature in winter and summer. The dust collectors and exhaust recovery equipments ensure the efficient control effect of indoor pollution. **Noise-reducing by manufacture process, acoustic panels and personal protective equipments ensure people's health from noise harm.**

From the above economic analysis on investment increment and payback period of green technologies, it can be observed that the investment on green technologies can be recovered shortly by appropriate green building strategy.

REFERENCES

- [1] Yanhong Y and Weiwei L, 2013. Energy Efficiency of Tianjin Library Under Architectural Design Perspective. *Building Energy Efficiency*, 41(11), 50-56.
- [2] Zhaohui Z and Jueshi Q, 2007. Analysis of Fly Ash Thermal Property and Its Application. *Coal Ash China*, 28(6), 38-40.
- [3] **People's Republic of China National Standard**, 2015. Code for Design of Heating, Ventilation and Air Conditioning. China Planning Press, Beijing.
- [4] **People's Republic of China National Standard**, 2010. Hygienic Standards for the Design of Industrial Enterprises. People's Medical Publishing House, Beijing.
- [5] **People's Republic of China National Standard**, 2007. Occupational Exposure Limits for Hazardous Agents in the Workplace. China Standard Publishing House, Beijing.

Research on the Strategies and Methods in Productive Green Renovation of Existing Urban Communities

ZHANG Yukun^a, DING Xiaoying^b

^a Tianjin University, Mainland China, zyk.tj@163.com

^b Tianjin University, Mainland China, 568334000@qq.com

ABSTRACT

At present, environmental pollution, resources and energy depletion, fast urban development and blind sprawl in China have forced the transformation of urban construction from physical expansion to built-up area improvement. Thus, it is imperative to renovate the existing urban communities with green strategies. This paper firstly presents a review of the current green renovation of existing communities and points out the existing problems of these strategies: emphasizing on the application of single technique and lacking adequate consideration of the community integrity, focusing on material conditions improvement and lacking research and concern about social humanity, etc. To address these problems, the concept of productive city, with the purpose of promoting agriculture production, energy production, and social & cultural capital preservation and redevelopment in a proactive way, is pointed out in the paper. Then, the paper presents the integration strategies of productive green function which can be employed in different community spaces, including reserving the existing productive space, replacing the ornamental landscaping, fulfilling the unused space, overlaying the single function space, and restructuring the community space system (physical, social and cultural space system). According to different productive functions, we carries out case studies for different types of community productive green renovation. Finally, through the comparison with the current green renovation, the advantages of productive green renovation of existing community on economy, society, culture and ecology are discussed, aiming at providing reference for the inventory planning and community renovation in China.

Keywords: sustainable neighbourhood, green renovation, productive city

1. INTRODUCTION

According to the International Energy Agency, the proportion of building energy account for 32% of the world's energy consumption. Community, a basic unit of city, plays an important part in reducing the total building operational energy consumption. Therefore, it is imperative to renovate the existing communities with green strategies.

Generally, green renovation of existing communities mainly focuses on how to reduce energy consumption and carbon emissions in different aspects of existing communities. However, this paper aims to explore a community renovation paradigm, whereby work is carried out with the goal of not only reducing energy consumption but also promoting agriculture production, energy production, and social & cultural capital preservation and redevelopment in a proactive way. This paper will, firstly, review the current existing communities renovation research and practice (Section 2). Then it will indicate why the productive green renovation mode is the best choice for the context of existing communities renovation (Section 3). Afterwards the integration strategies of different productive green functions are presented (Section 4), followed by an elaboration of various kinds of renovation types by case studies (Section 5). Finally, the advantages of productive green renovation are discussed (Section 6).

2. LITERATURE REVIEW OF GREEN RENOVATION RESEARCH OF EXISTING COMMUNITIES

The research on green renovation of communities mainly focuses on three topics: appropriate technologies options; case studies; policy and participation mechanism analysis. There are relatively more research on the technologies options. Qiu Baoxing pointed out the necessary and extended green renovation items (Qiu B., 2016). Wang X et al. studied the technologies and indicator systems for the construction of green-community (Wang X et al., 2016). While Hoicka C E et al. analyzed the amount of energy and greenhouse gas emissions saved of different renovation strategies (Hoicka C E et al., 2011). We summarize current community green renovation strategies into five aspects via literature and practices: basic functions improvement, environment improvement, renewable energy utilization, resources recycling utilization, and intelligent service system application. However, as Table 1 indicates, different

strategies have different emphases but few researchers, architects or planners have considered the relations of different strategies or integrated them together.

Category	Technology	Advantage
Basic functions improvement	Energy efficient retrofit for buildings (e.g., Increasing insulation in the ceiling and walls) Installing barrier-free facilities Building stereoscopic garage Installing energy saving devices	<ul style="list-style-type: none"> ● Meeting the basic living demand ● Reducing energy consumption ● Reasonable layout of buildings, transportation and facilities
Environment improvement	Land and lakes management Plants selection and planting Ecological infrastructure planning	<ul style="list-style-type: none"> ● Minimizing the use of chemicals and irrigation systems ● Increasing the green proportion ● Improving micro-climate
Renewable energy utilization	Solar power Wind turbines Geothermal heating and cooling Bio-energy	<ul style="list-style-type: none"> ● Making the full use of renewable energy ● Minimizing the external supplies
Resources recycling utilization	Rainwater collection Grey water recycle and reuse Materials reuse Waste sorting and disposal	<ul style="list-style-type: none"> ● Minimizing the environmental impact ● Promoting the circular economy ● Raising the reuse rate of materials
Intelligent service system application	Green transportation Dynamic supervision database Intelligent medical services or logistics systems	<ul style="list-style-type: none"> ● Creating comfortable life ● Improving the transportation efficiency

Table 1: Technology and advantage of different green renovation strategies

For the case studies, much of the research falls on the distinct renovation examples in specific context. For example, Han Qingmiao takes GWL-Terrein community in the Netherlands as example and analyzes the transformation background, implementation process and transformation effect in the original industrial land (Han Q., 2014).

As for the policy and participation mechanism analysis, the important role of civic engagement plays on the green renovation of communities has been highlighted (e.g., Vivek Shandas et al., 2008, Boland A and Zhu J., 2012). In recent literature the cooperatives and cooperative networks regarded as an efficient organizational form is proposed for involving citizens in the process of community green renovation (Purtik H et al., 2016). However, there is a lack of research and concern on social side of community renovation. Very little is known about how to undertake renovation (Fawcett T and Mayne R., 2012), how to manage the post-renovation community, and how to establish a social relationship in the process of renovation.

3. CONCEPT OF PRODUCTIVE CITY

Our productive city research team explored the concept of productive city based on the research of urban agriculture. Productive city is defined as a multi-level urban system with the green production as its main character, which also integrated with the functions of agriculture production, energy production and social & cultural capital preservation and redevelopment. With the purpose of promoting green production in a proactive way, the strategies of productive city includes not only reducing energy consumption but also increasing energy production within the minimum scope of each level. It aims at achieving the goal of self-sufficiency and sustainable development of each city as much as possible. Therefore, productive city is a system with many properties like production, ecology, hierarchy and integrity.

Productive green renovation of existing communities aims at reducing energy consumption, improving the community environment and achieving the goal of self-sufficient. Based on the existing community buildings, roads and landscapes, the community spaces which used for agriculture production, solar and wind energy production

are reconstructed or constructed. This kind of renovation mode changes the original community renovation paradigm that only focuses on the application of green technology. It integrates the living, production and ecology together, thus enabling a more productive, ecological and vibrant community to be built.

4. PRODUCTIVE GREEN RENOVATION STRATEGIES OF EXISTING COMMUNITIES

4.1 Reserving the existing productive space

Although the production function is not considered before community construction, there are still some productive planting activities in existing communities, such as community gardens, balcony agriculture and back gardens (Figure 1). During the renovation, the existing productive spaces are reserved and some of the public agriculture spaces are open to residents. Besides, residents from different clusters are encouraged to participate in repairation activities of agriculture facilities and adopt vegetables program. The public void spaces are transformed into important markets for community to exchange their vegetables. This reservation strategy respects **residents'** original life-styles and protects the economic interests of private garden owners. Meanwhile, the relationship between neighbors could be promoted. In general, the social humanistic value brought by this strategy may be much higher than production value.

4.2 Replacing the ornamental landscaping

Artificial lawn and ornamental garden-based community landscape is easy to produce pesticide pollution, burdening the community with a high maintenance cost. Productive community renovation changes this paradigm and replaces the original landscape with productive plantings. By this way, the community gains both the ecological and productive benefits. Some public space transformation adopts this strategy. For example, in order to change the mega-block into farmland, the spaces between buildings are expanded firstly. And then water systems and agriculture facilities are built. At last, different farming plantings are introduced in this area (Figure 2). The new view "productive landscape" replaces original decorate landscape and brings safe and abundant food for residents, which also increases species diversity.

4.3 Fulfilling the unused space

Plenty of unused spaces of existing communities are reasonably fulfilled by production function. For example, building roofs, which have little influence on residents, are reconstructed in parallel to community infrastructure transformation (such as elevator installation or rainwater pipe transformation), thus providing a convenient way for residents to reach the roof garden (Figure 3). The newly built roof garden also reduces the demand of food supply. According to the data of Wuhan Shilipu roof garden, the output from more than 37 kinds of vegetable species planted here satisfies the community dwellers' daily vegetable need and extra vegetables are sold (Dai X.G., 2011). There are various kinds of roof planting modes. Compared with planting boxes, the PV-based agricultural greenhouses which emerged in recent time has higher agriculture production, which brings additional energy benefit.

4.4 Overlaying the single function space

The community roads and outdoor parking lots have low space utilization because they are generally directly exposed to the sun. To compensate the occupation of land, community transport spaces are overlaid by agricultural production function, energy production function or a mixture of both. Agricultural production function-based traffic space transformation provides a way for people to use the upper space of roads and parking lots for installing devices to grow calabash, pumpkin or grapes. The newly created agriculture productive space serves as a communication space for residents where they can relax in the shade or pick fruits (Figure 4). While energy production function-based traffic space transformation means the upper space of roads and parking lots are used for installing devices to capture solar or wind energy. On one hand, it produces electricity. On the other, it reduces the automobile air conditioning energy consumption (Figure 5). As a distributed power system, the upper solar energy collection system of traffic space is connected with community charging piles or lighting system, which provides a more convenient living experiences for residents.

4.5 Restructuring the community space system (physical, social & cultural space system)

Community productive spacial system reconstruction includes two aspects, one is physical space reconstruction, the other is social & cultural space reconstruction. The former means that more space can be reused for raising the production rate (Figure 6). For example, the space between gables can be designed as a living and productive complex. The north side of this space can be used for living, while the south side can serve as greenhouse. Greenhouse provides vegetables for residents. In turn, the gray water and organic waste are recycled as fuel source for greenhouse, which creates a micro circulation system.

The goal of community productive renovation is not only to make the community self-sufficient on physical aspect, but to enhance community cohesion by the reconstruction of social humanistic space system. For example, the productive spaces mentioned above should be used for organizing community agriculture. Residents from different social groups are encouraged to communicate and cooperate with each other in these activities, so that the void spaces can be changed to social communication space and the stability of the community can be maintained.



Figure 1: Reserving the existing productive space



Figure 2: Replacing the ornamental landscaping



Figure 3: Fulfilling the unused roof space



Figure 4: Agricultural production-based traffic space transformation



Figure 5: Energy production-based traffic space transformation



Figure 6: Restructuring the community productive space system

5. CASE STUDY - DIFFERENT PRODUCTIVE GREEN RENOVATION TYPES OF EXISTING COMMUNITIES

According to different productive functions, the productive green renovation types of communities are classified into agriculture-based productive green renovation, energy-based productive green renovation and multi-productive functions-based green renovation.

5.1 Case study of agriculture-based productive green renovation

Agriculture-based productive green renovation seeks to explore an integration mode between agriculture function and living function. It fundamentally changes the way residents live, which allows people to grow, raise and produce their own food as close to their home as possible. The common agriculture pattern includes permanent farming, roof farming, greenhouse farming, and vertical farming. To add more agriculture output, the LED farming, helping grow more food in controlled environment, is introduced. Related agriculture programs, such as commul kitchen, agriculture skills classrooms and local food shops, are located within community.

In 2008, Atelier d'architecture autogérée (aaa) initiated a program called R-urban, which is a bottom-up framework aiming to help the city residents to transform their neighborhoods to face the challenges of the future. Agrocité, based in the city of Colombes, France, is one of the first pilot production units of this program. The area of this unit is 3,000 square meters. It consists of an experimental micro-farm, community gardens, educational and a range of experimental devices, such as, compost-powered heating, rainwater collection, solar energy generation, aquaponic gardening and phyto-remediation. A mix of public recreation spaces (e.g. the cooperative store and

cafe) and other cultural and educational spaces underpin a holistic community. By participating in these activities, residents acquired professional skills and the cooperation abilities as well as the ecological awareness are improved (Figure 7).



Figure 7: Renovation comparison of Agrocité

5.2 Case study of energy-based productive green renovation

Energy-based productive green renovation aims to make the most of community energy potential, which refers to the ability of a community to develop solar, wind and bioenergy for electricity, heat and fuel without causing damage to ecosystems. The energy system involves energy production, energy storage and energy management. Taking solar energy as an example, by applying photovoltaic solar panels, transparent solar panels and thermal solar panels on the buildings, roads and parking spaces, the community can change the solar energy into electricity and heat. The electricity is stored in Li-ion battery or Thermal Bank. Moreover, residents can share electricity through the use of energy internet.

The good case for the energy-based productive green renovation type is the renovation of Tassafaronga Village. In 2005, the Oakland Housing Authority made a new plan for this decrepit brownfield site, aiming at providing high-density, accessible, energy-efficient units for low residents. To make up for the electricity consumption, this village applied a 180kw photovoltaic system. Each building is equipped with a central, condensing gas water heater connected with rooftop solar collectors, which covers 60% of demand. The solar water heating devices are applied on the townhouse buildings and individually-controlled radiators are installed in each room (Figure 8).



Figure 8: Renovation comparison of Tassafaronga Village

5.3 Case study of multi-productive functions green renovation

Multi-productive functions-based green renovation represents a new paradigm of self-sufficient community, which reconfigures the relationship between living and multi-resources production. The objectives to be achieved covers local food, 100% renewable energy, zero waste, intelligent transportation, sharing economy & culture etc. All the productive systems are tied with each other. For example, The rainwater collected by water system are used for vegetables irrigation of food system, while the organic waste of food system are used for producing electricity of energy system.

The good case showing the way the multi-productive functions-based green renovation is the second nature: Country Garden Eco-reconstruction of Terrace Forest City, which achieved the first prize of student group for the Country Garden Forest City Landmark Architecture International Design Competition. The aim of this design is to create a completely self-sufficient living space without polluting and depending on outside environment. Inspired by the traditional courtyard houses, cave dwellings and terraced fields of China, it features the continuous terraced appearance with various communal and individual gardens. The different scales of farms distributing in the neighborhood are suitable for growing vegetables and fruits, such as, the backyard farms, the front yard farms and

the communal farms located in the center, which also serve as public space for residents to communicate. Meanwhile, a range of solar panels arraying in the edge of the terraces are used for energy production. The cultivation and management of the production programs provides more employment opportunities for residents. The community kitchen, market and classrooms are situated inside the terraces, where residents can share skills and food (Figure 9).



Figure 9: The second nature: Country Garden Eco-reconstruction of Terrace Forest City

6. CONCLUSIONS

Compared with current community green renovation, there are lots of advantages of community productive green renovation: Firstly, this kind of renovation fundamentally changes the one-way energy flow pattern, giving community the capacities of self-renewal, self-regulation and self-recycle. Secondly, the line of food producing, food gathering and food trading is closely combined with residents' life, which reduces the cost of food transportation and provides more job opportunities for residents. In addition, the relationship of residents are enhanced by these productive activities, which is of great significance to the future development of community.

Although the practice of productive green renovation is still at the exploratory stage, the research of it has a significant advantage in response to problems like food or energy shortage. Hence, the strategy that agriculture, renewable energy and other production factors are actively integrated into residents' living will be widely applied in the urban future development.

REFERENCES

- [1] Boland A, Zhu J., 2012. Public participation in China's green communities: Mobilizing memories and structuring incentives [J]. *Geoforum*, 43(1):147-157.
- [2] Fawcett T, Mayne R., 2012. Exploring an 'over time' model of eco-renovation [J]. *Retrofit*.
- [3] Han Qingmiao., 2014. Experience Study on Community Sustainable Renewal in the Netherlands. *Building Science*, 30(10):110-114.
- [4] Hoicka C E, Parker P., 2011. Residential energy efficiency programs, retrofit choices and greenhouse gas emissions savings: a decade of energy efficiency improvements in Waterloo Region, Canada [J]. *International Journal of Energy Research*, 35(35):1312-1324.
- [5] Nels Nelson. 2009. Planning the productive city. Delft Technical University.1-25.
- [6] Purtik H, Zimmerling E, Welpel I M., 2016. Cooperatives as catalysts for sustainable neighborhoods – a qualitative analysis of the participatory development process toward a 2000-Watt Society [J]. *Journal of Cleaner Production*, 134:112-123.
- [7] Qiu, B.X., 2016. Green Renovation of Old Communities-add a new approach to effective investment in China. *Construction Science and Technology*. 4(9).10-17.
- [8] Rifkin J., 2011. The third industrial revolution. Palgrave Macmillan, London.
- [9] Sun Y.B. 2013. Urban Agriculture and Its Potential in Urban Development. Thesis (PhD). Tianjin University.
- [10] Vivek Shandas, W. Barry Messer., 2008. Fostering Green Communities through Civic Engagement: Community-Based Environmental Stewardship in the Portland Area [J]. *Journal of the American Planning Association*, 74(4):408-418.
- [11] Vicente Guallart. 2014. Self-sufficient City. CITIC Press, Beijing.
- [12] Viljoen A. and Bohn K. (eds), 2005. CPULs Continuous Productive Urban Landscapes: Designing Urban Agriculture for Sustainable Cities. Architectural Press, Oxford.
- [13] Wang X, Zhao G, He C, et al., 2016. Low-carbon neighborhood planning technology and indicator system [J]. *Renewable & Sustainable Energy Reviews*, 57:1066-1076.

Session 5.12: **Occupants' Evaluation of Green Buildings**

Users' Perceptions of Building Performance – An Analysis of the Occupants' Comments

George BAIRD^a, Sara WAREING^b

^a Victoria University of Wellington, New Zealand, george.baird@vuw.ac.nz

^b McKee Fehl Constructors, New Zealand, sara.wareing@hotmail.com

ABSTRACT

55 commercial and institutional buildings have been surveyed by the authors and their collaborators using the Building Use Studies Methodology. Around 4,000 occupants scored over 45 factors related to their perceptions of the performance of these buildings and were invited to comment on ten of these – considered to be key factors. **The aim of this paper is to explore the nature of the occupants' comments on these** ten key factors: design; needs; meeting rooms; desk space; storage; comfort; noise; lighting; health; and productivity. Each comment was categorised as positive, balanced, or negative for analysis. Overall and as might have been anticipated, the higher the proportion of positive comments about any particular factor, the better it scored. Comparisons were undertaken of the nature of the comments between sustainable and conventional buildings, between New Zealand and overseas buildings, between commercial and institutional buildings, and between sustainable and conventional commercial buildings, all of which exhibited notable differences.

Keywords: commercial buildings, academic buildings, occupants comments, occupants perceptions

1. INTRODUCTION

Despite well-documented estimates of the large costs of employees compared to the rent and the energy costs of the buildings they occupy – ratios of 100:10:1 are often quoted (see Yudelsen, 2008, p151 for example) – and the potential benefits from relatively small increases in their productivity as a result of an improved working environment, asking for comments is still a relatively rare occurrence. While questionnaires have been developed for this over the years (see Oseland, 2007 for a review of some of these) to the **best of the authors' knowledge only two** organisations, Building Use Studies (BUS) Ltd in the UK and the Center for the Built Environment at the University of California Berkeley have processes with which they have been carrying out surveys of building occupants over several decades.

Thanks to the generosity of Building Use Studies (2016) - the developer of the questionnaire used in the landmark PROBE Studies (Post-occupancy Review Of Buildings and their Engineering) (BRI, 2001/2) - a large number of researchers have since used the questionnaire in different parts of the world (Jahnkassim et al, 2004; Thomas and Baird, 2006; Turpin-Brooks and Viccars, 2006; Vandenberg and Thomas 2010; Lenoir et al, 2012; Bunn and Marjanovic-Halburd, 2016). The present authors have undertaken such surveys both worldwide and in their home country of New Zealand, and have carried out a range of analyses and comparisons as their dataset has grown. **These were mostly based on the building occupants' scores for the 45 factors on which they rank the building's attributes on a 7-point scale mainly.**

While these earlier analyses focussed on the occupants' scores, in this paper the focus is firmly on the nature of the occupants' comments on the ten aspects where they were invited to do so. Some preliminary studies had speculated on the potential for the use of these comments in the analysis and prediction of building performance (Baird and Dykes, 2012). This paper looks much more closely at the nature of the comments for each factor, examines their distribution in relation to the scores, and makes comparisons across a range of building types.

2. OCCUPANT SURVEY AND ANALYSIS METHODOLOGY

55 buildings (40 commercial; 15 institutional) were surveyed by the authors and their collaborators. The instrument used was the standard questionnaire developed by Building Use Studies (2016). These were distributed personally, thus ensuring an 80 to 100% response rate from the staff present in the building. The questionnaire asks the

occupants to score 45 key aspects of the building on a seven-point scale and invites comment on 10 of these, as follows: building design; needs (in the building as a whole); availability of meeting rooms; suitability of storage; space at desk; noise; lighting; overall comfort; health; and productivity at work.

While the preamble to the questionnaire makes it clear that respondents were not required to score every question, in practice most respondents scored most of the questions (91.6% on average). However, when it came to making comments on the 10 aspects the response rate was much lower at around 30% on average. In terms of the nature of the comments received on each aspect, for the purposes of this analysis they were placed into three categories: positive (extolling the virtues of the building; negative (noting problems attributable to the building); and balanced (where the respondent was neutral about the effect of the building on their work, or made a combination of positive and negative comments).

Checking the validity of the categorisation process for consistency between analysts was carried out by calculating the Cohen's Kappa coefficient to measure the level of agreement between analysts. An overall coefficient of 0.884 was achieved, indicating very good agreement ($\kappa > 0.8$) as defined by Landis and Koch (1977). Virtually all of the individual aspects achieved good agreement (κ of 0.6 to 0.8) ranging from 0.978 for health to 0.672 for noise – only meeting rooms at 0.520 slipped slightly below this threshold.

In addition to the commercial and institutional building grouping noted above, several other groupings lent themselves to analysis: 39 of the buildings had sustainability credentials while 16 were conventional; 33 were located in New Zealand while 22 were in a range of overseas countries; and of the 40 commercial buildings, 26 were sustainable and 14 conventional.

3. THE NUMBER AND NATURE OF OCCUPANT COMMENTS

Figure 1 indicates, for all ten factors on which comments were invited, the total numbers and relative proportions of positive, balanced and negative comments, as well as the numbers of occupants who made no comment but simply scored the relevant factor. The actual numbers of occupants who either made or did not make a comment on each of the ten factors are shown on Figure 1, plotted on a percentage scale for ease of comparison. There it can be seen that design attracted the highest proportion of comments (42%); comments on desk space were next highest at 35%. Of the questions related to internal environmental conditions it was of interest to see a descending ranking order from noise (32%) through lighting (26%) to comfort with half the comments of design (21%).

The numbers, proportions and natures of comments on each factor are also depicted on Figure 1. Overall, some 30% of occupants took the opportunity to make a comment; of these nearly 60% were negative while approximately 20% each were positive or balanced (58%, 20% and 22% respectively). Storage (or the lack of it) attracted by far the highest number of negative comments (787) and the least positive (79). Design attracted the most comments in total (1433) and the most positive comments (429) but had the third highest number of negative comments (702) as well. However, the ratio of negative to positive comments at 1.6:1 was lowest of the ten factors. At the other end of the scale, storage had the highest negative to positive ratio at 10:1 followed by noise at 5.7:1.

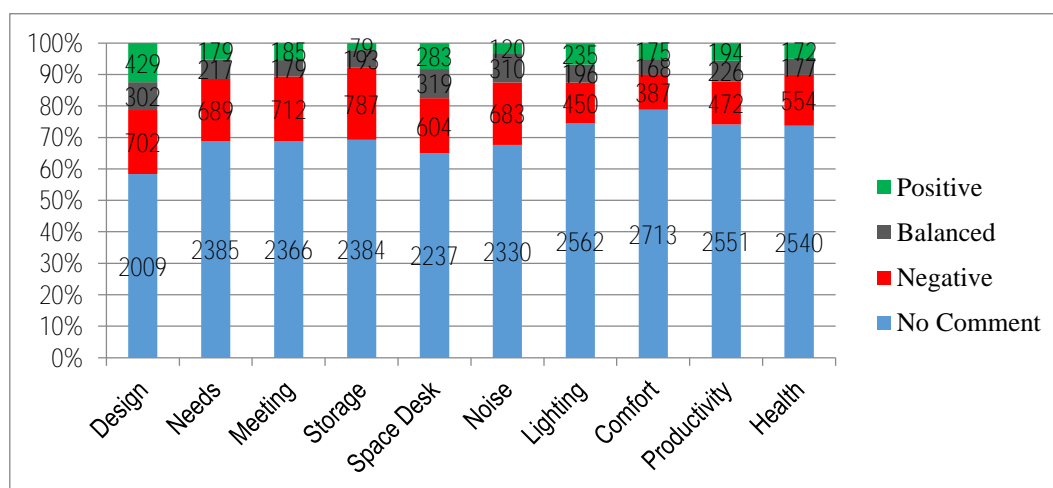
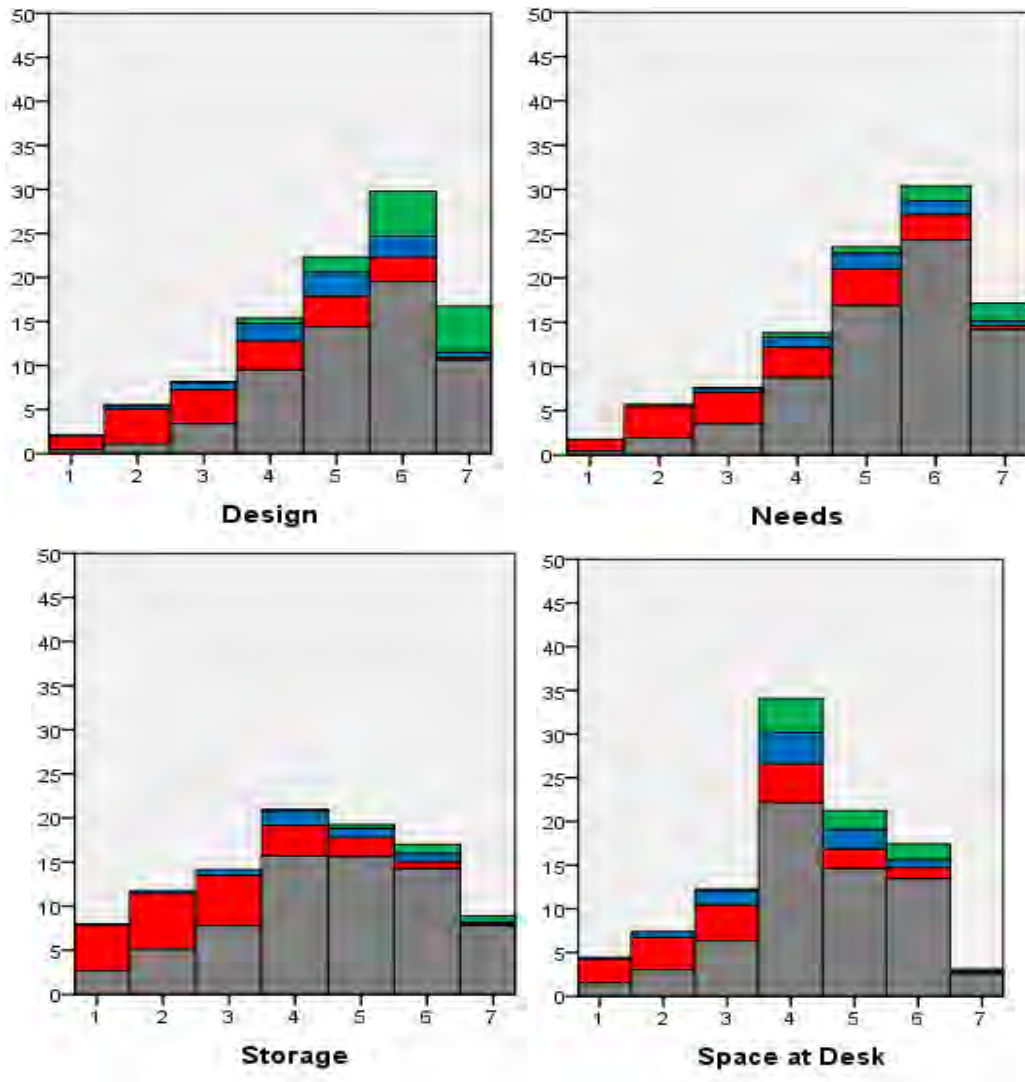

Figure 1: Numbers and percentages of comments on each factor

4. COMPARISON OF COMMENTS WITH SCORES

The histograms presented in Figure 2 indicate the percentages of positive, balanced, negative and no-comment responses corresponding to each division on the 7-point scale on which individual occupants rated each of the ten factors. Note that a score of 7 is best for all but two of the factors – in the case of desk space the mid-point of 4 is best; in the case of productivity a 9-point scale was used, with a score of 9 best.



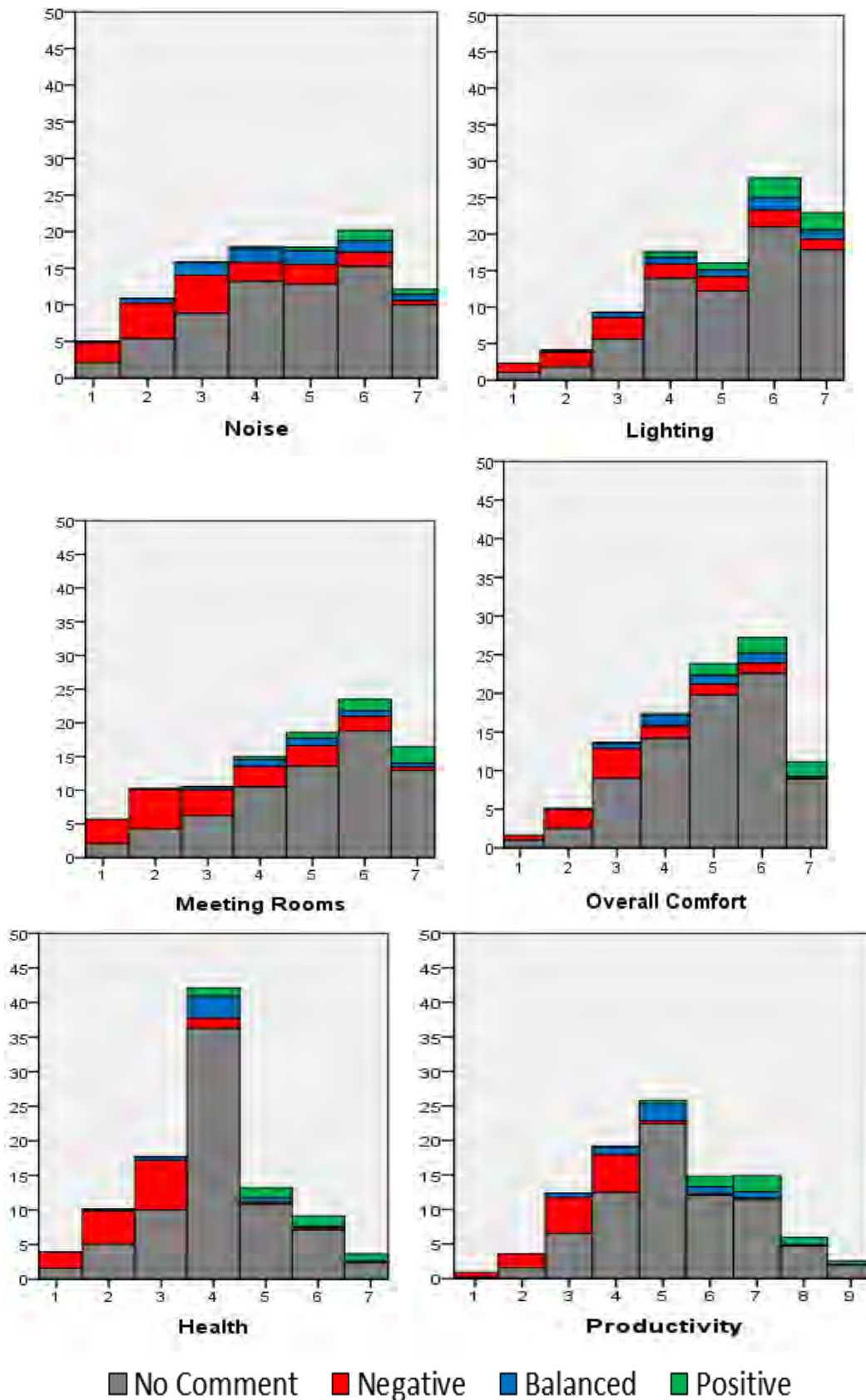

Figure 2: Plots of the nature of the comments vs. the corresponding scores

As might be expected, occupants who scored a factor well, tended also to make positive comments, and vice versa. However, assigning a high score to any given factor did not preclude individual occupants from simultaneously making a negative comment about it. In the case of design, needs, and comfort for example, where the average

scores tended to the better end of the scale, individual's scores of 5, 6 or even 7 were still getting some negative comments. However, simultaneous poor scores and positive comments were rare. Negative comments tended to be spread over the whole width of the scale though with more at the lower end.

5. COMPARISON BETWEEN OCCUPANTS OF DIFFERENT BUILDING TYPES

Given the mix of building types surveyed, the opportunity was taken to investigate if this had any influence on the nature or composition of the occupants' comments. The following pairs of comparisons were undertaken (total numbers of comments in brackets): Sustainable buildings (23,890) vs Conventional buildings (17,470): New Zealand buildings (27,300) vs Overseas buildings (14,060): Commercial buildings (35,260) vs Institutional buildings (6,100); and Sustainable Commercial buildings (20,210) vs Conventional Commercial buildings (15,050). Figure 3 displays the numbers, proportions (rounded to nearest whole number) and nature of the comments for each pair of comparisons.

In the case of the sustainable vs conventional buildings comparison the former attracted a higher proportion of positive comments (7.3% cf. 4.4%) and a lower proportion of negative comments (16% cf. 20%) than the latter. Both sets had virtually the same proportion of no-comment (69.6% cf. 69.4%) and balanced comments (6.8% cf. 6.3%).

The aim of comparing New Zealand building occupants with overseas was to see if any country biases could be detected in the nature of the comments. While the proportions of no-comment and balanced comments were very similar to each other, the overseas buildings produced a slightly higher proportion of positive comments (7.4% cf. 5.4%) and a slightly lower proportion of negative comments (16% cf.19%) than their New Zealand counterparts. However it should be noted that while the overseas buildings all had sustainability credentials, the New Zealand buildings were a mixture of conventional and sustainable.

While the number of institutional building occupants was considerably fewer than those for commercial buildings, a higher proportion of the institutional building occupants advanced comments of one kind or another – 35% cf. 30%. Arguably more notable than the actual percentages of negative and positive comments were the ratios of negative to positive - approximately 4:1 in the case of the institutional building occupants; less than 3:1 for their commercial building counterparts.

The final comparison undertaken was between sustainable commercial and conventional commercial building occupants. This was arguably the most statistically satisfactory in terms of the nature of the sample of buildings being compared. The overall percentages of comments made were similar (29% and 30% respectively) but the conventional commercial buildings attracted more negative comments than their sustainable counterparts (19% cf. 15%) and had a much higher ratio of negative to positive comments (over 4:1 cf. 2:1).

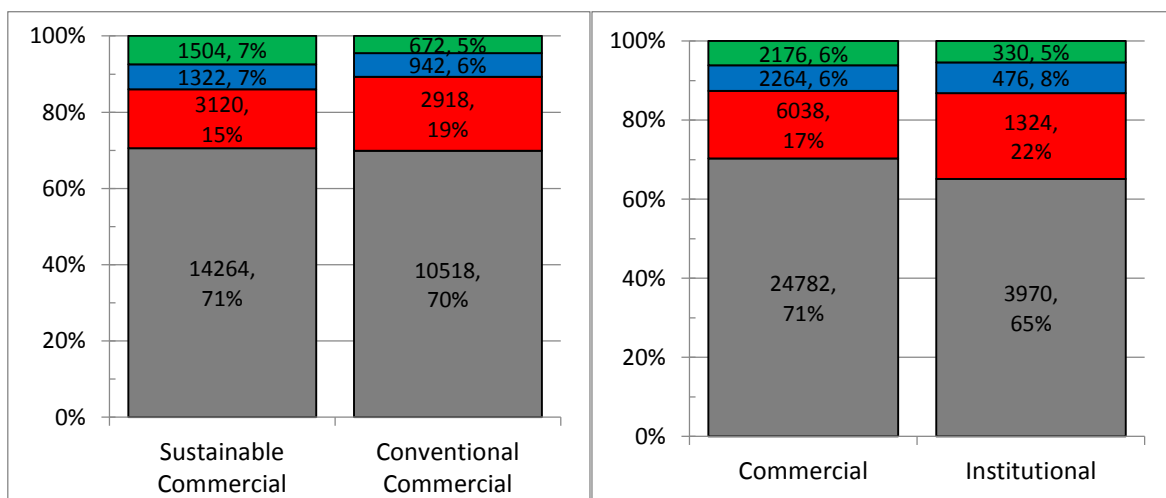

Figure 3: Comparisons based on the building type occupied

6. CONCLUSIONS

Overall, the rate of commenting was 30% of the rate of scoring of the ten key factors. Of these factors, the overall design of the building (42%) and desk/work area (35%) elicited the most comments – clearly matters of particular importance to the occupants; while overall comfort elicited the least (21%) – arguably an indication that the buildings were performing relatively well in terms of this factor.

The ratio of negative to positive comments worked out to be 3:1 overall. This is not seen as an indictment of the performance of these buildings but rather a characteristic of the nature of such questionnaires where respondents are being invited to make a comment in the context of a desire to make improvements. It could also be seen as a benchmark against which to assess the key factors. In this case, for example, the ratio for storage (suitability of storage arrangements to give the full question) was highest at 10:1, while design was lowest at 1.6:1 despite having most comments overall and the third highest number of negative comments. Clearly any benchmark would need to take into account both the ratio and the numbers involved.

While positive comments tended to correspond with high factor scores (and vice-versa) the comparison of individual scores against the nature of individual comments revealed that respondents were quite capable of rating any given factor highly while at the same time making a negative (arguably intended to be helpful) comment. This is particularly well illustrated in otherwise high scoring factors such as design, needs, comfort, and lighting, where negative comments are still evident at scores in the upper ranges. All of which indicates that building occupants can be very discerning in their evaluations – hardly surprising as working in a building they become the experts on its performance.

Comparison between the comments of the occupants of the different building types brought up some matters of interest too. Despite having virtually identical overall comment rates (close to the 30% average), the occupants of the sustainable buildings commented more positively and less negatively than those of the conventional buildings. Unsurprisingly, a similar but less pronounced effect was seen in the comparison of the comments about the overseas buildings (all of which were sustainable) with those of the New Zealand (which were an even mix of sustainable and conventional) – sounding an alert that care should be taken in sample selection.

Comparison of institutional with commercial buildings threw up the interesting findings that the occupants of the former not only made slightly more comments (by around 5%), their negative to positive ratio was higher (4:1 cf. 3:1). One could speculate on the reasons for this – are the occupants of institutional buildings more critical, or are institutional buildings less attuned to their users' needs? The largest differences were found between the sustainable commercial and the conventional commercial buildings, the former eliciting fewer negative and more positive comments and achieving a much lower negative to positive ratio (2:1 cf. 4:1) – a reassuring outcome for the proponents of sustainable buildings.

7. ACKNOWLEDGEMENTS

Special thanks to Adrian Leaman of Building Use Studies for his inspirational enthusiasm for building evaluation and his generous licensing arrangement of the BUS Methodology for researchers world-wide.

REFERENCES

- [1] Baird, G. and Dykes, C., 2012. "The potential for the use of the occupants' comments in the analysis and prediction of building performance". *Buildings*, 2012, 2(1), 33-42.
- [2] Building Use Studies, 2016. <http://www.usablebuildings.co.uk> (retrieved on 7 June 2016)
- [3] Bunn, R. and Marjanovic-Halburd, L., 2016. 'Occupant satisfaction signatures: longitudinal studies of changing comfort perceptions in two non-domestic buildings', paper presented at CIBSE Technical Symposium, Edinburgh.
- [4] Dixon, J., 2010. "General Purpose Building University of Newcastle". Chapter 25 in "Sustainable Buildings in Practice", G Baird, Routledge, Abingdon.
- [5] Jahnkassim, P.S., Ali, M., Abkr, Y. and Aripin, S., 2004. "Environmental performance Menara UMNO". Centre of Building Environment report EAG 101-103, International Islamic University, Kuala Lumpur.

- [6] Landis, J.R. and Koch, G., 1977. "The measurement of observer agreement for categorical data". *Biometrics*, 33: 159-174.
- [7] Lenoir, A., Baird, G. and Garde, F., 2012. "Post-occupancy evaluation and experimental feedback of a net zero-energy building in a tropical climate", *Architectural Science Review*, 55, 3, 156 - 168.
- [8] Oseland, N., 2007. *British Council for Offices Guide to Post-Occupancy Evaluation*. London: British Council for Offices.
- [9] Thomas, L. and Baird, G., 2006. "Post occupancy evaluation of passive evaporative downdraft cooling at Torrent Research Centre, Ahmedabad, India", Paper presented at the 40th ASA conference, University of Adelaide, pp97-104.
- [10] Turpin-Brooks, S. and Viccars, G., 2006. "The development of robust methods of post occupancy evaluation", *Facilities*, 24 (5/6): 177-196.
- [11] Vandenberg, M., and Thomas, L., 2010. "40 Albert Road, South Melbourne". Chapter 22 in "Sustainable Buildings in Practice", G Baird, Routledge, Abingdon.
- [12] Yudelsen, J., 2008. *The Green Building Revolution*. Island Press, Washington.

Cooperative Research for High Performance Buildings

Herbert Claus LEINDECKER^a, Armin WEBERBERGER^b

^a University of Applied Sciences Upper Austria, Austria, herbert.leindecker@fh-wels.at

^b University of Applied Sciences Upper Austria, Austria, in.weberberger@fh-wels.at

ABSTRACT

This paper represents two research projects with the aim **to define what “High Performance buildings” should be** and the steps to reach the highest goal, the user satisfaction and contentment with the building.

The quality optimization of buildings demands the consideration of the principles of life cycle assessment (LCA and LCC) and occupant satisfaction, particularly with the aim to create sustainable buildings and high comfort standards. However, these high expectations require expertise to an extent which cannot be covered by an institution or research unit by its own. This paper features the basic principles, the results and findings of two completed government funded research projects. These achievements emerged from a cooperation of several Austrian Universities of Applied Sciences.

The focus of the first research project LOG (life cycle improvement of the building quality) is on developing, analyzing and evaluating methods to assess planning decisions with their consequences on the life time of a building while normally, investment costs often serve as the only basis for decision making. Two main outputs of the project are firstly the creation of a comprehensive guideline on sustainable buildings (= Database of Quality) and secondly a common database of both economical and ecological building life cycle data.

The goal of the second research project MOFNUG (Modular questionnaire for the user satisfaction in buildings) is to determine the whole spectrum of user compliance in buildings by implementing different work packages, ranging from scientific research over purchasing of measurement tools to the improvement and optimization of the questionnaire, which is one of the main topics of the research group at the FH Wels.

The online accessibility of the project’s results and tools is important in terms of the usability in research and teaching.

Keywords: cooperative research, life cycle quality, user satisfaction

1. INTRODUCTION

The Topic “quality optimization of buildings” includes a steadily growing number of relevant aspects. Technological advances in product development and building simulation as well as changing relations of influencing life cycle factors often bring institutions and research projects to their limits so that cooperation is needed to cope with the complexity of these issues.

This paper is intended for introducing results and findings of two finished FFG (Austrian Research Promotion Agency) research projects, firstly the project LQG (life cycle improvement of the building quality) and secondly the project MOFNUG (modular questionnaire for user satisfaction in buildings). In the spirit of integration of knowledge and transforming cooperation into action, an association of several Universities of Applied Sciences has explored the complex questions of the topic just mentioned and achieved following results.

2. LQG: LIFE CYCLE ORIENTED QUALITY OPTIMIZATION OF BUILDINGS

Within the FFG research project which has been finished in 2013, five Austrian universities of applied sciences **compiled, among other issues, a “qualitative database” which is used as a collection of “tools” for building quality assurance**, helping to reach a degree of quality optimization that was hardly achievable before. In addition, a **“quantitative database” was created as a practical deliverable, leading to an “energy certificate plus” which is an energy certificate added with life cycle aspects.**

The life cycle cost development of sustainably optimized buildings, compared to standard buildings and the effect of decisions during the early planning phases on the cost development gradient is shown in Figure 1.

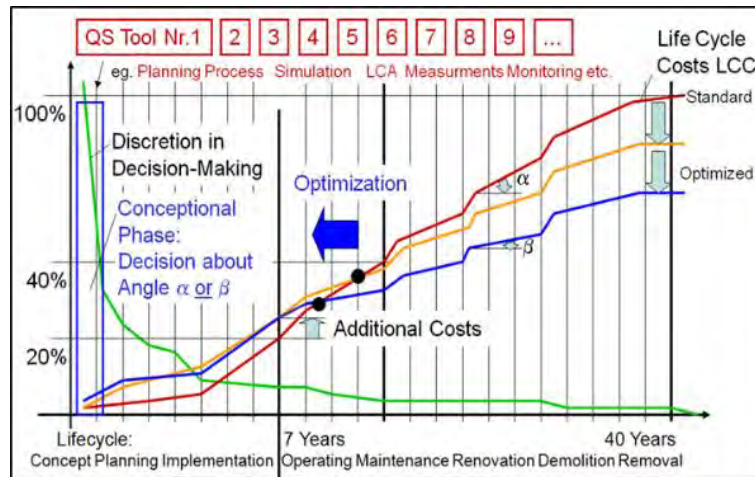

Figure 1: Diagram of LCC and the impact of decisions

2.1 Web based LOG database

This database follows the initial idea that a holistic improvement of the quality of buildings over the entire lifecycle can be achieved by adding a lot of quality assurance methods with one important aim in mind: the satisfaction and comfort of the user of a building. Building certification systems offer a possibility for a high level of quality performance. For this aspect some national and international certification systems – such as klimaaktiv, TQB, DGNB, BREEAM, LEED – have been considered and compared.

The qualitative database has been filled extensively and grouped into five life cycle stages: concept, planning, execution, use and deconstruction whereby these stages were further subdivided. Within the third level, filtration by information out of certain areas, for example project management, ecology, energy, etc. is possible. The fourth level is used to describe different complexes of themes, followed by the fifth level, where the results of the research project can be shown, for example quality assurance tools. Supplementary information like literature, hyperlinks and project-external documents, is provided within the sixth level. The optical appearance and the structure of the LOG-database are illustrated in Figure 2.

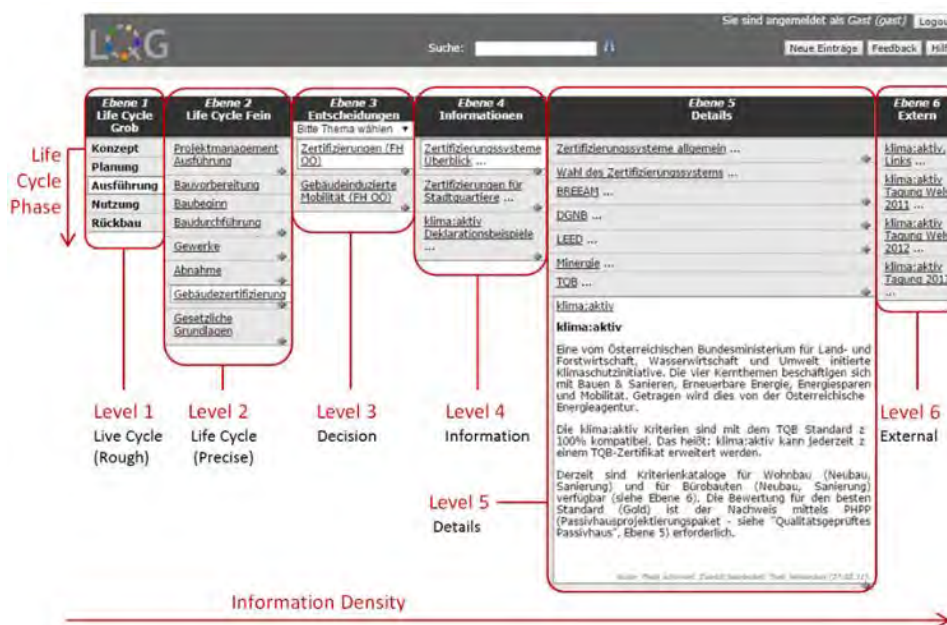

Figure 2: Appearance of the LOG database

2.2 Results of LQG

When complex issues of quality assurance arise, the project partners, as well as the interested persons (limited) can be supported by the online database, which is used on the one hand for commissioned projects, on the other hand also for teaching and research.

3. MOFNUG: MODULAR QUESTIONNAIRE FOR USER SATISFACTION IN BUILDINGS

The idea for the second cooperative FFG-project was born by scientists who worked on the previously mentioned LOG-project. User satisfaction still is the highest and most difficult target during the planning and operation of a **sustainably optimized “High Performance Building”**.

Because a very wide range of **factors, hard to quantify, is covered by the topic “user satisfaction”, four universities** of applied sciences where cooperating between 2013 and 2016 to shed light on this issue from different perspectives like marketing, psychology, energy technology and facility management. One main focus has been **developing an online survey platform, which is used to “measure” relevant aspects of a building. This tool is able** to respond to different circumstances (changing types of buildings or user structures in a flexible way as it is modularly structured).

The participation of the different universities has an impact on the variety of the modules and therefore on the increased platform flexibility. These modules range from aesthetic aspects and social interaction opportunities to building service engineering oriented topics. Improvements of already existing questionnaire parts (so called clusters) and generation of new modules have been done during the whole project (for example different questions for amateurs and experts and several building types).

3.1 MOFNUG online platform

To ensure easy usage of the platform for participants and prospective customers too, a clear and simple structure is necessary. Future customers can extend the questionnaire with minimum effort due to the modular design. Figure 3 shows the current visual appearance of the MOFNUG-project (just available in German). The different **Clusters, as well as the number of included questions can be found by clicking “Fragen-Katalog” (questionnaire)**. If the page is scrolled down, each question of the currently open cluster can be seen.

The cluster “Thermischer Komfort” (thermal comfort) has been checked and optimized by practical measurements, simulations and interviews after comprehensive literature research.

This was followed by an extension of the literature research and an inclusion of additional modules by cooperation partners, for instance acoustic or visual comfort, cleanness or the room layout. For a high degree of visual comfort, an even illumination without considerable disturbance is required as well as individual adaption to the individual **user’s needs. A visual connection to the outside world allows the user to inform about daytime, location and weather** subconsciously and therefore should not be underestimated in importance. These criteria give a direction for the development of promising questions.

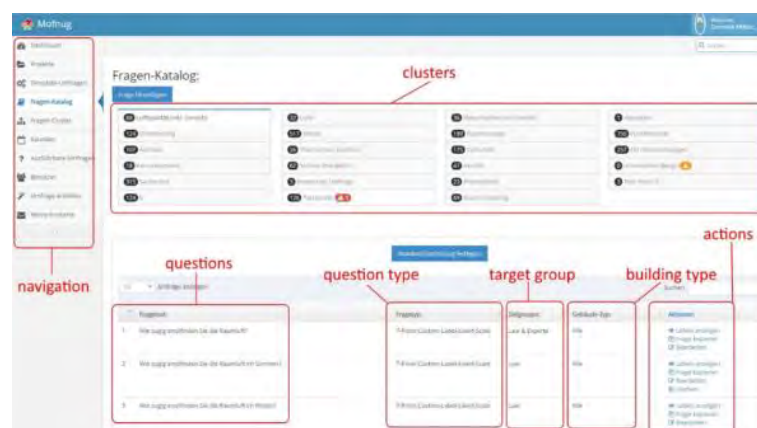

Figure 3: Screenshot of the questions currently available within each cluster of the Mofnug online

3.2 Results of the MOFNUG project

A main goal of the project was to generate an online platform where the modular questionnaire can be used to create surveys, perfectly tailored to the current needs. Each step, from developing an inquiry to its analysis can be done online without leaving the platform.

At the moment, the first surveys have been performed to check and improve the online tool. These surveys were performed within two master theses. The first one is about building automation and user satisfaction. Respondents receive an E-Mail, including a hyperlink which is valid only one time. As soon as the link is clicked, the survey opens and the first cluster is ready to be answered. In Figure 4, a typical survey, added by descriptions and translations, is displayed.

After sending invitations, the survey builder can check how many people already have finished the poll. Moreover, an evaluation of the current results is possible immediately.

It is also possible to generate word clouds with the online tool. If the questionnaire includes questions, answered onto free text areas, the system automatically creates a picture, where often mentioned terms are bigger than less frequent called words- **commonly used conjunctions and other words on a "black list" will not be displayed to ensure a maximum degree of relevant data.** A question of the first master thesis is what does produce noise at their workplace. The "biggest" answers, shown in Figure 5, are: heating system, conversations, and employees/persons.

Question (German)	Translation (English)
Welchem Typ entspricht Ihre Kleidung gerade am ehesten?	What type of clothes do you wear currently?
Wie würden Sie Ihre körperliche Aktivität beschreiben?	How would you describe your physical activity?
Wie empfinden Sie die Temperatur?	How do you feel about the temperature?
Alles in allem, wie zufrieden sind Sie mit dem Raumklima?	Altogether, how satisfied are you with the room climate?
Gibt es Veränderungsbedarf in Bezug auf thermischen Komfort?	Is there any need for change towards thermal comfort?

Figure 4: Typical survey on the MOFNUG platform



Figure 5: MOFNUG word cloud about what could be done to lower the noise level

A relevant indicator for air quality is the number of persons with health problems at their workplace, what is shown in Figure 6. In this case, multiple answers are possible.

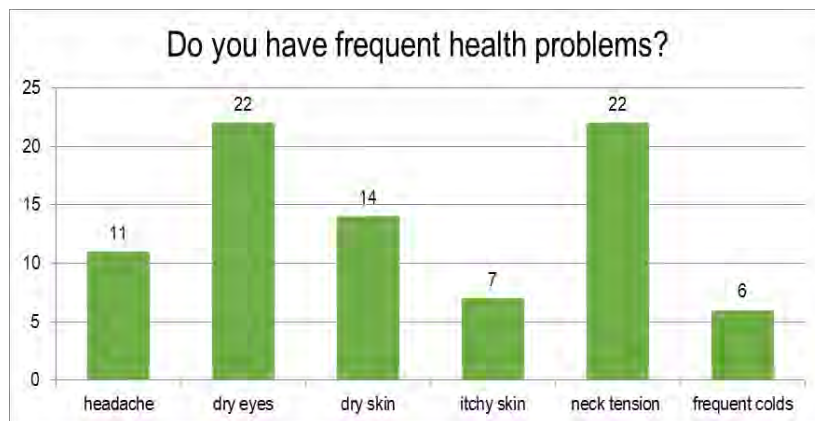

Figure 6: Physical problems of care staff at work

A usual question type on the platform is called “7-point custom Likert Scale” which allows the survey participant to answer the question relatively exact by ticking one of seven possible response options, for example reaching from 1-very bad to 7-very good or 1-too cold and 4- neutral to 7-too warm- shown in Figure 7 (additionally structured into summer and winter).

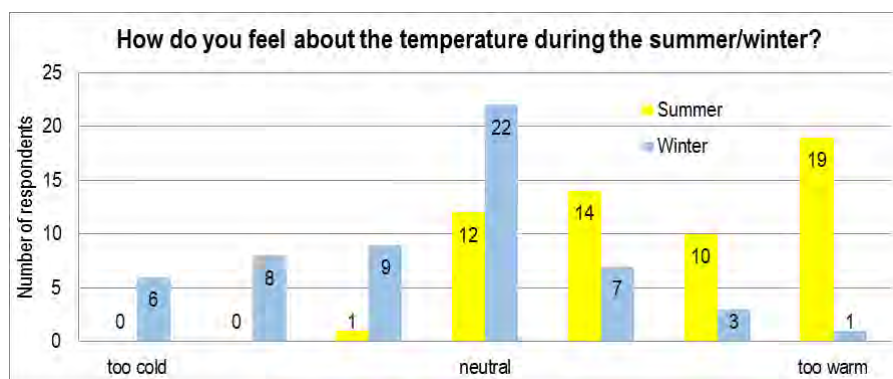

Figure 7: Perceived temperature split up into summer and winter

The second master thesis using the MOFNUNG-tool deals with user satisfaction in retirement homes for both inhabitants and staff.

Overall, the results of this study give a good overview about the preferences of the care center occupants and point out the differences of residents and geriatric nurses about thermal comfort. It is shown that with relatively **simple measures the occupants' comfort and subsequently the care satisfaction could be improved significantly.** The main discrepancies have been pointed out about the topic of thermal comfort. Whereas the residents feel relatively comfortable at an indoor temperature level of 23°C which is automatically adjusted by the heating system, this temperature is felt as too warm by the employees who have a higher metabolic rate due to their working activity. Additionally, the human thermal model established to regulate the indoor air climate in buildings by using Predicted Mean Vote (PMV) and Predicted Percentage of Dissatisfied (PPD) is not suitable for older people and especially for people suffering from dementia. 60% of the study participants felt that the room air in the building is too dry and 48 % of employees working in the building are suffering from health impairments caused by dry air. The existing spray humidifier installed in the ventilation system of the building is out of service.

For creating a new survey it is necessary to have enough information about the building, its automation systems and occupants as well as if the survey will be received by laymen or experts. If representative results are required, it is also crucial to perform measurements, such as temperature profile, VOC, humidity or CO₂.

4. CONCLUSION

The cooperation of several Austrian Universities of Applied Sciences helped to partly overcome competitive thinking and led to a significant added value at least for the participants, which is higher than just the sum of the findings.

Both LQG database and the MOFNUG platform are available from now on as supportive instruments to push forward the optimization of buildings in a broad range of fields such as life cycle costs, sustainability and user satisfaction. The online presence ensures a successful application in commissioned projects as well as in teaching and research.

REFERENCES

- [1] Dornigg, I. (2014). Application of building simulation for evaluation of thermal comfort. Wels, Austria: Master thesis at the University of Applied Sciences Upper Austria/ Campus Wels.
- [2] Leindecker, H. C., Dornigg, I. (2014). User contentment in sustainable buildings. Pinkafeld, Austria: conference transcript.
- [3] Leindecker, H. C., Luger, S. (2013). High performance buildings quality assessment. Graz, Austria: Proceedings of SB13. pp. 319-320.
- [4] Leindecker, H. C., Mittermaier, D. (2015). User satisfaction through using building automation. Pinkafeld, Austria: Sustainable Buildings. pp. 255-262
- [5] Leindecker, H. C., Mittermaier, D. (2016). Survey tool for the built environment. Zurich: SBE regional conference.
- [6] LQG, (2016). Homepage LQG- life cycle oriented quality optimization in buildings. [online] Available at: <http://lqg.beyondit.at/lqgwdb/MainSvl>, (28.01.2016)
- [7] Mittermaier, D. (2016). Building automation and user satisfaction. Wels, Austria: Master thesis at the University of Applied Sciences Upper Austria/ Campus Wels.
- [8] MOFNUG, (2016) Homepage MOFNUG -modular questionnaire for user satisfaction in buildings. [Online] Available at: <http://mofnuglive.web-fhku.eu/question>, (28.01.2016)
- [9] Ruschak, M. (2016) –user satisfaction in nursing homes –master thesis at the University of Applied Sciences Upper Austria/ Campus Wels, Austria
- [10] Schrag, T. et al. (2012). Combined database for LCC, LCA and life cycle quality. Vienna: 3rd international symposium on life-cycle civil engineering (IALCCE 2012). Pp. 1657-1664
- [11] Schrag, T. et al. (2013). Assessment of facades with life cycle aspects and case study office building-building physic. Vol. 35, No. 4, pp. 250-256
- [12] Weberberger, A. (2015). Impact of indoor air quality on the user satisfaction in buildings. Wels, Austria: Bachelor thesis at the University of Applied Sciences Upper Austria/ Campus Wels.
- [13] Zainer, S. (2015). Impact of building automation on the energy efficiency and user satisfaction. Wels, Austria: Bachelor thesis at the University of Applied Sciences Upper Austria/ Campus Wels.

The Role of Perceived Social and Physical Environments on Older Adults' Social Interactions

Piret VEEROJA^a, Greg FOLIENTE^b, Rod MCCREA^c, Hannah BADLAND^d, Chris PETTIT^e

^a University of Melbourne, Australia, pveeroja@student.unimelb.edu.au

^b University of Melbourne, Australia, greg.foliente@unimelb.edu.au

^c CSIRO, Australia, rod.mccrea@csiro.au

^d RMIT University, Australia, hannah.badland@rmit.edu.au

^e University of New South Wales, Australia, c.pettit@unsw.edu.au

ABSTRACT

The social environment and the physical environment at the neighbourhood level have been linked to social interactions and individual wellbeing in different urban populations. However, there is currently no clear understanding about the relative strength and nature of this relationship. This research seeks to better understand the relationship between measures of the social environment and the physical environment (i.e. urban form, **including community or "third places"**) and the frequency of social interactions of older adults (i.e. people aged 55 years and above). From the CSIRO Survey of Community Wellbeing and Responding to Change, we obtained **older people's individual views on their social interactions and their perceptions of social and physical environments** in six Local Government Areas (LGAs) in inner, middle, outer, and urban fringe areas of Metropolitan Melbourne, Australia. Using multiple regression analyses, we find that perceived social environment measures are stronger **predictors of social interaction frequency than the physical environment. In particular, respondents' participation in community events has the strongest association with social interactions, while the presence of, or access to, third places was not a dominant factor and had the weakest association.** These findings provide insights into older **adults' social interactions, and contribute to planning policy and practice to support ageing-in-place.** Further work **is required using objective and quantitative measures of the urban form in the context of the respondent's neighbourhood.**

Keywords: urban environment, sustainable neighbourhood, quality of life

1. INTRODUCTION

The Australian population is ageing due to rising life expectancy, declining birth rates and ageing 'baby boomers' (Lowen et al., 2015). With *The Intergenerational Report* (The Commonwealth of Australia, 2015) predicting that the number of older Australians will double by 2055, our cities need to be more age friendly. The same trend has also been predicted for other developed and developing countries in the world (Van Cauwenberg et al., 2011).

To address these societal changes, there is a growing interest in the concept of ageing-in-place. This is where people are able to age in their homes and communities in a way that their lives are changed as little as possible over time (Koh et al., 2015). Many older adults prefer ageing-in-place (Yen and Anderson, 2012) because their independence, networks and social connections are maintained (van den Berg et al., 2015). These, in turn, contribute to their overall health, wellbeing and Quality of Life (QoL). Furthermore, ageing-in-place is found to **reduce governments' health care costs (Lager et al., 2015).**

Many older adults have reduced mobility and energy levels compared with the general population (Buffel et al., 2011), so they tend to spend majority of their time in and around their homes (Wang and Lin, 2013) and immediate neighbourhoods. Face-to-face neighbourhood social interactions are claimed to reduce loneliness that is associated with due to life changes for older adults (e.g. reduced body capital and health, death of partners and friends) and increase their overall wellbeing (Lager et al., 2015). In this research we ask the question: *how can policy, planning practice and urban design provide vital support to allow ageing-in-place to occur?*

In the early 1960s, Jane Jacobs (1961) discussed among other things the influence of urban form on peoples' social relations. However, she never empirically tested her observations. Findings by Lund (2003) and Hickman (2013) confirm that urban form elements (such as density, accessibility and walkability) contribute towards social interactions. However, it is still unclear to which extent urban form influences social interactions and which specific

urban form elements contribute most. Some researchers have found that social environment elements, e.g. perceived safety (Delmelle et al., 2013), sense of social or economic opportunities (Argent, 2008) or belonging to social or cultural groups (Kent and Thompson, 2014) contribute more towards social interactions than the physical environment. This lack of clarity creates challenges in neighbourhood planning and in urban design for promoting ageing-in-place, social connectedness, overall wellbeing and QoL of older adults in our communities.

The assessment of urban form explicitly includes neighbourhood third places. Oldenburg (1989) divided places as first places (home), second places (work) and third (community) places. Little is known about social interactions across different types of third places (Hickman, 2013) with the majority of previous research concentrating on examining social interactions in one type or only couple types of places at a time. Herein, we consider eight types of third places: shops, services, cafes/bars/restaurants, public transportation stops, local streets and squares, natural environment, footpaths and community places.

This paper aims to investigate older adults' social and physical neighbourhood environments' contribution to face-to-face social interactions. In the present study, we test the following hypotheses:

H1: More favourable perceptions of social environment are positively associated with more frequent social interactions;

H2: More favourable perceptions of physical environment are positively associated with more frequent social interactions;

H3: Higher perceptions of the importance of social interactions in third places are positively associated with more frequent social interactions.

2. METHODOLOGY

2.1 Survey setting

Self-assessment of social interactions and perceptions of social and physical environments were obtained through the CSIRO Survey of Community Wellbeing and Responding to Change. This survey was administered among residents located in six (out of thirty-one) Melbourne municipalities or Local Government Areas (LGAs) - Melbourne, Yarra, Boroondara, Whittlesea, Greater Dandenong and Frankston as shown in Figure 1. The survey was undertaken in accordance with the Guidelines of the National Statement on Ethical Conduct in Human Research and approved via the CSIRO.



Figure 1: Metropolitan Melbourne in Australia (left) and study LGAs (right - marked with aqua colour).

2.2 Survey participants

Survey participants from the six LGAs were randomly selected by a third party survey company. Overall, 1,072 people participated in the survey, 476 of them were older adults (aged 55 and above) who agreed to participate in this study: with 243 older adults completing computer assisted telephone interviews (CATI) and 233 older adults completing an online survey. It took approximately 30 minutes to complete the survey (McCrea et al., 2015).

2.3 Survey measures

The survey measured different aspects of peoples' QoL and wellbeing. Most of the measures were sets of multiple items using Likert scales. The original items were designed to be treated as sets; therefore composite measures (instead of single items) were used. Means of each multiple item set were calculated (e.g. mean of all safety items), the means are referred to as a composite measure (e.g. composite measure of safety) and were used in the following analysis. Only measures for density, mix, access and the importance of various third places were single item measures.

Perceptions of social environment were measured with seven composite measures (the individual items for each are listed in the brackets):

- Social Interactions (I stop and talk to neighbors; I stop and talk to strangers in my suburb; I say hello to people in my suburb; I go out socially with others in my suburb; I enjoy simply seeing others in my suburb);
- Safety (It is safe to walk alone in the street during the day; It is safe to walk alone at night; It is safe to leave the car on the side of the road at night; Overall, I feel safe living in this suburb)¹;
- Participation in community groups (You regularly help out a local group as a volunteer; You have attended several community events in your suburb in the past year; You are a very active member of a local organization or club; Overall, you participate regularly in a variety of community activities in your suburb)¹;
- Community wellbeing (This suburb is suitable for seniors; Overall, this suburb offers a good quality of life; Overall, I am happy living in this suburb)¹;
- Community spirit (People can rely upon one another for help; People have friendly relationships; People can work together if there is a serious problem; Overall, I am satisfied with community spirit in my suburb)¹;
- Community inclusion (Suburb is welcoming of newcomers; Suburb is welcoming of people of different cultures; Overall, suburb includes everyone)¹;
- Level of trust (People that you see around can generally be trusted; Overall, I am satisfied with levels of trust in my suburb).

Perceptions of physical environment were measured under five themes:

- General appearance (Cleanliness; Greenery and parks; Walkways and paths; Neighborhoods character; Overall satisfaction with general appearance);
- General environment (Quality of the air; Level of noise; Overall quality of the general environment)²;
- Density (My suburb is becoming denser)¹;
- Mix (My suburb is becoming more varied, mixed and interesting)¹;
- Access (My suburb is becoming harder to get around)¹.

Importance of social interactions in eight types of third places were also measured: Cafes/bars/restaurants; Shops (shopping malls and specialty shops); Services (like the doctor); Public transport stops and hubs; Natural environments (like local parks); Footpaths; Local streets and squares; Community places (like libraries).

The reliability of the items in the composite measure were tested with Cronbach's alpha, all the reliabilities were good, >0.7.

2.4 Survey data analysis

The first two hypotheses (H1 and H2) were tested using multiple regression analyses. The dependent variable was the composite measure of social interactions (see first row in Table 1 for mean and SD). Independent variables were added stepwise to the multiple regression model, and we note the changes in R-square values (i.e. indicating

how well independent variables are predicting the dependent variable). Firstly, for testing H1, all social environment measures were added stepwise to the regression model. The measures were ordered according to their relevance from literature review, starting with composite measures of safety and participation with community groups and ending with composite measures of community inclusion and levels of trust.

Then urban form measures were added to the regression model, to test H2. The relevance or order of these items was not known; therefore, their order in the regression model followed their order in the survey.

Finally, for testing H3, third places were added to the analysis. They were ordered according to their relevance in literature review, starting with cafes/ bars/ restaurants, shops, natural environment and local streets and squares.

3. RESULTS

A brief summary of the socio-demographic characteristics of the participants are as follows: 56.7% were 65 years old or older, 52.5% female; 57.6% retired; 88.7% were homeowners and 67.8% lived in separate house; about 89% spoke English as their primary language; majority were very satisfied or satisfied with their physical mobility (81.3%) and health (74.0%). On average, respondents spent 5.3 days (during daytime) in and around their suburb.

The means of the measures suggest the majority of respondents were very satisfied or satisfied with their social and physical environment (only the composite measure of participation in community groups and the measure of access had a mean < 3.0) as seen in Table 1.

	Obs	Mean	SD	1	2	3	4	5	6	7	8	9	10	11
1. Social interaction	476	3.53	0.88											
2. Safety	476	3.85	0.88	0.24										
3. Participation in com. groups	475	2.53	1.28	0.38	0.10									
4. Com. wellbeing	476	4.29	0.73	0.44	0.42	0.15								
5. Com. spirit	473	3.67	0.86	0.56	0.33	0.26	0.53							
6. Com. inclusion	469	3.68	0.85	0.36	0.14	0.09	0.34	0.53						
7. Level of trust	467	3.50	0.82	0.44	0.42	0.21	0.50	0.63	0.38					
8. Gen. appearance	476	3.97	0.75	0.32	0.46	0.10	0.60	0.50	0.33	0.55				
9. Gen. environment	476	3.76	0.92	0.26	0.35	0.07	0.38	0.39	0.24	0.36	0.51			
10. Density	472	4.06	1.11	0.03	0.02	0.04	0.01	0.01	0.05	-0.03	-0.08	-0.10		
11. Mix	470	3.37	1.05	0.20	0.02	0.12	0.17	0.25	0.27	0.16	0.12	0.08	0.26	
12. Access	473	2.90	1.29	-0.10	-0.09	-0.04	-0.16	-0.17	-0.18	-0.13	-0.20	-0.20	0.34	0.04

Table 1: Descriptive statistics and spearman correlation coefficients

Community wellbeing (in Table 1) had a mean of 4.3, indicating that participants were satisfied with living in their community. Interestingly, the analysis revealed that 81.0% of older adults strongly agreed or agreed that their suburb was suitable for older adults; this measure was part of community wellbeing measure. Table 1 shows that majority of measures had weak or moderate correlations (coefficient < 0.5). The highest correlation was between composite measure of levels of trust and community spirit (0.63).

The results of the multiple regression analysis are presented in Table 2. Composite measures of community wellbeing added 10.6% to the model and community spirit 9.3% and were the most significant predictors of frequency of social interactions. The least important composite measure was levels of trust (i.e. it removed 0.2% from the model).

We cannot reject hypothesis H1 because half of the social environment measures are significant for predicting frequency of social interactions (composite measures of participation in community groups; community wellbeing and community spirit); and their p value is <0.05. We note, however, that the composite measures of levels of trust and community inclusion are not important predictors of frequency of social interactions, changing the prediction

model with less than 1%; similarly, the composite measure of safety changes the model with approx. 6% and the p-values of these measures are >0.05.

In testing H2, we added physical environment measures to the perception model (that already contained social environment measures). Physical environment measures had minimal impact to the model as seen in Table 2. Hypothesis H2 is rejected – the perceptions of physical environment did not influence the frequency of social interactions over and above than the social environment.

Finally, in testing H3, eight types of third places were added to the model. Overall, the third places added 8.7% to the model. Our results showed that cafes/bars/restaurants have the highest impact to the model (3.5%), followed by shops (1.5%), footpaths (1.4%) and natural environment (0.8%), these four types of third places had significant p-value (>0.05). We cannot reject hypothesis H3.

STEP 1. H1: Higher perception of the social environment is positively associated with greater amount of frequency of local social interactions.			
Measure	R-squared	Change in R-squared	p-value
Safety	0.0575		0.54
Participation in community groups	0.1985	0.141	0.00
Community wellbeing	0.3049	0.106	0.00
Community spirit	0.3975	0.093	0.00
Community inclusion	0.4059	0.008	0.12
Levels of trust	0.4042	-0.002	0.19
STEP 2. H2: Higher perceptions of the local environment is positively associated with greater amount of local social interactions.			
Measure	R-squared	Change in R-squared	p-value
General appearance	0.4049	0.0007	0.40
General environment	0.4054	0.0005	0.35
Density	0.4022	-0.0032	0.97
Mix	0.4026	-0.0028	0.70
Access	0.4023	-0.0031	0.95
Step 3. H3: Higher perceptions of social interactions in third places are positively associated with more frequent social interactions.			
Third place	R-squared	Change in R-squared	p-value
Cafes/bars/restaurants	0.4370	0.0347	0.000
Shops	0.4520	0.015	0.002
Natural environment	0.4601	0.0081	0.003
Local streets and squares	0.4676	0.0075	0.018
Community places	0.4723	0.0047	0.121
Services	0.4708	-0.0015	0.769
Public transport stops	0.4744	0.0036	0.844
Footpaths	0.4888	0.0144	0.001

Table 2: Results of hierarchical multiple regression analysis for predicting frequency of social interactions from respondents perceptions of social and physical environment

4. DISCUSSION

Participation in community events was the most significant social environment measure for predicting the frequency of social interactions in older urban residents. This accords with the work of van den Berg et al. (2015) who noted that volunteering (one item of the participation in community events measure) may be an important part of social interactions for older adults because it usually involves other people. Interestingly, approximately 47% of **respondents strongly disagreed with the statement “you regularly help out a local group as a volunteer”, as seen in Figure 2.** Overall, Figure 2 shows that responses for participation in community events are skewed to the right, meaning that participants do not perceive they are participating in community activities, which is an interesting finding in itself.

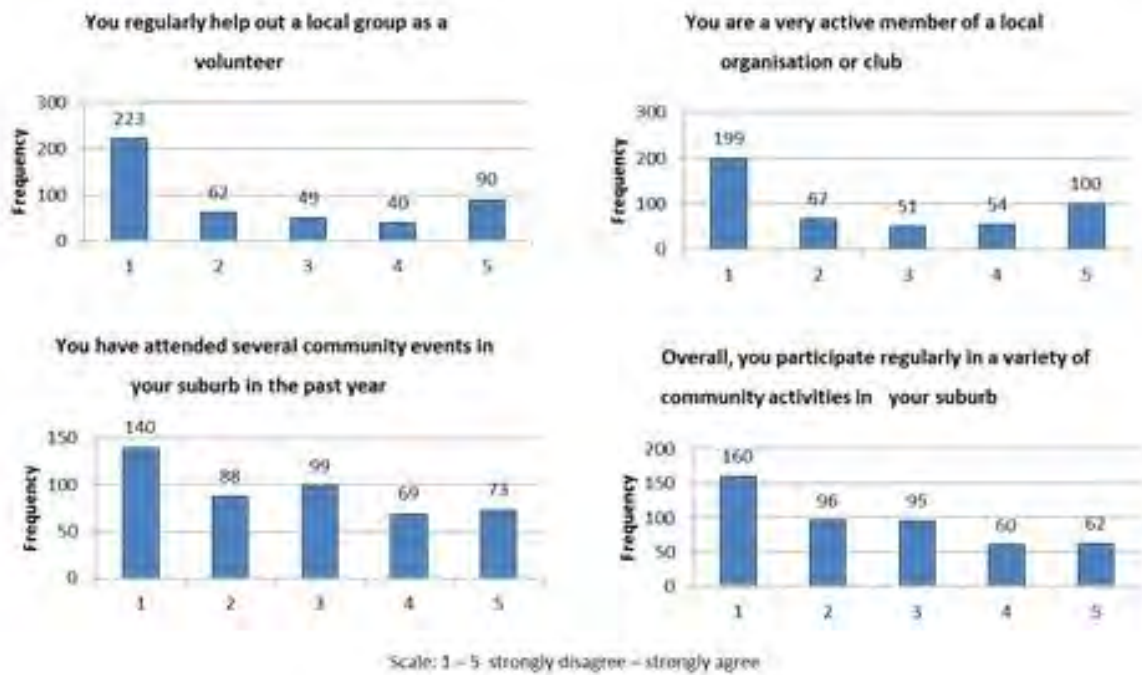

Figure 2: Frequency of 'participation in community events' responses

Perhaps the most surprising finding is that perceived safety was not a significant predictor of social interactions. This is not in accordance with literature. For example, Delmelle et al. (2013) suggested that safety is a very important aspect for social contacts to occur in Austrian context (and in some cases perhaps even more important than urban form). However, in the case of the 6 Melbourne LGAs, the majority of respondents were very satisfied or satisfied with their overall safety. This could be a general Australian or Melbourne community perception.

Surprisingly, the perceived urban form measures had minimal impact to the model over and above the social environment. This needs further investigation in the next **stage of analyses**. **The respondents' addresses have** been geo-coded to enable spatial analysis to be conducted.

5. CONCLUSIONS, LIMITATIONS AND FUTURE WORK

Based on urban older residents' perceptions of their social and physical environments and their relation to frequency of social interactions, we find that the former is relatively more important than the latter. This means that, **to specifically improve older adults' social environment and support ageing-in-place**, policies and initiatives that encourage participation in community events and activities and increase their social interactions are important. We note that the survey was a **self-reported study and covered only the participants' perceptions of their social and physical environments**. The role of neighbourhood planning, place-based design and specific configurations of urban form, including the availability of – and access to – third places, needs further investigation. Since we have geo-coded and mapped the respondents' home locations and we can have objective neighbourhood measures of urban form and structure, this is indeed the next phase in our investigation.

Furthermore, we did not include digital communication and social media use, which are continually growing and becoming increasingly more important in the developed world; these also need to be considered in future research.

REFERENCES

- [1] Argent, N. 2008. Perceived Density, Social Interaction and Morale in New South Wales Rural Communities. *Journal of Rural Studies*, 24 (3), 245-261.
- [2] The Commonwealth of Australia. 2015. 2015 Intergenerational Report: Australia in 2055. Retrieved from: <http://www.treasury.gov.au/PublicationsAndMedia/Publications/2015/2015-Intergenerational-Report> [Retrieved on 7 October 2016]
- [3] Buffel, T., Verté, D., De Donder, L., De Witte, N., Dury, S., Vanwing, T. & Bolsenbroek, A. 2011. Theorising the Relationship Between Older People and Their Immediate Social Living Environment. *International Journal of Lifelong Education*, 31(1), 13-32.
- [4] Delmelle, E. C., Haslauer, E. and Prinz, T. 2013. Social Satisfaction, Commuting and Neighborhoods. *Journal of Transport Geography*, 30, 110-116.
- [5] **Hickman, P. 2013. "Third Places" and Social Interaction in Deprived Neighbourhoods in Great Britain.** *Journal of Housing and the Built Environment*, 28(2), 221-236.
- [6] Jacobs, J. 1961. *The Death and Life of Great American Cities*, Vintage, New York.
- [7] Kent, J. L. and Thompson, S. 2014. The Three Domains of Urban Planning for Health and Well-Being. *Journal of Planning Literature*, 29(3), 239-256.
- [8] Koh, P., Leow, B. and Wong, Y. 2015. Mobility of the Elderly in Densely Populated Neighbourhoods in Singapore. *Sustainable Cities and Society*, 14, 126-132.
- [9] **Lager, D., Van Hoven, B. and Huigen, P. P. P. 2015. Understanding Older Adults' Social Capital in Place: Obstacles to and Opportunities for Social Contacts in The Neighbourhood.** *Geoforum*, 59(0), 87-97.
- [10] Lowen, T., Davern, M. T., Mavoa, S. and Brasher, K. 2015. Age Friendly Cities and Communities: Access to Services for Older People. *Australian Planner*, 52(4), 255-265.
- [11] Lund, H. 2003. Testing the Claims of New Urbanism: Local Access, Pedestrian Travel, And Neighboring Behaviors. *Journal of the American Planning Association*, 69(4), 414-429.
- [12] McCrea, R. Foliente, G.; Leonard, R.; Walton, A. 2015. 'Responding to change in a growing Melbourne: Community acceptance, wellbeing, and resilience', paper presented at the *State of Australian Cities Conference*, Gold Coast, 9-11 December.
- [13] Oldenburg, R. 1989. *The Great Good Place: Café, Coffee Shops, Community Centers, Beauty Parlors, General Stores, Bars, Hangouts, and How They Get You through the Day*, Paragon House Publishers, New York.
- [14] Van Cauwenberg, J., De Bourdeaudhuij, I., De Meester, F., Van Dyck, D., Salmon, J., Clarys, P. And Deforche, B. 2011. Relationship Between the Physical Environment and Physical Activity in Older Adults: a Systematic Review. *Health & Place*, 17(2), 458-469.
- [15] Van Den Berg, P., Kemperman, A., De Kleijn, B. And Borgers, A. 2015. Ageing and Loneliness: the Role of Mobility and the Built Environment. *Travel Behaviour and Society*, 5, 48-55.
- [16] Wang, D. and Lin, T. 2013. Built Environments, Social Environments, and Activity-Travel Behavior: a Case Study of Hong Kong. *Journal of Transport Geography*, 31 (0), 286-295.
- [17] Yen, I. H. and Anderson, L. A. 2012. Built Environment and Mobility of Older Adults: Important Policy and Practice Efforts. *Journal of the American Geriatrics Society*, 60(5), 951-956.

Every Breath We Take – Transforming the Health of China’s Office Space

Matthew CLIFFORD^a, Steven MCCORD^b, Eric HIRSCH^c, WU Xuchao^d, Louie CHENG^e, Linda YU^f

^a JLL, Mainland China, matthew.clifford@ap.jll.com

^b JLL, Mainland China, steven.mccord@ap.jll.com

^c JLL, Mainland China, eric.hirsch@ap.jll.com

^d JLL, Mainland China, xuchao.wu@ap.jll.com

^e PureLiving China, Mainland China, louie@purelivingchina.com

^f JLL, Mainland China, lindat.yu@ap.jll.com

ABSTRACT

Air pollution in China continues to be a major health risk for people across the country, with millions of premature deaths each year linked to the bad air. Continuous exposure to dangerous levels of PM2.5 – or ambient pollution dangerous to health – has also been proven to lower productivity, as well negatively impact talent attraction and retention, making it harder for companies in China to operate under a slowing economy.

With a majority of the PM2.5 outdoors making its way into the office buildings we work at, it is crucial for us to be aware of the fact that we are not safe indoors unless the air inside is properly managed. As China shifts to a service-oriented economy, even greater numbers of people will be working overtime hours in office towers, and thus, the importance of ensuring good air in the workplace will have greater implications ahead.

In the first in-depth industry look at how stakeholders in the China office market can improve indoor air quality by strategically incorporating the use of mechanical systems, professional commercial real estate services firm JLL and environmental consultancy PureLiving China present their findings on the subject. The publication also speaks to the level of action needed to be taken by landlords, tenants, and occupiers to create safer workspaces in China.

By taking the lead in this area, China has real opportunity to not only address the challenges it faces with air pollution head-on, but also to serve as an example for other industrializing nations to follow – as they, too, struggle to cope with bad air. Finally, while we cannot change conditions outside, we can all do something to control the situation indoors, which also happens to be where we spend most of our time working.

Keywords: indoor air quality, China office market, indoor environmental quality

1. OPPORTUNITY CALLS ON CHINA’S OFFICE MARKET

In the modern business world, people in China are spending more time indoors than outdoors. At work, employees **from 90 percent of the country’s industries are clocking in overtime hours on a weekly basis** (Beijing Normal University, 2015). Meanwhile, outside of the office, the air in China is a serious problem. Air pollution in China contributes to some 1.6 million fatalities in the country annually (Rohde et al., 2015). While the number of premature fatalities linked to the air that we breathe indoors is difficult to quantify, we know that spending time inside, in places where the air is not properly managed, also exposes us to harmful levels of outdoor pollution – and the ubiquitous PM2.5. The real danger is that 75% of PM2.5 outdoors – or particulate matter sized 2.5 microns or smaller – makes its way into buildings (Wallis, 2015). PM2.5 penetrates deep into our lungs, enters our bloodstream, and has sobering long-term health implications. Consequently, pollution remains at the forefront of public health concerns **in the country and continues to be a focal point of China’s 13th Five-Year Plan (2016-2020), with targets curbing reliance on coal-fuelled power – a chief source of PM2.5 – reaffirming the Chinese government’s deep commitment to the “war on pollution”.**

As pollution continues to strongly influence China’s plans for the future, indoor air quality is a critical issue that deserves greater attention, especially as high public awareness on pollution continues to increase and dramatically change people’s expectations toward health. Moreover, pollution is no longer primarily a concern among just foreigners working in China; everyone is worried about the bad air. In just a short time, the general public has gone from a state of near indifference to possessing to world-leading levels of knowledge on air quality indexes, and this is particularly evident in major cities like Beijing and Shanghai. Though China is not that far behind India and Pakistan, which suffer the highest PM2.5 concentrations in the world (World Health Organization, 2014), it is head

and shoulders above in both awareness and policy, making it best-positioned to act on indoor air quality in a global context so that other industrialising nations can follow.

While environmental reform in China is a long-term endeavour, we can all take proactive measures now to improve indoor air quality and create office space that employees will want to work in – and choose over others. In this white paper, we explore how sound investments in indoor air quality today pays immediate and future dividends, giving employers an important edge needed in China to attract and retain top talent in the increasingly competitive marketplace. Though our findings are far from providing all of the answers to indoor air quality problems, we have looked at the outside air in China and assessed how it is of concern to both landlords and tenants in the office market. Supported by data analysis of indoor air quality samples collected by our partner for this paper, indoor environmental consultancy PureLiving China, we address indoor air quality challenges for the China office market and offer potential solutions for companies operating in the country.

Our key takeaways include:

- Good indoor air quality correlates with nearly twice the level of productivity compared to average air quality and is of increasing significance for talent attraction and retention in China.
- Good indoor air quality can be achieved by following our three As: Assess, Act, and Assure.
- Investments in indoor air quality further differentiate office buildings from competitors, better enabling them to retain value.

Good indoor air can double productivity levels

While the benefits of a healthy workspace can be difficult to measure in terms of directly correlating gains, new research indicates that working environments with better ventilated clean air helps raise the level of productivity for analytically intensive tasks by as much as twice that compared to just average air quality (see Figure 1; Allen et al., 2015). The study is significant because it suggests that air quality has far more of an impact than previously thought, as previous studies only linked better airflow to a limited improvement of productivity for repetitive tasks such as typing speed (World Green Building Council, 2014). Furthermore, instead of relying on performance of rote tasks, the study measured performance on standardised tests assessing analytical skills highly relevant to professional services firms. This is particularly relevant for China, as it shifts towards a service-oriented economy.

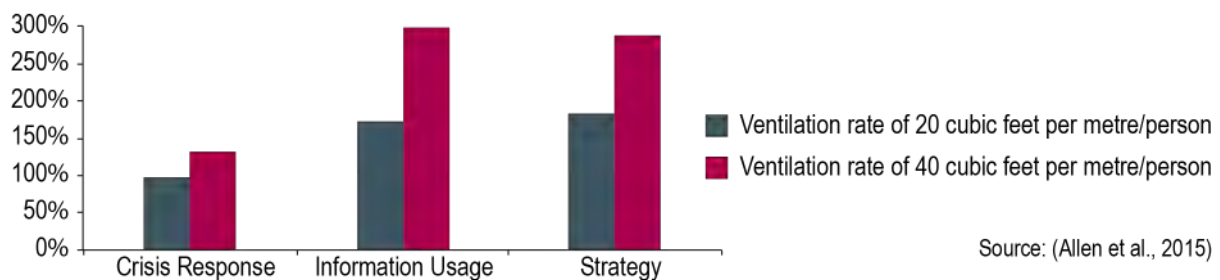

Figure 1: Productivity increases in analytical tasks

A boost for talent attraction and retention

Under a slower economy, productivity gains from good indoor air are also especially significant given that staffing costs make up the bulk of a company's operating costs. Moreover, investments in improving air quality can pay for themselves in as little as three to six months through increased productivity, reduced sick days, and lower health insurance premiums (Wallis, 2015). Though technologically advanced buildings with filtered fresh-air systems tend to be higher rent-buildings, these properties typically only demand marginally higher rent than the market average. Thus, a small premium in office rent could go a long way in creating big cost-savings for firms as greater productivity leads to better performance.

2. OUR 3As STRATEGY ACHIEVES OPTIMAL RESULTS

Achieving good indoor air quality at work is as simple as following our 3 As: Assess, Act, and Assure. While the actions taken by employers to improve indoor air quality in a new or old building will differ, the process undertaken to get there will be the same. Though many employers have a tendency to cut corners at some stage of the process, believing that budgetary requirements will be beyond their reach, this is perhaps unwise. Skipping over a step could lead to serious repercussions – the circulation of dirty and dangerous air – that could prove much costlier and painful to fix at a later date. It is also important to note that not all undertakings to improve air quality are necessarily costly. Moreover, as companies face added pressures to run on lower operating budgets to increase their competitiveness in the market, we expect more employers in China to seek a better a balance between achieving good indoor air quality, energy-efficiency, and cost-savings.

First: assess your workplace situation.

When considering a space for lease, tenants should be proactive in asking landlords about what has been done to provide good indoor air quality in the building. For example, does the office tower have a fresh-air system in place, and what is the effectiveness of its filtration system? The more tenants ask these questions, the better, as it motivates landlords to consider these specifications when they do upgrades. It also applies pressure on them to change their property management practices. Yet, even if a landlord assures you of excellent air quality, it is not possible to detect the indoor air quality of a space solely by relying on their responses. Even in cases where the landlord has answered truthfully, differences in design, operation, and maintenance can produce varying outcomes. Thus, due diligence is important. Having air quality tested not only provides a snapshot of the situation, but also helps to form the basis of a solution to improve the indoor air quality of the space in question. For the best results, PM2.5-auditing should be conducted by a credible third party, not just before occupation as is most commonly done, but actually prior to fit-out commencement to ensure that solutions can be implemented during the fit-out period (or afterwards as a retrofit). This assessment is critical to knowing how to act.

Second: act on that information.

With a sample of 100 data points collected at some 50 commercial offices around the country in Beijing, Shanghai, Chengdu, and Suzhou from indoor air quality testing carried out from 2013-2015, PureLiving China considered almost a dozen factors contributing to indoor air quality. This helped us determine what has the biggest impact on PM2.5-reduction indoors. Surprisingly, several factors, including building height, occupant density, and green certification had little correlation with the reduction of PM2.5 indoors. Statistical analysis revealed that as a group, mechanical systems, specifically the heating, ventilation, and air conditioning (HVAC), and filtration functions, make the most meaningful contributions to cleaner indoor air at offices in China (see Figure 3). Therefore, these should be the prime focus of efforts to improve the air where we work.

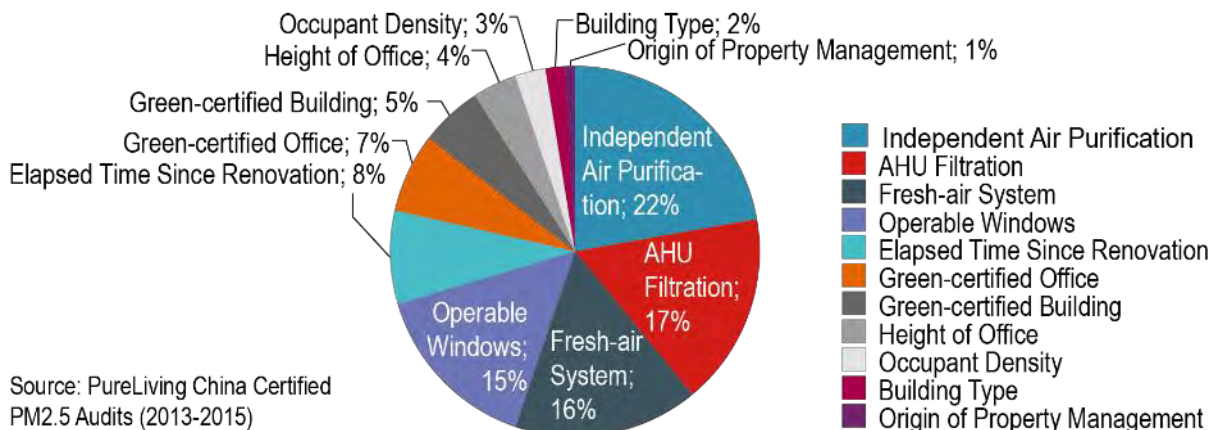

Figure 2: Relative impact of factors on PM2.5 reduction

Improving the indoor air quality of an office can be as simple as ventilating the space with fresh air from an open window. While this may work in other countries, in China, opening a window often means bringing polluted air into the workspace. As a result, many office towers rely on a fresh-air system to ventilate the air within their building. The easiest way to purify the air inside is to exploit existing equipment and retrofit higher efficiency particulate

filtration media into existing air handling units (AHUs) of a central HVAC system. AHUs utilising high-efficiency filters deliver large amounts of purified air at a minimal cost, but retrofitting the central ventilation or air conditioning system is not always an option; sometimes, the fresh-air delivery rate is already low and should not be further reduced, or the landlord is unwilling to allow modifications. This leads many tenants to assume that control over their environment is beyond their reach, but is untrue. Tenants can, in fact, significantly benefit from installing independent purifiers that filter the air within their offices. Depending on the size of the space or the time permitted for the upgrade, different methods can be used to filter the recirculating air.

There are two ways to approach this. One is the use of portables, which can be highly effective, but carries cost, maintenance and human error drawbacks. A second option is to install in-ceiling recirculating solutions which our data found to be the most effective and cost-efficient. The in-ceiling approach has been found to be significantly more effective for big areas compared to portable air purifiers at floor level due to their higher capacity and therefore sweeping coverage area. In-ceiling systems can also be spaced apart without any airflow obstructions from furniture. This allows for evenly distributed filtration at a faster rate and minimal sources of interruption. By comparison, portables are frequently found turned off, without a filter, with a dirty filter, or with a filter incorrectly inserted, making it difficult for the machines to work as designed. The results of our analysis (see Figure 4) demonstrate a combination of in-ceiling purification, AHU filtration, and a fresh-air system is most likely to lead to the most meaningful reductions of PM2.5 indoors.

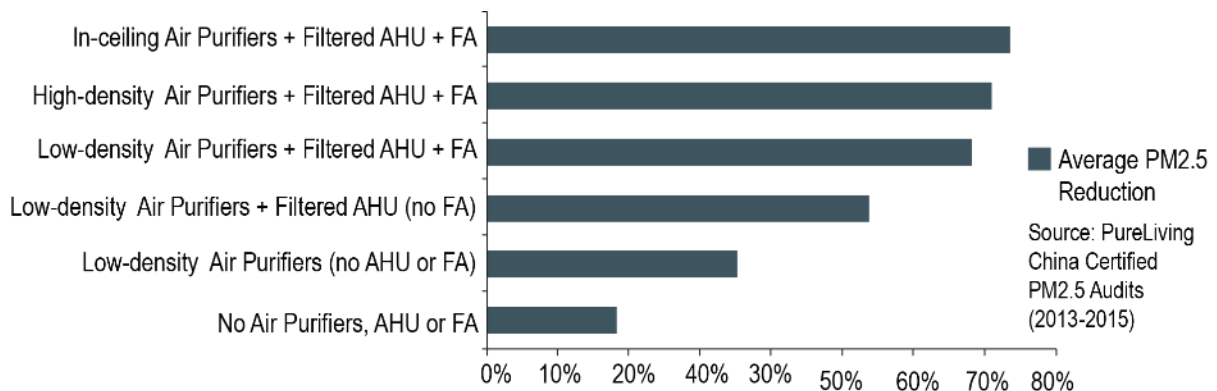

Figure 3: HVAC and filtration combination efficiencies

The use of mechanical systems is most compelling when extreme spells of pollution hit. Figure 4 shows the actual recorded PM2.5 levels in a 1,000-sqm Grade A office in Shanghai during a historic “airpocalyptic” episode in December 2013. This is the true stress-test of the equipment. By using in-ceiling air purifiers to filter the recirculating air, the company’s office effectively achieved a 93 percent-reduction. Indoor PM2.5 levels never exceeded 40 micrograms per cubic metre, while outdoor levels soared up to 570 micrograms per cubic metre.

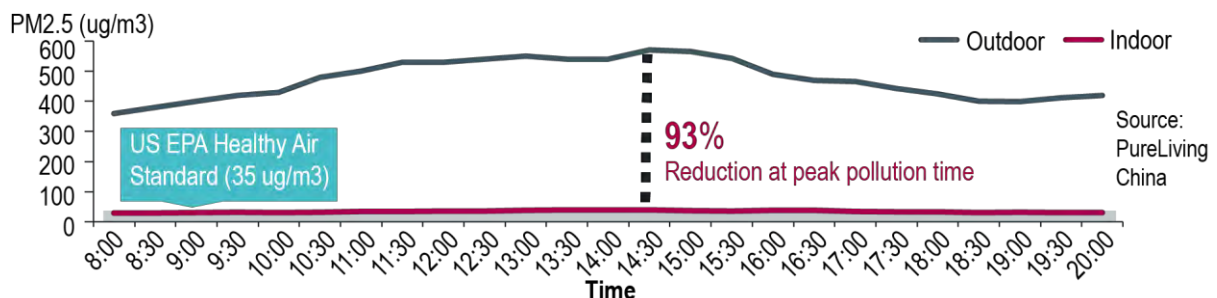

Figure 4: Dec. 2013 Shanghai “Airpocalypse” – PM2.5: outdoor vs. indoor

While portable filtration units are quicker to set up and cheaper by the unit than ceiling units, more portables are required to cover a larger space. Therefore, portables are most suitable for smaller rooms (typically working best in spaces smaller than 20 square metres in size) or temporary offices requiring flexibility in deployment. In-ceiling units, on the other hand, take comparatively longer to set up, but their installation is still relatively quick, and they can be hidden with drop ceilings to reduce their visibility and distraction to employees. Though the capital investment required for these systems is more upfront per unit than portables, they offer greater longer-term cost-savings due to lower maintenance costs and higher coverage per unit (see Figure 5).

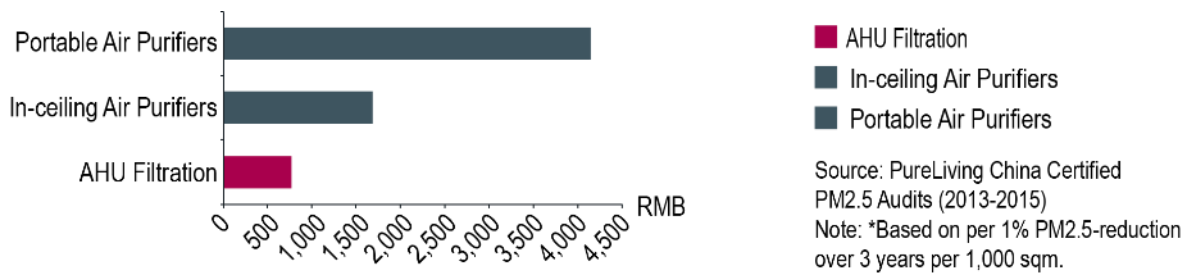

Figure 5: Relative cost for mechanical system filtration options*

Meanwhile, on-demand automation is the latest tool in the market. Strongly preferred for its ability to reduce human error or mistakes commonly made when it comes to manually operating purifiers, such as cleaners accidentally turning units off on “good-air days” and people fighting over the control switch without understanding how the machines work. On-demand automation is also highly efficient and energy-saving as pre-programmed functions enable air filtration systems to function based on real-time air quality (see Figure 6). Given that the machines do not need to be kept on at all times, on-demand automation also lowers operating costs through energy savings. Therefore, we expect interest in on-demand automation to grow as the number of employers investing in better indoor air quality rises.

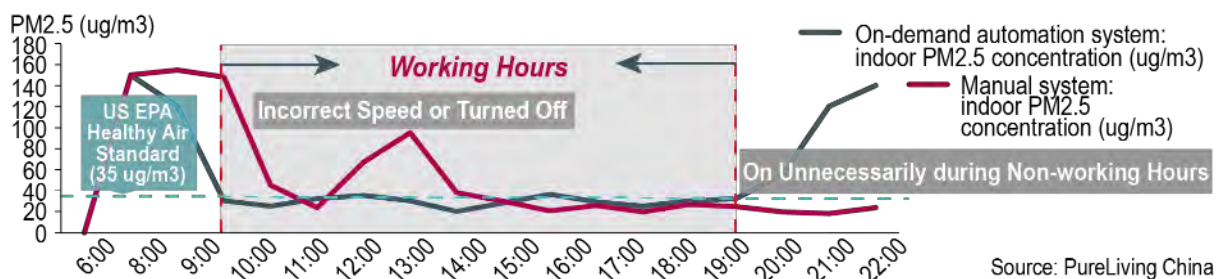

Figure 6: On-demand automation vs. manual operation

Third: assure that good air quality is maintained by continuously monitoring your accredited space.

Many landlords and employers mistakenly assume that once the installation is complete, there remains nothing left to do. In fact, the real work begins after a designated system is up and running. Continuous monitoring of the indoor air quality allows operation teams the ability to fine-tune performance of the equipment and staff operating the machines the ability to improve how the machines are used. It also ensures that landlords, employers, and employees are getting the most out of the systems. The good news is that ongoing monitoring has never been easier, due to the convenience of online applications that are able to capture live indoor air quality readings. This is rapidly driving the industry toward performance-driven solutions, exerting greater pressure on landlords to deliver consistently desirable results as employers are pushed by employees to provide safe air during working hours. In turn, demand for industry certifications like RESET (www.reset.build) or WELL (www.wellcertified.com) is mounting, as these accreditations have been proven to help protect occupant health with specific requirements for criteria affecting indoor air quality. Apart from providing a road map and standard for the creation of healthy spaces, these certifications provide marketing benefits and recognition for those who make the effort and achieve real results. Moreover, real-time monitoring apps, particularly those which allow accredited spaces to be followed online by employees, further offer a high degree of transparency, and thus, these apps also serve as a powerful feedback tool in holding both landlords and employers accountable for the indoor air quality of their space on a regular basis. This ultimately encourages both sides to work together to make certain that problems are rectified quickly as they arise, additionally helping to minimise interruptions to good indoor air quality.

3. MARKET DIFFERENTIATION IS KEY TO SURVIVAL, SUCCESS

Investments in indoor air quality further differentiate office buildings from competitors, better enabling them to retain value in any market. While we have discussed why employers have numerous reasons incentivising them to act quickly, it should also be recognised that landlords, too, have a very persuasive case to be proactive in leading the market. As more landlords consider HVAC upgrades, making the right level of investment in system upgrades will be essential. Under-investing has been the case historically and should be avoided – as should over-investing from

an insufficient assessment of the situation. The bottom line is that office towers with good indoor air will only be more appealing to tenants. Buildings without good indoor air quality will provide tenants with less incentive to sign or renew their leases, particularly in older buildings where tenant leases are nearing expiry. In the worst-case scenario, tenants will move into buildings with cleaner air. Even buildings with high occupancy are still susceptible to losing tenants.

Today, office buildings with good indoor air quality are able to set themselves apart from competitors. Later, as more buildings upgrade their systems, those with the best equipment (specifically fresh-air systems and AHU filtration) will be able to maintain their relevance to the market. Moreover, properties with good indoor air quality will be more resilient in periods of economic downturn or slow growth, thus extending their long-term market viability, particularly as health and safety concerns remain a priority for building satisfaction among tenants (BOMA, 2013).

4. WE ARE NOT POWERLESS AGAINST AIR POLLUTION

While we cannot change conditions outside, we can control the situation indoors, which also happens to be where we spend most of our time working. In the interim, this means that the onus will be increasingly placed on landlords and employers to be proactive in providing effective and sustainable solutions to safeguard people from the major health risks that come with the bad air, especially as more employees demand that the welfare of their health be taken seriously in the workplace. With all there is to gain, we are cautiously optimistic that more office stakeholders will act and lead the pack with the delivery of sensible indoor air quality solutions.

In this paper, we have examined the subject of indoor air quality, with a dedicated focus on its relation to pollution in the China office market within the context of commercial real estate. Considering that pollution is an ongoing concern, however, our intent is not to be overly conclusive, but rather to help provide a better understanding of the bigger picture and how the issue is growing in significance for companies operating in China. We have also outlined practical options in our 3 As strategy that are available in the market which can help improve the situation – now. Though more landlords and employers in the office market are increasingly getting on board, the reality of the situation is that those currently acting to achieve good indoor air quality continue to make up the minority, when in actuality, the pursuit of clean indoor air should really be a mainstream priority.

REFERENCES

- [1] Allen, J.G., Macnaughton, P., Satish, U., Santanam, S., Vallarino, J. and Spengler, J.D., 2015. Associations of Cognitive Function Scores with Carbon Dioxide, Ventilation, and Volatile Organic Compound Exposures in Office Workers: A Controlled Exposure Study of Green and Conventional Office Environments. *Environmental Health Perspective*. Retrieved from: http://ehp.niehs.nih.gov/wp-content/uploads/advpub/2015/10/ehp.1510037_acc0.pdf [Retrieved in 2015].
- [2] Beijing Normal University. China Labour Market Report Analysis, 2014. Retrieved from: www.cnki.net [Retrieved in 2015].
- [3] Building Owners and Managers Association (BOMA) China. Beijing Tenant Survey, 2013. Retrieved from: <http://www.purelivingchina.com/wp-content/uploads/2013/12/PureLiving-Commercial-Intro-EN-2013.pdf> [Retrieved in 2015].
- [4] Rohde, RA. and Muller, RA., 2015. "Air Pollution in China: Mapping of Concentrations and Sources". *PLoS ONE*, 10(8).
- [5] Wallis, R., 2015. RESET Certified Video, Retrieved from: www.v.youku.com/v_show/id_XMTQwNjQ5MDE0OA==.html?from=y1.7-1.2 [Retrieved in 2015].
- [6] World Green Building Council. Health, Wellbeing & Productivity in Offices, 2014. Retrieved from: www.worldgbc.org/files/6314/1152/0821/WorldGBC_Health_Wellbeing_productivity_Full_Report.pdf [Retrieved in 2015].
- [7] World Health Organization. Outdoor Air Pollution Database, 2014. Retrieved from: www.who.int/entity/quantifying_ehimpacts/national/countryprofile/app_pm_database_may2014.xls?ua=1 [Retrieved in 2015].

Are Patterns of Use the Key to Resource Efficiency in Office Buildings?

Ken DOOLEY^a, Davor STJELJA^b

^a Granlund Consulting, Finland, ken.dooley@granlund.fi

^b Granlund, Finland, Davor.stjelja@granlund.fi

ABSTRACT

The building sector is responsible for approximately one third of Europe's greenhouse gas emissions and thus it is a high priority when aiming to support climate change mitigation. Resource efficiency and energy efficiency strategies can help to reduce the environmental impact of buildings and this article aims to explore if occupancy data can assist their implementation. The influence of occupancy patterns are usually overlooked when consumption in buildings is being discussed. The current method of analysing the environmental impact of buildings is to normalise consumption by building size. This is done for energy, water and carbon dioxide and building size is typically defined by net internal area. However, there is growing call to normalize buildings with patterns of use and with occupancy patterns in particular. Occupancy data was collected in an office building for one month in order to calculate the peak occupancy of the case study area. This also enabled the occupancy and energy consumption patterns to be compared. In addition to this, the energy consumption of the case study building was simulated in order to explore how energy consumption is influenced by different workplace arrangement strategies. It has been shown that daily occupancy curves add valuable information regarding the control strategies of the energy using systems in office buildings. It has also been shown that the peak occupancy rate of the individual building areas is also valuable data as it holds the key to how many desks are needed for a set group of people. It is clear that the amount of space reserved has a big implication on rental costs and energy consumption. The data has multiple uses and can even be used to rent out unused spaces to the public via a growing number of sharing economy websites that focus on spaces in commercial buildings.

Keywords: resource efficiency, energy efficiency, utilisation rate

1. INTRODUCTION

The current method of analysing the environmental impact of existing buildings is to normalise consumption by building size. This is done for energy, water and carbon dioxide and building size is typically defined by net internal area. The simple reason for doing this is that buildings of different sizes can be compared with one another. This practice is reinforced by national building regulations which aim to reduce consumption in buildings and the legal requirements regarding energy efficiency commonly present their target criteria in the format of energy per unit area such as kWh/m². The problem with this is that the influence of the occupancy patterns are being overlooked when we only consider the amount of energy consumed and the building size.

For example the Finnish national energy efficiency regulations for buildings has defined the maximum amount of energy that new buildings can consume and this is presented in the format of energy per square meter. In order to simplify the comparison for different buildings, the regulation assumes that the buildings are occupied in a standard manner. If office buildings are taken as an example, then the predefined occupancy pattern is 5 days a week from 07:00–18:00 and during these hours it is assumed that 65% of the staff are present. It can clearly be seen here **that the influence of the building's individual occupancy patterns are being overlooked**. However, there is growing call to normalize buildings with patterns of use and with occupancy patterns in particular. The most comprehensive approaches have called for energy to be normalized by the combination of area and total person hours per year where total person hours per year is the sum of all of the time that each building user spent in the building during the year in question. Furthermore, this intention has been included in European Standard EN15643-1 which advocates that patterns of use should be used in the sustainability assessment of buildings. At present, the legal requirements for energy efficiency are only imposed on buildings when they are being designed or renovated and at this point the energy consumption and patterns of use that are used are estimated and not measured values. There is no legal pressure to conform any post-occupancy energy consumption requirements.

It has been widely discussed that office buildings are only partially occupied during opening hours. The British Council for Offices stated as recently as 2013 that occupancy levels are typically between 60-70%. This means

that on average in office buildings 30-40% of the desks are empty during working hours. In addition, there is a wide variation between occupation densities from 7 m² of floor area per person to as much as 19 m² per person for private offices. According to the British Council for Offices the mean occupation density is 10.9 m² per occupied workspace. It is important at this point in the discussion, to note that consumption should be normalised by measured post-occupancy patterns and not the occupancy patterns used in design. Energy consumption has in the past been presented in the form of energy per person where the number of people has been defined by the number of desks in the building or number of staff that the building has been designed for. However, these design numbers are not suitable due to the low occupancy levels of buildings during their use. Also, Dooley points out that energy per person does account for occupation density but does not account for working hours per day which also influences consumption. Thus, energy normalised by the combination of area and total person hours per year is a more suitable metric than energy per person.

Patterns of use have a strong influence on the environmental impact of the existing building stock. If office buildings are on average 30-40% empty during working hours then energy is being consumed by the unused area even if it is empty. It is being heated in winter, cooled in summer, ventilated and background lit all year round. Also, the embodied carbon emissions of the materials used to construct the building are not being optimised if a large portion of the building is consistently unused. Underutilised buildings can contribute to urban sprawl as new buildings are being built on the edge of cities while many spaces that are already constructed are unused. This is similar to how Airbnb has optimized the use of homes and this has resulted in less new hotels being built. Increasing the use of our existing buildings will make the built environment more resource efficient and will reduce the need for new buildings to be built. It also makes sound financial sense to optimise space use as according to a report published in 2014 by Finnish space efficiency experts, Rapal, the average annual cost per annum of a workstation in Helsinki is €9225. **The report also notes that Helsinki has only the 15th most expensive occupancy costs in the world and thus the cost per workstation is even higher in a number of other cities.**

Public bodies are now beginning to see this error and are starting to increase the use of their buildings. In 2014, it was reported that spaces in government buildings in Seoul, South Korea, were being opened and offered for use by the public. At the time of that publication 970 empty spaces, such as conference rooms and auditoriums had already been used in 22,931 cases. This is part of wider plan in Seoul to promote sharing of unused resources in order to achieve a more practical and sustainable way of living. At this point it should be clarified that the aim for efficient use of space should not compromise the comfort or productivity of the building users and it has been shown by many researchers that it is possible to provide quality and productive indoor workspace environments at high occupancy densities.

The European Commission plans to reduce greenhouse gas emissions by at least 80% by 2050, compared to 1990, with the intention of keeping climate change below two degrees Celsius. In order to achieve this, the building sector must be considered. Previous research has stated that the building sector consumes approximately 39% of the total energy consumption and emits approximately 35% of the total CO₂ emissions in Europe and thus it is an important sector when aiming to reduce global greenhouse gas emissions. This article focuses on office buildings which is the largest commercial building sector in terms of floor space and energy use in most countries. The aim of the article is to uncover: can measured occupancy data assist the implementation of resource efficiency and energy efficiency strategies in existing buildings?

2. RESEARCH METHODOLOGY

In order to collect empirical data on energy consumption and usage patterns, two video cameras were installed in an office building in Helsinki, Finland. The dome video cameras were chosen as they were compatible with a commercial people counting software which is typically used in retail buildings to monitor the number of visitors over a period of time. The studied area was a portion of the third floor of a three floor office building. Its floor area was approximately 650 m² and it mainly comprised of a large open office area, three meeting rooms, a small kitchenette and a break area. The case study area can be seen enclosed by a red box in Figure 1 below.

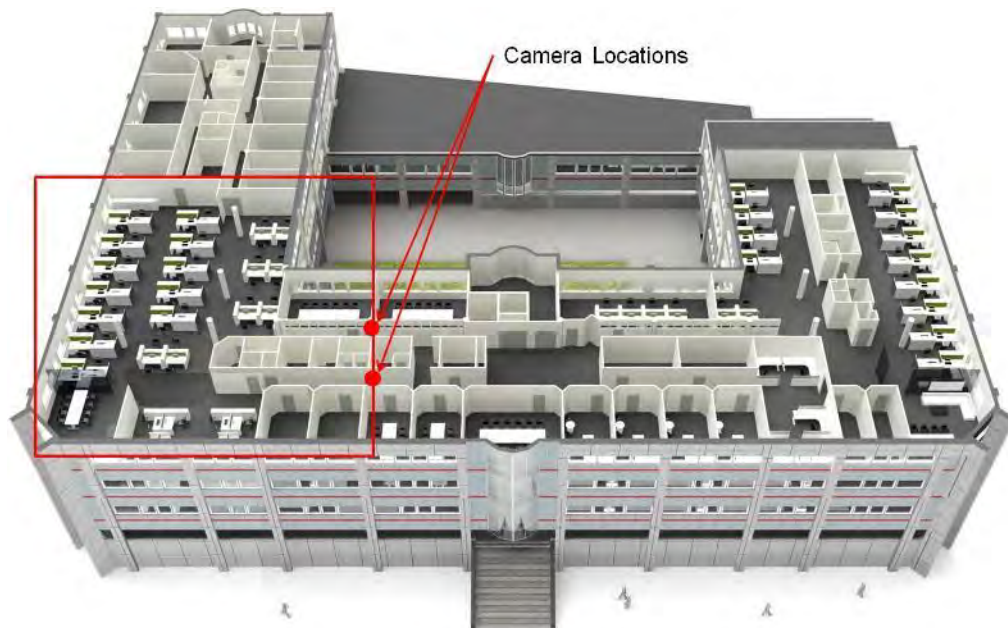

Figure 1: The camera locations and the studied area within the case study office building

This area was chosen as it was the only part of the building that had less than three entrance and exit routes and this greatly simplified the installation and the analysis of the camera data. The analysis of a whole floor could not be done as it was not possible to study people movement at the main entrance to each floor. The reason for this was that the camera software could not function correctly if the cameras were installed inside the door as at this point there was movement in two perpendicular directions (in/ out of the door and movement up/ down the adjacent corridor). In addition to this, there was a fire zone in the stair core outside the entrance to each floor which meant that this location was not suitable for camera installations. Figure 2 shows a camera installed in the ceiling of the case study building and Figure 3 shows an image from the people counting software which displays a real-time view from one of the cameras and the most recent results from that camera.



Figure 2: An installed camera in the case study building

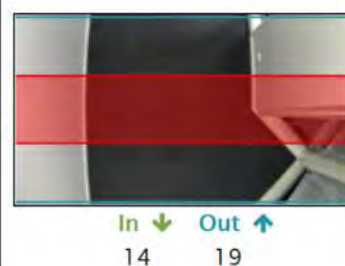

Figure3: An image from the people counting software

	In	Out
12 seconds ago	0	1
20 seconds ago	2	0
45 seconds ago	0	1
58 seconds ago	1	0
1 minute ago	2	3
2 minutes ago	2	2
4 minutes ago	1	0
6 minutes ago	3	3

Test accuracy

The study was carried out for the whole month of May 2016. May was suitable from an energy consumption point of view as it falls outside the hottest and coldest periods of the year. May was also suitable from an occupancy point of view as it was not affected by the Finnish summer holiday period which generally occurs from June to August. Thus the results for May should be a suitable representation of the whole year. Cameras were installed as the existing building systems were not considered adequate to count the number of building users accurately. A time card system is in place for the building users to clock in and out but it is not used by all employees and it is not used by visitors. RFID cards are used to open the doors to each floor in the building but this system could not be used to count people because of a tailgating problem. Tailgating is when where many people enter or leave the building after one person has unlocked the door with their card. The cameras were installed in the ceiling and pointed straight down so that the faces of the people passing beneath them could not be seen. This meant that privacy was less of an issue when compared to other security camera systems which are pointed directly at people

as they approach. This is an important point as it has been claimed by previous researchers that privacy is the main factor that prevents vision based occupancy monitoring from being widely implemented.

The purpose of the software is to count the number of people passing in real-time and also to calculate their direction of travel. The output file of each camera reports the number of people that travel in each direction for each 15 minute interval. The data from the cameras was then combined to calculate the number of people that occupied the case study area for each for each 15 minute interval of the month in question. The case study building is open for 16 hours each day from 06:00 - 22:00 and the counting software was reset to zero at midnight every night. One simple way of detecting error within the results of the counting software was to view the occupancy after 22:00. If the software reported that there was someone still occupying the studied area after 22:00 then it had failed to correctly detect all of the people that had left the studied area during the day and if the combined count was negative after 22:00 then it had failed to correctly detect all of the people that had entered the studied area during the day.

The energy consumption of the case study area during the month of May 2016 has been calculated by using the measured energy consumption for the whole building and proportioning this by area. The building is occupied by only one company and all areas have a similar function and utilisation rate and thus this was considered the best approach in the absence of sub-metering for the case study area. In addition to this, energy simulations were made to further understand the results of the occupancy measurements. The annual energy consumption of the building was calculated in order to examine the energy consumption of the case study open office with three alternative floor areas where each floor area relates to different workplace arrangement strategy. A full dynamic energy simulation was created using the programme IES Virtual Environment.

2.3 Post-processing of data

During the study it was observed that the results continuously reported a positive number of occupants after 22:00 and thus the software was not correctly detecting all of the people that had left the studied area during the day. In order to account for this error, the footage of one full day was observed for both cameras and a manual count was carried out. The comparison of the counting software and the manual count showed that the error was relatively evenly distributed over the whole day. It was observed that the error was not caused by a counting error at the times of the day when large groups of people enter or leave the space simultaneously such as the beginning of the day, at the beginning and end of lunchtime or in the evening. Based on this, following method for error correction was developed. Time periods with higher number of simultaneous passengers are presumed to have higher probability of counting error and therefore higher correction is applied to these periods, while for periods with lower number of simultaneous passengers, lower correction is presumed respectively. This not only removes the error but it also preserves occupancy profile.

3. RESULTS AND DISCUSSION

3.1 Space utilisation of the open office area

The measured peak occupancy of the open office area is particularly interesting with regard to the size of the area and required number of desks. The peak was measured on Tuesday the 10th of May and the occupancy curve for that day may be seen below in Figure 4. The open office area does not operate on a one desk per person policy and instead a desk sharing workplace arrangement strategy has been introduced to the area. In total there are 66 employees and the number of desks is 54. The result is an average desk allocation density of 8.85 m². When the peak day is used to compare the measured occupancy with the design occupancy we see that the peak measured occupancy of 44 people is 18.5% lower than the number of desks and that the measured occupancy is 33% lower than the total number of staff. It was also observed that the utilisation for all 5 weekdays is similar as may be seen by Figure 5 below.

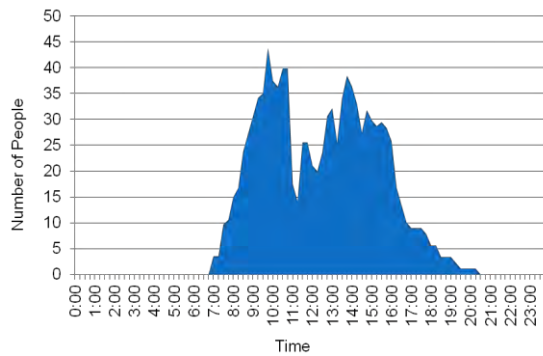

Figure 4: The peak occupancy rate of the open office area

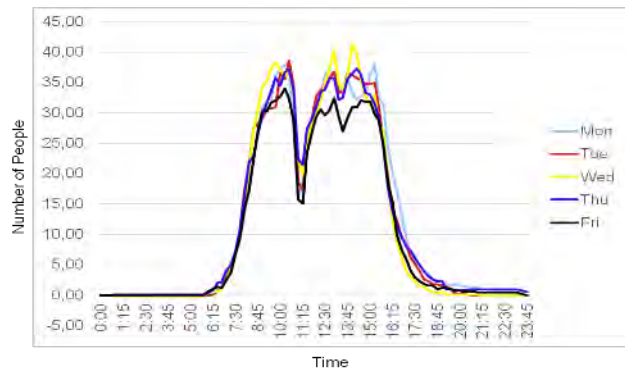

Figure 5: The average occupancy rate for each weekday of the case study area

3.2 Energy consumption for the day of peak occupancy

The collected data also enables the measured occupancy to be compared with the energy consumption of the case study building and this in turn enables the logic of the building management system (BMS) schedules and **the overall control strategy of the building's energy consuming systems to be interrogated. By comparing the occupancy curve and the energy consumption curve we can see when energy was consumed and this can be compared to the level of occupancy. This is demonstrated by Figure 6 below. It is important to note that the figure below shows the percentage that each hour contributes to the total energy consumption for the peak occupancy day. The figure below also shows the percentage that each hour contributes to the total person hours for that day. For example, it can be seen that 27.4% of the energy is consumed from midnight to 07:00 and 21:00 to midnight when the area is unoccupied and 34.1% of the energy is consumed from midnight to 07:00 and 19:00 to midnight when the occupancy rate is less than 1% of the total person hours per day.**

The breakdown of the energy consumption suggests that the heating consumption is relatively steady over the course of the whole day and this can be explained by a background heating demand in the night-time and a moderate load in the day-time as the internal gains from people, equipment and lighting assist the heating of the building. The electricity consumption has been subdivided into lighting, small power, ventilation and cooling and the comparison of these consumptions with the level of occupancy may be seen below in Figure 7.

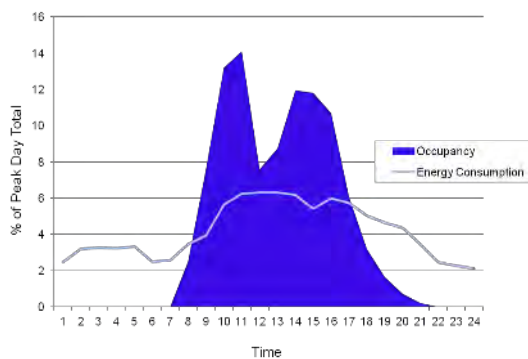

Figure 6: The proportion of total (Heating and Electricity) energy consumption and the occupancy rate for each hour of the peak occupancy day

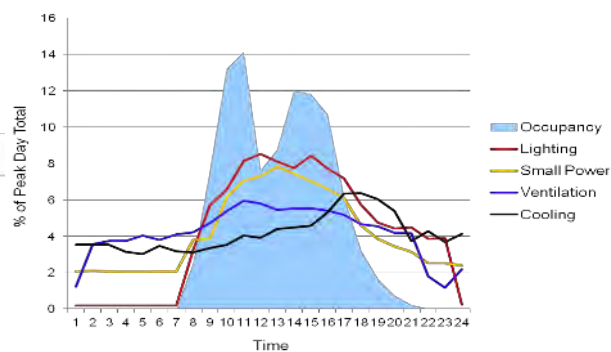

Figure 7: The proportion of the electrical energy consumption and the occupancy rate for each hour of the peak occupancy day

From the evidence provided by Figure 7 it can be deduced that the lighting control systems are suitably configured in the morning (00:00-07:00) but less so in the night-time (21:00-00:00). Also there is surprisingly high small power load, ventilation and cooling load outside of the buildings operational hours (06:00-22:00). It is typical to heat buildings at night-time but it can be expected that the electrical loads are easier to switch off outside the operational hours. Furthermore, if we apply the same comparison to the electrical consumption that was done to the energy consumption above we see that: 23.7% of the electrical energy is consumed from midnight to 07:00 and 21:00 to midnight when the area is unoccupied and 31.6% of the electrical energy is consumed from midnight to 07:00 and 19:00 to midnight when the occupancy rate is less than 1% of the total person hours per day.

3.3 Energy consumption for the day of peak occupancy

The desk sharing workplace arrangement strategy of the open office area provided enough desks for 54 of the 66 staff and as a result the office space can assumed to be 18% smaller than if a desk had been provided for each employee. A dynamic energy simulation was used to compare the energy consumption implications of optimising the number of desks in office areas. In all, the energy consumption of three alternative open office areas were simulated. The first office area was 644 m² and represented the scenario where each member of staff was allocated a desk and the second office area was 527 m² and represented the studied open office area with 54 desks. The final simulation concerned an office area of 429 m² which represented the scenario where the number of desks matched the measured peak occupancy of the open office area which was 44 people. The energy consumption of all three areas can be seen in Table 1 below.

The results show that optimising the size of the occupied area has a substantial impact on energy consumption. The current policy of providing 54 desks for 66 people has reduced the energy consumption by 14% compared to the calculated energy consumption of the traditional one desk per person strategy. However, our calculations show that the energy consumption could be reduced by a further 16% if the number of desks were to match the measured peak occupancy.

Simulation	Number of Employees	Number of Desks		Area		Annual Energy Consumption	
#	#	#	(%)	(m ²)	(%)	(MWh)	%
1	66	66	100	644	100	85,6	100
2	66	54	82	527	82	73,2	86
3	66	44	67	429	67	59,6	70

Table 1: The energy simulation results for the open office area

4. CONCLUSION

The original objective of this study was to explore if occupancy data can assist the implementation of resource efficiency and energy efficiency strategies in existing buildings. It is acknowledged that the data is difficult to obtain, however, it was demonstrated that usage patterns are an important factor in understanding the energy consumption of a building.

It has been shown that daily occupancy curves add valuable information regarding the control strategies of the energy using systems in office buildings. The case study building is open from 06:00-22:00 and it is important to understand if the building is occupied for the whole day. It is clear that the building is very likely to be occupied from 09:00-17:00 but without occupancy data it is impossible to accurately know the occupancy rates at the beginning and end of the day. The schedules of the energy consuming systems can be optimised based on the collected data. It is common place for the energy consuming systems to have schedules but maybe the spaces could have schedules too. New workplace arrangement strategies are emerging all the time and they are being driven by the rise of remote working and new hot desking strategies such as coworking. In offices that practice desk sharing it can be assumed that all employees have laptops and can sit at any desk. With this in mind one future area of research shall be to examine the benefits of gradually shutting down the building. For example instead of having the whole building open from 06:00-22:00, two of the three floors could be shut down from 18:00 onwards as at this time the occupancy rate is less than 10% of the peak occupancy.

The peak occupancy rate of the individual building areas is also a valuable piece of information and in a building with desk sharing it can be used to calculate the minimum number of workplaces that should be available. The fact that only providing 44 desks for 66 employees reduces the energy consumption by 30% shows that the amount of area that is reserved is a key driver in the energy consumption of offices. Resource efficient workplace arrangement strategies that focus on space optimisation reduce costs associated with rent and energy and also reduce the environmental impact of buildings through energy reduction and through the reduced need for new buildings.

Another emerging strategy is to rent out unused spaces in commercial buildings to the public via sharing economy websites which essentially act as the AirBnB of commercial buildings. There are already a number of these

websites such as Eventup, Splacer, Venuetastic, Venuu, and Flextila. Occupancy data can show the building managers when their spaces are empty and thus are available to be offered online.

One clear limitation of this study was that the area in which occupancy was measured was a small portion of the case study building. If the occupancy of the whole building could have been measured then the energy consumption of the studied area could have been more accurately calculated. The small case study area also contributed to the weekend occupancy being difficult to measure. It was observed that the daily energy consumption at the weekend is approximately 30% of typical weekday total and it is estimated that the peak occupancy is less than 5% but the occupancy could not be accurately calculated. Further studies are required to understand the strategies that could be employed in order to reduce the environmental impact of the weekend days as the building must be able to operate as normal but that occupancy rates are very low.

ACKNOWLEDGEMENTS

This research has been supported by the New TREND research project (www.newtrend-project.eu) which has been funded by the European Commission's Horizon 2020 research framework programme.

REFERENCES

- [1] British Council for Offices, 2013. Occupier Density Study
- [2] Brunia, S., De Been, I., van der Voordt, T.J.M., 2016. Accommodating new ways of working: lessons from best practices and worst cases. *Journal of Corporate Real Estate*, 18(1), 30 – 47
- [3] Cole, R.J., 2001. Lessons learned, future directions and issues for GBC. *Building Research & Creative Commons Korea*, 2014. Share Hub Annual Report
- [4] Dascalaki, E. G., Droutsas, K., Gaglia, A. G., Kontoyiannidis, S. and Balaras, C. A., 2010. Data collection and analysis of the building stock and its energy performance—An example for Hellenic buildings. *Energy and Buildings*, 42, 1231-1237
- [6] **Dooley, K., 2011, "New Ways of Working: Linking Energy Consumption to People", paper presented at the 6th World Sustainable Building Conference, Helsinki, Finland, 18-21 October**
- [7] Ekstrand, M., Damman, S., 2016. Front and backstage in the workplace: An explorative case study on activity based working and employee perceptions of control over work-related demands. *Journal of Facilities Management*, 14(2), 188-202
- [8] European Commission, 2011. A Roadmap for moving to a competitive low carbon economy in 2050
- [9] European Committee for Standardization, 2011. EN 15643-2:2011: Framework for the assessment of environmental performance.
- [10] Finnish Ministry of the Environment, 2012. Energy Efficiency of Buildings: Regulations and guidelines
- [11] Harris, R., 2016. New organisations and new workplaces: Implications for workplace design and management. *Journal of Corporate Real Estate*, 18(1), 4-16
- [12] **Huovila, A., Tyni, A. and Dooley, K., 2013. "Building occupancy as an aspect of energy efficiency", paper presented at Sustainable Building 13 Conference, Dubai, UAE, December 8-10**
- [13] *Information* 29(5), 355–373
- [14] Kim, J., Candido, C., Thomas, L. and de Dear, R., 2016. Desk ownership in the workplace: The effect of non-territorial working on employee workplace satisfaction, perceived productivity and health. *Building and Environment*, 103, 203-214
- [15] Korolija, I., Marjanovic-Halburd, L., Zhang, Y. and Hanby, V.I., 2013. UK office buildings archetypal model as methodological approach in development of regression models for predicting building energy consumption from heating and cooling demands. *Energy and Buildings*, 60, 152–162
- [16] Li, N., Calis, G. and Becerik-Gerber, B., 2012. Measuring and monitoring occupancy with an RFID based system for demand-driven HVAC operations. *Automation in Construction*, 24, 89–99
- [17] Nguyen, T.A. and Aiello, M., 2013. Energy intelligent buildings based on user activity: A survey. *Energy and Buildings*, 56, 244–257
- [18] Petrulaitiene, V., Jylhä, T., 2015. The perceived value of workplace concepts for organisations. *Journal of Corporate Real Estate*, 17(4), 260–281
- [19] Rapal, Space efficiency and space satisfaction in the Helsinki region [online]. Retrieved from: <http://rapal.fi/wp-content/uploads/2014/10/Space-efficiency-and-satisfaction-in-the-Helsinki-region.pdf> [Retrieved on 22 September 2015].

- [20] Sekki, T., Airaksinen, M. and Saari, A., 2015. Impact of building usage and occupancy on energy consumption in Finnish daycare and school buildings. *Energy and Buildings*, 105, 247–257

Session 6.12: Green Buildings – Occupants' Perspectives

Sculpting Socially Sustainable Neighbourhoods

Franklin YU^a

^a Singular Studio Limited, Hong Kong SAR, franklinyu@singularstudio.hk

ABSTRACT

The paper aims to illustrate, by way of examples, that through careful planning and design in the early stages of developing or renewing a neighbourhood/ building, a socially sustainable outcome can be achieved, and that the key to social sustainability is choice – choice in the activities to pursue, in the ways of attaining environmental **comfort, in the modes of transportation, etc.** Calling this kind of built environment “architecture of choice”, the paper also points the direction in which public spaces like parks and harbourfront promenades can be developed with this “architecture of choice” theory.

Examples used in the paper include the following and other cases, wherein the hardware facilitates users to pursue a multitude of activities with the same or different groups of people in a low-carbon-footprint way and thus helps achieving social sustainability in the neighbourhood:

- In a building for interdisciplinary research, an open staircase links the ground level to the open lobbies on each and every floor as well as the social spaces at G/F, 4/F and the roof garden. Coupled with the open campus policy, the cosy common areas contribute to the community through introduction of the quality public open spaces. Apart from being used for hanging out and having lunches, the social spaces provide comfortable, naturally ventilated gathering areas. They also provide visual cues to induce people to use the open staircase instead of the lifts.
- In a district park, the facilities allow a myriad of active and passive uses, including playing football, roller blading, jogging, lying on the grass, admiring the scenery and water features, climbing a knoll along the stairs or the gentle ramps, learning about Chinese medicinal herbs and traditional exercises in the outdoor areas or indoor exhibition centre, etc. This has encouraged people of different ages having different interests to come together as a community.

Keywords: choice, sustainable neighbourhood, social sustainability

1. INTRODUCTION

Time and expertise are both our valuable resources. While it seems the more we spend time the less it remains, the more we use our expertise the deeper and better it gets. So it seems a good use of our time would be to apply our expertise in bettering the community, in making synergy out of valuable resources.

Have you ever wondered:

Why can't we bike along the Harbourfront in Hong Kong? Why are some of the parks so barren and lifeless, despite **being full of plants and seats**? **Why do most tall buildings in Hong Kong look much alike**? **Why don't we see green terraces** on them, not to mention covered community spaces?

2. HARBOURFRONT PROMENADE

One reason things are not what they can be is that we are bound, in one way or another, by regulations, guidelines, practices, etc. that are simply not suitable for the present time anymore. Involvement in government committees reveals that things **would spring to life if we could just loosen the ties**. An example: **Hong Kong government's** current guidelines state that a cycle track cannot be put onto an Emergency Vehicular Access (EVA). This means there is no cycle track along the harbourfront since usually there is not enough width for a separate EVA and a cycle track, and the former takes precedence. It has taken us years, but once we convince the administration departments there are no reasons why the two cannot be combined, a much more vibrant harbourfront becomes

possible. In time, hopefully, a lively and inclusive waterfront (see Figure 1 taken at River Garonne in the Bordeaux region in France) can appear in Tsuen Wan, Wan Chai, and other areas in Hong Kong.



Figure 1

3. DISTRICT PARK

Mixing uses can be interesting. In a district park, we have put in the same place different passive and active programmatic elements like pavilions, water features, themed landscape, walking trails, jogging paths, children play equipment, etc. and we have added a lawn with a small knoll (Figure 2). Although this cross-programming **configuration was not required in the client's brief, it has enabled a more inclusive use of the park by the community** — on a workday, a retired grandpa in a wheelchair brings his granddaughter to play in the park, and while keeping an eye on her, he chats with friends practicing tai chi on the lawn. We could only marvel at the impact on children the players in the nearby skate park have, were it not merely visually connected with but fully integrated into the main area! What makes a park attractive are indeed different people doing what they like harmoniously, and much more than plants and seats, programming plays an important part.



Figure 2

4. CREMATORIUM

Examining the client's brief with respect to specific site conditions can also yield unexpected results. In re-providing a functional crematorium, taking advantage of the sloping topography, we have put the service halls on the lower level and lumped the “servant spaces” on one side, creating a garden on the roof of the service halls at the same level as the adjacent existing footpath, which is 7m above (Figure 3). Freeing up the area on top of the services halls has created a more spiritual setting, with sunlight coming down at the altar from the skylights. At the upper level, people walking on the footpath to and from columbaria can enjoy the view and can actually use the landscaped roof garden, which was not a planned facility at the onset of the project.



Figure 3

5. BUILDING FOR INTERDISCIPLINARY RESEARCH

Given the constraints of economic considerations, most building owners will choose to provide facilities and features that are not “saleable” or “rentable” only if they are not accountable for Gross Floor Area (GFA), as accepted by the government departments. This is why we rarely see in Hong Kong interesting sun-shading devices, double-skin facades, sky gardens, deep overhangs, large voids, slanting walls, etc. — facilities and features that can make a building charming and sustainable both socially and environmentally. In a building for interdisciplinary research, we designed an open staircase linking the ground level to the open lobbies on each and every floor as

well as the “social spaces” at G/F (double volume), 4/F (triple volume) and the roof garden (see Figure 4). While not required in the client’s brief, coupled with the open campus policy of the institution, the cosy common areas, the roof garden, and the external planters continuous from G/F to the roof have contributed to the community through introduction of quality public spaces. The common areas also serve as semi-open dining areas in the lunch hours, and tables and chairs are put there for people to hang out. The open staircase stands as a symbol inviting the community to go up the building and use it. But all of these are possible only because the client agrees to such a vision and allocate GFA accordingly. In the meanwhile, architects are still working hard to let the government departments understand why the benefits of the above facilities and features far outweigh the potential shortcomings of abuse and why they are worth promoting, much like what has been done in other countries.



Figure 87

6. CONCLUSION

Apart from fulfilling the client’s explicit brief, an architect’s mission would include providing people with choice—choice in where to go to in a place and how, what to do there, and how to enjoy and use the place (maybe this would not apply to a prison). This architecture of choice is essential, as illustrated above, in creating socially sustainable neighbourhoods. And so in designing places to be more inclusive, in providing auxiliary community facilities without much additional cost, and in extending common and public areas into the community, we may find another layer of meaning to our work. As more clients embrace environmental and social sustainability, we can be optimistic for what lies in the future.

It is unnecessary to confine using our expertise only in work and straitjacket its usage. On the contrary, good things usually happen when we employ our expertise beyond prescription and extend it into the community.

REFERENCES

- [1] Children did use the park creatively, as shown in the video at https://www.youtube.com/watch?v=11gEcyF9z_w [Retrieved on 30 September 2016].
- [2] Extracted and modified from <http://www.dailymail.co.uk/travel/article-2251857/France-cycling-holidays-Around-Bordeaux-wheels.html> [Retrieved on 30 September 2016].

Thermal Comfort Based Occupancy-driven Building Energy Saving Control Strategies

ZHANG Cheng^a, Mehdi PAZHOOHESH^b

^a Xi'an Jiaotong-Liverpool University, Mainland China, cheng.zhang@xjtlu.edu.cn

^b Xi'an Jiaotong-Liverpool University, Mainland China, mehdi.pazhoohesh@xjtlu.edu.cn

ABSTRACT

Current air conditioning systems often rely on maximum occupancy assumptions and fixed schedules to maintain sufficient comfort level. Having knowledge regarding occupancy situation may lead to significant energy-savings in a building. Therefore, the present research proposes a method to investigate an occupancy-driven HVAC control system based on thermal comfort analysis. Computational Fluid Dynamics (CFD) is used to evaluate thermal comfort through modeling the indoor air distribution and flows. Wind velocity and temperature are simulated in several scenarios and the Predicted Mean Vote (PMV) and the Predicted Percentage Dissatisfied (PPD) are **computed. The simulation results are verified through a survey asking for occupants' real feelings and** consequently thermal comfort profiles are identified, which are used for possible energy saving. Moreover, a pre-defined working schedule and historical behavior of persons are utilized to develop a pattern for predicting personal occupancy situations. Finally, all variables are imported to an intelligent system to fulfil an intelligent control of air conditioning system. The result shows a good potential to reduce energy consumption while meeting comfort requirements of occupants.

Keywords: thermal comfort, occupancy-driven, HVAC (heating, ventilating, and air conditioning)

1. INTRODUCTION

Increasingly expensive and polluting sources of energy dictate the need of energy conservation in the society. Building sector is responsible for high portion of energy consumption throughout the world (Lajoie et al., 2015; Magdalena et al., 2013). According to the European Union report, 40% of the total energy was consumed in the building sector, while HVAC systems contribute to a significant energy usage in buildings (Lajoie et al., 2015). Therefore, well-designed building ventilation systems can greatly reduce the energy consumption. Meanwhile, about 90% life of an average individual is spent in the indoor environment. A good indoor environment is essential for good productivity, less vacancy, and better health. Thermal comfort is an important factor that is considered to evaluate the indoor environment quality. The assessment of thermal comfort in offices showed that good thermal comfort level delivered more satisfaction for the occupants, and also improved their performance. American Society of Heating, Refrigeration and Air-Conditioning Engineers (ASHRAE) defines Thermal Comfort as the condition of mind which expresses satisfaction with the thermal environment. Well-designed building ventilation systems not only lead to reduction of energy consumption, but also should provide satisfaction for building occupants. However, due to unpredictable locations of the occupants during design stage, the fixed locations of ventilation systems, outlets, doors, and windows give little options to the occupants during operation stage. Therefore, more focus should be put on methods that can maintain the comfort level to occupants with minimum energy usage.

2. LITERATURE REVIEW

A lot of **research has focused on energy saving based on occupants' locations.** Marshall et al. (2016) investigated different occupancy patterns and calculated energy saving based on these patterns in residential buildings. Klein et al. (2012) introduced a multi-agent based system which also considers the location of users by using RFID tags. However, the above mentioned research did not evaluate the thermal comfort level of occupants which is the main goal of energy usage in a building. **The 'feeling comfortable' was** very personally and cannot be characterized objectively due to the differences of physiological and psychological for individuals. According to Fanger (1970), there are six major parameters that are needed to be considered to achieve a satisfied thermal level which are, dry bulb temperature, water vapour pressure, air velocity, radiant temperature, metabolic rate, and clothing. These factors are determined by analyzing the whole body satisfaction and local discomfort. Simulation based on relevant parameters is used to analyze and improve thermal comfort. Computational Fluid Dynamics (CFD) is known as the most reliable method for simulation and evaluation in industry sectors, especially for indoor environment. But

the accuracy of its predictions is a main challenge as the simulation is based on the highest capacity of thermal loads in each environment and we have some other variables such as occupied areas during a working day. Lajoie et al. (2015) utilized CFD to provide accurate description for the indoor air quality, where three parameters, i.e. wind velocity, indoor temperature and air age, were considered to simulate wall-hanging air conditioning systems. Chiang et al. (2012) evaluated the impact of radiant cooling ceiling and mechanical ventilation systems on the thermal comfort using CFD modeling. Magdalena et al., (2013) discussed the calibrated CFD model in a highly-glazed meeting room with natural ventilation.

Based on the literature review, it is found that an intelligent control is lack of investigation to meet energy saving purpose while providing satisfactory thermal comfort to occupants. Therefore, the present research proposes an **assessment of thermal comfort based on the locations of HVAC system and the occupant's location information** collected in real time. By establishing CFD models, wind velocity and temperature are simulated in a room to obtain the Predicted Mean Vote (PMV) and the Predicted Percentage Dissatisfied (PPD). A flowchart of intelligent control of the HVAC system is developed **based on the comfort areas, occupants' working patterns, etc. to investigate possible energy saving. The integration of occupant's location-based system and thermal comfort assessment** provides a deeper view of intelligent energy management systems not only based on energy saving but also considering the comfort level of occupants.

3. METHODOLOGY

The proposed methodology of this research is divided into two parts as shown in Figure 1. The purpose of the first part is to identify thermal zones from the building plan based on thermal comfort models. The geometry data of the area were retrieved from a building information model (BIM). Temperature sensors and location sensors are used to collect environmental temperature and the occupancy situation of persons. All the data are imported to the CFD model and simulation is done to analyze the comfort level at different zones. As the simulation is a time consuming process, it is not possible to model thermal comfort in real time. Therefore, based on the HVAC performances and modeling results, scenarios and corresponding control have been developed. To improve the accuracy of simulation-based thermal zones analysis, a survey has been done to investigate the individual's real feelings and how they match the simulation results, so that the boundaries of thermal zones can be identified.

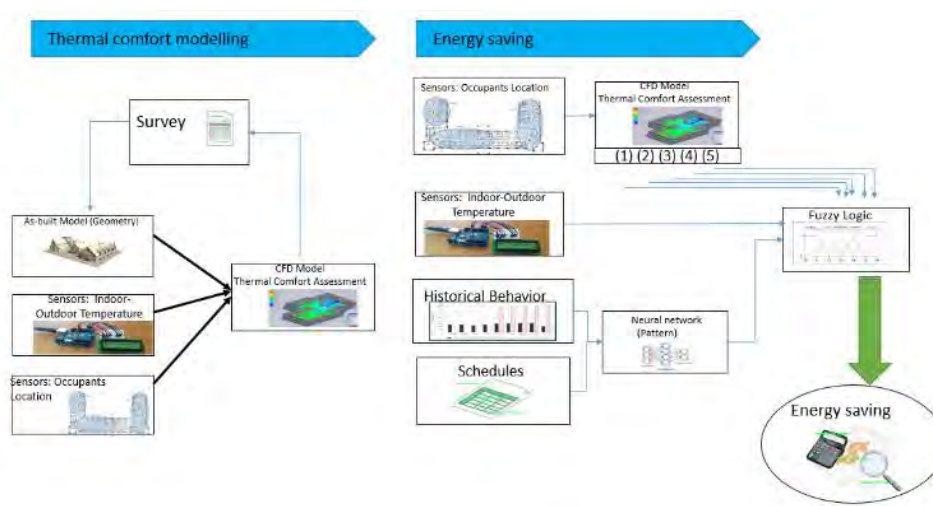

Figure 1: Proposed methodology

For the second part, four variables are considered to develop the occupancy-driven control strategies, which are: (i) the real-time locations of persons are monitored by using an indoor tracking system based on Zigbee technology. **Further details of this localization system can be found in the authors' previous research;** (ii) five types of individual situations are considered based on the location of the occupants and the duration of their activities: wandering, working in office, short-term leaving (e.g. coffee room), long-term leaving (e.g. meeting room, class room), and leaving the building. Based on these situations, the system distinguishes whether the occupant leaves the office for a short or long time, and consequently controls the operation of HVAC systems; (iii) indoor and outdoor temperatures are used to control HVAC systems and maintain comfort temperature; and (iv) historical behavior of persons and schedules of working time are also considered. A behavior pattern of individuals is created based on

historical data and is combined with schedules of working hours. A neural network pattern is developed to predict **individuals' working time and the duration of** presence time in the office. Finally, a fuzzy-based system is developed to integrate all variables and control the HVAC systems in a way that meets both energy efficiency and thermal comfort requirements.

4. INTELLEAGENT CONTROL

The present paper is to propose an intelligent control of HVAC system based on occupants' locations, behaviors and thermal comfort to improve the energy efficiency; therefore, the awareness of locations of occupants is essential, which is facilitated by a Real-time Location System using ZigBee nodes installed inside the office rooms. The decision of which HVAC system should be turned on/off is taken by the main server at the Facility Management office that is connected with a ZigBee receiver. The details of this system are beyond the scope of this paper therefore not presented here. Based on the thermal zones identified, simple control can be applied to turn on/off corresponding HVAC outlets according to the presence of persons in those thermal zones. Real-time data are **collected for persons' presence in the room and combined with their historical behavior to predict the time period** of their presence/absence for more intelligent control and energy saving.

Historical behavioral data of occupants

Figure 2 illustrates the occupancy data of office with nine persons. Figure 2(a) represents the occupancy behaviour of one user for one week from 6 AM to 8 PM.

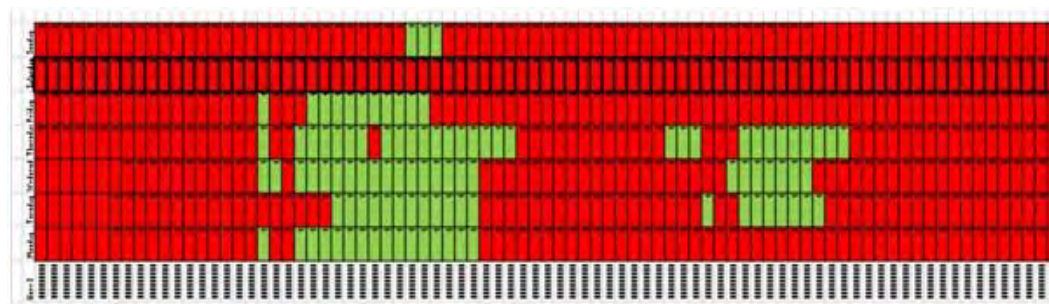

(a) One week occupancy data for one person

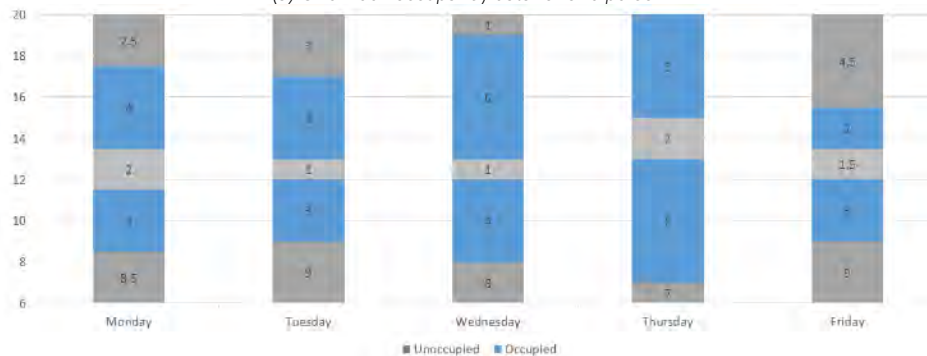

(b) One month occupancy patterns of individuals

Figure 2: Occupancy data

The red colour shows the absent periods while green colour shows presence periods. Data collected for one month provide historical data for behavioural patterns development (Figure 2(b)). The pattern of historical behavior of **persons is combined with the persons' real-time** location and corresponding thermal zones to enable the intelligent fuzzy-based HVAC control. Five types of individual situations are introduced: wandering, working in office, short-term leaving, long-term leaving, and leaving the building. These conditions are considered for the intelligent system to predict the period of time when each person leaves the office. More than 180 rules are developed to utilize the fuzzy decision making.

Intelligent control

Figure 3 illustrates the process of controlling HVAC system based on the person's occupancy situation. Any exit/entrance from/to the room will be monitored. When one person enters into the room or leaves the room, the information of person and related thermal zone are identified. Afterwards, the corresponding behavioral pattern and schedules are considered to predict the duration of this changes.

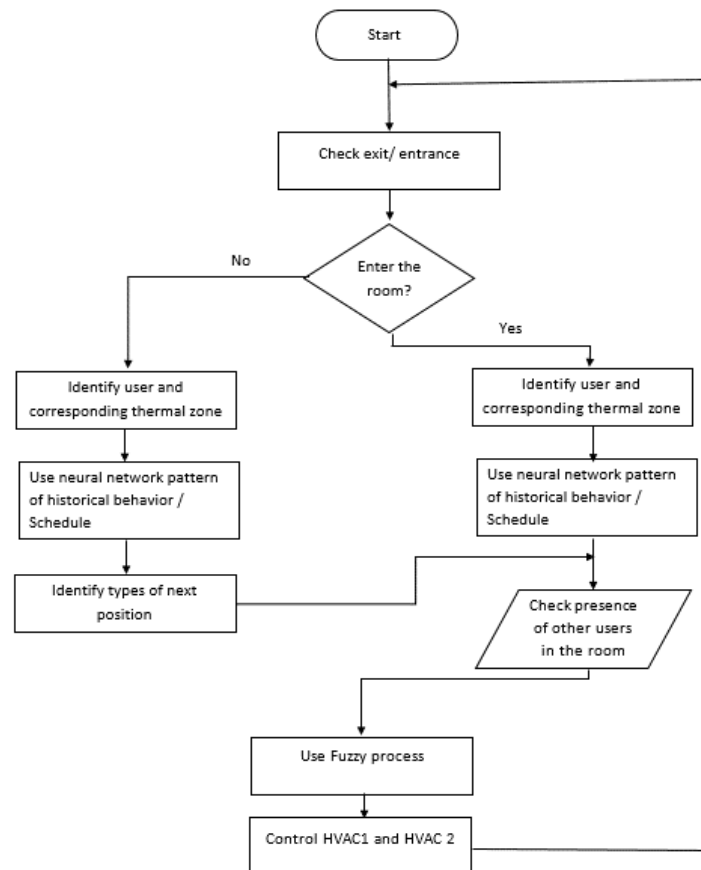

Figure 3: Flowchart of intelligent control

By considering the other persons in the thermal zone and the current situation of HVAC outlets, decisions are made to control the corresponding HVAC outlets. Figure 4 illustrates the HVAC performance during one day. The green and black lines represent the base-line and blue and red lines show the implemented intelligent control result. It is obvious that some times during the day, the controller decided to turn off HVACs based on the introduced rules. For instance, during 12:00 PM to 14:00 PM while all occupants left the room, HVAC 1 was kept on by users which resulted in wasting energy for two hours. However, intelligent controller decided to turn off all HVACs based on data extracted from the real-time and historical information.

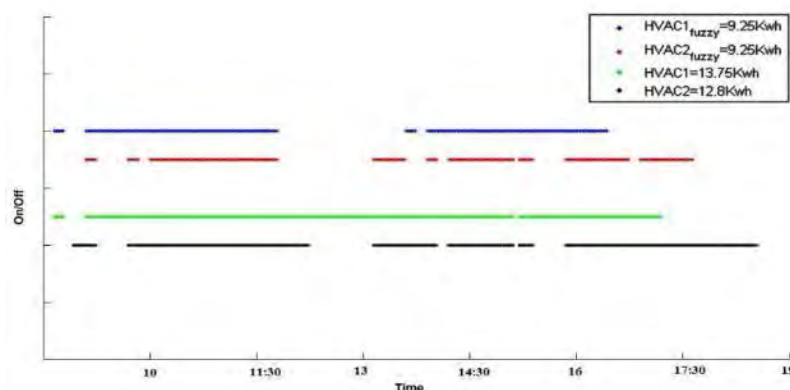

Figure 4: Energy consumption for base-line and occupancy-driven HVAC outlets

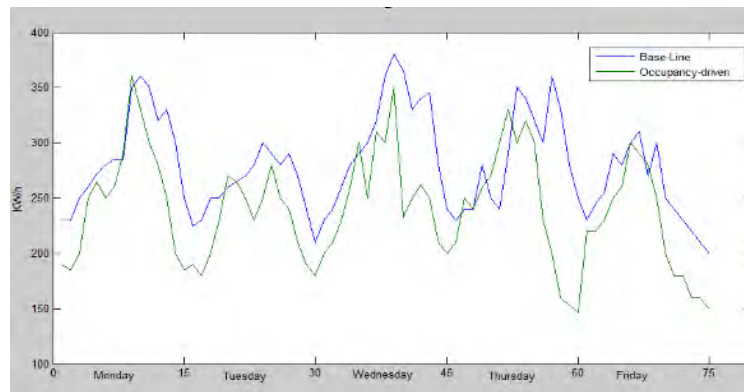

Figure 5: Energy consumption for base-line and occupancy-driven HVAC outlets

Figure 5 illustrates the base-line energy consumption and the energy consumed when applying the occupancy-driven intelligent controlled HVAC system for the test bed office during one week. This graph demonstrates that less energy is consumed by the occupancy-driven system.

5. CONCLUSIONS AND FUTURE WORK

This paper proposes intelligent control strategies by developing a CFD model for the air distribution and flow, calculating the PMV and PPD values, and identifying areas with the higher potential of discomfort and comfort level. Surveys are carried out to investigate the real feelings of the occupants under different situation to verify the simulation results. The test bed area is divided into several thermal zones and corresponding control strategies are developed for intelligent control purpose. Moreover, from historical behavior of persons and their timetables, **behavioral patterns are created to predict persons' occupancy situation in the room. The real-time locations of the persons are combined with their historical behavior data so that the persons' occupancy situation in the room can be predicted.** The system then evaluates all the variables and controls the situation of corresponding HVAC outlets. The results show the potential of occupancy-driven central air conditioner to undertake indoor heat load and provide suitable thermal comfort. Our future work can be focusing on utilizing different sensors to investigate the passive control of HVAC outlets and providing higher comfort level for persons and saving more energy simultaneously.

REFERENCES

- [1] Chiang, W.H., Wang, C.Y., and Huang, J.S., 2012. Evaluation of cooling ceiling and mechanical ventilation systems on thermal comfort using CFD study in an office for subtropical region. *Building and Environment*, 48(1), 113-127.
- [2] Fanger, P., 1970. *Thermal comfort, analysis and application in environmental engineering*. Copenhagen: Danish Technical Press.
- [3] Klein, L., Kwak, J., Kavulya, G., Jazizadeh, F., Becerik-Gerber, B., and Tambe, M. 2012. Coordinating occupant behavior for building energy and comfort management using multi-agent system. *Automation in Construction*, 22, 525–536.
- [4] Lajoie, P., Aubin, D., Gingras, V., Daigneault, P., Ducharme, F., Gauvin, D., Fugler, D., Leclerc, J., Won, D., Courteau, M., Gingras, S., Héroux, M., Yang, W., and Schleibinger, H., 2015. "The IVAIRE project – a randomized controlled study of the impact of ventilation on indoor air quality and the respiratory symptoms of asthmatic children in single family homes," *Indoor Air*, 25(6), 582-597.
- [5] Magdalena, H., Marco, G., and Marcus, M., 2013. Calibrated CFD simulation to evaluate thermal comfort in a highly-glazed naturally ventilated room. *Building and Environment*, 70, 73-89.
- [6] Marshall, E., Steinberger, J., Dupont, V., and Foxon, T., 2016. Combining energy efficiency measure approaches and occupancy patterns in building modelling in the UK residential context. *Energy and Buildings*, 111, 98–108.

The Effect of Occupant Behaviour on Real-time Electricity Consumption in Canadian School Spaces

Mohamed OUF^a, Mohamed H. ISSA^b

^a University of Manitoba, Canada, oufm@myumanitoba.ca

^b University of Manitoba, Canada, mohamed.issa@umanitoba.ca

ABSTRACT

Studies on sustainable and green buildings reveal mixed results regarding their energy performance. While many of these buildings demonstrate significant savings in gas consumption, previous studies indicated their electricity consumption is increasing in comparison with older buildings. These results highlight the importance of **investigating parameters influencing buildings' electricity consumption in order** to close the performance gap in new and sustainable buildings. The majority of previous studies focused on commercial or residential buildings emphasizing the need to investigate energy consumption in other building types. Therefore, this study analyzed historical energy consumption in a sample of thirty schools in Manitoba. It indicated the decrease in gas consumption for heating in new schools was counteracted by a statistically significant increase in their electricity consumption. Three cases study schools were then selected for further analysis of electricity consumption. Within each school, one classroom and the gymnasium, as well as spaces with significant community use, were sub-metered to collect real-time electricity consumption data. Occupant behaviour was also monitored simultaneously in these spaces to demonstrate its effect on electricity consumption. Results indicated total electricity consumption increased in the newest school, although sub-metered spaces in older schools showed higher electricity consumption. The study also indicated occupant behaviour influenced variations in electricity consumption between sub-metered classrooms. It is the first to provide in-depth investigations of electricity consumption in Canadian school buildings to identify reasons behind their increased electricity consumption.

Keywords: energy efficiency, school buildings, energy management, sustainability, occupancy and energy performance

1. INTRODUCTION

The building industry accounts for 20-40% of energy use worldwide, representing an excellent opportunity to achieve large-scale energy reductions. Advances in sustainable and green building technologies can help decrease their energy use by improving building envelopes and mechanical systems making them 25-30% more energy efficient on average than conventional ones. However, some studies indicated these buildings use more electricity than conventional ones e.g. [3], [4] which may be attributed to **occupants' behaviour**. Therefore, closing the gap between actual and **expected buildings' energy performance necessitates considering all parameters influencing buildings' energy consumption, including those related to occupancy and usage**. Previous studies focused on analyzing energy consumption in commercial or residential buildings, highlighting the need to analyze energy consumption in other building types. School buildings represent an excellent opportunity towards increasing **overall energy efficiency as they contribute to a considerable part of overall buildings' energy** consumption due to their large number within the building stock. These buildings "can also be used as communication means towards pupils and their families, thus educating many different society groups about sustainability in the built environment".

In order to evaluate energy performance in Manitoba's schools, this study entailed analyzing historical energy consumption in a randomly selected sample of thirty schools over 9 years. The analysis revealed newer schools used more electricity than older ones while using less gas annually, reinforcing the need to investigate their electricity consumption in more detail. Therefore, three case study schools in Manitoba, Canada were selected for analyzing their real-time electricity consumption over a period of 4 months. One of these schools was a new Leadership in Energy and Environmental Design (LEED) certified school built in 2009, a middle aged school built in 1968 and an old school building, built in 1951. The analysis entailed studying real-time electricity consumption in school spaces as well as occupant behaviour using several techniques. Specific objectives of this study involved 1) demonstrating the effect of school building age on their energy performance while controlling for school occupancy and floor area 2) demonstrating differences in electricity consumption between the three case-study

schools at the building and space levels 3) demonstrating differences in occupant behaviour related to energy consumption in the three case-study schools.

This study is the first to investigate real-time electricity consumption in Canadian school buildings. The analysis of real-time electricity consumption revealed large variations in electricity consumption between these schools which **could be attributed to occupants' behaviour**. The study results are, therefore, relevant to school divisions, **superintendents and operators looking to decrease schools' energy consumption by targeting specific occupant activities** which contribute to wasteful energy consumption. Since existing buildings represent the vast majority of the current building stock, decreasing occupant-related electricity consumption presents a great opportunity for **decreasing the building stock's overall energy consumption**.

2. BACKGROUND

Several studies found large discrepancies in energy consumption between similar buildings, speculating about the contribution of building occupants to these differences e.g. [9], [10]. Many of these studies showed green buildings may not perform as intended with respect to energy efficiency e.g. [1], [11], [12]. In many instances, actual energy use exceeded design estimates from energy models raising concerns about their accuracy especially when **predicting occupants' behaviour**. However, **relatively few studies investigated the effect of occupants' behaviour** on energy consumption and mostly focused on commercial buildings. The majority of these studies monitored real-time energy consumption to estimate occupant behaviour, with even fewer studies directly monitoring occupant behaviour. In these studies, analysis mostly focused on behaviour related to heating, ventilation and air-conditioning (HVAC) energy consumption as opposed to other end-uses.

Studies that measured actual real-time energy consumption entailed sub-metering specific building spaces, mostly with no further breakdown of end uses. For example, sub-metered floors within six commercial buildings and found 56% of their energy was consumed during non-business hours without specifying end-uses contributing to this finding. Similarly, [14] found 23% of the energy consumed by workstations in two office buildings occurred during non-business hours. After providing individual and group feedback to office employees regarding energy consumption, the study indicated power density in individual workspaces could decrease by 7-11% when occupants were informed about their energy consumption. [15] also showed that providing individual and group **feedback to building occupants regarding their energy consumption improved buildings' energy-efficiency**. Despite their strengths, these studies did not investigate specific end-uses with the highest effect on buildings' energy consumption and consequently their energy-efficiency.

For studies which investigated the effect of occupancy on buildings' energy consumption, they mostly estimated this effect using statistical methods. [16] Investigated energy consumption in a sample of 80 residential buildings over two years by grouping similar buildings into clusters using seven parameters not related to occupant behaviour. Using cluster analysis and grey-relational techniques, the study found significant variations in energy consumption among similar buildings and attributed these variations to occupant behaviour. Other studies used energy modelling tools to determine the effect of occupancy on energy consumption. By modifying occupancy input parameters in energy models, [17] concluded that occupancy could change annual energy consumption by 69 to 177% depending on building type and climate region. [18] found the relative standard deviation due to modelling extreme occupant actions can amount to 47%. Despite the value of these studies, most of them focused on how occupants affected HVAC energy consumption through occupant actions such as the use of blinds, window operations or clothing adjustments. However, these studies did not investigate the effect of occupants on real-time electricity consumption.

3. METHOD

This study entailed collecting data regarding schools' floor areas, dates of construction, number of students and teachers, as well as grade levels from 126 schools in four school divisions in Manitoba. The information was used to randomly select, using stratified random sampling and Neyman proportional allocation technique, a representative sample of thirty schools to be analyzed at a 90% confidence level. This is to create three groups of schools, with thirteen schools representing old schools built on or before 1959, thirteen middle-aged schools built between 1960 and 1989, and four new schools built on or after 1990 including one LEED-certified school. The cut-off dates used for these schools were based on the dates used by the United States Commercial Buildings Energy

Consumption Survey (CBECS 2003) for reporting energy consumption in buildings by year constructed. The study involved collecting and analyzing historical monthly gas and electricity consumption quantities and billing costs for these schools for the period between 2004 and 2013 to evaluate the effect of building age on energy consumption.

One school was then selected from each age category for analysis of total building electricity consumption, as well as space-level lighting and plug load consumption. Simultaneously, several tools were used to study occupant behaviour in spaces where electricity consumption was monitored. These tools included 1) sensors for logging half-hourly durations of light use and occupancy status in classrooms 2) observations of equipment and light use in school spaces 3) daily surveys completed by teachers documenting daily equipment use in classrooms. The monitored spaces were a south-facing classroom between grades 4 to 7, the gymnasium and one space typically used outside regular work hours in each school. Sub-meters were installed to monitor all lighting and plug loads circuits for the selected spaces in order to measure electricity consumption at half-hour intervals for the period between January and June 2015. Total building half-hourly electricity consumption was also obtained by downloading data from advanced utility meters in each school. Figure 1 shows a summary for the data collected for this study.

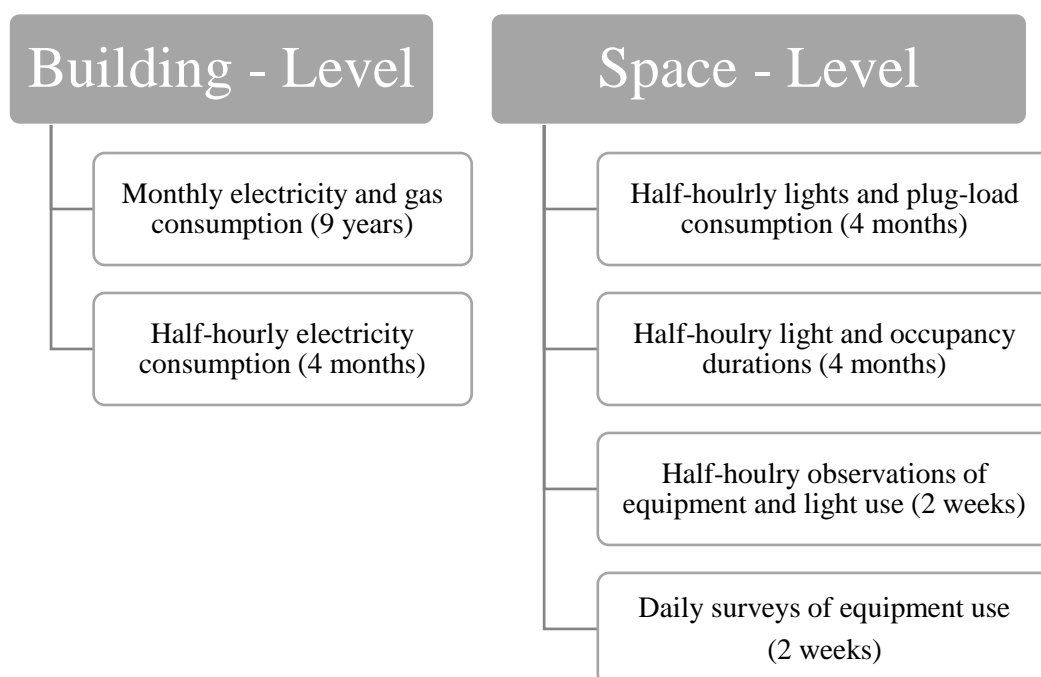

Figure 1: Summary of data collection methods.

Data analysis involved normalizing energy consumption by floor areas at the building and space-levels. Analysis of Covariance (ANCOVA) was used to investigate differences in annual electricity, gas and total energy consumption between the three age categories, after controlling for floor area and the number of occupants. For statistically significant differences, post hoc least significant difference (LSD) tests were used to assess the difference in means between every two age groups. Half-hourly electricity consumption data was used to calculate and compare the average daily electricity consumption for the entire schools, as well as classrooms between old, middle aged and new schools. Non-parametric tests were used to compare half-hourly electricity consumption between the three schools as this data did not follow normal distribution on a frequency plot.

Results presented in this paper focused on 1) analyzing the differences between the three school-age groups regarding their monthly electricity and gas consumption. 2) analyzing the differences in total building half-hourly electricity consumption between the three case-study schools 3) analyzing the differences in half-hourly electricity consumption for classrooms lighting between three case-study schools 4) analyzing the differences in light use durations between the three classrooms.

4. RESULTS

4.1 Historical energy consumption in Manitoba's schools

Figure 2 shows the average annual electricity consumption increased from old ($n = 13, 56.57 \pm 19.8 \text{ KWh/m}^2/\text{year}$), to middle aged (MA) ($n = 13, 116.26 \pm 48.7 \text{ KWh/m}^2/\text{year}$), to new ($n = 4, 126.27 \pm 29 \text{ KWh/m}^2/\text{year}$) school buildings. However, the average annual gas consumption followed the opposite trend where it decreased from old ($n = 12, 20.59 \pm 9.8 \text{ m}^3/\text{m}^2$), to middle aged ($n = 12, 16.58 \pm 7 \text{ m}^3/\text{m}^2$), to new ($n = 3, 12.66 \pm 3.5 \text{ m}^3/\text{m}^2$) school buildings, in that order. These results were in-line with previous studies which also showed new buildings used more electricity than older ones while using less gas annually e.g. [3], [4]. ANCOVA test results showed a statistically significant difference in electricity consumption quantities ($F(2, 25) = 5.22, p < .05$), but not in gas consumption quantities ($F(2, 25) = 100.53, p = 0.264$) between the three building age groups. Post-hoc LSD tests showed a statistically significant differences in electricity consumption quantities only between old schools and new schools, and between old schools and middle-aged ones, prompting further analysis of real-time electricity consumption.

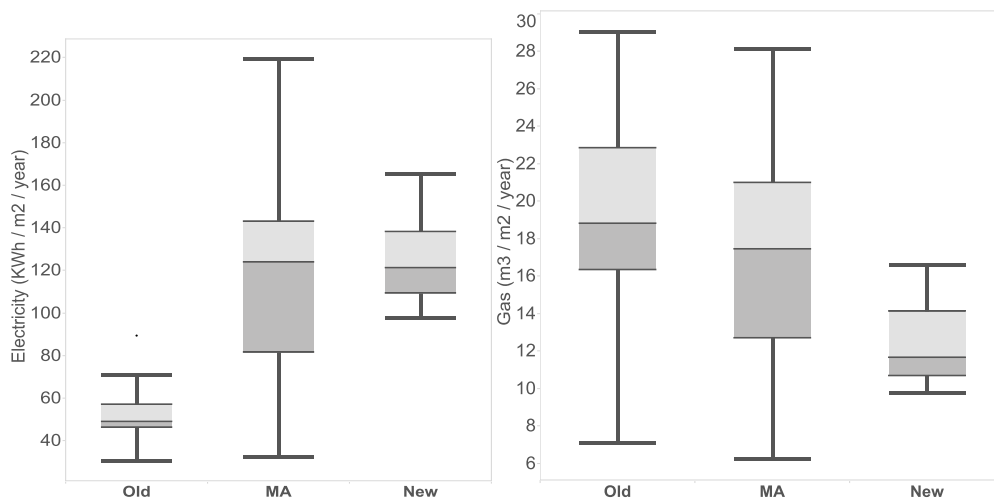

Figure 2: Annual electricity and gas consumption in Manitoba schools.

4.2 Electricity consumption in case-study schools

The analysis of the real-time building electricity consumption in the three case-study schools was in line with findings from the randomly selected school groups as shown in Figure 3. The new school used on average 48% more electricity on a daily basis ($0.54 \pm 0.24 \text{ KWh/m}^2/\text{day}$) than the middle aged school ($0.31 \pm 0.12 \text{ KWh/m}^2/\text{day}$) which used on average 82% more electricity on a daily basis than the old school ($0.17 \pm 0.03 \text{ KWh/m}^2/\text{day}$). The non-parametric Kruskal-Wallis H test showed statistically significant differences in total half-hourly electricity consumption between the three schools ($X^2(3) = 279.089, p < .005$).

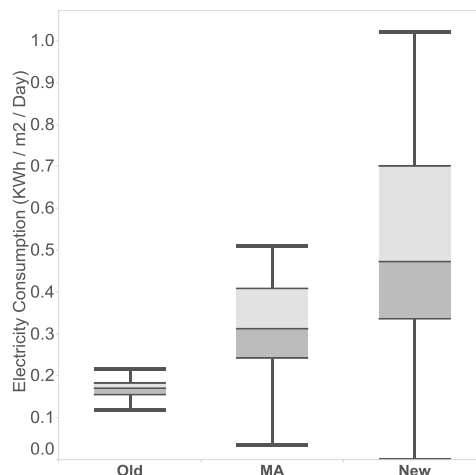

Figure 3: Daily electricity consumption in the three case-study schools.

4.3 Electricity consumption in case-study classrooms

Classrooms' electricity consumption in the three case-study schools did not follow the same trend as their total building electricity consumption. Daily plug load **and lighting electricity consumption was highest in the old school's** classroom (18.15 ± 12.04 Wh/m²/day, and 32.1 ± 31.02 Wh/m²/day respectively), and lowest in the middle-age school (3.82 ± 4.33 Wh/m²/day and 7.68 ± 10.18 Wh/m²/day respectively) as shown in **Figure 4**. **The new school's** classroom, on the other hand, consumed on average 8.88 ± 4.45 Wh/m²/day for plug loads and 11.71 ± 12.23 Wh/m²/day for lighting.

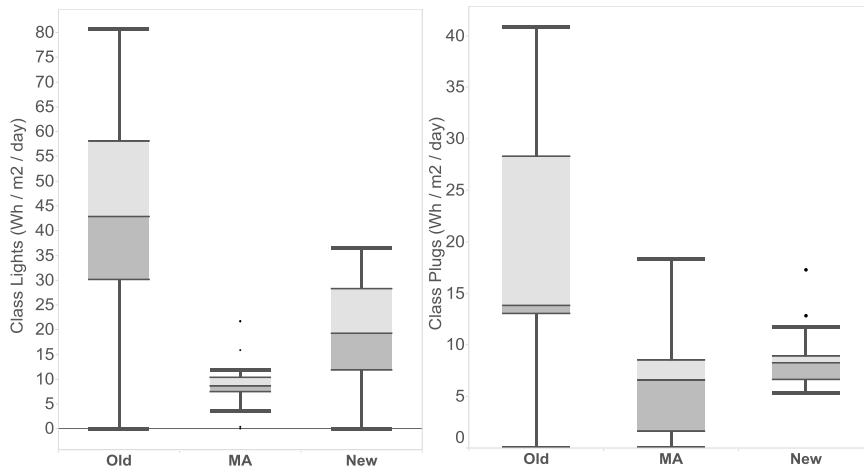

Figure 4: Average daily electricity consumption for classroom lights and plug loads.

4.4 Light sensors data in case-study classrooms

Although sub-meters data indicated the old school classroom was the highest consumer of electricity for lights per unit area, data from the installed light sensors revealed a different story. The average daily duration for which lights were switched on was lowest in the old school classroom (253 ± 163 minutes/day) which increased to 328 ± 212 minutes/day in the new school classroom, and 417 ± 322 minutes/day in the middle aged classroom. Data from light sensors was verified by plotting average half-hourly electricity consumption for lighting in classrooms as shown in Figure 5. These plots indicated lights were typically switched on until 10:30 PM in the middle aged classroom unlike other schools where they were switched on only until around 4:30 PM. School visits also confirmed teachers in the middle-aged school left the lights on for custodial staff, who typically turned them off at the end of their night shifts highlighting energy saving potential by adjusting occupant behaviour. These results indicated while occupant behaviour may influence light use durations, the type of fixtures and light density within classrooms may have been **the ultimate drivers for classrooms' lighting electricity consumption**. **The results indicate installing energy-efficient lighting systems would result in significant savings in the older schools' electricity consumption for lighting** which was at least double the consumption in newer schools.

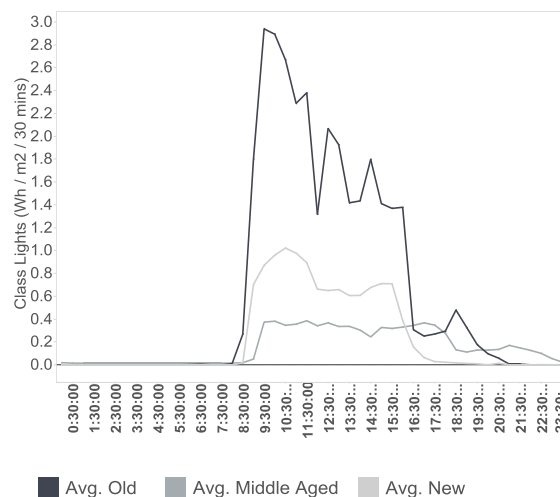

Figure 5: Average half-hourly electricity consumption for classroom lights.

5. CONCLUSION

Results from this study highlighted the increase in electricity consumption in new school buildings in Manitoba **although their classrooms' electricity consumption was lower than older schools. Findings of the study indicated occupancy may have played a role in classroom's electricity consumption for lighting. However, fixture types and installed lighting power density may have been the ultimate drivers behind increased electricity consumption for lights in older classrooms.** Nevertheless, the study results shed the light on potential opportunities for increasing energy efficiency through occupancy interventions, such as ensuring lights were only used during regular school hours. The discrepancy between total and classroom-level electricity consumption trends indicated other areas of electricity consumption in schools should be investigated. With increased automation and mechanization in new schools, these technologies may have contributed to increased electricity consumption in new schools. For example, electrically controlled blind were installed for all windows in the new school unlike the two older schools.

This study analyzed space-level electricity consumption in only three out of the randomly selected thirty schools in Manitoba due to resource limitations. Therefore, results could not be generalized to the larger population of Manitoba schools. Future studies should focus on investigating electricity consumption in a larger sample of schools and standardizing sub-metering methods to avoid errors in measuring real-time electricity consumption. Increasing the study period to demonstrate seasonal variations in electricity consumption can also help increase understanding of real-time electricity consumption in schools. The shift towards more stringent energy codes for greener, more energy-efficient buildings underscores the need to address new parameters influencing electricity consumption which is increasing in new buildings.

REFERENCES

- [1] E. Azar and C. C. Menassa, "A comprehensive analysis of the impact of occupancy parameters in energy simulation of office buildings," *Energy Build.*, vol. 55, pp. 841–853, 2012.
- [2] G. Kats, "Greening America's Schools," no. October, 2006.
- [3] D. K. Robertson and M. W. Higgins, "Do Older Schools Use Less Energy? Results of Calibrated Simulations and Post-occupancy Evaluations," no. March 2013, pp. 37–41, 2012.
- [4] M. H. Issa, M. Attalla, J. H. Rankin, and a. J. Christian, "Energy consumption in conventional, energy-retrofitted and green LEED Toronto schools," *Constr. Manag. Econ.*, vol. 29, no. 4, pp. 383–395, Apr. 2011.
- [5] Z. M. Gill, M. J. Tierney, I. M. Pegg, and N. Allan, "Low-energy dwellings: the contribution of behaviours to actual performance," *Build. Res. Inf.*, vol. 38, no. March 2013, pp. 491–508, 2010.
- [6] M. Hancock and F. Stevenson, "Examining the Interrelationships of Microclimate, Construction Performance and User Behaviour to Inform Design Strategies," no. June, pp. 22–24, 2009.
- [7] a. Dimoudi and P. Kostarela, "Energy monitoring and conservation potential in school buildings in the C₁ climatic zone of Greece," *Renew. Energy*, vol. 34, no. 1, pp. 289 – 296, 2009.
- [8] L. Dias Pereira, D. Raimondo, S. P. Corgnati, and M. Gameiro da Silva, "Energy consumption in schools – A review paper," *Renew. Sustain. Energy Rev.*, vol. 40, pp. 911–922, 2014.
- [9] I. Ridley, J. Bere, A. Clarke, Y. Schwartz, and A. Farr, "The side by side in use monitored performance of two passive and low carbon Welsh houses," *Energy Build.*, vol. 82, pp. 13–26, 2014.
- [10] O. Guerra-Santin, C. Tweed, H. Jenkins, and S. Jiang, "Monitoring the performance of low energy dwellings: Two UK case studies," *Energy Build.*, vol. 64, pp. 32–40, 2013.
- [11] D. Oates, K. T. Sullivan, D. Ph, and M. Asce, "Postoccupancy Energy Consumption Survey of Arizona's LEED New Construction Population," vol. 2, no. June, pp. 742–750, 2012.
- [12] L. Berkeley and P. Grove, "Evaluating the Energy Performance of the First Generation of LEED-Certified Commercial Buildings," 2011.
- [13] O. T. Masoso and L. J. Grobler, "The dark side of occupants' behaviour on building energy use," *Energy Build.*, vol. 42, pp. 173–177, 2010.
- [14] M. Mulville, K. Jones, and G. Huebner, "The potential for energy reduction in UK commercial offices through effective management and behaviour change," *Archit. Eng. Des. Manag.*, vol. 10, no. 1–2, pp. 79–90, 2014.
- [15] R. Gulbinas and J. E. Taylor, "Effects of real-time eco-feedback and organizational network dynamics on energy efficient behavior in commercial buildings," *Energy Build.*, vol. 84, pp. 493–500, 2014.

- [16] Z. Yu, B. C. M. Fung, F. Haghghat, H. Yoshino, and E. Morofsky, "A systematic procedure to study the influence of occupant behavior on building energy consumption," *Energy Build.*, vol. 43, no. 6, pp. 1409–1417, 2011.
- [17] C. M. Clevenger, J. R. Haymaker, and M. Jalili, "Demonstrating the Impact of the Occupant on Building Performance," *J. Comput. Civ. Eng.*, vol. 28, no. February, pp. 99–102, 2014.
- [18] M. Bonte, F. Thellier, and B. Lartigue, "Impact of occupant's actions on energy building performance and thermal sensation," *Energy Build.*, vol. 76, pp. 219–227, 2014.

Deep Green Approach to Create Sustainable Built Environment and Neighbourhoods, Case study of Lumpini Place Rama 4- Ratchada Project

Panita VARA-URAI^a

^a *Wisdom Consulting and Solution Co., Ltd., Thailand, panita@wisdomcs.co.th, panita.vara@gmail.com*

ABSTRACT

Lumpini Place Rama 4-Ratchada is a low income condominium project owned by L.P.N. Development Public Co., Ltd. located in “Phaisingto district”, a low development area with canal side settlement. This area is now facing overcrowding problem and thus results in poverty, polluted water bodies and quality of life degradation which has direct effects on the project. Moreover, community protest against building construction is another major problem. After these conditions evaluation, it was found that light green solutions which applied only inside the project can no more create sustainable built environments. The new goal is how the project can contribute to neighbourhood transformation. As such, a ‘deep green’ approach taken on a wholly dimension of sustainability; environmental, economic and social aspects, has been incorporated to advocate change at the community level.

Environmental approaches are, for example, ‘green construction site program’, L.P.N.’s own innovation to mitigate negative impacts from construction activities, passive design strategies such as creating green walls and open spaces to enhance biodiversity, increase storm water infiltration, and improve the microclimate of the area. Also, one part of the site will be dedicated to a community exercising park for social benefits.

As for economic impact, since major community source of revenue is from small retail business, L.P.N. has provided rental retail spaces in the building and launched a cooperative store network program to strengthen community economy.

Social aspect was taken by creating better understanding among local people and condominium’s occupants, promoting the project benefits on the community, social activities supporting by the project owner such as trade waste-recycling, walkway and water body cleaning etc. Above all, public relation to stimulate local awareness is a key driver. As long as people have mutual environmental concerns, sustainable built environments can be continually maintained to create a green community and neighbourhoods.

Keywords: deep green approach, neighborhood transformation, green community

1. INTRODUCTION

1.1 ‘Deep Green’ approach; A new dimension of green to provide sustainability in all facets

In the last decade, green building industry expansion in Thailand has appeared to be an accelerating effect which reflected in a rising number of projects applying for green building rating system. This increased interest in green building trend led to a new movement in real estate sector. As such, most developers have started to incorporate green design strategies into their projects in order to create product added values and strengthen their market positions. These green building strategies mostly focus on energy efficiency because tangible and measurable benefits are clearly seen for example, utility savings, operational cost reduction, increases in sale premiums and rental rates. Apart from these, green features such as roof gardens, green walls or solar panels are usually included as fancy items in buildings to promote the projects as ‘eco-friendly’. However, key objectives of green building in enhancing quality of life and reducing cost of living may not be achieved only through those features.

The approach that emphasizes only building performance improvement rather than undertaking holistic solution to create sustainable environments was defined by some environmentalists as ‘Light Green’. Light green environmentalism believes in green technologies and strongly advocates change at the individual level. This, sometimes, is criticized to be a ‘shallow green’ since it somehow views architecture as stand-alone objects having no connection to other facets of human life. In this way, wider prospects and impacts to the environment may be overlooked particularly in the larger scale like neighborhood development. Thus, the new shade of green has been addressed as ‘Deep green’ approach to solve more complex problems such as social issues.

In contrast with light green, deep green approach values the concept of the triple bottom line or 3p; people, profits, and planets. It pays respect to the interrelation between building and its surroundings in all dimensions and promotes changes at the community level. This approach can be demonstrated in the case study of Lumpini Place Rama 4-Ratchada in which deeper dimension of green strategies is considered as the best answer for the project.

2. A CASE STUDY OF LUMPINI PLACE RAMA 4- RATCHADA

2.1 Problematic issues in Lumpini Place Rama 4-Ratchada project

Lumpini Place Rama 4-Ratchada is located in 'Phaisingto' alley near 'Klong Toey', a low development area with canal side settlement. The project is a low-rise condominium in the land owned by the 'Crown Property Bureau' (CPB), the quasi-government agency responsible for managing the property of the crown of the Kingdom of Thailand. The CPB has mission to be responsible for protecting and managing the royal assets and property as well as supporting other activities for the benefit of Thai subjects and society. It also aims to build sustainable environments for low-income people, and thus had chosen Phaisingto alley in Klong Toey district as a new development project.

Phaisingto alley is located in a prime location in the city center of Bangkok, only 80 m. from underground train station (MRT), and one stop from Asoke interchange station. Plus, Queen Sirikit National convention center is on the opposite site of the project as shown in Figure 1.



Figure 1: Lumpini Place Rama 4-Ratchada location in the city center

Nonetheless, the area has several poor conditions from its surrounding contexts. As Phaisingto district has a small **slum called 'Phaisingto Community' which is now facing overcrowding problem** and thus results in quality of life degradation. Also, the area is lack of good management and thus results in environmental, economic and social problems. Environmental issue is found in polluted water bodies that emitted obnoxious smell and provided **bad scenery instead of city's scenic water way. Local people are confronted with poverty. More importantly, people in the community have to deal with crime issues and downgraded well-being.**

With all these circumstances, the CPB planned to transform this area into a better environment by choosing one land to develop a new residential project for low-income people. However, the critical issue lies on a bad perception and violent action from local community against the CPB. Primary cause of a protest derives from physical development and land expropriation in the area. The CPB concerned that this issue might worsen relationship between the project and its neighborhood. Hence, L.P.N. Development Public Co., Ltd., the leader of condominium for low to middle income people in Thailand had been chosen to help the CPB develop this project together.



Figure 2: Site surroundings and contexts

L.P.N. is a real estate developer that has an ambition to deliver sustainability to all its customers. The main goal of the company is to obtain sustainability by emphasizing on the ‘Vibrant Community’ which has been a signature of L.P.N. for years. Furthermore, L.P.N. had initiated an intensive ‘green program’ to create a new standard that specifically suits the organization’s culture. This ongoing development program has been deployed to all the organization’s staff and has been successfully adopted in several condominium projects from the beginning of the entire design and construction process. This integrative strategy causes no additional costs and produces financial benefits from building operating cost reduction. As a result, L.P.N. can provide its customers better performance condominium buildings while simultaneously keeping the projects’ selling prices lower than other green projects.

The CPB and L.P.N. also have share business values to create a community where residents can have a good quality of life and a better environment (Figure 2). The CPB, therefore, offered the land in a low rental price, together with L.P.N. know-how in massive construction, maintaining low investment cost to build affordable residential project is not an obstacle.



Figure 3: Crown Property Bureau and L.P.N. business shared values

In Lumpini Place Rama 4-Ratchada, L.P.N. has faced a new problematic situation in which social problems are the key obstruction to this project development. The CPB and L.P.N. had come up with a conclusion that only green standard that mainly concentrates in the project boundary is not enough and can no more create sustainable built environments for the project. Both organizations had to reinterpret conventional thinking method and seek for more profound solutions so that the mutual goal of providing sustainable environment for all residents can be maintained.

2.2 Project specific solutions

Deep green approach was then addressed for the first time among numerous L.P.N. condominiums in order to bring the best and most appropriate solutions that fit these specific site contexts. After conducting a deep research into the site context, 3 main resolutions which are social psychological, physical, and economic approaches have been undertaken.



Figure 4: 3 pillars of deep green approach resolution

Social psychological approach

Social psychological method is the most challenging aspect in this project. The key driver that can build a sustainable development which interrelated to its environments relies on people perception. Although Phasingto community is in a degraded condition and seems to lack of proper management, it has appeared to be a strong community with close relationship among each other. This reflects in the mutual activities such as community settlement groups or some social events. Therefore, the first and foremost strategy is to create better understanding among local people and Lumpini Place Rama 4-**Ratchada condominium's occupants, follow by** promoting physical and economic benefits provided by the project. This is to create better perception and cooperation between the project and the community. Lastly, enhancing mutual environmental concerns is crucial. As long as people have awareness, sustainable environments where residents and neighbours can happily live together can be last long.

Physical approach

This approach started from passive design strategies such as creating green walls to enhance biodiversity in the **project boundary, L.P.N. 'green construction site program' to lessen negative impacts from construction activities,** and surrounded security system improvement. Accordingly, outdoor lighting fixtures and CCTV cameras will be installed at the site boundary and some areas nearby. This plan is to improve security within the project neighbourhood and to prove that having the project located at the area can also enhance living quality of people in Phasingto community. Moreover, one part of the site will be dedicated to the community playground and exercising park for children and elderly to spend time together.

Economic approach

Major community source of revenues are from small retail business, thus L.P.N. planned to provide rental retail spaces in the condominium common areas and launch a cooperative small store network program. The ideas of this program are to collect existing store information and advertise condominium residents about various local products and store locations. Besides, L.P.N. also has housemate training program with an aim to create jobs for disadvantaged women in the community. All of these strategies have been incorporated to offer more job opportunities and revenues for local people and to strengthen community economy.

2.3 5 steps of implementation to change the project and its neighborhood into a sustainable environment

To ensure that the project can resolve all 3 issues mentioned above and reach its goals, implementation is a key success especially in community participation process. To give highest chance of success, an integrative process has been incorporated in the project. In Lumpini Place Rama 4-Ratchada project, all team members have gotten involved and developed action plans all together from the start. Each department has clear scope of work, responsibility and implementation periods. This is shown in the diagram of project participants and responsibilities of each working step in Figure 5.



Figure 5: Relationship of project participants and responsibilities comprises of environmental consultant, R & D, designer, contractor, marketing, and community management

After a brainstorming session, 5 following steps of implementation process were addressed as corresponding plans that cover all aspects.

Step 1: Conducting a site survey

Carrying out a site survey and analysis to explore all circumstances at the beginning of project planning process had helped in problem identification and thus, provided more precise solutions. Also, local people satisfaction survey had been taken to collect community feedback and apply in the project current operation assessment.

Step 2: Implementing sustainable construction strategy in the project during construction to prevent pollution from construction activity

L.P.N. has implemented its own 'green construction standard' which is the company's vision and mission to build condominiums with least negative impacts to the workers, residents, neighborhoods and environments. The company has sent a team to conduct monthly site inspection to ensure that green construction strategy is regularly implemented during construction period.

Step 3: Community development in physical, economic and social aspects

Several plans have been initiated to help in neighborhood development for example, physical improvement of site surrounding area by L.P.N. construction team, security system installation, provision of community common spaces for activities etc. As for economic facet, a cooperative store network program has been introduced to stimulate community economy. L.P.N. also planned to arrange social activities and facilities such as **trade waste-recycling program, walkway and water body cleaning program, children education program local and workers' children etc.**

Step 4: Create community participation

The project is opened for comments and advocates local people to participate in the community development plan. People can give recommendation to the plan if they feel it will not be fit with the community. The main purpose of this process is to encourage partnership among the community and build positive attitude about the project.

Step 5: Public relation of the project operation

Public relation campaign was planned to be launched after the project construction is completed, in order to communicate to the public about L.P.N. approaches and operation to resolve all dimensional issues of this project. This is to build confidence and a positive attitude to the community. Additionally, it can influence public to have awareness about environmental concerns in a wider and deeper facet apart from building performance and green strategies only within the project boundary.

Above all, to accomplish all these steps of implementation, an intensive integrative process that all parties set mutual agreement and work together at the beginning of entire project process is crucial.

3. CONCLUSION

This project has proved that the challenge of sustainability and green design is more a matter of local interpretation than of the setting of universal goal. The important thing is to consider existing issues and integrate achievable practices into the project in all dimensions. Intensive approach that advocates changes in all scales of social, physical, and economic aspects is significant and need to be considered since the very beginning of project entire process. The key seed of success is how we can raise awareness, create mutual understanding and cooperation among all project participants, and drive everyone to deeply engage in the project. Ultimately, it is important to keep in mind that creating change is never easy, especially in a delicate issue like social consequence. It always takes time and patience to create sustainable development, however; the outcome of a better living is worthwhile. As such, we can finally create communities that people could live comfortably and securely while having the least impact on the environment.

REFERENCES

- [1] (2015). Green Building Movement [23 Sept 2015]. Available: http://www.tgbi.or.th/news_detail.php?n=225. Last accessed Sep 2016.
- [2] (2010). A Future to Hope For. Available: <https://www.thesolutionsjournal.com/article/a-future-to-hope-for/>. Last accessed Sep 2016.
- [3] Available: <http://www.crownproperty.or.th/en/intro>. Last accessed Sep 2016.
- [4] Available: <http://propholic.com/prop-talk>. Last accessed Sep 2016.
- [5] (2013). LPN Annual Report. Available: http://www.56-1.com/reports/LPN/LPN_13F561_th.pdf. Last accessed Sep 2016.

M+, Sustainable Design for a Contemporary Art Museum in Hong Kong

Mark RICHARDSON^a, Alvin LO^b, Andrew SIMPSON^c

^a Arup, Hong Kong SAR, mark-a.richardson@arup.com

^b Arup, Hong Kong SAR, alvin.lo@arup.com

^c West Kowloon Cultural District Authority, Hong Kong SAR, andrew.simpson@wkcd.a.hk

ABSTRACT

M+ Museum (M+) will, upon completion be a globally leading museum with exemplar sustainable credentials. Designed for performance throughout, M+ will provide a high quality environment whilst significantly reducing energy consumption and potable water consumption. The roof podium provides landscaped and a publically accessible garden where the microclimate is refreshed by the harbour breeze. Internally, pockets of daylight animate selected gallery spaces reducing artificial lighting use and architectural shading minimises heat gain and cooling energy. The remaining building loads are served by district cooling and supplemented by solar hot water panels to supply sustainable energy.

Sustainability in modern museums is essential, however this should always be considered alongside the environmental requirements of art galleries, art work storage, staff and visitors.

This paper presents the sustainable engineering processes, analyses and findings which underpin the design of M+. Particular focus has been given to the areas of design which required specific solutions to be engineered beyond those found in conventional commercial buildings in Hong Kong, and how these designed solutions are creating a high performance, highly sustainable building.

Keywords: high-performance building, museum design, integrated design approach

1. INTRODUCTION

M+ Museum (M+), shown in Figure 1, is a globally leading museum with exemplar sustainable credentials. This high-performance sustainable building uses passive and active design strategies to minimise energy, material, water and land use. By making use of ambient energy sources such as daylight, breeze and solar energy, the external microclimate is improved, energy demands lowered and operating costs reduced.

The building envelope incorporates architectural shading over well placed windows to minimise heat gain and cooling energy. Internally, pockets of daylight animate selected gallery spaces reducing artificial lighting use. The remaining building loads are in part served by district cooling with solar hot water panels. Where required bespoke designed cooling delivery system provide low energy solutions whilst maintaining specific environments.

The extensive roof podium will provide a lush publically accessible garden where the optimised microclimate is refreshed by the harbour breeze, this type of usable outdoor space reduces the need for conditioned buildings. All together this enabled M+ to be awarded a Provisional BEAM Plus Gold rating. **BEAM Plus is Hong Kong's** sustainable building rating system (BEAM Society Limited 2012) and is equivalent to other rating systems such as the internationally recognised LEED v2009.

This paper presents the sustainable initiatives that have been designed into M+ and required specific analytical assessment to balance the requirements of sustainable design, visitor experience and art work preservation.



Figure1: Rendered Image of M+

2. SITE AND OUTDOOR ENVIRONMENT

Situated overlooking Hong Kong's Victoria Harbour, in The West Kowloon Cultural District, M+ will be a key asset of the district and city. The large publically accessible podium garden was designed to be comfortable for visitors throughout the year. During the hotter months in Hong Kong local microclimates are enhanced by sun shading, breezes and reducing surface temperatures with planting. This is particularly important along pedestrian circulation routes and areas designed for sitting and enjoying outdoor space.

2.4 The podium

To analyse visitor comfort the metric of thermal sensation was used. Thermal sensation is the combined physiological response to solar radiation, air temperature, wind, radiant temperature, metabolic rate and clothing (Givoni et al, 2003). The local wind speed was simulated using computational fluid dynamics which considered the neighbourhood massing and influential building features. The solar radiation was simulated using Radiance ray tracing tools which take into account local building massing. The other thermal sensation factors were included as typical values for the corresponding period of the year, the results are shown in Figure 2.

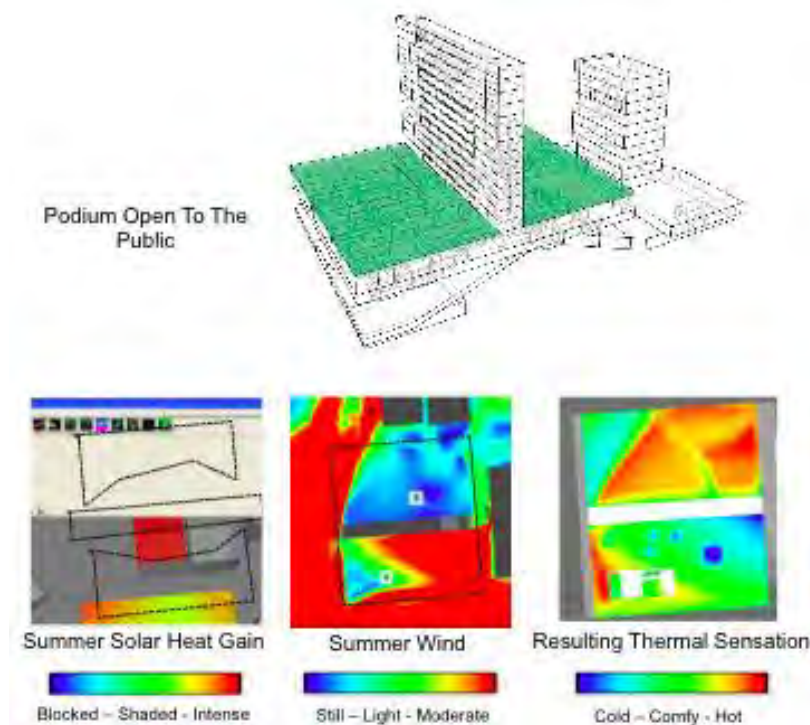

Figure 2: Thermal sensation analysis

Based on the results of the analysis, the podium was configured to make the best use of the outdoor space. The spaces with a comfortable thermal sensation are more suitable for pedestrian circulation areas, outdoor spaces and exhibitions spaces. Permanent planting and none accessible north lights were also included more extensively towards the north east where thermal sensation was hottest. This is shown in Figure 3.

The planting also provides a thermal and acoustic buffer for the gallery spaces, this lowers cooling energy and enhances visitor comfort. The planting predominantly used species native to Hong Kong and was chosen to vary in height to enhance bio-diversity and provide habitats for insects and pollinators.

This podium garden includes over 50% planted area. Rainwater is harvested from the roof, treated and stored in the basement before being used to serve over 50% of the annual irrigation demand.

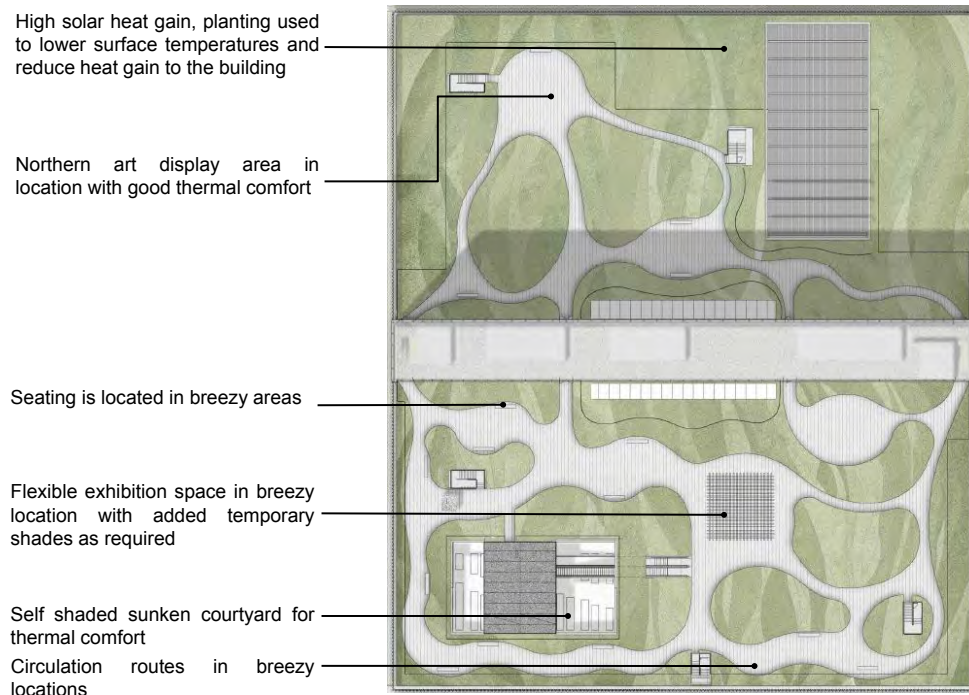

Figure 3: The resultant podium space planning. Background image courtesy of Herzog & de Meuron

2.5 Pedestrian circulation routes

Direct sunshine in the summer in Hong Kong will rapidly lead to thermal discomfort particularly for pedestrians walking between buildings or from transportation drop offs. The building was designed with setback at the ground floor façade. This allows the podium to provide shading to pedestrian routes. The setback also encourages breeze to flow around the building. Figure 4 shows the extent of the overhang in red.

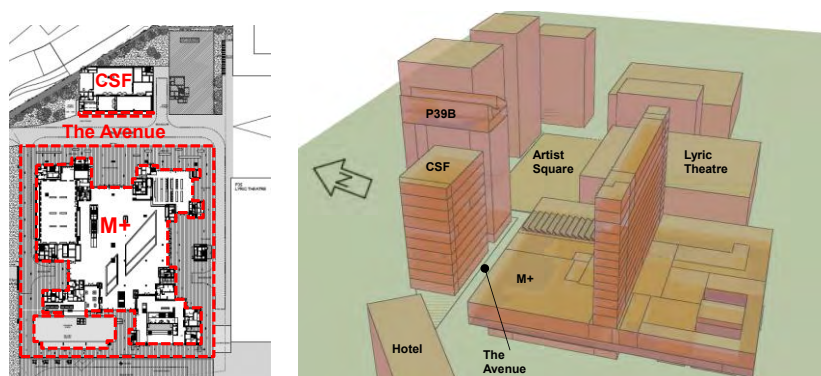

Figure 4: Shading of pedestrian routes with particular emphasis on "The Avenue" which transects the site

To ensure the shading environment is optimised ray tracing simulations were carried out to assess the hours of direct sunlight the pedestrian areas receive. These are shown in Figure 5.

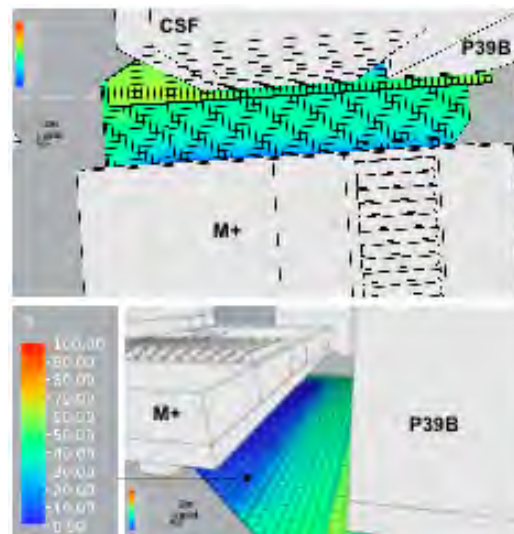

Figure 5: Simulation result highlighting that M+ massing enables large areas of pedestrian circulation routes with minimal hours of direct sunlight throughout the year. (Scale is % of daylight hours which experience direct sunlight across the year)

3. INTERNAL ENVIRONMENTAL QUALITY

The people that visit M+ and the artwork on display have specific environmental requirements. Key parameters are light levels (artificial and daylight), temperature, temperature distribution and humidity. As such the design embeds a number of passive and active systems into the building which ensure that strict environmental conditions can be maintained and energy use minimised. This section of the paper reviews the elements of design that presented specific challenges relating to M+.

3.1 Heat gain

In a sub-tropical climate such as Hong Kong, solar heat gain will drive up cooling loads and the associated capacity and energy consumption of the cooling plant. M+ minimised solar heat gain, by reducing glazing areas, locating more glazing away from the hotter east and west facades and providing shading for the tower portion of the building alongside north lights and extensive overhangs at the ground floor. The combined effect reduced annual solar heat gain by over 66% for the office portion compared to the statutory requirement for commercial offices in Hong Kong (note there is no statutory requirements for museum or archive stores). The shading elements are pre-cast concrete which reduces material wastage on site.

3.2 Daylight

Using natural light creates an alternative lighting ambiance and vibrant spaces for works of art (those which are not damaged by light). Daylight provides excellent colour rendering and a subtle dynamism which is favoured by curators. It also reduces the energy consumption associated with artificial lighting which is typically 2-3 times that of a typical office or school environment. This must be balanced with light exposure limits for sensitive artwork where both artificial and daylight must be controlled. As such, M+ lights certain galleries or parts of galleries with natural light and others with controlled artificial light. This enables freedom of curation for a variety of galleries. The use of daylight also plays an important part in creating a low-energy building and providing visitors and staff a valuable connection to nature with the associated health benefits.

The design guide, *Lighting For Museums and Art Galleries* (CIBSE, 1994), set limits for art work exposure which are as low as 150,000lux hours per year for sensitive art work. As direct unobstructed light can result in instantaneous illuminances of well over 50,000lux it follows that galleries should minimise or block direct sunlight completely if light sensitive artworks are to be displayed. **In practice, due to Hong Kong's solar geometry blocking direct light completely is challenging and limits general daylight levels.** Figure 6 shows a south – north section and **a Radiance simulation of “The Skylight Gallery”**. This gallery uses north lights to block over 90% of direct light,

however, blinds are still required to ensure art work is not damaged for the instances when the sun is in the north of the sky. During the design process precise Radiance ray tracing tools were used to guarantee building performance and artificial lighting demand was reduced by over 5% compared to Hong Kong Building Energy Efficiency Codes (EMSD, 2012).

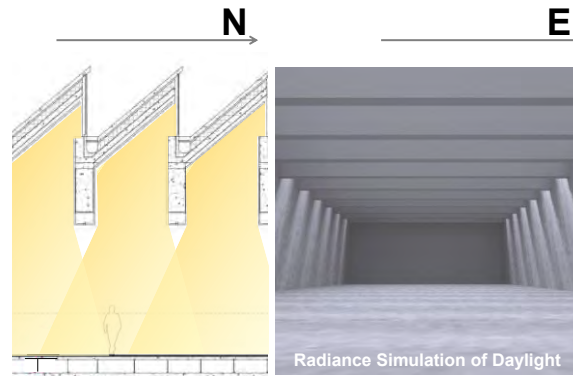

Figure 6: Section through the skylight gallery and Radiance simulation of daylight

3.3 Temperature distribution

Museums demand a lot from internal environments; temperature and humidity must be carefully controlled to preserve artwork, visitors must have best in class comfort and typically the HVAC systems must be sensitively integrated into architecture. For a museum to be sustainable this must be achieved with minimal energy and water expenditure, easily maintainable systems and high levels of adaptability. One of the more challenging spaces to design was the skylight gallery.

Due to requirements for subtle supply and extract locations underfloor air delivery was preferred; from the energy view point this was favourable due to reduced fan energy associated with higher temperature differences between supply and extract. The key environmental requirement for a minimal temperature gradient across the surface of art work also favoured this solution. Underfloor systems rely on natural buoyancy effects whereby room heat loads warm the air which then moves upwards towards the exhaust louvers. In this process warmer air will pool at the ceiling creating a stratified layer, below the layer the air temperature will be constant at the design set point. In the case of this gallery, this stratified temperature layer cannot drop below 5m into the art work zones else the art work will experience a temperature gradient. The heat gains and HVAC cooling delivery with computational fluid dynamics (CFD) to assess this. The simulation was conducted using k- ϵ turbulence computation for the gallery space. Figure 7 shows the input parameters and the results.

Case	Predicted Temperature Difference (°C)	Supply Air Volume Rate (L/s)	Supply Air Volume Velocity (m/s)	Occupied Zone Temperature (°C)	CFD Temperature Plots
1	4	9800	0.25	19.0 – 20.0	
2	6	6550	0.25	19.5 – 20.5	
3	8	4900	0.25	20.0 – 21.0	
4	8	4900	0.4	Not Stable	

Figure 7: Optimising the HVAC for environmental control and energy efficiency

The results show that as the air flow rate decreases the stratified layer lowers, hence the design looked to minimise air flow whilst ensuring the stratified layer does not infringe on the art work zone (with a suitable buffer). This minimises fan energy consumption and increases overall sustainable performance. As such Case 3 was taken forward as the optimised solution – supply air volume (and energy) is minimised to the point where the stratified layer cannot go any lower.

Case 4 highlights an optimisation exercise which was carried out to assess the feasibility of reducing the number of supply louvers. In case 4 the supply louvers were almost halved hence the supply velocity almost doubled. It is clear from the CFD plot that this increase in velocity led to short circuiting whereby the supply air jetted straight to the exhaust with insufficient room mixing. This is not a workable design solution.

4. OTHER SUSTAINABLE FEATURES

M+ has included a number of sustainable features to ensure that the building performs across multiple parameters, whilst not the focus of this paper they are listed here for reference.

A key aspect of M+'s sustainability is energy consumption. As close environmental control relies of extensive mechanical servicing, energy consumption is typically higher than other building types. The major energy consuming systems of a museum located in the sub-tropical climate are cooling, lighting and humidity control. Total energy consumption of M+ was reduced by almost 20% compared to Hong Kong Building Energy Efficiency Codes (EMSD, 2012).

M+ uses daylight and occupancy sensors to provide only the necessary light which is served by highly efficient and high quality (high colour rendering performance) fittings, lighting energy is reduced by over 23% compared to Hong Kong Building Energy Efficiency Codes (EMSD, 2012).

The cooling loads are served from a district cooling system with open loop sea water heat rejection. The district systems makes use of diversity across the site with the sea water heat rejection providing a lower average rejection temperature compared to the ambient air. In the archival and gallery spaces where close humidity control is needed (mould will develop quickly over 60% RH), desiccant dehumidification systems are used. The reheat from these systems is in part supplied by solar thermal hot water panels and heat recovery chillers, solar energy accounts for almost 1% of total building energy.

Energy consumption however cannot be driven down to the lowest levels as to provide an excellent environment, the air quality inside M+ must be excellent. With the use of high rated air filters and increased fresh air rates (with **associated increased fan energy consumption**) Hong Kong's indoor air quality standard of "excellent" is achieved.

M+'s toilets are flushed with seawater displacing the use of potable water and sanitary fittings are all low flow saving over 35% potable water compared to the BEAM Plus baseline.

5. CONCLUSION

The paper has primarily presented a selection of the analytical assessments which were carried out to deliver a modern, sustainable museum design. Often in this design process requirements for art work preservation and visitor comfort required more energy to run systems compared other building types. As such it was essential to carry out detailed building physics analysis to ensure the systems would perform optimally. A key example of this is the under floor air delivery which was optimised across multiple parameters to deliver the required environmental conditions with minimal energy consumption.

REFERENCES

- [1] Baruch Givoni, Mikiko Noguchi, Hadas Saaroni, Oded Pochter,
- [2] BEAM Society Limited, 2012, BEAM Plus for New Buildings Version 1.2
- [3] CIBSE, 2015. Lighting For Museums and Art Galleries.
- [4] EMSD, 2012, Code of Practice For Energy Efficiency of Building Services Installation
- [5] Yaron Yaacov, Noa Feller, Stefan Becker, 2003. Outdoor comfort research issues. Energy and Buildings.

Session 7.12: Multi-facet Considerations of Urban Regeneration Policies

The Role of Stakeholders in Masterplan Regeneration Decisions

Hannah BAKER^a, Alice MONCASTER^b

^a University of Cambridge, United Kingdom, heb51@cam.ac.uk

^b The Open University, United Kingdom, alice.moncaster@open.ac.uk

ABSTRACT

Brownfield sites often contain existing buildings and during regeneration the decision to demolish or adapt them should consider sustainability principles. This paper discusses decision-making criteria obtained through a literature review and primary research including 18 interviews, 2 workshops and 2 focus group discussions. The most frequently mentioned criteria including building condition; heritage value and capital costs are evaluated. Criteria are then analysed from different stakeholder perspectives and the paper identifies where stakeholder values align. The paper forms part of a three year research project which aims to develop a decision-making framework to assist with integrated and holistic decision making.

Keywords: urban regeneration, building adaptation, decision-making

1. INTRODUCTION

Worldwide there is an increasing population and a pressure for housing in a number of countries (Karantonis, 2008). In 2015, the UK Conservative Government's manifesto stated that brownfield land (Previously developed) should be used as much as possible for new development (HM Government, 2016; Smith, 2016). When redeveloping brownfield land, independent of scale, the decision needs to be made to demolish or adapt the existing building(s). This should consider the benefits and drawbacks of adaptation and demolition; alongside several decision-making criteria and sustainability principles (Love and Bullen, 2009). In general, the decision is not made by one person as it is complex and requires the expertise of a range of stakeholders (Bullen, 2007; Kaklauskas et al., 2005). This paper discusses decision-making criteria identified through a literature review and supported by primary research methods including 18 interviews, 2 workshops and 2 focus groups. Criteria are then discussed from different stakeholder perspectives to show where stakeholder interests may align or differ. The research is beneficial as the paper forms part of an ongoing three year research project which aims to develop a decision-making framework for the adaptation or demolition of existing buildings on masterplan regeneration sites to assist with integrated and holistic decision-making.

2. LITERATURE REVIEW

2.1 Brownfield redevelopment, adaptation and demolition

The decision to demolish or adapt is not 'black or white' (Baker et al., in press). There are different forms of adaptation and a building can be demolished in its entirety or part. Wilkinson et al. (2014) outlines the different options for decision-makers including: demolish; strip out and maintain the building shell; maintain the building in a vacant state; part demolish and adapt; modify, refurbish and adapt; part extend; let all or part; or sell.

2.2 Decision-making criteria

Through an in-depth literature review, seventy criteria used to evaluate building's and whether they should be adapted or demolished have been identified, collated and 'mapped' into three separate tiers: an overarching theme, 1st tier and 2nd tier. The overall themes include: technical; planning; environmental; economics; masterplan design; legal; heritage value; corporate objectives and the construction process. The most commonly cited criteria in the 1st tier are displayed in Table 1 and the most frequently referenced criteria in the 2nd tier are in Table 2.

Technical criteria are regularly mentioned including **the buildings' layout and dimensions; condition; regulations; structure and function.** Baker et al. (In press) identified poor building condition as a key disadvantage of adaptation, thus favouring demolition because it can increase the capital costs of the project. Although problems affecting the

condition can be identified in the structural appraisal stage, a key concern related to existing buildings in comparison to new-build is the risk of discovering unknown problems during construction (Bullen and Love, 2010; Remøy and Van der Voordt, 2006; Yung and Chan, 2012). Building regulations are regularly cited because of the safety of occupants and threat of prosecution if not met (Garrett, n.d.). Fire safety must always be adhered to (Table 2), whereas there is more lenience for other regulations such as the thermal performance (Energy efficiency) of listed buildings, scheduled monuments and buildings in conservation areas to avoid irreversible damage to the **buildings' fabric (Historic England, n.d.)**.

Wilkinson (2011) conducted a quantitative analysis of building permits to identify trends in previous adaptation projects and what features enable adaptation. For example, concrete frame buildings were found to be more adaptable than load-bearing brick, stone or concrete wall and the optimal building height was 11-20 storeys. Clark's (2001) case study investigation of historic naval buildings also found columnar structures to be more flexible because of their grids and larger spans. Building height is a factor related to land value and potential profits. Been et al. (2016) discuss that if buildings have low heights and low amenity values, the whole area should be redeveloped because it is not reaching its full potential.

Alongside the technical criteria, qualitative values should be considered for holistic and sustainable decision-making (Bullen, 2007) and are regularly cited in the literature. Table 1 shows that heritage incorporates a range of intangible values including: aesthetics; historical importance and architectural significance. Baker et al. (In press) **identified 'heritage value' as a key benefit of adaptation over demolition and that there is a growing appreciation** for heritage retention because of concepts such as place-making and providing a sense of identity to the community.

Theme	1 st Tier	References
Technical	Layout and dimensions	Been et al. 2016; Borst, 2014; Brennan and Tomback, 2013; Bullen and Love, 2011; Clark, 2001; Davison et al., 2006; Geraedts and Van der Voordt, 2007; Heath, 2001; Kutut et al., 2014; Lin and Low, 2012; Plimmer et al., 2008; Weber et al., 2006; Wilkinson et al., 2014.
	Building structure	Bullen and Love, 2011; Clark, 2001; Davison et al., 2006; Geraedts and Van der Voordt, 2007; Harun, 2011; Kim et al., 2010; Lin and Low, 2012; London Assembly, 2015; Natividade-Jesus et al., 2013; Plevoets and Van Cleempoel, 2011; Plimmer et al., 2008; Watson, 2009; Weber et al., 2006.
	Building regulations	Bullen and Love, 2011; Davison et al., 2006; Drury and McPherson, 2015; Geraedts and Van der Voordt, 2007; Heath, 2001; Kim et al., 2010; Lin and Low, 2012; Natividade-Jesus et al., 2013; Plevoets and Van Cleempoel, 2011; Van der Flier and Thomsen, 2006; Watson, 2009; Wilkinson et al., 2014; Yung and Chan, 2012.
	Building function	Borst, 2014; Bullen and Love, 2010; Clark, 2001; Geraedts and Van der Voordt, 2007; Heath, 2001; Kutut et al., 2014; Lin and Low, 2012; Palmer et al., 2003; Plimmer et al., 2008; Thomsen and Flier, 2009; Van der Flier and Thomsen, 2006; Wang and Zeng, 2010; Watson, 2009; Weber et al., 2006; Wilkinson et al., 2014; Yildirim, 2012; Yung and Chan, 2012.
	Building condition	Ball, 2002; Clark, 2001; Drury and McPherson, 2015; Dutta and Husain, 2009; Geraedts and Van der Voordt, 2007; Harun, 2011; Kim et al., 2010; Kutut et al., 2014; Lin and Low, 2012; London Assembly, 2015; Plevoets and Van Cleempoel, 2011; Thomsen and Flier, 2009; Van der Flier and Thomsen, 2006; Watson, 2009; Yildirim, 2012.
Heritage value	Aesthetics	Been et al., 2016; Bullen and Love, 2011; Drury and McPherson, 2015; Heath, 2001; Lin and Low, 2012; London Assembly, 2015; Mason, 2008; Palmer et al., 2003; Watson, 2009; Wilkinson et al., 2014; Yildirim, 2012.
	Historical importance	Ball, 2002; Bullen and Love, 2011; Clark, 2001; Drury and McPherson, 2015; Harun, 2011; Kim et al., 2010; Kutut et al., 2014; Mason, 2008; Plimmer et al., 2008; Wang and Zeng, 2010; Yildirim, 2012.
	Architectural value	Ball, 2002; Bullen and Love, 2011; Clark, 2001; Drury and McPherson, 2015; Harun, 2011; Kim et al., 2010; Kutut et al., 2014; Mason, 2008; Plimmer et al., 2008; Wang and Zeng, 2010; Yildirim, 2012.
Economic viability	Capital costs	Ball, 2002; Bullen and Love, 2011, 2010; Heath, 2001; Lin and Low, 2012; London Assembly, 2015; Palmer et al., 2003; Plimmer et al., 2008; Yung and Chan, 2012.
Planning	Development trends in area	Brennan and Tomback, 2013; Bullen and Love, 2011; Geraedts and Van der Voordt, 2007; Harun, 2011; Heath, 2001; Plimmer et al., 2008; Thomsen and Flier, 2009; Van der Flier and Thomsen, 2006.
	Planning policies	Bullen and Love, 2011; Clark, 2001; Geraedts and Van der Voordt, 2007; Kutut et al., 2014; Palmer et al., 2003; Plimmer et al., 2008; Van der Flier and Thomsen, 2006; Yung and Chan, 2012.

Table 1: Most frequently cited criteria at 1st tier level

Theme	1 st Tier	2 nd Tier	References
Planning	Development trends in area	Housing pressure in area	Bullen and Love, 2011; Geraedts and Van der Voordt, 2007; Heath, 2001; Plimmer et al., 2008; Thomsen and Flier, 2009; Van der Flier and Thomsen, 2006.
Environmental	Energy and carbon	Energy efficiency	Ball, 2002; Bullen and Love, 2011; Geraedts and Van der Voordt, 2007; Palmer et al., 2003; Plevoets and Van Cleempoel, 2011.
Economic viability	Capital costs	Cost per m ²	Ball, 2002; Lin and Low, 2012; London Assembly, 2015; Palmer et al., 2003; Plimmer et al., 2008; Yung and Chan, 2012.
Technical	Building structure	Façade adaptability	Davison et al., 2006; Drury and McPherson, 2015; Geraedts and Van der Voordt, 2007; Heath, 2001; Natividade-Jesus et al., 2013; Plevoets and Van Cleempoel, 2011.
	Building regulations	Means of fire escape and resistance	Davison et al., 2006; Drury and McPherson, 2015; Geraedts and Van der Voordt, 2007; Heath, 2001; Lin and Low, 2012; Natividade-Jesus et al., 2013; Plevoets and Van Cleempoel, 2011.
	Building function	Fit for purpose/new use	Borst, 2014; Bullen, 2007; Geraedts and Van der Voordt, 2007; Lin and Low, 2012; Palmer et al., 2003; Plimmer et al., 2008; Thomsen and Flier, 2009; Watson, 2009.

Table 2: Most frequently cited criteria at 2nd tier level

2.3 Stakeholder roles in the decision-making process

Mok et al. (2015) discuss the complexity of mega-construction projects including the involvement of numerous decision-makers who will have different interrelationships and conflicting viewpoints. The Engineering Council's inter-institutional guidance on sustainability (Bogle, 2010) says that engineers should "seek multiple views to solve sustainability challenges" (Ashley, n.d.). This is applicable to other decision-makers to ensure integrated decision-making. Wilkinson (2011) identifies decision-makers as: investors; producers; marketeers; regulators; policy-makers; developers and users, which then have a range of sub-categories. The general public may be stakeholders or decision-makers dependent on their influence and power in the process (Langston and Smith, 2012; Yang et al., 2014).

The criteria identified in Section 2.2 can be integrated into frameworks as decision-makers go through different processes to assess adaptation and demolition. There is inevitably a difference between the ways an engineer would assess a structure to a heritage consultant, but both processes need to be considered for holistic decision-making. For example, engineers are often responsible for analysing the building's condition and the Institute of Structural Engineers provide guidance and flow charts to show the suggested paths of appraisal, which include various stages of qualitative and quantitative analysis (IStructE, 2008). Heritage consultants aim to understand the contribution of various heritage values but these are often critiqued because of their perceived subjectivity. To try and overcome this, Historic England have recently published guidance on conservation principles and policies to ensure there is consistency between decision-makers (Drury and McPherson, 2015, p.38).

Fundamental decision-makers include the building owners and developers. Geraedts and Van der Voordt (2007); Langston and Smith (2012) and Wilkinson et al. (2014) have created tools for asset owners to assess a portfolio of office buildings with the aim of determining what intervention is required. An analysis by Baker et al. (In press) using case study sites found that adjustments are required if using the tools on masterplan sites rather than individual buildings.

3. METHODOLOGY

3.1 Thesis overview

This paper forms part of an ongoing three year research project, which aims to understand the decision to demolish or adapt existing buildings on masterplan regeneration sites. Results from the 1st year are outlined in this paper. The objective was to identify key decision-making criteria through general interviews with different stakeholders. During the second year of research these preliminary results will be used to assess case study sites, with the overarching aim of developing a holistic framework to assist in decision-making. During the 1st year, the use of social research methods, such as interviews and focus groups, was informed by previous studies (Referenced in the literature review) regarding adaptation. As shown by Bullen and Love (2011, p.35), an interpretive research approach "can capture information about the beliefs, actions and experiences of stakeholders involved".

3.2 Interviews

The participants for the 'general interviews' were chosen through opportunistic and purposive sampling methods (Given, 2008). Interviews conducted so far represent: property consultants, heritage societies, building surveyors, engineers, private planners, local authority planning officers and conservation officers – see Table 3. Once the interviews were transcribed, they were analysed through a coding software called HyperResearch. The initial set of codes established through the literature review were used as an introductory guide.

Stakeholder	Number of interviews
Engineers and building surveyors	4
Heritage societies	7
Property consultants	4
Town planners and conservation officers	3

Table 3: Interviews conducted to date

3.3 Focus groups and workshops

Two focus groups, containing eight people from academia and industry discussed “How can embodied energy be incorporated in the decision to demolish or retain existing buildings?” as part of an Embodied Energy Symposium. Conversations were recorded, transcribed and coded in the same way as the interviews. In addition, two workshops were hosted with post-graduate and undergraduate students on courses related to the built environment. Classes were separated into stakeholder groups of four to five people (Design team; planners; end-users and developers) and asked to determine what criteria were important from their stakeholder's perspective. These were recorded in Excel and mapped to the codes identified in the literature review.

3.4 Limitations

The current results should be treated as preliminary findings. Further iterations of coding analysis are required to refine the criteria being used as only one iteration has been completed to date. The research currently does not represent all stakeholders in the decision-making process and there is a higher representation of heritage societies, which may create a bias.

4. RESULTS

4.1 Decision-making criteria

Table 4 displays the decision-making criteria extracted from the interviews, focus groups and workshops and the number of people mentioning them.

Ws = no. of stakeholder's groups from workshops (n=9). In = no. of respondents from interviews (n=18). Fg = no. of focus groups (n=2)

Theme	1 st Tier	2 nd Tier	Ws	In	Fg
Technical	Layout and dimensions	Floor area	2	6	1
		Floor to ceiling height	-	4	2
	Building services	Service provision	4	1	2
	Building function	Fitness for purpose and finding a use	8	6	1
	Building condition	General condition of building	4	5	1
Economic viability	Capital costs	Cost per m ²	5	7	2
	General risk	General risk	-	5	-
Planning	Designations	Listed building	1	9	2
		Conservation area	-	4	1
Planning (cont.)		Public benefit through demolition	-	4	-
		Effect on setting	-	5	-

Theme	1 st Tier	2 nd Tier	Ws	In	Fg
Environment	Environmental conditions	Remediation	4	-	-
	Energy and carbon	Energy efficiency	2	5	2
Criteria below only contain theme and 1 st tier					
Corporate objectives	Overall corporate vision	-	-	6	-
Construction Process	Time	-	4	1	-
Masterplan design	Accessibility	-	6	-	-
	Phasing and future expansion	-	4	1	-
	Density and land efficiency	-	2	4	-
Heritage value	Community viewpoints	-	-	5	-

Table 4: Criteria identified from interviews and focus groups: Theme, 1st tier and 2nd tier

The most frequently mentioned technical criteria were those related to the building's condition; layout and dimensions; services and function. The building condition was regularly mentioned, similar to the literature review because of the effect it can have on costs. One interviewee stated: "If you are an asset owner - it's all about capital costs and running costs". Alongside this, four interviewees discussed unforeseen problems occurring during the construction process and issues associated with warranty.

It is vital for a building to have a use: "without a use, there is no point regenerating these buildings". The feasibility of adaptation is affected by floor areas, floor to ceiling heights and service provisions. If a building needs to have specialised floor-plates it may be more complex to adapt. Whereas, a factor which emerged during the interviews was the desirability of start-up companies and knowledge economies to accommodate within existing buildings. One building surveyor stated that "Groovy start-ups want to go into groovy little buildings". These businesses do not necessarily require open floor spaces and can utilise the "nooks and crannies".

One of the most commonly mentioned criteria in all three methods was whether or not a building was designated. If a building is listed in the UK, interviewees suggested that the de-listing process can be time-consuming and increase the risk of not obtaining planning permission. Despite some of the interviewees stating that retention was not dependent on designations and that non-designated heritage assets can still be desirable, one conservation officer said: "it's much harder when you're talking about undesignated assets".

Although embodied energy is a commonly cited benefit of building retention in the literature (Baker et al., in press) and was recognised as a benefit of retention in the interviews, the overall perception was that it is currently not a major factor to consider in the decision-making process because "it doesn't appear on balance sheets". During the focus groups, the general consensus was that for embodied energy to be considered in the decision-making process there needed to be tax incentives or legislation in place. At the moment this is difficult due to uncertainties associated with the measurement. This emphasises an important point - what is currently done, is not necessarily what should be done from a sustainability perspective. Future research will establish what should be changed in the decision-making process and which criteria should have a higher weighting of consideration.

4.2 Criteria in a masterplan context

Decision-making criteria may be considered differently for buildings in a masterplan context rather than individual buildings. In some situations it would not be economically viable to retain an individual building, however this may change within a larger site. This was discussed by a property consultant who said "when you look at the benefit of knocking that building down and replacing it in the scheme of the masterplan, it's miniscule...any space that we could have grabbed by knocking it down, we could catch up with elsewhere". When considering the economic

viability of a large scheme, it is important that the phasing of the development is considered. For example, the perception of three interviewees was that the scheme at Kings Cross, UK was successful because the historic buildings were completed first which created a hub of activity early on within the process. However, this may not always be possible as raising the funds to adapt existing buildings can be more complicated than new build because of the associated risks and uncertainty. Both the accessibility and the density on site were regularly mentioned as it is vital individual buildings work within the masterplan vision and this includes their location on site and if they are easy to access.

4.3 Stakeholder viewpoints

The primary research showed that there are differences in opinion between stakeholder groups and even within them. Currently there have not been enough interviews to conclude a criterion is only important to one stakeholder group, but it is interesting to acknowledge where stakeholder interests may align.

During the workshops the criteria mentioned by all stakeholder groups were building function and accessibility but were important for different reasons. For example, developers wanted to establish if a building was fit for purpose (1st tier = building function) to ensure development was economically viable. The design team were concerned with function as they are responsible for “space-planning” and designing the building for the intended use. The end-users were interested in whether the “space was practical” and “whether there were enough toilets and cafes” to meet their needs and the planners had a general interest to ensure the area is effectively used. The workshops emphasised that there can also be a difference of opinion within stakeholder groups. In the first workshop, the students chose to be ‘social developers’, whereas in the other they chose to be ‘profit-driven’, which meant they had different attitudes towards the scheme.

In the interviews, the criteria identified within all stakeholder groups (Figure 1) included: designations, planning policies, capital costs, building structure and building condition. As would be expected, engineers and building surveyors were interested in technical criteria as their role is to assess the robustness of the structures. Property consultants were interested in the technical aspects as they affect the cost of a project, whilst heritage societies and town planners recognised that non-economic viability can sometimes be used to justify demolition. This has to be balanced with heritage values. Designations were regularly mentioned because of the protection they can offer. Although property consultants recognised that heritage could add value (Economically and socially), they did express concern regarding constraints caused by designations which can lead to delays and extra costs.

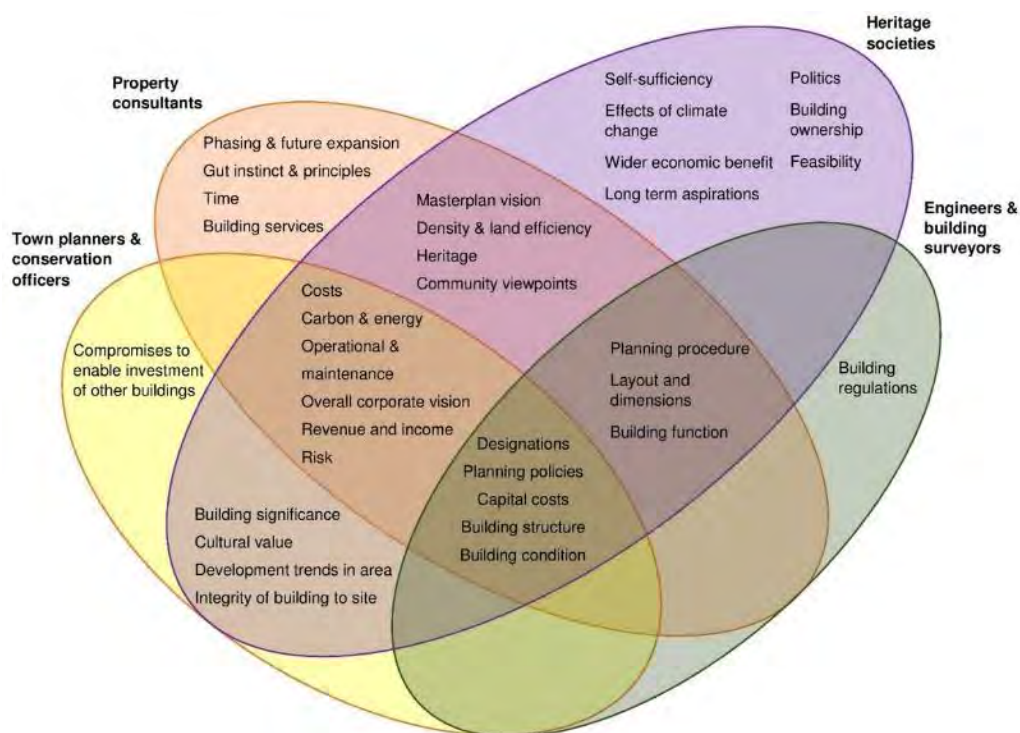

Figure 1: Criteria mentioned by stakeholder groups in the interviews

5. CONCLUSION

This paper has identified criteria currently used in the decision to demolish or adapt existing building on masterplan regeneration sites through a literature review, interviews, focus groups and workshops. Frequently mentioned criteria include: technical issues such as building function, condition, layout and services; economic viability; designations; and issues specific to masterplan sites, for instance accessibility, density and phasing.

Different stakeholder attitudes to the same criteria were discussed and the findings begin to show that it is vital to consider these differing viewpoints in the decision-making process. This includes a diversity of opinions between and within stakeholder groups. For example, an engineer may be concerned with designations for a different reason to heritage societies. The criteria outlined show an understanding of what currently happens when making adaptation and demolition decisions. Future work will establish if this is the most sustainable way of thinking and what needs to be changed. The criteria will be refined and contribute towards a decision-making framework which will aid holistic decision-making and collaboration between stakeholders.

REFERENCES

- [1] Ashley, R., n.d. *The role of the civil engineer in society: engineering ethics and major projects*. Eng. Nat. Way.
- [2] Baker, H., Moncaster, A., Al-Tabbaa, A., In press. *Decision-making for the demolition or adaptation of buildings*. ICE - Forensic Eng. Urban Renov. - Themed Issue
- [3] Ball, R.M., 2002. Re use potential and vacant industrial premises: revisiting the regeneration issue in Stoke-on-Trent. *J. Prop. Res.* 19, 93–110. doi:10.1080/09599910210125223
- [4] Been, V., Ellen, I.G., Gedal, M., Glaeser, E., McCabe, B.J., 2016. Preserving history or restricting development? The heterogeneous effects of historic districts on local housing markets in New York City. *J. Urban Econ.* 92, 16–30. doi:10.1016/j.jue.2015.12.002
- [5] **Bogle, D., 2010. Briefing: UK's Engineering Council guidance on sustainability. Proc. Inst. Civ. Eng. - Eng. Sustain.** 163, 61–63. doi:10.1680/ensu.2010.163.2.61
- [6] Borst, J.I.M., 2014. *NOW HIRING, wanted: user of tomorrow for space of the future: (Masters)*. Delft University of Technology.
- [7] Brand, S., 1994. *How Buildings Learn: What Happens After They're Built*. Viking.
- [8] Brennan, T., Tomback, D., 2013. *Heritage Works - The use of historic buildings in regeneration*. Historic England, London, UK.
- [9] Bullen, P.A., 2007. Adaptive reuse and sustainability of commercial buildings. *Facilities* 25, 20–31. doi:10.1108/02632770710716911
- [10] Bullen, P.A., Love, P.E.D., 2010. The rhetoric of adaptive reuse or reality of demolition: Views from the field. *Cities* 27, 215–224. doi:10.1016/j.cities.2009.12.005
- [11] Bullen, P.A., Love, P.E.D., 2011. A new future for the past: a model for adaptive reuse decision-making. *Built Environ. Proj. Asset Manag.* 1, 32–44. doi:10.1108/20441241111143768
- [12] Clark, C., 2001. Degrees of physical adaptation: current uses of historic naval building types. *Trans. Built Environ.* 55, 15.
- [13] Davison, N., Gibb, A.G.F., Austin, S.A., Goodier, C.I., Warner, P., 2006. *The multispace adaptable building concept and its extension into mass customisation*. © CIB.
- [14] Douglas, J., 2006. *Building Adaptation, Second Edition, 2 edition*. ed. Routledge.
- [15] Drury, P., McPherson, A., 2015. *Conservation Principles, Policies and Guidance*. Historic England, London, UK.
- [16] Duffy, F., Henney, A., 1989. *The changing city*. Bulstrode Press.
- [17] Dutta, M., Husain, Z., 2009. An application of Multicriteria Decision Making to built heritage. The case of Calcutta. *J. Cult. Herit.* 10, 237–243. doi:10.1016/j.culher.2008.09.007
- [18] Garrett, J., n.d. *Building Regulations - Failure to comply with Building Regulations [WWW Document]*. URL https://www.planningportal.co.uk/info/200187/your_responsibilities/38/building_regulations/3 (accessed 5.1.16).
- [19] Geraedts, R., Van der Voordt, T., 2007. A tool to measure opportunities and risks of converting empty offices into dwellings, in: *W11 – Metropolitan Dynamics: Urban Chan G E, Marke T and Governance*. Presented at the Sustainable Urban Areas, Rotterdam, p. 22.

- [20] Given, L.M., 2008. *The SAGE Encyclopedia of Qualitative Research Methods*. SAGE Publications.
- [21] Gosling, J., Sassi, P., Naim, M., Lark, R., 2013. Adaptable buildings: A systems approach. *Sustain. Cities Soc.* 7, 44–51. doi:10.1016/j.scs.2012.11.002
- [22] Harun, S.N., 2011. Heritage Building Conservation in Malaysia: Experience and Challenges. *Procedia Eng.*, 2nd International Building Control Conference 20, 41–53. doi:10.1016/j.proeng.2011.11.137
- [23] Heath, T., 2001. Adaptive re-use of offices for residential use: The experiences of London and Toronto. *Cities* 18, 173–184. doi:10.1016/S0264-2751(01)00009-9
- [24] Historic England, n.d. Building Regulations Compliance: Listed Buildings and Other Heritage Assets | Historic England [WWW Document]. URL <https://historicengland.org.uk/advice/hpg/compliantworks/buildingregs/> (accessed 5.1.16).
- [25] HM Government, 2016. Housing and Planning Act 2016 [WWW Document]. URL <http://www.legislation.gov.uk/ukpga/2016/22/part/6/crossheading/permission-in-principle-and-local-registers-of-land/enacted> (accessed 8.9.16).
- [26] IStructE, 2008. Guide to surveys and inspections of buildings and associated structures - Articles - The Institution of Structural Engineers. The Institution of Structural Engineers, London, UK.
- [27] Karantonis, A.C., 2008. Population growth and housing affordability in the modern city-Sydney a case study. Presented at the 14th Pacific Rim Real Estate Society Conference, Pacific Rim Real Estate Society, pp. 1–16.
- [28] Kelly, G., Schmidt III, R., Dainty, A., Story, V., 2011. Improving the design of adaptable buildings through effective feedback in use. Presented at the CIB Management and Innovation for a Sustainable Built Environment, Amsterdam, Netherlands.
- [29] Kim, C.-J., Yoo, W.S., Lee, U.-K., Song, K.-J., Kang, K.-I., Cho, H., 2010. An experience curve-based decision support model for prioritizing restoration needs of cultural heritage. *J. Cult. Herit.* 11, 430–437. doi:10.1016/j.culher.2010.03.004
- [30] Kutut, V., Zavadskas, E.K., Lazauskas, M., 2014. Assessment of priority alternatives for preservation of historic buildings using model based on ARAS and AHP methods. *Arch. Civ. Mech. Eng.* 14, 287–294. doi:10.1016/j.acme.2013.10.007
- [31] Lacovidou, E., Purnell, P., 2016. Mining the physical infrastructure: Opportunities, barriers and interventions in promoting structural components reuse. *Sci. Total Environ.* 557–558, 791–807. doi:10.1016/j.scitotenv.2016.03.098
- [32] Langston, C., Smith, J., 2012. Modelling property management decisions using “iconCUR.” *Autom. Constr., Planning Future Cities-Selected papers from the 2010 eCAADe Conference* 22, 406–413. doi:10.1016/j.autcon.2011.10.001
- [33] Lin, G., Low, S., 2012. Influential Criteria for Building Adaptation Potential from the Perspective of Decision Makers. Presented at the 48th ASC Annual International Conference, Birmingham, UK, p. 9.
- [34] London Assembly, 2015. Knock it Down or Do it Up? The challenge of estate regeneration. Greater London Authority, London, UK.
- [35] Mason, R., 2008. Be Interested and Beware: Joining Economic Valuation and Heritage Conservation. *Int. J. Herit. Stud.* 14, 303–318. doi:10.1080/13527250802155810
- [36] Mok, K.Y., Shen, G.Q., Yang, J., 2015. Stakeholder management studies in mega construction projects: A review and future directions. *Int. J. Proj. Manag.* 33, 446–457. doi:10.1016/j.ijproman.2014.08.007
- [37] Natividade-Jesus, E., Coutinho-Rodrigues, J., Tralhão, L., 2013. Housing evaluation with web-SDSS in urban regeneration actions. *Proc. Inst. Civ. Eng. - Munic. Eng.* 166, 194–207. doi:10.1680/muen.12.00022
- [38] Palmer, J., Platt, S., Fawcett, W., Baker, N., Brown, A., de Carteret, R., 2003. Report to the Energy Savings Trust. REFURBISH OR REPLACE? CONTEXT REPORT. Cambridge Architectural Research Ltd, Cambridge, UK.
- [39] Plevoets, B., Van Cleempoel, K., 2011. Adaptive reuse as a strategy towards conservation of cultural heritage: a literature review. pp. 155–164. doi:10.2495/STR110131
- [40] Plimmer, F., Pottinger, G., Harris, S., Waters, M., Pocock, Y., 2008. Knock it down or do it up? Sustainable housebuilding: New build and refurbishment in the Sustainable Communities Plan. BRE Press.
- [41] Remøy, H., Van der Voordt, T., 2006. A new life: transformation of vacant office buildings into housing. Presented at the CIBW70 Trondheim International Symposium, Norwegian University of Science and Technology, Trondheim, Norway, p. 10.

- [42] Schmidt III, R., Eguchi, T., Austin, S., Gibb, A., 2010. What is the meaning of adaptability in the building industry? Presented at the CIB 16th International Conference on Open and Sustainable Building, Bilbao, Spain, p. 10.
- [43] Smith, L., 2016. Planning Reform Proposals (Briefing Paper No. 6418). House of Commons Library, London.
- [44] Thomsen, A., Flier, K. van der, 2009. Replacement or renovation of dwellings: the relevance of a more sustainable approach. *Build. Res. Inf.* 37, 649–659. doi:10.1080/09613210903189335
- [45] Van der Flier, K., Thomsen, A., 2006. Life Cycle of Dwellings: Analysis and Assessment of DEmolition by Dutch Housing Associations. Presented at the ENHR **Conference “Housing in an expanding Europe: theory, policy, participation and implementation,” Ljubljana, Slovenia, p. 18.**
- [46] Wang, H.-J., Zeng, Z.-T., 2010. A multi-objective decision-making process for reuse selection of historic buildings. *Expert Syst. Appl.* 37, 1241–1249. doi:10.1016/j.eswa.2009.06.034
- [47] Watson, P., 2009. The key issues when choosing adaptation of an existing building over new build. *J. Build. Apprais.* 4, 215–223. doi:10.1057/jba.2008.39
- [48] Weber, R., Doussard, M., Bhatta, S.D., Mcgrath, D., 2006. Tearing the City down: Understanding Demolition Activity in Gentrifying Neighborhoods. *J. Urban Aff.* 28, 19–41. doi:10.1111/j.0735-2166.2006.00257.x
- [49] Wilkinson, S., 2011. The Relationship between Building Adaptation and Property Attributes (PhD). Deakin University, Australia.
- [50] Wilkinson, S.J., Remøy, H., Langston, C., 2014. Sustainable Building Adaptation: Innovations in Decision-making, 1 edition. ed. Wiley-Blackwell, Chichester, West Sussex, United Kingdom.
- [51] Yang, R.J., Wang, Y., Jin, X.-H., 2014. Stakeholders’ **Attributes, Behaviors, and Decision-Making** Strategies in Construction Projects: Importance and Correlations in Practice. *Proj. Manag. J.* 45, 74–90. doi:10.1002/pmj.21412
- [52] Yildirim, M., 2012. Assessment of the decision-making process for re-use of a historical asset: The example of Diyarbakir Hasan Pasha Khan, Turkey. *J. Cult. Herit.* 13, 379–388. doi:10.1016/j.culher.2012.01.018
- [53] Yung, E.H.K., Chan, E.H.W., 2012. Implementation challenges to the adaptive reuse of heritage buildings: Towards the goals of sustainable, low carbon cities. *Habitat Int.* 36, 352–361. doi:10.1016/j.habitatint.2011.11.001

Effect of Residential Tower Geometries on Urban Wind Environment

Ruffina THILAKARATNE^a, Paul CHU^b, XIAO Yana^c

^a Chu Hai College of Higher Education, Hong Kong SAR, ruffinaa@chuhai.edu.hk

^b Chu Hai College of Higher Education, Hong Kong SAR, paulchu@chuhai.edu.hk

^c Chu Hai College of Higher Education, Hong Kong SAR, yxiao@chuhai.edu.hk

ABSTRACT

Since 1960s building typologies in Hong Kong demonstrated significant variations in their geometry and size responding to plot ratio amendments. Majority of residential buildings prior to 1990s were of square or rectangular plan form. Since mid-1990s under Comprehensive Development Area policy, “**hyper podium tower**” typology which consists of a 15m high podium with quasi-cruciform plan residential towers above was introduced. Our previous research indicates a reduction in wind speed from 2.97 m/s in 1950s to 2.27 m/s in 1990 (Authors et al. 2016). A sharp drop in the wind speed was evident from 2.27 m/s in 1990 to 1.88 m/s in 2000 which may be attributed to **the emergence of “hyper podium tower” residential typology.**

The study further investigates the impacts created by these quasi-cruciform towers on urban wind environments comparing them with three different residential tower geometries considering two factory estates in Tsuen Wan as prospective redevelopment areas. Hyper podium developments with square towers, cylindrical towers, cruciform towers and cruciform towers with balconies were examined for their impact on urban wind speed. Wind speed was measured at 2m, 30m and 50m heights using a three dimensional urban model of Tsuen Wan as of 2015 development scenario testing with Computational Fluid Dynamics ANSYS Fluent platform.

Cruciform towers and cruciform towers with balconies outperformed wind speed around square and cylindrical towers. Cylindrical towers indicate the lowest wind performance due to the laminar wind flow facilitated by the smooth building envelope. These findings also support the positive impacts created by balconies in residential buildings as a green feature promoting urban ventilation. Findings from this study provides references for designing sustainable and liveable neighbourhoods.

Keywords: urban regeneration, sustainable neighbourhood, building geometries, urban air ventilation

1. BUILDING TYPOLOGIES IN HONG KONG

Evolution of building typologies in Hong Kong is discussed generally and also taking Tsuen Wan new town as a case study. Tsuen Wan is one of the first satellite towns in Hong Kong which is currently undergoing rapid revitalization.

Hong Kong building regulations have been evolving responding to factors that promote health and well-being of citizens and therefore plot ratio amendments. In mid 1930s permissible depth of buildings were reduced to 10.7 m with building height capped at three storeys. In the early 1950s, public housing programmes were introduced to accommodate increasing influx of returning residents. Initial public housing typologies were massive blocks with increased floor area. Private developers entered the market in 1956 and building regulations were further changed allowing taller buildings up to 24.4m high. Realizing the increased density by the massive blocks and their consequences, new building ordinance in 1966 reduced the plot ratio to 8:1 with options to choose higher plot ratio with lower site coverage or lower plot ratio with higher site coverage. Podium and tower typology became a popular option due to 100% site coverage for non-domestic portion.

Since early 1980s, industrial areas in Hong Kong have been transforming from manufacturing to a service and knowledge based economy **due to the decline in industrial sector's contribution to Gross Domestic Production.** With the relocation of industrial estates to Pearl River Delta Region, most these factory buildings were adopted for non-manufacturing and residential purposes. In 1988 Hong Kong inherited approximately 12 million ft² of flatted factories (Colliers, 2011). Tsuen Wan developed as an industrial hub accommodating some of the largest factory estates that exist even to date. In the past fifteen years, Tsuen Wan has been undergoing rapid transformation of these industrial estates and old buildings built in the 1950s. With modified zoning requirements, stand-alone developments have been progressively replaced by mixed use large scale redevelopments which are classified as

'Comprehensive Development Areas (CDA)'. Out of 136 factory zones in Tsuen Wan 52 have been transformed into non-industrial zones (HKSAR, 2011). Old wide roads made for container vehicles and factory blocks were amalgamated and transformed into large blocks with development Plot Ratio of 5 to 6. These modifications to plot sizes and plot ratios adversely impacted on the urban porosity.

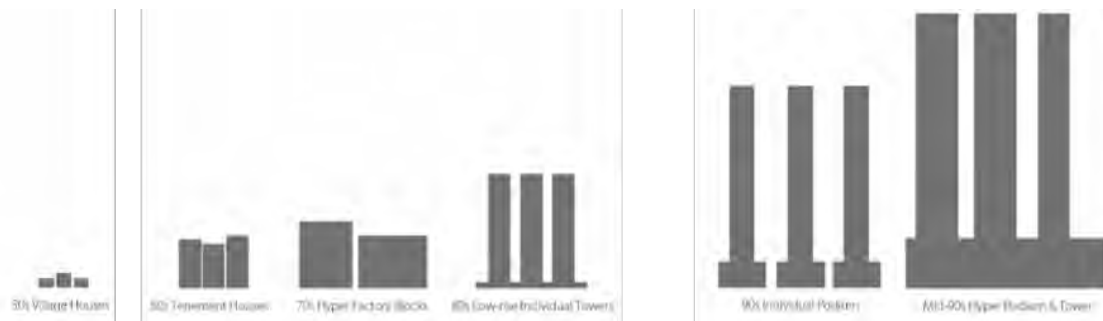

Figure 1: Evolution of building typologies in Tsuen Wan from 1950s to 2015

In Hong Kong distance between building blocks is governed by the vertical light angle requirement of 71.5 for habitable areas with a minimum 10% glazing area out of the floor area. As a result, distance between buildings became narrower resulting on lack of air and light penetration into lower levels.

1.1 Emergence of cruciform and quasi-cruciform residential typologies

In private residential developments, in order to maximize the gross floor area within given plot ratios, residential typologies began to evolve into plan forms that deliver higher spatial efficiency and daylight and natural ventilation penetration. Hong Kong building regulations stipulate minimum perpendicular distance between windows of habitable rooms in different blocks within the same site. Cruciform plan form and its mutations were the most feasible option; staggering building envelope of cruciform plan eliminates perpendicular obstruction between towers although adjacent towers are closely built. Most these developments also consisted of external features such as protruding drying racks, bay windows, planter boxes etc.

Most developments adopted bay windows instead of balconies as bay windows were exempted from the gross floor area (GFA) calculations. In 2001, GFA exemption was granted for balconies; 50% of balcony area that is not less than 2 m² became a value added sustainable feature in many new developments (Buildings Department, n.d.). Majority of hyper podium residential towers in Hong Kong are of cruciform geometries in order to increase number of flat units per floor that have daylight access.

For the purpose of this study, we calculated building volumes of square, rectangular and cruciform plan tower developments in Tsuen Wan as of 2015. Figure 2 indicates the predominant presence of quasi-cruciform towers in Tsuen wan compared to square plan form and rectangular plan form building volumes. Cruciform developments consist of 19.16 million m³ whilst square representing 5.6 million m³ and rectangular plan form towers representing 12.6 million m³.

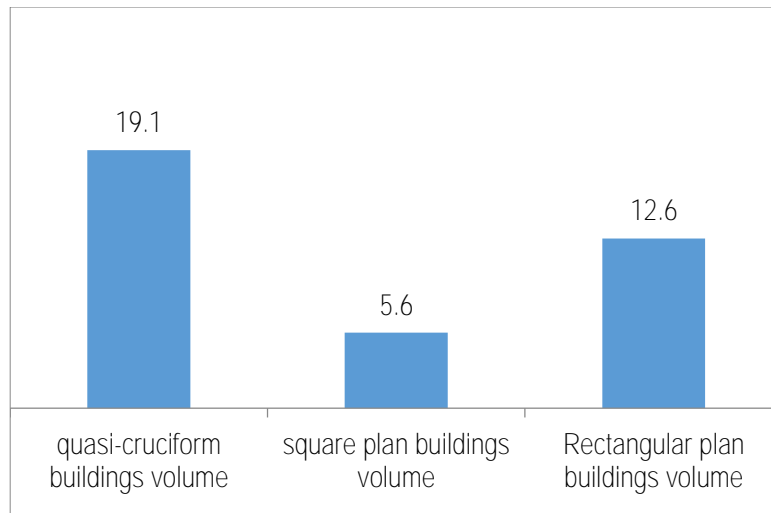

Figure 2: Building volumes three different building geometries in Tsuen Wan in 2015 in million m³

2. RESEARCH DESIGN PARAMETERS

A factory estate within Tsuen Wan that has prospects for redevelopment was considered as the experimental site: this existing factory estate was hypothetically replaced with eight podium developments that consists of 37 towers. These towers represented four variations of building geometries that were simulated for wind performance. These four variations are: square plan towers, quasi-cruciform plan towers, cylindrical towers and quasi-cruciform towers with balconies (Figure 3). Wind performance at 2m pedestrian level, 30 m and 50 m height above ground level was measured. All buildings were approximately similar in floor plate area and distance between towers.

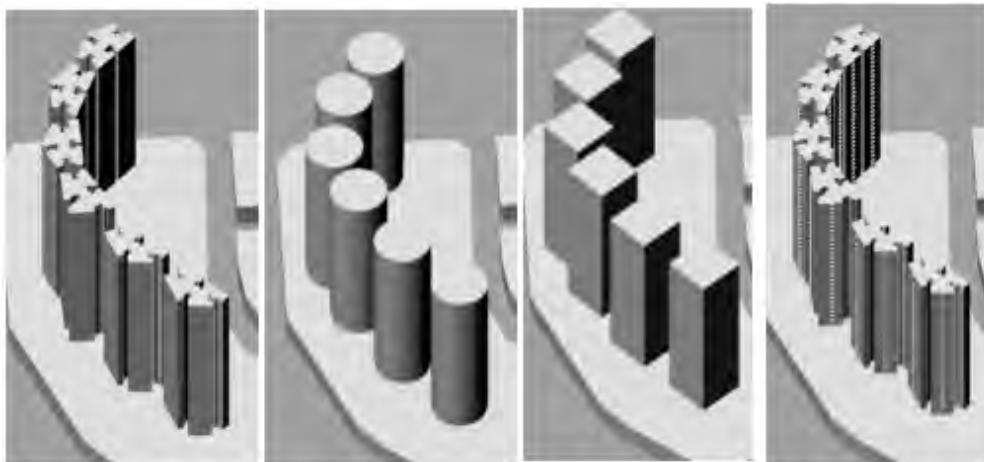

Figure 3: Four different building geometries tested for their impact on urban ventilation

2.1 Wind simulation parameters

All protocols stipulated in Hong Kong Air Ventilation Assessment Framework were followed in setting parameters. Simulations under seven strongest wind directions (E, ESE, ENE, NE, SE, S, and SSW) that represent over 76% of annual wind frequency were carried out for each case.

Inflow wind profiles are adopted from RAMS data from Hong Kong Planning Department's website. Inflow turbulent kinetic energy profile and corresponding dissipation rate profiles are estimated using the following equations where u^* is the frictional velocity, $C_\mu = 0.09$ and $\kappa = 0.4$.

$$k = \frac{u_*^2}{\sqrt{C_\mu}} \quad \varepsilon = \frac{u_*^3}{\kappa(z+z_0)}$$

Equation 1

Computation Fluid Dynamics ANSYS FLUENT solver (Fluent Inc., 2006) with the Realizable k-ε turbulence model was used for wind simulation adhering to the parameters described in Hong Kong Air Ventilation Assessment framework. Strength of the Reynolds number is referred to explain laminar and turbulence air flows. The model spans a distance of 2700m with inflow wind velocity of 6 m/s at boundary layer height, as for the formula of Reynolds number

$$Re = \frac{UL}{\gamma}$$

Equation 2

In which, U = Length Scale (Order of 10² to 10³) for Tsuen Wan district, the length scale is around 2700 meters for our study area.

L = Flow Velocity (Order of 10⁰) from our wind velocity profile, around 6 m/s for inflow wind velocity at boundary layer height.

γ = Kinematic Viscosity of Air (1.72* 10⁻⁵). Therefore, the simulations were carried out under high Reynolds number of order of magnitude of 10⁹

Unlike in a building scale AVA study, in a city scale study it is important to adopt a practicable and reasonable resolution and a scale for simulation. Typically recommended 8million cell resolution did not facilitate smooth operation of the software for this city scale analysis warranting an increased resolution of 15million cells. Selection of an appropriate turbulence model is crucial in CFD simulation studies. RANS k-ε k-ε family steady turbulence model are commonly practiced for carrying out parametric studies on wind flow problems. Out of the three variations of RANS k-ε k-ε models, 'Realizable k-ε model' proposed by Shih et al. (1995) were adopted due to its ability in predicting more physically realistic turbulence properties with a varying model coefficient of C_μ which modifies the turbulent viscosity term. Following the recommendations in CFD guidelines (Franke, 2007; Tominaga, et al. 2008; Mochida et al., 2002), the study adopted a rectangular computational domain with symmetric boundary conditions at the two side boundaries and the upper boundary. For our computation, the inflow boundary condition is set as the velocity inlet boundary condition and the outflow boundary as the outflow condition. Unstructured tetrahedral cells of approximately 8-15 million with maximum expansion ratio were created in the mesh with other settings as referring to the COST Action C14 (Franke et al., 2011) and the Architectural Institute of Japan (AIJ) guidelines (Tominaga et al., 2008; AIJ 2007).

3. EFFECT OF BUILDING GEOMETRIES ON WIND SPEED

3.1 Urban ventilation trends from 1960 to 2015

This study examined the effect of building geometries on urban wind speed taking into consideration three different plan form variations and one variation with balconies. In order to establish a rational and scope, this study also developed historical wind profiles from 1960 to 2015 considering urban fabric changes in every ten years and historical wind profiles from 1997 to 2015 to verify results with every three-year development changes in Tsuen Wan city centre (Figure 4).

Progressive developments in Tsuen Wan new town resulted in the reduction in urban porosity from 51% unbuilt area in 1960 to 6.1 unbuilt area in 1990 negatively impacting on the pedestrian zone wind speed. Weighted average scores from fifty strategically placed test points within the study area reported a decline in pedestrian wind speed in parallel to reduction in unbuilt areas. However, the reduction in wind speed was 0.7 m/s from 1960 to 1990 in parallel with approximately 45% reduction in urban porosity, compared to the sharp drop in the wind speed from mid 1990s onwards (Figure 5).

Two significant development typologies attributed to this noticeable decline in the wind speed; a decline from 2.97 m/s to 2.5 m/s with the introduction of 'hyper factory blocks' in the 1970s followed by another sharp decline from 2.27 m/s to 1.88 m/s with the introduction of 'hyper podium and tower' developments in mid 1990s. Approximately 1.1 m/s reduction in the wind speed can be observed in the year 2000

compared to 1960s (Figure 5). Alarming impacts from hyper podium developments calls for attention to the way we design buildings.

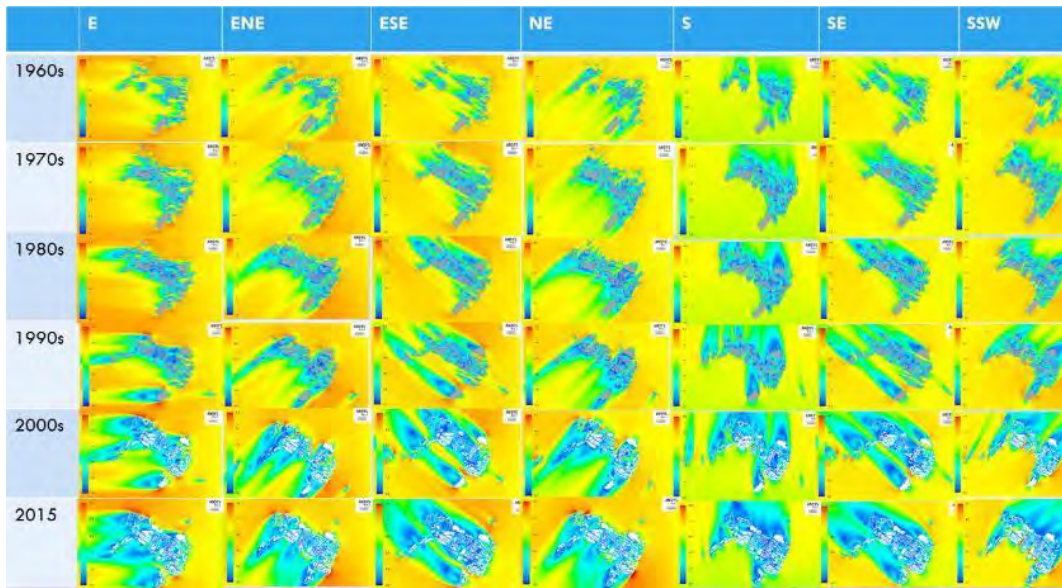

Figure 4: Ten year interval historical wind profiles from 1960 – 2015

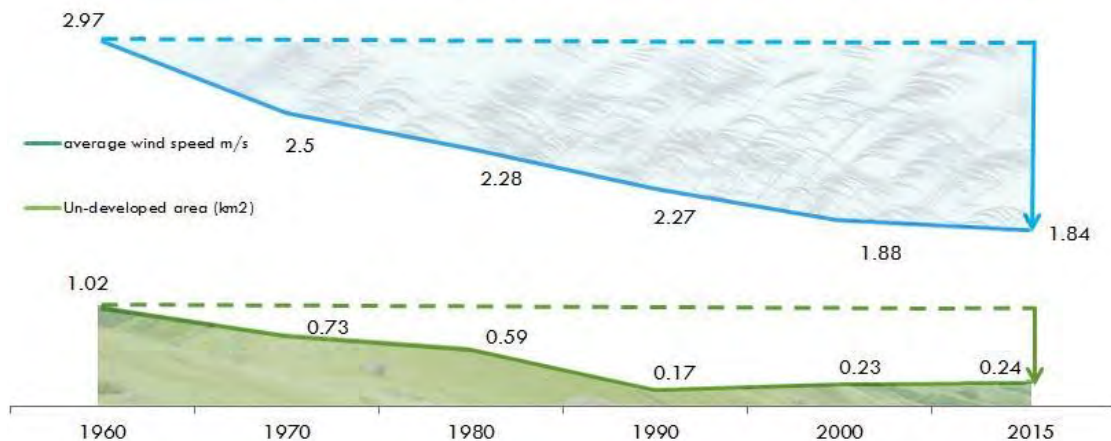

Figure 5: Correlation between pedestrian level ventilation and reduction in undeveloped land area in Tsuen Wan from 1960 – 2015

3.2 Creating sustainable neighbourhoods with better urban ventilation

Thermal comfort is a key consideration when designing liveable and sustainable neighborhoods. Poor air quality, urban heat island effect and extremely high humidity levels are some of the factors attributed by stagnant urban ventilation levels effecting liveability in urban Hong Kong. Effect of building geometries have been studied as a means of manipulating urban ventilation (Norberg, C.1987, Williamson, C. 1996). Findings reported distinct wind behavior patterns around these four building geometries with cruciform towers and cruciform towers with balconies reporting higher wind speeds around them compared to cylindrical and square towers. Results were consistent at 30m height and 50m height. These findings are supported by a study conducted by Montazeri, H. et al. (2013) which reports the contribution of uniform second skin façade to equalize wind pressure in balconies in high wind zones. Cylindrical forms facilitate more steady streamlined flow or laminar air flow around the surface. Whereas cruciform geometries facilitate erratic air flow around the edges due to resistive forces thereby creating air turbulence increasing wind speed around the buildings. In cruciform geometry, the envelope is rougher and therefore the friction between air and the envelope is higher; greater the friction between the layers, greater the drag. Results also indicate improvement in wind performance at upper zones compared to lower zones due to ground level friction which behaves differently from building envelope friction. Wind speed at the pedestrian zone can be unpredictable due to urban roughness variations; however, wind speed results at 2m high zone is seemingly consistent with 30m and 50m high zones.

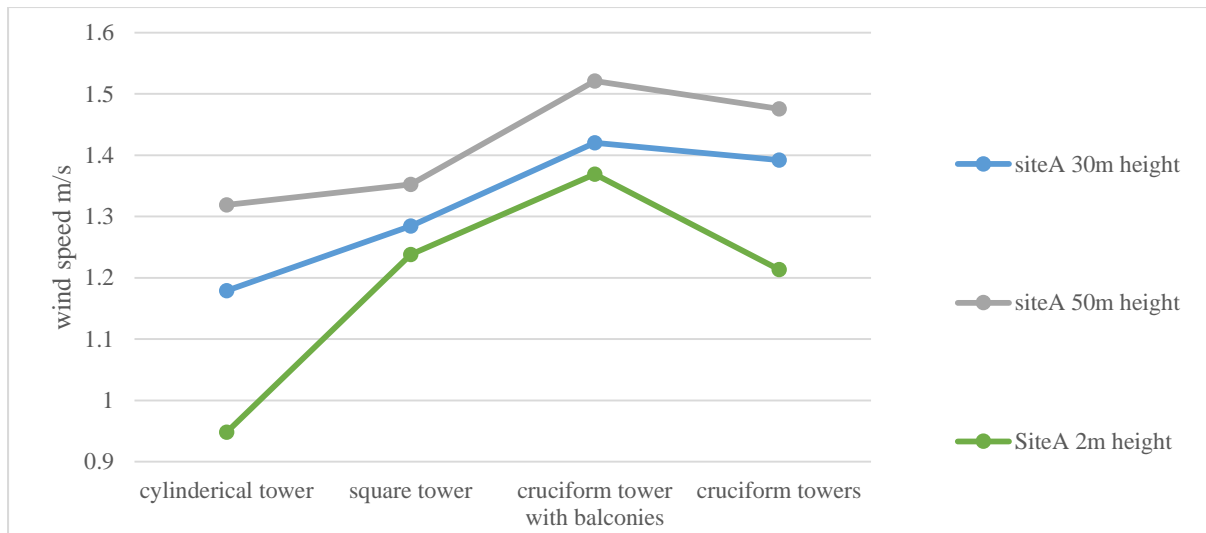

Figure 6: Building geometry impact on wind speed at different height zones

4. CONCLUSIONS

This study established a correlation between urban porosity and urban wind speed and the impact from various building typologies on wind speed since 1960 until 2015. Wind simulation results in the year 2000 indicated adverse impacts on wind environment by hyper podium tower developments emerged in mid 1990s. Adverse impacts were also notable around massive podiums due to wind amplification on the windward side. Cruciform towers reported better wind movement around them, however the gap between these towers influence ventilation levels.

This study contributed to the advancement in built environment knowledge by developing historical wind profiles from 1960-2015 and identifying the effect of development trends and building typologies on urban ventilation. Results from 3 year interval analysis and 10 year interval analysis confirm the adequacy of 10 year interval analysis for development of historical wind profiles at city scale. These findings may serve as a reference for future development of sustainable and liveable neighborhoods with improved outdoor thermal comfort.

Findings from this study established the contribution from cruciform towers and balconies as a green feature in improving urban ventilation speed thereby their creating sustainable neighborhoods. Findings also call for review of residential development and CDA policy in order to create desirable pedestrian wind environments and thermal comfort levels.

REFERENCES

- [1] Architecture Institute of Japan (2007) Guidebook for Practical Applications of CFD to Pedestrian Wind Environment around Buildings. Available at: http://www.aij.or.jp/jpnublishcfdguide/index_e.htm
- [2] Authors et al. (2016). 'Optimization of Hong Kong Residential Building Design Guidelines to Improve Urban Air Ventilation'. Fifty years later: Revisiting the role of architectural science in design and practice: 50th International Conference of the Architectural Science Association 2016, Adelaide, Australia
- [3] Buildings Department (n.d) Green and Innovative Buildings: Joint Practice Note No. 1. Available at: <http://www.bd.gov.hk/english/documents/joint/JPN01.pdf>
- [4] Colliers (2011) Research and Forecast Report: Hong Kong industrial market, Q2 2011. Available at: <http://www.colliers.com/~media/files/marketresearch/apac/hongkong/hk-research/hk-industrial-2q-11.pdf>
- [5] Franke, J. et al. (2011) 'The COST 732 Best Practice Guideline for CFD simulation of flows in the urban environment: A summary', International Journal of Environment and Pollution, 44(1-4), pp. 419-427
- [6] Franke, J. et al. (eds) (2007) Best practice guideline for the CFD simulation of flows in the urban environment. Brussels, Belgium: COST Office Brussels.
- [7] HKSAR (2011) Seminar on Office Development in Hong Kong: Revitalisation of Industrial Buildings—An Update, 12 March 2011. Available at: https://www.devb.gov.hk/filemanager/en/content_68/Presentation-Carrie%20Lam-f.pdf

- [8] **Mochida, A. et al. (2002) 'Comparison of various k- ϵ models and DSM applied to flow around a high-rise building—report on AIJ cooperative project for CFD prediction of wind environment', *Wind and Structures An International Journal*, 5(2-4), pp. 227-244.**
- [9] **Montazeri, H. et al. (2013) 'CFD evaluation of new second-skin facade concept for wind comfort on building balconies: Case study for the Park Tower in Antwerp', *Building and Environment*, 68, pp. 179-192. doi: 10.1016/j.buildenv.2013.07.004.**
- [10] Norberg, C. (1987) Effects of Reynolds number and a low-intensity free-stream turbulence on the flow around a circular cylinder, Publication No. 87/2, Department of Applied Thermodynamics and Fluid Mechanics, Chalmers University of Technology, Sweden.
- [11] Shih, T.-H. et al. (1995) 'A new k- ϵ eddy viscosity model for high reynolds number turbulent flows', *Computers & Fluids*. Pergamon, 24(3), pp. 227-238. doi: 10.1016/0045-7930(94)00032-T.
- [12] **Tominaga, Y. et al. (2008) 'AIJ guidelines for practical applications of CFD to pedestrian wind environment around buildings', *Journal of Wind Engineering and Industrial Aerodynamics*, 96(10), pp. 1749-1761. doi: 10.1016/j.jweia.2008.02.058.**
- [13] **Williamson, C. (1996) "Vortex dynamics in the cylinder wake," *Annual Review Fluid Mechanics*, 28, 477-539.**

Health Co-Benefits of Low Carbon Policies in the Built Environment: An Australian Investigation into Local Government Co-Benefits Policies

Sardar Masud KARIM^a, Susan THOMPSON^b, Peter WILLIAMS^c

^a The University of New South Wales (UNSW), Australia, s.karim@student.unsw.edu.au

^b The University of New South Wales (UNSW), Australia, s.thompson@unsw.edu.au

^c The University of New South Wales (UNSW), Australia, p.williams@unsw.edu.au

ABSTRACT

Purpose: Evidence suggests that in the area of public health, action on climate change can bring multiple health co-benefits. In Australia, while the 'co-benefits approach' is adopted by local governments in pursuing low carbon policies, the approach is limited in targeting certain 'energy-related' monetary benefits. 'Non-climatic and non-energy-related' benefits, which include significant health-related gains, rarely enter climate change-related policy discourse. This paper addresses the gap by contributing to current understanding of the 'co-benefits approach' in the Australian local government context. The aim is to determine whether, how and to what extent local governments' low carbon policies embrace the public health needs of their communities by targeting health-related co-benefits as an integral part of broader sustainable development strategies. The paper also provides an insight into the Australian local government policy context to enable better understanding of how to plan, generate and promote health-related co-benefits for urban built environments.

Methodology: The research methods comprised a comprehensive online survey and review of NSW councils' climate change-related policies, as well as interviews of selected council officers.

Findings: The findings show that NSW local governments' climate change-related policies rarely consider whether their greenhouse gas reduction strategies also yield health co-benefits. In many instances, the net co-benefits of health are not identified, let alone measured by local governments. In the majority of councils, climate planning activities and work on public health are happening separately and in parallel, rather than through an integrated approach.

Conclusions: The results of this study suggest the need for a clear policy direction from the State to local governments to link climate change planning with health; inter-agency coordination and training to conduct health analyses; development of tools, methods for identifying, quantifying, and incorporating health-related co-benefits; and regulatory or statutory changes to support actions in certain areas which are currently beyond local governments' sphere of control.

Keywords: Australia, built environment, climate change, health co-benefits, health and wellbeing, liveability, local government, low carbon policy, urban planning

1. INTRODUCTION

While climate change continues to be the hotly contested around the world, the 2015 Paris Climate Agreement has shifted the focus of this debate. There is now acceptance of the scientific certainty of climate change but disagreement identifying appropriate policy responses to mitigating climate change (Lewis, 2015). An urgent, high-priority global response is required through international negotiation of coordinated national policies for large-scale reduction in global emissions. At the national level policy-makers are now faced with the challenge of balancing the immediate interests of development needs with the long-term interests of stabilising the global climate.

On the one hand, climate change is a global commons problem that warrants a coordinated global response (Edenhofer et al., 2013; Ostrom et al., 1999). On the other hand, its source, greenhouse gas (GHG) emissions, is increasingly seen as being produced and most readily controlled at the local level (Revi et al. 2014). Achieving particular mitigation goals, such as limiting warming to 2°C, is most cost effective when approached from a worldwide perspective and results in high long-term international benefits at considerable short-term costs (Clarke et al., 2009). However, most climate policies are increasingly formulated at national and even local levels, where many of the non-climate objectives are often more salient as policy drivers (Dubash et al., 2013; Seto et al., 2014;

Somanathan et al., 2014). Because most co-benefits, unlike the primary benefit of greenhouse gas mitigation, are enjoyed typically at regional or local scales, are closer to the agents bearing the mitigation costs (typically the taxpayers and/or the consumers), have more immediate welfare effects (Markandya and Rübbecke, 2003) and easier to measure. Hence, they provide incentives for decision makers to engage in stricter climate action and are considered more politically feasible.

Hence, local governments are uniquely positioned to create large reductions in GHG emissions because of their impact on local patterns of urban development, economic activity, transportation infrastructure, and energy use (Rosenzweig, et al. 2010; Anguelovskik and Carmin 2011). However, the primary focus on cost minimisation at the local government level has largely limited climate policies targets to reducing GHG emissions cost, together with **the attainment of 'energy-related' monetary savings. In Australia, while the 'co-benefits approach' is adopted by local government in pursuing low carbon policies, the focus is largely economic. Non-climatic and non-energy-related benefits, which include significant human health outcomes from better air quality, active transport uptake, improved 'liveability' and the creation of local jobs (IPCC 2014, Woodcock et al. 2009; and Hickman 2013), rarely enter climate change-related policy discourse. Indeed, there is limited understanding of these co-benefits in the Australian context (Philp, Taylor and Thompson 2015).**

The purpose of this article is to determine whether, how and to what extent Australian local governments' climate change-related policies consider the public health needs of their communities. Do policies target health-related co-benefits as an integral part of broader sustainable development strategy? The paper also provides an insight into the Australian local government policy context to enable better understanding of how to plan, generate and purposively promote health-related co-benefits in planning urban built environments.

1.1 Emergence of co-benefits in climate change mitigation

The 'co-benefits concept' emerges internationally as an important paradigm for analysing, developing and implementing policies and strategies that simultaneously contribute to tackling climate change whilst addressing local environmental and developmental problems. The concept is not rigid with clearly identifiable boundaries and there is no common definition of 'co-benefits' in the academic literature. In policy discourse, positive impacts of policies and programs that occur in addition to the intended primary policy goal are commonly considered as co-benefits. However, in climate change-related policy discourse co-benefits are widely understood as the collection of benefits accruing to actions linking climate change and other development priorities. This understanding is based on the definition of co-benefits found in the Intergovernmental Panel on Climate Change (IPCC)'s Third Assessment Report where co-benefits are defined as:

"the benefits of policies that are implemented for various reasons at the same time – including climate change mitigation – acknowledging that most policies addressing greenhouse gas mitigation have other... equally important rationales" (Metz et al., 2001).

This definition focuses on simultaneous effects of policies specifically introduced with explicit intention to integrate climate change response benefits with other fields. According to **this definition the 'explicit intention' and integration of policy measures are considered essential in order to qualify for a 'co-benefit principle'. We adopt this definition of 'co-benefits' as it appropriately suits the scope and objectives of this paper.**

Over the past two decades, a growing number of studies have demonstrated that a 'co-benefits approach' could prove more cost effective than managing climate and development issues in isolation (Davis et al., 2000; Pacala et al., 2010; Burtraw et al., 2003). With increasing global attention and interest in mitigating GHG emissions since the 1990s, several studies indicated that GHG mitigation policy co-benefits could be the same order of magnitude as the cost of implementing the policies (Davis et al., 2000, Pacala et al., 2010). Several studies around the turn of the millennium found that co-benefits could significantly reduce the net costs of GHG reduction efforts (Burtraw et al., 2003). These studies demonstrate that 'Co-benefits approach' has the strength to reframe climate change mitigation in a positive and constructive 'win-win' way and thereby prevents framing issues in terms of trade-offs. In this respect, 'co-benefit approach' has the potential to become more relevant as an alternative paradigm which can be positioned complementarily to the post-Kyoto evolving global climate policy regime. Co-benefits are relevant not only for the economics of climate change mitigation, but also for the politics of climate policy-related decision making.

1.2 Climate change and health in Australian local government

In Australia, there are unique challenges to addressing climate change with respect to health and wellbeing. There is limited understanding and public awareness of the link between health and climate change, although this is changing with the work of The Climate and Health Alliance (Woodcock et al., 2009). Nevertheless, the health implications of climate change have been given a relatively low priority in climate change-related policy debate (Smith and Capon, 2011).

Climate change is unlikely to cause new health problems for city populations, rather, it will exacerbate existing urban health problems (Bambrick et al., 2008; Friel et al., 2011). The health impacts of climate change will be influenced by a range of factors such as environment, socioeconomic circumstances (at country, regional and personal levels), infrastructural and institutional resources, underlying physical vulnerabilities and local preventive (adaptive) strategies (IPCC, 2014).

This will be significant for Australia as it already experiences climate extremes in temperature and rainfall that are projected to become even more extreme (Climate Commission, 2011; Bureau of Meteorology, 2012; CSIRO, 2007; Climate Commission, 2013). Further, Australia is one of the most highly urbanised countries in the world with over 89% of the population living in cities (Commonwealth of Australia 2010a). With the population projected to grow 40% to 35 million by around mid-century, the way Australian cities perform environmentally, socially, economically and physically will largely determine the magnitude of the health impacts from climate change (Commonwealth of Australia, 2010b).

While the health system will have its role to play in planning services to mitigate these health impacts (Burton et al. 2014; Ebi et al. 2006), **the local councils collectively tasked with planning the nations' cities, will need to play a major role in mitigating the health impacts of climate change** (Capon 2010; Frumkin 2002) working in collaboration with health agencies across government, private and the not-for-profit sectors.

Although local government has limited power and resources to provide health services, many councils provide a range of direct health services to their communities which respond to varying local needs and conditions. Councils also provide a number of services generally not considered to be directly related to health, but they nevertheless deliver clear and demonstrable local health benefits. For example, council health associated services include, but are not limited to: municipal waste collection; food inspection; (in some states) the provision of maternal and child health centres; immunisations; programs to encourage community health and fitness, such as nutrition awareness and healthy weight loss programs; the establishment and/or maintenance of sports and recreation facilities, bicycle paths, and walking tracks; and traffic calming measures (CoA, 2010; NSW, 1993).

The link between climate change and health is not however well recognised at the local level. For example, the NSW government identified the roles local councils could play as key actors in adapting to the local impacts of climate change in the NSW Greenhouse Plan (NSWGHP). The NSW Local Government Act 1993 provides councils with an extensive list of functions, many of which could potentially be affected by climate change. For example, councils control land use, development and building in their areas; and they manage and maintain infrastructure, such as roads, bridges, public buildings, recreational areas, storm water systems, water supply and waste facilities. Thus, councils are considered ideally placed to provide a localised response to the climate problem (CoA, 2010; NSW, 1993) but the potential to address health issues in this context is not broached.

Within this context, from a local government perspective, environmental services, health services, health promotion and preventive health policies, should not be seen in isolation. Climate and health policy and programs at the local government level, therefore, must be integrated to address climate change with respect to health and well-being.

2. METHODOLOGY

This research used a combination of qualitative and quantitative methods. Qualitative research involved documenting and critiquing information from the literature, a desktop review and analysis of policy documents available in the public domain, and conducting in-depth interviews. Quantitative research involved assessment of data from a comprehensive on-line survey questionnaire.

The geographic area of investigation for this study was the Sydney Greater Metropolitan Region (GMR) and surrounding localities (See Figure 1). The investigation focused primarily upon policy processes at local government level, but the research also looked into the links of local to state, and broader national processes.

The research comprised three distinct phases. Phase one was a comprehensive online survey. Phase two comprised the desktop review and analysis of the selected council policy documents. Phase three was the in-depth interviewing of selected council officers.



Figure 1: Geographic scope: Sydney Greater Metropolitan Region (GMR) and surrounding local governments in NSW
Source: Department of Planning & Environment (2014). A plan for growing Sydney

SUB REGIONS		NO OF COUNCILS	RESPONDENTS	TOTAL	RESPONSE RATE (%)
GREATER METROPOLITAN REGION (GMR)	Central	41	10	38	92.68%
	West Central		6		
	West		3		
	North		10		
	South West		4		
	South		5		
BEYOND GMR	Central Coast	111	2	37	33.33%
	Illawarra		4		
	North Coast		8		
	New England North West		3		
	Orana & Central West		4		
	South East & Tablelands		6		
	Murray-Murrumbidgee		5		
	Far West		1		
	Other		4		

Table 1: Distribution of participated councils in on-line survey

2.1 Selection of councils with local climate change policies

The first stage of phase one was a targeted on-line survey of councils using a comprehensive questionnaire. This was conducted from July to December 2015. Based on the policy responses to climate change found in the survey, participating councils were categorised into three distinct groups. Councils who have:

Category A: Specific Climate Change Policy;

Category B: Climate Change Addressed Broadly Under 'Sustainability' (but no specific policy for climate change); and

Category C: No Climate Change Policy (but measures adopted mainly to reduce energy consumption which results in GHG reduction and other benefits). (See Table 2)

Subsequently, a data-driven set of three indicators were developed to assess the extent of policy responses to climate change and targeted policy benefits. These indicators are: i) Types of mitigation measures; ii) Policy integration; and iii) Targeted co-benefits. This information was then used in two ways in analysing the findings.

First, the total number and percentage of councils undertaking measures related to each indicator were calculated. **This information is collectively presented to give an overall picture of the extent of adoption of a 'co-benefits approach' across the three categories of councils. This gives a broad quantitative picture rather than an assessment of the quality of each measure under the three indicators (see Table 2).**

Councils were then selected from the three categories to evaluate in detail their climate change policies. The objective was to determine whether, how and to what extent, these policies target health-related co-benefits alongside other benefits (see Table 3).

2.2 Evaluation of council climate change policies for health co-benefits

In phase two, a qualitative review of selected council (as identified in phase one) climate change policies and plans was undertaken. The purpose of this review was to examine specific climate change-related and emissions reduction measures and their associated health-related co-benefits. An assessment of all aspects, actions and benefits of each policy document was not undertaken.

In phase three, in-depth interviewing of selected council officers (n = 11) was conducted from February to May 2016. The investigation specifically focused on exploring and understanding the variation in council policy responses to climate change across NSW. Of particular interest were the range of benefits obtained through the **policies and council perceptions of the 'co-benefits approach', especially with respect to health-related co-benefits** in the climate policy making process.

This study was approved by the University of New South Wales (UNSW) Human Research Ethics Committee.

3. RESULTS

In this section, findings are presented from the data generated by the online survey. This reporting is supported with analysis from the review of policy documents identified in the survey and key findings from interviews of selected council officers.

Out of the 152 NSW councils, 75 participated and completed the survey. Among the 75 councils: 38 are from the GMR of Sydney (out of total 41 GMR councils) and the remaining 37 councils are from across the surrounding areas beyond the GMR (see Table 1).

3.1 Variations in council climate change policies and targeted co-benefits

In terms of policy responses, the overwhelming majority of councils in NSW (i.e. 86.3% or 63 of the 73 respondents) reported they have some form of policy in place to address climate change. Conversely, only 13.69% (n = 10) reported they have neither a policy nor any action plan to address climate change. Only 56.16% (n = 41) councils **reported that they have a 'specific climate change policy' (see Table 2).**

COUNCILS' RESPONSES TO CLIMATE CHANGE		LOCATION OF COUNCILS		TYPES OF MITIGATION MEASURES			INTEGRATION WITH OTHER POLICIES		TARGETED CO-BENEFITS			
		GMR (n = 38)	Beyond GMR (n = 37)	Energy related	Non energy related		Integrated	Not integrated	Climatic and Energy related		Non-climatic and non-energy related	
					Waste	Active transport			Economic	Environmental	Health	Social
CATEGORIES OF COUNCILS	A. Specific Climate Change Policy (n=41)	22	19	40	37	33	25	16	41	39	07	09
	B. Climate Change Addressed Broadly Under 'Sustainability' (n=22) (but no specific policy for Climate Change)	11	11	22	19	11	13	09	21	21	04	05
	C. No Climate Change Policy (n=10) (but measures undertaken to reduce energy consumption that also result in GHG reduction)	05	05	08	06	03	01	07	07	05	00	02

Table 2:

It was found that councils who perceived climate change as a major policy issue by adopting a specific or dedicated climate change policy (n=41, 56.16%), managed to enhance their climate change actions by targeting more areas. This is evident from the data which show that councils with a specific climate change policy more effectively integrated climate change actions across different sectors in a consistent manner. This results in achieving maximum policy benefits compared to councils that do not have a dedicated climate change policy (n=22, 30.13%) (see Table 2, row A, B). Councils which do not have either a dedicated policy or strategy for climate change, **generally address 'climate change' under the term 'sustainability' as one of the many components of their Community Strategic Plan (CSP)** (see Table 2, row B).

Generally, it is observed that councils located in the GMR with higher populations (over 50,000 inhabitants) are undertaking more climate change-related activities which result in more benefits than councils which are located outside the GMR with smaller populations (less than 15,000 inhabitants) (see Table 3).

COUNCILS' WITH CLIMATE CHANGE POLICIES	POPULATION *	TYPES OF MITIGATION MEASURES			INTEGRATION WITH HEALTH		TARGETED CO-BENEFITS				
		Energy related	Non energy related		Integrated	Not integrated	Climatic and energy related		Non-climatic and non-energy related		
			Waste	Active transport			Economic	Environmental	Health	Social	
GMR Councils (n=22)	Bankstown	L	●	●		●		●	●		
	Black Town	L	●	●	●		●	●	●	●	●
	Camden	L	●	●			●	●	●		
	Campbelltown	L	●	●	●		●	●	●	○	
	Canada Bay	L	●	●	●		●	●	●	●	
	Canterbury	L	●	●	●	●		●	●	●	●
	Fairfield	L	●	●	●		●	●	●	○	
	Hornsby	L	●	●	●	●		●	●	○	
	Ku-ring-gai	L	●		●	●		●	●	○	
	Leichhardt	L	●	●	●	●		●	●	●	●
	Manly	M	●	●	●	●		●	●	○	
	Marrickville	L	●	●	●	●		●	●	○	
	North Sydney	L	●	●	●	●		●	●	○	●
	Parramatta	L	●	●	●		●	●	●	○	
	Penrith	L	●	●	●		●	●	●	○	
	Pittwater	L	●	●	●	●		●	●	●	●
	Randwick	L	●	●	●	●		●	○	○	●
	Ryde	L	●	●	●	●		●	●	○	●
	Strathfield	M	●	●	●	●		●	●	○	
	Sydney	L	●	●	●		●	●	●	○	
Warringah	L	●	●	●	●		●	●	○		
Beyond GMR Councils (n=19)	Armidale Dumarasq	M	●	●	●	●		●	●	●	●
	Ballina Shire	M	●	●	●		●	●	○		
	Bega Valley	M	●		●	●		●	●	○	
	Bellingen Shire	S	●			●		●	●		
	Byron	M	●	●	●	●		●	●	○	
	Clarence Valley	L	●	●	●	●		●	●	○	
	Coffs Harbour	L	●	●	●	●		●	●	○	
	Eurobodalla	M	●	●	●	●		●	●	○	
	Gosford	L	●	●	●		●	●	●	○	
	Greater Taree	M	●	●	●		●	●	●	●	
	Kiama	M	●	●			●	●	●		
	Kyogle	S	●	●	●		●	●	●	○	
	Lake Macquarie	L	●	●	●	●		●	●	○	
	Maitland	L	●	●			●	●	●		●
	New Castle	L	●	●	●		●	●	●	○	
	Queanbeyan	M	●	●		●		●	●		
	Shoalhaven	L	●	●			●	○			
	South East & Table Lands	S	●	●	●	●		●	●	○	
	Tweed Shire	L	●	●	●	●		●	●	○	
Wollongong	L	●	●	●	●		●	●	○		

Table 3: Targeted co-benefits of councils' climate change policies

3.2 Preference for 'climate- and energy-related' co-benefits over 'non-climate- and non-energy-related' co-benefits

While councils in NSW generally do not purposively adopt a 'co-benefits approach', nor explicitly mention this in any of their policies, adoption of a 'co-benefits approach' is clearly evident in the wide range of benefits resulting from these policies (see Table 2, column - Targeted Co-benefits). The response of one of the interviewed council officers illustrates this well:

... anything that we [council] can do is to refer to the objectives in the community strategic plan... [and]... these are related to environmental and social objectives... when we are producing policies we have to give alignment to these objectives and... all [are] about [technically] environment, efficiency with use of resources, caring inclusive communities... that's the main avenue to demonstrate how a proposal is proposing to align with those objectives we need to deliver as a council... it [co-benefits approach] is not formalised. There is no clear tool to say what the co-benefits are. You are simply putting words together to have a strategic reason to implement a policy and then whether the policy gets delivered or not that is another question. (Council officer interview 2016)

Irrespective of whether councils have any specific climate change policy or not, most were found to pursue measures that relate to climate change. Many of these measures relate to mitigation (see Table 2, column – Types of Mitigation Measures). While these measures are not always 'explicitly intended' to reduce GHG emissions, their adoption generally results in reduction of emissions as a 'co-benefit' along with the specific benefits targeted by these measures.

The indicator for adopted 'Mitigation Measures' (n = 179) illustrates a clear preference for 'energy-related mitigation measures' (n = 70; 39%) among the majority of councils compared with other mitigation measures such as 'active transport' (n = 47; 26%) (see Table 2). The potential for reducing consumption of energy, and therefore, GHGs, as well as making significant monetary savings, predominantly motivated this adoption of 'energy-related mitigation measures'.

As councils predominantly consider 'financial savings' as the main criterion for the selection of measures to reduce emissions, when considering the benefits from these measures the emphasis is overwhelmingly on 'financial benefits' (see Table 2, column - Targeted Co-benefits). This is mainly due to the current nature of local government policy discourse which stresses the need for quantification of results and concrete outcomes. In such a context, policy measures are negotiated mainly within an economic frame of reference. This is reflected in the following statement by one of the interviewed council officers:

...investment in mitigation is primarily seen as bit 'meeting a business case'... maybe reducing the 'operating overheads' of the building, for example, it's utilities of the building or maybe some driver in terms of efficiency... there is a need to demonstrate a 'business case'. Sometime that 'business case' could be quite marginal. Only then other 'non-monetary benefits' factor comes into it. (Council officer interview, 2016)

This clear preference for certain (quantifiable) monetary benefits only reflects GHG abatement and its associated fiscal savings as the main outcome from reduced energy use. Non-climatic benefits also result from these measures. They include 'non-energy-related benefits' such as health benefits from better air quality, active transport use, improved 'liveability' and access to locally created jobs. And while all of these have potential monetary savings for the health budget, they are not explicitly considered in the decision making process.

3.3 Consideration of health co-benefits in councils' climate change policies

In reviewing the councils that have climate change policies (n = 41), only seven (17%) have specific plans that explicitly consider the health co-benefits of adopted mitigation measures (see Table 3). However, nearly all these councils qualitatively describe health co-benefits in their relevant policy documents through graphic icons and bullet points. The graphics simply describe that the measures are selected for their potential to improve local air quality, decrease obesity, improve public health, and create a healthy living environment. This qualitative evaluation lacks a methodology as well as reference to evidence to support the claimed health co-benefits. Health co-benefits are also listed qualitatively alongside quantitative matrices that analyse the potential of these councils' climate change-related measures to reduce GHG emissions and achieve cost savings. These observations are echoed in the comments of the interviewed council officers. As one said:

Measuring those 'non-monetary health benefits'... it's a difficult one and it's one that I am not sure that we as a Council successfully measure that well. It's still like an evolving field. It's a bit like the issue of the active transport. There is a body of theories which says that if you make any area more attractive for pedestrians and cyclists that the local economy would benefit rather than having traffic going through the area. And that's an emerging body of evidence. But we don't necessarily at the local level yet really quantify some of those things. So when we invest in cycle paths we say that's good for people to get them out of their cars and there is health benefit for it. It makes people happier, it gives people sense of pleasure, it reduces the stresses of sitting in a traffic jam and but it's also maybe benefitting local economy because people riding pass may stop, shop and buy something... but we have not quite got there yet in terms of measuring the 'non-monetary' side of things. (Council officer interview, 2016).

4. DISCUSSION

The findings of this research indicate that while local governments in NSW purposively consider certain 'climate- and energy-related' co-benefits of their climate change-related policy measures, these are in the main quantifiable. 'Non-climate- and non-energy-related' co-benefits that also result from these measures are not considered, quantified, or even identified by local governments. This totally misses a swathe of health co-benefits arising from better air quality, active transport, improved 'liveability' and local job creation which are outcomes of climate change-related policy measures. This means planning for climate change and improved public health in the majority of NSW councils are currently not happening through an integrated approach. While this study identified limited number of local governments with specific climate change policies (n = 41; 56%), those policies can be easily judged as modestly effective due to their failure to incorporate health co-benefits. This study has identified a number of critical issues which have significant bearing on the possible incorporation of health co-benefits in the climate policy making process for NSW local government.

The existing regulatory framework within which local government currently operates determines the level of authority and control they can exercise over certain areas or sectors (NSW, 1993; CoA, 2010). This influences councils in their choice of mitigation measures. While councils have effective control over their buildings, vehicle fleet, other assets and facilities, and therefore achieve significant GHG abatement in emissions through adopting energy-related mitigation measures (see Table 2, Column – Types of Mitigation Measures), the same is not the case for emissions from the community. Councils generally have relatively little control over its citizen's energy consumption patterns and a host of other areas such as major land-use planning decisions, transport infrastructure, energy supply and addressing the demand for energy. This limited authority causes frustration among local government policy makers as evident in this officer's statement:

... I find that local government does not have that much planning control... I think that's another push back! When I was drafting this document [climate change strategy] I was looking at different actions that we could do... if I talk to the planners, the transport planners or transport engineers or the infrastructure people – they be like 'Oh! That's with State Government, our hands are tied... we can't do anything... that's State Government, that's State Government, that's State Government!' So any kind of change we want to make - lot of the time it's just 'That's not us, that's State Government' (Council officer interview, 2016).

Given that local councils operate with limited resources and there is no immediate return from prioritising limited expenditure to undertake such measures, the majority of councils lack incentives to pursue health benefits. One of the councils participating in the online survey clarified the position in this way:

Many of the additional benefits that can or will accrue to the community are not the responsibility of local government [i.e. health, employment]. Even if the 'monetary quantification' of these benefits was known or could be estimated, there is no return available to local government for prioritising our limited expenditure.

The above findings suggest that councils' over reliance on 'monetary considerations' and 'monetary quantification' in targeting benefits, coupled with their reluctance to undertake certain 'non-energy-related' mitigation measures that are not perceived to have any positive budgetary impact at the local level, excludes a wide range of environmental, social and health benefits from incorporation in the policy process. These 'non-climatic and non-energy-related benefits' include the most important and significant category of health-related benefits such as those from better air quality, active transport, improved 'liveability' and local job creation. Exclusion of these benefits from

incorporation in the policy process limits the potential for councils and their communities to achieve maximum policy benefits from climate change-related policy measures.

In terms of policy responses, this study has found that currently there is no clear direction for local governments from either Federal or NSW State Government with regards to climate change. In the absence of such direction, **local government mainly leverages state government's energy**-related policies and limited funding available for addressing climate change. As one of council officer noted:

There is no directive from Federal or State for us to have a climate change strategy. They are not forcing us to do that. So in that sense there is no direction. However, there are different levels of support and documents we can **look to...** (Council officer interview, 2016).

In this context, planning for climate change at local government level is primarily driven by the dual objectives of reducing GHG emissions and energy consumption. At present **NSW State's climate change**-related policies provide local governments with neither any direction regarding how to consider health in planning for climate change, nor any necessary tools or funds to conduct more extensive analyses of the health co-benefits of their climate change-related measures. As such, many councils consider public health benefits too far removed from their sphere of influence or benefit. This means that the focus of their climate change policy remains on reducing GHG emissions in a cost effective way and targeting monetary savings from reduced energy use.

A broader climate change policy agenda is needed to shift climate change-related activities at the local government level. Climate change and public health need to be addressed in an integrated and holistic manner. For this to happen, local government requires a clear policy direction from the State. Based on our assessment of local government climate change-related policies and interviews with local government officers, three policy areas are proposed. This is where the NSW State and local governments can focus to incorporate health co-benefits in climate change policies at the local government level.

First, State Government should mandate local councils to develop dedicated local climate change policies. As part of this, the State needs to provide adequate funding for conducting full health co-benefit analyses of the resultant climate policies. The challenge for such a task is the resourcing required to generate substantive public engagement programmes and cross-sector/multi-dimensional impacts analyses. However, the benefit of undertaking such a task is likely to more than compensate the initial investment for this purpose. This will enable local governments to broaden their focus to consider health co-benefits in their climate policies, alongside energy-related benefits. This will help local governments extend a **co-benefits approach 'beyond energy efficiency and monetary savings' incorporating broader co-benefits of low-carbon policies to include 'non-climatic and non-energy-related benefits' of low carbon measures.**

Second, this research shows a limited understanding among policy makers about the 'co-benefits approach', particularly in terms of how to frame climate change policies to include and quantify health-related co-benefits. The motivation behind a limited adoption of the co-benefits approach is currently driven by the monetary benefits to be gained from emissions reductions, though the potential for achieving better air quality, creating local jobs, improved **health and urban 'liveability' are also considered. However, these very difficult to calculate long term benefits get** side-lined in a policy discourse that stresses the need for immediate quantification of results and direct outcomes. Accordingly, co-benefits research should focus on developing tools and methods (including calculators, indicators and indices) to help policy makers estimate, quantify and monitor health and other non-energy-related co-benefits of different policy interventions.

Finally, the findings of this research demonstrate that while adopting co-benefits approach local governments can construct climate change mitigation as a local issue which can be reconciled with local priorities (i.e. energy efficiency and monetary savings) that reduce greenhouse gas emissions. However, the extent to which co-benefits approach can work beyond the bounds of local government is a crucial question for research. This is particularly relevant when scaling up the emission reduction targets and extending a co-benefits approach to include non-energy-related health benefits. These involve actions in areas such as land-use planning, transport provision, and addressing the demand for energy that require deeper policy shifts, which in turn entail legislative changes.

5. CONCLUSION

This article has provided an insight into the public health aspects of NSW local government climate change-related policies. The specific objective has been to understand the extent to which local councils are currently considering the public health needs of their communities and targeting health-related co-benefits in planning for climate change. The findings show that local government climate change-related policies in NSW rarely analyse whether their GHG reduction strategies also produce health co-benefits. This suggests a need for a broader policy direction from the State to local government to link planning for climate change with health. This direction will need to embrace inter-agency coordination and training to conduct health analyses; the development of tools and methods for identifying, quantifying, and incorporating health-related co-benefits; and legislative changes to support actions in areas **currently beyond local governments' sphere of control**.

This paper has also provided insight into local government policy makers' perceptions about targeting health-related co-benefits in their climate change planning. More research is needed to understand how individual councils are engaging with their communities and health agencies to establish explicit inter-connections between climate change and public health. Such research can examine how and why particular councils develop linkages between climate change and population health. A detailed investigation of **how local governments' climate change**-related policies across Australian states are developed in practice will provide a more strategic understanding of the particular agendas, politics, motivations, and expertise that influence the development of these policies and their health-related outcomes.

REFERENCES

- [1] Anguelovskik, Isabelle and Carmin, JoAnn, (2011). Something borrowed, everything new: innovation and institutionalization in urban climate governance. *Current Opinion in Environmental Sustainability*, 3, 169–175.
- [2] Bambrick, H.J., Capon, A.G., Barnett, G.B., Beaty, R.M., Burton, A.J. (2011). Climate change and health in the urban environment: adaptation opportunities in Australian cities. *Asia Pac. J. Public Health* 23 (Supplement 2), 12.
- [3] Burton, A.J., Bambrick, H., Friel, S., (2014). Is enough attention given to climate change in health service planning?: an Australian perspective. *Global Health Action* 7.
- [4] Burtraw D, Krupnick A, Palmer K, Paul A, Toman M, Bloyd C (2003). Ancillary benefits of reduced air pollution in the US from moderate greenhouse gas mitigation policies in the electricity sector. *Journal of Environmental Economics and Management*. 45(3):650-73.
- [5] Capon, T., 2010. Creating healthy, just, eco-sensitive cities. *Journal* [serial on the Internet].
- [6] Clarke L, Edmonds J, Krey V, Richels R, Rose S, Tavoni M. (2009). International climate policy architectures: overview of the EMF 22 international scenarios. *Energy Econ*. 31(Suppl. 2):S64–81
- [7] Climate Commission (2011). *THE CRITICAL DECADE: Climate science, risks and responses*: Climate Commission (Department of Climate Change and Energy Efficiency).
- [8] Climate Commission (2013). *THE CRITICAL DECADE: extreme weather*. In: *The Climate Commission* (Ed.), Canberra, p. 68.
- [9] Commonwealth of Australia (CoA) (2010). *Adapting to climate change in Australia—An Australian Government Position Paper*. Department of Climate Change, Canberra, Australia.
- [10] Commonwealth of Australia (CoA) (2010a). *State of Australian Cities*. Canberra: Major Cities Unit, Infrastructure Australia.
- [11] Commonwealth of Australia (CoA) (2010b). Environmental Health Committee (eHealth). *National Climate Change Adaptation Action Plan Workshop – Session 1: Scene setting*. National Climate Change Adaptation Action Plan Workshop; 2010 Friday 26 November, 2010; Rydges World Square, Sydney. Australian Government.
- [12] CSIRO (2007). *The Bureau of Meteorology. Climate Change in Australia – Technical Report 2007*: CSIRO.
- [13] Davis D, Krupnick A, Thurston G, editors (2000). *The ancillary health benefits and costs of GHG mitigation: scope, scale, and credibility*. *Ancillary Benefits and Costs of Greenhouse Gas Mitigation: Proceedings of an IPCC Co-sponsored Workshop held on 27-29 March 2000*.
- [14] Dubash NK, Hagemann M, Höhne N, Upadhyaya P. (2013). Developments in national climate change mitigation legislation and strategy. *Clim. Policy* 13(6):649–64.

- [15] Ebi, K.L., Lewis, N.D., Corvalan, C., (2006). Climate variability and change and their potential health effects in small island states: information for adaptation planning in the health sector. *Environ. Health Perspect.* 114 (12), 1957–1963.
- [16] Edenhofer O, Flachsland C, Jakob M, Lessmann K. (2013). The atmosphere as a global commons — challenges for international cooperation and governance. *Discuss. Pap.* 2013–58. HarvardProj.Clim.Agreem.
http://belfercenter.hks.harvard.edu/publication/23364/atmosphere_as_a_global_commonschallenges_for_international_cooperation_and_governance.html
- [17] Friel, S., Bowen, K., Campbell-Lendrum, D., Frumkin, H., McMichael, A.J., Rasanathan, K. (2011). Climate change, non-communicable diseases, and development: the relationships and common policy opportunities. *Annu. Rev. Public Health* 32 (1), 133–147.
- [18] Frumkin, H., 2002. Urban sprawl and public health. *Public Health Rep.* 117 (3), 201–217.
- [19] Hickman R. (2013). 5. Urbanization and future mobility. Givoni MaB, D editor: Edward Elgar Publishing, Cheltenham, UK; 2013. 60-74 p.
- [20] Intergovernmental Panel On Climate Change (IPCC) (2014). Human Health: Impacts, Adaptation, and Co-benefits, In *Climate Change 2014: Impacts, Adaptation, and Vulnerability. IPCC Working Group II Contribution to AR5.* Geneva.
- [21] Lewis, S. (2015). Five things you need to know about the Paris climate deal. In: *The Conversation*, December 13, 2015. Available at: <https://theconversation.com/five-things-you-need-to-know-about-the-paris-climate-deal-52256>
- [22] Markandya A, Rübberke DTG. (2003). Ancillary benefits of climate policy. *J. Econ. Stat. Jahrbücher Fur Natl. Stat.* 224(4):488–503
- [23] Metz B, Davidson O, Swart R, Pan J. (2001). Intergovernmental Panel on Climate Change (IPCC) Third Assessment Report. *Climate Change 2001: Mitigation.* Cambridge: Cambridge University Press.
- [24] NSW Government (1993). *Local Government Act 1993.* Department of Premier and Cabinet, Sydney.
- [25] Ostrom E, Burger J, Field CB, Norgaard RB, Policansky D. (1999). Revisiting the commons: local lessons, global challenges. *Science* 284(5412):278–82
- [26] Pacala SW, Breidenich C, Brewer P, Fung I, Gunson M, Heddle G, et al (2010). Verifying greenhouse gas emissions: methods to support international climate agreements. *Committee on Methods for Estimating Greenhouse Gas Emissions.*
- [27] Philp M., Taylor M. and Thompson S. (2015). *Carbon Reductions and Co-benefits: Final Report – Part I, Literature and practice review of Australian policies relating urban planning and public health.* CRC for Low Carbon Living.
- [28] Revi, Aromar, et al., 2014. Urban areas. In: John Balbus and Omar-Dario Cardona, eds. Chapter 8 in *Climate Change 2014: impacts, adaptation, and vulnerability. Vol. 1: Global and sectoral aspects. Contribution of Working Group II to the fifth assessment report of the Intergovernmental Panel on Climate Change.* Cambridge: Cambridge University Press, 535–612.
- [29] Rosenzweig, Cynthia, et al. (2010). Cities lead the way in climate-change action. *Nature*, 467, 909–911.
- [30] Seto KC, Dhakal S, Bigio A, Blanco H, Delgado GC, et al. (2014). Human settlements, infrastructure and spatial planning. See Ref. 20, pp. 923–1000
- [31] Smith, James A. and Capon, A. (2011). Addressing climate change through health promotion in Australia. *Health Promotion Journal of Australia*, 2011: 22 Special Issue
- [32] Somanathan E, Sterner T, Sugiyama T, Chimanikire D, Dubash NK, et al. (2014). National and subnational policies and institutions. See Ref. 20, pp. 1141–205
- [33] The Bureau of Meteorology (2012). *CSIRO. State of the Climate – 2012.* The Bureau of Meteorology. CSIRO
- [34] Woodcock J, Edwards P, Tonne C, Armstrong BG, Ashiru O, Banister D, et al. (2009). Public health benefits of strategies to reduce greenhouse-gas emissions: urban land transport. *The Lancet.* 374(9705):1930-43.

Bai Wan Zhuang, A Beijing Community at The Crossroads - An Analysis About the Sustainable Update of Chinese Old Distinctive Residential Areas

WANG Liang^a

^a CAUPD, Mainland China, 24911622@qq.com

ABSTRACT

Bai Wan Zhuang (BWZ) residential area, one of the excellent residential space designs during the early time of PRC's founding, had deeply influenced over people's life style in China. However, BWZ has turned into a poorly maintained community today with old houses, broken facilities, and disorganized outside environment. It had been listed in the Beijing City Renovation of Dilapidated Buildings Projects several times and should be renovated entirely earlier. However, due to the extensive controversy, the government temporarily stopped the BWZ's renovation project, and they waited for a more optimized alternative which focuses more on the balance of improving the living quality, protecting the historic buildings, respecting the householders' choices and economic success.

The way of BWZ's renewal will represent the fates of many Chinese distinctive old residential areas, particularly in the New Urbanization period. And this article commits itself in the most important topic of discussing how to foster the sustainable update for the BWZ.

Keywords: Baiwanzhuang, distinctive residential area, sustainable update

1. INTRODUCTION

1.1 The origin of the Issue

(1) Urban renewal and the sustainable development

Sustainable development refers to meet the current people's needs without hazards to the later generation's development abilities. It promotes the relationship between the environment and human existence in a sustainable approach. In 1992, the World Commission on Environment and Development (WCED) published the report "our common future" to formally state the concept and discussed it on commonly concerned themes. Then it has spread heavily all around the world.

The sustainable development in the context of urban renewal takes a city as an organism in a continuous process with quantities of historical information and reflects the city's life cycle. Thus, the urban renewal needs a more moderate way, in order to keep clues and characteristics of various development periods, including physical forms, local culture, composition of residents, etc. rather than the full replacement.

(2) The sustainable update of distinctive Residential Areas in China

Residential Area is one kind of modern living physical environments. In China, it appeared after the country's establishment and flourished with the rapid urbanization from the late of 1970's. In various period, there have been born some excellent residential areas taking the period's signals and become special heritage for present citizens. However, many of them are facing sustainable update issues.

(3) The sustainable update of the Bai Wan Zhuang (BWZ) Residential Area

The BWZ Residential Area, with the glory of "the first residential community in the new capital," was built in the Nation's establishment period. The project was started in 1953 and completed after 3 years. It is considered as a typical case of modern residential areas and published in the college subject textbook. Characteristics such as the red brick wall, slope roof, large area of green spaces, children' playground and the quiet living environment make it one model for activities of designs, developments and constructions in the following multiple decades in China.

Today, a large portion of BWZ suffers deteriorated houses and the environment. BWZ has become the object needing to demolition. But the government shows prudence due to the strong public opposition. The earlier voice rose from the local community residents. After 2011, many urban planners and construction experts joined the group. With **the knowledge of BWZ's historical and cultural value, they claimed that BWZ's** update should be in a sustainable way. Without a satisfactory explanation of the sustainable way, the old BWZ still has no formal development plan. Doubtless, the future of BWZ is full of variables.

1.2 The Current Condition of BWZ

(1) Position, administration and the population

BWZ is settled to the West of 2nd Ring Road, between the Chegongzhuang Street and Banwanzhuang Street. The east boundary is 400 meters from Zhanlan Road, while the west boundary is 80 meters to Sanlihe Road. Its whole shape shows a square with the size of 500m*420m, equivalent to 21 hectares. (Figure.1)



Figure 88: Location of BWZ.

It is administrated by two Residential committees, Baixi and Baidong, in the Xicheng District. They take charge of basic affairs such as the social and economic data, rent registration, cleaning stairs and passageways. In accordance with the governmental data, Baixi has 1864 households, 6218 residents; whereas 1932 households, 5777 residents in Baidong. And the gross population of BWZ is 11995.¹

(2) Land Use

BWZ includes 10 housing clusters. The center is the Baiwanzhuangzhongli cluster which is surrounded by the other nine clusters. A primary school two parts of a primary school stand separately on the east and south of the center cluster. On its northwest, there are one engineering company and one community life-service center with a supermarket, a restaurant and a parking lot. On the north of the BWZ erects a building belonged to China National Nuclear Corporation (CNNP). Several simple dormitory buildings stand along BWZ's east edge. In two yards near the north, a retirement center and a disability-nursing center stay separately. (Figure.2)



Figure 89: Landuse of BWZ.

(3) Living quality

Many surfaces of bottoms of the eaves are broken and fall-off, exposing inner wood structure. Moreover, without the thermal insulation layer, the buildings' walls lose heat easily, which make the rooms extremely cold in winter days, special before and after the heating period. Some walls are eroded due to the seepage from the aged pipeline, causing moss growth. Residents have to clean the sewer system frequently after it jams. Electric wires twist and fly here and there. Some furniture are abandoned in the corners, covered with thick dust. During summer, weeds grow thickly, and the apartment rooms becomes warm and humid. Mosquito attacks on the residents continuously. Besides, there are many illegal constructions in the yards between the buildings, which consumes a large amounts of open spaces. They rose up in the 1970s as earthquake shelters, and sprawl in the later years.² (Figure.3, Figure.4)



Figure 90: One water room.



Figure 91: The illegal houses.

On another angle, BWZ also keeps advantages: Buildings with only three-floor height hide behind the trees, which creates a comfortable space dimension for the resident. As a comparison, the too high buildings in Beijing's new residence area convey heavy pressure. For the reason that buildings are shorter than trees, plus a large area of greening, the temperature in BWZ is often 2-3 degrees lower than the adjacent communities in summer. Closing to the elementary school and life-service center provides BWZ a convenient daily life. The special 3m room height design increases the interior brightness and the flexibility of indoor activities. (Figure.5, Figure.6)



Figure 92: The scene in the alley.



Figure 93: The scene of one yard.

(4) Historic value

Researches for BWZ's historic value begin from 2010, the main points are:

- The earliest residential area design samples in China. BWZ's designer had learned a lot from the international forefront planning concept - "expanding neighbourhoods" (aka. the European or American "neighbourhood" concept) from the Soviet Union. With this concept, the clusters are planned to surround the center green park (where Baiwanzhuangbeili cluster is. It was built after 1975). And daily service facilities, stores, kindergartens, elementary schools, etc., can be reached within a five-minute walk. The most important is no need to cross the traffic road.
- The **buildings' arrangement suitable to local climate**. The majority of the residential buildings faces the north and south directions in order to receive more sunshine; whereas a small part of the buildings faces the east and west, to achieve enclosure and thus to get better resistance against the winter wind. (Figure.7)

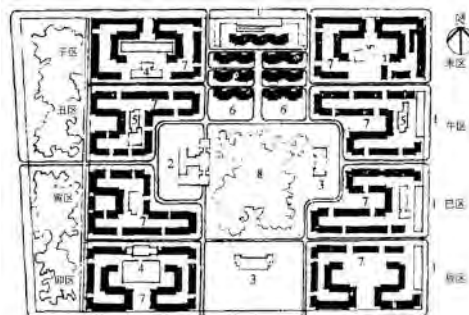

Figure 94: Master plan of BWZ.

- The **building's form** is on behalf of the era characteristic. All the buildings are three-floor height, with red brick walls and double-slope roofs. The special red color conforms the style of both Soviet Union and

China's Forbidden City. The white beam-column construction for seismic resistance sharpens this character. The independent kitchen and restroom with 3 meters height have referenced to Soviet Union too. The special "circling" pattern can be seen easily in the balcony wall between windows, in the stair arms, and in the heads of gate posts, which displays a "modernist" style. Many buildings still maintain doors and windows made of redwood from the northeast of China, which explain the traditional patterns in 1950 period. (Figure.8)

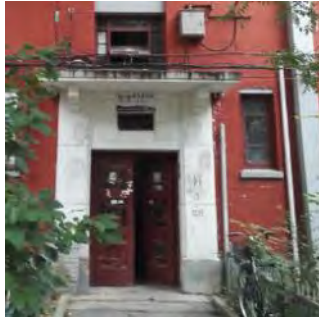

Figure 95: Concise design.

- Celebrity residents. Many country leaders, famous scholars and writers have spent their lives in BWZ, such as Li Peng, Gu Mu, Wen Jiabao, Qian Qichen. These celebrities add fascinating legends to this area.³
- Traditional taste. Names of the 9 clusters (not including the center one) come from the traditional earth branches system, which makes them heard unordinary. With the arrangement of a circle, the whole pattern of BWZ looks like a big peaceful Bagua image. An interesting explain for this special design is in order to **squench bad affections of BWZ's history as a grave before the country's foundation.**⁴

1.3 Key Problems for BWZ Sustainable Update

Lack of maintenance entity leading to acceleration of BWZ's deterioration

Over 50 years, BWZ had to face its quality problems in the 1990s. Many residents had ever plotted detailed plans to improve their **room's** quality and beautify their decorations. However, they gave up finally because the government declared the BWZ demolition project, not only once. Once the demolition project was carried out, the residents would receive monetary compensations or new apartments by calculating the room area. But the expense on reinforce and decoration has no payment, which means the householders' **investments on their houses** are waste. Considering this reason, in the past 20 years, most households only have spent minimal expenses on their houses.

Another **reason comes from the residential house's ownership system. In the early time, many BWZ residents** worked for the national "four departments and one committee" (national planning commission, ministries of geology, heavy industry, first and second machinery industry) . All of the houses belonged to these government institutions. In 1994, the state council published a reform policy on urban and town housing system in order to transit the urban housing system from the institutions into the open market. People could obtain their houses' ownership by paying at the original construction cost price or the standard price. Before, the maintenance work of buildings and the **environment was part of the institution's duty. After the ownership's shift**, institutions dropped out. Most of the maintenance affairs needed to seek special facility companies. However, the market has no interests at collective affairs. Original institutions' retreat had created troubles to perform the thorough maintenance works such as **buildings' repair**, which accelerated the deterioration.

(2) Out of the city protection system, short of policy support

The earliest professional protecting voice was claimed by its designer Zhang Kaiji in 2004, in a letter to the Beijing Administration of Cultural Heritage. In the same year, in the tenth meeting of 3rd Beijing Political Consultative Conference, **Lu Huai'an provided** a proposition (No. 0633) to advice protection for BWZ in time. At the same year, Ministry of Construction issued a document to demand protections of excellent modern buildings. After that, Beijing announced more than 70 modern buildings in the preservation list (without BWZ).⁵

Beijing is one of the first batches of Chinese historical and cultural cities. It finished its own protection plan in 1990s and has published 21 batches of historic and cultural resources. During the 11th and 12th five-year periods, Beijing had formulated the protective construction plan to conduct all the related works with necessary support on fund, technique and research. However, this plan only focused on the traditional cultural resources scattering in the old town scope (the 2nd Ring), plus some historical and cultural towns, villages and other cultural sites in the suburb. The most similar category to BWZ is cultural relics and modern architectures which is related with individual buildings. So BWZ gains no help from the Beijing's protect system.

(3) High proportion of the elderly and tenants reducing the community vitality

The population structure of BWZ has affected its community vitality. According to Zhanlanlu Street Office, among the gross population 11995, people over 60-year-old is 3058, and the tenant is 3292. The proportion of the two kinds is calculated to 25.4% and 27.4%, respectively, with a sum of more than 50%.⁶

Generally, a higher elderly proportion generates a higher participation rate in community activities.⁷ Different from the young people suffering a lot in daily work, the elder people enjoy retirement life and tend to devote more in the community. However, most of the aged population in BWZ is more than 75 years old. Their self-care ability is relatively weak, which leads to low participation rate in community activities. Besides, taking care of the much old people also cuts down the **younger generation's energy and enthusiasm into** community lives.

Tenants are short-term users of the community's facilities and environment. The higher tenant percentage means less motive force on the improvement of the community. Most of BWZ tenants run their business in a large wholesale market nearby. This market is planned to move out of the downtown area in 2017, which adds uncertainties to **the tenants' future. They only pay for temporary stay, not to mention the participation of the BWZ's** sustainable update.

1.4 The sustainable update path of BWZ

(1) To push forward the city protection system advancing more.

Although BWZ does not belong to **Beijing's historical and cultural city protection system** at present, it should be noted that this protection system advances itself in a constant process and has not solidified. In 1983, Beijing established the status of the historical and cultural city with an urban construction planning scheme. Since that time, the protected objects have expanded from single cultural relics to the entire historic and cultural field, from material entities to intangible cultures, including particular courtyard buildings, historical and cultural town and village, underground cultural relics buried area, excellent modern buildings, and industrial heritage. This evolution reflects the gradually increasing awareness of the historical preservation.⁸

In other cities, researchs and protections of distinctive residential areas, like BWZ, have already begun. Shanghai Chaoyang First Village, for example, was created in the 1950s. As a classic worker new village mode, it served as the national reception sites for foreign affairs, taking the role of the "working class" living room. It became a typical architectural style of the settlement for industry workers for the next following 30 years. In 2004, Chaoyang First Village was rated as "the fourth batch of excellent historical preservation building in Shanghai". The topic of how to protect it to achieve sustainable update has always been the social focus.⁹ Another case comes from Shenyang, a city with **many "worker village" dwelling units**. The units explained well at "new China's working class becomes the master", with deeply marked features as "**upstairs and downstairs, lights and telephones**" of that time.¹⁰

Preservation in Beijing also possess the dynamically developing character. All of the valuable objects should be protected in this city, covering each period. BWZ, which represents outstanding designs in the early time of China, have the qualification to be paid attention on, in spite of many research and work needed.

(2) To apply for urban renewal projects and take items selectively.

Beijing launched a comprehensive improvement plan for old residential areas in 2012, including areas built in and before 1990, with low construction-standard buildings, backward facilities, incomplete function and lack of long-term management mechanism.¹¹ In 2013, Beijing renamed it shantytown renovation and planned to complete all the projects within the 4th Ring Road before 2017, and complete all the projects before 2020. It is free totally to the

residents. A special national capital policy for this plan is exerted. Beijing also will invest a large amount of capital for this. 40 billion Yuan will be paid for the **35000 households' renovation task in 2016**.¹²

BWZ doubtlessly fits the definition "shanty". According to "implementation opinions" of the renovation, detailed items cover reconstruction of walls for energy saving, changing aged facilities and equipment, cleaning and painting walls, and collective works such as building elevators, changing air conditions, rearranging electric wires, repairing utility pipes, etc. There are also many items in yards, concerned with accessibility, fire protection, greening, landscaping, alleys, lights, etc. All of these are urgent for BWZ. Considering the valuable historic information on the surface, items such as the reconstruction and painting of walls may be canceled. Therefore, Rather than worrying about destruction of the shantytown renovation, BWZ should actively apply its project, exert the beneficial items, to grasp this opportunity to advance a great step in its sustainable update lifetime.

(3) To explore the property management and eliminate the illegal constructions.

Property management brings seasonable maintenance to buildings, facilities and related sites. Old residential areas, like BWZ, seldom achieve property management services because of the unclear property rights, the long-term rent or idling, frequent delay for the payment, etc. In addition to the sanitation task which belongs to the residents' committees, residents consult different professional municipal companies to solve their daily troubles. Affairs, especially the common affairs, are hardly to be carried out. For example, the parking. Many cars park in BWZ every day, which affects **residents' activities**. Safety is another problem. There are numerous hidden-risk locations exist in the outdoor, which is a danger to the people living here.

Suitable ways of the property management should be explored in BWZ. A good choice may combine it with the resident autonomy, which means semi property management. In Chaoyang District, a new property management with the "resident autonomy" characteristic is working. Local residents manage themselves in some service fields.¹³ Concerned about the municipal services have been completely open to the market, the property management of BWZ can run in fields of the parking, electronic surveillance, public green space design, fitness places arrangement, stairs corridor repairmen, etc.

As historical causes, the existing illegal buildings are used as living or storage rooms by householders and tenants, which makes them hard to dismantle. However, they really make the environment worse. Determination is needed for these illegal constructions. Paralleled with strong demolition activities, some trade mechanism is possibly plotted to compensate some reasonable affection.

(4) To gain social support to enhance the inner sustainable development ability.

In spite of the old appearance, it is still reckless to say BWZ is experiencing decay. From a long-term statistic data, the population of BWZ at its birth is 8176, while the newest data is 11995. Getting rid of people in the later buildings, BWZ's population has increased more than 2000 people. Simultaneously, **the householder's update** keeps going on. On the basis of HOME LINK **company's data**, there are 43 deals in the whole year of 2015, and 41 deals before October in 2016.¹⁴

On the other side, as a distinctive residential area, BWZ has already won attentions a lot. Some research articles are typed in journals and spreading in the internet, some professional urban planners and architects have shown wills of joining the sustainable update process of BWZ¹⁵. Obviously, BWZ needs outer force for its better future. With professional supports, **BWZ's historical and cultural value** can be displayed thoroughly. By careful designs and constructions, BWZ would gain its charming outer space. The local recognition will created gradually and the community vitality will recover.

2. CONCLUSION

In China, the urban historical and cultural protection system has established early, but still not perfect. The **distinctive old residential areas, which have significant values for cities' history, are neglected** in the majority of cities. As a typical case, BWZ is suffering update dilemma. The protection of its valuable historical and cultural information is facing challenge from the physical decline, uncertainty renovation plan, lack of maintaining service, low community vitality, etc.

However, positive factors are also growing. After analysis to BWZ's conditions, the sustainable update path is finally pointed out with four measures: (1) to push forward Beijing's protection system advancing and cover BWZ in the new system; (2) to apply for Beijing's urban renewal policy and take items selectively; (3) to explore the proper property management and eliminate the illegal constructions; (4) to gain social support to enhance the inner sustainable development ability.

REFERENCES

- [1] Introductions of Baixi and Baidong Community can be found on the website: zll.bjxch.gov.cn/ZLLIndex.ycs.
- [2] Many Articles have described the low living conditions of BWZ on the internet. This page is one of them: http://news.qq.com/a/20111218/000581_1.htm.
- [3] The Youth Planner Union. 'To Be Or Not To Be, Will BWZ Be Protected?'. <http://www.aiweibang.com/yuedu/64086021.html>
- [4] Jia, Rongxiang. Sun, Ying. A Study to the Buildings' Culture Characteristics and Existed Value of Beijing Banwanzhuang Residential Area. Journal of Beijing University of Civil Engineering and Architecture, 2012.9.
- [5] With Quantities of Illegal Construction, The Remove of BWZ, Which Is The First Residential Area In China, Is Facing A Dilemma'. *Legal Evening News*, 18th Dec. 2011. <http://news.qq.com/a/20111218/000581.htm>.
- [6] Chen, Jinghuan. Dong Yanchun. The Intent and Activity of Community Participation in Beijing. Journal of Beijing Youth Politics College, 2011.
- [7] Qiu, Yue. The Formation, Protection and Development of Beijing Historic and Cultural City. Proceeding of Urban Development And Planning Conference(2012).
- [8] Huang, Jianjian. 'The Glory And Embarrassment Of China's First Worker's New Villiage', *Liberation Daily*, 22 Oct. 2016. http://news.gmw.cn/newspaper/2016-10/12/content_116906948.htm
- [9] 'The Living Exhibition Building Of The Worker's Villiage'. *Shenyang Net*, 29 Mar, 2016. <http://travel.syd.com.cn/system/2016/03/29/011025426.shtml>.
- [10] 'The Notice Of The Comprehensive Improvement Work's Implementation Opinions In Beijing's Old Residential Areas'. This policy can be read on the website: <http://www.1633.com/policy/html/beijing/shizhengfu/2012/0814/506461.html>.
- [11] Zhao, Shi. 'The Shanty Town – Renovation Project Has Got 24, 000 Householders With ¥38.1 Billion In Beijing This Year'. *New Beijing*, 9 Sep. 2016. <http://house.qq.com/a/20160909/008507.htm>.
- [12] '181 Old Residential Areas Have The Quasi Property Management'. *China news*, 15 Nev. 2015. <http://www.bj.chinanews.com/news/2015/1115/48681.html>
- [13] The deal data of the houses' can be got on LianJia's website: http://bj.lianjia.com/chengjiao/rs_百万庄/
- [14] "Banwanzhuang Studio" was built by many tsinghua's architects in 2013 ; The China Youth Planner built the " Love In BWZ Group" in 2015.

Methodology for a Sustainable Urban Regeneration: Urban Cell as Dissemination Unit

Miguel AMADO^a, Ines RAMALHETE^b

^a Instituto Superior Tecnico, Portugal, miguelpamado@tecnico.ulisboa.pt

^b GEOTPU Grupo de Estudos de Ordenamento do Territorio e Planeamento Urbano, Portugal, i.ramalhete@fct.unl.pt

ABSTRACT

Accelerated urbanisation in developing countries is creating an unyielding pressure on existing urban areas. This reality is leading to the widespread growth of informal settlements, that is, urban areas without infrastructures and property titles. According to the United Nations, Sub-Saharan African Region are showing the worst scenario, with 55% of the population still living in informal settlements in 2014. Different approaches and strategies have been applied but the scale of the problem, the lack of financial resources and the political instability are the major **constraints. Urban regeneration actions is fully dependent on the State's decisions and resources, which delay the process** and, sometimes, show inadequacy to economic, social and environmental conditions. Yet, developing **countries represent a "tabula rasa" opportunity for the implementation of good practices within the urban and built environment.** After a literature review on urban regeneration approaches, this paper sets out the analytical and methodological framework applied to Luanda metropolitan plan (Angola). Understanding the importance of a practical perspective, a Geographic Information System (GIS) approach, based on the delimitation of urban cells, is adopted as tool for regeneration dissemination process across the city. The aim is to combine strategy and action into a model where the State is the promoter of regeneration programs that are developed by the private sector and the population, considering mechanisms to implement a self-empowerment process. This research aims to support the design and implementation of sustainable solutions for urban regeneration in developing countries.

Keywords: informal settlement, urban regeneration, GIS, urban cells, dissemination units, sustainable development

1. INTRODUCTION

Sustainability has been defined as the concept of meeting the needs of the present without compromising the ability of future generations to meet their own needs. Different definitions emphasize sustainability issues, related to economic, social and environmental analysis, as one interacting reality since the final objective requires a fair balanced approach within the management of all the resources. Sustainability is synonymous of complexity, since collects a huge group of interactions between human activities and the natural environment. It integrates the related phenomena of adaptability, resilience and flexibility as well as the need to assess responses to optimize system-wide effects and to minimize the impacts of localized actions and decisions. This framework places sustainability as an emergent subject, connecting food scarcity, floods, landslides, water availability and energy access with the sprawl of urban settlements boundaries. Such relations lead to models that political and governance institutions can also use to address to potential climate change effects and mitigation **of cities' impact on climate.** The translation of these concerns into practice fosters social and economic development toward a new way of thinking about sustainable urban regeneration that has established itself in developing country as a fundamental research subject. But, what do current trajectories of research suggest for future practice? Here, new ways of living, renewable energy, green and nature engineering, ecological design, manufacturing and products, reflect major scientific and technological pursuits endorsed by sustainability principles. According to the UN-Habitat latest reports, about 881 million people are currently living in slums in developing countries. This emergence is due, in large part, to the rapid growth of urban areas which leads to a shortfall in many sectors, especially in housing, since the cities cannot meet the huge demand and needs of population. Abrams argued that the informal city is a result of lack of shelter in a context where the formal channels are inaccessible to the poorer. Payne postulates that the growth of these settlements is inevitable in developing countries. Today, the proliferation of slums and squatter settlements are examples that government or public authorities deal with dynamics that are still uncontrolled or uncontrollable. This is a consequence of an instable and weak economic sector, aggravated by an insufficient education policy. Indeed, Sub-Saharan Africa continues to have the highest prevalence of slum conditions of all regions, estimated at 55 per cent in 2014. Informal settlements are marked by unhealthy conditions,

due the lack of basic infrastructure, overcrowding, environmental vulnerability and land tenure issues. However, some authors identify the potential of these informal settlements within its transformation. For instance, Turner identifies the informal settlements as a successful solution for the shelter of the urban poor, that is, people find their own ways to create shelter with few material and financial resources. Steyn, reinforces this perspective by saying that, besides the low quality and uncomfortable layouts, informal settlements are a viable response for the social and economic conditions of these populations. Both generally agree that the self-build housing linked to the application of local materials (composite and natural) are an important feature if not a sustainable approach. The inhabitants of today's settlements do not only need food but proper housing accommodation, adequate living space and healthy environment. The benefits linked to a better conditions of living in urban areas have a relation with the preservation of nature. Environmental psychologists have examined and concluded that, generally, such contact with the nature has been determined be necessary for human health and wellbeing and to quality of life. All of these issues are basic human rights and constitute the central framework to project sustainable development of future societies. Such features, together with the self-**determination and the capability to “do more with less”**, should be used within the regeneration process as a social and economic way to provide shelter. The local governments often lack the necessary funding and resources to implement long-term strategies able to promote sustainable transformation of the urban environment. Without an integrated approach this is a closed-loop problem. Regeneration process needs to be complemented with coherent policies and incremental strategies supported by both the State and private entities. Therefore, inclusive, universal and adaptive solutions that help to determine informed development strategies at local scale, represent an explicit challenge to innovate conventional urban regeneration models. This paper discusses a methodology for sustainable urban regeneration for the informal **settlements of Luanda, Angola, within the Luanda's metropolitan plan. Thus, the main challenge of this work relies** on the fact that 80% of the population (5 million people) of this city lives in informal settlements and are currently exposed to environmental risk and with precarious conditions that might compromise their lives.

2. URBAN REGENERATION

Many authors have focused on the meaning of urban regeneration. Robert and Sykes, consider that urban regeneration refers to urban rehabilitation or urban renovation to solve urban problems and simultaneously provide a long-term solution for the social, economic, physical and environment contexts. According to Sahin, urban regeneration includes urban redevelopment, revitalization, replacement and rehabilitation. However, it is commonly agreed that strategies that consider urban regeneration fully dependent on State are no longer viable. When the public sector is fully responsible for the project, problems such as bureaucracy, lack of financial resources and corruption might occur. Indeed, public actions based on economic premises, lead to severe consequences in the social context and promotes, in the end, social exclusion. The new settlements are commonly located in peripheral **urban areas where the land is cheaper. This result in “urban dorms” without services or economic opportunities for** employment, worsening the poverty situation of these populations besides the growth of collateral problems such as crime and thus insecurity. According to Turner the urban poor need to solve a difficult equation by getting shelter near employment opportunities centres. Even the informal economy (e.g. street vendors) need to occur in areas where consumers exist. Therefore, the public sector has the political responsibility to provide infrastructures and affordable housing for those with no means to acquire a house at all, that is, single parent families headed by women, elders or handicapped people for example. The site-and-service scheme is another solution that emerged in response to the failure of fully public initiatives. This approach can be considered as an indirect public initiative combined with self-help, where the State provides subdivided greenfield land with basic infrastructures and social facilities while the population build their own houses. One of the good examples of such approach is the Chilean experience on regeneration that evolves the incremental housing process. This process started with the State actions in providing land and infrastructure, where the people would build their houses, and then evolved within a more controlled process. During the first years of this experience, people built their houses as they knew which lead to precarious conditions similar to informal settlements but with access to water, sewage and energy. Later, an assisted process was introduced through a technical team that would help and support the population within the building process to provide better housing solutions and thus ensure quality. Some of these experiences lead, however, to the problems previously mentioned: most of the land provided by State was far away from economic centres; On the other hand, speculation triggered escalation of land prices. Site-and-service approaches are remarkable by integrating people within the process to, simultaneously, reduce costs and better solve the population needs. Moreover, the State is seen as a support instead of a direct provider which improved the viability of these kind of projects. However, such approach needs coordination between the whole stakeholders or

otherwise will be unable to provide a social and economic viable solution. Besides the site-and-service strategies that are commonly applied, upgrading informal settlements is also a current strategy considered by non-governmental organizations. This approach starts with the transformation of the urban environment through the participation of the State with the self-determination of the population. In fact, the process is similar to the site-and-service strategies but applied in the informal settlements instead of relocate people in other locations. The public sector provides basic infrastructure (roads, sewage, water, energy) and the community is responsible for the building upgrading. To do so, public sector needs to empower local authorities through legislation (policies) as well as human, financial and material resources. The absence of this support might compromise the whole purpose: people have indeed infrastructure but the building stock still precarious similar to what was mentioned in the incremental housing in Chile. In these approaches, the partnership between the State, the private sector and the population is the common premise. The public sector facilitates the regeneration process by creation the conditions for the private investment and people self-determination. This conditions can be through the management and monitoring the housing market, land provision and policies. Tax relief is commonly used in India and Morocco while in Egypt the State provides land and lower the housing standards through legislation. In Turkey, a counterpart is added: The State provides land but the private sector must accommodate a percentage of social housing. Political intentions but with a weak economy hampers the problem thus an incremental and local-based approach, supported by a partnerships scheme that involves the State and the private sector, is required. Therefore, the local features are important aspects to be considered to better accommodate the needs and create a viable solution for each case.

3. URBAN CELL AS DISSEMINATION UNIT

Despite the general complexity of informal settlements, when they empirically and theoretically studied, some general global patterns tend to emerge in response to land use patterns, urban system parameters and population density. Therefore physical-geographical approaches to the urban form and land use analysis are commonly used to deal with this kind of complexity. Many of these approaches are used to analyse different aspects of urban development at a macro spatial scale such as urban shape, city size distribution, population density and thus involving an array of interrelated methods and tools. The widespread use of geographic information systems (GIS) has shifted the emphasis to new forms of analysis and planning at a fine spatial scale. One of the most effective methods is the implementation of urban models, based on the principles of cellular automata (CA). The concept of **CA was introduced in the 60's by Von Neumann as a formal model of self-reproducing biological systems**, later, computer science, mathematics and physics began to study CA for modeling their respective domains. In 1979, Tobler introduced the concept of CA to geography and made the first application in the study of urban systems. In 1995, Clarke created a land use change model called SLEUTH (Slope, Land use map, Excluded area, Urban area, Transportation map, and Hillside area) that simulates the urban growth process showing the real value for planning and GIS application. The SLEUTH model is capable of modelling the complex urban growth dynamics and a land use system changes, providing a set of spatial variables such as topographic slope, road networks, land use maps. Other CA-based models, incorporating analysis of linear dimension of urban infrastructures, number of buildings densities and uses with the number of years and population growth, have also been propose. Related with these issues, the MOLAND (Monitoring Land Use/Cover Dynamics) model has been applied to European cities to assist spatial planners and policy makers to analyse a wide range of spatial policies and their associated spatial patterns. In this regard, the grid-based approach is the recognition of an alignment between the urban complexity and its study by means of units of space that are conceived as smallest urban units available: the cells. White reports that at the latter scale, cells may represent cadastral units (i.e. actual land lots), which may have any shape. More recently, the GUUD (Geographical Urban Units Delimitation) model emerges to deal with cellular approach to the urban form, land use analysis and solar potential and energy consumption estimation. The potential relationship between the GUUD model approach and the concept of dissemination units for urban regeneration are the theoretical boundaries that inspired the present research. Therefore, the paper describes the methodology for a sustainable urban regeneration, based on urban cell as dissemination unit considering an incremental long-term process.

4. METHODOLOGY

Within the scope of the Luanda's metropolitan plan, urban regeneration is a crucial aspect for the success of the planning action, not only due to the precarious living conditions but also because people are exposed to many risks, that is, floods, landslides and lack of mobility facilities which, all together, compromised both their life and development. The methodology developed in this paper combines several aspects of the aforementioned urban regeneration approaches, adding the sustainable component. The latter is achieved by considering the local features (social, economic and environmental) as primary aspects. The research framework addresses three complementary categories: 1). physical-geographical approach to urban form and land use analysis; 2). recent data from the public entities and fieldwork and local surveys developed between 2014 and 2015; 3). relationship between urban planning and housing deployment. Therefore, the methodology follows five steps that interrelate policies and physical scale through an integrated process (Figure 1).

A partnership model between public and private sector is also established where land valorisation and tax benefits are the key elements to attract private investment. The public sector is responsible to create the conditions for development. These conditions are not only physical, through the creation of major infrastructure and social facilities, but also at the policy level through incentives (inclusionary zoning and density bonuses), rights transfer and a tax benefit programme. Moreover, the State is also responsible in providing social housing within the national housing programme but it is mandatory that the private sector contributes for housing provision through the creation of affordable housing. This will result in fewer costs and direct and indirect revenues for the State and thus a viable solution for both stakeholders in working together for the housing deficit and city development.



Figure 96: Flowchart describing Luanda's methodology of urban regeneration

Step 1 - Definition of the intervention area

Definition of intervention area is firstly based on three main criteria according to its priority: 1). areas located in flood and landslide areas, that is, locations that compromise human lives; 2). areas where are programmed development projects (such as roads or main infrastructures); 3). Areas with precarious conditions (absence water, sewage and energy). The intervention area definition should also consider a dimension for its transformation of a neighbourhood unit of 5000-10000 people. This dimension was based in empirical and theoretical evidence of the

territory and its densities (about 350pph living in single-family homes in the city centre). This step is fully led by the public sector, regarding its development programme and intentions for the territory.

Step 2 - Urban analysis

Urban analysis refers to the development of a criteria framework that will work as the main core for the regeneration process. In this step, land tenure must be clearly defined to support the rights transfer model and establish the compensatory mechanism where buildings improvements may be added as compensation, according to the following parameters: existing roads, social facilities, cultural or historic heritage, commercial activities, agricultural area, vacant land. Regarding these uses, land tenure number of floors and materials should be also assessed. This phase is strongly supported by the State within the land tenure assessment that is the most bureaucratic and time-consuming task.

Step 3 – Delimitation of urban cells

The delimitation of the urban cell is implemented according to the urban analysis criteria by working with the physical parameters that might structure and organize a potential homogeneous neighbourhood. This step provides an opportunity for the management and monitoring process led by public sector because has a smaller operational unit, easier to operate, within the regeneration process.

Step 4 – Land valorisation

This step refers to the public sector effort to attract private investment, that is, land valorisation through the creation of conditions such as: major infrastructures (mobility corridors and basic infrastructure – water, sewage and energy); provision of social facilities (creation and upgrading of the existing ones) and open space; management of the urban plots according to the land tenure as well as the creation of social housing within the national housing programme. These are the main conditions for development and will provide the basis for the urbanization process lead by private sector in step 5.

Step 5 – Urbanization

Step 5 refers to the urbanisation process that envisages the creation of services, commerce, free market and affordable housing promoted by the private sector. This step is crucial for the effectiveness of the process as far as the private sector must contribute to the housing deficit, that is, a percentage of its investment must be affected to affordable housing. Indeed, this type of housing aims the low-income population that could pay for a house (in a rent or rent-to-buy scheme) based on the consumer-pays principle. The possible flexibility in gross floor area within the intervention area (density bonus) will actually encourage land transformation. Thus, private sector will take on a more significant role within the urbanization process through the transfer of building and/or land rights (the latter might involve another location).

5. CONCLUSIONS

Literature review shows different perspectives on informal settlements as well as different approaches to their resolution. The main outcomes of these strategies are identified and analysed. Therefore, a mixed-strategy that combines site-and-service and settlement upgrading, as well as a partnership model between public and private partnerships are crucial aspects for its effectiveness. Within the urban development process, urban cells can disseminate regeneration to surrounding areas not only physically but also in terms of social and economic impacts. The application of CA models supports the transition from macro-scale to micro-scale offers more and better data to understand the relationships among a range of key aspects of informal settlement such as urban form, built environment, land-use, densities and infrastructures across the city. This process helps on the definition of urban cells for regeneration, assuming that the problem can only be solved incrementally and with local operations. However, this research does not deny an holistic approach but consider that the intervention must be divided into phased components (cells) Therefore, the dissemination unit aims to be a small area that can be easily managed and monitored by the public sector. The definition of this intervention scale permits to control the viability of projects due the lower costs that are concentrated on a small urban area. This intervention combines a five-step process that integrates the transformation of the territory through physical actions and policies, where the State has an important role. Such policies are based in financial benefits and incentives to attract private sector and thus become

the main operative stakeholder. The support of the private sector on the creation of affordable housing, regarding a rights transfer model, will also have impacts on public budget by contributing to solve the housing deficit. This model aims the self-empowerment of the private sector in urbanising the land which might encourage to further interventions. In a long-term perspective, cities in developing countries can gradually transform its informal character into formal environment.

REFERENCES

- [1] WCED, *Our Common Future*. Oxford Paperbacks, 1987.
- [2] H. L. Abbas M. Hassan, 'Toward the sustainable development of urban areas: An overview of global trends in trials and policies', *Land Use Policy*, vol. 48, 2015.
- [3] D. Hoorweg, M. Freire, M. J. Lee, P. Bhada-Tata, and B. Yuen, 'Cities and Climate Change : Responding to an Urgent Agenda', The World Bank, World Bank Publications, 2011.
- [4] J. Corfee-Morlot, L. Kamal-Chaoui, M. G. Donovan, I. Cochran, A. Robert, and P.-J. Teasdale, 'Cities, climate change and multilevel governance', no. 14, p. 126, 2009.
- [5] M. P. Amado, I. Ramallete, A. R. Amado, and J. C. Freitas, 'Regeneration of informal areas: An integrated approach', *Cities*, vol. 58, pp. 59–69, Oct. 2016.
- [6] United Nations Human Settlements Programme, *World Cities Report 2016: Urbanization and Development - Emerging Futures*, 1st ed. Nairobi: United Nations Human Settlements Programme - UN-HABITAT, 2016.
- [7] C. Abrams, *Man's Struggle for Shelter in an Urbanizing World*. M.I.T. Press, 1964.
- [8] G. K. Payne, *Urban Housing in the Third World*. London : Boston: Routledge Kegan & Paul, 1977.
- [9] C. Way, Ed., *The Millenium Development Goals Report 2015*. New York: United Nations, 2015.
- [10] Ö. Güzey, 'The last round in restructuring the city: Urban regeneration becomes a state policy of disaster prevention in Turkey', *Cities*, vol. 50, pp. 40–53, fevereiro 2016.
- [11] J. Turner, 'Uncontrolled Urban Settlement: Problems and Policies', in *Urbanization: development policies and planning*, International Social Development Review No. 1, New York: United Nations, 1968.
- [12] G. Steyn, 'Sustainable African settlement: Profiling a vision', *Tshwane University of Technology*, Pretoria, South Africa, 2003.
- [13] B. W. Wekesa, G. S. Steyn, and F. A. O. (Fred) Otieno, 'A review of physical and socio-economic characteristics and intervention approaches of informal settlements', *Habitat Int.*, vol. 35, no. 2, pp. 238–245, abril 2011.
- [14] J. Maas, 'Green space, urbanity, and health: how strong is the relation?', *J. Epidemiol. Community Health*, vol. 60, no. 7, pp. 587–592, Jul. 2006.
- [15] R. Mitchell and F. Popham, 'Effect of exposure to natural environment on health inequalities: an observational population study', *The Lancet*, vol. 372, no. 9650, pp. 1655–1660, 2008.
- [16] P. Roberts and H. Sykes, *Urban Regeneration: A Handbook*. SAGE, 2000.
- [17] S. Z. Sahin, 'İmar Planı Değişiklikleri ve İmar Hakları Aracılığıyla Yanıltıcı (Pseudo) Kentsel Dönüşüm Senaryoları: ankara Altındağ İlçesi Örneği [Pseudo urban regeneration scenario through development plan changes and development rights: the case of Ankara Altındağ districts]', in *Symposium Proceedings of urban regeneration*, Ankara, Turkey, 2006, pp. 89–101.
- [18] R. Keivani and E. Werna, 'Modes of housing provision in developing countries', *Prog. Plan.*, vol. 55, no. 2, pp. 65–118, Feb. 2001.
- [19] V. Mukhija, 'The contradictions in enabling private developers of affordable housing: a cautionary case from Ahmedabad, India', *Urban Stud.*, vol. 41, no. 11, pp. 2231–2244, Oct. 2004.
- [20] M. Greene and E. Rojas, 'Incremental construction: a strategy to facilitate access to housing', *Environ. Urban.*, vol. 20, no. 1, pp. 89–108, Apr. 2008.
- [21] A. Aravena and A. Iacobelli, *Elemental: Incremental Housing and Participatory Design Manual*. Berlim: Hatje Cantz, 2013.
- [22] M. Greene, 'Incremental Housing; The Chilean Experience', presented at the 5th UN World Urban Forum, Rio de Janeiro, 2010.
- [23] S. M. Blaustein et al., Eds., *Spatial Strategies for Manyatta: Designing for Growth*, 1st ed. New York: The Urban Design Lab at the Earth Institute of Columbia University, 2014.
- [24] N. Devas, *Managing Fast Growing Cities: New Approaches to Urban Planning and Management in the Developing World*. Harlow, Essex, England; New York: Longman Group United Kingdom, 1993.

- [25] P. van Asperen, *Evaluation of Innovative Land Tools in Sub-Saharan Africa: Three Cases from a Peri-Urban Context*. IOS Press, 2014.
- [26] J. Abbott, 'A method-based planning framework for informal settlement upgrading', *Habitat Int.*, vol. 26, no. 3, pp. 317–333, Sep. 2002.
- [27] M. A. Khalifa, 'Evolution of informal settlements upgrading strategies in Egypt: From negligence to participatory development', *Ain Shams Eng. J.*, vol. 6, no. 4, pp. 1151–1159, dezembro 2015.
- [28] H. S. Mekawy, 'Effectual Role of Local Level Partnership Schemes in Affordable Housing Delivery', *Int. J. Soc. Behav. Educ. Econ. Bus. Ind. Eng.*, vol. 8, no. 4, pp. 1006–1014, 2014.
- [29] S. Zemni and K. Bogaert, 'Urban renewal and social development in Morocco in an age of neoliberal government', *Rev. Afr. Polit. Econ.*, vol. 38, no. 129, pp. 403–417, Sep. 2011.
- [30] E. O. Ibem, 'The contribution of Public–Private Partnerships (PPPs) to improving accessibility of low-income earners to housing in southern Nigeria', *J. Hous. Built Environ.*, vol. 26, no. 2, pp. 201–217, Jun. 2011.
- [31] Z. M. Akkar, 'The concepts, definitions and processes on urban regeneration in the Western literature and Turkey', *J. Chamb. City Plan.*, vol. 36, pp. 29–38, 2006.
- [32] Y. Coskun, 'Does Re-Design of the Policies on Housing Finance and Supply Help to Solve Housing Question of Turkey?', *SSRN Electron. J.*, 2011.
- [33] M. Batty, 'Building a science of cities', *Cities*, vol. 29, pp. S9–S16, 2012.
- [34] E. Shpuza, 'Urban shapes and urban grids: a comparative study of Adriatic and Ionian coastal cities', in *Proceedings, Istanbul*, 2007.
- [35] B. J. L. Berry and A. Okulicz-Kozaryn, 'The city size distribution debate: Resolution for US urban regions and megalopolitan areas', *Cities*, vol. 29, Supplement 1, pp. S17–S23, 2012.
- [36] P. Jia, Y. Qiu, and A. E. Gaughan, 'A fine-scale spatial population distribution on the High-resolution Gridded Population Surface and application in Alachua County, Florida', *Appl. Geogr.*, vol. 50, pp. 99–107, 2014.
- [37] E. Besussi, N. Chin, M. Batty, and P. Longley, 'The Structure and Form of Urban Settlements', in *Remote Sensing of Urban and Suburban Areas*, vol. 10, T. Rashed and C. Jürgens, Eds. Dordrecht: Springer Netherlands, 2010, pp. 13–31.
- [38] M. Batty, Y. Xie, and Z. Sun, 'Modelling urban dynamics through GIS-based cellular automata', *Comput. Environ. Urban Syst.*, vol. 23, pp. 205–233, 1999.
- [39] P. Sarkar, 'A Brief History of Cellular Automata', *ACM Comput Surv*, vol. 32, no. 1, pp. 80–107, 2000.
- [40] N. N. Pinto and A. P. Antunes, 'Cellular automata and urban studies: a literature survey', *ACE Archit. City Environ.*, vol. 1, no. 3, pp. 368–399, 2007.
- [41] K. C. Clarke, S. Hoppen, and L. Gaydos, 'A self-modifying cellular automaton model of historical urbanization in the San Francisco Bay area', *Environ. Plan. B Plan. Des.*, vol. 24, no. 2, pp. 247 – 261, 1997.
- [42] K. C. Clarke and L. J. Gaydos, 'Loose-coupling a cellular automaton model and GIS: long-term urban growth prediction for San Francisco and Washington/Baltimore', *Int. J. Geogr. Inf. Sci. IJGIS*, vol. 12, no. 7, pp. 699–714, 1998.
- [43] Lavalley, J. Barredo, N. MC Cormick, R. White, and I. Uljee, *The MOLAND Model for Urban and Regional Growth Forecast: A Tool for the Definition of Sustainable Development Paths*. European Commission, Joint Research Centre, 2004.
- [44] A. Lagarias, 'Urban sprawl simulation linking macro-scale processes to micro-dynamics through cellular automata, an application in Thessaloniki, Greece', *Appl. Geogr.*, vol. 34, pp. 146–160, May 2012.
- [45] R. White, 'Cities and cellular automata', *Discrete Dyn. Nat. Soc.*, vol. 2, no. 2, pp. 111–125, 1998.
- [46] M. Amado and F. Poggi, 'Solar Energy Integration in Urban Planning: GUUD Model', *Energy Procedia*, vol. 50, pp. 277–284, 2014.
- [47] M. Amado, F. Poggi, and A. R. Amado, 'Energy efficient city: A model for urban planning', *Sustain. Cities Soc.*, vol. 26, pp. 476–485, 2016.

Poster Session

Urban Regeneration Introduced with Resilient City Concept - A Case Study of Pingtung City in Taiwan

CHANG Kuei-feng^a, CHANG Wan-ting^b, LIUNG Hing-heng^c, WONG Wei-jin^d

^a Pingtung County Government, Taiwan, a001549@oa.pthg.gov.tw

^b Pingtung County Government, Taiwan, a001408@oa.pthg.gov.tw

^c Pingtung County Government, Taiwan, a000124@oa.pthg.gov.tw

^d Pingtung County Government, Taiwan, a001700@oa.pthg.gov.tw

ABSTRACT

Pingtung City, Pingtung County, Taiwan is an old city, and villages started to be established there around 1684. In 1836, defensive walls were constructed to prevent thieves and fights. The county was developed very early and is the central city on Pingtung Plain. During the Japanese Occupation Period (1907), Pingtung City, due to the establishment of railway station and sugar factory, attracted population and gradually formed the prototype of its urban plan. However, as time changes, Taiwan sugar industry loses its advantages. The extensive land owned by Taiwan Sugar in the south of Pingtung experienced slow transition. The previous Front Station and Back Station areas of the plane railway station are situated in the south and north of Pingtung City. Also, the urban development is featured by non-homogeneous growth. Besides, with the enhanced urban disaster-prevention awareness in recent years, the central hinterland of Pingtung is small but is an area where tons of dilapidated buildings are erected, suggesting that the space development of Pingtung City shall be renewed and reviewed.

“TRA Kaohsiung-Pingtung Chaozhou Rapid Transit Systematization Construction Project” brings new opportunities for the urban renewal of Pingtung City. To empty the land for the new project in the railway station, eliminate urban level crossing, implement the concept of resilient city, work with related major construction projects to continue to produce synergy, and respond to extreme climate and vulnerability in the earthquake zone, the Pingtung County government has embarked on overall and systematic planning and strategy planning of Pingtung's urban renewal, reviewing the land surrounding the Railway Station and planning transfer stations to integrate the railway and highway transit system. Also, it connects the traffic arteries of Front Station and Back Station and develops the business district in Front Station and Back Station in the form of urban renewal, hence fueling local sightseeing, leisure and business activities and guiding sustainable development and environmental optimization of Pingtung city.

Keywords: urban regeneration, resilient city, sustainability

1. DEVELOPMENT OF RESILIENT CITY

1.1 Global sustainable development framework - addressing disasters caused by climate changes

At the end of the twentieth century, mankind gradually realized that the environmental destruction had already begun to result in counterattack on the nature. Therefore, in order to reach a consensus on environmental protection, in 1983, the Brundtland Commission (formally known as the World Commission on Environment and Development, WCED), which probed into environmental issues, was convened in the United Nations.

This commission suggests that human beings formally explored environmental issues and formulated processing framework for the first time. In 1987, the Brundtland Commission published the well-known report **“Our Common Future” (also known as the Brundtland Report), which for the first time gives a complete definition of sustainable development:**

“Development that meets needs of the present without compromising the ability of future generations to meet their own needs.”

After the idea of sustainable development had been proposed in the United States, in 1992, the United Nations Conference on Environment Development (UNCED) held the Earth Summit in Rio de Janeiro, Brazil, and put forward a comprehensive proposal on how to address climate change, i.e. “Agenda 21”.

“Agenda 21” is an unprecedented sustainable development program and seeks to provide a blueprint for the sustainable development of mankind as a whole. It presents more than 2,500 proposals for action plans, including detailed proposals for how to reduce waste and consumption patterns, protect the atmosphere, marine and livelihood diversities, and promote proposals for sustainable agricultural development (Lin, 2005).

The Agenda mainly focuses on four aspects, that is, society and economy, conservation and management of resources, to promote development, strengthen the roles and major groups and means of implementation. Additionally, the Agenda also defines three respects of sustainable development: environment, economy and society. Pope and Parkin later developed the three respects into the current well-known interconnected three-respect development framework, and the development framework is detailed in Figure 1.

In 2005, the United Nations adopted the “Hyogo Framework for Action 2005-2015: Building the Resilience of Nations and Communities to Disasters, HFA”. The framework preliminarily constructed the planning idea centering on handling disasters -- Resilient City, and confirmed the importance and development framework of resilient city. Presently, HFA has become the most important guiding principle of implementing resilient city planning of the world’s governments and sustainable development organizations.

1.2 Definition of resilient city- adaption and recovery of cities despite complex disasters

According to the planning framework of the resilient cities “City Resilience Framework” published by the promotion organization of resilient cities the “100 Resilient Cities” (100RC) in 2014, it put forward the following concept of resilient cities: “The resilience of a city refers to the capacity of individuals, communities, institutions, businesses, and systems within a city to survive, adapt, and grow no matter what kinds of chronic stresses and acute shocks they experience.”

“Resilience” is recovery and adaptability

Resilience is a term that emerged from the field of ecology in the 1970s, to describe the capacity of a system to maintain or recover functionality in the event of disruption or disturbance. It is applicable to cities because the urban environment and ecological environment are complex systems that are constantly adapting to changing circumstances (ARUP, 2014). Therefore, the concept of resilient cities not only emphasizes the ecological of urban entity construction by disasters, but also stresses the disturbance to social system.

Resilient cities focus on “multiple hazards”: including chronic stresses and acute shocks

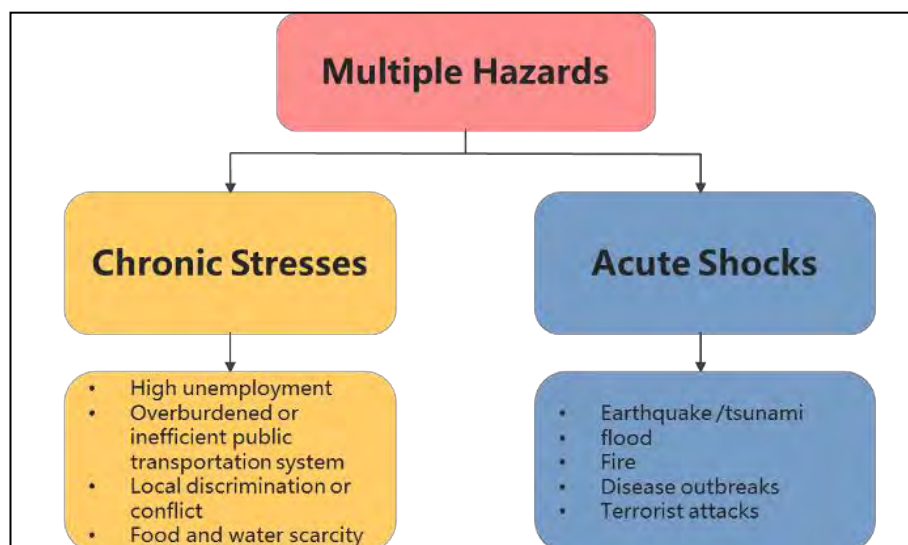

Figure 1: Composite structure of multiple hazards

(Source: 100RC, en.wikipedia.org, CNN, www.panoramio.com, Telegraph Media Group)

In addition, the 100RC also points out that resilient cities move away from traditional disaster risk management, which is founded on risk assessments that relate to assessment and reduction of specific hazards. Instead, resilient cities take multiple hazards as the strategic objectives, including the chronic stresses and acute shocks faced by the cities. Therefore, resilience focuses on enhancing the performance of a system in the face of multiple hazards, rather than preventing or mitigating the loss of life and assets due to specific events.

2. PRESENT STATUS, DEVELOPMENT AND PROBLEMS OF PINGTUNG CITY

2.1 Information on present status of Pingtung City

Pingtung City is the largest city in Pingtung County, and the county government is also situated there. It is located in the west of Pingtung County, and borders Kaoping River and Kaohsiung County. It covers an area of 65 square kilometers, accounting for about 2.43% of the county.

Pingtung urban planning area is located in the east of Pingtung City, covering 61 villages like Anle Village and part of Xiangyang Village, Changzhi Township, and representing 27% of Pingtung City area. Changzhi urban planning and Linluo urban planning are located within 5 kilometers of Pingtung City, so this planning intends to regard the Pingtung urban planning areas of Pingtung County as the planning area with a planning area of about 1,760 hectares. It is planned to develop the Pingtung urban renewal program and review the scope of Pingtung urban renewal areas. The relevant laws and regulations of Pingtung urban renewal are formulated and completed as the basis for Pingtung County to promote future urban renewal.

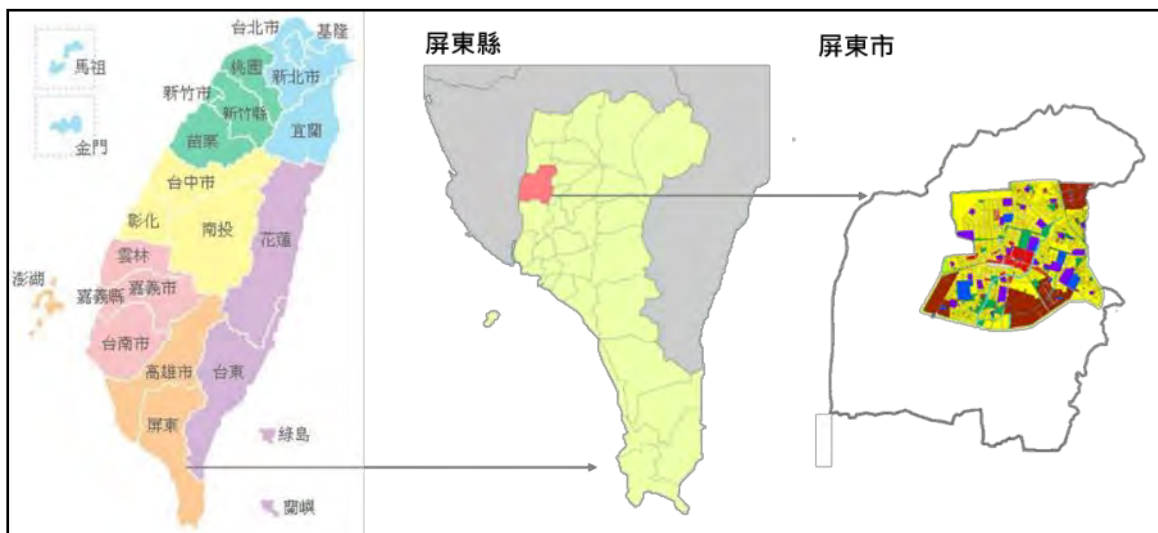

Figure 2: District map of Pingtung City

2.2 Overview of development status and current major construction plans

The business district of Pingtung City is concentrated in Pingtung Front Station with a development rate of 95%. The edge of the city is dominated by an industrial area with a development rate of 13% only. The remaining area is residential area with a development rate of 85%. Besides, although the buildings of Pingtung City are primarily situated along the street and are town houses, the five-floor dilapidated buildings of more than 20 years total 215 in Pingtung County, 153 of which are located in Pingtung City, accounting for 72% of all buildings.

Besides, in recent years, the Pingtung County Government invested in large numbers of major construction projects, such as elevated railway stations and reconstruction of station areas, renovation and construction of green belts in Wannian River, review of public facilities and reserves, lease of public land in Dawuying and industry introduction, connection of green-ways in Shengli Road, widening of Gongyong Road, and re-planning and renewal of old winery urban land (see Figure). Among them, elevated construction of railway stations is the most important

construction for Pingtung in one hundred years, and brings new opportunities for urban development. The details are as follows:

- The original space on both sides of plane railway was mostly crossing traffic (such as land bridge), idle land, temporary business districts and old settlements. After the railway was elevated, the Pingtung train station was reviewed and the land development texture surrounding the corridor was elevated, and the space image of entrance to Pingtung City was planned as a whole.
- Railway corridor is the pulse of the development of Pingtung. After the railway was elevated, new appropriate functional orientation shall be detailed to offer new opportunities for the development of Pingtung City.
- To meet the overall needs of future urban space development, the urban renovation of the existing Pingtung Railway Station and the areas along the railway corridor must substantially increase the value of the station area and its surrounding land and encourage regional development.

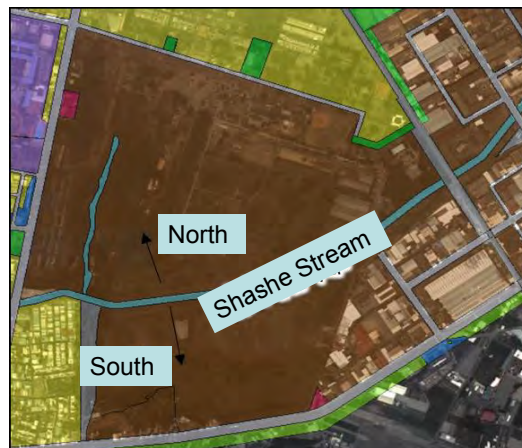

Figure 3: Urban plan of Taiwan sugar industrial area

- About 80 hectares to the south of the railway corridor is the idle land owned by Taiwan Sugar, where the Taiwan Sugar's pulp plant is located. Since the 1980s, the land has been idle, so it can serve as a model of brownfield regeneration by means of overall planning and revitalization of low-use land.

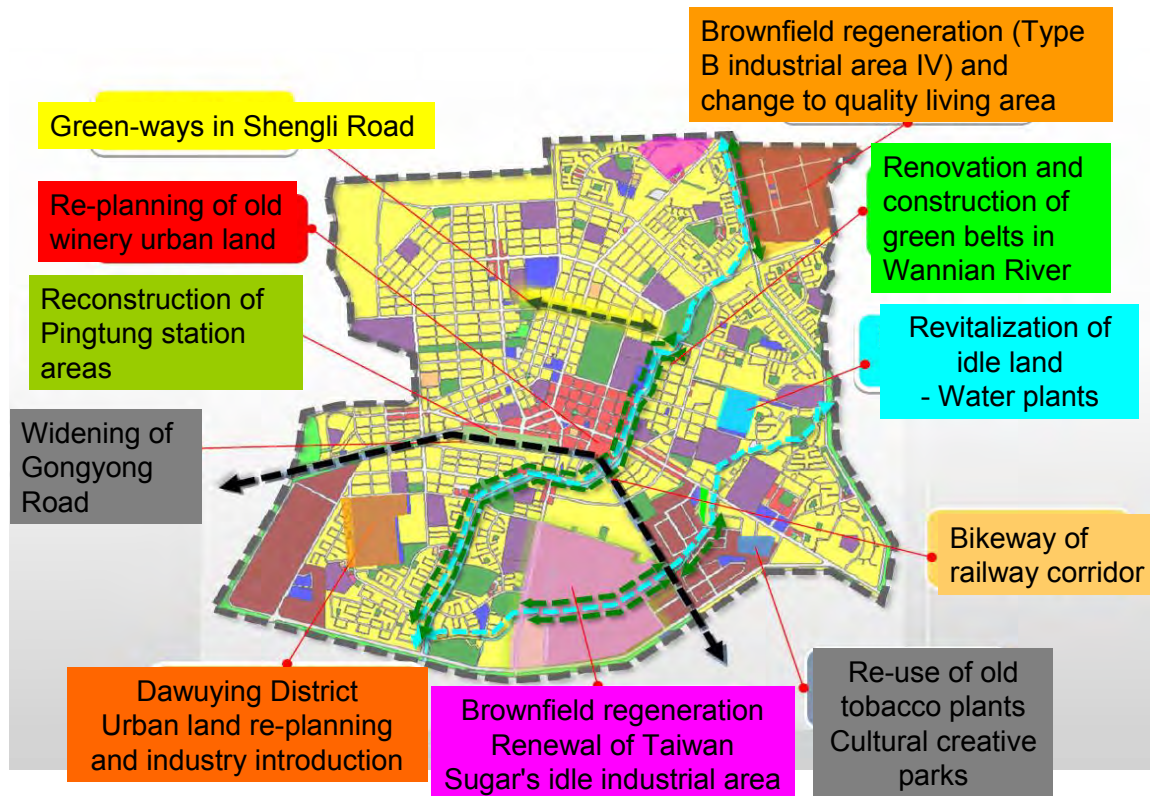

Figure 4: Schematic diagram of Pingtung urban planning land use partition and major construction distribution

Additionally, the earthquake on February 6, 2016 captured people's attention to disaster prevention. The dilapidated buildings in Pingtung City account for 72% of the total buildings of the county, demonstrating that Pingtung City is the area with a heavy demand for disaster prevention in the county. Given the local characteristics of Pingtung City, Pingtung City has a low demand for the bulk reward for urban renewal. The traditional urban renewal method by reconstruction is not competitive in Pingtung City, so only the elevated railway facilities can bring new opportunities for improving Pingtung City's urban landscape and building of public facilities. This study plan attempts to respond to the global trend of resilient urban planning and disaster prevention urban planning, expand the construction synergy, integrate into the overall spatial planning and put forward integrated strategies to use as the guiding principles of Pingtung City's future urban renewal.

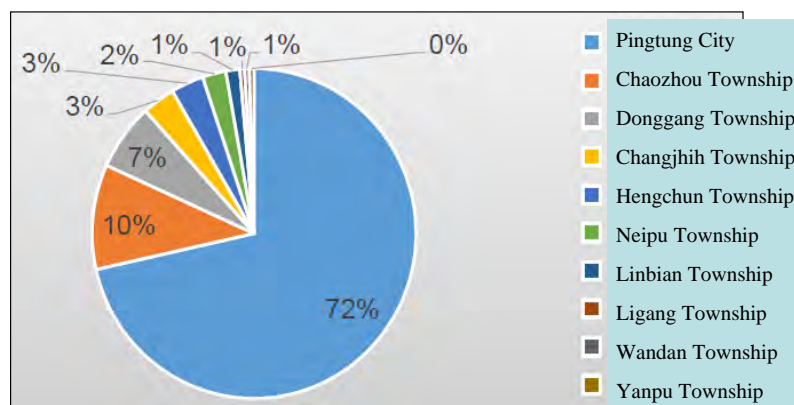

Figure 5: Proportions of dilapidated buildings of more than five floors in townships, Pingtung County

3. EXPECTED RESULTS OF THIS PLAN

This study plan expects to last for two years, and intends to start from investigation into basic information. After analysis, it will set the city's development goals and strategies, and formulate local self-government regulations according to local circumstances. The details are as follows:

Preliminary investigation into basic information and feasibility assessment

Background environment of the plan scope and basic information analysis include: Master plan and major construction plan of the adjacent areas, policy and ordinance analysis, analysis of physical environment (socio-cultural environment and current urban plan), land and building ownership analysis, survey and analysis of land use status, traffic system analysis, surrounding public facilities, etc. Besides, the preliminary work also includes the real estate market survey and analysis (including analysis of related development cases), development potential and restriction analysis.

Redevelopment goals of Pingtung County

This plan's key renewal scope shall be the entrance portals of Pingtung County, and covers the commercial and transportation centers of Pingtung City, such as Pacific Department Store, Global Market, Central Market, Pingtung Station, etc. To continue the synergy of elevated major construction projects, it is intended to develop an overall plan of urban renewal of Pingtung City. It is expected that through the planning and implementation strategies of key demonstration areas of urban renewal and through the specific city-wide implementation programs of urban renewal, the old urban areas of Pingtung City can be connected, the life quality of citizens in old urban areas improved and the regional environmental landscape enhanced. Moreover, the Pingtung urban environmental space can be re-shaped and the Pingtung urban portal intentions and industrial development can be activated.

- Formulation of determination criteria or identification scope of the urban renewal areas, and of the benchmark of determining urban renewal units and the self-government ordinance of Pingtung County's urban renewal.
- Substantive redevelopment strategies

Disaster-prevention urban renewal strategies

Given that the dilapidated buildings of over 20 years in **Pingtung City tops Pingtung County and given the "2016 Annual Earthquake-resistant Inspection of Existing Buildings (Old Building Inspection Plan)** funded by the central government in Pingtung County in 2016, this study plan provides strategies of promoting disaster-prevention urban renewal in Pingtung City, puts forward the criteria for determining disaster-prevention urban renewal areas with local characteristics of Pingtung County, gives priority to determining the urban renewal units, and assists independent application for renewal, reconstruction and maintenance through consulting groups of independent application for renewal.

Development strategies of resilient cities

Regeneration and development strategies of brownfield in Taiwan Sugar industrial areas

Type B (II) industrial area in the south of Pingtung Railway Station covers an area of 92 hectares, and owned by Taiwan Sugar. Currently, except some land that is maintained by the government and Pingtung City Office as open space, the remaining land is idle industrial land. It is suggested that by working with the overall urban development direction of Pingtung City, new development concepts are planned and land redevelopment strategies and plans are proposed. Furthermore, there are no detailed planned roads within this industrial area, so by referring to the urban renewal and the urban plans and procedures, the implementers are required to plan and build public Utilities.

4. CONCLUSION

Since Pingtung City was developed earlier than other areas, currently, there are numerous dilapidated and shabby buildings, and especially, those around the railway station are mostly dilapidated buildings of more than 30 years. **In the future, after the completion of the "TRA Kaohsiung-Pingtung Chaozhou Rapid Transit Systematization Construction Project", the railway will be elevated, and the original railway land will be released and connected** with the adjacent land as part of the city, hence bringing new opportunities for the renewal of dilapidated buildings. In response to the opportunities and challenges brought by the elevated railways, and to the new urban development issues like climate change and urban disaster prevention, this study plan intends to implement the **concept of "resilient city" through the proposal** of this urban renewal plan of Pingtung City, stimulate the urban

development of Pingtung City and bring a new look for the city via extensive urban renewal ways and revitalization of national land.

REFERENCES

- [1] Morgan, C., Bevington, C., Levin, D., Robinson, P., Davis, P., Abbott, J. & Simkins, P. (2013) Water sensitive urban design in the UK in the UK Ideas for built environment practitioners, London, CIRIA
- [2] Ove Arup & Partners International Limited 2014 (2014) City Resilience Framework, London, The Rockefeller Foundation & ARUP
- [3] The United Nations Office for Disaster Risk Reduction (2012) Making Cities Resilient Report 2012, New York, UNISDR
- [4] Collett, B., Friedman, V., Miller, W., Zawarus, P., Allen, J., Yue, X., Norman, D., Sneed, C., & Murphree, L. (2013) LOW IMPACT DEVELOPMENT - OPPORTUNITIES FOR THE PlanET REGION, Tennessee, University of Tennessee, Knoxville, Landscape Architecture Program
- [5] **Lin, T.C. (2005) Sustainable development with the United Nations "Agenda 21", Kaohsiung, National Youth Commission of the Executive Yuan.**
- [6] Ministry of Housing and Urban-Rural Development of the People's Republic of China (2014). Technical Guidelines for Sponge City -- Low Impact Development of Rainwater Drainage System (Trial), Ministry of Housing and Urban-Rural Development in Beijing.
- [7] **Chou, Y. (2015). "Study on Right Transfer System in Disaster-prevention Urban Renewal Areas -- A Case Study of Yongkang, Tainan", Report on study findings of the college and university students' study plans** subsidized by the Ministry of Science and Technology.
- [8] Urban Renewal Division of the Construction and Planning Agency of the Ministry of the Interior (2013). **"Concepts and Strategies to Promote Disaster-prevention Urban Renewal**, Urban Renewal Newsletter No.59.

The Status and Operation Issues Related to Covered Playgrounds of Elementary Schools

HSIEH Hung-ren^a, LI Ming-da^b

^a National Ilan University, Taiwan, hrhsieh@niu.edu.tw

^b National Ilan University, Taiwan, li.md@msa.hinet.net

ABSTRACT

Taiwan often built campus gymnasiums to hold large gathering events and physical education activities in rainy, extremely hot and other harsh weather days. In recent years, based on the considerations of the rationalization of construction investment efficiency and building operation energy-saving, semi-outdoor gymnasiums, a covered playground, have been proposed as the corresponding program. However, whether the covered playground can meet the needs of the users remains yet to be verified. Therefore, this study took the covered playgrounds of **elementary schools in Taiwan's Yilan area as the research objects. The method of post-occupancy evaluation is used to explore the status and operation issues related to covered playgrounds' spatial planning, physical environment, building facilities, and the use of spare parts.**

The research results show that five categories of common activities are usually carried out in covered playgrounds, including physical education activities, sports competitions, performances, exhibitions, and gatherings. The most serious problem in terms of the spatial capacity of covered playgrounds is the inadequate buffer space and it also suffers the insufficient space height of the main ground for sports activities. There are also problems related to physical environments of covered playgrounds; sound environment related problems are caused by background noise interference; lighting environment related problems are caused by inadequate illumination and glare light interference; thermal environment related problems are caused by sunlight interference; and water environment related problems are caused by wind-driven rain. Besides, building facilities of covered playgrounds primarily comprise two types of equipment, namely, the electrical equipment and the AV equipment. Further, there are two types of spare parts, namely, spare parts for sport and those for gathering events.

Finally, based on the above findings, this study also made recommendations corresponding to architectural programming of elementary school covered playgrounds and as the reference for building or renewing the covered playgrounds in the future.

Keywords: architectural programming, post occupancy evaluation, sport activity

1. OVERVIEW

Gymnasiums are often seen in Taiwan campuses, which are used for large gathering or gym classes held in bad weathers like rainy or hot days. However, the funds required for building gyms are enormous. Recently, in consideration of reasonable architectural investment and energy-saving for the operation of buildings, a concept of semi-opened covered playground was proposed as a countermeasure.

The so-called covered playground denotes a simplified sport field with rooftop but no wall, in order to facilitate ventilation as well as reduce maintenance cost (Sports Affairs Council, 2008). Yilan area, where the researcher is located, has been budgeting since 2010 for building covered playgrounds for the schools in the county which have no large sites for indoor activity, so as to reduce the impact of harsh weather on student's learning activities and improve the issue of limited activity space for students during raining days as well as provide a good place for community residents to have leisure activities (Yilan County Government, 2012). As of the end of 2015, 11 elementary schools in Yilan area have completed building covered playgrounds. However, could the building satisfy the usage requirements of schools? Is there any issue in using? These are worth of further exploration.

Therefore, this research based on the needs in practical activity usage of covered playground to explore the current situations regarding spatial planning, physical environment, building facilities, spare parts and other issues, and dig out related problems. In the end, corresponding architectural programming recommendations were proposed accordingly.

2. RESEARCH METHODOLOGY

Two research methods were introduced in this research: literature survey and current situation investigation, which are described as follows:

- Literature survey: The literature survey includes issues such as sports facility planning guidelines, sports space planning standards and physical environment standards. The summary of literature survey result is used as a reference baseline for the content definition and review of current situations.
- Current situation investigation: The current situation investigation includes work items such as administrator interview, spatial surveying and mapping, activity observation and physical environment measurement, etc. The content of current situation investigation covers school basic information, practical activity status, spatial planning, physical environment, architectural facilities, spare parts, etc.

The investigation result shows that among a total of 77 elementary schools in Yilan area in 2014, there are 11 schools have covered playgrounds, which are used as the research objects in the case study of this research (Figure 1). The class number of all these 11 schools is between 6 to 12 (1-2 classes a grade), and the average student number for a school is 144 students (standard deviation: 61.6 students).



Figure 1: Appearance of research cases

3. Discussion

3.2. Practical activity status in covered playground

In the practical activities taking place in covered playgrounds, 50 activities were collected through interviews, which can be categorized in the following five major types: physical education activities (24 items), sports competitions (2 items), performances (5 items), exhibitions (4 items), and gatherings (15 items). Furthermore, though the index of "strength of activity occurrence", the activities that are likely to occur in covered playgrounds were selected for the analysis basis of follow-up explorations on spatial planning, physical environment, architectural facility, spare part and other issues. The "strength of activity occurrence" is derived from multiplying three types of data: "average number of people in activity", "average activity time" and "average time of usage in a year". The principle for selecting the activities that occur more frequently in covered playgrounds is by choosing the activity with the highest "strength of activity occurrence" in all 5 types of activities, and the single activity that is 5% higher in "strength of activity occurrence" than the sum of that of all activities.

The research result shows that the activities frequently occurring in covered playground include 9 activities as follows: sports education - basketball (taking up 16.26% of overall strength of activity occurrences), dodge ball (8.95%), badminton (5.52%), Tee ball (5.29%), healthy exercise (5.14%); sports competition - basketball (0.34%); performance - comprehensive performance activity (1.19%); exhibition - mobile public library activity (3.14%); gathering - gathering event for school anniversary (2.59%).

3.3. Spatial planning

The current status and issue on the spatial planning of covered playground are explored via 5 approaches, which are overall architecture, unit space, space organization, space size and space material, respectively.

- Overall architectures: The covered playgrounds of elementary schools in Yilan area are all of one-story buildings, with average building area of 674m² (standard deviation of 244m²). The building orientation, with regards to the long axis of court, is mainly in east-west direction. Half of the cases are with performance stages in the field and mainly locate at the long side of the court. The floor of the covered playgrounds are marked with court-lines of 2 to 3 types of ball games, among which all cases are marked with basketball and dodge ball court-lines. Nearly 40% are marked with badminton court-lines but only one case is marked with volleyball court-line.
- Unit space: The unit space of covered playground is divided into three major categories: main space, secondary space and service space, and 9 items. According to the frequency of occurrence in all cases, the sequence is as follows: Main ground (100%), covered corridor (54.5%), performance stage (45.4%), maintenance catwalk (45.4%), storeroom (27.3%), facility control room (18.2%), parking lot (18.2%), bleacher (9.1%) and restroom (shared with adjacent school buildings).
- Space organization: Regarding the above mentioned 9 activities that are often held in covered playgrounds, the space organization analysis of covered playground were executed for the spatial items that are required to be used in the proceeding of each activity.
 - Main space (including main ground, performance stage and bleacher): The main ground is used as the main space for the operation of all kinds of ball games; the performance stage is used for health exercise teaching, basketball competition, comprehensive performance and gathering of school anniversary; while the bleacher is used for basketball competitions only.
 - Secondary space (including storeroom and facility control room): The facility control room is used for the operation and storage of switches, controls and relevant facilities for electrical equipment and AV equipment, while the storeroom is used for the storage of spare parts related to physical education and gathering events.
 - Service space (including covered corridor, maintenance catwalk, parking lot and restroom): The maintenance catwalk is used for the inspection and maintenance of lightings and other equipment of the court; the covered corridor is used to connect the covered playground with other school buildings.; the parking space is used for mobile public library cars; while restrooms are used for teachers, students and community residents.

It was found in the research that some cases suffer inconvenient issues for using covered playgrounds causing by lacking performance stage, bleacher, covered corridors and other spaces. For example, due to no storeroom, the moving of physical education or gathering event related spare parts of a long distance is a headache in using covered playgrounds.

- Space size:
 - Main space: The space of main ground is capable to arrange courts of 4 different ball games, among which the basketball court takes up the biggest space. The basketball court is possible to contain one dodge ball court or two badminton courts, or one volleyball court. The basketball court takes up the space of 26 x 14 meters. Moreover, the bottom line buffer space of the court is about 0.25-3m, the side line 0.25-2m and the net height of 5.2-8.6m. In addition, the width of performance stage is between 7.8-15.9m and 3.75-4.6m in depth. And the bleacher space appears only at one side for about 60m².
 - Secondary space: The area of facility control room is around 13-13.5m², and the storeroom is around 27-67m².
 - Service space: 80% of maintenance catwalks are configured as a C shape, while the rest 20% are configured as a square. The width of covered corridor space is between 1.5-2.5m. The parking space is 6m in length and 2.5 in width. The restroom space in all cases is commonly used with adjacent school buildings.

It was discovered in this research that in parts of the cases, as the main ground space is used for basketball court, the buffer space for bottom lines and side lines is only 0.25m, or the ceiling height is only 5.2m, both of which are

lower than the recommendation value (Sports Affairs Council, 2008). Furthermore, there are also insufficient size and space issue in performance stages, bleaches, storerooms, covered corridors, etc.

- Space material:
 - Floor material: There are two kinds of floor material seen in this research, with over 90% have monolithic finish flooring and less than 10% has acrylic flooring. For most of the cases that use monolithic finish flooring encounter problems such as insufficient slip friction resistance, poor elastic force and pulverization of surface layer. However, there is no foregoing issue in acrylic flooring.
 - Ceiling material: There are three kinds of ceiling material seen in this research, with 54.5% of the cases uses galvanized steel, 36.4% uses galvanized steel + polycarbonate lighting board, and 9.1% uses galvanized steel + presensitized insulation foam board. The ceiling material in all cases is presenting a good condition.

3.4. Physical environment

- Sound environment: Noise from cars and motorcycles around the school were considered affecting the usage of covered playgrounds by the administrators in 70% of the cases. According to a field investigation result, all cases present a environmental background noise of 45~55 dB(A) in daytime and 40~55 dB(A) in night time, which complies to the standard of 55 dB(A) (Lai et al., 1991). On the contrary, it was also discovered that the noise generated by the activities held in covered playgrounds is possible to become a source of noise for other spaces in the vicinity, which is worth of attention as well.
- Lighting environment:
 - Illumination: The average illumination of the main ground in covered playgrounds is 700~6,000 Lux in daytime, while in night time the average illumination of artificial lighting is 100~300 Lux, from which we know that parts of the cases cannot meet the usage standard of 300 Lux in artificial lighting in case of activities held in night-time (Architecture and Building Research Institute, 2010). And nearly 50% of the cases reflected the insufficient artificial lighting illumination issue in the interviews. In addition, there was also 81.8% of the cases reflected that the natural illumination in covered playgrounds is extremely imbalanced which caused troubles in using.
 - Glare light: In this research the most popular activity in covered playgrounds, the basketball game and performance activities, were used for the evaluation of glare light problem. The result shows that under the natural lighting in daytime for basketball game, there was 63.6% of the cases have troubles with the glare caused by the over-brightness of the background behind the basketball board or performance stage and affect the use. Furthermore, there was 45.5% of the cases have troubles with the glare caused by the artificial lighting on the basketball board or performance stage, which is worth of consideration as well.
- Thermal environment: Insufficient shading of the covered playground will lead to direct sunlight on the main ground space, and causes troubles to users for exposing under the burning sun. The interview result shows that 45.5% of the cases reflected the foregoing issue. On the other hand, a computer simulation was conducted in this research, which shows a direct sunlight interference in 5%~65% of the area of main grounds (3~5m in depth) from 9 am to 11 am; while there is 6%~60% from 1 pm to 3 pm (3~5m in depth).
- Water environment: The issue of covered playground in water environment is mainly caused by strong wind that blows raindrops into the main ground space, and results in a slippery condition of the ground that comes with safety concerns in holding activities. The investigation result shows that the eave at the long side of the main ground space in covered playgrounds have an average height of 7.5m, which is subjected to the wind-driven rain at the windward side by 3m in depth, and by 1.5m at the lee side; the eave at the bottom line has an average height of 7.7m, which is subjected to the wind-driven rain at the windward side by 2m in depth, and by 1m at the lee side. According to actual statistics result, there is over 30% of the cases are under severe impact by wind-driven rain.

3.5. Building facilities and activity spare parts

- Building facilities: Lighting and power sockets are the building facilities that installed in all cases. There are less than 20% of the cases installed with lighting for stages, AV equipment and other facilities. Almost in all cases the insufficiency of power socket during performances, gatherings and such like was proposed by administrators.
- Spare parts: Basketball stands, basketballs and dodge balls required for physical education activities as well as folding chairs and tables for gatherings are equipped in all cases. And then, over 60% of the cases have badminton, Tee ball, mobile AV equipment, timers, score boards and movable stage. In addition, less than 30% of the cases have badminton nets and poles, whiteboards, bleach chairs, notebook PCs, podiums and other spare parts. Also, parts of the cases were found having headaches on moving folding chairs and tables for long distance for performances or gathering activities, as there is no storeroom prepared in the covered playgrounds.

4. Recommendations for architectural programming of elementary school covered playground

According to the investigation result of current status as well as referencing relevant recommendation standards, the following suggestions for architectural programming of elementary school covered playground were proposed.

4.1 Spatial planning

- The space organization of covered playground shall have three unit spaces at least: a main ground space that can accommodate a basketball court, a storeroom for storing necessary spare parts required for physical education and gathering activities, and a covered corridor connecting other adjacent school buildings. Furthermore, according to the expected activity types, schools can plan for performance stages, bleaches, equipment control rooms, maintenance catwalks, parking space for mobile public library cars and other unit spaces in covered playgrounds. The relative position of the above unit spaces are recommended as Figure 2.

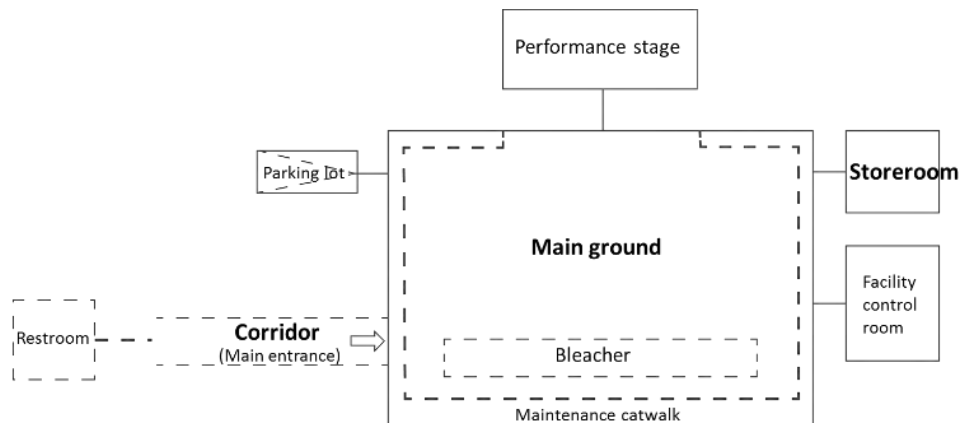

Figure 2: Typical space organization of covered playgrounds in an elementary school

- Unit space size:
 - The main ground space shall accommodate a basketball court with sufficient court-side buffer space plus weather buffer space of proper depth, whose spatial size is around 34mx22m, area is about 748m² and net height is at least 7m.
 - The storeroom shall be about the size of a general classroom with area around 75m², which can be increased or decreased according to the needs of spare parts for physical education and gathering.
 - The size of a performance stage space shall be at least 8m x 4m, and is better located at the long side of main ground space.
 - The area of bleach can be estimated by 0.4m²/ people, which shall be located at the opposite side of the performance stage and the line of sight shall be able to go through the whole basketball court.
 - The area of facility control space shall not be less than 10m².

- The width of a covered corridor shall not be less than 1.8m.
- The installed height of a maintenance catwalk shall not be lower than 4.5m with the width above 0.5m and the railing height above 1.1m at least.
- The parking space shall be of the size of 6m x 2.5m at least.

4.2 Physical environment

- The artificial lighting shall reach an average illumination of over 300 Lux, and to avoid uneven illumination the main ground space shall be better allocated with over 12 sets of lightings.
- To avoid the glaring interference of sunlight in daytime, it is better to install glare-shields above the 4m height from the ground behind basketball boards and main stage. Artificial lightings shall be avoided from being installed on the wall along the short side of main courts as well.
- To avoid direct sunlight or wind-driven rain into the main ground space, the main ground space shall have at least additional 3m of depth for weather buffer space in addition to the original required space for activities.

4.3 Space material

- The flooring material of main ground space can be acrylic or synthetic rubber that prevent sport injury due to insufficient friction and elasticity of the floor. If concrete flooring is chosen due to cost concern, the surface shall be cut for expansion joints after the smoothening of the surface layer, which can reduce powder generation due to floor cracking.

4.4 Building facilities and spare parts for activities

- The building facilities of a covered playground shall include court lighting and power sockets (over 6 sets). In addition, if necessary the stage lighting and AV equipment can be considered for installation.
- Regarding the spare parts for activities, there shall be enough quantity of spare parts for basketball, dodge ball, badminton and Tee ball for at least 20 people to use as well as spare parts for basketball games, and at least 100 folding chairs and 20 folding tables for gathering activities. Furthermore, whiteboard, bleach chairs, podiums and other spare parts can also be considered.

REFERENCES

- [1] Architecture and Building Research Institute, 2010. Research on the standard of lighting for indoor work places. Architecture and Building Research Institute, Taipei.
- [2] Lai, R.P., Lin H.T. and Chou, C.P., 1991. Physical Environment of Buildings. Liuho Press, Taipei.
- [3] Sports Affairs Council, 2008. Instruction manual for facilities of sports fields. Sports Affairs Council, Taipei.
- [4] Yilan County Government, News of county, embrace the space of happiness - Openings of covered playgrounds of five schools [online]. Retrieved from: <http://www.e-land.gov.tw/ct.asp?xItem=55236&ctNode=627&mp=777> [Retrieved on 15 Jan 2015].

Study of Public Mood Based on Sentiment Analysis in the City of Bandar Lampung, Indonesia

Munawir^a, Fritz Akhmad NUZIR^b, Bart Julien DEWANCKER^c

^a The University of Kitakyushu, Japan, munawiradam2@gmail.com; Cokroaminoto Palopo University, munawiradam2@gmail.com

^b Bandar Lampung University, Indonesia, fritz.ahmad@gmail.com

^c The University of Kitakyushu, Japan, bart@kitakyu-u.ac.jp

ABSTRACT

This study is an initial attempt to investigate public mood in the city by revealing relationships between opinion mining from online sources and real world phenomena based on sentiment analysis. The aim of the study is to determine potential of geo-tagging social media data, as well as offering possible new directions for city planners. We analyzed data from social media i.e. Twitter and generate a sentiment map of the city. We developed classifier tweets and emoticons to determine the mood of each tweet. We selected the city of Bandar Lampung as the case study. Bandar Lampung is the capital of Lampung Province with the population of over one million people. Moreover approximately 10% of the population in Bandar Lampung is within the age of 15-19. In Indonesia, this group of age represents 80% of the internet users. Therefore we would argue that the citizens of Bandar Lampung could provide sufficient social media data for this study. Sentiment analysis on social media data can offer better information for city planners and developers that can be used to improve planning and quality of life in the city.

Keywords: sustainable neighbourhood, city, sentiment analysis

1. INTRODUCTION

Social networking websites are the new era of expressing views. Today every person put their opinions, views, comments on these micro-blogging and social sites like Twitter, Facebook and many more. Social networking sites have provided an easy and attractive way to exchange ideas, opinions, knowledge and lots more. People can **update status which gives a picture of what's going on in their minds. These statuses can reflect an individual's mood, their achievement or failure.** Further, the comments on the same **can help to gather other people's opinion** on the same, thus, providing an overwhelming and valuable piece of information on a particular subject.

Twitter makes it easy for users to communicate, collaborate, interact and share data. The ease of access so as to provide the online reaction to everything that happens around them. Mood someone usually poured in posting their tweets. a person's lifestyle can be drawn from their tweet. Some of research studies have linked the use data from twitter. Twitter use of data related to public health surveillance. The large volume of data in Twitter approximately 5000 posts per second, it can help the extent to which the data twitter support public health surveillance and provide results that support for exploration of the future. Social media can be leveraged to provide greater understanding of the **well-being and health behaviours of community's information that has been previously difficult and expensive** to obtain consistently across geographies. More open access neighbourhood data can enable better design of programs and policies addressing social determinants of health. From retagged twitter data, a national neighbourhood database with area-level indicators of well-being and health behaviours.

Sentiment analysis or opinion mining is the process of understanding, extract and process the textual data automatically to get the sentiment of information contained in an opinion sentence. In this paper we analyse data from the micro-blogging site Twitter and generate a sentiment map of cities. We develop a classier Twitter messages, or tweets, using key words, phrases and emoticons to determine the mood of each tweet. We combined with geo-tagging provided by user. We can find the public mood is based on the level of sentiment in certain locations. Based on the results of data classification twitter we tried to take a variety of issues related to the environment, sustainable development and climate change.

We use Twitter to study of the cities based on geography and dynamics of sentiment in the greater area of the city, identifying areas and times of positive and negative sentiment. We built a sentiment classifier in order to assess the mood of the twitter.

The aim of the research is to determine potential of geo-tagging social media data based on sentiment analysis, as well as offering possible new directions for the research community for city planners. Sentiment analysis on social media data can offer city planners and developers better information that can be used to improve planning and quality of life in cities especially in the areas of environment, climate and sustainable development.

2. METHODOLOGY

2.1 Data collection

Twitter is a microblogging site created in 2006 that is used by over 500 million people worldwide. Twitter tweet are used for our research work which is our primary focus. They will be further use for mine opinion on the basis of features contain in the tweet extracted. We use Twitter to study of the cities based on geography and dynamics of sentiment in the greater area of the city, identifying areas and times of positive and negative sentiment.

We selected the city of Bandar Lampung as the case study. Bandar Lampung is the capital of Lampung Province with the population of over one million people. Figure 1 show in Map of Bandar Lampung, Latitude and longitude coordinates are: - 5.450000, 105.266670.

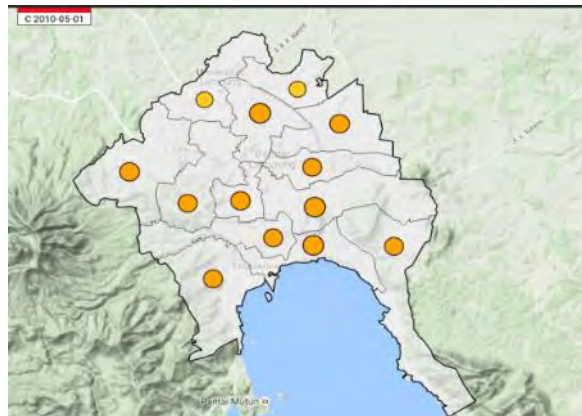

Figure 1: Map of Kota Bandar Lampung
Source: Badan Pusat Statistik, Republik Indonesia (web)

Table 1 shows of population in Kota Bandar Lampung. Bandar Lampung is large city. With its almost 900,000 population, the city is considered to the third most populous one in the country.

Name	Status	Population Census 2010-05-01
Kota Bandar Lampung	City	881,801
Kedaton	District	88,314
Kemiling	District	71,471
Panjang	District	63,504
Rajabasa	District	43,257
Sukabumi	District	63,598
Sukarela	District	70,761
Tanjung Karang Barat	District	63,747
Tanjung Karang Pusat	District	72,385
Tanjung Karang Timur	District	89,324
Tanjung Senang	District	41,225
Taluk Betung Barat	District	59,389
Teluk Betung Selatan	District	92,158
Teluk Betung Selatan	District	62,663

Table 1: The population in Kota Bandar Lampung

2.2 Sentiment Analysis

Figure 2 depicts a typical sentiment analysis model. The model takes a collection of tweets as input, and processes them using three core steps, data preparation, and review analysis and sentiment classification. The results produced by such a model are the classifications of the public mood.

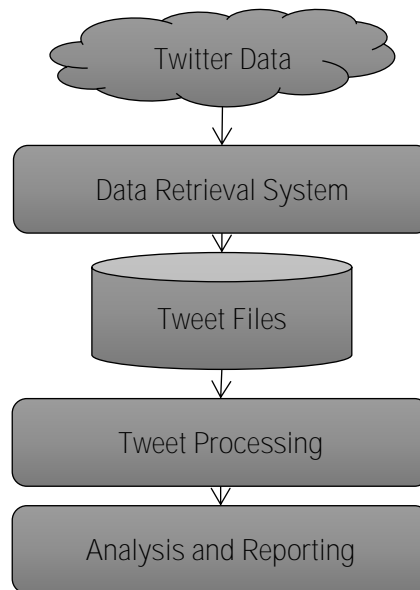

Figure 2: Sentiment analysis model

2.2.1 Data preparation

Text preparation is nothing but filtering the extracted data before analysis. It includes identifying and eliminating non-textual content and content that is irrelevant to the area of study from the data. The retrieved data was cleansed by removing: symbols, punctuations, special characters, URLs, and numbers. Bag of Words approach was used for sentiment analysis.

- Stemming: Each tweet was stemmed into the group Indonesian words
- Matching: A match of each word was searched in the lexicon database
- Scoring: Positive and negative matches were summed to define a score of each tweet
- Polarity: $(P-N) / (P+N)$, where P=total sum of positive sentiment words; N=total sum of negative sentiment words

2.2.2 Naïve Bayes classification

Naive Bayes classifier is a simple model for classification. It is simple and works well on text classification. It is a probabilistic classifier based on applying Bayes' theorem with strong independence assumptions. This is the simplest form of Bayesian Network, in which all attributes are independent given the value of the class variable. This is called conditional independence. It assumes each feature is conditional independent to other features given the class. A Naive Bayes classifier is a technique that applies to a certain class of problems, namely those that phrased as associating an object with a discrete category. We make two classes positive and negative tweets.

A conditional probability is a probability that event X will occur, given the evidence. So, our initial formula looks like this:

$$P(\textit{sentiment}|\textit{sentence}) = \frac{P(\textit{sentiment})P(\textit{sentence}|\textit{sentiment})}{P(\textit{sentence})}$$

We can drop the dividing $P(\textit{sentence})$, as it's the same for both classes, and we just want to rank them rather than calculate a precise probability. We can use the independence assumption to let us treat $P(\textit{Sentence} | \textit{Sentiment})$

as the product of P (Token | Sentiment) across all the tokens in the sentence. So, we estimate P (Token | Sentiment) as:

$$\text{Count (This token in class)} + 1 / \text{count (All tokens in class)} + \text{Count (All tokens)}$$

The classify function starts by calculating the prior probability (The chance of it being one or the other before any tokens are looked at) based on the number of positive and negative.

3. ANALYSIS RESULTS

We collected 53389 tweets from September-October 2015. We built a sentiment classifier in order to assess the mood of the twitter. Here we use Twitter to study the fine-grained geography and dynamics of sentiment in the greater Bandar Lampung City area, identifying areas and times of positive and negative sentiment. Figure 3 shows tweets collected from Bandar Lampung city during September-October 2105.

No	Name User	Username	Text	Date	Time	Latitude	Longitude
1	Anniza Faradhana	annizafaradhana		9/10/2015	10:05:23	-5.36457	105.2418
2	sinta yana	sintayanaa_	Love you sayang{} http://t.co/k8vyoQKQg6	9/10/2015	10:05:20	-5.38399	105.2593
3	ollamiller	olveee	thanks syg, akhirnya 6 colours of nyx mat	9/10/2015	9:56:36	-5.40381	105.2883
4	JO	julio_agusta	Makann	9/10/2015	9:56:16	-5.42253	105.2644
5	harpeet cazoria	harbraan	Libur aja masih tetep dines	9/10/2015	9:55:57	-5.39561	105.2575
6	CK	21Adelia	Selamat pagi	9/10/2015	9:55:21	-5.42322	105.2639
7	Zzzz..ayn	zaynsandika	Kerja kerjaa! (at Toyota Auto 2000 Rajaba	9/10/2015	9:55:08	-5.35657	105.2208
8	Mumuss	Mustika2502	Rutinitass	9/10/2015	9:55:07	-5.37827	105.3024
9	FRANZESKASimarmata	franzeskhamaria	E002-R,45k Shipping : JNE	9/10/2015	9:54:23	-5.37954	105.2638
10	Robert	Bedjodiningrat	Seperti "hantu". Karena setiap deru angka	9/10/2015	9:51:44	-5.42516	105.2684
11	vian	supianto8	Dah mulau keruh ne orang rmh mulai lagi	9/10/2015	9:50:06	-5.397	105.2684
12	-	densfitri	Pagi-pagi-pagi-pagi-malam	9/10/2015	9:48:57	-5.36796	105.2419
13	Yugo Verdinand	yugoverdinan	Samar samar (at Gedung F fakultas ekono	9/10/2015	9:47:08	-5.36287	105.2453
14	Shoraya Yudithia	shorayayudithia	With Mariessa at Lamban Nyai — https://	9/10/2015	9:46:38	-5.42555	105.2476
15	yola	yolandaastari	Lari dri knyataan pak udin	9/10/2015	9:46:23	-5.42005	105.2466
16	Rani Karenina	Kharen_103	Pagi pagi syudah digupekin sma hafalan s	9/10/2015	9:45:36	-5.43559	105.2803
17	MedianaSury	surianoong	Sekalinya kuliah nyubuh eney	9/10/2015	9:44:05	-5.36775	105.2445
18	Natasha Josevine ?	_Natasha_Josevi	Sarapan matem	9/10/2015	9:42:07	-5.42505	105.268
19	RomanJayaSaputra	RomanJaya_S	Telat ini mah	9/10/2015	9:41:46	-5.36521	105.2437
20	Natasha Josevine ?	_Natasha_Josevi	Sarapam matemmm	9/10/2015	9:41:32	-5.42499	105.2678
21	UNA?	FinalisaUna	kepagian	9/10/2015	9:39:45	-5.36408	105.2423
22	Raa	SafaraRdifa		9/10/2015	9:39:40	-5.36262	105.2439
23	achmad danu iskandar	iskandar_danu		9/10/2015	9:39:32	-5.43917	105.256
24	Amalia Harpani	amaliahrp_	RT "@FaktaGoogle: Rindu yang tidak tersa	9/10/2015	9:39:27	-5.36276	105.2435

Figure 3: Tweets collected from Bandar Lampung during September-October 2015

We collected tweets by name of user, text tweets, date, time, longitude and latitude. From this data we classification which tweets positive or negative based on location.



Figure 4: Map of tweets collected from city of Bandar Lampung during September and October, 2015

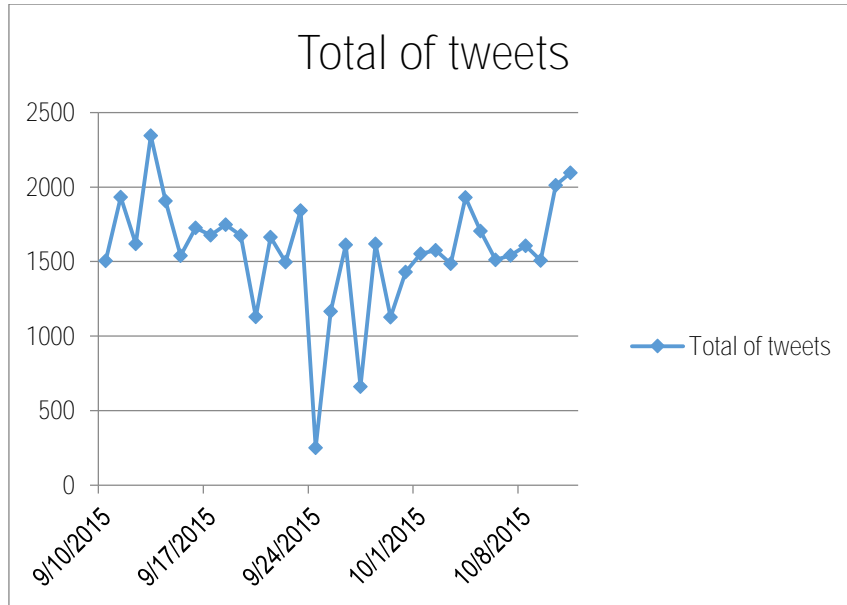

Figure 5: Total tweets per day

We have analyzed the geo-tagging social media data based on sentiment analysis in Bandar Lampung during a period September and October 2015. By building classifiers based on tweets mood, we are able to map the general trends and identify areas of strong sentiment.

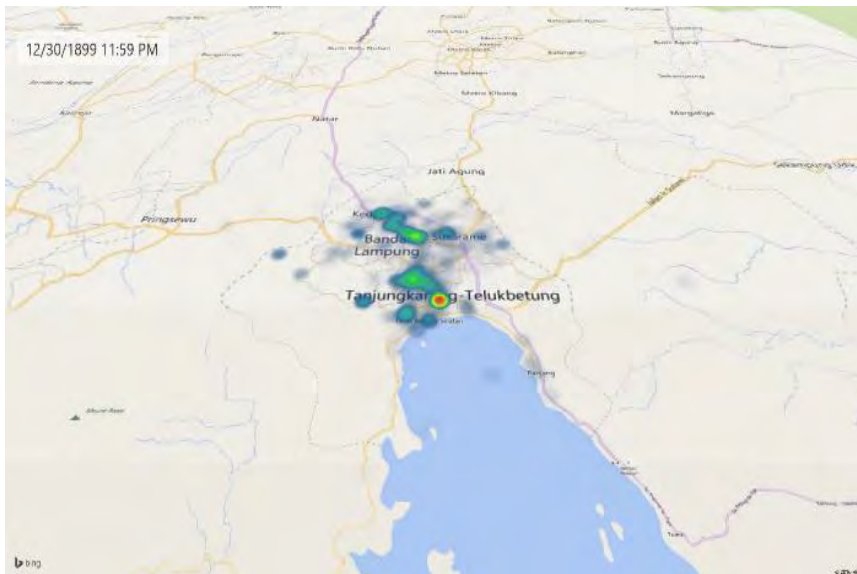

Figure 6: Map of tweets data based on tweets frequency

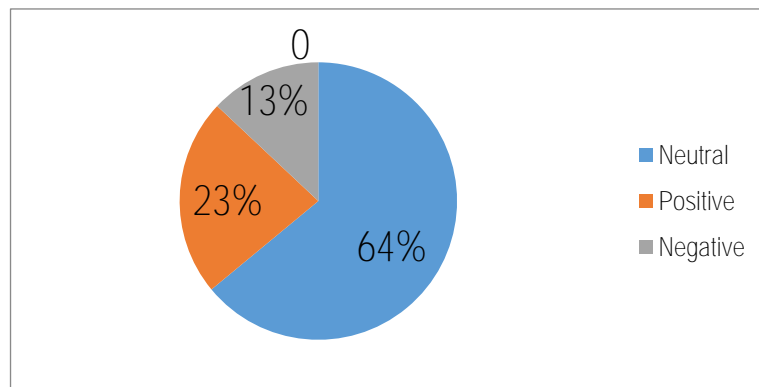

Figure 7: Overall sentiment classification

Figure 7 shows overall sentiment classification, this data we can use to find what the problem makes users negative tweets. After the classification process of positive and negative tweets, then we will filter the data based on the issues relating to the environment, sustainable development and climate change. For the future work we are trying to collect as many words related to the environment, sustainable development and climate change that can support better filtering tweets again.

4. CONCLUSION

This study is an initial attempt to investigate public mood in the city to reveal relationships between opinion mining and real world phenomena based on sentiment analysis. This study establishes a methodology for using opinion mining social media and sentiment analysis to understand cities. This information could help city planners plan future developments. Our method of public mood analysis has several strengths. For future work we plan to collect more tweet data to get specific mood about city. We hope this paper will contribute to the research of the built environment and is based on a complex network analysis based on social media from Twitter.

REFERENCES

- [1] Akash, S., & Bhasker, P. (2012). Opinion Extraction and Classification of Real Time Facebook Status. *Global Journal of Computer Science and Technology*.
- [2] **Antonio J Yepes ,Andrew MacKinlay and Bo Han. 2015. "Investigating Public Health Surveillance using Twitter". Proceedings of the 2015 Workshop on Biomedical Natural Language Processing (BioNLP 2015), pages 164–170, Beijing, China.**
- [3] Geetika, V., & Sangharsh, T. (2014). Facebook as a Corpus for Emoticons-Based Sentiment Analysis. *International Journal of Emerging Technology and Advanced Engineering* , 904-908.
- [4] I. Lunden, Analyst: Twitter passed 500M users in June 2012, 140M of them in US; Jakarta biggest tweeting city, TechCrunch
- [5] Jasleen, K., & Jatinderkumar, R. S. (2014). On Classifying Sentiments and Mining Opinions. *International Journal of Emerging Technologies in Computational and Applied Sciences (IJETCAS)* , 210-214.
- [6] **Quynh C Nguyen. 2016. "Building a National Neighborhood Dataset From Geotagged Twitter Data for Indicators of Happiness, Diet, and Physical Activity". JMIR Public Health Surveill 2016;2(2):e158.**
- [7] **Troussas,C., and Maria,V.,2013. 'Sentiment analysis of Facebook statuses using Naive Bayes Classifier for Language learning',paper presented at the Information ,Intelligent and Applications (IISA),july 2013.**

Track 10: Place-making & Community Empowerment

Session 3.13: Community Empowerment (1)

The Strategy of Launching Rural Regeneration in Pingtung County Government

Hung Chieh-jen^a, CHANG Kuei-feng^b, LIUNG Hing-heng^c, LU Yuan-hua^d

^a Pingtung County Government, Taiwan, a001142@oa.pthg.gov.tw

^b Pingtung County Government, Taiwan, a001811@oa.pthg.gov.tw

^c Pingtung County Government, Taiwan, a000124@oa.pthg.gov.tw

^d Shu-Te University, Taiwan, yhlu@stu.edu.tw

ABSTRACT

Rural Regeneration is the most prominent national policy project of the Council of Agriculture, Executive Yuan of Taiwan. According to the Agricultural Development Regulations issued for implementation in Aug.4, 2010, 150 billion NT dollars of the rural regeneration fund would be allocated to ten-year budgets to boost rural developments for fishermen and farmers. Located in the most southern part of Taiwan, Pingtung County is the most important agricultural county in the south and Pingtung government has dedicated to the rural regeneration policy to improve the life conditions there. Among the 381 agricultural communities, 238 participated in incubation programs, of which 37 communities were granted for rejuvenation. This project aims at depicting how a local government of Pingtung County complies with the central government to promote rural regeneration policies and to innovate their governance.

Keywords: rural regeneration, landscape axis, vital action project, live and work in peace and contentment

1. INTRODUCTION

To meet the need of the entire rural development, rural regeneration is settled. With current agricultural communities in the center, participating from bottom to top, agricultural villages are holistically established to better **residents' life. Besides, related industries, natural ecology, and living environments are also planned and constructed** for conserving the cultures and sustain a green environment. Therefore, Pingtung County Government (PCG) established Rural Renewal Project Office (RRPO) on Mar.3, 2016 to specifically and directly deal with rural regeneration matters; related resources can hence be integrated effectively.

In 2016, PCG has implemented the incubation programs, vital action projects, rural rejuvenation plan reviews, annual implementation plans, farmhouse inspection and management, excellent rural community competitions, **and other related plans. To achieve the goal of "work and live in peace and in contentment," rural regeneration is able to be carried out with sufficient resources and appropriate content.** RRPO is led by the deputy governor along with each bureau to voluntarily take charge of a township as a team and to assist each agricultural community involved in the project. It is expected that through in-depth interviews and counselling, strategies for promoting regenerations can be found. **Cross-bureau integration on the basis of "communities" contributes to effectiveness** of resource combinations for the interests of people in the communities.

2. AGRICULTURAL REGENERATION POLICIES OF PINGTUNG COUNTY

Given more modernized areas in Taiwan, more and more people have begun to recollect a simple rural life of friendly people, without hustle and bustle of cities. In view of the fact that some communities, after receiving subsidies, have started to build their own communities with their plans, or others copy some successful communities in form but neglect local features, the agricultural regeneration project was initiated by the Bureau of Soil and Water Conservation of the Council of Agriculture. A bottom-up promotion policy has been adopted and trained residents through the Bacon Project for them to comply with their community regulations and create a distinctive community from the perspectives of life, production and ecology.

As a leading position to promote the overall construction of the domestic communities, PCG makes good use of the resources from the central government to boost regeneration. Since 2015, PCG, by the principle of innovative management, has integrated actual demands and development plans. In 2016, PCG even took the lead in setting up the first RRPO in Taiwan, with a single window linking the central and local resources to help the communities promote rural industries, train professionals, explore local cultures and inject new elements to local resources. Via resource integrations, the direction of rural regenerations is in line with other major projects of PCG.

3. SEVEN AREAS OF RURAL REGENERATION

The promotion of rural regeneration in Pingtung County is an entirely new administrative subject and experience. Especially in the 21st century with the aim of conservation as a way of life, we identify existing landscape types from the past, in search of a new development link among life, production and ecology. Apart from local characteristic of each village, high-quality, safe, recreational, and ecological communities must be built as well as gathering rural manpower in teams to increase self-reliance. The rural landscape structures of Pingtung County can be divided to seven areas: (1) the valley living production area, (2) the multi-agricultural production and living area, (3) the Tinan large-scale open production and living area, (4) the Pingtung City core development area, (5) the production and living area of Pingnan traditional tribes, (6) the fishing village area of living, and (7) the Peninsula humanities and natural ecological living area. The division is based on the historical changes in life. Through the environmental investigation and analysis, the rural areas of Pingtung Country are spatially evident with a goal of reconstructing the unique rural landscape and its sustaining systems.



Figure 1: Seven areas of rural regeneration

4. THE VISION AND PROSPECT OF THE DEVELOPMENT OF THE SIX ZONES OF AGRICULTURAL REGENERATION

There are six areas for development in Pingtung County on the basis of different visions. Respectively, they are “pro-mountain ecological corridor”, “characteristic agricultural development area”, “high-quality new life town”, “metropolitan core life area”, “marine recreation development area,” and “Peninsula sustainable tourism area.” These six zones for development correspond to (1) eco-tourism, environmental preservation, cultural preservation, humanistic values, (2) I-center cross-area values for agricultural regeneration, (3) liveable city+ investment promotion +green living +low carbon transportation, (4) Sightseeing fisheries, low carbon sustainability, marine recreation and convenient transportation, (5) cultural creativity, sightseeing recreation, ecological conservation and ecotourism. The six visions of the development are combined with the seven areas of the geographical division of rural regeneration, which results in a prosperous development of Pingtung County.

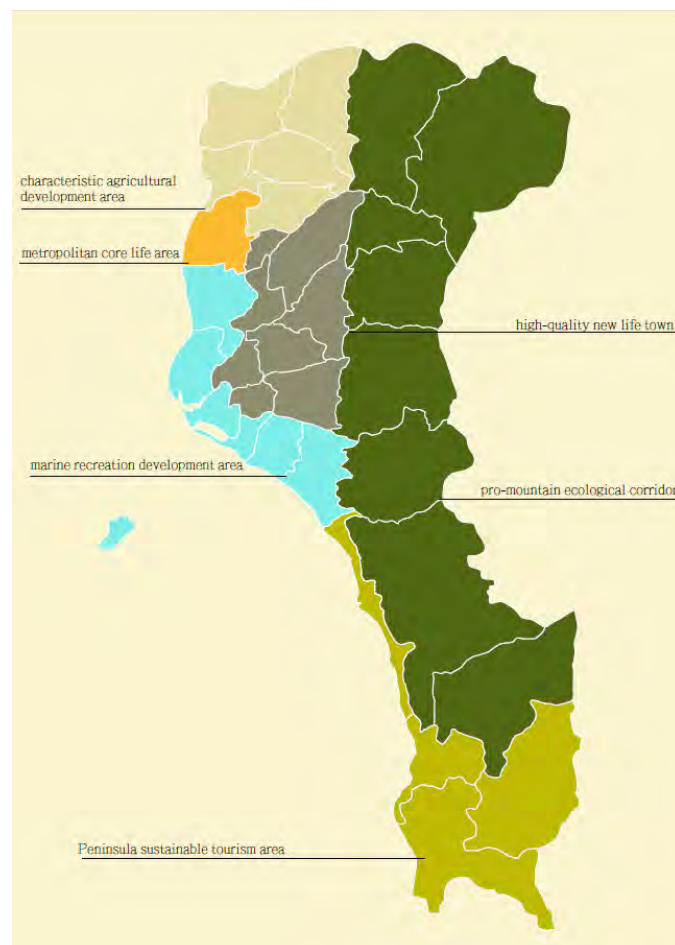

Figure 2: Six areas for development in Pingtung County on the basis of different visions

5. INNOVATIVE GOVERNANCE OF RURAL REGENERATION IN PINGTUNG COUNTY

On March, 3, 2016, the first Rural Renewal Project Office was officially established in Pingtung County to initiate the rural regeneration programs and promote rural sustainable development and rural revitalization. Through the matrix-based organization mode, a platform for the rural regeneration program will be constructed by a dedicate staff, and resources of the central and local governments will be associated to take a big leap ahead. Pingtung County and Yilan County have been at the leading position to boost the overall development of community building in Taiwan. Moreover, the special budget under the Rural Renewal Regulation offers a new energy for rural transformation. However, the rural regeneration program was developed by the community itself after stages of discussions and its effect was less significant. As a result, starting from 2015, the county government, led by the Deputy Mayor, Wu Lixue, has integrated the actual needs of the communities and development plans. For example,

along the line of County Rd.185, resources are combined to build up a featured agricultural village of culture, industry and tourism.

When local governments have been entrusted by the Bureau of Soil and Water Conservation under the Council of Agriculture to promote rural regeneration businesses, it is imperative for a special project office to integrate and plan them. PCG established the first Rural Renewal Project Office as a single window linking the central and local resources to assist the communities in promoting rural industries and personnel training. Furthermore, a multi-faceted integration of people, culture, farm, production and landscape is complete to link marketing and tourism to vitalize rural lives. As a result, the Rural Renewal Project Office was set up to help the communities incorporate sustainability policies into their respective rural regeneration programs. Through resource integration, the rural regeneration project complements the overall plan of PCG as to comprehensively implement the project, empower the community resources and sustain the community development.

County Rd. 185 landscape axis

County Rd. 185, from Dajin to Fangliao, is about 68.885 kilometers long and is the fifth longest county road among all in Taiwan. Along the line by the west side of the central mountain range of Taiwan, it is also named Yanshang Road for its location along the mountain side and is considered the main contact road among the eight mountain townships in Pingtung County, forming a multi-ethnic convergence axis. The majority of the population in Pingtung County are Taiwanese, but the proportion of Hakka people accounts for 23 %, indigenous peoples, including Rukai, Paiwan, and Pingpu, are about 6.85%, and immigrants from China, including veterans, Dachen immigrants, Burmese immigrants are about 8.4%. Due to the diversity of cultures, County Rd. 185 goes through and integrates different ethnic groups in terms of life, ecology, production, culture and other regional categories.

Pingtung rural tour of the six arts

The term “rural six arts” refers to an action plan of arts in rural areas to create an artistic community. Through a multi-resource mixture of County Rd. 185 and Rd. 189, coupled with the marketing of PCG, emerging tourist attractions and experience-based recreation modes are established. With the theme of the rural regeneration program, the **“valley living production area” uses eco-urban and rural constructions as the future blueprint.** Using the six arts (performing arts, toys art, agriculture, crafts, travel art, and stone carving art) as the main elements, the plan fuses the previous outcomes of the industrial development, ecological conversation, cultural preservation, and the software and hardware construction. Within the theme of Six Arts Tour in Pingtung Rural Area, cultural tourism is implemented with the **residents’ participation and with a rural image. The landscape along the axis can be shaped then to promote a travel package in the future.**

Along County Rd. 185, the targeted communities of the rural regeneration which are equipped with the six arts and have been granted as the included communities in the project or have developed well include: Xinfeng Community, Anpo Community, Dewen Community, Sandi Community, Maer Community, Qingye Community, and Wanjin Community. The seven communities have been chosen as the main constructs of this proposal. After the **integration, installation arts and signboards will be settled. Concrete constructs will be done through the “Exploring Experience Area” and the “Native Community Environment Beautification of the Xinfeng Community,** for instance. In the following, small country tours, environmental improvements, industrial brand planning and design, deepening and upgrading industries, eco tours, conservation and improvement of ecological environment, cultural heritage and learning can be all implemented to highlight the features and visions of this project.

Tribes, starry skies, and fun of camping

Modern people have urgent needs to approach the nature and the earth in the leisure time due to pressure from work, family and so on. In order to mediate and ease their minds, camping in the wild provides a way out to balance the body and the mind. Given this, Maer Community and Qingye Community create a spotlight for camping in tribes under the starry sky.

On the other hand, these **two communities have a theme of “myth art village” and “traditional horse-riding arena** to corporate ecotourism, post space, star camping, traditional folk, tribal i-center as community highlights. The landscape planning and design style can be improved, and new features and opportunities are shaped in rural areas along with tribal characteristics, and marketing camping.

County Rd. 189: Six arts axis

The six arts innovation and management plan on the left bank of Gaoping River will be carried out from 2017 to 2019. The spirit of the plan lies in the mastery of the merits and opportunities of regional and geographical conditions and a further integration of urban and rural areas in the prospect of co-prosperity. **The concept of “living circle,” “production circle,” “Ecological circle,” and “cultural circle” will be implemented to arrange a sustainable landscape.**

In a cycle of annual plans, the Bureau of Soil and Water Conservation connects directly with PCG to implement the rural regeneration policy. In 2017, townships along County Rd. 189 and 185 will be united and extended as a **vertical landscape axis, encompassing “Pingtung Six Arts Life Museum.” A bright spot of six arts via a cross-domain integration will build up agricultural communities through resources of people, culture, geography, specialties, landscape, and so on.**

Action plan of rural revitalization

Based on the characteristics and needs of individual rural communities, the rural revitalization plan is to broaden **the concept of rural residents’ bonds** and co-participation. They take part in practical courses, practices of life, production, conservation of ecology and culture, and even bring about a concept of community consensus. The establishment of rural communities leads to self-development awareness and create new features to them.

The plan subsidizes NT\$250,000 for each rural community. Programs or courses will be offered and conducted through a consensus meeting, a proposal, qualification and content review, workshop experience sharing, write-off instruction and guidance. A dynamic, systematic action play will be carried out to create bright spots in a multi-dimensional landscape in a new community. Integrated with six arts, the features of each community are highlighted and new opportunities are created for community life.

6. CONCLUSION

Pingtung County lies in a place of green mountains and blue seas. During the day time, the sun shines to rural communities with full energy. At night, starry skies are seen in Qingye Community and Maer Community, camping venues. Along the landscape axis of County Rd. 185, granted revitalized villages corporate six arts into their lives **to display individual features. The “six arts,” are assimilated to the six arts of Chinese Confucianism,” rites, music, archery, riding, books, and art.” But now the six arts refer to performing arts (Maer Community), toys art (Anpo Community), agriculture (Qingye Community and Dewen Community), crafts (Sandi Community), travel art (Xinfeng Community), and stone carving art (Wanjin Community), altogether comprising Pingtung Six Arts Life Museum.** Through qualia in the six arts of rural communities and those of the action plan of rural revitalization, a new journey to Pintung has been linked like a string of pearls, leading to a new era, a new appearance and a new energy.

The rural revitalization policy and innovative governance is a complete, sustainable development and management of rural communities along a landscape axis. Regeneration is promoted to improve the ecological environment, to maintain agricultural cultures, to enhance country lives, and to construct new villages. With the help of the Rural Renewal Project Office of Pingtung County, related businesses are integrated on a single platform or window to directly link to the central government, including the Bureau of the Soil and Water Conservation of the Council of Agriculture and its affiliated divisions. Therefore, horizontally and vertically, related departments are able to be associated and contacted. Special personnel are responsible to contact them and implement their tasks. Meanwhile, the project of value-added strategies for rural revitalization is proposed to integrate the resources of each department or office to comply with their current administrative and project promotions. Finally, other resources will also be put in related rural constructions or revitalization to add values with this project for more **concrete effects, realizing the governmental vision of Pingtung County, “work and live in peace and contentment.”**

2030 Districts: Putting Ideas into Action

Yaki WO^a, Jiri SKOPEK^b, Vincent MARTINEZ^c, David LOW^d, LI Jiexin^e

^a 2030 Districts, ywo@architecture2030.org

^b 2030 Districts, jiri.skopek@am.jll.com

^c Architecture 2030, martinez@architecture2030.org

^d 2030 Districts, davelow@2030districts.org

^e 2030 Districts, jli@architecture2030.org

ABSTRACT

As of 2016, fifteen 2030 Districts® have formed across North America to implement the carbon reduction targets set by Architecture 2030 for existing buildings through energy, water and vehicle emissions reductions.

2030 Districts® are unique private/public partnerships that bring property owners, managers and developers together with local governments, businesses and community stakeholders to provide a business model for urban sustainability through collaboration, leveraged financing, and shared resources. Together they engage local community stakeholders to benchmark, develop and implement creative strategies, best practices and verification methods for measuring progress towards common goals.

The majority of 2030 Districts are located in downtown commercial cores and city centres, which typically have the highest and most concentrated energy and environmental impact. There, the reduction of energy and water consumption, transportation emissions, and improved indoor air quality provides the additional benefit of increased competitiveness in the business environment and owner's returns on investment. Several of the Districts that are vulnerable to environmental threats such as flooding also focus on community and economic resilience. This paper will explore the achievements of the 2030 Districts in meeting their carbon reduction targets, and their impact on raising awareness of climate change and mobilizing community action. It will also explore some of the challenges of fighting climate change at a community level and provide guidance for emerging 2030 Districts and/or cities interested in establishing 2030 Districts.

Keywords: design process, green rating tool, high-performance building

1. 2030 DISTRICTS

“Without a dramatic change in the way built environments are designed, constructed, and operated, the world has no chance of adequately **addressing climate change**.” - Architecture 2030

On December 12 2015, the world came together and reached a monumental climate change agreement. At the **heart of the agreement is a “long-term goal” to limit global average temperature increase to**

“well below 2°C above pre-industrial levels and to pursue efforts to limit the temperature increase to 1.5°C.”

To realize this goal, the scientific community estimates that the world must peak total greenhouse gas (GHG) emissions by 2020 and reach zero fossil fuel CO₂ emissions by about mid-century. [1]

COP 21 in Paris also provided an opportunity for the building sector to address the critical role it must play in reducing carbon emissions worldwide. Urban environments are responsible for over 70 percent of global energy consumption and GHG emissions, mostly from buildings. [2] Over the next two decades, it is estimated that a staggering amount of building area will be newly built or rebuilt in cities worldwide to accommodate a projected 1.1 billion new urban inhabitants – a number equivalent to the current population of the entire western hemisphere. [3] These trends reveal an important opportunity to address the climate change crisis through the design and operation of the urban built environment. This requires leadership, ingenuity, and new types of partnerships.

1.1 2030 Challenge

Architecture 2030 defined the connection between climate change and the global building sector in 2003 when it revealed that buildings are responsible for 48 percent of total U.S. energy consumption and greenhouse gas (GHG)

emissions, and 77 percent of total U.S. electricity consumption. [4] It followed that architects and other building professionals, who design our buildings and specify materials and equipment for new projects, have a direct stake in lowering the level of carbon emissions from buildings, particularly in dense urban areas. Architecture 2030 partners and collaborators have been instrumental in framing the discussion around the decarbonization of the global built environment.

In 2006, Architecture 2030 issued the 2030 Challenge, asking the architecture and design community to commit to using design strategies and specifications that would gradually reduce GHG emissions in all new buildings, developments, and major renovations, to make them carbon-neutral by 2030. Since the Challenge was issued, thousands of design professionals, firms, and organizations have committed to meeting the 2030 Challenge in their work.

Delving deeper into energy use and GHG emissions in cities, Architecture 2030 issued the 2030 Challenge for Planning in 2008. The 2030 Challenge for Planning goes beyond reducing carbon emissions from individual buildings, integrating transportation, infrastructure, planning and climate resilience into its focus. This challenge comprises a set of incremental reduction targets for energy, water and vehicle emissions, and includes 2030 Challenge targets for new construction while adding targets for the existing building stock. The 2030 Challenge for Planning has attracted stakeholders from both the private and public sectors, including engineers, building owners and managers, institutional and civic leaders, and businesses.

2030 CHALLENGE FOR PLANNING: EXISTING BUILDINGS

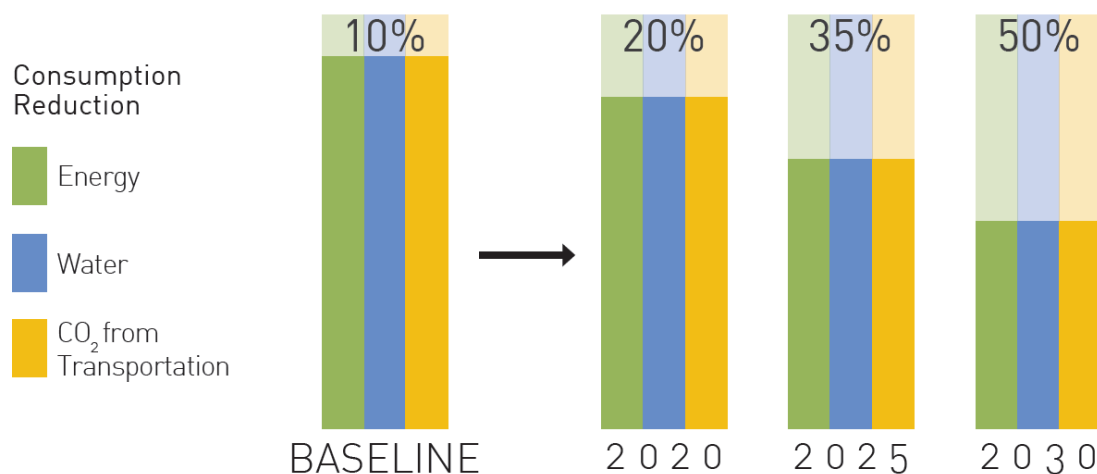

Figure 1: District 2030 reduction targets for existing buildings

1.2 What is a 2030 district?

The 2030 Districts movement began as a collective response to the 2030 Challenge for Planning. A 2030 District is a locally organized, private/public partnership among stakeholders within a concentrated commercial or institutional urban core. 2030 Districts demonstrate that reductions in energy, water, and transportation emissions called for by the 2030 Challenge for Planning can be achieved through collaboration, leveraged financing, and shared District Member Resources. 2030 Districts bring together local property owners, managers and developers, government officials, businesses, and community institutions. Together they develop and implement creative strategies, best practices and verification methods for achieving progress towards a common goal.

Across North America and beyond, 2030 Districts are forming to meet the emissions reduction targets called for by the 2030 Challenge for Planning. Emissions reduction solutions and strategies vary among cities, depending on climate and geography as well as the local economy and community goals and priorities. For this reason, 2030 Districts are unique in their flexibility, while consistent goals and performance tracking strategies across Districts allow for the collaboration and success of the entire 2030 Districts Network.

2. THE NEXT STEP: CONVENING A 2030 DISTRICTS NETWORK

Architecture 2030 organized the first annual 2030 Districts Summit in August of 2013, which was attended by representatives of all established Districts and those from cities interested in creating a District of their own. The outcome of the Summit was consensus among District leadership of the value of forming a Districts Network.

In October of 2013, Architecture 2030 drafted a comprehensive business plan to implement future expansion of the Network and its benefits to members. The multi-pronged vision of the 2030 Districts Network included attracting new cities to the 2030 District model, supporting peer exchange among Districts, aggregating the purchasing power of Network membership, and creating national partner relationships. Architecture 2030 launched a 2030 Districts Network website, with online technical tools provided by Lawrence Berkeley National Laboratory, and a number of toolkits for existing and emerging 2030 Districts and their members.

Beginning with Seattle in 2011, the 2030 Districts Network has grown to fifteen (and counting) in 2016. Through the current 2030 Districts Network, all 2030 Districts benefit from collaboration and services, including technical support, fundraising guidance, access to national partners, and participation in 2030 Districts Network conference calls, summits, webinars and capacity building workshops



Figure 2: Representation of the established Districts 2030

3. WHAT HAVE THE 2030 DISTRICTS ACHIEVED SO FAR?

To date, the 2030 Districts have made tremendous progress towards meeting their goals and targets. The Seattle 2030 District's Strategic Plan presents a vision for a high performance urban area that dramatically reduces the environmental impacts of building construction and operations while contributing to the growth of Seattle's economy. [5] This vision has taken hold within Seattle's City Council, which has launched the Living Building Pilot to incentivise and implement the construction of buildings that capture and treat all stormwater and produce as much energy as they use. Meanwhile, Seattle 2030 District energy achievements include five whole-building retrofits that achieved an average 17% energy reduction, and more than 8.2 million kWh total energy savings for the District as a whole. [6]

The Cleveland 2030 District, which joined the initiative in 2011, has brought together 168 buildings comprising 40 million sq. ft. Sixty six percent of these properties now report their energy consumption in Portfolio Manager, an ENERGY STAR tracking software developed by the US Department of Energy. With the help of District programs and initiatives these buildings are currently operating at a 24.2% reduction from the district baseline, saving an average of 107,752,188 kWh (367,665,725 kBTUs) per year – equivalent to the total energy use of almost 3,000 single family homes in the Midwestern US. The Cleveland 2030 District is also working with the Water Department and local transportation agencies to understand historic consumption trends and define water and transportation baselines. [7]

Pittsburgh, one of the most aggressive Districts to pursue the 2030 goals, has involved 85 property partners who have committed 438 buildings totalling 68.2 million square feet. Pittsburgh 2030 District has held 44 one-on-one meetings with property partners and held 32 educational events and presentations. Partner building achievements to date include 12.5% energy reduction, 10.3% water reduction and 24.2% transportation emissions (CO₂) reduction. [8]



Figure 3: Pittsburgh progress toward the 2030 goals

The San Francisco 2030 District, with an aggregated member building area of over 12 million square feet, has recently been awarded \$5 million in grant funding from the California Energy Commission. The grants are targeted **at two of San Francisco's most prevalent, and therefore most environmentally impactful, building types: mixed use and small (under 50,000 square feet) commercial.** The funding will support the San Francisco 2030 District both in proving the business case for Zero Net Energy (ZNE) retrofits for these building types as well as in developing tools and resources for ZNE retrofits throughout the city and country.

The 2030 Districts effort is not limited to larger cities, and has garnered the participation of smaller cities such as Stamford and Ithaca. Though it is one of the newest and currently the smallest 2030 District, Ithaca has secured funding from both the New York State Energy Research and Development Authority (NYSERDA) and the Park Foundation, **supporting the District in proving the model's viability in smaller markets. And in its 2015 annual report, Stamford demonstrated an improved energy performance of 23.9% for 2030 District members, compared to the baseline.** [9] In addition to the key District 2030 goals of energy, water and transportation, Stanford has identified **resilience as one of its key objectives. To assess Stamford's vulnerability to coastal storms, the District is working closely with the City of Stamford to complete a preliminary review of the UNISDR Disaster Resilience scorecard and is actively working with CIRCA, C2ES and other organizations to determine which meaningful actions will make Stamford a more resilient city.**

4. CONCLUSION

2030 Districts have emerged as an effective bottom-up, community-driven mechanism to fight climate change. For local government, 2030 Districts provide an opportunity to collaborate with communities on implementing

increasingly critical climate change policies. For participating businesses and commercial partners, particularly the real estate sector, 2030 Districts provide an opportunity to document organizational commitments to social responsibility and act as a driver for improving operational performance, reducing energy and water costs, and participating in a green economy. Nationally and globally, the 2030 Districts Network is proving to be an effective mechanism for aggressively reducing carbon emissions at the scale necessary to meet our climate change goals.

REFERENCES

- [1] IPCC. 2013. IPCC Fifth Assessment Report, 2013: Representative Concentration Pathways (RCP), temperature projections for SRES scenarios and the RCPs. Available at https://www.ipcc.ch/pdf/assessment-report/ar5/syr/AR5_SYR_FINAL_SPM.pdf
- [2] Un-Habitat (2010) **State of the world's cities 2010/11: Cities for all, bridging the urban divide**. London: United Nations Human Settlements.
- [3] McKinsey Global Institute (2012) *Urban World: Cities and the rise of the consuming class*.
- [4] U.S. Energy information administration (EIA) (2012) Available at: <http://www.eia.gov/>
- [5] Seattle 2030 District (2016). A Vision for 2030: Our Strategic Plan. Available at: http://www.2030districts.org/sites/default/files/atoms/files/Seattle_2030_District_Strategic_Plan_Updated.pdf
- [6] Seattle 2030 District Report-Leading Change (2013). Available at: <http://www.2030districts.org/sites/default/files/atoms/files/2030.Report.2013.pdf> .
- [7] Cleveland 2030 District Report-On the Rise (2015). Available at: http://www.2030districts.org/sites/default/files/atoms/files/2015%20Report%2C%201.26.16%2C%20electronic%20version.FINAL_.pdf .
- [8] Pittsburgh 2030 District (2015). Pittsburgh 2030 District Progress Report. Available at: <http://www.2030districts.org/sites/default/files/atoms/files/Pittsburgh%202030%20District%20Progress%20Report%202015.pdf> .
- [9] Stamford 2030 District (2015). Stamford 2030 District Annual Report. Available at: http://www.2030districts.org/sites/default/files/atoms/files/2030AnnualRep_022516_0.pdf .

A Critical Discussion on the Role of Architectural Practice in Development of Rural China: For Living Sustainably

LI Ke-han^a, Edward NG^b

^a The Chinese University of Hong Kong, Hong Kong SAR, likehan@link.cuhk.edu.hk

^b The Chinese University of Hong Kong, Hong Kong SAR, edwardng@cuhk.edu.hk

ABSTRACT

Worldwide sustainable development advocates sustainable living for all. The increasing architectural construction in China has become an irreversible force in rural development. Judging and conducting architectural practice based on analysis of living sustainably in rural China is urgently needed. The developing of rurality should show sustainability through the lenses of institutions, capital, and ecosystem services, with the aim of achieving well-being and maintaining ruralite-centred development. Such a perspective will facilitate the development of a conceptual framework of sustainable rural living. Architectural practices can advance sustainable living. Contextualisation sustainable living in rural China can identify the current needs of a decent and endogenous life, which is also open-source and universally beneficial to all. Prevalent problems in architectural practice in rural China such as house demolition, inefficient use, inadequate sustainable concern, and the recently unveiled top-down working pattern are challenged. An alternative framework of architectural practice pattern should be adopted to promote sustainable living in rural China. Such a framework should include context specification and should consider functional, procedural, material, and managerial sustainability.

Keywords: rural architectural practice, living sustainably, community empowerment

1 INTRODUCTION

The rural architectural practice emerging in China over the last decade should be re-examined from the lens of sustainability because sustainable development has become a worldwide consensus for human development. China has promoted sustainable development as a national strategy since the 1990s, but modernisation and industrialisation remain the ultimate goal of development. The Sustainable Development Goals (SDGs) in 2015 signify the global movement towards sustainability. Given the announcement of SDGs and the inevitable domestic structural transformation, China intensifies its effort to reduce carbon emissions and advance balanced urbanisation. Thus, rural architectural practice requires extensive knowledge on sustainable rural development and must promote sustainable approaches. The broad concept of sustainability provides varied perspectives on particular contexts and needs. Rural life in China is discussed using a conceptual framework of sustainable living. Targeting this, appraisal on the current situation and the latest empirical results of rural architectural practice reveals the problems and limitations. The role of sustainable architecture practice is also contextualised.

2. LIVING SUSTAINABLY IN THE RURAL CONTEXT

2.1. Rurality and rural space, sustainability, and well-being

Rurality provides a scope for the development of a conceptual framework of living sustainably. Rurality is related to the physical or emotional characteristics that are interpreted and reinterpreted by people living or working in **rural areas (Bosworth, Somerville 2013, Cloke 2003). These features guide ruralites' life, practice, and choice (Van Assche, Hornidge 2015).** Three theoretical lenses are used to conceptualise rurality (Adapted from Bryant, Pini 2010, p.4-5): the functional lens refers to the rural land use, landscape, and identities of living on land (Cloke 2006); the lens of political-economy indicates the domestic relationships and global connections of rural places based on networks such as production, economic activities, social structure and relations (Cloke, Goodwin 1992, Friedmann, McMichael 1989, McMichael 1996, Redclift et al., 1991); the lens of social constructionism shapes identities of **place by rural idyll and the "interconnection between construction of rurality and nature" (Cloke 2006, p.21).** These three lenses of rurality are applicable to a certain location, space, or place that support rural life. Location indicates specific topographic positions, whereas space pertains to human and non-human activities in a location; place possesses identities and boundaries which may be impermanent, permeable and blurred, indicating the socio-cultural and environmental values (Cloke 2006, Bosworth, Somerville 2013). A triad model of rural space (Halfacree

2006, p.51) includes rural localities, which are “inscribed through relatively distinctive spatial practices,” formal representations, which frame rurality “within the (capitalist) production process,” and everyday lives of the rural, which “incorporates individual and social elements (‘culture’) in cognitive interpretation and negotiation.” which emphasise “materiality, representation, and imagination” (Harvey 1996, p. 322) respectively when learning rural space.

The development trends or needs of a certain area influence the perception of rural life and future rurality. Sustainable development became a primary development model worldwide because of its global appeal. Necessary adjustments help to match sustainability to differential development paths of countries and regions. Knowledge of sustainability should be grasped from perspectives of locals and experts, and consider locality while internationally learn, share, and innovate. In a bottom-up approach, sustainable living starts by adopting small changes in daily life (United Nations 2016), which are easy to practice by any individual. Increasingly interdisciplinary studies and practice continue expanding the concept of sustainability. Sustainability incorporates problems, solutions, and responses at a systems level, which contains three key concepts, namely, institutions, capital, and ecosystem services (Jacques 2014). Institutions indicate the rights, rules, procedures, and features of governance (Young 2013). Development efforts must be resilient to changes. Thus, governance must be capable of providing effective rules to coordinate differential participants and modify the inappropriate rules at a proper time. Capital determines livelihoods and living style and comprises natural, physical, human, financial, and social capital, among most of which can change with varying conditions (Ellis 2000, Jacques 2014). Ecosystem services, a component of natural capital, **refer to the critical ecological goods and service for human life and society “in four types: provisioning, cultural, regulating, and supporting” (Jacques 2014, p.9): provisioning services address direct needs; cultural services meet the spiritual and recreational demands; regulating services provide stable spatial and temporal conditions; supporting services are crucial for the operations of other services.** The interaction and evolution of elements of rurality and rural space within development can be determined based on institutions, capital, and ecosystem services.

Rural institutions, capital, and ecosystem services influence local life and livelihood through which sustainable lifestyle can be introduced. According to the theory of rural livelihoods, the diversification and access to capital and capital-based activities can help people learn more skills, broaden their minds, and promote regional economy, which in the long run improve healthy, self-recognition and self-esteem of individuals and stimulate them to obtain decent work and pursue life goals (Jahan 2015). Institutions and ecosystem services vitally enable people to access desired capital and develop activities. The well-being of rural residents should be the most important goal and evaluate criterion for improving rural livelihoods. Human well-being encompasses security, the basic material for good life, health, good social relations, and also freedom of choice and action (Millennium Ecosystem Assessment 2005). Rural areas usually suffer from the effects of industrialisation, such as environmental degradation, low economic competitiveness, and disintegration of moral values, which weaken the capacity of local development and result in dissatisfaction in rural life. Resilient approaches that provide universal basic social services and enhance opportunities and capacity for choice can promote happy and healthy living, particularly lifelong and cross-generation well-being (Malik 2014). Sustainable operation and optimisation of rural institutions, capital, and ecosystem services can maintain the provision of public goods, strengthen the capability of individuals and communities, and provide additional options on what and how lifelong development can be achieved.

2.2. Ruralite

The concept of sustainable living in the rural context must be established based on the scope of institutions, capital, and ecosystem services and the achievement of well-being. The stakeholders of rural sustainable living should then be prioritised. Stakeholders include permanent or the long-term rural residents, particularly the underclass, the vulnerable, and the marginalised population. Approaches of diversifying the rural economy by intensive agriculture, tourism or other forms of business usually ingratiate urban customers and benefit rural middle-class and urban-rural migrants who have a higher education level, favourable living conditions, and high disposable income to pursue non-farming jobs (Ribeiro, Marques 2002). Uncertainty is another factor that increases the vulnerability of rural residents. Sources of rural income are usually unstable. Market and climate influence agriculture. Rural tourism suffers seasonal non-income and non-employment. The growth of rural businesses depends on external investments. Also, climate change and catastrophes can easily alter rural life and production. A liberal market causes alienation between people and land in regions with low labour-intensive production regions, result in segregation of land function that may adversely influence sustainable rural landscape management (Vos,

Meekes 1999). Migration between rural and urban is highly affected by the changing conditions of social welfare and services in the two regions (He 2014) thereby causing instability of rural human capital. People who live most of their life in the countryside have the right to benefit from development fairly and equally.

2.3. Role of rural architectural practice

Assessing the architectural effects on rurality is kind of moot because the current architectural practice is partially **driven by rural residents' needs and problems in development, which also reflect and influence rurality**. Rural architectural practice enables developers or builders to visually and rapidly realise their aspirations. The locals or outsiders shapes a location, space, or place, affects the evolution of rurality, and manifests through the spatial changes and transformations of rural lives. Thus, changes in rurality shaped by architectural practices to a certain extent indicate the willingness of rural residents to alter their lifestyles because they interpret rurality, but also show the imagination of rural life and interventions by the outside practitioners. The quality of built environment and rural landscape determines the quality of the well-being of ruralites, particularly their health, means of sustenance, functionality of the social and ecological system, and mental satisfaction. Rural architectural practice should help rural residents to optimise their built environment to enable them to live sustainably and achieve short- and long-term improvement of their well-being.

3. RURAL DEVELOPMENT AND LIFE IN CHINA

Rurality in Chinese context cultivates moderation and forbearance because rural life and society accept good or bad things as human nature, and such acceptance showcases the Chinese philosophy of perceiving and pursuing humanity (Village Diary 2013). Exploring Chinese rurality and rural identity entail following this nature of Chinese countryside because it roots the sense of belonging to rural residents who share a common social culture. Stories in a certain rural place that people remember and pass on indicate specific semiotic meanings. During decades of development after 1949, rural China is shifting from a society based totally on the familiar and a differential mode of association (Fei 1992) to a society with disassembled traditional social institutions and association based on **mutual interests or profits (He 2013)**. **The Chinese government dominates the country's rural development. The Three Rural Issue** raised in the late 1990s identified the increasing poverty, unguaranteed rights of the peasantry, and their dissatisfaction with rural livelihoods, instability of agriculture, and food insecurity. To address these concerns, national policies have started enhancing rural development through rural governance reform, infrastructure and housing construction, industrial development, and urban-rural integration. Designated rural regions or groups receive sufficient political support and resources, whereas the less favoured areas or the marginalised groups are left behind. This situation results in the unstable expectation of rural life. Later, the improvement of social welfare in the rural areas accompanied by the decline of urban employment during the economic transformation gradually decreases the rural-urban migration (He 2014). The tendency of young adults to stay in villages increases rural human capital. Given this issue, life in the countryside should provide Chinese ruralites with increased choices on the means and direction of development, guaranteed rights, and increased capacity and confidence to grasp local development, which is, living sustainably in rural areas.

The constitutions of well-being can demonstrate the need to improve sustainable life in rural China, stabilise governance, and achieve balanced development. In contrast to the hard and disrespectful life in cities, when the physical living condition, infrastructure, and social welfare in the countryside are gradually improved, rural residents begin to aware of and pursue a decent life (He 2014). Decent living is achieved when the rights of rural residents are realised. Such realisation empowers them and also provides them with freedom, accessibility, and appreciation. Rural China must improve its endogenous life, respect diverse livelihood, and protect nature in response to the modernist development model and the top-down governance approach. The advocacy towards endogenous development in Europe (Woods 2011) emerges for rural China. However, Woods (2011) also states the three significant limitations of endogenous development model: first, the model is inefficient in foundational or structural disadvantaged areas where must be urgently improved; second, rural middle-class residents gain more benefits than the poor and vulnerable; last, this model strengthens rural elites and professionals and creates exclusion, internal inequalities, and oppressions (Shortall 2008, Árnason et al., 2009, Shucksmith 2000). Thus, promoting endogenous development in rural China needs critical contextualisation and adjustment. Also, updated knowledge and modern techniques must be made available to people and easy to be inherited locally. High-science low-tech rural architecture, which led by Edward Ng (Wan et al., 2011) and Hsieh Ying-Chun (2015), and public science services such as that provided by Public Lab (2016), are examples of researches and innovations cater to people.

Lastly, rural development must be universally beneficial. SDGs emphasise fair and universal development, suggesting that the priorities of different groups should be addressed in a fair, timely, and continuous manner. The term universally beneficial means provision of benefits to different groups in the same developing process according to each specific need, while the results may differ that not all should meet a unified standard. Living sustainably for Chinese peasantry refers to decent living where one can endogenously live with open-source and universally beneficial development.

4. RURAL ARCHITECTURAL PRACTICE IN CHINA

In China, the rural architectural practice has gradually arisen since the early 2000s due to the political and economic changes that aim to bridge the significant rural–urban disparity. Since 2005, the implementation of the New Socialist Countryside resulted in various cases of entire village relocation, large-scale residential demolition, and evictions. Thus, the official initiative of traditional village preservation established in 2012 and the Beautiful Countryside Construction movement enacted in 2013 advocated the conservation of rural locality and nostalgia. These actions encourage growing rural architectural practice by the third sector (Zhou 2016). Also, the saturated market of urban construction that proliferated because of rapid urbanisation but declined after 2013 (Hewitt 2016) impels architects to target rural regions. The permeation of market economy also results in the widespread rural construction. The rural symbols and meanings that satisfying rural consumers but detaching from rural residents and referent (Cloke 2006) emerge during the modernist and market-oriented Chinese rural development. Certain rural areas with pleasant climate or environment face excessive commercial development. The new middle-class rural residents prefer building multi-storey houses with industrial materials as a display of affluence or a sop to urbanite. This feature also causes the marginalisation or elimination of remote, less favoured, or common villages. Rural architecture is currently one of the most crucial domains when intervening rural development in China.

The widespread and rapid growth of rural architectural practice focuses more on short-term results than on systematic development planning and long-term benefits. The obliterated conventional livelihood and lifestyles must be re-built through community engagement and organisation in new villages (Liu et al., 2015). However, this process is difficult because re-establishment entails substantial resources and significant time, and to adapt to new conditions and neighbourhoods usually fails. Foci of the government and the public on the inefficient use of new cottages remain inadequate. Various factors cause the vacancies and idleness of new village residences, including oversized or inconvenient indoor or outdoor space (Liu et al., 2015), the low comfort level of built environment, and improper land planning that are primarily attributed to urban bias or unconformity of rural life. A systematic strategy of rural construction in China based on investigation and experience of crucial projects was first proposed by China **Architecture Design Group (2016) on a public forum under the theme of 'Remember the Nostalgia' by Architect Su Tong**. Su firstly summarised the current problems related to rural construction in China as follows:

- Economic backwardness
- Social disintegration
- Ecological degradation
- Loss of identity and locality
- Fail to reach consensus between rural community, local government, and architect
- Convergence of business model (mainly refers to tourism and related services)
- Inadequate transmission of vernacular knowledge and tectonics

Similar to the findings of many current rural architectural projects, Su pointed out that the same externally supported architectural projects are inapplicable in all the areas in rural China. This finding means that bias may exist and project sites must be carefully examined and selected at an early stage. Su emphasised the market-oriented development supported by the external capital and based on the negotiations coordinated by local government, and stated the five stages under this rural construction strategy as follows:

- Intensive and professional investigation
- Identity clarification and planning initiation
- Localisation of development and spatial planning by targeting specific conditions
- Integration of multi-level and multi-element planning for operationalisation

- Space categorisation and design in line with three types of functions, namely, ordinary buildings, demonstrating and gathering buildings, and semiotic buildings and rural landscapes

The rural construction strategy proposed by Architect Su methodologically represents most perceptions on current rural construction in China and the future development, most of which are based on actual projects and other domestic experiences. However, challenges can be established through the lens of living sustainably in rural areas, which is discussed before. The rural construction strategy of Su is highly biased towards a top-down approach under which typical predicaments in land tenure or rural governance are easily compromised or avoided. This rural construction strategy lacks architectural innovations to sustain rural cultures and ecosystems. This strategy also implies urban bias to some extent in selecting sites, planning, designing space, and proposing development. Participation of rural residents is concerned in this strategy but inclines to requests local governments to persuade residents to accept plans and designs by architectural teams composed of outsiders. This process fails to enhance professionalisation of construction of the villagers or promote collective labour for bonding community.

More generally, most current architectural practice in rural China fails to consider the multi-dimensional aspects of sustainability. Most practice acknowledges the values of vernacular tectonics and traditional knowledge but barely contribute directly to the inheritance of vernacular architecture by local generations. Simplifying problem-oriented methods produces a common construction style and similar features in different rural areas and results in the loss of vernacular knowledge and techniques. The knowledge exchange and local education during the architectural practice are scarcely noticed. Mature planning strategies and climate change preparedness at a bottom level are not systematically provided. The locals usually cannot sustain the contributions of architectural practice on social and environmental dimensions. And the economic functions of new-built space serve less except rural tourism and concomitant services. In terms of professionalisation, weaknesses indicated currently primarily relates to the inadequate capacity to plan and design sustainable built environment. Interdisciplinary cooperation and study of instruments for assessing, maintaining, managing, and operating rural built environment has been seldom conducted. From another angle, all these limitations also inspire the alternative approaches.

5. **ALTERNATIVE FOR CHINA'S RURAL ARCHITECTURAL PRACTICE TOWARDS LIVING SUSTAINABLY**

General strategies proposed for the identified issues in rural China construction are developed below. A well grasp of a rural space depends on deep experiencing the local through lenses of materiality, representation, and imagination. Based on a proper understanding of the local, innovation and practice in rural architectural will enhance the spirit of place, reduce urban bias, and modify capitalist or materialist orientation. Sustainable architectural practice in rural must gradually apply bottom-up approach. Investigations and engagements should figure out the situations and working patterns of local institutions, capital, and ecosystem services and then scrutinise possible opportunities to change local mind and build cooperation during designing and constructing. This approach should allow the locals to express their opinions and respectfully provide them low-cost but sustainable choices according to their ability and resources when they encounter problems in sustaining decent life. A local consensus of ecological conservation is crucial, though difficult to establish, based on which architectural tectonics obtain evolution sustainably. Attempts of adopting a systems level on the local and regional social-economic changes help to identify local priorities and adjust architectural approaches. Allowing rural residents to dominate architectural practice is possible, which requires learning from the locals and subsequently encouraging them to learn. Architecturally targeting sustainable well-being should particularly enable the left-behind rural groups or regions to improve their way of living and shape particular sense of place and belonging endogenously. A framework of local architectural practice pattern is proposed by contextualising sustainable living in rural China, which is described below:

- Context specification: Establishing the concept or idea of design for the local by spatially and temporally reflecting on the past, grasping its potential of development and enhancing foresight;
- Functionally sustainable: Planning and designing space while appreciating locality, showing accountability of increasing engagement and developing potentials;
- Procedurally sustainable: Improving local human capital, maximising usage of local resources, exchanging or generating knowledge, and transmitting culture and value while planning, designing and building;

- Materially sustainable: Choosing materials that showcase identity and care for habitat, challenging consumerism, and exploring more ways of reusing or recreating;
- Managerially sustainable: Operating projects cost-effectively, advancing social connections and community participation, and catalysing governance breakthroughs.

6. CONCLUSION

Dynamic changes occur in rural areas in China because of decades of rapid industrialisation and urbanisation. A proper perception of Chinese rurality provides architectural facilitators practical directions to grasp local contexts and establish understandings. Learning rural institutions, capital, and ecosystem services in a certain place will promote the engagement with local networks and establish proper bottom-up approach as a response. To help rural residents perceive well-being ensures that rural architectural activities concentrate on enhancing the capacity and providing access for the locals to lead and maintain a sustainable life. A methodological discussion establishes an alternative framework for the rural architectural practice pattern in China that specifies context and considers functional, procedural, material, and managerial sustainability. More theoretical supports and empirical strategies should add to improve this architectural practice pattern further.

REFERENCES

- [1] ÁRNASON, A., SHUCKSMITH, M. and VERGUNST, J.L., 2009. Comparing rural development: Continuity and change in the countryside of Western Europe. Ashgate Publishing, Ltd.
- [2] BOSWORTH, G. and SOMERVILLE, P., 2013. Interpreting rurality: multidisciplinary approaches. Routledge.
- [3] BRYANT, L. and PINI, B., 2010. Gender and rurality. Routledge.
- [4] CHINA ARCHITECTURE DESIGN GROUP, 26 Sept. 2016. Remember the Nostalgia (exhibition and forum). Beijing, China.
- [5] CLOKE, P., 2006. Conceptualizing rurality. In: P. CLOKE, T. MARSDEN and P. MOONEY, (eds.) Handbook of rural studies. London: Sage, pp. 18-28.
- [6] CLOKE, P. and GOODWIN, M., 1992. Conceptualizing countryside change: from post-Fordism to rural structured coherence. Transactions of the Institute of British Geographers, 17(3), pp. 321-336.
- [7] CLOKE, P.J., 2003. Country visions. Harlow: Harlow: Pearson/Prentice Hall.
- [8] ELLIS, F., 2000. Rural livelihoods and diversity in developing countries. Oxford university press.
- [9] FEI, X., HAMILTON, G. and WANG, Z. (1992). From the soil, the foundations of Chinese society. 1st ed. Berkeley: University of California Press.
- [10] FRIEDMANN, H. and MCMICHAEL, P., 1989. Agriculture and the state system: The rise and decline of national agricultures, 1870 to the present. Sociologia ruralis, 29(2), pp. 93-117.
- [11] HALFACREE, K., 2006. Rural space: constructing a three-fold architecture. In: P. CLOKE, T. MARSDEN and P. MOONEY, (eds.) Handbook of rural studies. London: Sage, pp. 44-62.
- [12] HARVEY, D. (1996). Justice, nature, and the geography of difference. 1st ed. Cambridge, Mass.: Blackwell Publishers, p.322.
- [13] HE, X.F., 2013. Rural china in the 21 century. Revised edition, Beijing: Peking University Press.
- [14] HE, X.F., 2014. **China's way of urbanisation. Beijing: People's Oriental Publishing & Media.**
- [15] HEWITT, D. 2016. **China's Real Estate Conundrum: Boom And Bust. [online] International Business Times.** Available at: <http://www.ibtimes.com/chinas-real-estate-conundrum-big-property-bubble-vs-ghost-towns-2354090> [Accessed 29 Sep. 2016].
- [16] HSIEH, Y., ZHANG, J. and YANG, Y., Yue, 2015. Return the rights of architecture to people. Architecture Technique, (8), pp. 82-90.
- [17] JACQUES, P., 2014. Sustainability: the basics. Routledge.
- [18] JAHAN, S., 2015. Human Development Report 2015: Work for human development. Washington DC, USA: Communications Development Incorporated.
- [19] VILLAGE DIARY. (2013). [film] China: Jiao Bo.
- [20] LIU, Y., DU, L.H., WANG, C. and JIANG, W.H., 2015. Analysis of Factors of New Rural Community Farmers' Residential Eco-satisfaction Based on Structural Equation Model--A Case of Dazhu New Village, the Entire-village Advancement Demonstration Village in Chongqing. Journal of Southwest China Normal University (Natural Science Edition), 40(7), pp. 151-157.

- [21] MALIK, K., 2014. Human Development Report 2014: Sustaining Human Progress: Reducing Vulnerabilities and Building Resilience. Washington DC, USA: Communications Development Incorporated.
- [22] MCMICHAEL, P., 1996. Globalization: Myths and Realities¹. *Rural Sociology*, 61(1), pp. 25-55.
- MILLENNIUM ECOSYSTEM ASSESSMENT, 2005. *Ecosystems and Human Well-being: Synthesis*. Washington, DC: Island Press.
- [23] Public Lab, 2016. Public Lab: a DIY environmental science community. [online] Publiclab.org. Available at: <https://publiclab.org/> [Accessed 30 Sep. 2016].
- [24] REDCLIFT, M., GOODMAN, D. and REDCLIFT, M., 1991. *Refashioning Nature: Food, Ecology and Culture*. Taylor & Francis.
- [25] RIBEIRO, M. and MARQUES, C., 2002. Rural tourism and the development of less favoured areas—between rhetoric and practice. *International Journal of Tourism Research*, 4(3), pp. 211-220.
- [26] SHORTALL, S., 2008. Are rural development programmes socially inclusive? Social inclusion, civic engagement, participation, and social capital: Exploring the differences. *Journal of Rural Studies*, 24(4), pp. 450-457.
- [27] SHUCKSMITH, M., 2000. Endogenous development, social capital and social inclusion: Perspectives from LEADER in the UK. *Sociologia ruralis*, 40(2), pp. 208-218.
- [28] UNITED NATIONS, 2016. Year of Living Sustainably - United Nations Sustainable Development. [online] United Nations Sustainable Development. Available at: <http://www.un.org/sustainabledevelopment/yols/> [Accessed 7 Jan. 2016].
- [29] VAN ASSCHE, K. and HORNIDGE, A., 2015. *Rural development: knowledge and expertise in governance*. 1st edition, Wageningen: Wageningen Academic Publishers.
- [30] VOS, W. and MEEKES, H., 1999. Trends in European cultural landscape development: perspectives for a sustainable future. *Landscape and Urban Planning*, 46(1), pp. 3-14.
- [31] WAN, L., NG, E., MU, J. and SHI, W., 2011. Mohurd No. 1 Site: Post-Earthquake Village Reconstruction and Demonstration Project in Ma'anqiao Village. *Eco-city and Green Building*, (2), pp. 58-62.
- [32] WOODS, M., 2011. *Rural*. Milton Park, Abingdon, Oxon; New York: Routledge.
- [33] YOUNG, O.R., 2013. Sugaring off: enduring insights from long-term research on environmental governance. *International Environmental Agreements: Politics, Law and Economics*, 13(1), pp. 87-105.
- [34] ZHOU, X.Y., (ed.). TPB experts gathered in September, seminars and Towns "Nostalgia" - Top News. [online] Top-news. Available at: <http://www.top-news.top/news-12358662.html> [Accessed 29 Sep. 2016].

Retrofit or Behaviour Change? Which Has the Greater Impact on Energy Consumption in Low Income Households?

Melissa JAMES^a, Michael AMBROSE^b

^a CSIRO, Australia, melissa.james@csiro.au

^b CSIRO, Australia, michael.ambrose@csiro.au

This paper was presented at SBE16 Sydney Regional Conference. Please view the full paper [here](#).

Towards a Holistic Methodology: A Practical Approach to Local Energy Planning

Thomas SCHLUCK^a, Matthias SULZER^b

^a Hochschule Luzern, Switzerland, thomas.schluck@hslu.ch

^b Hochschule Luzern, Switzerland, matthias.sulzer@hslu.ch

ABSTRACT

Within the energy strategy 2050 the Swiss Confederation decided upon the nuclear fade-out and the reduction of CO₂-emissions. The hereof derived ambitious sub-goals are to consecutively increase the share of renewable energy sources, improve energy efficiencies, enhance the domestically added value and finally reduce the dependency on foreign supplying countries.

The realization of these goals and the final implementation of this self-decreed policy drop down on local stakeholders and especially the local communities. They often understand the need for action, but have neither a sufficient knowledge in this field nor the set of skills to oversee, let alone develop a local energy plan by themselves.

To cope with the different aspects during the planning process and to empower communities, local stakeholders and local planners, a modular and thus adaptive method is in ongoing development.

Here we present the core module for local energy planning and the module for monitoring and assessment of the planning process. Both modules were developed in cooperation with a local energy utility and a local community based on state-of-the-art systems engineering and systems thinking principles.

As the target audience was chosen to be diverse in knowledge, resources and skill-sets the modules were designed to be as coherent and adaptable as possible. The local energy planning for instance allows for both: a hands-on planning approach as well as the integration of sophisticated optimization approaches (Like the energy-hub concept or similar).

Further planned modules comprise stakeholder engagement / collective learning, business modelling (ongoing) and information quality assessment.

Keywords: community empowerment, design process, transit-oriented development

1. BACKGROUND

In 2007 the Swiss government decided to base its energy policy on four strategic areas: efficiency, renewable energy sources, replacement and rebuilding of large power stations and its foreign energy and trading policy. In 2011, under the impression of the Fukushima disaster, the nuclear fade-out was decided and the focus was strongly set on the efficient use of energy and the dissemination of renewable energy sources (BFE-website, 2016). Besides all efforts on the federal level, it still is ambiguous how to reach these ambitious goals. Many measures to effectively achieve these goals must be realized at the local level and involve local stakeholders. Especially the development of a holistic energy plan is normally an overwhelming task for a community as it needs the coverage of a wide range of topics and expertise in conjunction with a systemic approach. However, the idea of resorting to a national wide decreed infliction of general measures on the communities will very probably not be an effective solution. Communities are too diverse and face different challenges, pursue different goals and find themselves in individually unique situations with distinct stakeholder constellations and thus interest. A federal infliction, which takes all these aspects into account, firstly would certainly render infeasible **and secondly would be perceived as a massive political interference with the communities' sovereignties.**

Today the Swiss government's main approach is to raise awareness, to support and bundle existing effective measures, to fund research and to drive the dissemination of new and existing measures. Due to the complexity and interdisciplinarity of these tasks comprehensive research networks, like the SCCER FEED&D, were established that pool academic competencies and establish a strong link to industry and economy. But the key question is still to be answered: How to empower local communities, their stakeholders, and especially

local energy planner to find locally feasible solutions and help to reach the national superordinate goals in the long term? A first step to address this question was taken by developing a flexible method, which will be described in detail in chapter 2.

1.1 Related work

In 1994 the EBC – Annex 22 (Jank et al., 1994) addressed the question how to develop economic and ecological energy concepts for communities and larger regions. Annex 22 collected knowledge from different countries and looked at different available tools, models, public acceptance and proposed planning processes which were **summarized among the term “Local Energy Planning” (LEP). The follow-up Annex 33 (Jank et al., 2000) then picked up on its predecessor’s proposal of a more holistic approach to LEP, which resulted in the “Advanced Local Energy Planning” (ALEP) method. At its core ALEP is based on comprehensive computer modeling of the communities’ whole energy systems, but also allows for the optimization of subsystems. Due to its descriptive and general generic approach in necessary combination with a sophisticated computer tool local administration, stakeholders and planners cannot directly apply these findings, but must still develop their own approaches. Finally, the aspect of stakeholder analysis and involvement and the difference in overall strategic and operative LEP was addressed in the subsequent and last Annex 51 (Jank et al., 2013). These research programs represent about two decades of dedicated work on Energy Planning and are not only a valuable resource of knowledge, but in its entirety a testimony how the field of Energy Planning developed into a more and more complex and systemic field of research.**

Handling complexity and making at least the conceptual design more manageable is the dedicated goal of recent projects. Some projects like TABULA focus on the definition of energetic building archetypes in a country, which allows for an easy mapping of the energy demand of entire areas (TABULA website, 2016) (Loga et al., 2015). Other projects like the UrbanReNet (Hegger et al., 2012) work on comprehensive model kits that use archetypes in combination with sophisticated optimization approaches to find a representation and solution for the demand and supply side.

All these projects share the common approach to make their methodology available in specially developed tools, which thereby become an integral part of the method itself. This progressing entanglement between methodologies and their tools make them more and more indistinguishable.

1.2 Underlying criteria to the developed method

The given premise to this work was to provide practitioners with a methodology to develop energy concepts for their community and region and monitor the process in the run. The method should consider principles (see (Winzer, 2013)) and latest findings in systems thinking, systems engineering and research on method development (Haberfellner, 2012) (Winzer, 2013). In accordance to these principles the method aims to provide a conceptual model that acts as a frame and guidance to the developmental process.

The method should be versatile, i.e. applicable on different communities and adaptable in technicality. The planning group should be able to decide whether to use sophisticated modeling and simulation approaches or a rather hands-on approach using more familiar engineering tools and techniques.

To cope with the varieties of individual tasks and to take into account that holistic approaches vary from system to system the method is sought to be modular in design. Different topics should be treated in separate methodological modules that can be subjoined as is considered necessary.

2. A METHOD FOR LOCAL ENERGY PLANNING

2.1 The module for energy planning

Here we will present the core module of the method for local energy planning and the module for the assessment of the planning process. Initially these modules were developed for a joint project between a local Swiss community, the SCCER FEEB&D and a energy utility to develop a holistic energy concept that will accomplish the given national goals until 2050 (Kellenberger et al., 2012).

An overview of the core module, i.e. the energy planning module is given in figure 1.

It is organized in seven layers and each layer comprises between one to four subunits. The module starts with an understanding of the initial situation and ends with the final recommendation for an energy concept. The depiction in figure 1 is held in similarity to a classical cascade approach to help the planning groups map and visualize their overall progress, but also to provide guidance through the process. Iterations and feedback between layers are accepted and actually considered as a crucial part of the method.

The method's main target groups are planning engineers, architects, community staff members and the like. To keep the method flexible and adaptable and to provide the using groups with a proper framework in which they can orient but also find enough freedom to develop their ideas, the method was designed to be prescriptive in its general design and descriptive in its subunits. The above also implies that the method keeps its neutrality, i.e. must separate its design from any utilized tools.

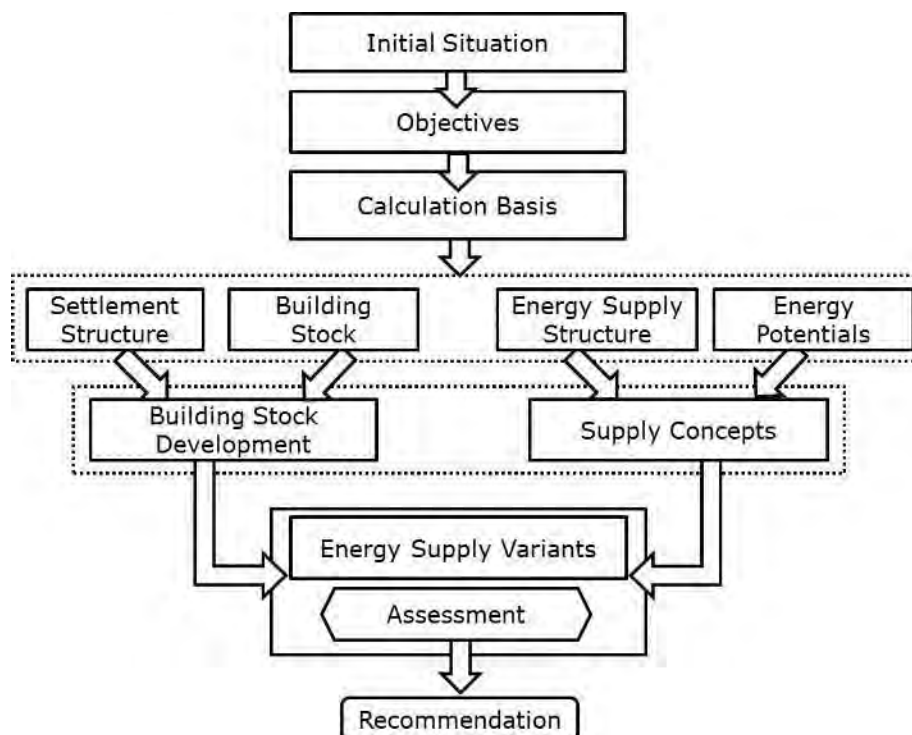

Figure 97: Concise representation of the methods core module for energy planning.

2.2 Layers and subunits

Here we will shortly present the different layers and subunits. A more detailed overview can be found in (Schluck, 2016).

Initial Situation: In this layer and subunit the community's situation is examined in regard to existing visions, goals and developmental plans but also in regard to the possibly different interests and the stakeholders in the community. **All involved stakeholders agreed upon the considered system's boundaries, especially in terms of geography, the forecasting horizon and the balancing boundaries.** Finally, the structure of the planning group and their ways of communication are defined.

Objectives: Based on the insights from the previous layer a system of objectives is established which comprises a definition of the goal, measurable indicators for the fulfillment of the goal and the method how the indicator is measured. This approach corresponds to (Jank, 1994). If too few is known about the community and a final definition of objectives seems not to be feasible yet, preliminary objectives must be set. The method is then advanced until layer four – **the analysis of the community's current situation. After the analysis the method comes back to this layer.**

Calculation Basis: The procurement of information is one of the fundamental issues in any form of planning. In energy planning information quality varies strongly such that deductions drawn from it may be more or less conclusive and must be interpreted with some wariness. Thus this layer and subunit was explicitly introduced to stress this point and to deeply embed information quality assessment and quality gap analysis in the method. In addition all assumptions made and all tools planned to be used must be listed at this point. All these measures help later on to clarify on what bases the final recommendation was elaborated.

Analysis: This layer consists of four subunits, which do not have to be worked on in any particular order.

Analysis – Settlement Structure: In this subunit the settlement's topology is examined. Is it a rural or urban structure? What kind of areas – like residential, industrial or business – can be found? Does a centre exist? These and similar questions are addressed.

Analysis – Building Stock: Here the building stock is analyzed in detail. Parameters like the energy reference area, the building building period, renovation period, usage, and energy demand are determined.

Analysis – Energy Supply Structure: In this unit the existing energy infrastructure is examined. What kind of infrastructure is already present and will be influential in the further planning process? For instance, if district heating is an option the location of the sewage channels must be taken into account. What temperature levels must be obtained for room heating and domestic hot water? What capacities of the electrical grid are still unused and available for further installations? And so forth...

Analysis – Energy Potentials: This subunit encompasses the analysis of local energy potentials like wind, solar gains, geothermal usage, ground-, sea-, waste- or lake-water usage, waste heat or the like.

Synthesis I: This layer combines the information from the units “Settlement Structure” with “Building Stock” and “Energy Supply Structure” with “Energy Potentials” to develop forecasting scenarios. The main objective of this layer is to define the solution space.

Synthesis I – Building Stock Development: The findings in the previous units “Settlement Structure” and “Building Stock” are combined with available statistics to forecast the community's development for the given time frame.

Synthesis I – Supply Concepts: The results from the units “Energy Supply Structure” and “Energy Potentials” are merged together to determine all possible energy supply solutions.

Synthesis II – Energy Supply Variants and Assessment: In this forecast layer the optimal solution within the solution space is determined.

Recommendations: The planning group presents a collection of solutions it sees fit.

2.3 The module for planning assessment

Key-performance indicators (KPIs) are best known from quantitative economics, but they also found their way into the field of sustainability (Epstein et al., 2001) (Ugwu et al., 2007). KPIs are ordinarily developed to obtain some kind of metrics for either measuring the overall success or the influence and sensitivity of a taken action. Thus they **are often divided into “operational” and “strategic” KPIs. Normally any method based on a systemic approach** demands for measurable and specific objectives and thus implicitly demands a set of strategic KPIs. The same is true for the previous presented energy planning method. So the question obtrudes why to dedicate a separate module to the assessment via KPIs.

The definition of operational KPIs is not part of the core module, while the definition of strategic KPIs can overlap with the objectives defined in layer two. By transferring the definition of KPIs into a distinct module process management and the substantive work are kept separated and thus clearer. Thereby each unit in the energy planning method can be assessed.

Two approaches can be taken to develop KPIs. On the one hand all available data can be collected and archived and subsequently an explorative analysis of the data on sensitive parameters is performed. This means that the analyst looks at the process in retrospect and must thoroughly handle a vast amount of diverse data. When

methodologically supporting local stakeholders to develop an energy concept for their community this approach is infeasible as the concept would have to exist already. This is why this module develops KPIs based on key-performance-questions (KPQs) (Marr, 2015). For each subunit (besides “Initial Situation” and “Recommendation”) a KPQ is broadly formulated but in relevance to quantification of the subunit’s goal. This approach creates the necessity to rethink each step before any substantial work is done and can help to eliminate uncertainties. Figure 2 shows an example how KPIs for one subunit are obtained. Thus the interface between the core module and the module for planning assessment are the key-performance-questions. At present the module only loosely sums up all derived KPIs, which then must be controlled separately and independently. However in a next step extending the module to a performance management system (PMS) (Rodriguez et al., 2009) with inherent KPI management, advanced assessment and interconnection is aspired.

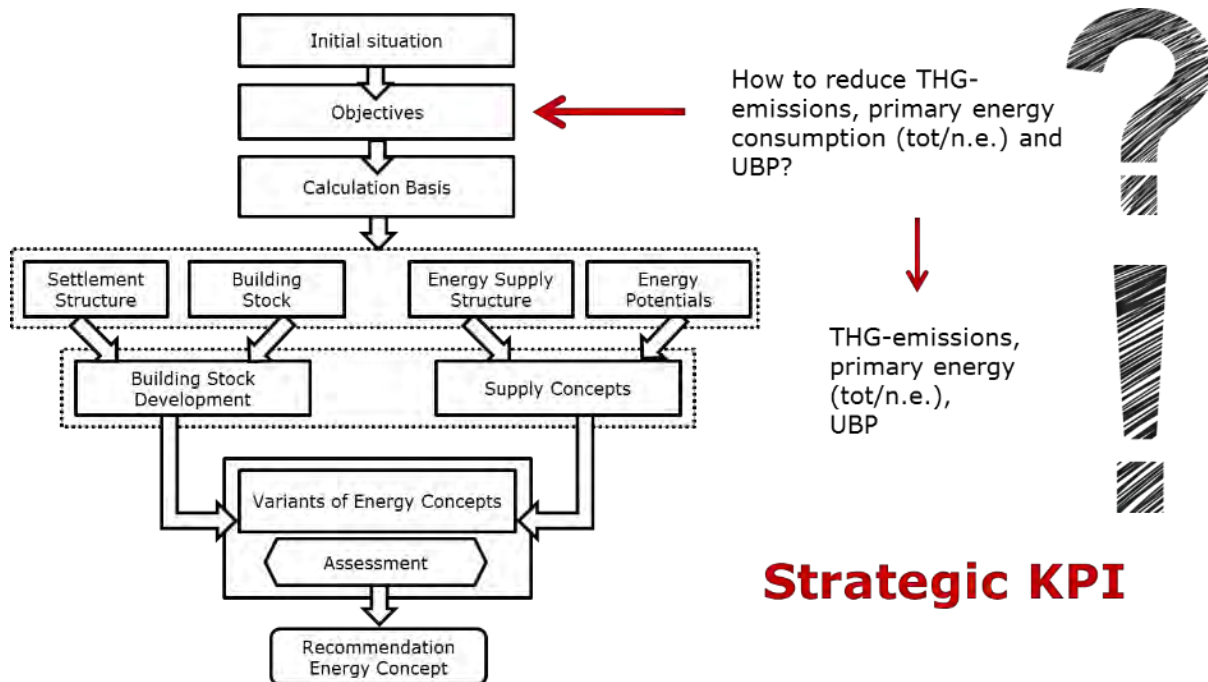

Figure 98: Exemplary KPI development for the “Objectives” subunit. Key-performance-questions are the interface between the module for planning assessment and the core module. (UBP: Measure of the Swiss Ecological Scarcity Method)

3. DISCUSSION

Twenty years ago local energy planning focussed on energy savings in production plans and it were raising opportunities of available optimization tools like MARKAL/ TIMES (MARKAL, 2016) that led to sophisticated methods capable to address the energy system in a more holistic fashion. Today hundreds of such tools are available (Connolly et al., 2010) and each of them needs knowledge and expertise, which is offered by academia. Realizing that this expertise did not disseminate as hoped for over the last years, research was emphasized on socio-economic aspects (Jank et al., 2013). Tools became more and more developed and designed with regard to practitioners and in a similar spirit the here presented method was developed. Although the method allows for a hands-on approach in energy planning it is compatible to modern optimization approaches like the Energy-Hub concept (Geidl, 2007) (Parisio et al., 2012) (Orehounig et al., 2015). Indeed such an approach is still recommended. An important aspect during the development of the method was to consider modern findings in generic systems engineering and help in handling complexity. This was one of the main reasons why a possibly strict separation between substantial and methodological work and between method itself and the used tools was sought. For the same reason different aspects are purposely addressed in its original module. However this methodological approach is still very young and although successfully tested on a project there will be changes and improvements made. For instance our experiences showed how important a sound understanding of information’s quality is. An assessment and an extended gap analysis – treated in a separate unit – could be considered. Another experience was that the economic calculations, which are now distributed over the different subunits, should also rather be condensed in one single unit.

The module for planning assessment also should be consolidated and developed into a full performance measurement system.

The modular methodological approach offers the clear benefit of adding and removing modules for each communities need as they see fit. Ideas for further modules are:

- A dedicated module for stakeholder analysis and involvement
- A module addressing mobility
- A module to incorporate life cycle analysis (LCA)

In this article recommendations on tools, useful visualizations, details in balancing, and information gathering were purposely excluded as they specifically address the circumstances in Switzerland. Information on these topics can be found in (Schluck, 2016).

4. CONCLUSION

A method for developing local and holistic energy concepts was presented in short. The method is modular in design and at its core stands the module for Energy Planning. A separate module was elaborated to accompany the planning process and develop operational as well as strategic key-performance-indicators using key-performance-questions. These also represent the interface to the core module.

When designing the method key findings of generic systems engineering were considered. Despite its novelty it had already proven successful in one large project. In a next step the method will be refined as already discussed in chapter 3.

A module for the development of business cases was not presented here, but partially exists and is in further active development.

ACKNOWLEDGMENTS

We would like to thank the Swiss Commission for Technology and Innovation (CTI) that partially funded this work within the research framework of the SCCER FEED&D.

REFERENCES

- [1] BFE website, 'Was ist die Energiestrategie 2050?', Bundesamt für Energie, Retrieved from: <http://www.bfe.admin.ch/energiestrategie2050/06445/index.html?lang=de#> [Retrieved on 25 September 2016]
- [2] Connolly, D., Lund, H., Mathiesen, B. and Leahy, M. (2010), 'A review of computer tools for analysing the integration of renewable energy into various energy systems', *Applied Energy* 87(4), 1059 – 1082.
- [3] Epstein, M. J. and Roy, M.-J. (2001), 'Sustainability in action: Identifying and measuring the key performance drivers', *Long Range Planning* 34(5), 585 – 604.
- [4] Geidl, M., Koeppl, G., Favre-Perrod, P., Klockl, B., Andersson, G. and Frohlich, K. (2007), 'Energy hubs for the future', *IEEE Power and Energy Magazine* 5(1), 24.
- [5] Haberfellner, R., 2012, *Systems Engineering: Grundlagen und Anwendung*, Orell Füssli, Zürich.
- [6] Hegger, M., Dettmar, J. and Martin, A. (2012), 'Urbanrenet – Vernetzte regenerative Energiekonzepte im Siedlungs- und Landschaftsraum', Technische Universität Darmstadt.
- [7] Jank, R., Johnsson, J., S. R.-N. (1994), 'Annex 22 – Energy efficient communities.', IEA-EBC Annex 22, final report.
- [8] Jank, R. & Steidle, T. (2000), 'Advanced Local Energy Planning (ALEP): A Guidebook', IEA-EBC Annex 33, final report.
- [9] Jank, R., Webster, J., Dütz, A., Bloch, T., Jank, L., Church, K., Kimman, J., Koch, A., Pol, O., Rosa, A., Strasser, H., Beier, C., Shimoda, Y., Erhorn-Kluttig, H., Zinko, H., Moshfegh, B., Broers, W., Eicker, U. and Pol, O., 2013, *Case Studies and Guidelines for Energy Efficient Communities*, Fraunhofer IRB Verlag, Karlsruhe.

- [10] Kellenberger, D., Ménard, M., Schneider, S., Hänger, M., Org, M., Victor, K. & Lenel, S. (2012), '**Arealentwicklung für die 2000-Watt-Gesellschaft. Leitfaden und Fallbeispiele.**', Bundesamt für Energie, Switzerland.
- [11] TABULA website, Retrieved from <http://episcopo.eu/building-typology/> [Retrieved on 25 September 2016].
- [12] Loga, T., Stein, B., Diefenbach, N. and Born, R. (2015), '**Deutsche Wohngebäudetypologie – beispielhafte Massnahmen zur Verbesserung der Energieeffizienz von typischen Wohngebäuden**', Institut Wohnen und Umwelt, final report
- [13] MARKAL and TIMES website Retrieved from: <http://www.iea-etsap.org/web/Markal.asp> [Retrieved on 02 September 2016].
- [14] Marr, B., 2015, Key Performance Indicators For Dummies, Wiley Verlag, Chichester.
- [15] Orehounig, K., Evins, R. and Dorer, V. (2015), '**Integration of decentralized energy systems in neighbourhoods using the energy hub approach**', *Applied Energy* 154, 277 – 289.
- [16] Parisio, A., Vecchio, C. D. and Vaccaro, A. (2012), '**A robust optimization approach to energy hub management**', *International Journal of Electrical Power & Energy Systems* 42(1), 98 – 104.
- [17] Rodriguez, R. R., Saiz, J. J. A. and Bas, A. O. (2009), '**Quantitative relationships between key performance indicators for supporting decision-making processes**', *Computers in Industry* 60(2), 104 – 113.
- [18] SCCER FEEB&D website, Retrieved from: <http://www.sccer-feebe.ch/> [Retrieved on 02 September 2016].
- [19] Schluck, T., 2016, Methoden zur Erstellung angewandter, regionaler Energiekonzepte – Üttligen ein Praxisbeispiel, Thesis (MAS), Hochschule Luzern.
- [20] Ugwu, O. and Haupt, T. (2007), '**Key Performance Indicators and Assessment Methods for Infrastructure Sustainability – A South African Construction Industry Perspective**', *Building and Environment* 42(2), 665 – 680.
- [21] Winzer, P., 2013, Generic Systems Engineering: Ein methodischer Ansatz zur Komplexitätsbewältigung, Springer-Verlag, Zürich.

Session 4.13: Community Empowerment (2)

'Pride the Civilians Motivator for Resilient Sustainable Cities' Results of the 2016 Questionnaire Research Under Dutch Amsterdam Council Members

Fred SANDERS^a

^a Delft University of Technology in the Netherlands, The Netherlands, f.c.sanders@tudelft.nl

ABSTRACT

Dutch practice shows that cities will only become UNFCCC 2016 Paris Agreement sustainable proof when civilians besides government are willing to take responsibility for these cities too. Motivation feelings and neighbourhood conditions seem the key success factors. Many of these factors and conditions have become clear in recent years. **Feelings of 'Pride' though is very often called as the motivation factor of importance although less is known of this phenomenon. To make the role of 'pride feelings' more clear exploring research on feelings of 'Pride' is done in the Dutch city of Amsterdam recently.** Therefore the 100 council members of the Amsterdam city and its 7 city areas are questioned on their vision on pride as the motivation factor of civilian initiative and responsibility. Besides there were asked to give best practices examples actual in Amsterdam. The analysis of literature search show that **'pride feeling' knows the four stages: proportional pride, shared pride, self-esteem and shared identity.** The case-study analysis shows based on homogeneous outcome unless the small sample of data, that civilian initiatives are seen as important (74%) for city development and that **'pride feeling' of importance for the success of civilian initiative is (72,5%). Besides the analysis shows that 'shared pride' is the most common stage for civilian initiative.** Recommended is that civilian initiatives should be **more inventoried whereby 'pride feeling' can be deeper examined being the important motivator for the participants and factor for success.**

Keywords: pride-feeling, civilian-initiative, sustainable-cities

1. PRIDE THE DIFFUSE CIVILIAN INITIATIVE MOTIVATOR

Pride is the diffuse motivator for civilian initiative. Knowing more about this motivation factor will help to understand civilian initiatives better. Therefore in succession explanation is worked-out concerning: the role of civilian initiatives for resilient sustainable cities (1.1) and its motivation factors (1.2), the function of pride as motivation factor (1.3), the need and set-up of the additional 2016 research on the pride motivation factor done in the seven Amsterdam city areas included the research question (1.4).

1.1 Civilian initiative for resilient sustainable cities

Urbanization is increasing worldwide and in the Netherlands the Amsterdam city is in special growing too (UN, 2014). Recent forecasting predicts that Amsterdam will grow with 300.000 houses from 850.000 towards 1.500.000 inhabitants in the coming 25 years (municipality, 2015). This trend of urbanization growth is a trend of global magnitude including new cities on all continents. Dutch practice shows that cities will only become UNFCCC 2016 Paris Agreement sustainable proof when civilians besides government are willing to take responsibility for these cities too (Sanders, 2014). In the Netherlands stimulated by national government and its municipalities civilian initiatives has become though a growing phenomenon. Civilian initiatives show to be social and cooperative of nature, reasonably often into producing of renewable energy on the neighbourhood scale. It feels a realistic hypothesis that by increasing urbanization the existence of civilian initiatives and therewith civilian responsibility becomes more important to reduce the need for governmental control (Hajer, 2011). Civilians can make the difference bringing cities on a higher state of resilience. Recent developments proof that Dutch governmental organizations have become more successful by facilitating and stimulating civilian initiatives in recent years. For the civilians themselves these initiatives should be attractive enough for the group and each of the participating individuals. Motivation feelings and neighbourhood conditions are the key success factors. Many of these factors and conditions have **become clear in recent years. Feeling of 'Pride' though is very often called as the motivation factor of importance although less is known of this phenomenon (Sanders, 2014).** Insight on pride feelings therewith is necessary to understand civilian initiatives for building resilient city populations that have that social defensibility that they invest in sustainability of their city.

1.2 Civilian initiative and their municipalities

At the SBE16 Conference in Utrecht the Netherlands the 2015 research done with focus on civilian initiative in a number of Dutch IKS energy-neutral projects was presented (Sanders and Timmeren, 2016). It concerned the Dutch 2010 innovation program for speeding-up the transition of cities towards climate neutrality 2010 (IKS) (Ministerie-VROM, 2009). This program contained 20 projects at the start (IKS1) from which 8 projects ended-up in project realization (IKS2) being innovation project realistic enough for execution and 4 projects concerning neighbourhood coupled renewable-energy sustainability projects.

The 2013 evaluation of this IKS program (Boon et al., 2013) scanned all climate neutral activities in 55 of the 400 (2009) municipalities working on climate neutrality. The conclusion of this 2013 research was that municipality civil servants and civilians by acting together can make the difference between failure and success. To make the picture more clear these 4 IKS2 are given a closer research for this SBE16 Conference.

Based on my dissertation (Sanders, 2014), research concerning the relation forms of citizen initiatives with local governments (Tonkens, 2009) and governmental evaluation research on societal participation (WRR, 2012) a hierarchy for civilian participation is used as input for this research. This hierarchy showed the following three stages: thinking-along (a passive citizenship, civilians reflect and advice by accepting governmental initiatives), joining-in (a passive citizenship, civilians participate in and support government initiatives) and investing-in (an active citizenship, civilians take responsibility for initiatives dealing with government) all stages of exceeding civilian empowerment.

Analysis of these four IKS 2 projects in 2015 for the SBE16 Conference is done using these three stages of civilian participation. This diversity of stages helped to make the differences of civilian participation in the projects clear and made it possible to couple the renewable-energy results to these. The result is showed in Figure 1. The conclusion was that project dominated by local government the municipality and civilian initiative both can be **successful. Hybrid cooperation's of both are less successful.**

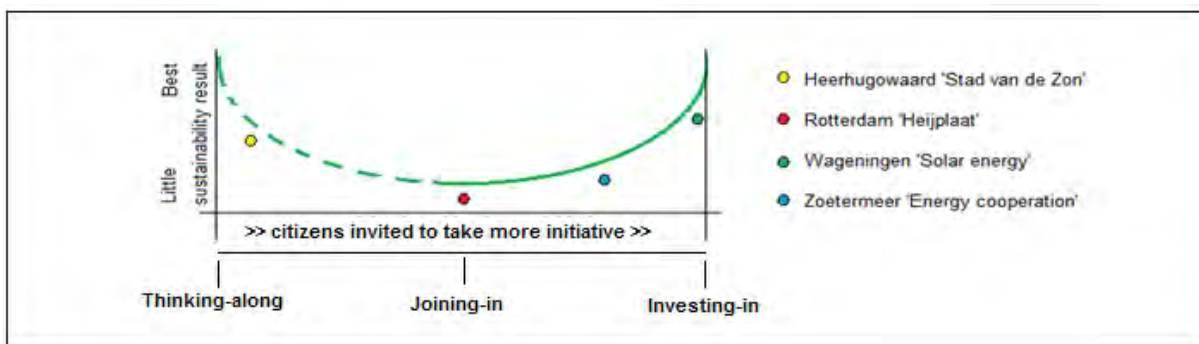

Figure 1: Square diagram of the 4 IKS2 sustainability neighbourhood project .

Remark 1: Unfortunately the sample of these 4 IKS2 innovation projects was little of number. However these **concern interesting Dutch examples of 'Climate neutral' innovations coupled to civilian initiative for the period** that such initiatives started-up at the beginning of this century. Therefore these projects are analyzed in 2015 on the moment that the evaluation report became available. The casestudy research is done by file-search, key-person interviewing with the **the above mentioned dissertation as the 'body of knowledge' for the research methodology,** analyzes and conclusion making.

Remark 2: The result of this research stresses that civilian sustainability initiatives are worthwhile to make succesful, in the IKS 2 selection they scored the best results.

1.3 Pride feeling literature search

Pride feelings show to be related to feelings of self-esteem (Cooper, 2003) and identity (Mercer, 2014). According to Cooper prideful activities give people self acceptance and sin giving factors founding feelings of self-esteem. pride can have positive benefits enhancing creativity, productivity and altruism according to Cooper too. Mercer found that people functioning in a group doing collective activities, by which they share culture, interaction, mutual

interests create themselves identity. He also found that such group emotion is more powerful than light coupled group activities. The lightest form of pride seems to be proportional pride, pride feelings of something, a son, a house, an ability (Davidson, 1976). This basic feeling of pride is there with a self-directed pleasant sensation (Taylor, 2012). These are the topics of numerous of research and publications on pride feeling though this selection concerns insights from recent data. Analysis of these forms of pride feeling shows a hierarchy although this is not given in the literature involved. Although the base for such an hierarchy is little, these can be used as a hypothesis for analyzing pride feeling in case situations, with reservation. This hypothesis is that the hierarchy of pride conceptions form a circle that suggests an accelerator for **people's group initiatives**, see Figure 2.

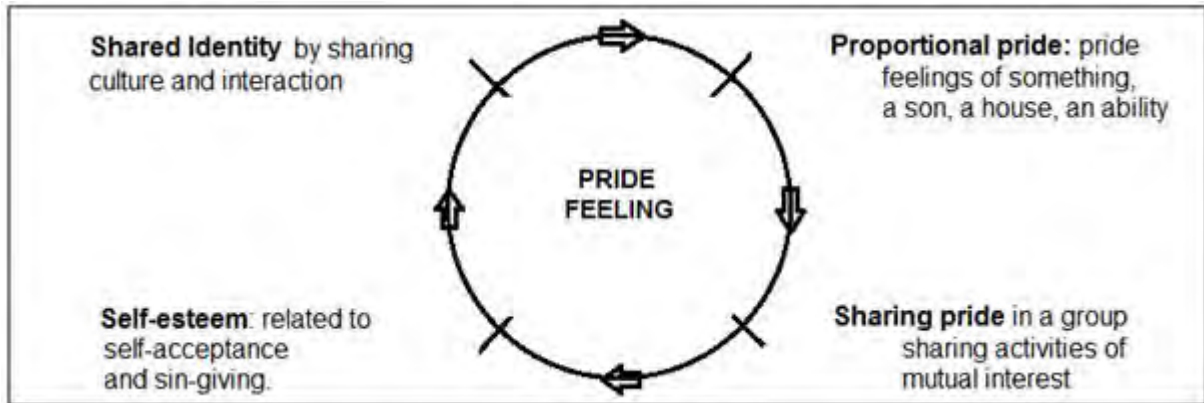

Figure 2: Pride feeling circle containing four stages and continuous stages.

Explanation: The first stage of pride feeling concerns proportional pride a personal group-loose feeling attached to things and persons and own achievements. Sharing pride the second stage develops when people share activities of mutual interest. Self-esteem the third stage is a pride feeling that people develop in reflection with others giving self-acceptance and sin-giving. The fourth stage of pride feeling develops when people share culture and interaction with group members become part of the group by which they share mutual feelings of pride. These stages are outlined in a circle with the reason that group feelings become part of personal pride afterwards with the effect that following the circle feelings of pride become stronger and stronger the longer a person deals with group related activities.

1.4 Pride feeling researched

To make the role of 'pride feelings' of civilian initiative more clear exploring research on feelings of 'Pride' is done in the Dutch city of Amsterdam. The research is done to make the function of 'pride feelings' as motivator among participant of civilian initiative more clearly, there were research from the past lacks this special focus.

The underlying research question for this research therewith is: 'How important and with what impact are feelings of pride for civilians initiatives of importance'.

Therefore additional to the literature search done with the results given in this chapter, the 100 council members of the Amsterdam city and its 7 city areas are questioned on their vision on pride as the motivation factor of civilian initiative and responsibility. The choice for questioning council members is grounded in the idea that these people know many civilians, that they know how they think and how they feel taking group initiatives.

Remark: The response was little and some council members reflected that they are too busy for even short questionnaires. In total 17 out of 99 council members reacted from which four gave a blank reaction by which 13 reactions remain, no 15% yet. Therewith the questionnaire gave no chance on a significant result. The answer at the other hand were homonymous. So the questionnaire results therewith gives a direction of the council members their opinion on civilian initiatives. Secondly they were asked to give best practices civilian initiative examples. The 11 suggestions given are used as case study material. For the results and analysis see chapter 2.

2. PRIDE FEELING IN AMSTERDAM CIVILIAN INITIATIVES

For the questionnaire research on pride feelings of civilian initiative among Amsterdam city area council members the elaboration is presented in this chapter: the questionnaire and results focusing on the importance of pride

feelings (2.1), the given best practices and analysis focusing the impact of proud feeling (1.2) and the general analysis (2.3).

2.1 Questionnaire on pride feeling and results

The questionnaire touched four questions scanning the existence of civilian initiative (the first question) in relation to the importance of pride feeling for the success of civilian initiative (the next three questions) concerning the city area for which the council member carries responsibility for. These four questions are:

- What is the density of civilian initiative in your city area, with the average of one initiative on a 1.000 residents as the reference, +/- 0-10-100%.
- How important are civilian initiatives for development of your city area in general, 0-10-100%.
- How important is pride feeling for the success of these civilian initiatives in your city area, 0-10-100%.
- How often are negative motivation stimulant (contra question) for civilian initiatives in the city area you are responsible for, 0-10-100%.

With the low percentage of reactions a sustainable conclusion cannot be the result. Though the reaction were so homogeneously (see appendix 1) that these are useful for the exploring attitude of this research answering the first **part of the research question 'How important are feelings of pride for civilians initiatives of importance'**. The results are.

Density Civilian Initiatives,

The city area council members show to have little impression of the density, the number of civilian initiatives, in their city area. In relation to the average density of one initiative on a 1.000 residents many could not give a deviation percentage (8 out of 17) and the other reactions differed enormous from -65% to +150% with estimations of -5%, -30%, -10%, -3%, +1%, +10% and +30% in between.

Importance of Civilian Initiative,

The city area council members were reasonably unanimous that civilian initiatives are an important stimulant for development of **their city area's a)**. **Their estimation showed an average of 74% importance on the scale of 0-100%** leaving the one deviation of 5% behind.

- a) Amsterdam counts 7 city areas with own town councils varying from 12 to 15 council members with an average of 120.000 inhabitants.

Importance of pride feeling for civilian initiatives (and contra question),

The city area council members their reactions reacted with an average of 72,5% leaving the two deviations 10% and 20% apart. This reasonably fits to the contra question asking the estimated percentage of initiatives in with negative motivation plays a role b) what gave an average result of 38,5%. What gives the result that the importance of pride feeling for civilian initiatives estimated by city area councilors lays around 67%.

- b) The two questions asking for the influence factors of proud feeling and negative motivations are not exact contrary questions though in the practice and vocabulary of citizens initiatives they can be seen as.

2.2 Amsterdam best practices on pride initiatives

Secondly these Amsterdam city area council members were asked to give best practices examples of proud feeling driven civilian initiatives in their city area. A number of 11 civilian initiatives were mentioned, from which 5 meeting of people oriented, 3 green activities producing food or plant zones, and 3 of other product.

The reason for this questioning is connecting and categorizing these best practices in perspective of the forms of civilian initiative presented in paragraph 1.2 and the four stages of proud feeling illustrated in paragraph 1.3. To discover how deep proud feeling in these best practices civilian initiatives is anchored, see paragraph 2.3.

These best practices civilian initiatives are:

1. Centrum, 'Canon van de Zeedijk' (Story of the Red Light Zeedijk)

Inhabitants from the 'Zeedijk' being the central oldest street in the red light district of Amsterdam, started an association being a neighbourhood network with pride feeling stimulating activities. The underlying reason is that many of the locals are negative about their neighbourhood because of the negative attitude of outsiders related to the prostitution activities in their streets. One of these activities is presenting the interesting neighbourhood past by a 'canon' a sequential line of historical pictures suggested and selected by the inhabitants. The idea is that this will change the inhabitants attitude to the neighbourhood and each other with the positive spin-off that they will be more willing to meet and do joint activities. Therewith it show to be a project of 'sharing pride' the second stage of the 'pride feeling circle'. See Figure 3.

2. New-West, 'Studiezalen'(Study Rooms)

A platform of students started a study room to help new and isolated students to great and meet each other on the level of the city area New-West. Their motivation was that many students newcomers in Amsterdam live to spread in the area and the degree of interaction is so little at the universities, that too many students suffer from loneliness. By starting study rooms in the area students should meet others that live nearby enough to stimulate more frequent contact and breaking open isolation. This initiative shows to be an example of the fourth stage 'sharing identity'.

3. New-West, 'Beer met kussen' (Bear with pillow)

Welfare organizations active in the 'Staalman's' neighbourhood asked the artist Florentijn Hofman to make a artwork with non-active youngsters 'loiterers' to create a meeting-place, stimulate place-attachment and proud feeling among them. The results was the creation of a statue representing a 'beer with a pillow'. The youngsters participating first rejected the idea. The final result is that the statue excite so much discussion concerning the choices for the place in the park and the figure of a beer, that not only the youngsters but also children, older people and local immigrants started the dialogue with each other. The artwork showed to be an instigation of meeting and talking among the neighbourhood residents. This project shows to be an example of the second stage 'sharing pride'. See Figure 3.

4. North, 'Noordoogst'(Northern harvest)

Neighbourhood resident started a city garden for ecological food production in a deserted piece of land near sport field accommodations. Fellow believers in the need for such homemade food were invited to join the project. Also local volunteers and entrepreneurs joined the initiative. The city area loaned the land for a starting period of ten years. Spinoff activities were theater festivals, a kindergarten and food producing workshops. This temporary project shows to be an example of the third stage 'self esteem' sharing sin-giving. See Figure 3.

5. North, 'Kadoelenweg 360' (Kadoelen street 360)

The initiative concerns homeless youngsters taking an empty office for temporary housing without permission, without permission of the owner and the city area council. Ten years after the toleration of this action the youngsters were set-out of the office for making the parcel free for new to built housing. The youngsters defended their temporary shelter and acted as a group although they weren't. The happening shows a situation similar to the first stage 'proportional pride'.

6. East, 'Fonds voor Oost' (Funding for East)

A committee of befriended civilians started a fund for neighbourhood activities of any kind with the goal that residents meet in activities, to learn and know each other better, to stimulate spinoff relations and activities. Locals are asked for crowdfunding and others can start projects with the financial result of this. The initiative seems an example of stage 2 'sharing pride'. See Figure 3.



Figure 3: Initiatives Zeedijk, Bear with pillow, Noordoogst and 'Fonds van Oost'.

7. West, 'Domela Nieuwenhuis Plantsoen' (Domela Nieuwenhuis Park)

In de spirit of Domela Nieuwenhuis (1846-1919) a socialist Amsterdam citizen in 1972 a park was applied in de 'Spaarndammer' neighbourhood. From the start this was an initiative of the neighbourhood residents. When the city area council in 2010 planned to built houses on part of the park these residents started an opposition movement against these plans because of the importance of this park for meeting an identity in their neighbourhood. The result is that the city area changed the plans in building outside the park in a way that the function of the park will become stronger. The situation gave an impulse to the group strength too. This initiative shows to be an example of the fourth stage 'sharing identity'.

8. West, 'Leefstraat' Hugo de Grootkade (Liveability street)

Liveability streets is an initiative of the city area council to give the Hugo de Grootkade one month at August 2016 free from traffic and parking cars to give the street inhabitants the freedom to organize new and personal neighbourhood activities. In fact the street inhabitants organized activities for children, created meeting places for all and started a street library with donated books open for each other. Target was that the residents make new meetings, learn to know and help each other in Dutch called 'mantelzorg' care giving. This month free street zone shows to be an example of the second stage 'sharing pride'. See picture 4.

9. Zuid, 'G250 Hallo de Pijp' neighbourhood summit

In March 2015 residents, entrepreneurs, politicians and civil servants started talking about their neighbourhood, about what could be done or organized new or better. This talking delivered 52 realistic ideas to explore. Afterwards a new project called 'G250 works'(G250 werkt) started to make these ideas come true. The city area council donated a fund for use on a 50/50 base. Target of the project was bringing people together for more self initiative for the benefit of each other and themselves. A typical example of stage two 'sharing pride'. See picture 4.

10. Zuid, 'Watertuinen' (Water gardens)

From 2000 on residents of two Amsterdam city canals created 200 floating gardens to create meeting places, be active together and to make the city more green and healthy. Additional projects started like a picture competition to share the good feeling among the residents. In 2015 by a mistake the city area organization destroyed a number of these water gardens. That happening showed how pride the participants were on their project and new initiatives developed afterwards. Therewith the project showed to be an example of the fourth stage 'shared identity'. See picture 4.

11. Zuid- East, 'Straatschoonmaak' Holendrecht (street cleaning-up)

On a regular base neighbourhood ambassadors (local civilian volunteers that try to know residents, speak and connect them) do organize street cleaning up activities with school children. Parents and local entrepreneurs are

asked to organize food and small presents to honor the children for their work. These spinoff activities show that this project is an example of stage three 'self esteem'



Figure 4: Initiatives DN park, Hugo de Grootkade, water gardens and G250 de Pijp.

2.3 General analysis of Amsterdam questionnaire results

The revealing of the best practices by city councilors mentioned civilian initiatives (paragraph 2.2) should be a help to learn which stages of 'proud feeling' (as illustrated in paragraph 1.3) are actual in the nowadays practice of Amsterdam initiatives. Secondly, by categorizing these Amsterdam initiatives to the by SBE16 presented diversity of civilian initiative forms (paragraph 1.2). To learn from the possible coupling between 'proud feeling' and the working form of the civilian initiatives. This all to answer the second part of the research question 'what's the impact of pride feeling on the success of civilian initiatives'.

For the analysis is chosen for using the visual methodology of a diagram in which these stages of 'proud feeling' and 'civilian initiative forms' form the axis of a table in which the 11 Amsterdam civilian initiatives can find its place. Another reason for this choice is, there was to less data on the initiatives available for cross-data relation analyses, and secondly this choice of analysis makes the SBE17 research a interesting deepening of the SBE16 research in 2016 presented. Additional can be argued that the simplicity of the diagram approach suits an exploring research as this is.

The result of this analyses is the diagram shown in Figure 5, containing the 11 civilian initiatives by city area counselors mentioned, categorized towards the two axis of stages of 'pride feeling' (x-axis) and forms of civilian initiatives (SBE16) (y-axis). Advanced to that the initiatives are given in the diagram three colors categorizing the kind of initiative if this is of 'meeting people' (red), 'green plants' (green) and others (blue), this because these categories are mentioned in the dissertation concerning facets of civilian group cohesion behaviour (Sanders, 2014). Thirdly the cloud of initiatives in the diagram is given a circling (purple) to visualize which combinations of categorizing are the more actual for the 11 civilian Amsterdam initiatives.

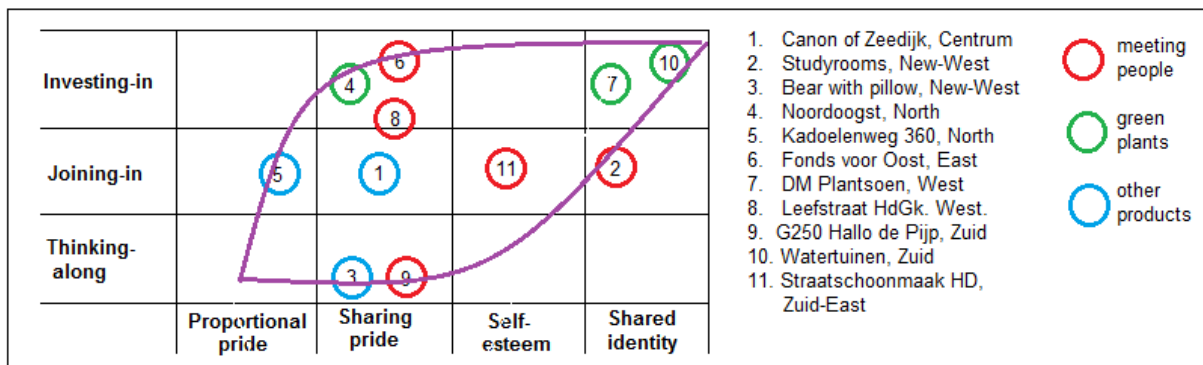

Figure 5: Diagram categorizing 11 Amsterdam civilian initiatives.

The following conclusions can be adopted:

- **Most of these civilian initiative a 55% concern 'sharing pride' stage two.**
- **These 'sharing pride' initiatives are found in all forms of civilian initiatives**
- These initiatives do not combine basic and further developed stages and forms.
- **Green initiatives concern 'investing-in' mostly and match all 'pride feeling' stage.**
- **Initiatives other then 'meeting people' and 'green plants' are mainly of 'sharing pride' stage and 'joining-in' form.**
- **The initiatives of 'shared identity' stage and 'investing-in' form are both green.**

3. PRIDE FEELING THE CIVILIANS INITIATIVE MOTIVATOR CONCLUSIONS

In special preparation for the SBE17 Conference this advanced research following-up the SBE16 research on successful models of sustainable civilian initiatives concerning the **importance and the impact of 'pride feeling'** is examined during autumn 2016. The result must be marked as exploring research having the characteristics of a quick. At the other hand the research is done as a spinoff of my dissertation. And there with this exploring research suits in the new tradition of quick and divers research deepening facets of this dissertation, widening the scope around the subject of civilian initiative more than focusing as in the dissertation, more to build-up a body of knowledge facilitating new long term research in time on civilian initiative.

With this reserves the following conclusion can be presented:

- **Based on literature search 'pride feelings' an be given four stages namely: proportional pride, sharing pride, self-esteem, sharing identity.** By analyses the idea is suggested that these ca form a closed circle that can be followed additional times, this is not proven and not rejected by this research.
- The Amsterdam city area counselors do high estimate both the importance of civilian initiative for the **development of the city and the importance of 'pride feeling' for the success of these civilian initiatives**, respectively 74% and 72,5%. At the other hand they show less to know how many initiatives there actual are in the city of Amsterdam. Because of the homogeneous reaction of the counselors on this subject the result can be seen as a direction for conclusion. An sophisticated inventory of civilian initiatives in combination with research on the drivers for success is recommended.
- **The analysis of the 11 best practices 'proud feeling' civilian initiatives delivered the insight that 'sharing pride', sharing activities and mutual interest, is the most common stage actual for Amsterdam initiatives.** The more interpersonal stages being **'self-esteem' and 'sharing identity' are less common.** Here can be suggested a parallelism with one of the conclusion of my dissertation that Dutch civilians avoid tight forms of social cohesion, they prefer social togetherness instead.

The cloud of categorized initiatives in the diagram of paragraph 2.3 show that the less (and the most and **intermediate forms**) **developed stages of 'pride feeling' and forms of cooperation of the civilian initiative** show matching to the most. Thereby can be suggested that this can be the case because of the difference of light and tight structured networks of the participants (Weick, 1979). It can be an obvious combination that within civilian initiative in which the participants take more own government-loose responsibility for which they have to work more intensive together, proud feelings becomes more breeding ground and urgency from the participants. It would be interesting to research such best best-practices further when a significant number of cases is available.

APPENDIX

Civilian Initiative Factors		Density to 1/1000	Local development factor	Proud Feeling factor	Negative Motivation factor
		%	%	%	%
Centrum	1	-50	15	10	70
	2	-	88	0	50
Nieuw-West	3	+/-3	100	85	5
	4	-65	5	30	35
	5	x	x	x	x

Noord	6	-	80	70	50
	7	+30	60	80	0
Oost	8	+/-30	80	50	0
	9	x	x	x	x
	10	x	-x	x	x
West	11	-	70	80	10
	12	+20	80	80	10
	13	x	x	x	x
Zuid	14	+/-1	100	20	80
	15	-	50	100	-
	16	+150	100	80	40
Zuid- Oost	17	-10	70	70	25

Appendix 1: Research results questionnaire Amsterdam city area council members questioned on factors of civilian initiative.

REFERENCES

- [1] BOON, F., ROODENRIJS, J. & STIJKEL, A. 2013. Kennisdelen over Klimaatneutraal, we gaan samen voor goud. Rijkswaterstaat
- [2] COOPER, T. D. 2003. Sin, pride, and self-acceptance. Downers Grove, IL: InterVarsity Press.
- [3] DAVIDSON, D. 1976. Hume's cognitive theory of pride. *The Journal of Philosophy*, 73, 744-757.
- [4] HAJER, M. 2011. De energieke samenleving. Op zoek naar een sturingsfilosofie voor een schone economie. Planbureau voor de leefomgeving.
- [5] MANUCIPALITY, A. 2015. Housing in Amsterdam 2040.
- [6] MERCER, J. 2014. Feeling like a state: social emotion and identity. *International Theory*, 6, 515-535.
- [7] MINISTERIE-VROM 2009. Innovatieprogramma Klimaatneutrale Steden. Den Haag: Rijksoverheid.
- [8] SANDERS, F. C. 2014. **Sustainable Development through Resident's Collective Initiatives (dissertation)**. Delft University of Technology.
- [9] SANDERS, F. C. & TIMMEREN, A. V. 2016. 'Zero Transition' in housing areas prosper by balancing municipality-control and citizens-participation, by bundling of Dutch IKS2 case-study results in a PhD following-up. In: EWEG, E. (ed.) SBE16 Sustainable Built Environment 2016 - Transition Zero 7-8 April 2016 (Reviewed). Utrecht, the Netherlands: Hogeschool Utrecht.
- [10] TAYLOR, G. 2012. Pride. *The International Encyclopedia of Ethics*.
- [11] TONKENS, E. H. 2009. Tussen onderschatten en overvragen: actief burgerschap en activerende organisaties in de wijk, Haarlem, SUN Trancity.
- [12] UN 2014. World Urbanization.
- [13] WEICK, K. E. 1979. *The social psychology of organizing*, Boston, Addison-Wesley Reading, MA.
- [14] WRR 2012. Vertrouwen in burgers. Den Haag: Wetenschappelijke Raad voor het Regeringsbeleid.

Enhance Public Sustainability Awareness by Feng Shui

Patrick LUI Yin-park^a, Michael Y MAK^b

^a Cundall Hong Kong Ltd., Hong Kong SAR, p.lui@cundall.com

^b The University of Newcastle, Australia, michael.mak@newcastle.edu.au

ABSTRACT

Sustainability is the most sought after topic in the contemporary built environment. The fundamental concept of modern sustainable building emphasizes on a holistic approach to reduce negative environmental impact of man-made structure, and this is coincided with the ancient Chinese knowledge of Feng Shui that aims to creating harmony between heaven, earth and human. Previous studies have already indicated that there are many similarities between ecological sustainable design and principles and practice of Feng Shui. The purpose of this paper is to explore these similarities through BEAM Plus, the sustainability rating system in Hong Kong. This paper will compare the five categories of BEAM Plus with the Chinese traditional Feng Shui concepts to enhance public awareness of sustainability in the built environment amongst the Chinese communities. The results indicate that two categories of BEAM Plus: Site Aspects and Indoor Environmental Quality are the major concern toward Feng Shui concepts. This study enhance the general public in Hong Kong to aware the importance of sustainability from the Feng Shui perspective.

Keywords: Feng Shui, sustainability, BEAM Plus, public awareness

1. INTRODUCTION

Feng Shui is the traditional wisdom of the Chinese art of building design that aims at creating a harmony between environment, buildings and people. Sustainable design emphasizes on a holistic approach to eliminate negative environmental impact through skillful and sensitive design. The goal of sustainable design is to look at all the systems together and to make sure they work in harmony. This integrative design process is similar to the Chinese holistic view and the Feng Shui approach to the built environment (Humphreys, 1976). It is suggested that interpreting Feng Shui knowledge would embrace the western concept of sustainable design. This paper explores the relationships between the concepts of sustainable design and Feng Shui in environmental design. Firstly, the principles and practices of sustainable design and Feng Shui in environmental design are briefly explained. Then, a set of five concepts of sustainable design and five Feng Shui concepts in terms of environmental design are identified and compared. Finally, the five categories of BEAM Plus for New Buildings, the sustainability rating system in Hong Kong, are compared with the traditional Feng Shui practice.

1.1 Sustainability design in Hong Kong

The original concept of Green Buildings emphasizes “the increasing efficiency with which buildings and their sites use water, energy and material; and reducing building impacts of human health and the environment, through better siting, design, construction, operation, maintenance and removal throughout the complete life cycle” (Office of Federal Environmental Executive, 2003). The concept of Green Buildings has been extended on a larger scale, focused on “Sustainability” or “Sustainable Development”. According to the World Commission on Environment and Development (WCED), it is defined as “forms of progress that meet the needs of the present without compromising the ability of future generations to meet their needs” (Brundtland, 1987). With the latest sustainability commitment in Paris 2015, “Transforming our world: the 2030 Agenda for Sustainable Development”, every single country and all human in the world should change their life a little bit to protect our planet.

In Hong Kong, HK2030 Campaign provides a vision for a low carbon, sustainable built environment in Hong Kong by 2030. BEAM Plus – Building Environmental Assessment Method is a renowned green building labelling tool in Hong Kong certified by the Hong Kong Green Building Council (HKGBC) to evaluate the environmental performance of buildings. It contributes significantly towards sustainable development in Hong Kong. The marking scheme process the rating on five categories: Site Aspects, Material Aspects, Energy Use, Water Use and Indoor Environmental Quality, and credits on Innovations and Additions on design solutions. It will be classified in the rating of Bronze, Silver, Gold and Platinum.

1.2 Feng Shui – The traditional Chinese wisdom

Feng Shui, the ancient Chinese knowledge that aims at creating a harmony between heaven, earth and human **has influenced most traditional built environmental design in China for thousands of years. Since the late 1960's**, the impact of western civilisation and technology has grown to global proportions, with more western scholars becoming aware of the limitations of modern scientific paradigms that fail to explain the whole realm of natural phenomena and beginning to realize that there are similarities between modern science and eastern philosophy (Capra, 1975).

However, it was not until 1956, when Joseph Needham published his book series “Science and Civilisation in China”, that western readers began to appreciate the scientific context in which Feng Shui flourished. Needham tried to identify relevant aspects of western science and their applications to traditional Chinese counterparts. He began to appreciate the value of Feng Shui in ecology and landscape aesthetics. According to Needham (1959, p.361) Feng Shui **“embodied ... a marked aesthetic component, which accounts for the great beauty of the siting of so many farms, houses and villages throughout China”**.

Anderson and Anderson (1973) recognized that Feng Shui is an aspect of Chinese cultural ecology. They investigated village siting in Hong Kong of Feng Shui configurations with modern planning practice on site planning, **land use and natural resources, especially those of ecology. They recognized that Feng Shui is “basically a very practical system whereby a village is situated such that it does not take up farmland or lay itself open to floods and typhoons... based on sound pragmatism” (Anderson and Anderson, 1973, p.45-50). They called Feng Shui “the traditional Chinese science of site planning”, containing “an organized body of knowledge, intensely practiced in application, and of specific intent” (Anderson, 1973, pp.127-128).**

2. COMPARISON OF SUSTAINABLE DESIGN AND FENG SHUI

The sustainable development concept includes many areas such as waste and recycling, energy, water, building design, emission, indoor environmental quality (IEQ), alternative transport, landscaping, and about everything that revolves around human activity, and aims to eliminate negative environmental impact while continuing to be completely ecologically sustainable through skilful and sensitive design (McLennan, 2004). It can be summarized to a set of five fundamental concepts for sustainable development (Dong and Zuehl, 2009):

- Constructivism – to create more enjoyable space that build knowledge and skills for the end users
- **Circular design (McDonough’s “Cradle to Cradle” concept)** – to reduce, reuse, recycle through the intelligence of natural systems
- Energy efficiency – reduce consumption of natural resources to increase environmental satisfaction
- Balance between natural and the built environment – bring natural elements (sunlight, plants, water, etc.) to improve the behaviour of the user in the environment
- Thinking global and buying local – acquire from local markets to increase **the environment’s overall well-being**

The principles and practices of Feng Shui are aimed at creating a harmonised built environment for people to live in, and it represents a traditional Chinese architectural theory for selecting favourable sites, as well as a theory for designing cities and buildings (Lee, 1986). The five fundamental concepts of Feng Shui in terms of environmental design (Mak & Ge, 2010) are:

- Unity between heaven and human – to create a balance and harmonious environment between natural and man-made structures
- The five elements cycles – productive and destructive relationships of five observed natural phenomena (Fire, Water, Metal, Wood and Earth)
- Yin and Yang harmony – to create balance space from engaging two opposing parts (positive and negative) in nature and human
- The form school model – an arm-chair position from five geographical configurations (Dragon - supporting mountain, Sand - surrounding hills, Water – flow of water, Cave - front open space, Direction – orientation)
- Balance between interior and exterior spaces – create a harmonious space amongst surrounding environment, external layout, internal layout and interior arrangement

The five fundamental concepts of sustainable design can be compared with the five Feng Shui concepts in terms of environmental design. When comparing the concepts of sustainable design with Feng Shui, there are both similarities and differences. Firstly, the concept of constructivism translates well into the principles of harmony between universe, earth and human in Feng Shui. The ideal environment for Feng Shui is that these three aspects intersected and overlapped. These three circles can also be found in sustainable design as social contexts, environmental and human as shown in Figure 1.

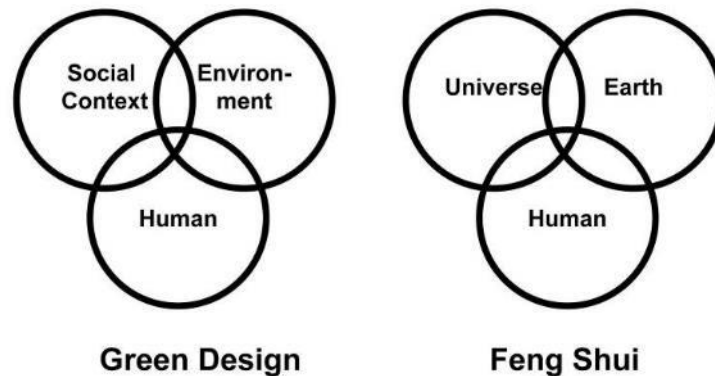

Figure 1: Comparison of the principles of green design with Feng Shui (Source: Dong and Zuehl, 2009)

The second principle of Feng Shui is the productive and destructive cycles of five elements, which is similar to the **circular design** or McDonough's "Cradle to Cradle" concept (McDonough and Braungart, 2002). The third Feng Shui concept is the balance and harmony between Yin and Yang, which also matches with the concept of sustainable design of balancing between natural environment and the built environment. In sustainable design, the third and fifth concepts, energy efficiency and buying local concepts are focused explicitly on the sources and consumptions of natural resources. However, the Feng Shui concepts of Form school model and balance between interior and exterior spaces are focused on the physical form and spatial arrangement of the built environment. Table 1 summarized the comparison of sustainable design concepts and Feng Shui concepts.

Sustainable Design Concepts	Feng Shui Concepts
<i>Balance and Harmony</i>	
(1) Constructivism	(1) Unity between heaven and human
(4) Balance between natural and the built environment	(3) Yin and Yang harmony
<i>Cycles Pattern</i>	
(2) Circular design	(2) Five elements cycles
<i>Sources and Consumption of Natural Resources</i>	
(3) Energy efficiency	(4) Form school model
(5) Thinking global and buying local	(5) Balance between interior and exterior space

Table 1: Comparison of sustainable design and Feng Shui concepts (Source: Mak and So, 2015, p.152)

3. COMPARISON OF BEAM PLUS AND FENG SHUI

There are five categories of BEAM Plus rating system: Site Aspects, Material Aspects, Energy Use, Water Use and Indoor Environmental Quality (while credits on the Innovations and additions are measured separately). In the BEAM Plus for New Buildings Version 1.2 published in July 2012, there are a total of 80 considerations (BEAM Society, 2012). The following Table 2 to 6 highlighted those considerations which are similar to the Feng Shui concepts.

Site Aspects (SA)	Sustainable evaluations	Feng Shui concepts
(SAP1) Minimum Landscape Area	Planting on site equivalent to at least 20% of the site area.	(2) Five elements cycle of the natural phenomena (Wood element)
(SA1) Contaminated Land	Conducting a site contamination assessment and implementing measures for rehabilitation, and/or proper preparation of sites and structures adjacent to landfill sites.	(1) Create a balance and harmonious environment (Natural environment must be restored to create a balance space)
(SA4) Site Design Appraisal	To achieve greater integration of site planning and design issues	(4) Create an arm-chair model formed from five geographical configurations (Dragon - supporting mountain, Sand - surrounding hills, Water – flow of water, Cave - front open space, Direction – orientation)
(SA5) Ecological Impact	Appropriate design measures have been implemented to contribute positively to the ecological value of the site.	(1) Create a balance and harmonious environment (Balance between natural and man-made environment)
(SA7) Landscaping and planters	Using pervious materials for a minimum of 50% of hard landscaped areas, and appropriate planting on site equivalent to at least 40% of the site area.	(3) Create a balance space from two opposing parts (hard and soft landscape)
(SA8) Microclimate Around Buildings	(a) Wind Amplification - No pedestrian areas will be subject to excessive wind velocities caused by amplification due to the site layout design and/or building design. (b) Elevated temperatures - Providing shade on at least 50% of non-roof impervious surfaces on the site and roof material that meets the Solar Reflectance Index (SRI) of 78 or vegetation roof covering at least 50% of the total roof area.	(4) Create an arm-chair model with balance geographical configurations (Sand - protected by surrounding hills, and Direction – orientation) (3) Create a balance space from two opposing parts (open area and roofed area)
(SA9) Neighborhood Daylight Access and Lighting Pollution	The access to daylight of neighboring sensitive buildings is maintained to the prescribed level. Also, obtrusive light from exterior lighting meets the specified performance for the environmental zone	(5) Balance external environment with interior environment (From surrounding environment to internal layout for natural and artificial lighting)
(SA11-SA15) Air pollution, Noise and Water pollution During Construction and from building Equipment	Providing adequate mitigation measures for construction dust, air emissions, noise and water pollution.	(1) Create a balance between natural and built environment (Balance between natural and man-made features)

Table 2: Comparison table of sustainable and Feng Shui in site aspects

<u>Materials Aspects (MA)</u>	Sustainable evaluations	Feng Shui concepts
(MA4) Adaptability and Deconstruction -Spatial adaptability and structural adaptability	Providing spatial flexibility that can adapt spaces for different uses, and allows for expansion to permit additional spatial requirements	(3) Create a balance space with two opposing parts (space requirements for different users, different timeframe)

Table 3: Comparison table of sustainable and Feng Shui in material aspects

<u>Energy Use (EU)</u>	Sustainable evaluations	Feng Shui concepts
(EU13) Energy Efficient Building Layout	a) Consideration of built form and building orientation; b) Consideration of optimum spatial planning; c) Consideration of building permeability provisions of building features to enhance the use of natural ventilation; d) Provision of fixed or movable horizontal/vertical external shading devices; e) Provision of movable external shading devices for major atrium facade windows or skylights.	(4) Create an arm-chair model with balance geographical configurations (Dragon - supporting mountain, Sand - surrounding hills, Water – flow of water, Cave - front open space, Direction – orientation)

Table 4: Comparison table of sustainable and Feng Shui in energy use

<u>Water Use (WU)</u>	Sustainable evaluations	Feng Shui concepts
(WUP1) Water Quality Survey	Ensure quality of water delivered to building users is satisfactory.	(4) Create an arm-chair model with balance geographical configurations (Water – flow of water)

Table 5: Comparison table of sustainable and Feng Shui in water use

<u>Indoor Environmental Quality (IEQ)</u>	Sustainable evaluations	Feng Shui concepts
(IEQP1) Minimum Ventilation Performance	With the minimum requirements of Outdoor Air Quality; and Minimum Ventilation Rate	(4) Create an arm-chair model with balance geographical configurations (Sand - protected by surrounding hills, and Direction – orientation)
(IEQ2) Plumbing and Drainage	Reduce the potential for transmission of harmful bacteria viruses, and odours.	(3) Create a balance space with two opposing parts (Balance between nature and human)
(IEQ13and 14) Thermal Comfort in Air-Conditioned Premises and Naturally Ventilation Premises	Room air diffusers satisfy the Air Diffusion Performance Index. The thermal performance, and the internal wind speeds, of the occupied/habitable rooms fall within the 80% acceptability range for the tropical climate conditions of Hong Kong.	(4) Create an arm-chair model with balance geographical configurations (For natural ventilation, Sand - protected by surrounding hills, and Direction – orientation)
(IEQ15) Natural Lighting	Normally occupied spaces is adequately lit with an average daylight factor	(5) Balance external environment with interior environment (For natural lighting, balance of external layout and internal layout)

Table 6: Comparison table of sustainable and Feng Shui in indoor environment quality

From the above tables, Site Aspects consist 8 items that are similar to Feng Shui concepts, which is half of the list above. Other than that, there is only one item each in Material Aspects, Energy Use, and Water Use. In Indoor Environmental Quality, there are 4 items similar to Feng Shui concepts. Overall, in the BEAM Plus – New Building category, Site Aspects and Indoor Environmental Quality are the major concern toward Feng Shui concepts.

These results indicated that BEAM Plus rating system is focused on the tangible measurements in Material Aspects, Energy Use and Water Use. However, Site Aspects are most related to the architectural and urban planning, which is classified as passive sustainable design and it should be planned at the very beginning of a development project. Feng Shui concepts focused on physical form and spatial arrangement of the built environment provides intangible evaluation in these aspects. Performance measurements of BEAM Plus in Indoor Environmental Quality suggested to provide a comfort condition for human to live. This is similar to the Feng Shui concepts that aim to creating harmony between heaven, earth and human, with the emphasis of human potential through the built environment.

4. CONCLUSION

This paper has compared and contrasted the concepts and practices between western sustainable design and Chinese Feng Shui through investigations of five categories of BEAM Plus rating system in Hong Kong. The findings have suggested that both concepts are the same in terms of focusing sustainable development, that is, to provide a balance and harmonious built environment. The distinct feature of sustainable design put greater emphasis on the measurement of physical attributes such as the efficient use of material, water and energy, whereas Feng Shui is unique and the emphases are on the balance of Yin Yang, exterior and interior, the relationship between physical form and spatial arrangement of the built environment. Through the analysis of five categories of BEAM Plus rating system for New Buildings in Hong Kong, Site Aspects and Indoor Environmental Quality are the major concern of the Feng Shui concepts. These results indicated that BEAM Plus focus on tangible measurement of sources and consumptions of natural resources, whereas Feng Shui concepts focus on intangible factors of surrounding environment and well-being conditions. Based on this comparison between Feng Shui and the BEAM Plus rating system in Hong Kong, it can enhance the public awareness on sustainability amongst the Chinese communities. This analysis also provides a framework for Feng Shui concepts to be considered and applied into the modern sustainable buildings that will enhance the effectiveness of sustainable development.

REFERENCES

- [1] Anderson, E. (1973) Feng-Shui: Ideology and Ecology. IN: Anderson, E. and Anderson, M (eds.) Mountains and water: Essays on the Cultural Ecology of South Coastal China. Taipei, Orient Cultural Service.
- [2] Anderson, E. and Anderson, M. (1973) Changing Patterns of Land Use in Rural Hong Kong. IN: Anderson, E. and Anderson, M. (eds.) Mountains and water: Essays on the Cultural Ecology of South Coastal China. Taipei, Orient Cultural Service. pp.45-50.
- [3] BEAM Society Ltd. (2012) BEAM Plus for New Buildings, Version 1.2. Hong Kong: Hong Kong Green Building Council. http://www.beamsociety.org.hk/files/BEAM_Plus_For_New_Buildings_Version_1_2.pdf
- [4] Brundtland, G.H. (1987) Report of the World Commission on Environment and Development. United Nations, General Assembly Resolution 42/187, 11 December 1987. Retrieved: 2007-04-12
- [5] Capra, F. (1975) The Tao of Physics. London, Wildwood House.
- [6] Dong, W. and Zuehl, R. (2009) The Comparison and Contract Between Green Design and Feng Shui. IN: Mak, M.Y. and So, A.T.P. (eds) Research in Scientific Feng Shui and the Built Environment. Hong Kong, City University of Hong Kong Press. pp.201-222.
- [7] Humphreys, C. (1976) Zen Buddhism. London, Allen &Unwin.
- [8] Lee, S.H. (1986) Feng Shui: Its Context and Meaning. Unpublished PhD Thesis, Cornell University.
- [9] Mak, M.Y. & Ge, J.X. (2010) Sustainable Design and Feng Shui: A Case Study of an Office Building in Sydney. IN: Barrett, P., Amaratunga, D., Haigh, R., Keraminiyage, K., Pathirage, C. (eds) Building a Better World, Proceedings of CIB World Congress 2010, The University of Salford, Salford, UK. <http://www.cib2010.org/post/files/papers/1197.pdf> (accessed 18 May 2010).
- [10] Mak, M.Y. & So, A.T.P. (2015) Scientific Feng Shui for the Built Environment: Theories and Applications, Enhanced New Edition. Hong Kong: City University of Hong Kong Press.
- [11] McDonough, W. & Braungart, M. (2002) Cradle to Cradle: Remaking the way we make things. New York, North Point Press.
- [12] McLennan, J.F. (2004) The Philosophy of Sustainable Design. Kansas City, Missouri, Ecotone Publishing.
- [13] Needham, J. (1959) Science and Civilisation in China, vol 3, Mathematics and the Sciences of the Heavens and the Earth. Cambridge, Cambridge University Press.
- [14] Office of Federal Environmental Executive (2003) The Federal Commitment to Green Building: Experiences and Expectations, 18 September 2003.

Social Sustainability

Ada FUNG^a, Irene CHENG^b, Stephen YIM^c, Clarence FUNG^d, Cynthia CHU^e

^a Hong Kong Housing Authority, Government of the HKSAR, Hong Kong SAR, ada.fung@housingauthority.gov.hk

^b Hong Kong Housing Authority, Government of the HKSAR, Hong Kong SAR, irene.cheng@housingauthority.gov.hk

^c Hong Kong Housing Authority, Government of the HKSAR, Hong Kong SAR, stephen.yim@housingauthority.gov.hk

^d Hong Kong Housing Authority, Government of the HKSAR, Hong Kong SAR, clarence.fung@housingauthority.gov.hk

^e Hong Kong Housing Authority, Government of the HKSAR, Hong Kong SAR, cynthia.chu@housingauthority.gov.hk

ABSTRACT

The Hong Kong Housing Authority (HKHA) develops and implements one of the world's largest public housing programme and is committed to providing adequate and affordable quality housing services to people who are in genuine need.

Over the decades, HKHA has been embracing the core values of "Caring, Committed, Creative and Customer Focused" in delivering the sustainable public housing in Hong Kong. Since 2002, we have changed our modus operandi from basic levels of "informing", "consulting", to tertiary levels of engaging the public to "decide together" and "acting together" in drawing up of plans and design briefs to meet common objectives, and in providing feedback and suggestions for long-term maintenance. Public engagement processes result in socio-economic benefits and the aggregate of changes enhance the surrounding built environment, local character and social identity of its neighbourhood. In this Paper, we focus on the community aspects, namely, a) Community engagement; b) Sustainable lifestyle; c) Socio-economic impact, and d) Corporate social responsibility, to share our experience on how HKHA creates sustainable communities in public housing estates –

- Public consultation at planning stage engaging the District Council, Concern Groups and Stakeholders in the neighbourhood;
- Integrated knowledge management and feedback system covering not only the design stage but expanding also to building completion and occupation. Under the system, we conduct resident surveys and organize post completion review workshops for newly completed projects to gauge residents' satisfaction level on the estates in which they live, and capitalize their feedback for continuous enhancement of our design standards;
- **Setting up Estate Management Advisory Committees with tenants' participation** - to decentralize estate management to local level; and
- Total Maintenance Scheme features proactive in-flat inspection, timely arrangement of maintenance works and education for tenants.

Keywords: sustainable community, community engagement, public housing

1. INTRODUCTION

The Hong Kong Housing Authority (HKHA) develops and implements one of the world's largest public housing programme. As a progressive public sector developer underpinned by the core values being caring, customer-focused, creative, and committed, HKHA is committed to providing happy and harmonious homes with caring and **stable communities for the people of Hong Kong**. The ensuing paragraphs share HKHA's experience on community participation through case studies and summarize tangible results and benefits in the recent endeavors.

2. FROM INFORMING, CONSULTING TO ENGAGING

Sherry Arnstein, former Executive Director of the American Association of Colleges of Osteopathic Medicine, mentioned about a "ladder" of participation, reflecting different levels of power exercised by communities, and there are five different kinds of participation as follows (Lister, Perry & Thornley):

1	Informing	Telling people about what is planned and engaging their interest in it
2	Consulting	Offering people options, getting feedback from them and taking account of their views
3	Deciding Together	Encouraging people to develop ideas or options, and giving them some influence in deciding the way forward
4	Acting Together	Joint decision-making on action to be taken, and forming partnerships with residents' groups to carry it out
5	Supporting Independent Community Initiatives	Helping residents to carry out their own plans or initiatives, whilst leaving them in charge of what happens

Table 1: Five different kinds of participants

Since HKHA's development has major impact on the lives of our tenants, we make every effort to ensure that our residents will enjoy a sustainable community life and have a sense of belonging in the communities they live in. So have we done enough for our tenants and community in terms of tenants' participation and public engagement?

Towards this end, we have a long-standing practice of informing the community, consulting various concerned groups and District Councils (DC) at the early stage of planning and design of new estates. That is to say, "Informing" and "Consulting" have long been our common practice across the board. Following the turn of the millennium, we ventured to test the route for higher levels of involvement by partnership with stakeholders. In our recent endeavours, we took a step ahead to engage the community in "Deciding together", "Acting together" as well as helping the residents to carry out their own initiatives.

3. CASE 1 – REDEVELOPMENT OF PAK TIN ESTATE

Since the announcement of the redevelopment of Pak Tin Estate in April 2012, HKHA has conducted over 150 events to communicate with the local residents and stakeholders, to collect their feedback and concerns so as to optimize the redevelopment proposal. We believe that "Strengthening of communication and understanding will strike a balance between the expectations of both sides and alleviate grievance."

The 150 events included:

Regular level of consultation (over 130 events)

- DC & Estate Management Advisory Committee (EMAC) consultations
- Meetings & site visits with Legislative Council (LegCo), **DC members, concerned groups and residents' representatives**
- **HKHA members' meeting with concern groups**



Figure 1: Over 130 events of regular level of consultation including consultations, meetings & visits

Advanced level of consultation (over 20 events)

- **Arranged briefings and attended residents' forums held by DC members**
- Arranged community engagement workshop
- Distribution of pamphlet & newsletters to tenants, Non-Government Organizations (NGOs) and schools, to brief and respond to concerned redevelopment issues e.g. closure of public transport interchange and temporary transportation arrangement
- Broadcasting video at domestic block entrance lobbies to brief residents on redevelopment information



Figure 2: Advanced level of consultation events e.g. forum, workshops, pamphlets, newsletters

Through public consultation, basic and consistent development information and principles were conveyed to stakeholders, and stakeholders' views were collected. This strengthened communication between community and HKHA and enhanced the planning and design of the redevelopment project with incorporation of their views.

4. CASE 2 – URBAN GREEN HOME – KWAI SHING CIRCUIT

Kwai Shing Circuit Development was the last part of a major redevelopment project at Kwai Shing East. The project scope comprised the demolition of the former Block 12 of Kwai Shing East Estate and construction of two domestic blocks as well as an integrated lift tower and the communal open space.



Figure 3: Image and location of the former Block 12 of Kwai Shing East Estate

At the planning stage of the project in late 2008, objections from stakeholders were received on the disposition of the proposed development, i.e. one of the domestic blocks was at a locality right next to an existing school. Management of expectation of the school was crucial as complaints arose from the school might jeopardize the construction programme. A series of activities and workshops were conducted to engage stakeholders in the design of the development. Until April 2009, based on the comments collected from the public consultation activities, disposition of the two domestic blocks was re-arranged to the lower and the upper platform, where the adjoining space of existing school was planned to be an open space.

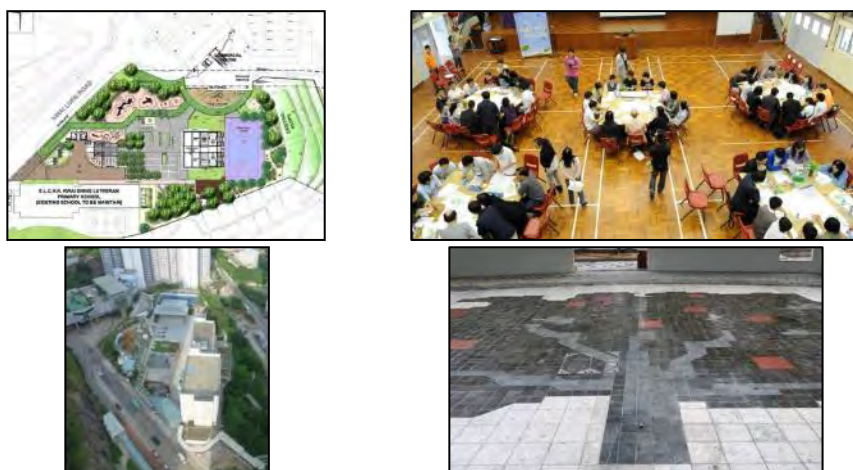

Figure 4: A series of activities and workshops have been conducted to allow stakeholders to get involved in design of the development

During demolition of the existing block, a green hoarding design competition for students of the nearby schools was organized with “green living” as the main theme. The awarded design entries were posted on the hoardings.

Briefing meeting and workshop were also conducted to brief the nearby school users on the demolition procedure, hoarding design, noise and environmental management and safety measures.



Figure 5: Green hoarding drawings competition and briefing meeting and workshop had also been conducted during demolition of the existing block

The community engagement process in Kwai Shing Circuit project is a manifestation of “informing”, “consulting”, “deciding” and “acting together”

- Stakeholder, were invited to community engagement workshop to give ideas for conceptual design of the community garden
- They were also actively involved in design development and construction stage to assure that the final deliverables met their requirements
- The project has best addressed needs and wish of stakeholders. Resistance from stakeholders was minimized and project delivery was accelerated

5. CASE 3 – CONVERSION OF CHAI WAN FACTORY ESTATE TO PUBLIC RENTAL HOUSING

The Government announced the conversion of the Chai Wan Factory Estate (CWFE) into public rental housing in 2012 as one of the short term measures to address the needs of singletons and small families for small-sized housing units in urban area. Being the only surviving example of H-shaped factory building in Hong Kong, CWFE was granted Grade II Historic Building status by the Antiquities Advisory Board in 2013.



Figure 6: A series of community engagement activities and display area in the public rental housing estate sharing collective memories from ex-tenants and local residents

HKHA conducted a series of community engagement activities to introduce the heritage value of the CWFE, to share the collective memories from ex-tenants and local residents and to collect opinion from the district on the preservation of CWFE. In the workshop, design concept of the display area in the future public rental housing estate was also introduced and the valuable contents to be included in the display area discussed.

The participatory processes of “consulting” and “deciding together” described above have taken into account the interests and assets offered by an existing well established community. We have successfully built up the estate identity, ownership and a sustainable community synergistically. We believe that “It is important to recognize the asset and potential that local people, building fabric and service provider offers and to creatively extend them into exciting new potential.”

6. CASE 4 – HAND IN HAND – ACTION SEEDLING

Action Seedling initiated in 2007, is a Community Participatory Scheme to enhance our partnership with contractors, public housing tenants and the community at large. Through Estate Management Advisory Committees, schools and community organizations, seedling plants are given out by HKHA and its building contractors. The participants would nurture the seedling plants at their home until the plants are fit for transplanting into the planters of the newly constructed estates.



Figure 7: Action seedling

The initiative allows our contractor to play their part in greening and environmental protection as part of their corporate social responsibility. **Action Seedling is a manifestation of “acting together”.** It effectively accomplishes our mission towards green and sustainable community. Besides, the programme helps to foster a greater sense of belonging amongst the resident and the community.

7. CASE 5 – ESTATE IMPROVEMENT PROGRAMME FOR KWAI SHING WEST ESTATE

HKHA selected Kwai Shing West Estate completed in 1975 for pilot implementation of BEAM Plus for Existing Buildings. Various improvement measures had been tied in with the Estate Improvement Programme to enhance the environmental performance and promote sustainable living in the estate community. Kwai Shing West Estate had achieved Final Platinum Rating under BEAM Plus EB Version 1.2 in October 2015 and it is the first existing building to receive this award under the existing building category.

7.1 Creating thriving communities

Innovative services and educational components brought the estate improvement in Kwai Shing West Estate to a **new height**. Under “**Total Maintenance Scheme**”, we put un-precedential emphasis on customer services and education. In serving Kwai Shing West Estate and other estates under management of HKHA, some 140 specially **trained inspectors, who not only perform technical building inspections, but also act as landlord’s ambassadors, help motivate and educate the tenants in bringing building defects in their homes to the landlord’s hands**. This holistic approach, which brings peace-of-mind, has been very well received by our tenants and customer satisfaction has stayed high since introduction. With the Scheme as foundation in promoting a defect reporting **culture, the “Responsive In-flat Maintenance Services”** has been launched to provide enhanced and responsive in-flat maintenance services for all tenants with frontline staff register maintenance requests directly from tenants and set repair process in motion quickly. The estate communities are well engaged and educated which contribute to the success of estate improvement in Kwai Shing West Estate.

7.2 Fostering community goals

Energy saving is one of the common community goals to promote sustainable living in Kwai Shing West Estate. Alongside with building improvements using energy-saving light fittings and water-saving installations in common areas, we strive for continuous improvement by regularly monitoring the energy consumptions of the estate. To **arouse tenants’ environmental awareness and** nurture their sense of belonging, ten LCD panels had been installed to display the periodic consumption of electricity, gas and water consumptions at all domestic blocks.

7.3 Engaging the communities

To strengthen social cohesion and sense of belongings, public engagement was conducted in formulation of its estate improvement projects of Open Space Design and Improvement of Elevated Walkway. Through proactive

publicity in DC and Estate Management Advisory Committees meetings, partnership functions with Non-Government Organizations and open forums organized by political parties, about 60 representatives from various stakeholders including estate tenants, nearby schools, NGOs, local District Councilors were invited to participate in the Community Workshop. **A total of twelve meetings were held to gauge stakeholders' views and interviews** were conducted with our tenants in which all participants were able to freely express ideas and enthusiastically contribute constructive ideas. The elevated walkway was finally designed as an Art Gallery displaying old estate **photos and students' drawings, whereas the Open Space was adopted as a fitness and children recreational area.** We have successfully fostered neighbourhood spirit and achieved harmonious relationship with good community network in Kwai Shing West Estate.



Figure 9: Photo (From Top): Community engagement workshop, open space design and improvement of elevated walkway, community workshop

8. POST-OCCUPANCY CONSIDERATIONS

We treasure the views of our residents and have conducted independent Residents Surveys for all newly **completed estates since 2004. The major objective of the Residents surveys is to gauge residents' satisfaction** level on the design and provisions of the estates in which they live, as well as to collect opinion on hypothetical **design and provision scenarios that we would like to explore. Satisfaction level on "estate as a whole" from each** Residents Survey conducted within a year will be aggregated to compile the Customer Satisfaction Index for that financial year. At the onset, our Key Performance Indicator was pitched at 70%. In light of the consistently high satisfaction obtained from these surveys over the years, the Key Performance Indicator has been uplifted to 80% from 2011/ 12 onwards. With engagement of the residents in the planning and design of our estates, the Customer Satisfaction Index is continuously on the rising trend, reaching 95% in recent years.

9. CONCLUSION AND WAY FORWARD

In all cases mentioned above, there is better communication, better understanding, better consensus, and with a better product or services where participating stakeholders have a sense of ownership. Forget about bureaucracies and impossibilities for a while, and be a good listener.

"Seek first to listen and understand, before one could be understood." Start from scratch and look at the world from a different view, listen and accommodate others' views, work with them to arrive at the final conclusion – and on a road less traveled we can derive more satisfaction during the journey towards a win-win destination.

REFERENCES

- [1] Ada YS Fung – Community Engagement in the Planning and Design for a Harmonious Community, 9th International Value Management Conference, 30 Oct 2008

The Application of Social Innovation in Designing an Aged Care Centre in Malaysia

Thomas TANG Sek-khuen^a

^a Kuala Lumpur Centre for Sustainable Innovation, Malaysia, sk.tang@klcsi.com

ABSTRACT

Social innovation is the commercial application of ideas and technology towards improving societies. Of key importance, social innovation works best when the community concerned is empowered to help co-create the innovation. In this paper, social innovation is considered in a Southeast Asian context and how a bottom up approach improves the sustainable design of public buildings such as schools and community centres. A living lab case study is used to demonstrate how identifying and analysing community needs by consulting the latter is fundamental to the design of a community care centre for the aged. The centre incorporates assistive technologies, access design and care features as well as sustainable design such as urban gardening, rainwater harvesting, waste recycling and energy efficiency. The building is also designed for intergenerational use as it is intended to have other users of different ages so that the elderly will be encouraged to interact with them thereby promoting the benefits of active ageing.

Keywords: social innovation, living lab, aged care, community centre

1. INTRODUCTION

Social innovation is the commercial application of ideas and technology towards improving societies and works best when the community concerned is empowered to help co-create the innovation. In this paper, social innovation is considered in a Southeast Asian context and how a bottom up approach improves the sustainable design of public buildings such as schools and community centres. To take this idea further a living lab approach was applied in Kuala Lumpur to design an aged centre in a suburban area.

2. BACKGROUND

2.1 Social innovation

Social innovation can be defined as, “new solutions (products, services, models, markets, processes etc.) that simultaneously meet a social need (more effectively than existing solutions) and lead to new or improved capabilities and relationships and better use of assets and resources. In other words, social innovations are both good for society and enhance society’s capacity to act.” Social innovation, much like technical innovation, involves creative ideas and problem solving skills with the aim of improving social conditions.

Five core factors for social innovation are:

- Novelty: Social innovations are new to the field, sector, region, market or user, or to be applied in a new way;
- From ideas to implementation: Social innovation focuses on implementation and application of new ideas, rather than just inventing new ideas;
- Meets a social need: Social innovations are explicitly designed to meet a recognised social need;
- Effectiveness: Social innovations are more effective than existing solutions – they create a measurable improvement in terms of outcomes; and
- **Enhances society’s capacity to act: Social innovations empower beneficiaries by creating new roles and relationships, developing assets and capabilities and/or better use of assets and resources.**

Thus, social innovators are individuals who have come up with product or service solutions for a specific social problem. For instance, a person who has developed an app for translating an aboriginal dialect into English to improve communication between indigenous tribes and health workers could be considered to be a social innovator. Another example could be an engineer who has invented a way of low cost construction for housing the homeless.

In these cases, the innovator may or may not be seeking a profit out of his or her work. But commonly social innovators would want to see some commercial return on their ideas but not necessarily as a business. Government too sometimes comes up with social innovations e.g. providing free or subsidized bicycles for school children whilst making the school zones car-free to avoid traffic jams around schools. Some NGOs have also provided social innovations such as using cookery or art as a means for the mentally disabled to express themselves.

Over the past decade social innovation has been applied to sustainability and to encourage sustainable living as a lifestyle and behaviour change. The very nature of social innovation, which is community-driven, ensures that institutions, enterprises, non-profit organizations and networks of collaborative persons are able to find common platforms to work together generating a variety of initiatives such as community-supported agriculture, co-housing, carpooling, community gardens, neighbourhood care, talent exchange and time banks. These initiatives propose viable solutions to complex problems e.g., social cohesion, urban regeneration, healthy food accessibility, water and sustainable energy management and, at the same time, they represent working prototypes of sustainable ways of living.

2.2 The living lab approach

Living labs are platforms like a building or a community for user-centred products before they are commercially available. As living labs usually involve partnerships, they are appropriate mechanisms for social innovation. Such partnerships can involve government agencies, companies and research institutes to pool their research on built environment and city management, urban mobility, IT and info-communications, public safety, waste and water management and clean energy. Members of communities are furthermore invited to contribute and shape the tested product.

Social innovation applied in a living lab allows:

- Unprecedented connectivity and networking, which means new possibilities for competition as well as cooperation;
- Global awareness (e.g. about climate change), thanks to information from other citizens and sensors alike, which can enable access to culture and inclusion;
- New solutions for sustainability, based on collective intelligence, including not only new financial and economic models, but also support for a true low-carbon economy, and renewable energy production.

Living labs have the potential to strategically frame co-production processes in two ways. First, consulting users and stakeholders allows complementary sets of projects to be strategically planned that offer holistic solutions to sustainability challenges. Second, by emphasising the iterative process of experimenting and learning from year to year they provide a more coherent basis for action over time. Living labs are emerging as a form of collective urban governance and experimentation to address the sustainability challenges and opportunities created by urbanisation. Five key characteristics are identified:

- Living labs are situated in a real urban context where the process in focus is taking place. This may be a region, an agglomeration, a city, a district or neighbourhood, a road or corridor, or a building.
- Living labs represent a specific form of experimentation, whereby processes of innovation and learning are formalized, unlike policy experiments, and enable the co-production of knowledge and ideas with the users.
- Participation and co-design with stakeholders such as residents and users is at the core and appears in all stages of the living lab approach – from identifying stakeholder needs, deciding upon living lab goals, planning and designing to developing, implementing, evaluating actions and updating.
- A clear leader or owner is crucial for a living lab to be effective, although a fine balance exists between steering and controlling. The living lab needs to be flexible for different stakeholders to engage in its development and direction.
- Finally, evaluation of the actions and impacts of a living lab is important to feed back the results, and revisit and refine the goals and visions over time. Evaluation underpins the ability of living lab projects to facilitate formalised learning amongst the participants.

3. CASE STUDY: AGED CARE CENTRE LIVING LAB

3.1 Ageing populations

Globally, the population of persons aged 60 and above is projected to double to more than 2 billion by 2050 or 21% from 11.7% in 2013. By 2047 the number of older persons is expected to surpass the number of children for the first time. Not only are the numbers of older persons increasing substantially, they also have longer and healthier lives due to higher standards of living and advancements in healthcare. Population ageing is found to be more prominent in developing countries due to the rapid decrease in fertility rates in recent years compared to developed countries. Asian countries stand to face the biggest growth in their ageing population, as one in four Asians will be over the age of 60 by the year 2050.

Malaysia, one of the modern nations in ASEAN, faces an ageing problem. Compared to European countries which took 100 years to double their populations aged 65 and above, Malaysia will take only 23 years to double from 7% in 2020 to 14% in 2043. This is a reflection of longer life expectancy, good public healthcare and lower fertility but the downside is that the country does not have much time to prepare for a new set of issues that come with ageing.

Firstly, care and attention for the elderly will be critical. The old are more prone to chronic diseases, sleep disruption, psychological problems and cognitive decline. Healthcare models will have to be reconfigured to cater for the aged who have spent a lifetime of modern living with all the associated stresses. Housing will be another challenge as **homes designed for the young and active become difficult for the elderly to cope with. Whilst ageing in one's own place is the best approach for a greying population, the practicalities of stairs and toilets will become physically insurmountable with ageing. Moving to aged care homes is a possibility but affordability will be an issue and many elderly will probably end up in aged homes of a basic nature unsuited for their needs. Other problems include physical and psychological degeneration. Even with extended retirement ages, there will come a time when people can no longer work and rapidly deteriorate through emptiness and boredom. Deprived of human company, aged decrepitude becomes synonymous with being abandoned or ignored.**

3.2 Intergenerational community centre case study

The KL Centre for Sustainable Innovation has been involved in the design and development of an innovative community centre in Kuala Lumpur as a social innovation and a living lab that will cater to the needs of the immediate local community - **the elderly, adults, youths and children. The centre's facilities and programs will cover health, social, recreational and educational purposes.** The community centre is a model for intergenerational care that can be easily replicated across other communities in urban areas across Malaysia.

The basis of this approach comes from intergenerational housing models where the young share living quarters with the elderly. In Japan, 40% of older people live with their adult offspring and over 17% live with their grandchildren in contrast to the UK where less than 10% of those aged 70 and over live with their adult offspring and around 2% live in multigenerational households with offspring and grandchildren. Home sharing is where an older person offers accommodation to a younger person at a reduced rate in exchange for support with basic tasks such as shopping or gardening. Co-housing is the development of private households with shared facilities that invoke a sense of community. The best example of an intergenerational model is in Alicante, Spain where 200 affordable, intergenerational housing units were created in central urban areas and populated by older persons over the age of **65 and young people under the age of 35 in a ratio of 80:20 respectively. On the basis of a 'good neighbor agreement', each young person had responsibility for four older people in the building with resulting positive feedback from the elders (increase in well-being and independence within a family-like environment) and the young people (knowledge gaining and the opportunity to nurture real relationships of friendship with the older persons they assisted).**

KLCSI in conjunction with Kirk Architects came up with a design to apply the intergenerational concept for a community centre in a suburban setting. This centre was to be designed specifically with the local community in mind, after a study of the demographics and lifestyle patterns in the area and identifying any gaps or needs not being fulfilled from the perspectives of a wider community. Factors to be taken into consideration include:

- Inclusivity. The community centre will be designed to meet the basic needs of the local community regardless of age, beliefs and social standing. These include a safe environment, modern technology, adequate facilities and open spaces.
- Active. The community centre will provide products and services that the community need or want like classes, activities and assistive tools. These will be provided at a discount through sponsorship.
- Adaptability. The centre will be able to adapt to the changing needs of the community over time through regular stakeholder focus groups.
- Sustainability. The centre will be a showcase for sustainable living that the community members can adapt and apply in their own homes such as urban gardening, waste recycling and energy efficiency.

3.3 Living lab design

Survey

KLCSI conducted a survey on elderly users on their preferences for a community centre. Working with a group of senior adults, the following findings emerged:

- 97% of the respondents prefer that a medical centre should be nearby, and 91% want to live close to their children.
- All of the respondents prefer well trained caregivers (staff or nurses), 97% want swift response and accessible means of summoning help in emergencies, and 97% agree that a 24/7 ambulance service is crucial.
- 94% of the respondents want wheelchair accessibility and 96% want safety features in the buildings. Green technologies received 73% of votes.
- 87% of respondents feel that the reputation of the developer as well as the care centre operator is important, 93% want security features and 96% agree that street lighting is crucial. Gardening and sports received 54% and 48% of the responses.

Architectural design

Kirk Architects produced a pavilion-based design using a reinterpretation of a traditional Straits shop house that was adaptive, viable and flexible with a framework to support a wide range of uses, and allowed multiple modes of management and operation for different generations (see Appendix). Key features include:

- Broad space typologies of activity space, office, amenity and service spaces and circulation in combination with passive strategies to deal with the tropical environment for natural light and ventilation, shading and glare, views and privacy.
- The modular structure of the pavilions allows a loose fit model using structural simplicity and open span functional areas that offer flexibility for a multitude of configurations depending on the particular program requirements whether for elderly or non-elderly use. These include larger spaces suitable for dining, exercise studio, arts and crafts, seminars, celebrations and libraries to smaller configurations suitable for counselling, medical consultation and more personalised services for the elderly such as health planning and management, and non-invasive therapies, and at the same time can be used for playrooms or youth activities if needed.
- The central courtyard forms the key space of the building to connect the community. Security and safety would be ensured in all public spaces and the courtyard acts as a spine to allow easy movement and clear way for the elderly and non-elderly community. The building is permeable allowing continuous connection to landscape elements such as roof top gardens, water, window seats and informal social breakout spaces.
- Utilitarian functions are located each end of the pavilions for vertical circulation, amenities, offices, stores and plants etc. This planning arrangement and the modular nature of the pavilions allows for a building model that can scaled and sized for different sites.
- Technological advances through internet communication allow for remote access for people to online specialist counselling and medical care. This unlocks opportunities for medical screenings, health and nutritional management, counselling and rehabilitative training close to home at the local community facility.

From a sustainable building perspective, sustainability is considered holistically in the design whereby the building responds to climatic conditions such as high rainfall, solar and sky glare, reflective and radiant heat. Features such as natural diffused daylighting and thermal massing, renewable energy such as solar panel and solar air cooling systems, and rainwater collection and harvesting are incorporated. A roof garden serves as an edible food source using rainwater for irrigation and food waste for compost. The centre furthermore utilizes intelligent building systems and real-time software to verify building performances. It is possible that through use of durable, resilient and low maintenance materials, innovative and sustainable building technologies (including glue laminated and cross laminated timber technologies) together with low energy demand that the building could be a leading exemplar as a zero carbon footprint building and act as a catalyst for growth and regeneration in the neighbouring community.

4. DISCUSSION

Although the intergenerational model of aged care has been shown to be successful elsewhere, there are inherent challenges in Malaysia. Other than family ties, it would be justified to say that the model has not taken root in any large measure, possibly due to the unpopular notion of having to share facilities with strangers. There are further issues to do with the fact that Malaysia is quite diverse in its population mix through ethnicity (Malays, Indians, Chinese), religion (Muslim, Christian, Buddhist, Hindu) and culture. But the benefits exist - older people can benefit from reduced levels of loneliness and isolation and increased levels of civic participation, while younger generations can also gain in similar ways and through the learning of new skills and experiences.

In the living lab example presented, the social innovation lies in tackling three issues simultaneously: (1) Creating an intergenerational centre for sharing of knowledge and well-being; (2) Active ageing to enrich the quality of life for the elders; and (3) Sustainable design to lower the footprint of the building and at the same time provide an educational tool to highlight a sustainable lifestyle. The living lab itself benefits from stakeholder consultation and it is planned to do further community profiling to determine potential users.

The architectural design is a creation taking traditional ideas interwoven with more contemporary ones. The application of the modular approach is key to the design as it allows flexibility for the different age groups and their interests, while at the same time does not neglect the needs of the elderly and the potential for active ageing. With further opportunity spaces for interaction (like the urban garden and activity rooms for cooking and dancing) the intergenerational aspects can be tested to see which ones work best. The use of passive strategies like ventilation and natural light provide a degree of comfort and sustainable living, and the overall design further imbues character to the place and a sense of belonging to the users.

To develop the living lab there still remains further exploration of ideas to be completed:

- More community outreach to assess the needs of the non-elderly users – the original idea was that the centre could be used for elderly and very young i.e. toddlers so that it becomes a one-stop shop for families to leave their dependents there during the working day. Surveys need to be done for parents and youths (18 - 24) who may want to drop by the centre to enrol on courses to learn skills from the elderly.
- The modular design needs to be refined to allow interchangeability of units for different purposes. At this stage, the operators of the centre will need to be consulted on the types of service offerings and the fixtures needed to deliver them so that the units can be designed accordingly.
- The active ageing element provides an opportunity to try out new assistive technologies that can help elders still maintain a level of mental and physical ability to be able to socialise and contribute. Further research needs to be done on what types of technologies are available, particularly leveraging on ICT and smart building and personal technologies.
- The sustainability aspects can be further developed. Life cycle costing can be carried out to establish the economic benefits as well as the environmental benefits for each measure. There are other innovative applications that can be incorporated like water recycling and zero waste.

5. CONCLUSION

Social innovation is the commercial application of ideas and technology towards improving societies. Linking social innovation with a living lab allows the idea to be taken to a live demonstrable example which can be replicated to achieve greater impact. An example of this is how to provide for ageing populations. Use of an intergenerational approach could be a social innovation, coupled with active ageing carried out in a sustainable built environment. A case study is used to demonstrate this effect. Further research, in particular on user needs, is recommended.

REFERENCES

- [1] Building and Housing Social Foundation (2012) Municipal Project for Intergenerational Housing and Community Services in Alicante
- [2] Davies, A., (2014) **Spreading Social Innovations: A Case Study Report. A deliverable of the project: "The theoretical, empirical and policy foundations for building social innovation in Europe"** (TEPSIE), European Commission – 7th Framework Programme, Brussels: European Commission, DG Research
- [3] **EU FP7 theme (2012). 'New innovation processes including Social Innovation (collaborative project)'** Project Number: 290771.
- [4] **Evans, J., (2015). 'Living labs and co-production: university campuses as platforms for sustainability science, Current Opinion in Environmental Sustainability, Volume 16, October 2015**
- [5] **Meroni, A., (2010) Social Innovation, Collaborative Networks and Public Space', Chapter · in book: Human Cities - Celebrating Public Space, Publisher: Stichting Kunstboek**
- [6] Neale, D., (2012) An intergenerational solution to the housing quagmire, Guardian Newspaper (May 12th, 2012)
- [7] **Star Newspaper (2015). Silent 'epidemic' of ageing. (9th August 2015)**
- [8] United Nations. (2013). World Population Ageing 2013. United Nations Department of Economic and Social Affairs, Population division. ST/ESA/SER.A/348.
- [9] Voytenko, P. Urban living labs for sustainability and low carbon cities in Europe: Towards a research agenda Journal of Cleaner Production (August 2015)
- [10] WebMD (2015) Is This Normal Aging or Not?
- [11] Wei, L., (2009) Consequences Of Ageing Population in Developing Countries.

APPENDIX

A HOME AWAY FROM HOME

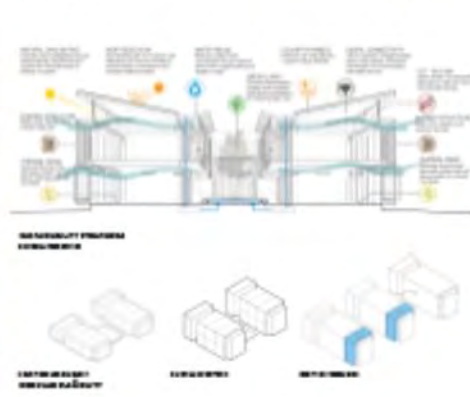

The vision for the KLCSI Elderly Day Care Centre is a building which engages and celebrates the diverse needs of the elderly community. It is a place where the elderly can live and thrive, and where they can find a sense of purpose and belonging. The facility will provide a range of services and activities that will support the elderly in their daily lives and help them to live well into old age.

Our response is to create an adaptive, viable and flexible proposition that is resilient and legible within the local and regional context. Our vision creates a sense of place and a sense of community, with multiple levels of engagement and participation.

The proposal is a multi-story, multi-use building that is designed to be a place where the elderly can live and thrive, and where they can find a sense of purpose and belonging. It is a place that provides a sense of community and a sense of belonging.

KLCSI ELDERLY DAY CARE CENTRE

Ritualized Place and Community Empower

Wasana DE SILVA^a

^a University of Moratuwa, Sri Lanka, wasanade@yahoo.com

ABSTRACT

Traditional cities and settlements in Sri Lanka, are dynamically re-enacted through regular performances and rituals. People, place, rituals, landscape and architecture are inter-connected in these processes making harmonized relationships between built elements, architecture and nature, in contrast to many contemporary developments. The research questions how people understand these places, through these performances and communal engagement and reflect harmonized relationships between people, landscape and architecture. This paper examines the notion of sustainable built environment from phenomenological point of view. Kandy city is described within this performative phenomenon in order to understand the sustainable nature of the place. Phenomenology is the research methodology. A theoretical framework, synthesizing key concepts of place, sense of place, dwelling, *chora*, becoming, non-representational landscape theory and performance theory and body theories, is developed and utilized to examine performance of the Asala perahera ritual process in Kandy city. In these ritual performances people form unique relationships with the immediate and wider landscape by means of walking, dancing, parading, connecting natural elements, topographical locations and historical places with the city. Communal engagement and ritual behaviour are highlighted and re-enacted in these place making processes. Case study analysis illustrates that, Asala perahera marks geometrical patterns, in the landscape inter-weaving different locations, rituals, people and the invisible dimensions of the place which reflect in the place, landscape and architecture as emerging patterns. Ritual behaviour establishes embodied relationships and specific state of mind-body condition in the space and time, true sustainable understanding of the place, significant with specific behavioural approaches throughout the process in natural-cultural setting and body performances.

Keywords: ritual behaviour, performing place, Asala perahera

1. INTRODUCTION

1.1 Asala perahera and spirituality of the place

This paper examines the notion of 'sustainability' from phenomenological point of view. The study examines the Asala perahera performing in traditional cities and settlements in Sri Lanka, where these places are dynamically re-enacted through regular performances and rituals. These ritual ceremonies are happening within the similar time period of the year in all traditional settlements with the participation of large number of people actively, in some places and some events more than two hundred thousand people. The most significant in these ritual ceremonies are people do not recognize any speciality or extra ordinary of these events; people experience these rituals as part of their life and daily routine. Despite contemporary social, economic trends highlight the tourist attraction of these festivals, through social media, emphasizing the dramatic beauty of the performance, the main concern of temple priests, is to perform these rituals as original as it was happening during the past days, experiencing spirituality of the place and ritual performances. Hence, do these ritual performances reflect the essential nature of the humans, associated with culture and nature of the place where they occupied; as a process of place making related to human nature and ontology?

1.2 Research aim and methodology: traditional vs. contemporary

People, place, rituals, landscape and architecture are inter-connected in these traditional processes making harmonized relationships between built elements, architecture and nature, in contrast to many contemporary developments (De Silva,2014). The research questions how people understand these places, through these performances and communal engagement and reflect harmonized relationships between people, landscape and architecture; whether this ritualistic communal behaviour could be utilized to explain sustainable approaches: more in-depth versions of sustainability of the place and cities and settlements. Although Kandy city is under world heritage list, many contemporary developments are a question, whether these forms, styles and tectonics are fitting to the historical and natural context of the Kandy, to the mountainous landscape and to the spirit of the place; how

far these could be explained as sustainable with the landscape, social, cultural, religious context. Among the new developments, new life patterns, and new values how do people understand the value of these traditional rituals? The large number of people, who are not tourists, gathered as participant observers is an evidence of recognizing the human sense and continuing meaning of these performances for their contemporary life. How do these historical ritual performances decide human nature and the place? Can these be a mechanism to understand the **notions of 'sustainability' and 'authenticity' of the place in contemporary city developments?** Therefore, it is realistic to examine the notion of sustainable built environment from phenomenological point of view. The research aims to investigate the role of body and performances of communal engagement of these rituals, among the relationships of people, ritual performances, place and architecture and landscape, employing case study Kandy and Asala perahera ritual performance. It questions how people experience the place; what relationships are developed **between groups of people in these performances. How do these performances 'establish' specific phenomenological situation in the space-time-body framework? How do 'bodies' of communal group engage, empowering the place?** Phenomenology is the research methodology. A theoretical framework, synthesizing key concepts of place, sense of place, dwelling, chora, becoming, non-representational landscape theory and performance theory and body theories, will address these questions.

2. SUSTAINABILITY AND AUTHENTICITY OF THE PLACE

2.1 New trends

The modern concept of sustainable development urged from Brundtland report (1987), advancing some earlier **concepts around 'forest management'**. Today, **'sustainability' evokes vital** forum all around the world encouraging research fields, policy making, International and national conferences, forums, academic curriculum, and recognizing different approaches for sustainability. In the built environment it flourishes many pathways with the **adjective of 'sustainable'** - green architecture, green buildings, sustainable cities, sustainable materials, sustainable construction, sustainable tourism, waste management, sustainable energy consumption, eco tourism, are some of these. Some words and approaches are stylish such as; minimalism, green concepts, adjective of **'eco' describing many nouns, reflecting modern trend of commercialize approaches. However, all these modern trends arise to achieve one goal of sustainability, directly or in directly focusing on natural environment, climate, and human well-being. However, it is true that all around the world these kinds of concepts were not useful and meaningless before 20th century. Traditional settlements reflect multifaceted sustainable approaches to live with nature in harmony, because the life attitudes and nature of understanding the place differ from modern concepts (Borgmann,1987). Sustainable developments as a process is identified and methods, approaches and assessments are developing in many research areas. However, in-depth understanding of 'sustainability' is still unclear, ambiguous, gaps, and incomplete.**

2.2 Sustainable place and authenticity

The **'process' described by Brundtland, implied direction and orientation of human needs and aspirations.** Miller (2013) defines as **'procedural sustainability', an understanding of sustainability as a process for identifying important societal values and pathways for a desirable future.** Dynamic properties of sustainability (Leach et.al) are described as stability, durability, resilience and robustness which could be further described as the properties of material culture. The pathways approach describe STEPS (social, technological and environmental pathways to sustainability) – Leach, where this orientation and direction could be happened in order to achieve material culture. However, processes and approaches are still ambiguous in nature. Although place concepts are identified, case studies which fulfil all the parameters are less regarded. In this context, **the notion of 'place' in phenomenology of architecture, is a useful concept to describe the harmonize relationship between buildings, people and the context; dealing with human experience of the place. In this view, authenticity of the place(Relph,1976 is described as how place flourish with people and from their needs, how people attached to the place and experience 'sense of place' as the essential nature of dwelling (Heidegger, 1962). Placelessness is where people detached from the context, where place is the result of outside agents and aspirations which could be described as a threat to the authenticity of the place, largely reflect on many new developments. Norberg-Schulz(1980) describes how place responds to the natural landscape and the spirit of the locality as a process of dwelling. Place has a direction and dynamic nature, therefore, more useful in describing sustainable approaches to understand the in-depth orientation of material culture.**

3. SUSTAINABILITY AND PERFORMING PLACE

3.1 Performing place

Performance approaches (De Silva, 2014) are more useful to describe dynamics of the place and process to understand the orientation, which leads to the sustainability; performing place is developed to describe the process of sense of place and dwelling, how place emerge and re-emerge with people and their activities, by employing actor network theory (ANT), performance theories and advancing ideas on performance approaches in landscape research. ANT describes that people by acting and walking make a network of relationships around them, which produce place and space (Lefebvre, 1991); landscape which represent the material environment as more than representative, as lived practice in terms of relational views, actions and processes (Lorimer,2005). Therefore, performing place which represents dynamics of the place is an interesting approach to understand **'sustainable nature' of the place and material culture of cities, settlements and landscape of people within the** changing attitudes of people and the place: a phenomenological approach.

The embodied place is evident in sense of place, dwelling and performing place in experiencing the place, architecture and landscape. Surrounding as an extended body; as a lived body; as worldhood understanding and perception of the world (Merleau-Ponty) describe how body reveal the place in acting and performing in surrounding place and landscape. Recent Neuro-scientific research is focusing on finding the gaps between the body and the surrounding reveals how people experience around them as extension of their bodies . All these describe establishing specific space-time-body framework in dwelling and performing place.

3.2 Ritual behaviour

Performing life and celebrating place is common in traditional and primitive cultures, identical with ritual behavior which is characterized by seasonal journeys, walking, ceremonial parades, celebrating places, events and natural landscape features and the making of cultural theatre. According to neuro-scientific explanations, a kind of sharing of sensitivity and understanding happens between people through such rituals. It is also described that emerging place is not always visual; it can also be mythical. It could be involved in making temporary/ permanent structures (built elements/ architecture), making mythical stories about landscape features, singing and playing sounds, dancing/ body gesture, decorating, drawing pictures and images, crafting (varies from farming lands to arts and crafts), and narrating stories: multifaceted nature. According to Eliade(1961) ritual behaviour is identical and revealing inside, center and divine/ spiritual experience within mundane performances, which reveals the orientation of the place towards spirituality. All discussed above theoretically prove that ritual behavior involving with producing space and place, identical with acting and making network of relationships, embodied place, and sharing bodily experiences strengthen the place and place attachment among group of people, attached with invisible dimensions, chora of the place. Following section illustrates and examines how it practically happens by employing case study Kandy and Asala perahera ritual performance in Sri Lanka; how these traditional notions of place understanding could be utilized to understand the sustainability of these places.

4. CITY AS A PERFORMATIVE PLACE

The cultural, religious, social aspects of Asala perahera ritual performance has been studied from various perspectives (Seneviratne, 1978; Seneviratna, 2009). How city is re-enacted and re-experienced through a process of place making, by employing performance approaches of Asala perahera is explained more in-depth place attachments associated with performing, and dwelling (De Silva,2014). Kandy is the last kingdom of Sri Lanka has been taken under the British power in 1815AD and city and city life has been exposed to major changes hereinafter. However, it is recognized by temple priests that rituals in Kandy including Asala perahera still continue without any major changes in the changing face of social, cultural, political history and even today in the contemporary globalization. It is an evidence of how place understanding still continues within the pure domain of phenomenology of the place and architecture, clues of more in-depth sustainable approaches to the place. Asala perahera in Kandy is performed annually making celebrative atmosphere in the city and other villages during July/ August and ended on a full moon day. Sounds of traditional drum beats, dynamic movement of dancers, elephants wearing traditional cloths in the parade are common happenings in the city, making vibrating atmosphere. In Kandy the beginning of the festivals are declared by planting kapa ritual performance held at four temples; temple of god Natha, temple of god Vishnu, temple of god Kataragama and temple of goddess Pattini, the locations of these

temples are same as it was in 1815 A.D. It is noted that although origins of these temple deities are Hindu, in Kandy appears in Buddhist context and interpretations, thus boundaries between religions are unclear, as an evidence of phenomenological place notions. After planting Kapa ritual process, inner parade is performed around these temples for five continuous days; temple priests, flag bearers, drummers and temple assistants participate in this event. Thereafter outer parade known as Kumbal perahera a long processions of people of different villages belong to four temples; dancers, pipers, drum beaters, elephants, traditional administrative heads and temple priests parade along the streets of old city for ten continuous days. Each day parade becomes much longer and much glamorous and in the fifth day temple of the tooth relic also participates in the parade. The final night parade is more elegant, and performed until **midnight of the full moon night, then followed by 'diya kapeema' parade which connects city to the river**; where the place where this ritual happens is related to several mythical and historical stories. The following day afternoon, the parade revisits the city, at an auspicious time: rejuvenating the place (Figure1). The most important in these ritual performances are active participation of large number of people, who **are not traditional or belong to the period before 1815 A.D., they belong to the today's context**. How they participate in these events and method of performing involved illustrate that walking barefoot across the landscape marking network of relationships with temples, specific places, with villages, with people, landscape features, city and the river as common and significant, re-producing the place. The common methods of performing are; walking, dancing, playing music, clockwise movement/ circumbulation and repeating the events. The marking of centers and insides/ enclosed domains are significant aspects in these performances where spiritual experience is significant in all these performative processes, revealing the invisible dimensions of the place. These performances and network of relationships are reflecting on art and architecture, natural landscape and with the city and **social/cultural/religious place of the Kandyan kingdom. It is explained that city is emerged as an 'inside' within the triangular shaped valley enclosed by mountains** (De Silva,2014), re-enacting the city through network of relationships of ritualistic communal engagements, reflecting upon social/cultural/religious aspects of the place and physical dimensions of the place in material culture.

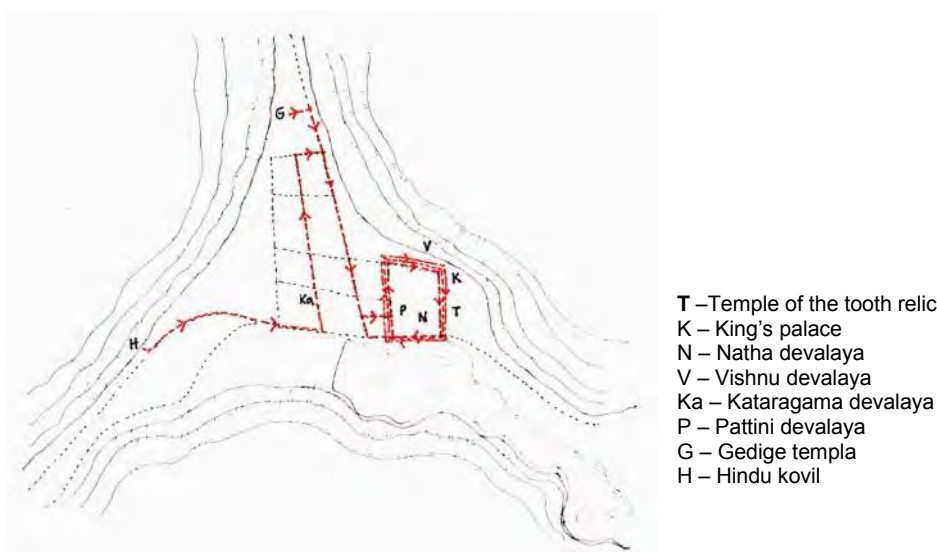

Figure 1: Revisit the city

5. RITUALIZED PLACE AND COMMUNAL EMPOWER

How repeating events of ritual behavior ritualized the place and establishing communal power of the place is evident in these performing processes.

5.1 Embodied place and communal empower

It is observed in Asala perahera the significance of body performance and methods of performance taking central role with the dynamic movement of the parade. There are a number of actions, which takes simultaneously while concentrating on the actions, such as listening, jumping high above, circling around the body, and performing and dancing according to the rhythm of hewisi, as lived practice of producing place are common and communal engagement is highlighted. According to historical documental evidences, Asala perahera is a more than cultural display and highlight body abilities and body performances, is an important clue about communal engagement and

sustainable understanding of the place through these performances. Very small children , five and six years of age take part in fire ball circling/ rotating and dancing , displaying the importance of the body in making and sensing the place and space, establish the human nature of place understanding. It is evident that inter-related network develops between the body and with the other bodies, performances, with the action, space, city and landscape producing new space and place as discussed in earlier sections.

It is evident that people experience embodied relationships between the body and the surrounding, a worldhood experience – body, action and surrounding as one spatial extension (see Table 1). In these ritual behaviors all people are engaged in the same repetitive actions of walking, dancing, playing, drumming, singing, rhyming and other activities. According to neuro-scientific explanations, a kind of sharing of sensitivity and understanding happens between bodies of people as one communal body in space, embodied in the performing place. Also the repetitive nature of these body performances strengthens the sense of place and attachment to the place, art and architecture, bounded by social/ cultural/ religious norms as important notions in sustainable approaches and authenticity of the place discussed in earlier sections.

Behavior and attitudes of performers	All of them are non-alcoholic and vegetarian during the entire ceremonial period.
Relationships between performers and perahera	Perahera performance becomes the first priority among all other commitments. People take leave from their jobs, who involve in self business temporary suspend for this period.
Their feelings about performance	They are in a great feeling of present themselves in the perahera, wherever they are, feeling of they are as part of the performance.
Feeling of body and performance	Tireless feeling of their walk and performance Feel free and less weight of the body Never fall ill during the participation period.

Table 1: Performers experiences and attitudes

5.2 Sustainability of the place

Performing Asala perahera and its experiences vibrates between myth and reality, between historical/ mythical events, stories of the place, divine experience and through direct relationship of the body with the landscape experience such as walking barefoot, sensing topography, wind and rain and bathing in river. These ritual performances are socially organized and culturally transmitted; flourishing among natural landscape, shaping the place and architecture. Ritual performance re-enact the place and strengthen the place attachment empowering the place and community. Therefore, communal empower in ritualistic behavior of Kandy city highlights the notions of sustainability of the place, its processes and manifestation of the place through performing place, experiencing invisible dimensions of the place, chora. As these places are a result of people and community engagement with direct experience of the landscape implies from inner orientation of the place, more in-depth understanding of the places, provide evidences of orientation of the sustainability of the place which is deeply rooted in the place significant with spiritual experiences.

6. CONCLUSION

The current trend 'sustainable built environment' focuses on natural environment, climate and human well-being: humans to be in harmony with nature. The methods, approaches and assessments are developing in many research areas, around the globe, focusing on the material culture, the end product. The sustainable developments as a 'process' describes direction and orientation of human needs and aspirations, while pathway approach describes where this orientation and direction could be happened in order to achieve sustainability in built environment, however, still unclear. This research proposed the phenomenology and 'performing place' concept to understand the orientation towards sustainability, utilizing performance of Asala perahera ritual festival still continues in its traditional form in Kandy. Theoretical discussions reviewed that ritual behaviour involving with producing space and place, identical with acting and making network of relationships, embodied place, and sharing bodily experience strengthened the place and place attachment among group of people, attached with invisible dimensions, chora of the place. Further, this is proved by case study and observed that even in contemporary

globalization of the world, Asala perahera in Kandy continues without any major changes and people experience the value of these performances and authenticity of the place and place attachment. The repeated events of ritualistic behaviour and communal engagement ritualize the place, empowering the place and people, highlight notions of sustainability of the place. The orientation of the sustainability of these traditional places is deeply rooted with community empower of ritual behaviour and with the place and significant with spiritual experience.

REFERENCES

- [1] **Brundtland Report (1987) 'Our Common Future' WCED.**
- [2] Borgmann, A, (1987) *Technology and the character of contemporary life*. London: Chicago.
- [3] Miller, T.R,(2013) *Constructing sustainability science: emerging perspectives and research trajectories*. *Sustain science* 8:279-293.
- [4] Leach M, Scoones I, Stirling A, (2010) *Dynamic sustainabilities: technology, environment, social justice*. London: Earthscan.
- [5] Relph, E (1976) *Place and placelessness*. London: Pion
- [6] Heidegger, M. (1962) *Being and Time*. New York: Harper &Row.
- [7] Norberg-Schulz C (1980) *Genius loci: towards a phenomenology of architecture*. New York: Rizzoli.
- [8] De Silva W(2014) *Performing Place : natural landscape, cultural place, performances of Sri Lankan traditional settlements, Kandy and Lankathilaka*. PhD Thesis, University of Nottingham, UK.
- [9] Lefebvre, H (1991) *The production of space/ Henry Lefebvre*. Translated by Donald Nicholson-Smith. Oxford: Blackwell
- [10] **Lorimer H (2005) Cultural geography: the busyness of being "more-than-representational"**. *Progress in Human Geography* 29(1) : 83-94.
- [11] Merleau-Ponty M (2002) *Phenomenology of perception / Maurice Merleau-Ponty* (translated by Colin Smith) London : Routledge
- [12] Eliade M (1961) *The Sacred and the Profane*. New York: Harcourt
- [13] Seneviratne, H.L. (1978) *Rituals of the Kandy State*. Cambridge : Cambridge University Press.
- [14] Seneviratna, A. (2009) *The Kandy Asala Perahera*. Sri Lanka: Vijitha Yapa.

Session 5.13: Stakeholder Collaboration

Green Management by Stakeholder Empowerment – The Hong Kong Housing Authority Experience

Ada FUNG^a, Irene CHENG^b, Rosman WAI^c

^a Hong Kong Housing Authority, Government of the HKSAR, Hong Kong SAR, ada.fung@housingauthority.gov.hk

^b Hong Kong Housing Authority, Government of the HKSAR, Hong Kong SAR, irene.cheng@housingauthority.gov.hk

^c Hong Kong Housing Authority, Government of the HKSAR, Hong Kong SAR, rosman.wai@housingauthority.gov.hk

ABSTRACT

Providing housing for about one third of the territory's population, the Hong Kong Housing Authority (HKHA) has committed to continuously improving the environmental standards in providing public housing and related services. With our wide spectrum of services from design, construction, to management and maintenance of our estates, apart from the endeavour of our own staff, we have empowered our stakeholders to join hand with us to promote healthy living and a green environment in our housing estates.

In the planning and design stage, we have been collaborating with the construction industry, material suppliers, and academia to research and develop environment-friendly design, green building products and construction technology. The micro-climate studies, w-trap drainage system, twin-water tank system, LED bulk-head, were some of the examples. On the other hand, we have also encouraged our staff to take initiative to innovatively develop the most suitable provisions for our stakeholders, such as the Zero Irrigation System for water saving, acoustic window or balcony to mitigate noise pollution, a two-level lighting system to reduce energy use; as well as the Carbon Emission Estimation, and energy estimation to ensure low carbon footprint design.

We also empower our tenants to help upkeep the green environment. We organised the "Let's Join Hands to Reduce Waste", Source Separation of Domestic Waste Programme, tree planting days, and developed community gardens. Since 2005, we have been partnering with Green Groups for a community environmental education programme to raise environmental awareness among public rental housing residents and to instil a culture of environmental concern.

We believe that habit change is instrumental in achieving a green living environment, and empowering the community to work in synergy is the key to its success.

Keywords: green management, stakeholder empowerment, Hong Kong Housing Authority experience

1. INTRODUCTION

The Hong Kong Housing Authority (HKHA) is responsible for producing and managing one of the world's largest public rental housing programme, helping low-income families gain access to adequate and affordable housing. Our public housing programme has been successful in providing homes for over two million people and it has been well recognized as one of the solid foundations upon which the prosperity of Hong Kong is built.

We are committed to continuously enhancing the environmental standards in providing public housing and related facilities. With our wide spectrum of services from design, construction, to management and maintenance of our estates, apart from the endeavour of our own staff, we have empowered our stakeholders to join hand with us to promote healthy living and green environment in our housing estates.

Throughout these years, we have been actively engaging our residents and the community-at-large, as well as our many stakeholders and our own staff, to join hands together in supporting, executing and underpinning the work of the Housing Authority. The result provides vivid evidence of the tremendous benefit of empowering the stakeholders in providing sustainable public housing. In this paper, we will illustrate with examples to show what we have achieved in empowering our stakeholders to provide a green and sustainable public housing programme.

2. EMPOWERING THE INDUSTRY

Starting from year 2000, we have the leverage to partner with our stakeholders in the construction industry, including the contractors, material suppliers, academia and regulators through regular meetings, participation in local/ regional/ international seminars, exhibitions, journals and conferences, to undertake research and development. These activities and discussions drive the industry to think for innovations towards greener, safer, more efficient and sustainable construction operations and system. With their support, we have been driving innovations in the use of green materials, design and site management tools, and construction systems. All these enhancements have reaped a bountiful harvest in delivering quality and sustainable housing.

2.1 Micro-climate studies

Starting from year 2004, the HKHA has been applying micro-climate studies to facilitate designers in passive design from the planning and design of all new projects in order to provide comfortable living environment in sub-tropical climate. We enhance the design, orientation and disposition of the building blocks through the optimal use of natural resources such as local wind breezes, natural ventilation, daylight and solar heat gain, by applying proven scientific technologies including computational fluid dynamics analysis, wind tunnel tests, daylight simulation tools etc. Apart from using the computational simulation tools at design stage, we also carry out verification studies to validate the results of our studies; these include model calibration and on-site measurement at the construction and post-occupation stages, applying to both outdoor and indoor public spaces for both winter and summer seasons. For major estates planned and designed after July 2006, we conduct air ventilation assessment to compare the environmental performance of different design options and select the optimal planning and design solution as required by Planning Department.

2.2 W-trap drainage system

The outbreak of SARS in March 2003 aroused public concern over the problem of dried up floor traps in the drainage system. Public health will be jeopardized due to the possible transmission of virus through these short circuits in the bathrooms/ kitchens from contaminated soil and waste stacks. HKHA in collaboration with City University of Hong Kong conducted the study on the use of Common U-traps in the drainage system in 2004. After vigorous research and laboratory tests verifying the operational stability and mock-up installation, we finally came up with the innovative Common W-trap system.

2.3 Twin tank system

Water supply interruption during tank cleansing once every 3 – 6 months often causes inconvenience to residents. Residents may need to store fresh water for temporary use or use fresh water to flush toilets during those periods. There is also considerable wastage when water remained in the tanks has to be drained away for tank cleansing. **A solution was in place with the introduction of the innovative “twin tanks system” to all new public housing projects since 2008.** Originated by HKHA, the system not only allows continuous water supply to residents during regular tank cleansing, but also facilitates maintainability and helps conserve the environment by saving water.

2.4 LED bulk-head

To further enhance the energy efficiency in lighting, we have tried some types of LED bulkhead lightings in the corridors of typical domestic floors since 2011 and have implemented a large scale of trial installation at the corridors, staircases and lift lobbies of a domestic block in Kai Tak Site 1A project in 2013. The performance of LED bulkhead lightings in these trial installations has been satisfactory.

3. EMPOWERING OUR STAFF

One of the most precious resources in the Housing Authority is our dedicated staff. We empower them to take initiatives in developing innovative ideas to serve the community. We encourage them by means of incentive schemes, awards, and provide necessary resources to assist them. In the aspect of providing sustainable housing, the followings are some examples:

3.1 Rainwater harvesting/ Root zone irrigation/ Zero irrigation system

As early as 2008, HKHA had started exploring means to harvest rainwater for irrigation to help reduce water consumption. Two pilot Rainwater Harvesting Systems (RWHS) in Eastern Harbour Crossing Site Phase 5 and Lower Ngau Tau Kok Estate Phase 1 were put into use in July 2011 and March 2012 respectively.

A root zone irrigation system has also been tried out in Kai Ching Estate with polyethylene dripping tubes wrapped with specially designed fleece to form the Root Zone Irrigation Mat installed about 100mm below soil surface. The irrigation system achieved water saving of 38% while maintaining healthy plant growth.

HKHA further devises Zero Irrigation System “ZIS” to achieve ‘zero irrigation’. ZIS is a sub-irrigation system comprising a wicking mechanism which is a self-sustained and passive design to deliver storm water stored in sub-soil retention box to the vegetation and minimize topsoil evaporation through capillary action. The system is found more efficient in water conservation and less mechanical part for maintenance when compared with RWHS. Refer to Figure 1 and 2.

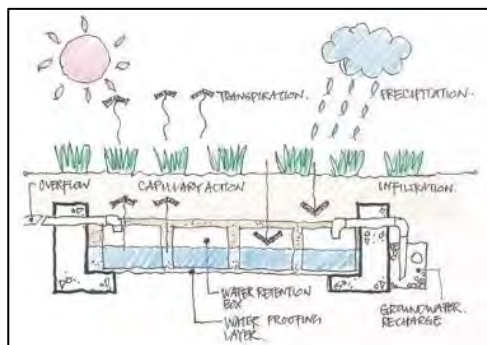

Figure 1: Illustration of ZIS



Figure 2: Construction of ZIS at trial planter

3.2 Acoustic window and acoustic balcony

Hong Kong is renowned for its high density living environment. With limited land sources, residential developments, including public housing developments, may usually be located in close proximity to heavily trafficked roads or other noise sources. To tackle the most severe noise challenge without compromising the performance of natural ventilation for the flats, HKHA has come up with the innovative acoustic windows (refer to Figure 3) and acoustic balcony design for shielding noise impact. These innovative designs could secure comfortable environment whilst maintaining the valuable natural ventilation at the living areas.

In 2015, we developed the second generation of Acoustic Balcony which amalgamates the acoustic window concept with slide screen in front of the balcony door, acoustic window plus subsisting features like sound absorptive material at the wall and ceiling of the balcony and inclined projecting panel from the parapet, all to be determined on a site-specific basis (refer to Figure 4).



Figure 3: Configuration of acoustic window

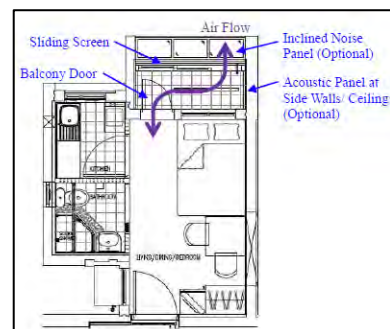

Figure 4: Layout of enhanced acoustic balcony

3.3 Precasting and prefabrication

As early as 1980s, HKHA has already been pioneering the use of precasting techniques in construction of its domestic blocks using precast facades, staircases, tie beams, refuse chutes, semi-precast slabs etc. to enhance site safety, built quality, save timber, reduce CO₂ emission and sustainability. After nearly two decades of application, we develop the Enhanced Precast and Prefabrication System in 2008. One major breakthrough achieved is the development of large scale volumetric precast components, which signifies a great advancement from planar to volumetric precasting. The invaluable precasting knowledge and experience gained in public housing developments will continue to be a prime mover for sustainable construction in the industry and will certainly contribute to the quality, saving of labour on site and sustainability of public housing developments hence better living environment for the public.

3.4 Two-level lighting system

To strike a balance between energy conservation and adequate illumination meeting the need of users at large, we adopt a 2-level lighting control system for public area of domestic buildings with illumination level maintained normally at 50 lux at lift lobbies and 30 lux at corridors and staircases around the clock, while the illumination level can be elevated to 85 lux, zone by zone, for a pre-set period of time once triggered by users on a need basis. With this control system, the energy consumption of the lighting installation can be saved by approximately 30%. This design approach is considered practicable, cost effective and environmental friendly.

3.5 Recycling and re-use marine mud

Marine mud is a stiff, moist, dark brownish grey, slightly sandy silt or clay, containing occasional small shell fragments. They have little engineering value due to its low strength and high compressibility but the disposal of large volumes of marine mud in landfill sites or marine dumping facilities is costly, time consuming and most important of all, burdensome to the natural environment. Our Structural Engineers have developed an innovative and inexpensive engineering method to re-cycle the materials, through mixing with a certain proportion of cement and granular materials, to strengthen, stiffen, and stabilise the mud. The cement-stabilised marine mud can be used for backfilling as well as turning them into eco-paver blocks.

3.6 Carbon emission estimation

Since February 2011, HKHA have conducted Carbon Emission Estimations (CEE) for all domestic blocks of new public housing developments. We have developed a user-friendly CEE methodology to holistically evaluate the carbon emission of our new public housing developments throughout the building life cycle. The CEE model consists of six aspects, namely (i) materials consumed during construction, (ii) materials for building structure, (iii) communal building services installations, (iv) renewable energy, (v) trees planting, and (vi) demolition. This provides an effective design verification tool for us to gauge the overall performance of a public housing development in terms of carbon emission throughout the life cycle of the buildings. We have achieved an estimated reduction in carbon emission of around 980,000 tonnes for the whole life cycle of these domestic blocks, representing an average of 13% reduction as compared with the baseline figure of New Harmony 1 block in terms of CFA.

3.7 Building information modelling (BIM)

In the past decade, we have devoted ourselves to integrating the use of Building Information Modelling (BIM) to enhance design efficiency, improve environmental performance, and advance the quality and safety of our built environment for the entire life cycle. With the concerted effort by staff at all levels, we have successfully integrated BIM at all stages of our work, including:

- Feasibility and planning stage – Integration of BIM and geographic information system (GIS) to facilitate a variety of studies, including visual impact assessments, ridge line, vantage point and shadow analyses as well as site appraisal studies.
- Scheme design stage - Use of BIM for site specific design and value management
- Detail design stage - Integrated use of BIM and environmental analysis software to achieve energy saving (refer to Figure 5 and Figure 6).

- Construction stage - Use of BIM for site safety and construction planning.
- Post completion stage - Use of BIM for facilities and asset management.

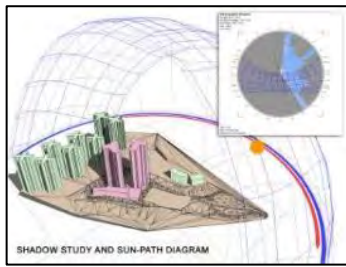

Figure 5: Daylight analysis for site specific block design

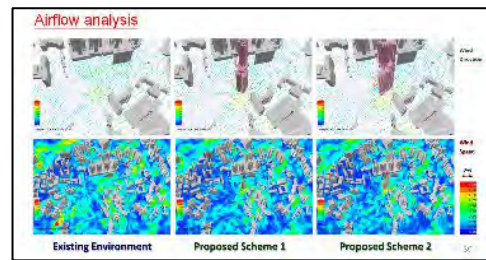

Figure 6: Testing of new software for airflow analysis

4. EMPOWERING OUR HOUSING TENANTS

Apart from the construction partners and our delegated staff, housing tenants are another important stakeholder of the Housing Authority. After all, they are the end-users to enjoy the green living we provide. We empower them to upkeep the premises and make themselves their own master in building a healthy and happy life in the estates. **To achieve this, we partner with the tenants' association, the Estate Management Advisory Committee (EMAC),** as well as local Non-governmental Organisations (NGO), schools, to organise green activities engaging estate tenants.

4.1 Green delight in estates

Since 2005, we have been partnering with green groups for the "Green Delight in Estates" (GDE) programme, which aims to raise environmental awareness among Public Rental Housing residents and to instill a culture of protecting and improving the environment.

There are also in-depth educational and promotional programmes for about 30 selected PRH estates each year which focused on special themes and activities, such as green living carnival, green living quiz competition, flower bed design competitions, waste reduction and recycling, waste separation at source, etc. The in-depth programmes have eventually covered all existing PRH estates and we have trained up over 15,000 green ambassadors who are volunteers within the estates to spread environmental messages to other tenants.

Various activities have been well received by the estate tenants, Estate Management Advisory Committees, local schools and Non-Governmental Organisations and the programme has raised the environmental awareness of the tenants and improved on their environmental habits.

4.2 Waste separation and recovery

Since 2005, HKHA have been actively implementing a number of waste management programmes across our PRH estates, including the Source Separation of Domestic Waste Programme. To facilitate our collection of recyclables, collection points have been established in all PRH estates. Tenants are encouraged to bring recyclables to the collection points in exchange for cash or daily household items.

4.3 "Let's Join Hands to Reduce Waste in Our Estates" campaign

From July to December 2014, we launched a campaign "Let's Join Hands to Reduce Waste in Our Estates" in all PRH estates. A series of activities engaging our tenants were arranged to encourage reduction of municipal solid waste. We have also engaged Non-governmental Organisations (NGOs) and other government departments in organising environmental activities. For instance, we sponsored the venues for the Waste Reduction Campaign held at Domain, our biggest shopping centre, in September 2014 to line-up tenants of restaurants and supermarkets to adopt food waste reduction and management practices. With all these activities and campaigns, our residents generate 30% less domestic waste than HK average (refer to Figure 7).

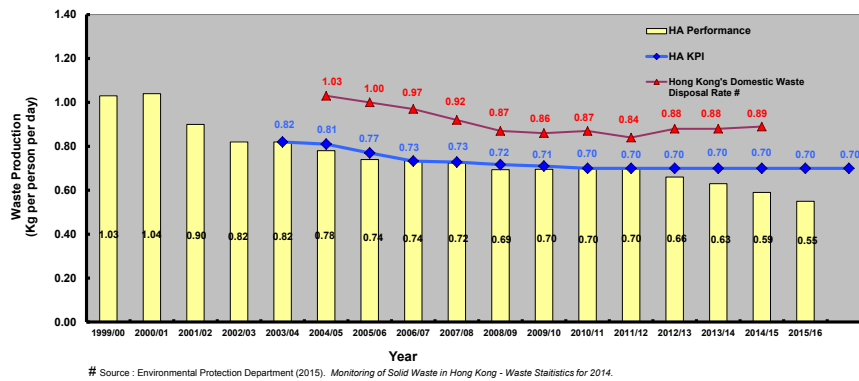

Figure 7: Average domestic waste production

5. CONCLUDING REMARKS

The roles and functions of Housing Authority are unique in many aspects which spread from design, construction, maintenance and management. To provide sustainable housing that can be enjoyed by about two million people, environmental awareness and habit change of our stakeholders are instrumental in achieving a green living environment. With engagement of the residents in the planning and design of our estates, the Customer Satisfaction Index for our newly occupied projects is continuously on the rising trend, reaching 95% in 2014/15 (refer to Figure 8). We cannot work alone as the effect will be limited; we believe that empowering the community to work in synergy with us is the key to its success.



Figure 8: Customer satisfaction index

REFERENCES

- [1] Hong Kong Housing Authority, 2016. Building Green for the Community, Sustainability Report 2014/15. Retrieved from: <http://www.housingauthority.gov.hk/mini-site/hasr1415/common/index.html>
- [2] Wai,R.(Ed), 2011. Planning, Design, and Delivery of Quality Public Housing in the New Millennium. Hong Kong: Hong Kong Housing Authority

CoLLaboratoire Montreal: Living Experiments for Climate Change Awareness

Carmela CUCUZZELLA^a

^a Design and Computation Arts, Concordia University, University Research Chair IDEASBE, L.E.A.P, Canada,
carmela.cucuzzella@concordia.ca

ABSTRACT

This paper introduces a new research initiative called CoLLaboratoire, a community embedded project with the goal of realizing a series of art-architecture installations that communicate some critical theme of sustainable living in the city. This project links together academics, students, community, and business leaders to address sustainability challenges together. It therefore serves as a medium for transdisciplinary scientific research requiring citizen-engagement while also creating a measurable impact with regards to sustainable living.

The goal of this initiative is to stimulate Montreal's collective intelligence by recovering memories of place and environment while serving as a model project of a sustainable city. CoLLaboratoire has adopted the urban corridor of Sherbrooke Street, a street that runs 31km from east to west in the city of Montreal, Canada. This research project has been adopted as an organizing principle for these urban installations, where each public art piece will have its own story. The resulting narrative from the collection of installations along the length of Sherbrooke Street will be at once, educational, interactive and experiential. The intent is to foster public awareness of natural systems and resilient urban infrastructures through community engagement, both during the design process and during the use of the public artwork after it has been installed. This may have the benefit of invigorating life in the city while **addressing pressing problems of today. By using one of the city's main east-west axis** we can disseminate the idea of context-specific sustainable living throughout the various communities.

In this paper, we will present our first design challenge/experiment in Montreal, in terms of its process, its outcome and our analysis. This project's main research questions are: What type of art-based installations can help heighten community awareness to issues, questions, or solutions regarding climate change? How can participation in the design of these art installations contribute to a deeper understanding and embodiment of sustainable practices for participants in the long term?

Keywords: sustainable neighbourhood, design process, community empowerment

1. INTRODUCTION

CoLLaboratoire is a research-creation initiative, which started on September 2014, in Montreal, Canada. The aim of this project is to better understand how the collaborative design of public art-architecture installations can contribute to a critique, deeper understanding and/or embodiment of sustainable urban, professional, community, and even human practices in the long term. It focuses on the design of art-architecture for public spaces as a practice in which the resulting representation and narrative can contribute to today's imperative questions by pushing its disciplinary boundaries.

Through design experimentation, citizen engagement, and the construction of working prototypes installed in Montreal, these designs are intended to lead to scalable and measurable environmental benefits, such as green energy and food production, water conservation, greater community involvement, etc. It is a project under the auspices of the Concordia University Research Chair Integrated Design, Ecology, and Sustainability for the Built Environment (IDEAS-BE), of which I am chair. This research project is also directly related to the worldwide initiative called Future Earth. Future Earth is a global platform for sustainability research serving as a vehicle for communicating knowledge between sustainability sciences, business leaders, policy makers, and community leaders. The location of the United Nations Future Earth global secretariat is in Montreal. Montreal, a UNESCO city of Design, with its hybridity of cultures, languages, urban dynamism, and its leading place in the history of sustainability, is a fertile place for such an experiment in sustainable living.

Through this initiative we are planning, designing, and building public space urban installations with the intent of heightening climate change awareness, while also building capacity in citizenry to address issues together. The aim is to successfully make connections between academics, community members, artists, designers, architects, professionals, and business leaders, etc., in order to better address sustainability challenges. This research project has the inherent benefit of communicating the research directly to the community involved, and therefore also acts as an outreach project.

All installations are context sensitive, taking into consideration the concerns of the community in which they are intended. CoLLaboratoire has adopted the urban corridor of Sherbrooke Street, which runs 31km east to west across the city of Montreal in Canada as an organizing principle for all urban interventions and/or installations. This iconic Montreal street runs from the Parc Delphis Delorme and Paroisse Marie-Goretti nature area in the east to **just west of Concordia University's Loyola Campus in Montreal Ouest**. Along this corridor we will identify roughly 12 sites or hubs for artistic-architectural installations and interventions. The resulting narrative from the collection of these designs along Sherbrooke Street will be at once, educational, interactive and experiential.

One of the main goals for CoLLaboratoire is to stimulate Montreal's collective intelligence by recovering memories of place and environment and to serve as a model project of a sustainable city. These interventions serve as elements of a path to a sustainable, resilient future. In addition to the creation of site-specific interventions, we expect the broader societal impacts of this project to include greater networks for mobilization at the community level, better public understanding of solar energy, concept development for potential product commercialization and toolkits for effective participatory design.

The research questions that are at the core of this research project are: What type of art-based installations can help heighten community awareness to issues, questions, or solutions to climate change? How can the inclusion of the community in which the installation is embedded contribute to a deeper understanding and embodiment of sustainable practices for the long term? Specific installation sites are constantly investigated based on their historical importance, natural features, availability, and future possibilities. The site for our first design challenge was Concordia University's Loyola campus, which sits on the far west end of Montreal. We selected this site because we wanted the community of students, especially at Concordia to be deeply involved in our inaugural design challenge.

This paper is organized into three main sections. We will first introduce the historical context and theoretical canvas for CoLLaboratoire. Here we consider the transdisciplinary approach of designing art-architecture for the public realm. We will then present the details of our first design challenge on the Concordia Loyola campus, in terms of the process we adopted, the projects resulting from the design challenge, and our analysis. We conclude with insights on this first experiment and suggest a variety of ways forward.

2. THEORETICAL BASIS OF RESEARCH PROJECT

Although the scientific discovery of climate change began early in the 19th century when changes in the climate were first suspected, these ideas were met with disbelief at the time. It was becoming known only in the late 1950s and early 1960s that questions of human emissions were causing not only environmental degradation but were also disrupting climates around the world. It was at this time that radical designers entered the conversation of environmental degradation.

Since the 1960s designers have been ardently working towards addressing the complexity of the pressing questions of their time. The discourses related to environmental design started at this time, and have shifted since. In the 1960s, the drive towards holistic approaches of public and individual human settlements gave rise to the idea of environmental design, as a mean to transcend the boundaries between various design disciplines: architecture, landscape, urban and product design. **This first "environmentalism" culminated, amongst other manifestations, in the formation of the *Environmental Design Research Association (EDRA)* founded in 1968**. In the 1970s, environmentalism started to shift towards an ecological ideology soon dominated by technical solutions. This coincided with the energy crisis and so environmental design soon shifted from a holistic approach to the search for new methods that would help designers reduce energy used in all phases of their designs. This technological turn was driven by highly structured principles, many of which were in the search for ever-more efficiency.

At the turn of this century, the technological emphasis for efficiency systematically developed throughout the 1980s and 1990s, started to reveal its limitations. The limitations faced by the emerging methods and tools developed specifically at the time to address both global and local environmental degradation can be categorized in three general areas. First, the prescriptive or normative nature of the tools being developed left little room for profound exploration in innovative solutions. We have seen in our previous researchers on large-scale sustainable projects, that it is the tried and tested proposals that go ahead rather than the experimental. Second, their predisposition to fragment the given problem through very rigorous and numerous analyses tools for the various portions of the project, resulted in very little or no thought given to the encompassing situation. This disconnectedness between the analyses of the many parts and the whole project was problematic especially in terms of synergies and of coherence. Third, the profound problems facing humanity at the time could not be solved through technology alone, since questions of the social or cultural conditions could no longer be ignored.

Facing a problematic integration of both social and cultural dimensions, this approach revealed a contradictory opposition between form and meaning, between aesthetics and ethics, between process and content [6]. Numerous scholars now underline that these missing inter-subjective dimensions may be compromising the very idea of a holistic environmentalism in various realms of knowledge and action. Such is the case in the design disciplines, where a series of paradoxes are being identified at varying scales. We focus on three paradoxes related to how design today deals with environmental degradation and climate change mitigation. These three paradoxes are:

- Human behaviour is hardly considered in environmental evaluations yet behaviour is at the core of environmental degradation and specifically resource consumption;
- Predicted performance measurements of design projects rely on managerial and eco-deterministic approaches, yet there is a large gap between these promises based on best case scenarios and actual performance; and
- Representations of 'green' design are often added to spaces or buildings to communicate the 'greenness' of these projects rather than integrating actual effective environmental processes or characteristics not necessarily visible to the general user if these spaces or buildings.

An example demonstrating the first paradox is when smart buildings are adopted as a way to design energy efficient buildings. The 'intelligence' designed into the buildings is often quite disconnected from actual human behaviour, to such a point that energy promises at the design phase, are rarely met at the post-occupancy phase.

An example demonstrating the third paradox is that it is commonly observed that some uses of solar panels have more to do with communicating (green) than actually reducing environmental impacts. This phenomenon has been observed in contemporary Canadian public spaces, where there is evidence that designers tend to bypass the race for efficiency through strategies of communication.

It has now become critical to better understand how the dominant doctrines of managerialism, environmental efficiency, eco-determinism, among others, as systematic approaches, are resulting in a series of contradictions **and 'demonstrative devices' which influence collective intelligence while deceiving the public that real action** has been taken.

Today the question of climate change and its projected catastrophic impacts worldwide requires a rethinking of some of the predominant international discourses and approaches, so that human behaviour and collective intelligence regarding issues of climate change becomes a priority rather than a residual thought. Our hypothesis states that the critical and reflective design of art-architecture installations for the public space can address collective intelligence for the longer-term by helping to shift human behaviour. The CoLLaboratoire research project is focused on this approach.

3. INAUGURAL DESIGN CHALLENGE OF COLLABORATOIRE

For the inaugural experimental design challenge, CoLLaboratoire organized a design competition open to only young designers, artists, architects, creative or critical thinkers, and therefore preferably students. We heavily targeted our own students at Concordia University since the site of first design challenge was the Concordia University Loyola campus. The challenge called for an augmented bus shelter that students can use during the

week as a bus shelter, but would have an augmented program during evenings, weekends and especially the summer. Solar energy was to be used in the project in creative ways, for collecting, storing, using, as well as displaying a variety of metrics to users of the shelter. The projects were expected to consider the role of public art and design in increasing awareness of, and engagement in, issues around climate change at the local level.

This competition was anonymously judged. The jury was made up of an art historian, a gallery director, an expert in solar energy, two architects, an interdisciplinary designer, and a doctorate candidate in sustainable business practices comprised the jury. A public vote was also included in this challenge as a way to get the members of the community involved in the conversation.

The main criteria for the challenge was the following:

- Imaginative shelter design (form, materiality, spatial qualities, etc.);
- Innovative interpretation of the idea of 'shelter' for the Loyola campus site;
- Incorporate solar energy and provide details of its use;
- Consideration on how the impact of your project might be measured over time (eg.: the number of mobile devices being charged per day using the solar power).
- The maximum allowable budget for the project build-out is \$23,000.

Anonymity was ensured since all young contributors to the challenge had to preregister and obtain a code to include on their design panels. Because of the requirement of solar energy and the creative interpretation of the shelter, multi-disciplinary teams were highly encouraged.

3.1 Results from design challenge

This first design challenge was launched on April 2016. In this challenge, which was geared towards young designers only, we received 26 design proposals from Brazil, Canada, France, Iran, and USA. Three proposals were selected as originally announced, but the jury decided to add two honourable mentions. We present a short description of the awarded projects.

The first prize went to a project that displayed a bold architectural proposition, with an elaborate, yet clear reinterpretation of the 'bus shelter'. The solar panels could be integrated into the floating canopy, which glows at night. The proposal collects energy in order to create a night-time beacon, providing a feeling of security for users of the shelter over the darker months of the school year.

The second prize also proposed a poetic gesture for the site, alluding to a lighthouse in its design. The proposal, which included the addition of a subtle installation for social gathering adjacent to the original, refurbished shelter had great symbolic potential as a landmark.

The third prize was innovative in form and composition and extended the program of the bus shelter by proposing a structure that might also be useful as a weekend market. The proposal stood out for its distinctive, flexible form.

The two honourable mentions were selected for their pragmatic approaches. One of these doubled the capacity of the shelter, thus allowing for an extended interior program, such as the inclusion of a sharing library within the shelter. The second designed a series of modular shelters that can be combined in a variety of permutations to increase the capacity of the shelter while revealing perhaps too directly the solar technology.

With the winning project selected, a supervised design process is now ongoing. The winning team is currently collaborating directly with research groups, researchers and students from Concordia University, as well as other professional bodies in order to construct the project for the summer of 2017 on the Loyola Campus of Concordia University. The construction of the winning project is expected to begin by in early spring of 2017 for a completion date by August 2017. The launch of the constructed project will be done concurrently with the 375th Montreal celebrations in 2017.

4. DISCUSSION OF RESULTS OF CHALLENGE

With 26 projects submitted to this design challenge, the diversity was high and therefore the selection of the winning project was difficult since the criteria had to be reinterpreted for each special case. The projects can be categorized into a series of polarities, which ranged from:

- Projects that chose to focus on symbolic gestures to those that were completely pragmatic in their approaches;
- Easily buildable projects to overly complicated parametric designs - let's keep in mind that the competition was for a bus shelter;
- The visible exhibition of solar panels on elementary architectural forms to the elegant use of new solar technologies inconspicuously concealed in clean forms;
- Projects that focused on sites and their spatial compositions to projects that focused on the composition of the artefact (bus shelter) alone.

The winning project provided a symbolic gesture, that is buildable, with solar panels obscured in the materiality of the canopy, focusing on the spatial qualities of the site while also the designing an artefact that can act as a beacon for the entrance of the university. It also proposed a playful and theatrical lighting approach for displaying the level of energy stored, used and left in the shelter.

The theatricality of this gesture for displaying such dry information allows reaching a broader spectrum of users of differing ages, backgrounds, etc. The designers provide a shelter that is didactic and interactive, informing the user of the energy saved from the grid. As the user activates the elements that use the stored solar heat, they will immediately see the indicators of stored solar energy decrease. This playful gesture is meant to communicate to the users, or the passer-by as to the solar energy that is being collected, stored, and used on a daily basis for cooling, heating or charging portable devices.

Furthermore, the clever manner in which the solar panels (harsh engineered components) are concealed in the canopy of the shelter presents two key outcomes: (1) the clean integration of effective environmental processes is possible; and (2) the expression of 'sustainability' or 'green design' does not equal green design, since the winning design is not embellished with demonstrative environmental gadgets.

The winning project addresses the main goal of CoLLaboratoire, which is to recover memories of place and environment and to serve as a model project of a sustainable city.

5. CONCLUSION

This first inaugural project for CoLLaboratoire helped reflect on how architecture and more broadly, spatial practices, through its autonomous structures, formal procedures and even representational approaches, enables designers to expand out towards other discourses such as virtual technologies, sustainability, spatial practices, in order to address pressing questions of today, such as climate change issues. This project allows architects to bridge the gap between different modes of knowledge, and this is especially evident in practices of sustainable architecture. This project is also key in highlighting its contribution to the expansion of today's architectural interdisciplinary practices.

This community-academic experimentation through public art-architecture installations, helped in finding unconventional ways to allow designers and community to better reflect on questions of climate change. Such a project may also bring to light some of the contradictions of the prominent practices of what is termed 'sustainable' design today - but this is only observable once the installation is adopted and used by the community over the course of the next few years. So such a project is not only a cultural production for the community, it also is a living lab, a dissemination project of innovative technologies and uses of technologies. Such a critical practice is key to help bridge the gap of collective intelligence so deeply needed for moving towards sustainable cities.

REFERENCES

- [1] FULLER, R. B. 1968. *Operating Manual for Spaceship Earth*, Lars Muller Publishers.
- [2] SANOFF, H. & COHN, S. (eds.) 1975. *Edra 1 / proceedings of the 1st annual Environmental Design Research Association conference*, Stroudsburg, Pa.: Dowden, Hutchinson & Ross.
- [3] JONAS, H. 1979. *Toward a Philosophy of Technology*. The Hastings Center Report, 9, 34-43.
- [4] FLETCHER, K. T. & GOGGIN, P. A. 2001. The Dominant Stances on Ecodesign: a Critique. *Design Issues*, 17.
MADGE, P. 1997. *Ecological Design: A New Critique*. *Design Issues*, 13, 44-54.
- [5] CUCUZZELLA, C. 2009. The Limits of Current Evaluation Methods in a Context of Sustainable Design: Prudence as a New Framework. *International Journal of Design Engineering*, 2, 243-261.
PAPANEEK, V. 2000 [1971]. *Design for the Real World: Human Ecology and Social Change*, Chicago, Academy Chicago Publishers.
ROSSI, M. 2004. *Reaching the Limits of Quantitative Life Cycle Assessment*. Clean Production Action. European Commission.
- [6] BROUWER, J., MULDER, A. & SPUYBROEK, L. (eds.) 2012. *Vital Beauty : Reclaiming Aesthetics in the Tangle of Technology and Nature*, Rotterdam: V2 Pub: NAI.
FRY, T. 2009. *Design Futuring: Sustainability. Ethics and New Practice*, New York, BERG Publishers.
- [7] FISHER, T. 2008. *Architectural Design and Ethics: Tools for Survival*, Architectural Press, Elsevier.
SPECTOR, T. 2001. *The Ethical Architect, the dilemma of contemporary practice*, New York, Princeton Architectural Press.
- [8] TUKKER, A. & TISCHNER, U. 2006. Product-services as a research field: past, present and future. Reflections from a decade of research. *Journal of Cleaner Production*, 14, 1552-1556.
- [9] VON SCHOMBERG, R. 2002. *The objective of Sustainable Development: are we coming closer?* Foresight Working Papers Series, Serie Documents de Travail Prospectifs, N°1. European Commission, Directorate General for Research, Unit K-2 Science and Technology Foresight.
YUDELSON, J. & MEYER, U. 2013. *The World's Greenest Buildings: Promise Versus Performance in Sustainable Design*, London, Routledge.
- [10] CUCUZZELLA, C. 2015. Is Sustainability Reorienting the Visual Expression of Architecture? *Revue d'art canadienne / Canadian Art Review (RACAR): Design Studies in Canada (and beyond)*, (editors) Keith Bresnahan, Brian Donnelly, Martin Racine, 40, 86-100.
HOSEY, L. 2012. *The Shape of Green: Aesthetics, Ecology, and Design*, Washington, Island Press.
- [11] PICON, A. 2015. *Smart Cities: A Spatialised Intelligence*, Wiley.
- [12] BASA, I. 2009. Environmental discourse of architecture. *International Journal of Environmental Studies*, 66, 271 - 279.
- [13] CUCUZZELLA, C. 2015. Judging in a World of Expertise: When the Sum of the Parts is LESS than the Whole. In: CHUPIN, J.-P., CUCUZZELLA, C. & HELAL, B. (eds.) *Architecture Competitions and the Production of Culture, Quality and Knowledge: An International Inquiry*. Montreal: Potential Architecture Books.

Putting Regenerative Development into Action: Understanding the Decision Making Process of a 680 Hectare Regenerative Project

Dominique HES^a, André STEPHAN^b, Sareh MOOSAVI^c

^a The University of Melbourne, Australia, dhes@unimelb.edu.au

^b The University of Melbourne, Australia, andre.stephan@unimelb.edu.au

^c The University of Melbourne, Australia, sareh.moosavi@unimelb.edu.au

ABSTRACT

The built environment is responsible for significant environmental impacts. It is therefore a central research area to balance ecological and built systems and allow them both to thrive. While the majority of previous and existing attempts have targeted minimising environmental impacts, regenerative development goes beyond reduction and aims to restore and support environmental, social and economic flows. Yet, very few projects to date have been able to demonstrate a regenerative outcome. This is because few consulting firms currently offer regenerative design thinking, which is in turn linked to a lack of understanding of processes that support decision making in regenerative development projects. This paper uses a 680 hectares regenerative development project in Gippsland, South East Australia as a case study to investigate how implementing a regenerative development approach from the onset affects the decision-making process. A series of workshops were facilitated by the authors with the local community, indigenous elders, design experts, academics, scientists, government and industry partners and other stakeholders. An online survey consisting of 10 questions was sent to the 40 actors involved and 28 responses were collected (N = 28 and a response rate of 70%). This study provides a contribution to the understanding of both the processes that can support the implementation of innovative regenerative concepts in the built environment and their benefits. It covers aspects ranging from the personal motivation of participants, to the performance of the workshops in facilitating a regenerative design. The knowledge gained from this study will inform the future use of regenerative development and associated facilitation tools.

Keywords: regenerative development, design process, sustainable neighbourhood

1. INTRODUCTION

The built environment is responsible for a significant portion of the environmental impacts humans are having on the planet. Yet the built environment is critical to human development. How do we reconcile this when past practice has always privileged human progress above ecological (Steffen et al., 2007). The solution to this is to understand the interconnected nature of our planets systems (Pretty, 2011). In the long term humanity will only thrive if the systems on which it depends thrive. As such our built environment should be designed to support the viability and vitality of social and ecological systems and enhance the ability to adapt constructively to change. That is, cities designed to provide net ecological and social benefits; no longer minimising environmental impacts but actually aiming to heal, connect and strengthen them. An approach to doing this is termed Regenerative Development, which aims to restore and support environmental, social and economic flows.

This contributive approach to designing the built environment is relatively new with very little long term research underpinning it. It has been practiced by a few consultants internationally (Mang and Reed, 2012) and case studies found on practitioner pages from Regeneration and Institute for the Built Environment (IBE), Colorado State University) but rarely as part of a research led process. While regenerative practices provide insights into the outputs of regenerative development projects; there is a need to better understand the process that supports regenerative thinking by contrasting it to business as usual.

The aim of this paper is to evaluate the experience of stakeholders during a regenerative design charrette facilitated using LENSES and applied to a large scale regenerative development proposal: Seacombe West, Gippsland, Victoria, Australia. This contributes to our understanding of the process of regenerative design and the effectiveness of facilitation tools such as LENSES. LENSES is a framework which supports design thinking towards regenerative goals. There are other tools or frameworks used by Regeneration, and it could be argued that any consultation process could incorporate regenerative outcomes, if the underpinning ecological thinking is present. That is, thinking that determines the potential of place, looks that the flows that bring a place to life, enables design

to enhance the relationships between flows and the place and therefore the ability for a place to be more resilience and to constructively adapt to change (Hes and du Plessis 2015). The LENSES framework was chosen as it nicely support this approach to regenerative development.

1.1 Site

Seacombe West is a proposed 680 hectares (6.8 km²) development on Lake Wellington (or Murla in the Gunai aboriginal language), the largest of the Gippsland lakes in Victoria, Australia which cover 340 km² (Roberts et al., 2012). Some areas along the lakes are protected under the Ramsar convention (Ramsar, 2016) and other wetland and birds protection agreements. The Gippsland lakes are therefore a significant natural feature and generate a large economic activity, mainly in terms of agriculture and tourism. However, these lakes were artificially connected to the sea at Lakes Entrance in 1889 and since then the salinity of their waters has steadily increased. While Lake Wellington is the least saline of the three lakes, its salinity is increasing and its biodiversity has simultaneously declined over the last decades. Salty flood waters have also blighted the Seacombe West site which can no longer fulfil its past ecological or farming functions. The owners of the site decided to regenerate the site through a development that would provide stable habitats while also regenerating its ecological functions and enhancing its socio economic activity.

2. METHOD

This section presents the LENSES regenerative development framework assessed. The overall research strategy and the project timeline are also described before detailing the survey used to assess the facilitation process.

2.1 Case study and LENSES description

LENSES stands for Living Environments in Natural, Social and Economic Systems. Plaut et al. (2012) state that **LENSES aims 'to facilitate tangible, actionable and contextually based solutions that support and create healthy, natural, social and economic systems'**. Error! Reference source not found. shows that LENSES is represented by three overlaid lenses. The outermost lens (the Foundation Lens) outlines the guiding principles of the project. The intermediate lens (in blue) is the Flow Lens and represents the flows across the project. These can be physical or abstract. Both the flows and the guiding principles of the project have been defined by the stakeholders during Workshops 1 - 3 (see Figure 1). In the centre of the framework lays the Vitality Lens which includes the two spheres of degenerative and regenerative design and incites a workshop participant to focus on regenerative outcomes for each flow. Artefacts of this model are generally printed or made for workshops. This visual representation is a tool that helps structure the thinking during the workshops and allows the stakeholders to have all the key flows and principles in an organised manner.

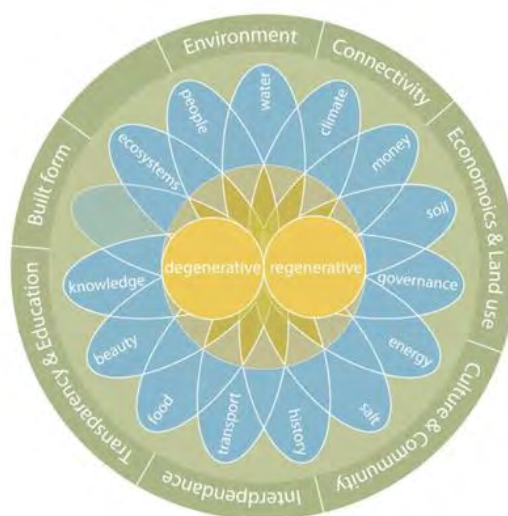

Figure 1: Visual representation of the LENSES framework

Beyond its visual representation and ability to organise thoughts and information, LENSES focuses on systems thinking, allowing regenerative outcomes to emerge. Stakeholders develop their own lens during the initial workshops and then use the resulting model to guide the design charrette. LENSES has been used to drive regenerative outcomes in multiple projects (including for town planning, building design, education, personal growth, organisational development and others). However, there is limited information about how participating stakeholders perceive LENSES and judge its effectiveness. The next section describes the research method used to evaluate this aspect.

2.2 Overall research strategy

The authors have led and organised a series of workshops with key stakeholders of the project in order to facilitate regenerative thinking from the early stages of design. The results of the each workshop were carried forward to the next as depicted in Figure 2. The workshops are described in more detail in Section 2.3.

As shown in Figure 2, this paper focuses on the evaluation of the workshops facilitated using the LENSES framework. This evaluation was conducted through an online survey (described in Section 2.4) and additional interviews with stakeholders. The survey and interviews are designed to extract as much information as possible on the effectiveness of the LENSES framework and how different it is from business as usual. Only the survey results are analysed in this paper due to a lack of space.

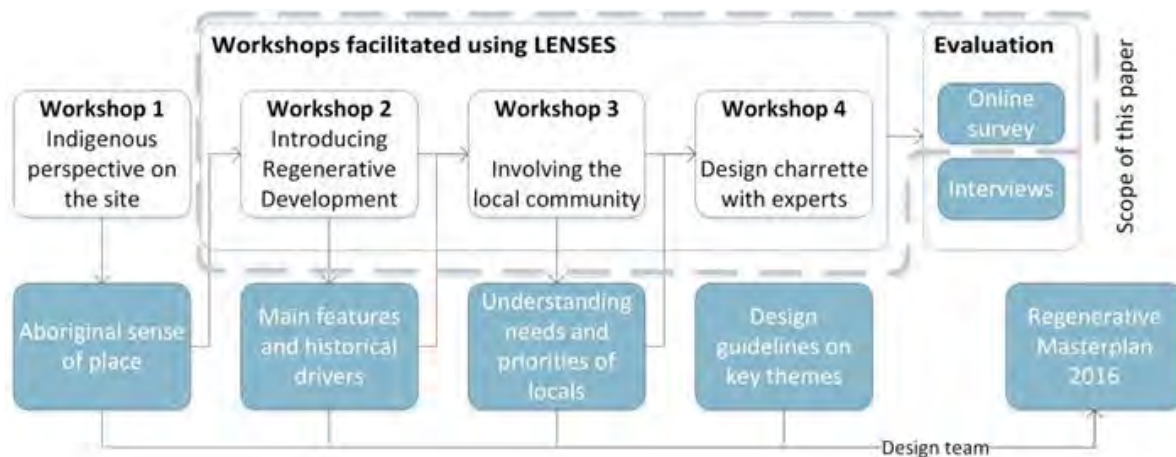

Figure 2: Overall process of the project and scope of this paper

2.3 Project timeline and workshops description

Table 1 is a summary of the process used to integrate regenerative development principles in the design process. Based on the LENSES framework it was critical to first understand the story of place and the context of the project in order to identify the principles that the project would be designed to. This context included a timeline of the site with inputs from the local community, government, and Indigenous participants. The following step was to determine the flows that brought this site to life, and identify potential flows that can create resilience and adaptive capacities for social and ecological systems. The resulting LENSES artefact was then used to inform the two days charrette workshop. The outcomes of all of these were fed into the final design process, the resulting master plan and details for implementation.

WS/ event	Aim	Stakeholders	Activities	Outputs
2015 – Prework – at the site around the room table	Identify the principles of the project	land owners	Used the Vitality lens Discuss shift from degenerative to regenerative design; and foundation lens develop an initial understanding of regen. development principles	Key principles: Interdependence Stewardship Respecting limits Partnership Transparency and education
2016 Jan –	Team formation	group of researchers	Shares the potential of the project for a research grant from Carlton Connect.	Received grant
2016 Feb WS1 – at the UoX	Cultural Awareness Training	The initial design team	Team taken through Indigenous history and design; and, the way to be sensitive and effective communicators to the Indigenous community.	Deeper understanding of inclusion and potential, we also started using the Indigenous timeline as basis for the history of place activities.
2016 Feb WS2 at the UoX	LENSES and Regen training	The initial design team	Three hours introduction to regeneration (Vitality) and the LENSES process, and started the Flows Analysis through a history timeline activity (Flows)	Shared understanding of the potential of the site and the regenerative design process
2016 Feb site visit	Site familiarisation	design team and researchers	A whole day visit of the site – visited 4 areas of the site and collected drone footage	Ability to connect to the issues of the site, input into the flows lens
2016 March WS3 onsite	Community input and site visit	Community – with wine and cheese – around 20 participants	site visit, followed by a two- and-a-half-hour workshop around: “What is important to the community?”	Ability to connect to the issues of the site, input into the flows lens
2016 March WS3 at the local council	Community and government input	Community, government and design team – 12 participants	Repetition of the above with an additional three hours workshop: “What are the critical flows and relationships we need to develop to ensure the place has the potential to thrive?”	Ability to connect to the issues of the site, input into the flows lens – this finalised the principles, and flows lenses
2016 April/May – design several	Integrate regen thinking into the design	Design team	Develop design concepts and finalizing principles and flows	Initial design ideas
2016 April WS4 at UoX - 2 days	Design concepts for the project	40 industry and research experts	Developed regen. ideas integrated across building, infrastructure, ecosystem, water, land, governance, community & innovation.	Participants identified opportunities and gaps in the knowledge to further inform the research agenda

Table 1: Description of the workshops' aims, participants, activities and final outputs. Note: WS: Workshop, UoM: University of xxxx

2.4 Survey description

In order to evaluate LENSES an online survey was conducted with the stakeholders that attended the workshops. The survey consisted of ten questions (see Appendix A for the entire survey):

- 2 questions regarding the role of the stakeholders and their attendance;
- 3 Likert-scale (7 options) questions on personal gain from the workshops, the project's benefit from the workshops and the stakeholder's understanding of regenerative development;
- 4 open-ended questions that cover personal gain, defining regenerative development, the benefits of LENSES and the potential improvement to the facilitation process with LENSES: and
- 1 Likert-scale (5 options) with 9 sub-questions evaluating the performance of LENSES on a range of indicators.

The survey was opened to participants from the end of Workshop 4 (12/04/2016) and closed on the 31/05/2016. Participants were encouraged to participate and were reminded twice by email. Although, participation in the survey was facultative, 28 responses were collected out of 40 stakeholders involved in the workshops (most of whom were present during the design charrette or workshop 4). The resulting response rate of 28/40 = 70% is relatively high. However, the sample size is not statistically significant and this is further discussed in Section 4. All survey questions were approved by an Ethics committee and all participants were informed of the project, data collection and survey participation through a plain language statement distributed during the workshops as well as face-to-face explanations.

3. RESULTS

The 28 responses received for the survey included 3 architects (11%), 7 engineers (25%), 6 scientists (21%), 2 community members (7%) and 10 other (36%), which mostly included consultants (4/10) and academics (3/10). The large majority of respondents participated in Workshop 4 (86%) and some participated in Workshop 2. Regarding personal gains (Q3 and Q4), 61% responded that the workshop was useful (5/7 on the Likert scale) followed by 25% responding that it was essential (6/7 on the Likert scale). The average was 5.1/7 with a standard deviation of 0.96, revealing that respondents felt they benefited personally from attending the workshop(s).

The free comments revolved mostly around the interdisciplinary nature of Workshop 4 and the positive exposure to LENSES. The respondents felt that the project gained useful (5/7 on the Likert scale) to essential (6/7 on the Likert scale) value from the workshops (Q5). On average, they rated the added value 5.5/7 with a standard deviation of 0.79. This shows that most participants valued the inputs of LENSES.

Most respondents felt that they understood regenerative development in Q6 (14% a little (4/7), 39% enough (5/7) and ~46% a lot (6/7)). When asked about defining regenerative development (Q7), some of the most recurring words used included environment (11 responses), positive (8 responses), system (7 responses) and human (5 responses). Overall, respondents were seemingly satisfied with the performance of LENSES.

Answers to Q8 (see Figure 3) present averages ranging from 3 to 4 (over 5) across the different aspects evaluated. The lowest average score was attributed to the capacity of future proofing the development while the highest score was linked to its support for cross disciplinary collaboration. When asked about the benefits of using LENSES (Q9), **a strong focus was made on its ability to discuss the topic broadly, providing a more "holistic approach"** (Respondents 10 and 22). The most used words by the respondents included, different (7), flows (5), thinking (5), understanding (4) and relationships (4), highlighting some of the key features of regenerative development (see Section 1). The major limitation of the process and what could be improved in the view of most respondents (Q10) was the amount of time provided to better understand the LENSES framework. This is highlighted by the word time appearing in 10 different responses.

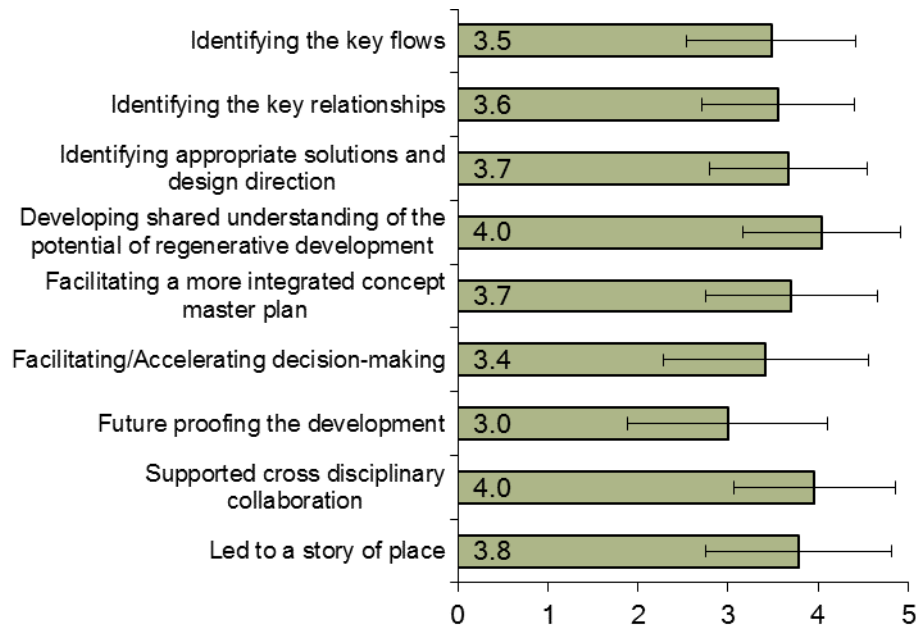

Figure 1: Answers to question 8 of the survey on a scale from 1 to 5, can you score how well you felt the following parts of the workshop, including the LENSES framework worked?

4. DISCUSSION AND CONCLUSION

Designing a community such as Seacombe West regeneratively requires systems thinking and designing with the express intention of creating benefit for those systems. The results shown above illustrate the ability of those in **the project to think beyond their disciplinary silos, as it was noted by one of the stakeholders in the interviews: “The lenses process I believe is probably quite an interesting way of trying to focus people who have specific expertise ... onto [common] topics, and ... breaking down communication barriers...”**. One of the reasons this was achieved was the ability to have a shared understanding of the project. This ability to have a common story, a common purpose to a project has been shown to be critical in the success of complex projects where the aim is to produce results beyond common practice (Mang and Haggard, 2016, Hes and du Plessis, 2015).

Interestingly the survey results show that participants wanted more time, to resolve and refine ideas and create concrete opportunities. Yet for most projects the time spent on this activity would not be seen as productive. This is where looking at projects across their design, development, construction and handover is critical. The work of Reed and the 7 group (2009), has shown that integrated project design, where more emphasis is put on the initial holistic concept design, and includes all stakeholders, results in projects that are completed faster with less cost than comparative projects.

It is interesting that the participants score the LENSES framework lowest on its ability to future proof the project. This may be a reflection of the project being at such a preliminary stage and/or the low lying nature of the project and therefore uncertainty around its ability to thrive through sea level rise. It may also be related to the lack of time spent debriefing the project around next steps and how the guidelines would feed into the design, development and construction aspects. Theoretically the process the project went through should help improve the resilience of the site to future changes as an interdisciplinary body of experts was present. Further assessment of the built project is required to evaluate the effectiveness of LENSES in resulting in adaptive design outcomes.

To conclude this research shows that the LENSES framework seems to be assessed favourably by workshop participants and that it strongly supports interdisciplinary systems thinking. Whether this project will indeed lead to increased vitality, viability and ability to adapt will need to be seen over time. The results of the design stage and the comparison of the resulting master plan to that of the original master plan of 2003, discussed in a previous paper suggest that the potential is there (Hes, Stephan, Moosavi, 2016; Plaut et al. 2016) and highlighted by **stakeholder comments such as: “So it [LENSES] really helps us look at not only just the building of the development, but all the other aspects such as the environment and the social outcomes and how the whole development will operate into the future. And so it gives a much deeper and fuller understanding of the project”**.

REFERENCES

- [1] HES, D. & DU PLESSIS, C. 2015. *Designing for hope: pathways to regenerative sustainability*, New York, Routledge.
- [2] MANG, P. & HAGGARD, B. 2016. *Regenerative Development and Design: A Framework for Evolving Sustainability*, Hoboken, New Jersey, John Wiley & Sons, Inc.
- [3] MANG, P. & REED, B. 2012. Designing from place: a regenerative framework and methodology. *Building Research & Information*, 40, 23-38.
- [4] PLAUT, J. M., DUNBAR, B., WACKERMAN, A. & HODGIN, S. 2012. Regenerative design: the LENSES Framework for buildings and communities. *Building Research & Information*, 40, 112-122.
- [5] PRETTY, J. 2011. Interdisciplinary progress in approaches to address social-ecological and ecocultural systems. *Environmental Conservation*, 38, 127-139.
- [6] RAMSAR. 2016. The Ramsar convention and its mission [Online]. Available: [http://ramweb-
uat.neox24.ch/about/the-ramsar-convention-and-its-mission](http://ramweb-uat.neox24.ch/about/the-ramsar-convention-and-its-mission) [Accessed 13/06 2016].
- [7] REED, B. & THE 7GROUP 2009. *The integrative design guide to green building: redefining the practice of sustainability*, Hoboken, N.J., Wiley.
- [8] ROBERTS, A. M., PANNELL, D. J., DOOLE, G. & VIGIAK, O. 2012. Agricultural land management strategies to reduce phosphorus loads in the Gippsland Lakes, Australia. *Agricultural Systems*, 106, 11-22.
- [9] STEFFEN, W., CRUTZEN, P. J. & MCNEILL, J. R. 2007. The Anthropocene: are humans now overwhelming the great forces of nature. *AMBIO: A Journal of the Human Environment*, 36, 614-621.

APPENDIX A: Online survey questions

This appendix presents the questions of the online survey. A description of the three Likert-scales used is given first in Table A.1.

Likert Scale 5		Likert Scale 7a		Likert Scale 7b	
1.	Not at all	1.	Waste of time	1.	Totally confused
2.	A little	2.	None	2.	A little confused
3.	Fairly	3.	A little	3.	Barely
4.	Significantly	4.	Some interest	4.	A little
5.	Very much	5.	Useful	5.	Enough
		6.	Essential	6.	A lot
		7.	This changes everything	7.	Everything I need to know

Table A.1: Likert scales used in the online survey

The questions are given below in bold and the answer format between hyphens afterwards. Not that LS refers to Likert Scale and FA refers to Free Answer.

- **What is your role?** (select from: Architect, Engineer, Scientist, Community Member, Indigenous Representative, Government Member, Other (specify))
- **Which workshops did you participate in?** (select one or more from workshops 2-4)
- **How much value do you feel YOU gained personally from attending this/these workshop(s)?** (LS 7a)
- **What did you gain from attending?** (Free answer)
- **How much value do you feel the PROJECT gained from this/these workshop(s)?** (LS 7a)
- **How well do you think you understand regenerative development?** (LS 7b)
- **In your own words what do you think regenerative development is?** (FA)
- **On a scale from 1 to 5, can you score how well you felt the following parts of the workshop, including the LENSES framework worked?** (LS 5)
 - Identifying the key flows
 - Identifying the key relationships
 - Identifying appropriate solutions and design directions
 - Developing shared understanding of the potential of regenerative development
 - Facilitating a more integrated concept master plan
 - Facilitating/Accelerating decision-making
 - Future proofing the development

- Supported cross disciplinary collaboration
- Led to a story of place
- What do you feel were the key benefits to using the LENSES Process? (FA)
- What do you feel were the key areas for improvement in using the workshop, including the LENSES Process? (FA)

Gamification as a Means to User Involvement in Decision-Making Processes for Sustainable Buildings

Hanne Tine Ring HANSEN^a, Mary-ann KNUDSTRUP^b, Stine Skøtt PEDERSEN^c

^a Søren Jensen, Denmark, hrh@sj.dk

^b Aalborg University, Denmark, mak@create.aau.dk

^c Søren Jensen, Denmark, ssp@sj.dk

ABSTRACT

User ownership, actors' and stakeholders' lack of knowledge is often identified as critical success parameters and barriers when evaluating how well sustainable buildings perform. Recognising that it is impossible to drive sustainable development without the people who pay for sustainable buildings, and the people who run and use these buildings, the development of a dialogue and prioritisation tool was funded by the Danish Ministry of Immigration, Integration and Housing. This paper presents the tool development process that is a result of a participatory research and development process where the tool was developed by a multidisciplinary group of stakeholders and actors from the Danish building and housing industry. The paper presents how gamification can be used to make complex and academic issues of sustainability available to decision-makers in housing organisations who are typically people from all walks of life.

Design thinking was used as method to develop a tool that focuses on how to make sustainable strategy development accessible to non-specialists during those critical stages of building design processes when goals and prioritisations are set. The tool is based on an open and editable platform and it will be available to the public in the early Summer of 2017. The paper presents how design thinking is used as an engaging research and development methodology, as well as, an introduction to the dialogue and prioritisation tool's content and format.

Keywords: community empowerment, affordable housing, decision making process

1. INTRODUCTION

In August 2013, an open two-stage architectural design competition was launched under the title 'Future Sustainable Public Housing'. The project owners, selected by the Danish Ministry of City, Housing and Rural Districts, were the two Danish housing organisations, 'Lejerbo' and 'AL2Bolig'. The Danish version of the DGNB system [2] was described in the competition material and the project owners hired a DGNB consultant to initiate a pre-certification of the competition projects that were selected for participation in stage two of the competition. During this process the DGNB tool was introduced to the project managers from Lejerbo and AL2Bolig and the residential decision-making construction committee at AL2Bolig. During this process it became apparent that the DGNB system was too academic and complex to enable easy communication with decision-makers in the housing organisation. Because of this, the director of AL2Bolig initiated the idea to develop a dialogue and prioritisation tool for user-involvement on sustainability strategy development for social housing. In late 2015, The Danish Ministry of Immigration, Integration and Housing decided to fund the tools' development.

1.1 Decision-making in Danish housing organisations

The social housing organisations in Denmark depend on subsidies for renovation from "Landsbyggefonden", governmental subsidies for new constructions, as well as, municipal planners who determine where housing projects are to be built and how they are financed. Because of the public subsidies, and the fact that the tenants carry most of the investment in new buildings, Danish housing organisations are based on residential democracy where the residents elect their peers as members of the board and different committees. The residential democracy is supplemented by professional staff consisting of a director, a communication department, tenant management, technical staff and facility managers. How the residential boards and committees are involved in decision-making on building projects vary a great deal depending on the housing organisations. In some organisations the residential democracy is greatly involved in the decision-making processes. This means that in some cases residents with very different educational background will have a great impact on the sustainability strategies for

building projects thus making it necessary to communicate with the residential democrats about complex and highly specialised knowledge.

1.2 Project organisation

The project was organised as follows: A work group was established that refers to the Danish Ministry of Immigration, Integration and Housing. An advisory board and a test group were established as advisors to the work group. The work group consists of two building design engineers, a social housing expert and the following representatives from two housing organisations: a director, a technical chief and a communication team leader. One of the members in the work group is the project owner who refers to the Danish Ministry of Immigration, Integration and Housing. The advisory board is interdisciplinary with representatives from the work group and the following roles: Architect, engineer, technical chief and project managers from housing organisations, contractors, municipal plan chief, residential democrat and technical reviewer from the Danish Green Building Council. The test groups consist of project managers from five different housing organisations and a group of residential democrats with very different background and skills who were elected by their peers for decision-making on building projects in their respective housing organisations. The purpose of the multidisciplinary workgroup and advisory board was to ensure that all relevant actors from the building industry could contribute with their experiences and ideas in the tool development process whilst the selection of people for the test group focused on ensuring that projects managers and residential democrats from very different housing organisations would test the tool. This was chosen to ensure that the tool is applicable by housing organisations with very diverse backgrounds.

2. TOOL DEVELOPMENT METHODOLOGY

2.1 Design thinking as a methodical approach

Design Thinking was used to facilitate the development of the dialogue and prioritisation tool. The term Design Thinking (DT) is often used as a way of describing how designers think. David Kelly, IDEO, is amongst the pioneers behind the notion of Design Thinking in business development projects. IDEO explains DT like this: “**Design thinking is a human-centered approach to innovation that draws from the designer's toolkit to integrate the needs of people, the possibilities of technology, and the requirements for business success.**” (Brown, September 20th 2016). Prior to the launch of the term design thinking researchers like Professor Bryan Lawson, Sheffield University, and the laid Professor Donald Schön, Massachusetts Institute of Technology, were some of the main authorities in the field of how designers think. The referenced paper by Hansen and Knudstrup (2008) concluded that designers and engineers traditionally approached problem solving in different ways where the designer reframed the design problem continually throughout their process whilst engineers tended to stick with the original problem and test different hypotheses for how to solve the problem. Today DT is a commonly used term that is applied to many disciplines including engineering and the disciplinary boundaries between architectural design and engineering have therefore diminished. When developing the dialogue and prioritisation tool a model of design thinking, developed by the Danish Design School in Kolding, was utilised. The model shown in Figure 2 was chosen because it builds on the theories behind design thinking and visualises when open and closed modes are utilised in the project and product development.

2.2 The tool development process

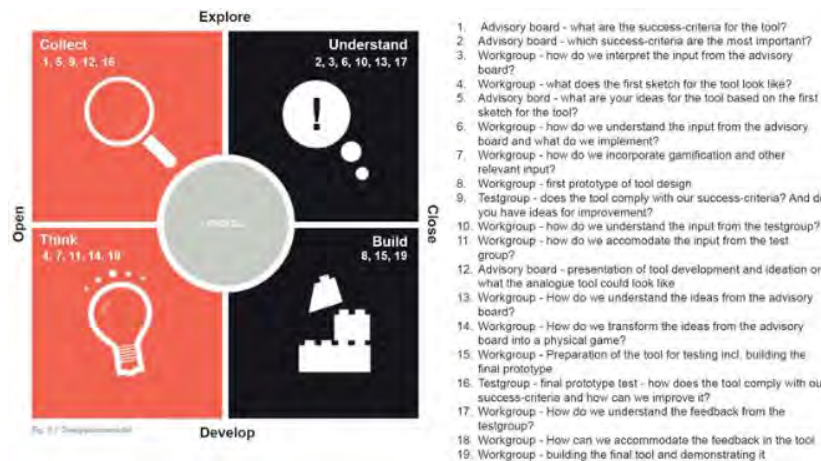

Figure 1: The tool development process mapped via numbers added to the "Design Process Model" from the Danish Design School in Kolding

The dialogue and prioritisation tool development occurred in four phases with a total of 19 activities where each phase included open and closed modes in the Design Process Model from the Danish Design School in Kolding. These activities are added as a new layer with numbers in the Design Process Model (please refer to Figure 1).

3. THE NEW DIALOGUE AND PRIORITISATION TOOL

The idea of basing the dialogue and prioritisation tool on gamification originates from a meeting with the advisory board where some of the advisory board members explained how using the DGNB system on projects had resulted **in a sense of competing with oneself and how this increased the project actors' engagement and commitment** to increase the features of sustainability in their projects. The reasoning behind the decision to gamify the dialogue and prioritisation process was that 1) Physical interaction with objects will make the decision-making process more engaging and 2) Visualisation of qualitative performance at an early stage is an important driver that makes stakeholders compete with themselves. Gamification was therefore selected as a means of using the DGNB system to turn sustainability into measurable parameters thus quantifying and visualising the decision-making effect on social, economic and environmental sustainability. Gamification is thus in this instance defined as an interactive strategic decision-making process where the results of qualitative decisions are quantified and visualised as a driver for a better dialogue about sustainability and hopefully more holistic sustainability strategies [10]. The element of gamification in the tool is therefore essentially the situation where the decision-makers gain increased insight into sustainability aspects of building design and compete with themselves to improve the project performance.

To ensure that the actors focus on strategic decisions rather than immersing themselves into specific solutions the tool contains two components; 1) A digital tool programmed in Microsoft Office Excel for project managers in housing associations and 2) A dialogue tool number of physical dialogue and prioritisation cards that are to be used at a workshop with different actors from the housing organisations. Physical objects in the form of different coloured Centricubes are assigned to each corresponding coloured dialogue and prioritisation card. The number of Centricubes roughly corresponds with the influence that the specific dialogue card has on the environmental, social, economic, technical or process quality in the DGNB system. The purpose of these objects is to visualise how the conclusions of the decision-making process affect the project's sustainability.

Figure 2 shows a picture of the new analogue dialogue and prioritisation tool used in the prototype test in November and December 2016. The dialogue board and the questions on the cards are under revision after the prototype test but the essential elements of the tool described in this paper will be preserved.



Figure 2: The new developed analogue dialogue and prioritisation tool used in the prototype test.

3.1 Tool content

As mentioned in the previous paragraph, the tool consists of two components, a digital platform for the project manager and an analogue platform to be used by the project manager in dialogue with the residential democrats in the housing organisation.

The approach taken to sustainability in the tool is the Danish version of the DGNB system. The challenge one faces when trying to use the DGNB system in communication with non-specialists is that the system is perceived as very academic – i.e. very theoretical and abstract – and very unapproachable by non-specialists. This makes sense seen in the light that one needs to have at least 2 years of practical experience prior to completing the training to become a DGNB consultant. It is however a significant barrier when it comes to ensuring ownership and engagement with non-specialists in the decision-making process. Because of this the DGNB system has been transcribed into the themes listed in Table 1.

Quality	Themes
Environmental quality (green colour)	Materials, Energy, Water, Biodiversity, Pollution management
Economic quality (blue)	Life cycle costs, Flexibility, Durability and robust solutions
Social quality (orange)	Quality of outdoor areas, Indoor climate, User control, Accessibility, Safety and security, Cyclist facilities, Architectural quality, Functionality and planning
Technical quality (yellow)	Fire management, Building envelope quality, Cleaning and maintenance
Process quality (purple)	Project planning, Integrated design process, Integrated concepts, Responsible contractors, O&M material handover, Construction site operation, Onsite measurements, Commissioning

Table 1: List of DGNB themes referring to the different colourers in the tool

Communication with the residential democrats is based on these themes and a number of topics related to each of these themes. Examples of topics related to the theme Materials are: design for disassembly, environmental impact of materials, embedded toxins and responsible procurement. For each of these topics there is a short explanatory text that describes 1) What this topic has to do with sustainability and 2) Which type of value it adds to the projects social, environmental and economic sustainability. Each topic has at least one question that the residential democrats are asked to discuss and prioritise on a scale of three levels of importance. Depending on their answers the actors will place the Centricubes belonging to the specific dialogue card in one of two fields at the dialogue board 'prioritised' and 'not prioritised'. **The purpose of this exercise is to visualise how different types of sustainability is weighted by the dialogue partners as well as an identification of the remaining potential to improve the project's sustainability. The project manager will mark the selected answer for each question in a table that he/ she has printed from the digital tool in case the dialogue partners wish to change their minds and change the project's prioritisation of a specific topic.**

After the workshop the answers to each question is transferred to the digital tool and translated into a series of graphs that show how the project is expected to perform against the DGNB system. It is also possible for the project manager to add his or her own weighting to each theme if they do not wish to adhere to the weighting of the themes in the DGNB system e.g. if they have chosen to disregard some of the themes in their project. Once the dialogue process has been completed the dialogue tool translates the questions and answers for each topic **back into the DGNB system's structure as part of the preparation of the tender material. This is done to ensure easy communication with DGNB specialists that have to reply to the upcoming tender.**

3.2 Tool application

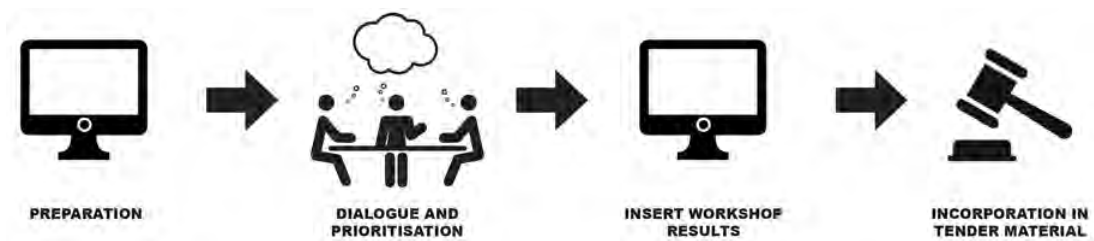

Figure 3: Overview of the tool application process.

The tool is applied in the following manner:

- **The project manager fills out a form with background data and contextual questions about the project's preconditions** including which actors he wishes to include in the dialogue process.
- Based on his or her answers the list of themes are sorted by the digital tool and for each of the themes listed by the tool the project manager selects which actor or group of actors to include in the decision making process for each theme.
- Based on step 2: The tool divides the topics, questions and answers for each theme into separate sheets in the tool. This is where the project manager will insert the results of the analogue dialogue process.
- Based on step 3: The project manager divides his/her dialogue cards into piles for each actor or group of actors that he/she wants to involve in the decision-making process. He/she also divides the number of Centricubes into piles and brings these with the rest of the dialogue tool to a meeting or a workshop with these actors.
- **At the workshop each card is prioritised on a scale of three levels that define the importance of the card's topic.** Each card has a colour that tells the dialogue partners whether the topic has to do with social, environmental, economic, technical or process quality. The project manager can also choose to bring the coloured Centricubes that correspond to the weights of each card and use these to build an image of how the selected strategy performs for each of the 5 qualities in the DGNB system. If this is included in the dialogue process the actors will receive instant feedback on how their choices influence the future sustainability of their project. The type of sustainability is marked via the coloured Centricubes thus visualising how different types of sustainability is weighted in the strategy.
- After the workshop the project manager inserts the conclusions from the dialogue process into the digital tool and the tool provides him/her with input for the tender material and a series of graphs of the project performance at this very early stage of the design process.
- After the project tender has been completed the prioritisation can be revised in collaboration with the residential democrats if they need to find areas to save money or if the winning tender has improved the **project's sustainability**.

4. CONCLUSION

This paper presents the development and content of a tool developed for early actor involvement in decision making processes related to sustainable building design. The tool development was based on a combination of design thinking and gamification. The preliminary tool was tested in August 2016 with positive feedback and great suggestions for improvement by project managers in residential housing organisations. A second round of testing was completed with residential democrats and their project managers in November and December 2016. The feedback from this test was very positive and the work group got some interesting input on what was difficult to understand and ideas for how to improve the tool.

The conclusion of the prototype tests was that a) Using analogue elements such as dialogue cards and Centricubes in the dialogue with residential democrats increases their understanding of sustainability and their engagement in the decision-making process, b) **Physical activity increases the actors' remembrance**, c) Gamification is interesting because it makes actors reflect on how to improve the performance of their decisions towards the project's sustainability profile and d) the final tool needs to find a balance between abstract ideas and specific solutions that

ensures that the discussion does not focus too much on specific solutions and give an illustrative information over the prioritisation in the project exemplified in the numbers of coloured Centricubes referring to the 5 DGNB themes.

After the final testing in November and December 2016 the tool will be finalised. The final version of the tool is expected to be released in May 2016 and the final tool will be ready for presentation at the WSBE17 conference.

Design Thinking has proven itself as a valuable method for the tool development. Without the conscious and strategic use of open and closed modes the final tool would not have ended out as well as it did if the work group had designed it without the input from the advisory board and the test group.

ACKNOWLEDGEMENT

The following people have contributed to the tool development either as part of the work group (WG), the advisory board (AB) or the test group (TG): Ole Nielsen (WG) and Jesper Toft-Nielsen (TG) , Boligselskabet Sct. Jørgen-Viborg (WG), Allan Werge (WG), Tania Andersen (WG) Peter Brix Westergaard (AB) and Per Kinly (TG), AL2Bolig, Anna-Claudia Erichsen, acelab (WG), Hanne Tine Ring Hansen (WG), Ramboll/Søren Jensen Rådgivende Ingeniører, Stine Skøtt Pedersen (WG), Ramboll/Søren Jensen Rådgivende Ingeniører, Lau Raffnsøe, Danish Green Building Council (AB), Pernille Hedehuus (AB), MT Højgaard, Philip Naegeli Arnhild (AB) and Charlotte Algreen (TG), Lejerbo, Katja Adelhøj Lindblad (AB), Heine Krarup Møller (TG) and Jonas Hugo Stavad (TG) , Boligkontoret Danmark, Suna Cenholt (AB), PLUSkontoret arkitekter, Henrik Staun, Lund & Staun (AB), Lisbet Wolters, Vejle kommune (AB), Carina Hedevang (TG) and Carsten Kjær Christensen (TG) AAB Aarhus (TG).

REFERENCES

- [1] Aumann, R. J. 1989, Game Theory, UK, 1st edition.
- [2] Brown, T. 2009. Change by Design, U.S.A, New York, 1st edition.
- [3] Danish Association of Architects [Online] Retrieved from <https://www.arkitektforeningen.dk/konkurrence/fremtidens-baeredygtige-almene-bolig> [Retrieved on September 28, 2016]
- [4] Danish Green Building Council, an introduction to DGNB [Online] Retrieved from: <http://dk-gbc.dk/publikationer/an-introduction-to-dgnb/> [Retrieved on September 27, 2016]
- [5] Designskolen Kolding, the design process model [online] Retrieved from: <https://www.designskolenkolding.dk/en/design-process-model> [Retrieved on September 20, 2016]
- [6] Hansen, H. T. R. and Knudstrup M., Parametric analysis as a methodical approach that facilitates the exploration of the creative space in low-energy and zeroenergy design projects [Online] Retrieved from http://architecture.ucd.ie/Paul/PLEA2008/content/papers/oral/PLEA_FinalPaper_ref_207.pdf [Retrieved on September 20, 2016]
- [7] IDEO, About IDEO [online] Retrieved from: <https://www.ideo.com/about/#68W5xiugGsSb0m6l.99> [Retrieved on September 20, 2016]
- [8] John Cleese lecture, How to be creative [Online] Retrieved from: <https://vimeo.com/89936101> [Retrieved on September 27, 2016]
- [9] Landsbyggefonden, om landsbyggefonden, organisation [Online] Retrieved from: <https://www.lbf.dk/om-lbf/organisationen/> [Retrieved on September 20, 2016]
- [10] Retsinformation, Bekendtgørelse af lov om almene boliger m.v. [online] Retrieved from: <https://www.retsinformation.dk/forms/R0710.aspx?id=183636> [Retrieved on September 27 2016]

Accelerating HKIA's Carbon Footprint Reduction through Multi-stakeholder Engagement and its Potential for Multi-tenant Facilities

Mike KILBURN^a, Stephen CHAN^b

^a Airport Authority Hong Kong, Hong Kong SAR, mike.kilburn@hkaairport.com

^b Airport Authority Hong Kong, Hong Kong SAR, stephen.chan@hkaairport.com

ABSTRACT

With a team of 1,500 staff, Airport Authority Hong Kong (AAHK) is responsible for the operation and development of Hong Kong International Airport (HKIA) while the majority of the airport's operation is outsourced to its business partners (BPs), such as airlines, caterers and cargo handlers, who collectively employ 73,000 staff (AAHK, 2016a).

In order to accelerate environmental footprint reductions at HKIA, AAHK has adopted a strategy of moving beyond its direct sphere of control to proactively engage with its BPs and other stakeholders to address specific environmental issues. In 2008, AAHK launched the HKIA Carbon Reduction Programme which provides the framework that enables AAHK to work collaboratively with BPs from a range of sectors to measure, reduce and report carbon emissions through a series of initiatives. This collaboration enables a greater pool of emissions to be addressed as the BPs account for some 60% of airport emissions (AAHK, 2015). In 2010, AAHK, together with 40 BPs, pledged to reduce the airport-wide carbon intensity by 25% from 2008 levels by 2015. This multi-stakeholder approach has proven successful in reducing the carbon footprint of HKIA, and is also suitable for implementation by other operators of multi-tenant facilities such as shopping malls, universities or industrial parks seeking to reduce carbon across the whole facility. This paper describes how the multi-stakeholder approach was adopted at HKIA in achieving the 25% carbon reduction target and the potential of its application to accelerate carbon footprint reduction in other multi-tenant facilities.

Keywords: HKIA Carbon Reduction Programme, carbon footprint reduction, stakeholder engagement

1. INTRODUCTION

Airport Authority Hong Kong (AAHK)'s HKIA Carbon Reduction Programme is the core carbon reduction initiative for Hong Kong International Airport (HKIA). Airport operators typically report only on the emissions under their direct control, but under this voluntary multi-year programme AAHK provides a framework that enables it to work collaboratively with over 40 business partners (BPs) to measure, reduce and report carbon emissions across the whole airport. This multi-stakeholder approach, which has won several carbon management and reporting awards, is also suitable for implementation by other operators of multi-tenant facilities (such as industrial parks, shopping centres or universities) seeking to take a lead in reducing carbon across the whole facility. AAHK continues to develop the Programme and proactively shares its methodology with interested parties in Hong Kong and the global aviation community.

The foundation of this Programme is the pledge made in 2010 by AAHK and 40 BPs to reduce airport-wide carbon intensity at HKIA by 25% by 2015 based on 2008 levels (AAHK, 2010). This was the first airport-wide carbon reduction target made by any airport operator (AAHK, 2010). As at end 2015, AAHK and its BPs together achieved a reduction of 25.6%.



Figure 1: The HKIA carbon reduction pledge ceremony

2. PROJECT SUMMARY

2.1 Scope and sources of airport carbon emissions

Carbon emissions are categorised into three different scopes according to **Hong Kong Government's guidelines** for carbon auditing (EPD & EMSD, 2010). Examples of the main airport and airport-related emission sources in each scope are summarized below:

Scope 1: Direct emissions from sources and removals by sinks

- Emergency power generators
- Vehicle fleet including ground support equipment (GSE)
- Hydrofluorocarbons (HFCs) and perfluorocarbons (PFCs) emissions for refrigeration / air-conditioning

Scope 2: Energy indirect emissions

- Emissions from electricity/ Towngas generation

Scope 3: Other indirect emissions

- Methane gas generation at landfill in Hong Kong due to disposal of paper waste

2.2 Overview of carbon reduction programme

To reduce the airport's carbon emissions, AAHK started the airport-wide HKIA Carbon Reduction Programme in 2008. The key milestones of the programme are summarised in Figure 2.

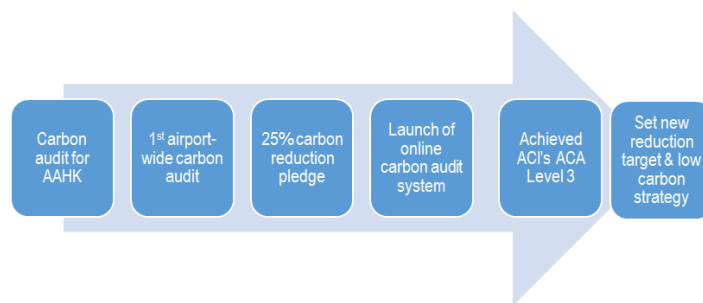

Figure 2: HKIA's carbon management roadmap

In 2008, following the release of the Hong Kong Government's guidelines for carbon auditing, AAHK conducted the first carbon audit of its own buildings and facilities at HKIA.

This was then followed by an airport-wide carbon audit in conjunction with AAHK's BPs in 2009. **This audit laid the foundation for AAHK to develop and formalise the airport-wide HKIA carbon reduction programme.**

In 2010, AAHK, together with some 40 BPs, pledged to reduce carbon intensity by 25% by 2015, based on 2008 levels.

In 2011, AAHK developed and launched a proprietary online carbon audit system (CAS) that provides an advanced carbon monitoring and reporting platform for AAHK and its BPs (AAHK, 2015a).

HKIA's efforts in carbon management and reduction were recognized in March 2013 when it was awarded the 'Optimisation' level in **Airports Council International's Airport Carbon Accreditation (ACI's ACA) programme.** This is the second-highest level of accreditation, and HKIA was the first airport in the Asia-Pacific region to achieve this standard (AAHK, 2013). AAHK successfully renewed the accreditation in the subsequent years, and has extended the airport-wide Carbon Reduction Programme to cover 46 BPs at HKIA (AAHK, 2015b).

In 2015 – 2016, AAHK worked with its BPs to develop a new airport-wide carbon reduction target for 2016 – 2020 and the associated strategies to achieve carbon reduction.

2.3 Reduction in airport-wide carbon emissions

AAHK understands that the carbon emission sources at HKIA which are under its direct responsibility, and hence the extent of reduction, are limited. In fact, AAHK accounts for approximately 40% of the airport-wide carbon emissions while the BPs account for the remaining 60% (Figure 3).

HKIA carbon emission in 2015



Figure 3: AAHK's BPs account for some 60% of emissions at HKIA

Through engaging and collaborating with BPs, AAHK has been able to accelerate the rate of airport-wide carbon reduction. With the concerted efforts made by the airport community, the airport-wide carbon intensity was reduced by 25.6% in 2015. Figure 4 illustrates **HKIA's carbon emission reduction performance between 2008 and 2015** in both intensity and absolute reduction. It should be noted that between 2008 and 2015, the throughput has increased from 48.6 million passengers and 3.6 million tonnes of cargo (AAHK, 2009) to 68.5 million passengers and 4.4 million tonnes of cargo respectively (AAHK, 2016b), representing a growth of 41% and 22% respectively during this period.

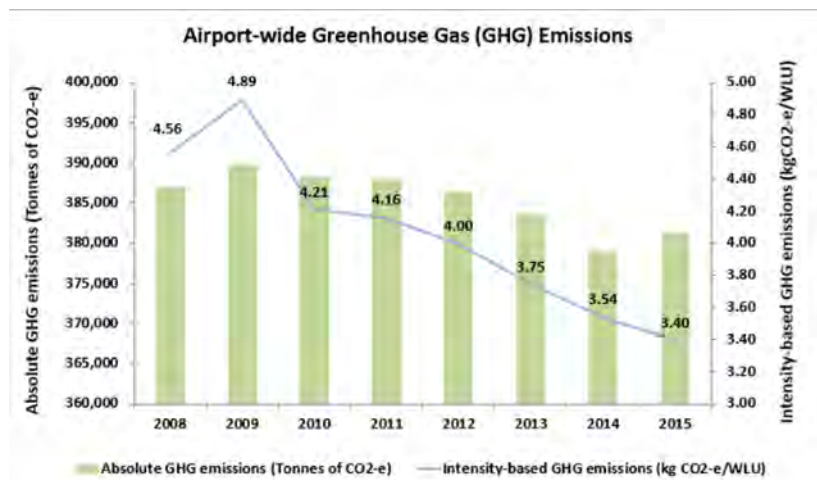

Note:

1. A fixed grid emission factor for 2008 was used throughout to enable year-to-year comparison.
2. Excludes emissions from companies joining the programme after 2010.

Figure 4: HKIA carbon emission reduction performance between 2008 and 2015

The number of BPs joining the programme grew from 40 in 2010 to 46 in 2015 as a result of AAHK's continuous engagement approach, which has led to enhanced awareness of carbon management amongst the airport community. The exceptionally high rate of participation also demonstrated the success of the Programme and its contribution in spreading the message of carbon reduction.

Looking forward, AAHK will extend the Programme to cover tenants and other Hong Kong-based airlines. By recruiting more BPs to the Programme, the footprint of emission that can be reduced is further increased.

3. KEY SUCCESS FACTORS

The success and achievements of the HKIA Carbon Reduction Programme are attributable to the following factors. These factors are not specific to airport environment, and are also applicable to carbon reduction initiatives in other multi-tenant buildings.

3.1 Flexibility in adoption of carbon reduction solutions

The BPs include a wide range of organizations from sectors including airlines, airline caterers, government departments, cargo handlers and ground services providers.

Given the diversity of their business nature, **it is not possible to find a “one-size-fit-all” solution for all BPs. Rather** than dictating what the BPs should do to reduce carbon emissions, AAHK encourages the BPs to devise their own measures based on their business nature, resources and level of expertise, but plays an important role in facilitating the sharing of best practices.

In this way, each of the 46 participating BPs have the flexibility to determine the most effective solutions for its own situation, but can also benefit by learning from the best practice of other participants. The flexibility of this model makes it also suitable for other multi-tenant facilities such as shopping malls, logistics centres, industrial parks or multi-tenant office buildings.

3.2 Public commitment from senior management

The 25% carbon reduction pledge set in 2010 was the world's first airport-wide carbon reduction pledge (AAHK, 2010). The pledge, supported by the Hong Kong Government at ministerial level, AAHK's senior management, the BPs and environmental non-governmental organisations (NGOs), set a carbon intensity reduction target for 40 BPs and demonstrated the commitment of the whole airport community. This public commitment served as a compelling driver for the successful and continuous implementation of the HKIA Carbon Reduction Programme.

3.3 Demonstrating the business case for reduction measures

AAHK acts as a pioneer within the airport community, leading by example through investing in the adoption of innovative reduction measures, and proactively explaining the associated benefits and business case. For example, **AAHK's replacement of 100,000 traditional lights with LEDs successfully demonstrated that the savings in maintenance cost and reductions in operational disruption exceeded the greater capital cost of the LEDs and the new fixtures (AAHK, 2015).**

AAHK also highlighted the work of BPs to demonstrate the business case of other innovative carbon saving solutions such as solar-powered staircases. The operational and environmental benefits included reduced labour costs and fewer incidents of damage to aircraft in addition to the savings in fuel and associated carbon emission.

3.4 Airport-wide carbon reporting platform

AAHK invested over US\$70,000 to develop an online CAS to calculate and monitor HKIA's airport-wide carbon emissions. The CAS is made available to all 46 participating BPs at no cost, enabling them to enter all data relevant to carbon emissions, and to calculate and analyze their carbon performance on a single unified platform. The system automatically calculates carbon emissions and generates various graphs to suit different analysis and reporting needs. BPs only have access to their own data. AA uses the aggregated data to monitor, review and report airport-wide carbon reduction performance.

3.5 Capacity building

To ensure BPs are equipped with the necessary knowledge, AAHK has organised over 30 carbon workshops, sharing and training sessions. AAHK has also trained 5 internal staff as certified carbon auditors to conduct free carbon audits for participating BPs every year, which also provide another opportunity for AAHK to understand **BPs' needs and to provide assistance accordingly.**

4. SETTING A NEW CARBON REDUCTION TARGET

Following the completion of the 2010 - 2015 pledge, in 2015 AAHK began the process for setting a new airport-wide reduction target for 2016 – 2020. This process involves benchmarking the carbon targets set by other hub airports, comprehensive engagement with the BPs and internal departments to identify energy efficiency and other carbon reduction measures, as well as developing a framework for stronger airport-wide collaboration in pursuit of the new targets. The outline of the target-setting process is presented in Figure 5.

4.1 Engagement with BPs

With over 60% of HKIA's emission coming from the BPs, it is important that BPs' views are taken into account in setting the target. Their views have been consolidated through various stages in the target-setting process.

A survey was conducted to identify suitable carbon reduction measures reflecting the fact that the BPs have different business natures and different reduction opportunities. This survey was also important to understand the key hurdles to implementing low carbon measures, so that support measures could be tailored to suit the **BPs'** needs. Based on the feedback from BPs, an initial target range and the associated support measures were prepared for consultation. Consultation sessions were conducted to introduce the targets to BPs. Following the consultation, their views were collected in a survey. These showed BPs agreed to the support measures and identified a consensus around the level of target to be set.

To demonstrate the airport's commitment, a public ceremony will be held in November 2016 at which AAHK and the participating BPs will jointly pledge to achieve the new target, in the presence of senior government officials, environmental NGOs and the media.

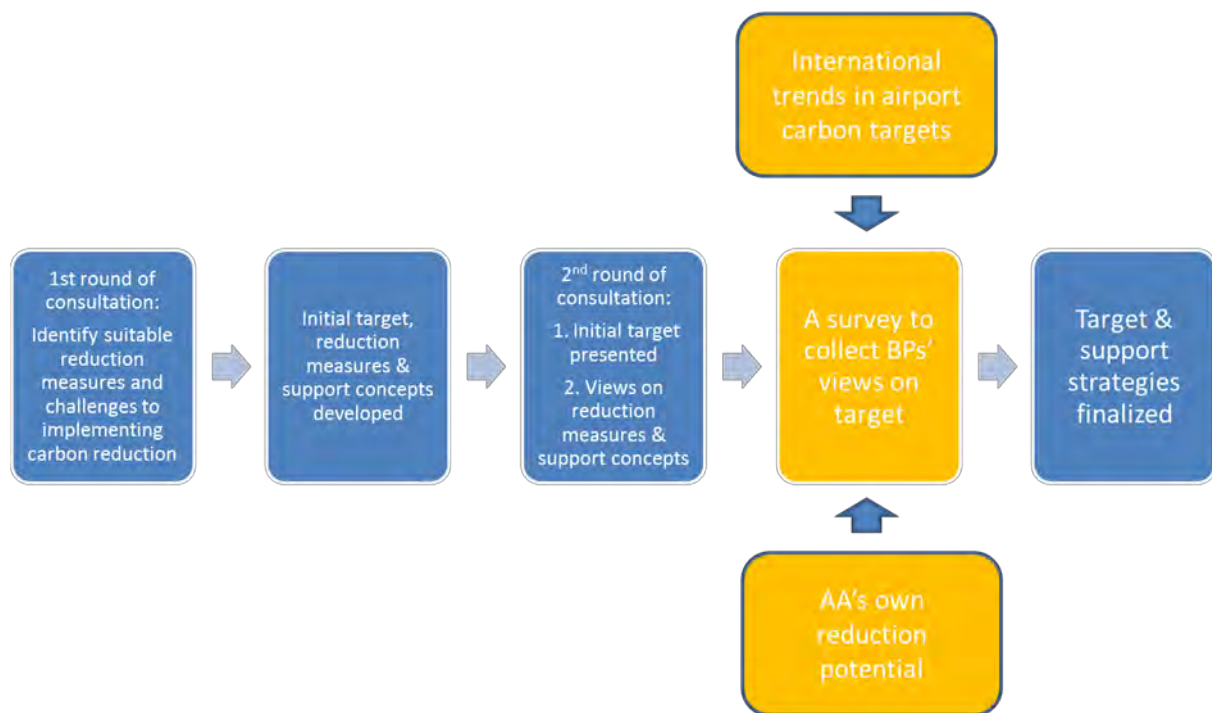

Figure 5: Process for setting the new airport-wide carbon reduction target for 2016 - 2020

4.2 Support Strategies for BPs

As the Carbon Reduction Programme matures, the reduction opportunities available to HKIA will shift away from **'low hanging fruit' energy saving opportunities to more complex technologies and projects, with potentially greater capital requirements, longer lead times and longer payback periods that need to be justified by a sound business case.** Having considered the feedback from BPs, AAHK is considering to implement the following measures to encourage reductions from BPs:

- **Roundtable discussion with BPs' senior management;**
- A technical working group to share technical knowledge of carbon reduction technologies;
- A benchmarking scheme to enable BPs to compare their carbon reduction performance; and
- A carbon reduction award scheme to encourage best practices.

5. CONCLUSION

The HKIA Carbon Reduction Programme has demonstrated its value as a tool for accelerating carbon reductions across the airport. The Programme could also serve as a template for other multi-tenant buildings or facilities to effectively manage and accelerate the reduction of their carbon footprints through innovation and collaboration with their BPs and tenants. This approach is supported by a proven business case based on cost, operational and reputational benefits and the flexibility for different individual tenants and franchisees to determine their own best approach for carbon reduction.

REFERENCES

- [1] AAHK (2009), Finalized Civil International Air Traffic Statistics at HKIA for Year 2008 [online]. Retrieved from: <http://www.hongkongairport.com/eng/pdf/business/statistics/2008e.pdf> [Retrieved on 29 September 2016].
- [2] AAHK (2010), Press release: HKIA Pledges to Reduce 25% Carbon Intensity by 2015, Airport Authority Hong Kong [online]. Retrieved from: https://www.hongkongairport.com/eng/media/press-releases/pr_1015.html [Retrieved on 26 September 2016].
- [3] AAHK (2013), Press release: HKIA Becomes First Airport in Asia-Pacific to Achieve Airport Carbon Accreditation "Optimisation" Level, Airport Authority Hong Kong [online]. Retrieved from: https://hongkongairport.com/eng/media/press-releases/pr_1092.html [Retrieved on 26 September 2016].
- [4] AAHK (2015a), Environmental Stories: Carbon Reduction at HKIA [online]. Retrieved from: https://www.hongkongairport.com/eng/sustainability/environmental-management/environment-stories/carbon_reduction_programme.html [Retrieved on 29 September 2016].
- [5] AAHK (2015b), Sustainability Report 2014/15, Airport Authority Hong Kong [online]. Retrieved from: http://www.hongkongairport.com/eng/business/about-the-airport/publication/sustainability-report/SD-reports-2014_15.html [Retrieved on 27 September 2016].
- [6] AAHK (2016a), HKIA Fact Sheets, Airport Authority Hong Kong [online]. Retrieved from: <http://www.hongkongairport.com/eng/business/about-the-airport/facts-figures/facts-sheets.html> [Retrieved on 26 September 2016].
- [7] AAHK (2016b), Finalized Civil International Air Traffic Statistics at HKIA for Year 2015 [online]. Retrieved from: <http://www.hongkongairport.com/eng/pdf/business/statistics/2015e.pdf> [Retrieved on 29 September 2016].
- [8] ACI WESC (2009), Guidance Manual: Airport Greenhouse Gas Emissions Management, 1st Edition. Airports Council International, Montreal.
- [9] EPD & EMSD (2010), Guidelines to Account for and Report on Greenhouse Gas Emissions and Removals for Buildings (Commercial, Residential or Institutional Purposes) in Hong Kong, Revised Edition, Environmental Protection Department and Electrical and Mechanical Services Department, Hong Kong.

Session 6.13: Place-making – Integrative Design Processes

Integrated Design Guidance for The Early Process Phase - PLENAR –

Günter LÖHNERT^a, Sabine DORN-PFAHLER^b, Jessica STRITTER^c, Andreas DALKOWSKI^d

^a sol-id-ar planungswerkstatt, Germany, loehnert@solidar-pw.de

^b sol-id-ar planungswerkstatt, Germany, dorn@solidar-pw.de

^c sol-id-ar planungswerkstatt, Germany, stritter@solidar-pw.de

^d sol-id-ar planungswerkstatt, Germany, dalkowski@solidar-pw.de

ABSTRACT

PLENAR is a design guide for structuring of basic principles of building design for the preparation and implementation of an integrated design process. Without this process ambitious projects won't succeed. Main focus is the support of a common, interdisciplinary understanding of planning philosophy regarding energy efficiency and sustainability, among all partners involved in a building project.

PLENAR consists of three main goals which include

- Communication among actors involved by well-structured discussion formats
- Qualification of participants and project goals by interdisciplinary approaches
- Documentation of results in suitable formats for decision making and QA

For facilitating these goals PLENAR provides correlating application modules

- Evaluation: Using the matrix, correlations of relevant criteria can be evaluated individually by participants, the next step is to compare and assess the result.
- Information: A database provides generic information on criteria and their correlations with a focus on energy efficiency and sustainability.
- Analysis: The individual assessments of the relevant correlations made by the participants are discussed to derive the main goals for the specific project.

The structure of Goals and Modules creates an interrelated network which will enhance an interdisciplinary understanding among all actors involved and will foster a target-oriented integrated design process during early design stages.

This contribution presents the tools current state of development and advertises the support of planners as well as interested customers and companies to promote progress towards a professional, web-based tool.

Keywords: integrated design process, sustainable building, energy efficiency, design guidance

1. BACKGROUND – OBJECTIVE - POTENTIALS

The complexity of design processes increases continually. The potential of influence on energy performance, comfort and cost efficiency, as the most essential characteristics of sustainable building design, lies in early design stages. Hence, already in state of demand planning certain conditions have to be settled to define a requirement profile with an entire space allocation plan and holistic project goals.

Therefore, it is necessary that a common understanding of planning philosophy regarding energy efficient and sustainable building is set from the very beginning among all project partners. The early and constructive examination of the most important criteria and their correlations as well as their impact on sustainability quickly leads to this common planning understanding and guarantees a higher quality of the entire planning process. PLENAR can be used and adapted by all design teams for their individual project.

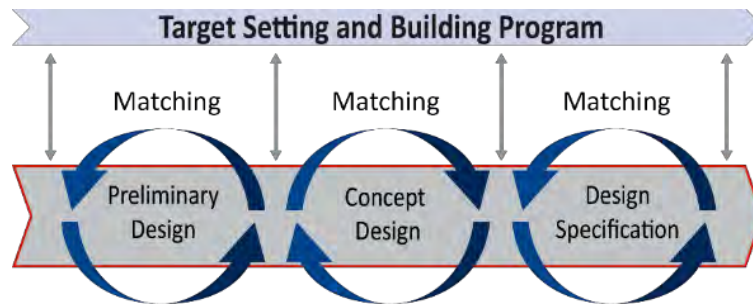

Figure 1: Optimization by Iteration loops during an integrated design process

The planning aid PLENAR enables in a short period of time

- An improvement of transdisciplinary understanding on energy and sustainability-oriented relations for all project partners: client, architect, professional planners, user, facility manager and others
- The development of an individual project master as a baseline for the specific project requirement profile and the structuring of the projects integrated design process by selecting and adapting the type and number of relevant criteria
- The development of a project roadmap for the further approaches in the integral design process with concepts to iterations in individual planning stages to optimize the entire planning and implementation process
- The documentation of results as a requirement profile for target agreements and performance specifications as a to-do-list for planners
- The documentation for the building certification as a verification and optimisation for planning objectives when applying assessment systems

2. APPROACH

The design guidance is based on extensive experience of comprehensive project support focussing integrated building design, energy efficiency and sustainability. All correlations (Figure 2) are assessed individually concerning their degree of influence on energy efficiency and sustainability by each actor.

Example: Correlation no. 21 represents the relation between building mass distribution (criteria no. 2) and flexibility (criteria no. 6). The assessment of the actors is determined and compared to a reference (master). Significant deviations to this master, but also among actors, allow a structured discussion. By this way misunderstanding among participants and information gaps can thereby be eliminated. Moreover, the actors will get insight to their role during an integrated design process.

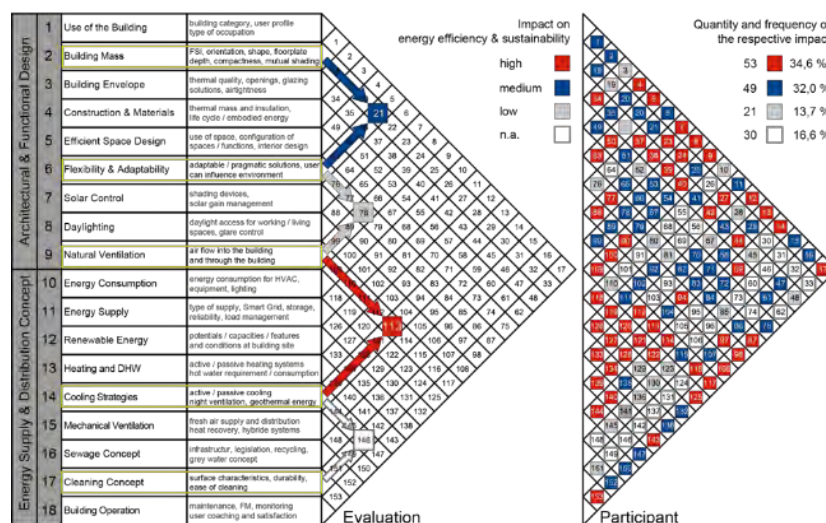

Figure 2: The correlation matrix for an individual application for planning actors

All planning participants, such as architects, energy planners, client and other experts evaluate 153 correlations resulting from 18 criteria, e.g. for office buildings, according to their individual assessment and experience. If possible, all correlations are to be assessed completely with regard to their impact on energy efficiency and sustainability and to be determined in the matrix according to the evaluation level (high, moderate, low or not applicable).

Hence, in the early planning stage each member of the interdisciplinary team has to deal with the same questions. This means, all project participants gain an extensive insight into the planning complexity and, above all, beyond the boundaries of their own planning discipline.

2.1 Evaluation of the individual knowledge

The results are analysed on the basis of the assessments made by the actors, i.e. they will be compared among each another and mirrored to a (master-) reference matrix provided by the design guidance PLENAR. This process gives an overview of the individual knowledge of all actors involved (Figure 3).

With a professional supported and moderated discussion, the different perspectives of the actors can be brought to a common level. Thus, individual expertise is exchanged and expanded for each participant. In the first iteration of the discussion process only the assessments with substantial deviations (deviation of 3 levels) are considered. In a second loop the deviations of level 2 can be discussed on demand as well.

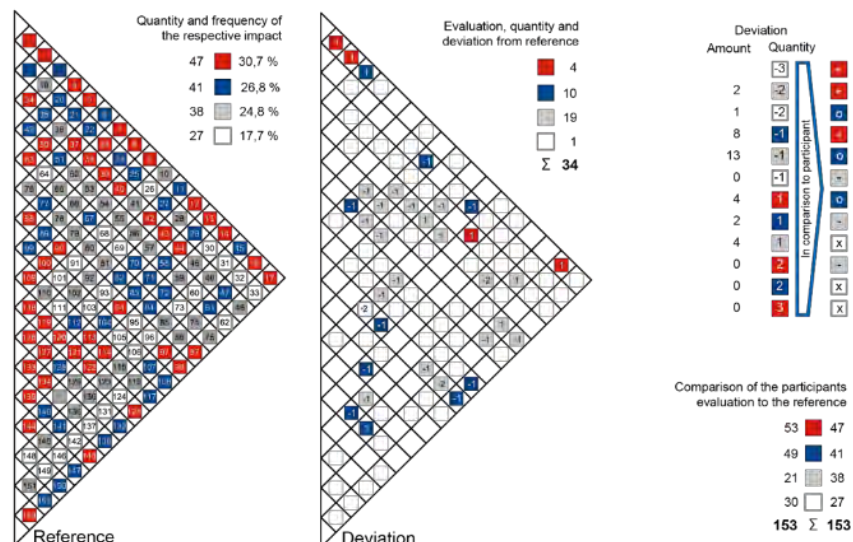

Figure 3: The individual correlation matrix is compared to a reference matrix (master) and evaluated

PLENAR is applicable on different levels. Information level 1 (see Figure 4) gives a rough description of the related criterion and its specification and a recommendation for the planning to its user. This level is the basis for evaluating the correlations of individual assessments regarding their respective relevance and the degree of their influence on energy efficiency and sustainability.

Information level 2 describes a variety of information about the potentials of the respective criteria, requirements, risks, standards and guidelines, concepts and examples, such as generally formulated sheets for the requirement and performance specifications (see Figure 5). In a discussion, this additional information provides well-founded information to qualify and simplify the planning process.

2.2 Information about the correlations (Level 1)

The database provides supportive generic information for the interdisciplinary discussion of the actor's assessments. This is done for all 18 criteria. If the correlation between two criteria has a high impact on energy efficiency and sustainability (e.g. correlation 113 marked in red), corresponding relevant information is provided as well (see Figure 4).

This information can also be adapted and documented according to the respective project specific requirements of the construction project. In this way you fulfil the prerequisites for compiling a performance specification sheet for further planning steps.

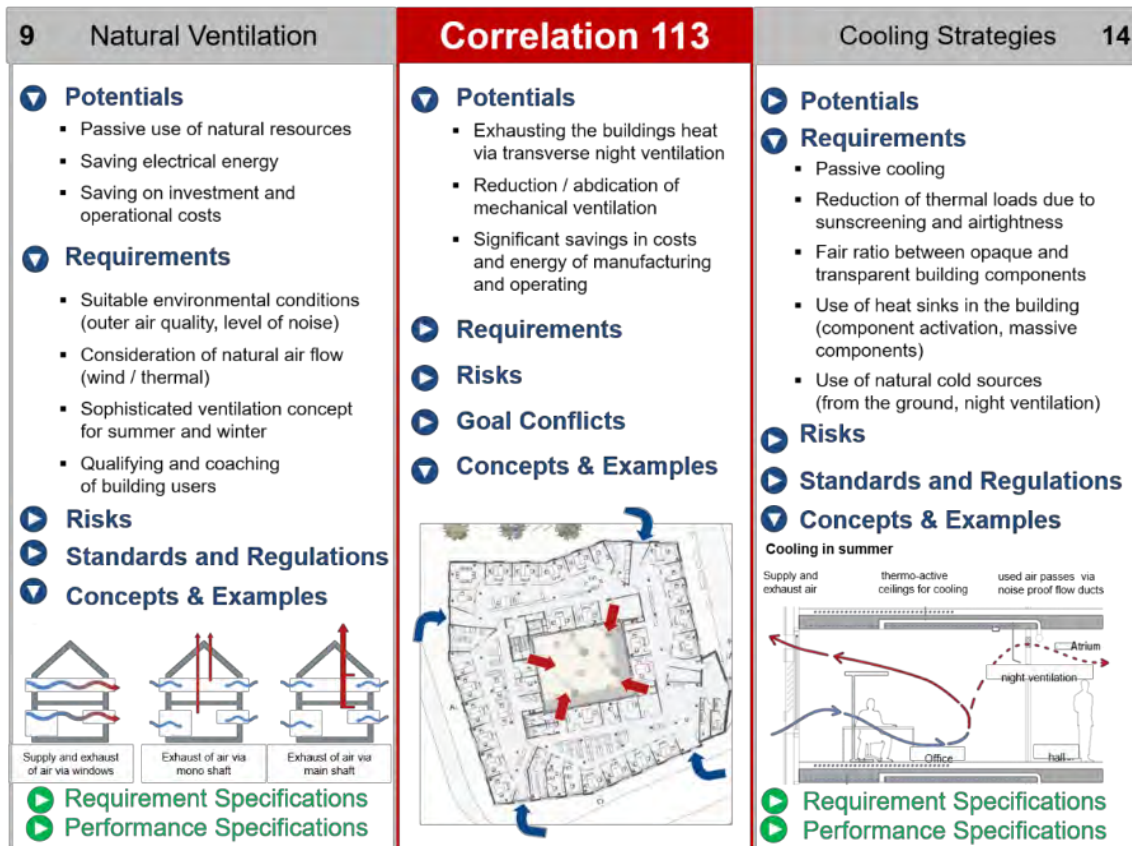

Figure 4: Correlation example 113: Natural ventilation versus cooling strategies

Information: As a communication basis a database provides information on all criteria provided and relevant correlations of high, moderate and low impact. In the discussion different levels of knowledge of the individual actors are balanced and the database is expanded continuously by the feedback of each project implementation. This is true for all building type applications.

Communicate contents and attitudes. Deviations of assessments will be analysed and interpreted in comparison **to the chosen reference (generic master, individual project matrix, individual actor's assessment)**. Important deviations are preferably discussed in a kick-off workshop.

2.3 Profile of requirements and implementation concept (Level 2)

For sustainable design, the requirements profile must be defined with clear project targets and subsequently a complete building program, which is then to be transferred into a performance specification sheet and implementation concept. The starting point and guideline are the confirmed project targets resulting from and addressed in the sustainable building certification system.

The example in Figure 5 shows requirements for a qualified ventilation concept: air quality, user acceptance, low energy demand, low operating costs and noise distribution. The performance specification sheet instructs the relevant measures to be implemented.



Figure 5: Requirement specs define requests - Performance specs determine related steps for a successful realisation

Qualify: The professional exchange for the assessment of correlations and the relevance for the certain project qualifies both the actors and the entire planning process. As a target agreement, elaborated content and results are documented in a requirement specification sheet as well as in the performance specification sheet based on it.

Document the integrated design process. With the help of PLENAR, all results of the assessment, the discussion and the specification of the connections for the optimisation of energy efficiency and sustainability can be structured and documented bindingly, for all subsequent planning steps.

2.4 Analysis of effective conclusions

The respective interrelation of tasks, targets, issues and target conflicts, requirements and desires as well as their backgrounds and effects can be analyzed in a subsequent context analysis (Figure 6) in order to develop solutions. In further planning progress design-related specifications are defined and updated or re-defined especially for the current project. As a directive for the objective implementation they are then documented in a comprehensive performance specification manual serving as an instruction book as well.

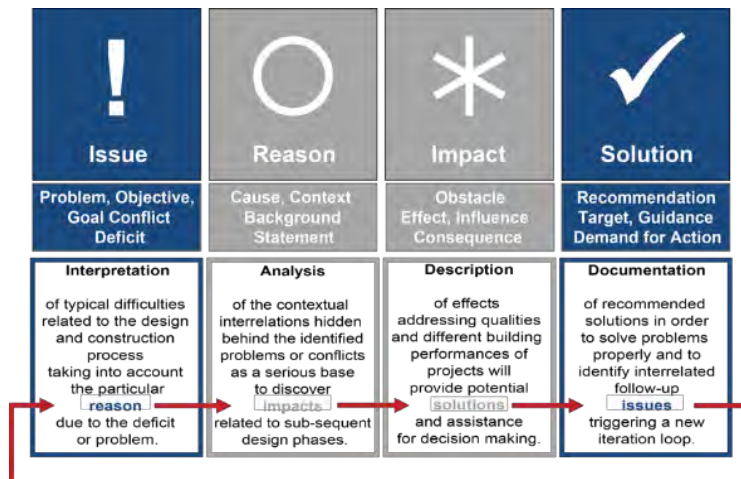

Figure 6: The context analysis is a method for the holistic analysis of correlations in the context of tasks and solutions of all kinds, in order to create a solid basis for the decision-making process

By using the method of context analysis, tasks, issues, goal conflicts and deficits or problems can be identified in a dialogue with all planning actors. Their backgrounds should be described as well as the respective effects, for example on comfort or operating costs, can be identified systematically. Only this kind of view on the entire context will give the opportunity to deal with questions in a comprehensive way.

For example, solution approaches of the context analysis will also be developed resulting from contradictions and problems with review of the requirement and performance specification sheets or with deviating in goal statements during design progress.

Thereby this method is an important instrument for the elaboration of decision papers and also, based on comprehensive consideration, an element for the integrated planning and implementation process.

3. FUTURE PROSPECTS

In order to provide the tool for planning teams in all kinds of projects, it is to be developed as a web-based application. for individual adaption. As a result, it gives an important contribution to the improvement of the interdisciplinary planning and building culture towards integrated design, energy efficiency and sustainability. In addition to the use of PLENAR as a design guidance in building projects, it is also suitable for (interdisciplinary) teaching at universities as well as for further education and training through the academies of architects and engineers chambers.

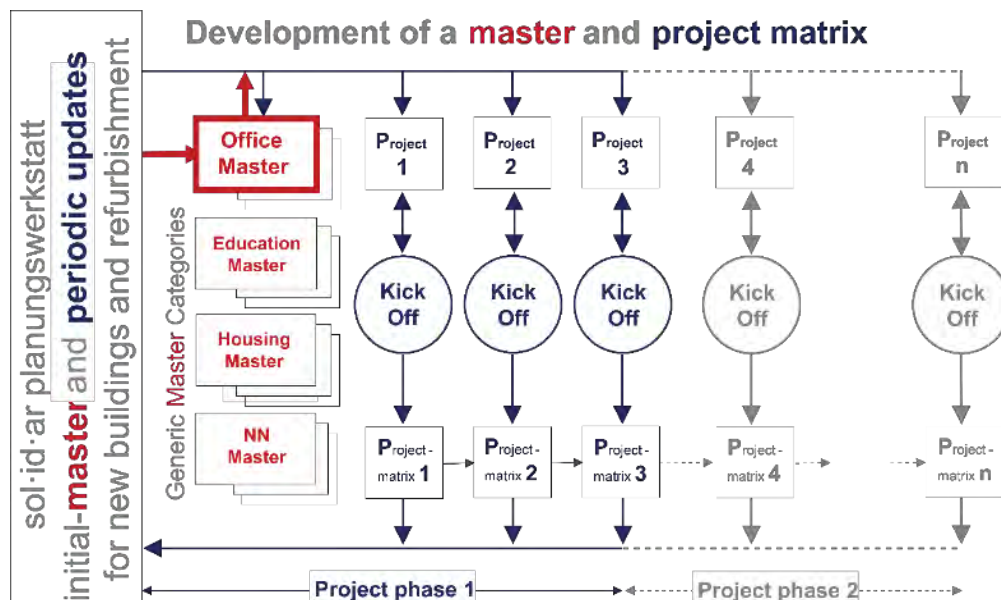

Figure 7: Development of master and project matrix: By applying PLENAR in different projects with different building categories, different masters for different building uses will be created

Moreover, it is also reasonable to use the tool to educate sustainability coordinators and auditors of sustainable building certification systems such as DGNB and BNB in Germany, LEED, BREEAM, etc.

The development for professional applications will provide so-called masters for building categories like office building, housing, education buildings, etc. for both new buildings and refurbishment (Figure 7). Thus, PLENAR qualifies itself frequently by the implementation into design processes and feedback from application practice.

REFERENCES

- [1] Löhnert, G. Planungshilfe aus der Praxis; XIA intelligente architektur 04-06/15
- [2] Löhnert, G. PLENAR Planungshilfe; Deutsches Architektenblatt 07/2015
- [3] Löhnert, G. Train-the-Trainer-Seminar, India, BEEP-Project 12/2014

Responsive Design – The Innovative Approach to Create Sustainable Neighbourhoods and Cities

Mary CHAN^a

^aDennis Lau & Ng Chun Man Architects and Engineers (HK) Ltd, Hong Kong SAR, mc@dln.com.hk

ABSTRACT

Green building certifications worldwide have mostly been focusing on building performance in terms of efficiency and savings in the use of energy and water, or the enhancement to the environment such as reduction in CO₂ emission, heat island effect, rainwater runoff or better indoor environmental quality as well as green material use.

Neighbourhoods and cities now face greater challenges of sustainability beyond efficiency and high performance. Unsustainable situations have led to disastrous consequences which have caused the loss of lives, destroying communities, neighbourhoods and cities.

From the wildfires in Alberta, Canada, to the sudden blast of underground pipes in Taiwan, earthquake and tsunami in Japan that triggered the failure of nuclear power plants, hurricane Katrina that swept through New Orleans, or simply the collapse of buildings and structures due to poor construction or lack of maintenance, time and again, none of the affected communities, neighbourhoods or cities were prepared to face the devastating consequence of disaster that shocked and destroyed them.

Are such catastrophes really unavoidable? While humans cannot control the natural environment, we can surely manage the man-made environment which we have created ourselves to minimize the magnitude of effects caused by unexpected events. With better planning, design and management, we should aim to avoid disasters from happening in the first place. Sustainability of neighbourhoods and cities is achievable and needs to be addressed as a matter of utmost urgency.

Using case studies, this paper will look into examples of neighbourhoods and cities in various countries where sustainability can be achieved through the use of responsive design as the innovative approach to create sustainable neighbourhoods and cities, helping them to avoid the devastating consequence of disasters.

Keywords: climatic responsive architecture, sustainable neighbourhood, sustainable cities

1. INTRODUCTION

Green building certifications worldwide have mostly been focusing on building performance in terms of efficiency and savings in the use of energy and water, or the enhancement to the environment such as reduction in CO₂ emission, heat island effect, rainwater runoff or better indoor environmental quality as well as green material use.

Neighbourhoods and cities now face greater challenges of sustainability beyond efficiency and high performance. Unsustainable situations have led to disastrous consequences which have caused the loss of lives, destroying communities, neighbourhoods and cities.

From the wildfires in Alberta, Canada, to the sudden blast of underground pipes in Taiwan, earthquake and tsunami in Japan that triggered the failure of nuclear power plants, hurricane Katrina that swept through New Orleans, or simply the collapse of buildings and structures due to poor construction or lack of maintenance, time and again, none of the affected communities, neighbourhoods or cities were prepared to face the devastating consequence of disaster that shocked and destroyed them.

Using case studies, this paper will look into examples of neighbourhoods and cities in various countries where sustainability can be achieved through the use of responsive design as the innovative approach to create sustainable neighbourhoods and cities, helping them to avoid the devastating consequence of disasters.

The current state of disaster management seems to suffer from one or all of the following:

- Insufficient investment to design for safety
- Reactive rather than responsive approach
- More attention on post-disaster management instead of pre-disaster management

2. WILDFIRE IN ALBERTA, CANADA

2.1 Spread and action – the reactive approach

Wildfire broke out in Ford McMurray, Alberta, Canada on May 1, 2016. When first discovered, the size of the wildfire is 2 hectares. Due to the dry weather and wind, it spread quickly and was soon uncontrollable.

By 10 May 2016, the wildfire had reached 200,000 hectares. Emergency registry by Red Cross had been setup and 32,000 household were affected. 90,000 persons had registered with the Red Cross by then. The Government of Alberta was also offering a relief fund of 1250 Canadian Dollars per person with 500 Canadian Dollars for dependents, for people who were affected by the wildfire but asked those that are not really in need not to apply for the relief fund.

If all 90,000 persons registered at Red Cross's emergency registry applied for the relief fund offered by Government of Alberta, it would have cost millions of dollars in relief fund.

This is only a small fraction of the loss caused by the wildfire. Many people who were evacuated were faced with the grim consequence of the wildfire in multiple folds. Many of them lost their home. Many lost their jobs which were dependent upon the oil industry that had to shut down due to the wildfire. The financial loss due to the wildfire was mounting. It was also devastating to all the people affected.

The Forestry Department has on-going routine effort to manage wildfire all along with on-going fire management teams. Their routine effort includes the removal of dry grass by burning them off. They have cut down trees to reduce fuel size available. They have also put up fire status maps and update of wildfire status all available to the public on their website. Last but not the least, they have listed all the common causes of wildfire and provided advice on the actions necessary to avoid causing wildfire which include naked campfire and the use of OHV (Off Highway Vehicles). In spite of all the precautions and warnings taken, wildfires continue to break out, often becoming uncontrollable as they spread with the help of favourable dry weather, heat and wind.

On Mother's Day 2016, it was reported in the news that 2 persons died during the evacuation. In her televised report, the Alberta's Premier Rachel Notley was tearful when she talked about the devastating situation on Mother's Day, a happy occasion which had turned into a gloomy one due to the wildfire. Premier Rachel Notley proclaimed that the city contained hazardous material, water was not drinkable, 2,400 structures were destroyed.

How fast and how big the wildfire spread:

	Status	Area affected	Growth
May 1, 2016 4pm	Wildfire first discovered	2 hectares	Initial size of fire = 1x
May 2, 2016 12am	8 hours from start	60 hectares	30x
May 5, 2016	5 th day	85,000 hectares	42,500x
May 6, 2016	6 th day	100,000 hectares	50,000x
May 9, 2016	9 th day	200,000 hectares	100,000x
May 10, 2016	10 th day	229,000 hectares	114,500x
May 15, 2016	15 th day	251,000 hectares	125,500x
May 26, 2016	26 th day	566,188 hectares in Alberta and about 3,200 hectares in Saskatchewan Total: 569,388 hectares	284,694x
June 10, 2016	41 st day	589,995 hectares	

The Fort McMurray Wildfire as of May 10, 2016 had grown to be the most costly wildfire. Insurance cost for rebuilding was estimated to be 9 billion Canadian dollars.

2.2 Responsive design – the proactive approach

According to Chad Morrison, **Alberta province's senior wildfire official, the wildfire would not pose any danger to** the Suncor oil sands facilities which were located 30 km away from the wildfire. These sites were resilient to forest fire because they were cleared and free of vegetation. He also mentioned that all the oil sand facilities in the area were surrounded by wide firebreaks and were protected by their own highly trained fire crews. Nevertheless, Suncor and Syncrude had evacuated their facilities as a precautionary measure.

If we compare a forest to a building compound, we need to look at prevention and the provision of automatic detection systems and automatic fire fighting systems so that the fire can be detected at early stage before the fire size grow into uncontrollable size.

When fire size is about 2 hectares in the case of Ford McMurray, the fire-fighters already could not control the fire. So, it can be suggested that to control the growth of wildfire, fire size should be less than 2 hectares.

In a super tall building or a building with a very large footprint, the building will be divided into compartments of a certain size to make any breakout of fire more manageable. There will be automatic smoke detectors and automatic sprinkler systems which will ensure early detection of fire and early activation of the automatic sprinkler system to control the fire.

It is highly possible to place similar fire detection and fire-fighting systems in the forest as well. If forest can be covered by automatic smoke detectors and automatic sprinklers, then any wildfire will be detected earlier when the fire size is smaller, and with automatic sprinkler triggered, the water from the sprinkler will make the fire diminish or reduce in size. At the very least, it will help to reduce the chance of the fire spreading to a much bigger area and becoming uncontrollable with the rapid growth of the fire.

The grid for laying the automatic sprinkler system shall be more than one hectare. The closer the grid, the higher will be the chance of containment of the fire. One would immediately think about how costly this will be and will dismiss the practicality of implementation.

While the provision of automatic detection and sprinkler systems is not cheap, it makes sense when we compare this to the extreme high cost of restoration when big wildfire such as the one in Ford McMurray occurs.

Comparing to a large scale residential development such as Double Cove in Hong Kong where the total site area is about 5 hectares with over 2 hectares of greenery, we note that the greenery area of Double Cove is about the original size of the wildfire that broke out in Fort Murray, Canada. The Double Cove project, being a normal construction project, has an emergency vehicular access roads complete with street fire hydrants allow fire-fighters to reach each and every one of the twenty-one blocks of residential towers within this neighbourhood development. Each tower is also complete with standard fire fighting installations including smoke detectors, fire alarms, automatic sprinklers, fire services water tanks. Each floor is a fire compartment separated from the next floor with smoke lobbies, doors and walls of required fire rating.

Where there are people living or working in close proximity of forests, we should no longer consider the forest as undisturbed nature. Learning from the examples such as the oil sand facilities Suncor and Syncrude in Fort Murray area or the large scale residential development such as Double Cove in Hong Kong, we should adopt more preventive fire fighting design and management in the construction near the forest. In the case of large forest areas such as those in Canada, more investment in fire detection system and fire fighting system in the forests is a necessary investment which will help to save lives, save the forest, save jobs, avoid the trauma and even higher cost of post wildfire rebuilding of structures and communities.

Installation of automatic sprinklers is not a totally new invention. People have used automatic sprinklers to water their garden lawns at their homes or to water the extensive area of golf courses or man-made park areas. If such sprinklers were modified to form part of a fire-fighting installation for the forest, the wildfire will not be out of control as what have happened in the wildfire at Fort Murray in Canada. Smoke detectors in the forest can be connected to a fire control management centre so that wildfire will be detected when the size of wildfire is still small. Wildfire prevention and management should take advantage of modern day technology to adopt a more proactive approach in the design, planning, monitoring and management of forests similar to new building construction projects.

3. TSUNAMI IN JAPAN

The earthquake and tsunami in Japan that happened in March of 2011 caused the melt down of the Fukushima Daiichi Nuclear Power Plant operated by the Tokyo Electric Power Company (Tepco). While earthquake and tsunami is a natural disaster that cannot be avoided, the tsunami in the melt down of the Fukushima Daiichi Nuclear Power Plant is a disaster that could have been prevented.

It was noted that the Onagawa Nuclear Power Plant operated by the Tohoku Electric Power Supply (Tohoku Electric) near the Fukushima Daiichi Nuclear Power Plant was also affected by the tsunami. However, a report from the International Atomic Energy Agency mission found that the Onagawa Nuclear Power Plant had shut down safely and was unremarkably undamaged, even though it had experienced very high levels of ground motion.

Location wise, the Onagawa plant is located 123 kilometres away from the epicentre of the earthquake which is 60 kilometres closer to the epicentre of the earthquake as compared to the Fukushima Daiichi Nuclear Power Plant. Seismic intensity experienced by both nuclear power plants was similar. The tsunami at Onagawa was 14.3 metres high while the tsunami at Fukushima Daiichi was 13.1 meters high.

Given the same nature of the plant experiencing similar natural disaster of earthquake and tsunami, the result is very different.

Prior to **the plant's construction, Tohoku Electric conducted surveys and simulations to predict tsunami levels. Their** initial prediction was tsunami height of 3 metres based on historical average tsunami levels in that region. Based on this prediction, Tohoku Electric constructed their Onagawa nuclear plant at 14.7 metres which is about 5 times the historical average tsunami levels. As more research was carried out, the tsunami levels increased and Tohoku Electric conducted periodic check-up based on such new research results.

Fukushima Daiichi plant however was built at a lower elevation of 10 metres. Tepco had removed 25 metres from the 35 metres natural seawall at the Fukushima Daiichi plant site in order to enhance easy transportation of equipment and to save construction cost.

It was noted that the original construction of the Fukushima Daiichi plant was based on existing seismological information which was shown to be underestimated by later research. While Tohoku Electric learned from the past earthquakes and tsunamis and **continuously improve its counter measures, Tepco's approach was different. According to the Nuclear Accident Independent Investigation Commission (NAIIC)'s report that Tepco "resorted to delaying tactics, such as presenting alternative scientific studies and lobbying".**

In terms of emergency response, Tohoku Electric established an emergency response centre at the Onagawa **plant and at the company headquarters immediately after the earthquake. "Thorough the disaster, headquarters supported the plant operators minute by minute. Supervisors and chief engineers were dispatched to the main control rooms of the damaged reactors to make decision, and information was sent in a timely manner to all levels of the response team."**

The safety culture in Tohoku Electric at the Onagawa plant is observed to be very proactive and more transparent **as compared to Tepco at the Fukushima Daiichi plant. "After the disaster, Hasuike Tooru, the former president of Tepco, described how management decided to lengthen the expected lifetime of power plants, even if there were safety consequence.**

It is noted that the Fukushima Daiichi plant melt down can be prevented if it had adopted better safety approach in the planning and construction. If it had not removed 25 metres of the natural seawall of the Fukushima Daiichi plant site and the plant was built at a much higher elevation, the power plant could have been more resilient to the tsunami and like the Onagawa plant, the melt down of the Fukushima Daiichi nuclear plant may have been prevented.

4. FLOOD

In LEED for Neighbourhood Development 2009, the Green Building Certification for neighbourhood development of the US Green Building Council, under the Smart Location and Linkage (SLL) category - Prerequisite 5 Floodplain Avoidance, there are several options for floodplain avoidance as summarised below:

Option 1. Sites without Floodplains

The best strategy was to avoid locating the neighbourhood development within a 100-year high- or moderate-risk floodplain or to locate it entirely outside any floodplain subject to 1% or greater chance of flooding in any given year.

Option 2. Infill or previously Developed Sites with Floodplains

It requires the neighbourhood development to comply with National Flood Insurance Program (NFIP) requirements for any portions of the site that lie within a 100-year high- or moderate-risk floodplain. If the project includes construction of any critical facility, such as hospital, water and sewage treatment facility, emergency operation centre, emergency shelters or fire or police station, the critical facility must be designed and built to be protected and operable during a 500-year flood event.

Option 3. All other sites with Floodplains:

Requirements are similar to Option 2.

It is noted that there are two different standards adopted:

- Critical facilities which are considered to be important enough to remain operable after the flood are required to be located above floodwater levels representing 0.2% annual chance (500-year) flood.
- Other buildings and facilities that are not defined as being critical are subject to a much lower standard and are only required to be located above floodwater levels representing 1% annual chance (100-year) flood.

Based on such double standard, all the homes for people are not considered as critical. This really means that in order to seek a place that is safer, people must evacuate from their homes and move to emergency shelters or hospitals.

In the devastating flood that was brought by hurricane Katrina to New Orleans in the United States in August 2005, we can see how homes were destroyed and many people had evacuated from their homes. Even though they sought refuge at emergency centres, their living conditions were undesirable and often just as devastating. There were deaths reported and the city of New Orleans was mostly destroyed. The post disaster reconstruction of the city was extremely costly.

In August 2016, the Federal Emergency Management Agency (FEMA) finally proposed regulations that would require companies and homeowners using federal funds on construction projects in flood-prone areas to build on higher ground based on the following three options:

- Build 2 feet above the 100-year floodplain level for standard projects, or
- Build 3 feet above the 100-year floodplain level for **“critical action” projects such as hospital or nursing homes;**
- Build to the 500-year floodplain.
- Use the best available scientific models which combine flood records with other factors e.g. sea-level rise data.

It is noted that there were concerns from business groups and politicians that this new regulation will result in higher cost for builders and the cost of recovery for areas which have suffered flooding will be more expensive. This point of view emphasizes cost saving rather than the importance of investment for design for safety in the first place.

Although FEMA's proposed regulations only applies to companies and homeowners using federal funds on construction projects in flood-prone areas, such regulations should also be applied to those projects not using federal funds so that such higher standard for design for safety can be adopted for all buildings.

5. CONCLUSION

Apart from natural disasters, there have been many other disasters that resulted in loss of life, loss of properties, destruction of neighbourhoods and cities.

From the gas explosion of underground gas pipes in Kaohsiung in 2014 in Taiwan to the collapse of buildings and roads due to poor construction or lack of proper monitoring or maintenance, there are man-made disasters that could have been prevented by proper design and planning.

Responsive design that takes into consideration of the worst case scenario shall be in place from day one. There shall be no excuse to lower the standard to save initial cost of construction or operation. Any compromise in the initial stage may lead to even higher costs for post disaster rebuilding of the neighbourhood and cities that are affected. **In addition to the cost of reconstruction, the cost of people's life is priceless.**

Responsive design is design that can respond to the situation in the best possible way. It takes innovating thinking to adopt strategies that are preventive and should exceed the conventional thinking of how neighbourhoods and cities are built, maintained and operated in order to make our neighbourhoods and cities truly sustainable.

REFERENCES

- [1] Alberta Agriculture and Forestry. Available from: <http://wildfire.alberta.ca/wildfire-status/default.aspx> [1 May 2016] to [10 June 2016]
- [2] Airi Ryu & Najmedin Meshkati, 2014. Onagawa: The Japanese Nuclear Power Plant That Didn't Melt Down on 3/11. Available from: <http://thebulletin.org/onagawa-japanese-nuclear-power-plant-didn%E2%80%99t-melt-down-311> [30 September 2016]
- [3] Dow Jones Newswires, 2016. FEMA Proposes Rules for Construction in Flood Areas. Available from: <http://www.nasdaq.com/article/fema-proposes-rules-that-push-rebuilding-after-floods-to-higher-ground-20160822-00708> [30 September 2016].
- [4] LEED for Neighbourhood Development 2009, US Green Building Council, Washington.
- [5] Effects of Hurricane Katrina in New Orleans, Wikipedia, 2016. Available from: https://en.wikipedia.org/wiki/Effects_of_Hurricane_Katrina_in_New_Orleans. [30 September 2016].

Conceptualizing Sustainable Neighbourhoods through Collaborative Placemaking

Solomon ADEWUMI^a, Husam ALWAER^b, Vincent ONYANGO^c

^a University of Dundee, United Kingdom, s.a.adewumi@dundee.ac.uk

^b University of Dundee, United Kingdom, h.alwaer@dundee.ac.uk

^c University of Dundee, United Kingdom, v.onyango@dundee.ac.uk

ABSTRACT

Neighbourhood planning which dates back to the closing decades of the nineteenth century has metamorphosed under various movements in an attempt to evolve places that are socially responsive, economically viable, and environmentally friendly. With the constraints of rapid urbanization, climate change, financial instability coupled with significant demographic and social changes, the ability of the contemporary approaches to neighbourhood planning have been questioned, as to if it can lead to delivery of sustainable settlements. In addition, the potential of a single-specialist profession thinking as the 'messiah' to resolve the dynamic urban problems has been challenged. This paper proposes how placemaking, which promotes citizens' involvement and engagement in the plans and policies that shape the places where they live through an inclusive, collaborative, and design-led initiatives can provide a basis of a suitable approach for sustainable neighbourhood planning. The paper examines the nature of contemporary approaches in neighbourhood planning in the context of both developed and developing nations. While some degree of progress have been recorded by applying some of these initiatives across the various context, findings show that there is an urgent need to respond to the obvious shortcomings associated with the sectoral and individual attempts to tackle the problems that confronts the 21st century neighbourhoods. In proposing the transdisciplinary and collaborative placemaking approach, its salient key features and processes are highlighted in this paper and how it could be the game changer in delivering sustainable neighbourhoods. The paper concludes with recommendations on how collaborative placemaking can further be enhanced in practice, academia, and in policy making.

Keywords: collaborative placemaking, neighbourhood, sustainable

1. INTRODUCTION

The neighbourhood can be regarded as the building block of a city with a potential to determine the sustainability of that particular nation as it has been well established that the battle for sustainable urban planning will be won or lost in the city (Komeily & Srinivasan, 2015). This submission clearly justifies the attention that the neighbourhood scale of spatial development deserves as the planning unit of urban centres (Rohe, 2009). While the campaign for sustainable urban planning has continued to take the central stage in academia, practice, and policy making (Berardi, 2011), of necessity is the need to examine how it can best be delivered at the neighbourhood level. Since the beginning of the 20th century till date, there have been several approaches adopted to evolve sustainable settlements- an endeavour that has resulted to the emergence of various movements. However, taking an unbiased view to assess the state of neighbourhoods in both developed and developing country context, the ideal neighbourhood suggested by Roberts (2009:128) where people 'can live, work, prosper, and enjoy good quality of life now and in the future' is still a challenge to the 21st planning.

Aside from the generic sustainability issues like environmental degradation, global warming, and social inequality among others, various countries of the world are seeking for ways to abate their peculiar sustainability challenges. Developed countries like the USA are battling urban sprawl and high car dependency; UK is trying to reduce energy demand and consumption (Edwards, 2014) while developing countries like Nigeria for example is confronted with urban slum, inadequate amenities and infrastructures, waste control and management, and insecurity. The aim of this paper therefore is to conceptualize sustainable neighbourhood through collaborative placemaking. The objectives to be pursued are: (i) to examine sustainable neighbourhood planning; (ii) to examine the contemporary approaches to neighbourhood planning in different context and their shortcomings in order to justify a need for a paradigm shift; (iii) to introduce the concept and key issues of collaborative placemaking; (iv) to examine the nexus between collaborative placemaking and sustainable neighbourhood planning.

Although there have been series of studies carried out independently on sustainable neighbourhoods (Barton et al., 2010; Barton, 2000; Wheeler, 2013) and placemaking (Arefi, 2014; Parlemo and Ponzini, 2015), there is no evidence in literature of a study that to establish a correlation between sustainable urban neighbourhood planning and collaborative placemaking. This is therefore a fundamental gap in research which this paper attempts to address. How can a sustainable neighbourhood be conceptualised through collaborative placemaking is the main research question of this study.

2. WHAT IS A SUSTAINABLE NEIGHBOURHOOD?

A neighbourhood is a local unit within which people are personally acquainted with each other by reason of residential proximity (Lynch, 1981). While the term neighbourhood could be subjective in terms of its size, it should typically refer to an area that can be traversed by foot with some distinct and unifying social, architectural, historical, and economic features (Wheeler, 2013). Although, 'neighbourhood' and 'community' are often used interchangeably in literature, the former refers to the fabric (such as streets, buildings, facilities, and green spaces) while the later refers to the people in the neighbourhood (Barton et al., 2010). A sustainable neighbourhood according to Roberts (2009) is the spatial manifestation of sustainability principles. A sustainable neighbourhood should be compact, supports pedestrian movement, and mixed-use in design in which many daily living activity can be carried out within the shortest possible distance through interconnected networks of streets (Charter for the New Urbanism, 2015). A sustainable community according to the ODPM (2004) must address the issues of good governance; transport and connectivity; services; environmental; economy; housing and built environment (figure 1).

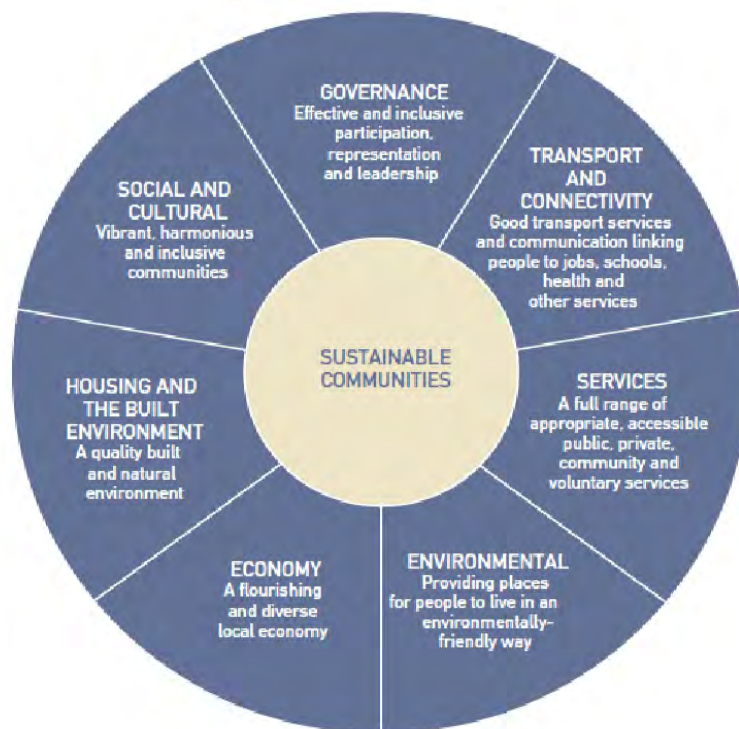

Figure 1: A sustainable community (Source: Egan Review, 2004)

3. CONTEMPORARY APPROACHES TO NEIGHBOURHOOD PLANNING AND THE NEED FOR A PARADIGM SHIFT

Although the neighbourhood planning predates the concept of sustainability, the campaign for sustainable urban planning at the local level (chapter 28 of Agenda 21) led to renewed interest in developing new initiatives and paradigms to address sustainability issues at the neighbourhood scale of spatial development (Farr, 2008; Rohe, 2009). Prior to this time in history, attempts have been made to create liveable, environment-friendly, and prosperous places through the neighbourhood planning model. The sustainable neighbourhood planning is **therefore an extension of urban planning and design trends of the early 20th century works of Ebenezer Howard's Garden city; the Neighbourhood unit of Clarence Perry; the modernism movement initiated by Le Corbusier and**

Frank Lloyd Wright; the neo-traditional (new urbanism) movement of the likes of Andres Duany, Elizabeth Plater-Zyberk, Peter Calthorpe; the eco-urbanism; and the latest being the smart growth movement (an advancement to the neo-traditional movement).

Contemporary approaches to enhance sustainable neighbourhood planning are traceable to several initiatives from the academia, practitioners and policy makers in various parts of the world. In the developed countries, the 21st century heralded the development of Neighbourhood Sustainability Assessment Frameworks through which a master plan can be evaluated against an array of Sustainability criteria and indicators (Al Waer and Kirk, 2015). Sustainability Assessment is carried in order to evolve a better scheme of development (Gibson et al., 2005) by integrating a wide range of assessment practices that are concerned with long-term impacts of development (Al Waer and Kirk, 2015). Examples of these frameworks include BREEAM communities in UK; LEED for Neighbourhood development in USA; CASBEE in Japan; and Green STAR Communities in Australia among others. Coupled with these assessment frameworks was the development of the Neighbourhood Quality Assessment Tools which can be used to assess the quality of neighbourhoods (Nickelson et al., 2013). Several governments **agenda like the 'Towards an urban renaissance' (a report by the UK Urban Task Force) of 1999; The Planning Advice Note (PAN, 83 prepared by the Scottish government in 2008); and the Plan 2030 of the Abu Dhabi Planning Council** are also worth mentioning.

While Neighbourhood Sustainability Assessment frameworks and Quality Assessment Tools are yet to evolve in most developing countries (Berardi, 2013), the existing planning laws are outdated and as a result have failed to meet the present urbanization demands and challenges. What is observable in these countries is the adoption of urban neighbourhood regeneration which is the reconstruction and upgrading of deteriorating neighbourhoods. It is a deliberate effort to effect a change in an urban environment by large scale adjustment of existing area to meet the present and future requirements for urban living and working. However, not much progress have been recorded with these initiatives as expected in both developed and developing countries context due to the persistent urban problems that are obvious. Consequently, the ability of the contemporary approaches to neighbourhood planning in the 21st century has been questioned. The Neighbourhood Sustainability Assessment framework for instance has been questioned on the basis of the following uncertainties:

- The involvement stakeholders in its development (Brandon and Lombardi, 2011; Sala et al., 2015)
- The consideration of existing statutory and legal planning framework (Berardi, 2011)
- Adoption of a holistic approach of sustainability issues and how balanced it is in its choice of indicators (Srinivasan and Komeily, 2015);
- Whether it can be adopted for use in another context (Joss et al., 2015).

While the urban regeneration programme has helped in revitalizing the urban neighbourhoods in developing countries by evolving new houses, apartments, offices, shops, schools, the approach has been criticized as it most often result to break-up of communal relationship; congestion of the nearest neighbourhood due to migration of displaced residents; and the upsetting existing economic systems and opportunities. These identified limitations of the contemporary approaches to neighbourhood planning in both developed and developing countries context call for a paradigm shift in the planning and delivery of the 21st century neighbourhoods.

4. PLACEMAKING

4.1 Basic concepts and key aspects

Placemaking is a collaborative process of shaping a community's public realm with a goal to maximize shared value through creative pattern of use and emphasis on the physical, cultural, and social identities that defines a place (Project for Public Space, 2016). Making better places is not new as the earlier works of Jane Jacobs in *The death and life of great American cities* (1961); William H Whyte in *The social life of small urban spaces* (1980) and Kevin Lynch in *The Image of the City* (1960) attest to this. In recent times, the works of Jan Gehl in *Cities for people* (2010), *How to study public life* (2013), *Public space, public life* (1996); and Herbert Girardet in *Cities People Planet* (2010), while advocating for placemaking provide practical guidelines for creating liveable, healthy, and safe places. Placemaking according to Arefi (2014) can triggered by needs, opportunities, or by assets as shown in figure 2 and explained:

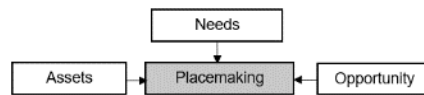

Figure 2: Placemaking paradigms (Source: Adapted after Arefi (2014))

While the placemaking stimulated by the forces of needs and opportunity have been criticised for being a top-down approach, with dependency on government resources and the sovereignty of expert knowledge over local knowledge, asset-based placemaking creates an atmosphere of synergy and interaction within which experts and non-experts can have a common ground for the planning of long term needs (Arefi, 2014). This is collaborative placemaking as shown in figure 3:

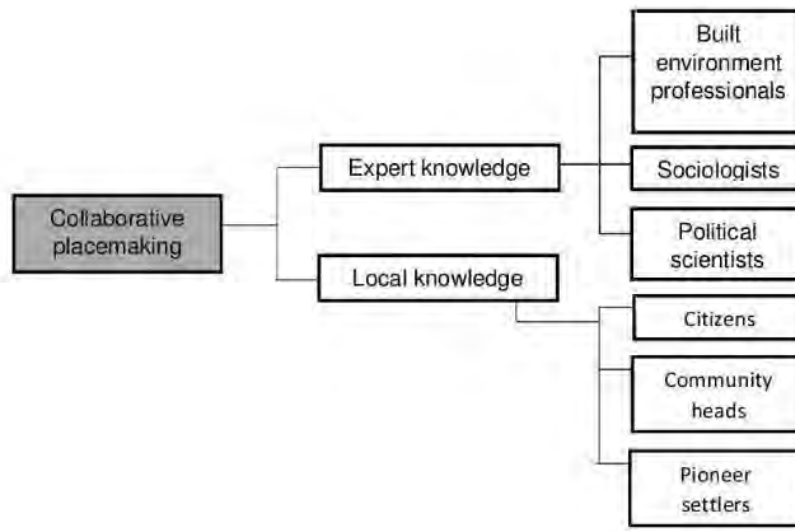

Figure 3: The Collaborative Placemaking (Source: Adapted after Arefi (2014))

4.2 Process of collaborative placemaking (From space to place)

Making better places is a universal activity as people consciously and unconsciously try to shape the places where they live with or without professionals. Schneekloth and Shibley (1995) however argued that professionals can contribute to this unconscious process in a deliberate way in the following three stages: (i) creating a dialogic; (ii) dialectical work of confirmation and interrogation; and (iii) framing action. (Figure 4)

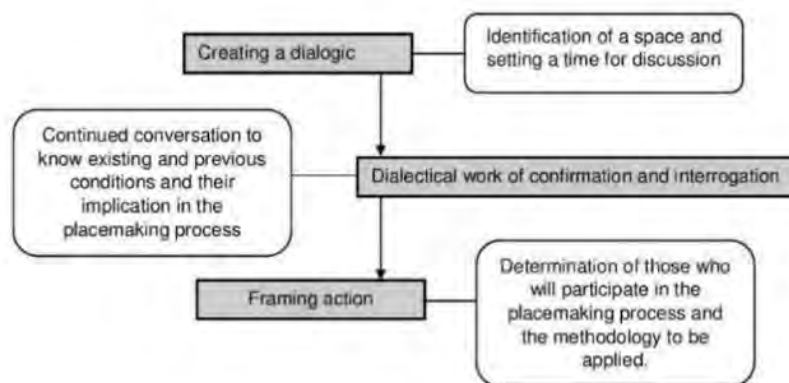

Figure 4: The placemaking process (Source: Adapted after Schneekloth and Shibley (1995))

5. DISCUSSION

The previous sections of this paper provided the theoretical understanding of sustainable neighbourhood planning and collaborative placemaking. This section attempts to establish the nexus between both concepts by examining the question of how well does collaborative placemaking address principle of sustainable neighbourhood planning.

5.1 Needs and assets in sustainable neighbourhood planning

Sustainable neighbourhood planning is driven by the needs which vary from one particular context to another. In neighbourhood planning, there is need to consider the existing assets in terms of physical and social capital and how it be identified, leveraged, and managed. It has been argued that what makes a neighbourhood sustainable is determined by how it has been able to explore its local assets (Gibson et al., 2005).

5.2 Sustainable neighbourhood planning as a long term vision

While progress can be monitored intermittently, the sustainability of a neighbourhood can only be assessed on a long term scale. This can be justified on the basis that sustainability considers both the present and future **generations (intergenerational and intragenerational equities)**. **Placemaking is termed to be a 'work-in-progress'**. Plans do evolve and change (as a result of monitoring in the placemaking process) into a more sophisticated and complex one (Arefi, 2014). It is this possibility whereby plans can be reviewed and monitored as a result of the environmental, social, and economic challenges that sustainable settlements evolves.

5.3 Social learning and knowledge sharing

In recent times, attaining sustainable neighbourhoods has gone beyond environmental concerns, as the issue of governance in terms of public participation and engagement have well been advocated for (Brandon and Lombardi, 2011). One of the key **objectives of sustainable communities' skills and knowledge agenda is to transform the** closed disciplinary and professional territories and boundaries into open institution landscape (Roberts, 2009). Equitable and sustainable development can be encouraged through placemaking that engages all users (Project for Public Spaces, 2016). That is, an opportunity where social learning and knowledge sharing can be enhanced through the synergy of both local and expert knowledge. This can be actualized through charrette, workshops, and focus groups among others. Also, attempts by an architect to enhance architecture of place will only result to mere artistic statement without consulting and engaging with the local community in evolving solutions.

5.4 Security, local economy, health, and public realm

Undoubtedly, security, local economy, and public realm are key criteria to be considered in assessing the sustainability of a neighbourhood. Placemaking in its process advocates for mixed-used development, walkable neighbourhoods which enhance safety through easy surveillance in the neighbourhood as against the concepts of gated communities and disconnected neighbourhoods noticeable in most developing countries. Collaborative placemaking also has the potential to drive local economy through innovation, usage of local construction materials and workforce while also advocating for business ownership and retail sales centres. In addition, collaborative placemaking prioritise the community needs by ensuring that the neighbourhood planning enhances the physical, mental, and social health of individuals and the entire community (Project for Public Spaces, 2016)

6. CONCLUSIONS

This paper attempted to conceptualize a sustainable neighbourhood through collaborative placemaking. The limitations of the contemporary approaches to neighbourhood planning in both the developed and developing countries were discussed which justified the need for a paradigm shift. The placemaking approach that enhances **citizens' engagement in the planning and delivery** of the places where they live as against the expert-led contemporary approach was introduced. How this concept could lead to a sustainable neighbourhood was explained in this paper. In order to enhance collaborative placemaking as a solution for 21st century neighbourhood planning challenges, there is need to make its outcomes and delivery clearly visible so as to be well appreciated and recognised. A review of professional ethics and practices is also important by advocating for a behavioural change. Professionals should learn to imbibe the ethics of engaging with local knowledge and non-experts who by their local experience will contribute significantly to their planning and design decisions.

REFERENCES

- [1] AlWaer, H. & Kirk, R., 2015. Matching a community assessment tools to the requirements of practice. Proceedings of the institution of civil engineers: Urban design and planning.
- [2] Arefi, M., 2014. Deconstructing Placemaking. Oxon: Routledge.
- [3] Barton, H., 2000. Conflicting Perceptions of Neighbourhood. In: H. Barton, ed. Sustainable Communities: The Potential for Eco-Neighbourhoods. London: Earthscan Publications Ltd, pp. 3-18.
- [4] Barton, H., Grant, M. & Guise, R., 2010. Shaping neighbourhoods for local health and global sustainability. 2nd ed. Oxon: Routledge.
- [5] Berardi, U., 2011. Beyond Sustainability Assessment: Upgrading topics by enlarging the scale of assessment. International Journal of Sustainable Building Technology and Urban Development, Volume 2, pp. 276-282.
- [6] Brandon, P. & Lombardi, P., 2011. Evaluating Sustainability development in the built environment. Oxford: Wiley-Blackwell Publishing Ltd.
- [7] The charter of the new urbanism, The Neighbourhood, the district, and the corridor [Online] Retrieved from: <http://www.cnu.org/who-we-are/charter-new-urbanism> [Retrieved on 14 September 2016]
- [8] Farr, D., 2008. Sustainable urbanism: Urban design with nature. New Jersey: John Wiley & Sons.
- [9] Gehl, J., 2010. Cities for people. Washington: Island Press.
- [10] Gehl, J. & Gemzoe, L., 1996. Public spaces, public life. Copenhagen: Danish Architectural Press and the RDA of Fine Arts, School of Architecture .
- [11] Gehl, J. & Svarre, B., 2013. How to study public life. Washington: Island Press.
- [12] Gibson, R. et al., 2005. Sustainability Assessment: Criteria, Processes and Application. London: Routledge.
- [13] Girardet, H., 2008. Cities people planet. 2nd ed. Hoboken New Jersey: Wiley.
- [14] Jacobs, J., 1961. The death and life of great American cities. New York: Random House.
- [15] Joss, S. et al., 2015. Tomorrow's City Today: Prospects for Standardising Sustainable Urban Development, London: University of Westminster.
- [16] Komeily, S. & Srinivasan, R., 2015. A need for a balanced approach to
- [17] Neighbourhood Sustainability Assessment. Journal of sustainable cities and society, Volume 18, pp. 32-43.
- [18] Lynch, K., 1960. The image of the city. Cambridge: MIT Press.
- [19] Nickelson, J., Wang, A, R., Mitchell, Q, P., Hendricks, K. & Paschal, A., 2013. Inventory of the physical environment domains and subdomains measured by the neighbourhood audit tools: a systematic literature review. Journal of Environmental Psychology, 36, pp. 179-189.
- [20] Office of the Deputy Prime Minister ODPM, 2004. The Egan Review: Skills for Sustainable communities. London, RIBA Enterprises Ltd
- [21] Parlemo, P. & Ponzini, D., 2015. Place-making and Urban Development: New challenges for contemporary planning and design. Oxon: Routledge.
- [22] Roberts, P., 2009. Sustainable communities. In: I. Cooper & M. Symes, eds. Sustainable Urban Development- Changing Professional Practice. Oxon: Routledge, pp. 127-144.
- [23] Rohe, W., 2009. From Local to Global: One hundred Years of Neighbourhood Planning. Journal of the American Planning Association, 75(2), pp. 209-230.
- [24] Sala, S., Ciuffo, B. & Nijkamp, P., 2015. A systemic framework for sustainability assessment. Ecological Economics, Volume 119, pp. 314-325.
- [25] Schneekloth, L. & Shibley, R., 1995. Placemaking: the art and practice of building communities. New York: Wiley.
- [26] Project for public spaces, what is Placemaking? [online] Retrieved from: http://www.pps.org/conference/what_is_placemaking/ [Retrieved on 14 September 2016]
- [27] Wheeler, S., 2013. Planning for Sustainability: Creating livable, equitable and ecological communities. 2nd ed. Oxon: Routledge.
- [28] Whyte, W., 1980. The social life of small urban spaces. New York: Project for public spaces.

A Conceptual Model of Integral Sustainable Design Framework

Wilson YIK^a, Dicken POON^b, Matthew LEE^c, Ivy SW LEE^d

^a Leigh & Orange Ltd, Hong Kong SAR, wilson.yik@leighorange.com

^b Leigh & Orange Ltd, Hong Kong SAR, dicken.poon@leighorange.com

^c Leigh & Orange Ltd, Hong Kong SAR, matthew.lee@leighorange.com

^d Leigh & Orange Ltd, Hong Kong SAR, ivy.lee@leighorange.com

ABSTRACT

The fundamental shift of design thinking towards embracing co-evolutionary and partnered relationship between socio-cultural and ecological systems is critical in combating climate change. Immediate radical reduction of anthropogenic greenhouse gas emissions is demanded to keep the global average temperature rise within 2 degree Celsius. Meanwhile, drastic enhancement of building energy efficiency further exhausts technologies, which means exceeding potential planetary boundaries for the long run. However, meaningful actions are delayed firstly due to the long-standing disparity of the perceptions and standards towards “good” and “green” design. Secondly, externalization of sustainable designs consideration during the design process is a common practice among practitioners. The built environment of today remains impactful in decades to come, which unequivocally represents the window of time where effective changes are still possible to avert catastrophic climate consequences. Therefore, we are here to explore an effective and integrative instrument that bridges the gaps within the local practice that is imperative to the juncture in meeting our obligation towards global climate change.

This paper examines the fundamentals of sustainability, drawing on an interdisciplinary body of literature relating to, inter alia, ecological and regenerative design principles as well as established integral theories. We would explore and introduce the conceptual model of integral sustainable design framework in transcending awareness and the know-how of architecture practitioners. Through the guiding principles devised to enable vigorous engagement with the implications and consequences of design decision in facing the 21st century environmental challenge, this framework ultimately celebrates the gift of creative capacities for the richness of architecture making in the era of transition.

Keywords: regenerative design, ecological design, climate change

1. INTRODUCTION: CHALLENGES OF OUR ARCHITECTURAL PRACTICE

Integral Sustainability Design is an emerging term originating from the theory of ecological and regenerative design (Wackernagel et al. 2002; Mang & Reed 2012; Moffatt & Kohler 2008). The concept of integration challenges whether the current practice of sustainable development is indeed sustainable (DeKay 2012; Raco 2005; Whitmarsh 2012). If we refer sustainability as the ability to re-establish cooperation between human and nature for mutual beneficial development, it would be a great depart from the regenerative definition in the Brundtland Report (Sadler-Smith, 2015; WCED, 1987). The key difference between the two paradigms resides in two substantially different goals (Conte & Monno 2012; Fraser et al. 2006; Kwok & Grondzik 2007). In the first scenario, sustainable development is targeting at reducing the natural resource depletion and the environmental impacts while maintaining the current architectural practice (Conte & Monno 2016; Chen et al. 2015). As for the latter, regenerative design reverses the current trend of consumption in the ecological-system indispensable for the human race existence (Mang & Reed 2012; DeKay 2012). The built environment is the most significant field of action because it represents the socio-cultural identity at the local, regional and global level (Conte & Monno 2016; Bond 1999). In the meanwhile, the shift of value in designing the built environment can better utilize resources and minimize impacts within the ecological boundary of the planet.

In this essay, we would first identify the limitations of the traditional building centric design process. The perception of “green” design is stereotypical and often technological charged (Holden et al. 2014; Chen et al. 2015). It represents implementation of macro-level policies, plans and programmes (Baresel et al. 2006; Iwaro & Mwashia 2013). Sustainability assessments become the only instrument to determine the building performance (Howard et al. 2008; Poveda & Young 2014). The documentation process is complex and commonly externalized. Certification highly relies on the top-down command weighting each criterions by cost-effectiveness (Fraser et al. 2006; Moffatt

& Kohler 2008; Conte & Monno 2012). Therefore, we would explore different ways of design thinking for fundamental shift in values, not as substitute, but as complement to the current rating system (Dorst 2001; Conte & Monno 2012). The theory of ecological and regenerative design offers an alternative inter-disciplinary perspective on design (Wackernagel et. Al. 2002; Moffatt & Kohler 2008; Hosey 2012). It proposes frameworks that are open and heuristic for innovation. Through simple guiding rules in a socio-ecological perspective, integral designs inducted from the regenerative values and facilitate massive-small change from the bottom-up (Fraser et al. 2006; DeKay 2012). With the early adoption of eco-centric world view, we conclude that integral design would no longer be externalised as a particular sustainable check box (Poveda 2014; Wright & Alajimi 2016). Embedding qualitative reflection process in the current architectural practice, integral sustainable design would be integral design simply.

2. LIMITATION ON TRADITIONAL DESIGN PROCESS

2.1 Disparity between “Good” and “Green” design

Architectural practices, as a knowledge-based profession, are challenged to reconfigure their traditional design process. **Established firms’ architectural knowledge is rooted in the social channels, systemic filters, and individual strategies** (Henderson et. al. 1990; Blizzard 2012; Board et. al. 2015). As a result, the discovery process and the creation of new information take time. The cooperation often is tempted to modify the existing system rather than incurring the substantial friction required to build new sets of design method from scratch (Poveda 2014; Geels 2011). According to Dorst (2012), the challenge of dealing with open and complex problems, like Climate Change, **leads to particular interest to create “frames”**. **Design organizations deal with frames in their field of practice as part of collective consciousness called “design thinking”** (McHarg 1969; Raco 2005). The term implies deliberate strategies tackling complex challenge by coming up with an intervention (what) which is induced from the **framework of its working principle (how) and “value”**. In other words, the strategy involves developing a specific “frame” by applying principles that generate values (Dorst & Cross 2001; Dorst 2011). In the context of Climate Change, we attempt to develop a design framework with guiding principles that cultivate the value in securing a sustainable future.

The economic benefits of “green” buildings fall into four areas according to Yudelson (2008). Firstly, decreasing the electricity consumption which is the dominant energy source for buildings would reduce the operating cost (Yudelson 2008; Poveda 2014). Secondly, comprehensive functional testing of energy systems before occupancy could minimize the maintenance cost (Yudelson 2008; Sadler-Smith 2015). Furthermore, energy efficiency can significantly increase the building value cost (Yudelson 2008; Chen et. Al. 2015). Lastly, the tax benefit offered by the local authorities is the primary incentive for the implementation of “green” strategy cost (Yudelson 2008; Sullivan 2012). However, designers are confused when energy efficiency is equivalent to “good” design and compliance to the rating scheme is “green”. Paraphrasing Horsey’s (2012) quote during Peter Eisenman’s interview, “green” design and sustainability are irrelevant to architecture. “Green” design has a reputation of all substances and no style (McHarg 1969; Horsey 2012). The stereotype of sustainability as exclusively technical and ugly comes from the polarized values of “aesthetics” versus “environment”. In the current debate on “green” design, the iconic buildings by “Starchitect” represent unsustainable development on one end; environmental and sustainable rating system (ESRS) present a particular vision on “sustainability” on the other end (Yudelson 2008). It is a common practice for project managers to divide the job between designers and environmental experts in creating aesthetically-pleasing building while externalizing sustainable tasks in complying certification criterions (Mang & Reed 2012; Iwaro & Mwashia 2013). The selection of categories of water and energy consumption, greenhouse gas emissions and waste reduction are independent to the design process.

2.2 Complex rules and self-perpetuating process of externalization

The primary framework of the current practice of “green” design is indeed grounded in the environmental and sustainability rating system. The evaluation methods translated into assessment system is the common tool for communication among the actors in the building industry (Henderson & Clark 1990; Holden et. Al. 2014). In the sustainable urban development process, ESRS is a benchmark to measure the rate of sustainability in buildings, neighbourhoods and cities (Iwaro & Mwashia 2013; Poveda & Young 2014). However, the inherent limitation in ESRS is beyond aesthetic. It leads to a self-perpetuating process of externalization. Fundamentally, the location of a project renders majority of pilot sustainability project uncertified (Holden et. al. 2014; Wright & Alajimi 2016). **On the contrary, achieving “energy efficiency in buildings” and “reduced water use” would be rewarded**

comparatively fewer points, although these strategies contribute to the sustainability of the project by itself without requiring occupants to change their behaviour (Reed 2009; Hosey 2012). Furthermore, the subjectivity in weighting the importance of the criteria is ambiguous. It is difficult to determine which strategy would have higher contribution. Lastly, the incompatibility between ESRS and the unique local conditions impeded adoption aligning with the local sustainability development goals (Garde 2009; Board 2015). The role of rating system is questionable when the ESRS is irrelevant to local contexts.

The voluntary approach encourages developers to attain certification with minimal changes. Thus, the cost-effectiveness becomes the determining factor of final implementation. Unfortunately, projects that do not meet the prerequisite of the ESRS are often overlooked even if the design retains a higher regenerative value in comparison to a certified project (Howard et. al. 2008; Garde 2009). Nevertheless, the complex rules underlined and exhaustive documentation work in ESRS led to externalization of the sustainability design (Iwaro & Mwashia 2013; Conte 2016). As a result, ESRS is usually outsourced to the environmental consultants, while designers are blind-sided in the process. This defeats the purpose of ESRS as a tool to inform, design and educate (Kwok & Grondzik 2007; Reed 2009; Sullivan 2012). We argue that building can sustainably behave without a large content of advanced eco-technologies (Mang & Reed 2012; Conte & Monno 2016). Therefore, we are motivated to set-up some proactive guiding principles to address the limitations in the building-centric assessment where sustainability is achieved at its minimal standards of performance.

2.3 Top-down command control

The current unilateral approach to developing, adopting, and implementing ESRS originates from the top-down command control tradition (Fraser et. al.2006; Moffatt & Kohler 2008; Wilnaz & Daly 2016). In the building industry, authoritative decision-making structure can implement programmes efficiently; However organizations fail to include participation of the end-users (Holden et. al. 2014; Wright & Alajmi 2016). On the contrary, decentralization of decision and political controls is often perceived as creating conflicts between stakeholders (Raco 2005). It is a common practice to develop environmental management plan by hiring trained experts (Holden et. al. 2014). However, the failure of top-down implementation is due to the disparity between detailed local knowledge of the individuals and the community support composed mainly of the practitioners and architects (Howard 2008; DeKay 2012). **Adopting Dorst's (2011) principle of design thinking, the assessment is the intervention (what) while the rating system defines the working principle (how) for decision making.** In a reflective research conducted by Garde (2009), the qualitative findings suggest that the majority of respondents, who are developers, designers and consultants, find the rating system useful for informing sustainable design. **From the respondents' observation, the certifications mainly generate publicity and give them marketing advantage (Garde 2009).** ESRS also streamlines the project approval process because the local officials recognize the appraisal as bench-marking (Garde 2009). However, this way of sustainable development is only targeting at reducing the natural resource depletion and the environmental impacts while maintaining the current architectural practice (Moffatt & Kohler 2008; Mang & Reed 2012). In the neoliberal paradigm, sustainability is viewed as re-establishing the cooperation between human and nature for mutual beneficial development (Sadler-Smith, 2015; WCED, 1987). Therefore, we argue that the **convention "check-list" approach is not embodying the regenerative value of sustainability and the top-down governance structure needs to evolve.**

3. INTEGRAL DESIGN CONCEPTUAL FRAMEWORK

3.1 Theory of integral, ecological and regenerative design

The structure of integral design conceptual framework in the built environment is found on the socio-ecological system (SES) perspective. Moffatt and Kohler (2008) described SES as multiple-related metabolisms that interact with one another at different time scales. The tension between the nature and built environment becomes a dynamic attribute that changes within the historical context (Wackernagel 2002; Moffatt & Kohler 2008). The integral theory set up a common framework by combining the flow-based models, resource-conservation-based models and top-down and bottom-up model (Fraser et. al.2006; Moffatt & Kohler 2008; Wilnaz & Daly 2016). Different from the quantitative assessment ESRS as a retrofit in the traditional design process, ecological models encourage adaptive and resilience design in building from the start (Reed 2009; Hosey 2012). The regenerative management is a co-evolution of the social-ecological system for the long term. SES incorporates the ecological concept of time with the history of nature and human culture (Wackernagel 2002; Moffatt & Kohler 2008). This life-

cycle orientated design methodology addresses two major deficiencies of the building industry of today (Moffatt & Kohler 2008; Conte & Monno 2012). Firstly, the negligence of the spatial characteristic of the environment disconnects with the physical flows. SES attempts to integrate the morphological and physiological process within the analytical methods and design decision-making process to negate this phenomenon (Moffatt & Kohler 2008; Conte & Monno 2012). Secondly, majority of the ESRS evaluation method is temporal which disregards the economic discounting of the built environment in the ecosphere (Moffatt & Kohler 2008; Conte & Monno 2016). The incapability of forecasting and back-casting scenarios renders most sustainable development irrelevant. The simplistic concept of time is the biggest hurdle to effectively develop applicable concept to our built environment (Moffatt & Kohler 2008). Therefore, regenerative designs incorporate the time factor in SES which takes sustainable development further by reversing the current trend of exhaustive consumption in the built environment.

Regenerative design relies on a developmental process that enhances the value of the whole and takes the system to the next level. Furthermore, integration would evoke a set of higher orders and develop the capacities for pursuing the goals context (Wackernagel 2002; Moffatt & Kohler 2008). Integral design conceptual framework departs from the traditional design process above where value is a two-dimensional combination of an intervention (what) and its working principle (how). The theory of ecological and regenerative design is a dynamic three dimensional process (Mang & Reed 2012; DeKay 2012). On the left vertex of the triangle in Figure 2, aligning human development efforts with the creative efforts of nature is the key to achieve sustainability. Meanwhile, co-creative partnership between people and the planet is activated by the aims and aspirations on the right (Mang & Reed 2012). The complementing relationship between the alignment and activation would eventually achieve regenerative action.

3.2 Fundamental shift of values from bottom-up

A collective balance ought to strike between the need to build climate resilience rapidly and to encourage inclusion of marginalised voices in order to change the way we design. Climate science agencies should be able to contribute in decision-making, planning and implementation (Geels 2011; Whitmarsh 2012). The process of engaging people in designing is a great opportunity for values cultivation, community empowerment and education (Kwok & Grondzik 2007; Reed 2009; Sullivan 2012). The shift in design methodology is not necessarily initiated from a bottom-up level, but the local stakeholders would be allowed to drive the design process (Fraser et. al. 2006). As a result, public protocols would be an integration of collective simple rules and bureaucratic complex regulations. Meanwhile, regenerative designs would germinate from both grassroots emergent solutions and sophisticated place-making process. Ultimately, the top-down governance would take on an empowering role in initiating leadership from the bottom-up. In order to achieve regenerative action (value) which aims at reversing the current trend of consumption in the ecological-system indispensable for the human race existence (Mang & Reed 2012; DeKay 2012), we create a design frame under the **qualitative reflection process (how)**. Adopting Dorst's (2011) principle again on design thinking in Figure1, the integral design palette in Figure 3 is the intervention (what) we are introducing to the (frame) integral design framework (Dorst & Corss, 2011; Dorst 2011). The goal of this tool is to stimulate the alignment and activation process in Figure 2 which would eventually lead to holistic design (Mang & Reed 2012). Under the integral design framework, design palette is a device based on the shifted eco-centric values and sustainability guiding principles. It provides an open and holistic platform for designers to frame the condition and character of a space (Fraser et. al. 2006; Moffatt & Kohler 2008; Suzuki 2010). Taking into account of the time factor, designers can back-cast the precedence and invent their own steps along the way in searching for a proper design solution.

3.3 Integral design palette for qualitative reflection process

The integral design palette in Figure 3 is divided into six segments in a circular format radiating from the pillars of sustainable development, social, economic and environment. Recognizing the three sectors are in transition and bridged into one another and introduce additional subsections as socio-economic, socio-environment and eco-economic respectively (Wackernagel et al. 2002; Mang & Reed 2012; Moffatt & Kohler 2008). Adopting the top-down and bottom-up model, governance is used as the unifying subject in balancing the power of the three (Fraser et al. 2006; Moffatt & Kohler 2008; Conte & Monno 2012). This is to ensure clarity in linking the main cause of implementation to suggested design responses. Different aspects of design strategies are organized in radial line according to the six categories mentioned above. The sub-division element is assigned with potential design responses from five different colour-coded sections in the middle rings of the palette, corresponding to the design

elements. They are categorized under low-impact high efficiency, health productivity & well-being, safety & resilience, community & innovation and informational technology (Iwaro & Mwashia 2013; Poveda & Young 2014). The outermost ring refers to the topic of interest in the design archive that relates to a specific sustainability issue. At the beginning of the design process, designers can navigate each section from the centre-out to explore synergistic relationship of sustainability attributes and forecast the potential benefits or impacts of their decision-making. The palette is emergent and mature over time with the gain of design knowledge.

Spatial representations of natural systems were introduced to the design and preliminary planning process in the early 1970s following the publication of *Design with Nature* by McHarg (1969). However, the prescriptive tool is obsolete to the contemporary design-making. Nevertheless, Moffatt and Kohler (2008) argue that integrating spatial specific information at the beginning of the design is vital to inform professionals on the long-term effects of their designs and management decisions. The combination of this integral design palette (what) and the qualitative reflective process (how) define in the working principle for sustainable design and complement to the building-centric ESRS to achieve holistic design (Dorst & Cross 2001; Dorst 2011). Therefore, integral design palette is a critical analytical tool to inform the key ecological functions which are sensitive factors to the built environments and their relation to the local resources (Reed 2009; Hosey 2012). The simple guiding rules of integral design palette would encourage early adoption of eco-centric worldview. Under this integral design framework, sustainability would no longer be externalised as a particular check box. Embedding qualitative reflection process in the current architectural practice, integral sustainable design would be integral design simply.

4. CONCLUSION

Integral Sustainability Design challenges the current practice of sustainable development, not as a substitute, but as a complement to the current design thinking (Dorst 2001; Conte & Monno 2012). At the beginning, established **firms' architectural knowledge is rooted in the social channels, systemic filters, and individual strategies** (Henderson et. al. 1990; Blizzard 2012; Board et. al. 2015). Thus, the translation of evaluation methods into environmental and sustainability rating systems is an effective tool for communication among the actors in the built industry with minimal adoption to a new design paradigm (Henderson & Clark 1990; Holden et. al. 2014). However, the inherent limitation in ESRS leads to a self-perpetuating process of externalization. Hence, ecological models respond to such deficiency and encourage adaptive and resilience design in building from the start. Different from the quantitative assessment as a retrofit in the traditional design process, regenerative design stimulates evolution in governance structure and change the way we design from bottom-up (Moffatt & Kohler 2008; Conte & Monno 2016). Moreover, integration strikes between the need to build climate resilience rapidly and encouraging inclusion of marginalised voices. In this regard, the socio-ecological system perspective sets the ground work to establish integral design palette as a tool to inform professionals on the long-term effects of their design and management decisions (Wackernagel et al. 2002; Mang & Reed 2012; Moffatt & Kohler 2008). As a result, the fundamental shift in values and design thinking would embed qualitative reflection process in the architectural practice. Therefore, this integral design framework is critical to cultivate the value of securing a sustainable future.

REFERENCES

- [1] Baresel, C., Destouni, G. & Gren, I.M., 2006. The influence of metal source uncertainty on cost-effective allocation of mine water pollution abatement in catchments. *Journal of Environmental Management*, 78(2), pp.138–148.
- [2] Blizzard, J.L. & Klotz, L.E., 2012. A framework for sustainable whole systems design. *Design Studies*, 33(5), pp.456–479.
- [3] Board, E., Horr, Y. Al & Dosary, A. Al, 2015. Edi Board. *International Journal of Sustainable Built Environment*, 4(2), p.IFC.
- [4] Chen, X., Yang, H. & Lu, L., 2015. A comprehensive review on passive design approaches in green building rating tools. *Renewable and Sustainable Energy Reviews*, 50, pp.1425–1436.
- [5] Conte, E. & Monno, V., 2016. The regenerative approach to model an integrated urban-building evaluation method. *International Journal of Sustainable Built Environment*, 5(1), pp.12–22.
- [6] Conte, E. & Monno, V., 2012. Beyond the building centric approach: A vision for an integrated evaluation of sustainable buildings. *Environmental Impact Assessment Review*, 34, pp.31–40.
- [7] DeKay, M., 2012. *Integral Sustainable Design: Transformative Perspectives*. , 9(1), p.528.
- [8] Dorst, K., 2011. The core of “design thinking” and its application. *Design Studies*, 32(6), pp.521–532.

- [9] Dorst, K. & Cross, N., 2001. Creativity in the design process: Co-evolution of problem-solution. *Design Studies*, 22(5), pp.425–437.
- [10] Fraser, E.D.G. et al., 2006. Bottom up and top down: Analysis of participatory processes for sustainability indicator identification as a pathway to community empowerment and sustainable environmental management. *Journal of Environmental Management*, 78(2), pp.114–127.
- [11] Garde, A., 2009. Sustainable by Design?: Insights From U.S. LEED-ND Pilot Projects. *Journal of the American Planning Association*, 75(4), pp.424–440.
- [12] Geels, F.W., 2011. The multi-level perspective on sustainability transitions: Responses to seven criticisms. *Environmental Innovation and Societal Transitions*, 1(1), pp.24–40.
- [13] Henderson, R.M. & Clark, K.B., 1990. *Architectural Innovation: The Reconfiguration of Existing Product Technologies and the Failure of Established Firms* Author (s): Rebecca M. Henderson and Kim B. Clark Source: *Administrative Science Quarterly*, Vol. 35, No 1, Special Issue: Tech., 35(1), pp.9–30.
- [14] Holden, E., Linnerud, K. & Banister, D., 2014. Sustainable development: Our Common Future revisited. *Global Environmental Change*, 26(1), pp.130–139.
- [15] Hosey, L., 2012. *The shape of green: aesthetics, ecology, and design*. Island Press.
- [16] Howard, T.J., Culley, S.J. & Dekoninck, E., 2008. Describing the creative design process by the integration of engineering design and cognitive psychology literature. *Design Studies*, 29(2), pp.160–180.
- [17] Iwano, J. & Mwashia, A., 2013. The impact of sustainable building envelope design on building sustainability using Integrated Performance Model. *International Journal of Sustainable Built Environment*, 2(2), pp.153–171.
- [18] Kwok, A. & Grondzik, W., 2007. The green studio handbook: environmental strategies for schematic design. *Enquiry/The ARCC Journal of Architectural Research*, 4(2), pp.43–50.
- [19] Mang, P. & Reed, B., 2012. Designing from place: a regenerative framework and methodology. *Building Research & Information*, 40(1), pp.23–38.
- [20] McHarg, I.L., 1969. Design with nature, Available at: <http://www.ncbi.nlm.nih.gov/pubmed/21156334>.
- [21] Moffatt, S. & Kohler, N., 2008. Conceptualizing the built environment as a social–ecological system. *Building Research & Information*, 36(3), pp.248–268.
- [22] Poveda, C.A. & Young, R., 2014. Potential benefits of developing and implementing environmental and sustainability rating systems: Making the case for the need of diversification. *International Journal of Sustainable Built Environment*, 4(1), pp.1–11.
- [23] Raco, M., 2005. Sustainable development, rolled-out neoliberalism and sustainable communities. *Antipode*, 37(2), pp.324–347.
- [24] Reed, B., 2009. *The integrative design guide to green building: Redefining the practice of sustainability* (Vol. 43). John Wiley & Sons.
- [25] Sadler-Smith, E., 2015. Communicating Climate Change Risk and Enabling Pro-Environmental Behavioral Change Through Human Resource Development. *Advances in Developing Human Resources*, 17(4), pp.442–459.
- [26] Sullivan, L., 2012. *The RIBA Guide to Sustainability in Practice*. Royal Institute of British Architects, (March), p.36.
- [27] Suzuki, D., 2010. *The legacy: An elder's vision for our sustainable future*. Greystone Books Ltd.
- [28] Wackernagel, M. et al., 2002. Tracking the ecological overshoot of the human economy. *Proceedings of the National Academy of Sciences of the United States of America*, 99(14), pp.9266–71.
- [29] WCED. *Our Common Future: Report of the World Commission on Environment and Development*. Brundtland, G.H., 1987. *Medicine, Conflict and Survival*, 4(1), p.300.
- [30] Whitmarsh, L., 2012. How useful is the Multi-Level Perspective for transport and sustainability research? *Journal of Transport Geography*, 24, pp.483–487.
- [31] Wright, J. & Alajmi, A., 2016. Efficient Genetic Algorithm sets for optimizing constrained building design problem. *International Journal of Sustainable Built Environment*, 5(1), pp.123–131.
- [32] Yilmaz, S. & Daly, S.R., 2016. Feedback in concept development: Comparing design disciplines. *Design Studies*, 45, pp.137–158.
- [33] Yudelsohn, J., 2008. *The Green Building Revolution*. Island Press, Washington (DC).

APPENDIX A

WHAT + **HOW** lead to **VALUE**

FRAME

Figure 1: Design thinking conceptual framework adopted from Dorst, 2011, p. 524

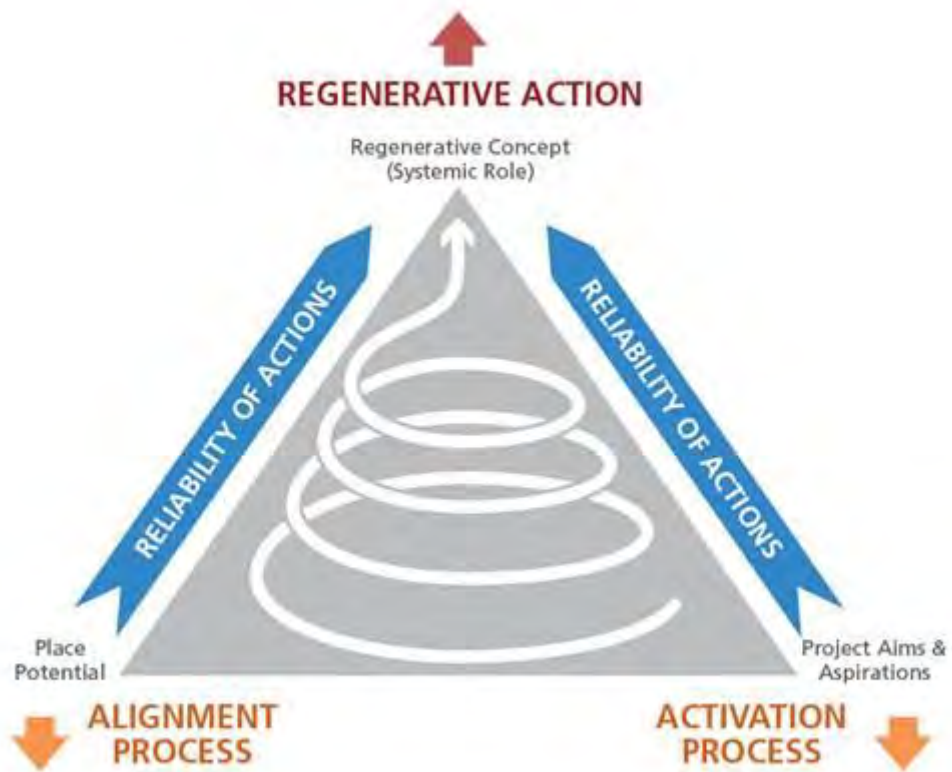
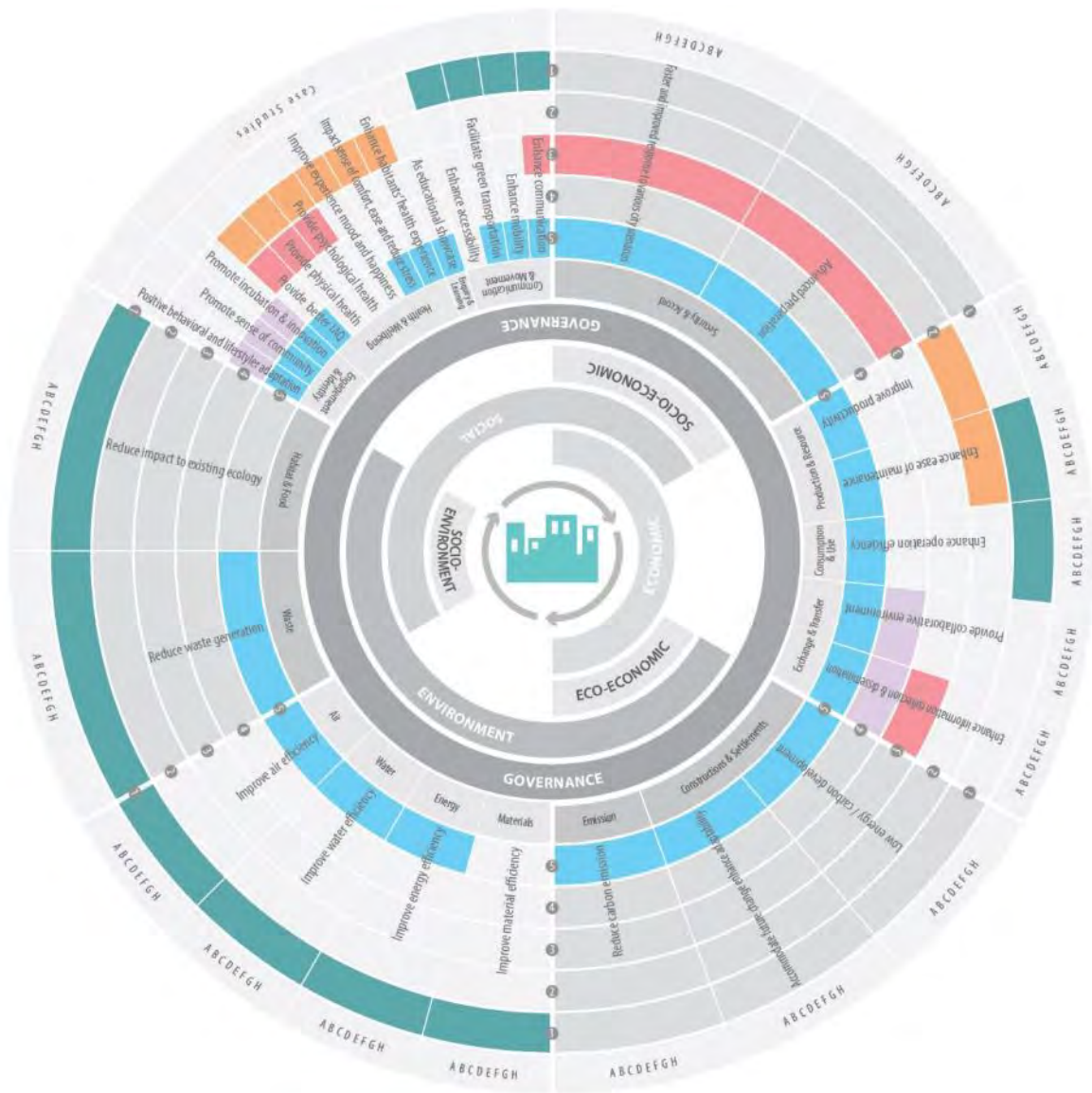

Figure 2: Dynamic creation of a regenerative concept at the operational level for regenerative action proposed by Mang and Reed, 2012 Figure 6, p.34.

APPENDIX B



DESIGN STRATEGY NATURE

- 5 Information of Tech.
- 4 Health, Productivity & Well-being
- 3 Safety & Resilience
- 2 Community & Innovation
- 1 Low-Impact High efficiency

CASE STUDY (A-H)

- A Background
- B Issues
- C Principles
- D Settings
- E Support
- F Experience
- G Project
- H Ideas

DESIGN FROM CENTER OUT

1. Regenerative Action
- ↓
2. Sustainability Issue
- ↓
3. Governance Structure
- ↓
4. Classification
- ↓
5. Design Strategy
- ↓
6. Case Study

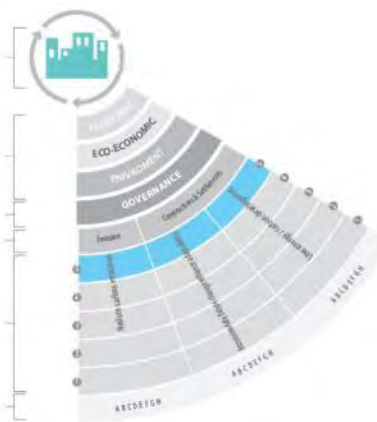

Figure 3: Integral design palette for qualitative reflection process from a socio-ecological system (SES) perspective

From Environmental to Social and Cultural Sustainability

Bryant LU^a, Peter YAM^b

^a Ronald Lu & Partners, Hong Kong SAR, bryantlu@rlphk.com

^b Ronald Lu & Partners, Hong Kong SAR, peteryam@rlphk.com

ABSTRACT

While we are excited in pursuing a sustainable environment through advanced technologies design, our consciousness to bring people closer to nature for a healthier habitat less dependent on energy consumption fades.

In this paper, we use the Ko Shan Theatre New Wing as a case study to explore how environmental sustainable design can escalate the social and cultural aspiration of a public venue that benefits both the general community as well as the district neighbourhood.

A theatre in a park

The challenge starts off with the finding of an environmental design solution to dissolve a 30m high theatre bulk, which houses 600-seats and supported with numerous amenities, into the tranquil park treasured by the neighbourhood as a precious communal backyard to their tiny dwellings in the old district. By preserving the mature trees – **the old and faithful “companions” of park users** – located in front of the site and carefully positioning the building masses according to the approaching view vista, the architect well integrates the building into its environmentally sensitive context.

A new sustainable living experience

Well-being of the park users has never been neglected when we were responding to the functional need of a new theatre. **Values are added to the park through introducing a “green trail” around the building envelope from ground level to the “moon lawn” on the auditorium roof. Instead of simply strolling at ground level, park users can now “hike up the building” and enjoy panoramic scenes of the district.** This trail together with the roof garden increases the site greenery coverage by 300 per cent.

A park in a theatre

Located on a site originally occupied by just four tennis courts, the theatre’s design adopted an innovative space-creation approach for its interiors. By wrapping the theatre foyer around the auditorium with a transparent building facade, the park’s scenery is “borrowed” into the interior and let the foyer bathed in natural daylight and greenery of the park.

Cultural and economic sustainability

The Old and New Wings aim to create a cultural heritage hub for Cantonese Opera, sustain and promote this traditional arts form. Bringing this mission to life involved the intensive engagement of various stakeholders in the performing arts – from actors to stage technicians and maintenance operators. The input of these stakeholders helped shape the design brief and the design process to ensure that the facilities can be well received by the public, allow flexibility to meet the changing needs throughout its building lifespan and become a value-added cultural venue to the city of Hong Kong.

Keywords: well-being, green trail, social and cultural sustainability

1. SUSTAINABILITY IS NOT JUST ABOUT TECHNOLOGICAL INNOVATION, IT IS MORE FOR THE HUMAN WELLNESS

Sustainable design that attracts public's attention is often through the display of its advanced technological innovations in its capability in energy/ water saving and energy renewability. Building systems efficiency performance is becoming the sole yardstick to measure the successfulness of a building sustainability design. While this engineering-based approach to sustainability does encourage people to waste less and recycle more, our consumption-based lifestyle has not altered much.

In this relentless pursuit of innovative design technologies, our design should facilitate people to interact more with the natural environment and to enjoy more the outdoor living habitat for a healthier lifestyle. After all, it is always more economical in capital and long-term running and maintenance costs when the building occupancies depend less on mechanical installations.

2. CLOSER LIVING RELATIONSHIP WITH THE NATURAL ENVIRONMENT TRANSFORMS OUR BEHAVIOUR FOR A SUSTAINABLE LIVING

This paper will look at the design of the Ko Shan Theatre New Wing (the "New Wing"), the first theatre built in Hong Kong to service the needs of the art of Cantonese Opera. It will act as a case study, looking at the transformation of an otherwise typical inward-looking theatre design into an environmentally, socially and culturally sustainable architecture project.

The focus of its sustainable design is more than benchmarking its energy efficiency with an engineering yardstick but to let the architecture socially respond to the park-**users expectation for a "humble" design that sits quietly in the park context and environmentally blend in with the greeneries and avoid obstruction to the ventilation paths around the park.** In fact, the design also aims to add values to the theatre-**goers for them to experience the park's green context even inside the foyer areas. By introducing a new "green" trail up onto the roof of the auditorium, the design adds a new vertical dimension to the park-users for jogging or strolling up to the rooftop moon lawn.**

We aim to transform the public behaviour by taking visitors out of an introverted air-conditioned space to outreach the nature and to enjoy fresh air and gentle breezes even here, deep inside the fabric of the city.

By **allowing the users to organically experience the park's natural environment, the design helps facilitate a truly sustainable lifestyle and transform to a healthier living behaviour for the well-being of our future generations.**

3. A DESIGN DILEMMA OF CELEBRATING CULTURAL HERITAGE WITH A GRAND DESIGN VERSUS CONCEALING THE BULK WITHIN A TRANQUIL PARK ENVIRONMENT

Parks in Hong Kong, regardless of whether they are located in the countryside or the urban area, are precious community resources. For the densely populated residential district of To Kwa Wan, Ko Shan Road Park has always been an irreplaceable breathing space— **a "backyard" garden and a "communal clubhouse" for people living in the tiny dwellings in the district.**

Built in the 1980s as an amenity facility **in the Ko Shan Road Park, Ko Shan Theatre (or the "Old Wing") gradually became a popular Cantonese Opera performance venue for Hong Kong.** Over the past decade, there were increasing calls from the cultural groups and general public to foster this traditional performing arts form. Eventually, the government confirmed that it would build a new wing next to the existing Ko Shan Theatre as a commitment to preserve this intangible cultural heritage and to promote the venue as a cultural and tourism asset of Hong Kong.

Performing arts groups as well as district council have eagerly anticipating this new theatre and expecting it to provide advanced theatrical installations and various ancillary services that the Old Wing cannot support. These include a fly tower for the stage, properly-sized dressing rooms, rehearsal rooms, singing practice rooms, an exhibition gallery, a souvenir shop, a tea house, a VIP lounge and more. However, only a tiny site of 4,000 sq. m., previously occupied by just four tennis courts, is available for the annex. After all, the tranquil park environment, strict zoning height restriction, high bedrock ground condition and presence of mature trees around the site have imposed unprecedented challenges to the design team to come up with a feasible design, not to mention a sustainable design solution.

This assignment was not only a design challenge, it also posed a design dilemma to the architect: whether to take this as a rare opportunity to design a landmark building which celebrates this piece of intangible cultural heritage **for Hong Kong, or to design a building that rests humbly within the tranquil “backyard” which the local residence treasures so deeply.**

Our desire to create sustainable, people-centric designs along with our commitment to design excellence led us to our final decision: we would attempt to address both sides of the dilemma by delivering on the expectations of stakeholders and theatre-goers for a landmark theatre, and give park users an enhanced leisure garden experience which would blend in with the park environment.

Essentially, we decided to create “A THEATRE IN A PARK” through the seamless integration of the theatre building with the park, and “A PARK IN A THEATRE”, whereby the park environment blends into the theatre’s interior.

4. A THEATRE IN THE PARK: A CONVERGENCE WITH THE PARK ENVIRONMENT

Trees are vital to a park environment. They soften the hard edges of any structure within the park and create an atmosphere of leisure and relaxation. Old mature trees in parks are often considered by park users as their old faithful companions and commonly become the landmark and remembrance in the community.

Despite the already-**small site, we sacrificed the precious buildable footprint by setting the building’s perimeter** back and adopting a curvilinear shape for the auditorium and foyer space to preserve most of the existing mature trees in-situ in front of the site and thrive hard to keep them in healthy condition throughout the construction period. These mature trees now embrace the building and serve as a visual screen for the building bulk behind, preserving the sound of wind through the tree leaves and birdsong high in the tree branches.

Our green design approach has not stopped at tree preservation. We create accessible green terraces at various levels of the building and we link them up to form a green trail that culminates at the moon lawn on the roof of the auditorium. This trail is an innovative extension of the park: a new, elevated exercise ground which gives park users a fresh experience and the moon lawn provides a spacious open roof garden where morning exercise classes can be held and events can be celebrated on festive days. This trail together with the roof garden has contributed to the park beyond the design brief requirements and figuratively has increased the site greenery coverage by 300 per cent.

Shared “green” space is also created at ground level – a naturally ventilated entrance foyer covered with a skylight. It is a cosy semi-outdoor plaza where people can meet before show time or gather as a pre-function area extended from the air-conditioned main foyer during intermissions. On non-performance days, it is used as an extended park amenity – a grand trellis that provides shelter for ad-hoc park activities in hot or rainy days. This is truly a people and space connector where the park and the theatre meet and a place where both park users and theatre-goers can utilise at different times of the day.

5. A DESIGN FOCUSING ON ENVIRONMENTALLY PASSIVE APPROACH

In addition to **creating “green spaces”, sustainable building design should also start with a passive environmental** approach, using strategic orientation and positioning of the building mass to minimize solar heat gain, while encouraging the use of natural daylight and **ventilation into interior space to lower building’s energy consumption.** **The following “green passive” design approaches are adopted in the New Wing:**

5.1 Building massing disposition and orientation

The building is oriented so that the main foyer faces east and south, drawing natural daylight into the common circulation space in the morning. The tower portion of the complex is treated with a solid surface façade and positioned on the west of the building composition shading the lower auditorium portion and the roof garden during the afternoon. With the rock slope behind the site lending its assistance, the building heat gain originating from the low-angle setting western sun is greatly reduced.

5.2 Building profile to optimize urban air ventilation

The stepped building profile follows the prevailing wind direction from east to west. Despite being the tallest part of the theatre – at almost 30m above ground – the tower portion is situated at the rear of the site close to the cut slope and merges well with the site **topography and creates no adverse effects on the district's ventilation corridor.**

The curvilinear building form of the auditorium block which faces towards the windward side also allows air to flow easily through the park and around the building perimeter and avoids creating undesirable wind gusts which could affect park users.

5.3 Solar reflectivity of the building envelope

White-washed walls are adopted for the tower's large vertical wall surfaces providing effective solar reflectivity and reducing solar heat absorption through the building envelope. This plain wall surfaces are easy and economical to maintain.

These passive sustainable strategies and the creation of shared "green spaces" help this new comer to be perceived as a park companion that accomplishes the cultural characteristic of the Ko Shan Road Park than an invader depriving the space and green resources of the Park. Such positive social interaction with the neighbourhood and the users gives an equal weight to the importance of environmental sustainability for a civic building.

6. A PARK IN THE THEATRE: AN INTEGRATED BUILDING ENVELOPE FOR A SUSTAINABLE INTERIOR SPACE

Besides being a Park companion, the park's greenery is welcomed into the theatre foyer through full-height glazing. External views of the park are **"borrowed" into the interior through window frames or gate openings and reveals like** a row of traditional Chinese landscape paintings through the window segments, a technique often used in traditional Chinese landscape design.

The following elements amplified this design:

6.1 Building facade

Through a high-performance glazing system which uses low U-value insulated glass units (1.5W/m²/K), the entire theatre foyer can be bathed comfortably in natural daylight, incurring neither high thermal transmission nor high cooling load demand. The overall thermal transfer value of the building envelope is only 17.17W/m² –51 per cent lower than the baseline standard for a local office building.

The glazing panels of the full-height curtain wall are electrically **operated and work with the main foyer's free cooling mode ventilation system under favourable weather conditions, minimising the air conditioning system's power consumption.**

External sun-shading fins, which detach from the glazing panels to form an external **shading "skin" for the envelope,** serve as an effective solar shield, minimising direct solar impact on the east- and south-facing glass façades. A maintenance gap is reserved between the glass façade and the fins to ensure easy access for cleaning and repair work.

6.2 Rooftop thermal insulation

The urban heat island effect is mitigated by incorporating green roof system at multiple levels of the building. The greenery acts as an insulation layer, reducing heat gain through the building envelope and providing extra protection to the roofing system from direct radiation attack. This also reduces the temperature of the local area and the energy consumption of the air-conditioning system operating in the space below.

6.3 High greenery coverage

The total planting area covers 34.6 per cent of the site. More importantly, majority of these landscaped areas are not only designed for visual pleasant, these green terraces are also accessible and can be integrated with the adjoining rooms to form an expandable function area.

6.4 Acoustic insulation

Acoustic separation is achieved in a number of ways: through sound barrier ceiling, isolation partitioning and floating slab. The isolation elements are suspended by isolation hangers or spring fixing with neoprene separators, allowing the room interiors to be isolated from building structure.

Such design integration of the interior atmosphere with the exterior park environment reinforces its companionship of its natural setting in the park and the traditional Chinese cultural arts form through its close spatial interaction with the Nature.

7. CULTURAL AND ECONOMIC SUSTAINABILITY

Sustainability should be interpreted multi-disciplinarily. Environmentally, a low-carbon building enables the building operations to be economical and friendly to our earthly environment.

In the design process, the architect has always been conscious on its social sustainability aspect of the development and fully engaged its design with the environment to let it be a companion of the park setting and its neighbourhood.

Besides, intensive engagement and partnering workshops (20 nos.) with stakeholders from various disciplines and consultation meetings at district level (10 nos. of District Council meetings) as well as professional level (50 nos. of Cantonese Opera Advisory Committee Meetings) were conducted.

The aim is to ensure that the facilities can be economically sustainable as a well-received arts venue by the performers and the audiences and can accommodate flexibility to meet the changing needs throughout its building lifespan. After all, the project can gradually become a value-added cultural venue to the city of Hong Kong.

8. CONCLUSION

The heart of the design approach to the Ko Shan Theatre New Wing involved a re-evaluation of the basics of sustainable design: instead of focusing solely on technology-based sustainability innovation, we sought to create a design that well integrates with the green environment, encouraging all users – theatre-goers as well as park users – to reach out and embrace nature.

In a wider sense, our search to achieve building sustainability should not be limited to economic and environmental sustainability, but should also incorporate intangible social and human values which service the well-being of our future generations to achieve cultural sustainability.

Session 7.13: Place-making – Practices Review

From Icon to Community: Repositioning the Image of the Modern Mega-Tower

Bryant LU^a, Guymo WONG^b

^a Ronald Lu & Partners, Hong Kong SAR, bryantlu@rlphk.com

^b Ronald Lu & Partners, Hong Kong SAR, guymowong@rlphk.com

ABSTRACT

Historically, mega-towers were frequently labelled “egocentric displays of power”, becoming iconic symbols of a city or an individual.

In today's age of global hyper-urbanization, mega tall towers are, for the first time in history, becoming more than just iconic power symbols. Mega-towers address a real urbanization problem: they create more building space with less land. New generation mega-towers have evolved from being independent structures into complex mini-cities with integrated underground transportation systems and pedestrian connections. Their underground and above-grade connections to infrastructure are often more challenging to design and build than the towers themselves. Given this complex and highly dynamic design environment, the existing mega-tower delivery model is no longer fit for purpose; a new, more efficient model must be explored.

This paper compares two mega-towers: Tianjin CTF Finance Centre (530m) in Tianjin, China and Wuhan CTF Finance Centre (648m) in Wuhan, China; discusses the design and build challenges involved in both towers, and proposes a procurement methodology which will usher in a new era for mega-tower delivery.

“Come, let us build ourselves a city, with a tower that reaches to the heavens, so that we may make a name for ourselves; otherwise we will be scattered over the face of the whole earth.”

– Genesis 11: 4, The Bible

Since the dawn of humankind, towers constructed by human hands have served one overriding purpose: to express power. Towers have been variously depicted as a challenge from humanity to the gods, a demonstration of local or personal prestige and even, to put it bluntly – as the ultimate phallic symbol.

Often a product of boom times in wealthy cities and nations, the primary function of these early icons was to be just that: an icon, designed to represent the high status or a person, city or nation, or to fuel the ego of a developer or a government and broadcast that image to the world. But as the world changed and societies evolved, many of these original icons have now fallen and become monuments to forgotten people.

The world in the 21st century is a very different place, but the echo of this original, egotistical purpose still lingers when one considers many of the tall buildings in cities across the planet. For many people, towers still represent power. However, today's mega-towers are challenging this idea and a dramatic shift is beginning.

These new towers are still iconic – but they act as symbols of something entirely different – the strength of a community and the vitality of a neighbourhood. This paper will examine the evolution of the modern mega-tower as well as the tower's significance to the wider world and the local community. A specific example, Wuhan CTF Finance Centre in China, will be examined in detail.

1. FROM ERECTION TO ICON

The first modern skyscrapers to be built, let us call them Generation One, were located in Chicago in the 1880s – the Montauk Block and the Home Insurance Building – both ten storeys tall. Designed to house offices and make businesses more efficient, these towers were part of society's response to rising land values sparked by an influx of people into cities, and the corresponding increase in the urban population and fall in the availability of land.

These buildings also served as a training ground for architects and engineers as they developed the Commercial style of architecture – steel-framed edifices which steadily grew higher, stronger and bolder over the next 50 years. Despite their prominence in Chicago, New York and the US Midwest, and the fact that they paid testament to the obvious skill of their designers and builders; these buildings were ultimately just places of work – destinations serving only themselves.

Then came Generation Two, the first example of which was the mighty Empire State Building built in 1931. At 443m this magnificent super-tall building became – and has remained – an icon of a nation and its people. One reason for its wide popularity was a new and crucially different design feature – a public observation deck on the 102nd floor, giving the public a never-before-seen 360-degree view of Manhattan.

This provision was the first nod to the potential “community service” these towers could provide: a public space located at the top of a city. This space immediately captured the imagination and the hearts of the public – cementing its place in popular culture and inspiring stories, books and films, notably *An Affair to Remember* and *Sleepless in Seattle*. This excitement and enthrallment illustrates the latent potential power lurking within tall buildings – **the notion that towers can provide a community with something that “belongs” to them.**

Through the years, towers have risen higher and higher, with breakthroughs in engineering and technology allowing super-tall towers and mega-towers to become ever more complex, beautiful, lofty and iconic. Yet still, their function within the city has remained relatively static – **they are a place to do business and the focal point of a city’s** skyline, sometimes even defining a city; but still they remain disconnected from the community around them.

In spite of this fact, super-tall towers and mega-towers are widely considered by developers, planners and governments to be the primary generator of urban development and renewal. Thanks to advancements in material science, wind analysis modelling and vertical transportation mechanics, not to mention pressing demand, high-density urban development and growth can be promoted and sustained, and more and more skyscrapers are being built.

This is particularly the case in Asia, the fastest-growing region on Earth. With rapidly-rising urban populations and precious little space, mega-towers are the seemingly perfect solution to all problems.

2. THE VERTICAL CITY PARADOX: FUNCTIONAL BUT DISCONNECTED

Today’s mega-towers are mostly Generation Three – the next evolutionary step of Generation Two towers. These mega-tall super-towers **often invoke the concept of the “vertical city”** – where multiple uses are contained within a **single building, providing the building’s occupants with many of the conveniences** one would find in a mature, developed urban neighbourhood. Generation Three skyscrapers contain an impressive diversity of facilities organized around a comprehensive vertical.

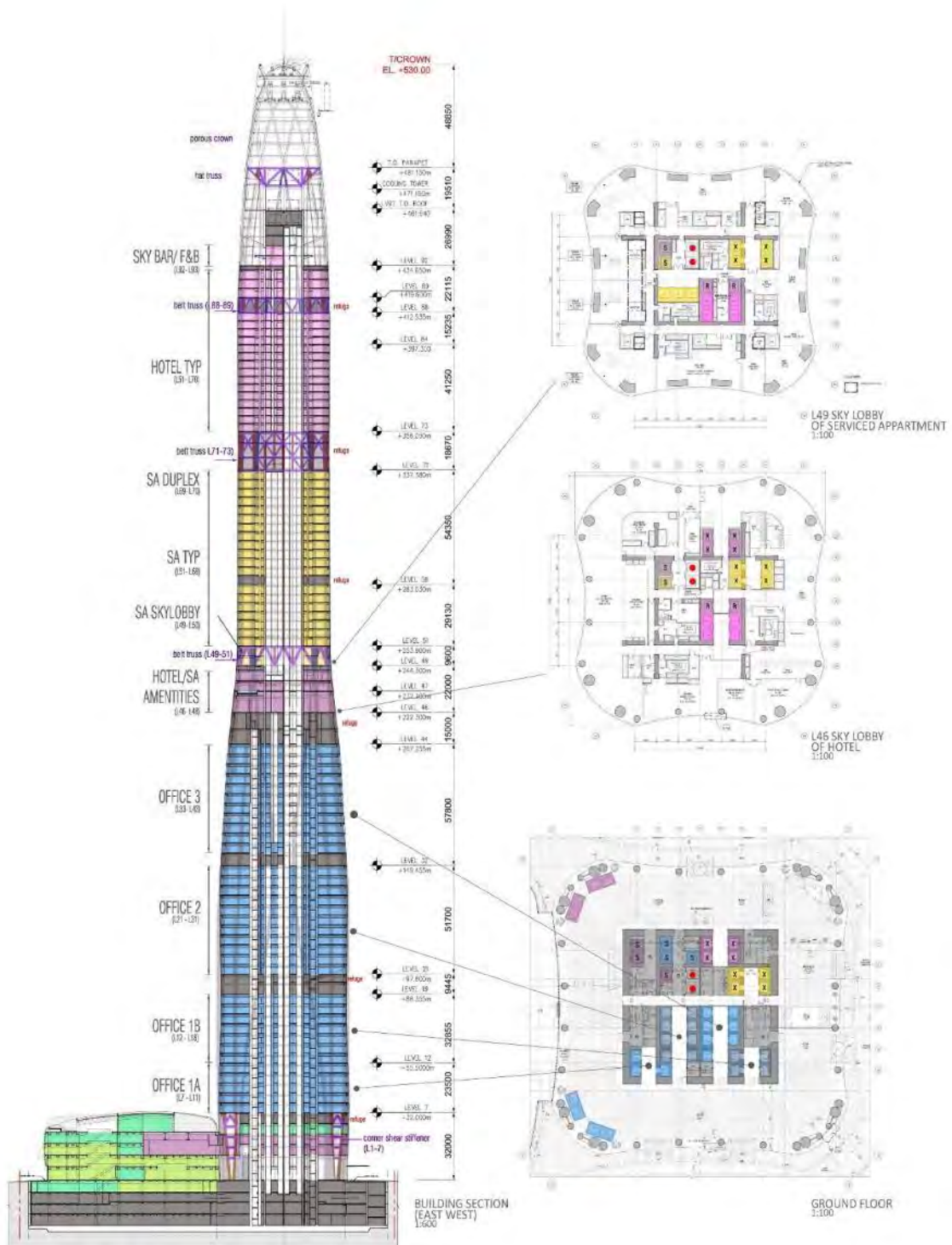

Figure 1: Tianjin CTF Finance Centre: Section showing a stratified vertical city

One example is the Tianjin CTF Finance Centre mega-tower, situated in the newly-developed Teda urban area in Tianjin's Binhai New Town. Rising to 530m, Tianjin CTF Finance Centre is a standalone mega-tower surrounded by institutional, commercial and retail buildings, but its design is fully confined within the site boundary, with the exception of one underground pedestrian connection to an adjacent metro station.



Figure 2: Tianjin CTF Finance Centre: A carved-out city block in a low-rise neighbourhood

With a total gross floor area of 389,900 m², this tower is the vertical city personified. Its 99 floors are stratified into different zones, including a 23 storey ultra-luxury hotel; 21 floors of serviced apartments; 34 office floors; five storeys of lobby and clubhouse facilities at the lower floors connecting to a five-storey retail arcade and hotel public facility podium; and four basement levels which house car parking spaces, a mechanical plant and a back-of-house area.



Figure 3: Tianjin CTF finance centre: An icon in the community

Impressively demonstrating the integration of facilities, form and structure, Tianjin CTF Finance Centre is inarguably an icon for the city, as are so many Generation Three towers. But while remarkably efficient and self contained, these towers are still more about themselves than the surrounding area. Their zones are well-defined, but often have limited connectivity with each other; there is a distinct lack of accessible and good quality public space; and most crucially – these towers lack a connection to the wider community. They are still disconnected islands floating in an urban sea.

3. FROM ICON TO COMMUNITY GENERATOR – CREATING CONNECTIONS

As the most populous country on Earth, China is the ultimate “people-oriented” place. The unprecedented rural to urban migration occurring in modern China is leading to rapid, hyper-density urbanization as the country’s cities rapidly run out of space to house new arrivals. This current growth model is unsustainable and, as we have seen repeatedly in other countries, leads to massive society-wide problems – traffic congestion, pollution and declining quality of life.

People can only truly thrive in functioning, living, connected communities. The designers of newest generation of mega-towers, **“Generation Four” if you like, have begun to realize this and are acting accordingly. Generation Four towers create solutions to these hyper-density related problems by providing the missing piece of the puzzle: creating flourishing, sustainable mini-cities with multiple robust connections to the surrounding environment.**

Wuhan CTF Finance Centre mega-tower, currently under development, is an example of a Generation Four tower. Located on a vast site, with most of its area consisting entirely of public green space, Wuhan CTF Finance Centre is first and foremost a people-oriented development which emphasizes community and connectivity. **The development is highly connected to the rest of the city via an underground “root” system – road, rail and pedestrian connections – which firmly “plug the project in” to the rest of the city.**



Figure 4: Wuhan CTF Finance Centre: Visually connecting and physically integrating with the community

4. DESIGNING A NEW GENERATION OF MEGA-TOWER

Wuhan CTF Finance Centre is situated in an urban renewal area of Wuhan, the capital city of Hubei Province. **Wuhan, historically known as “two waters and three towns”, is widely known as being the traditional transportation hub of Central China. The site sits next to a flood prevention dam on the Yangtze River in a key, centralised position in a newly-planned CBD area.**



Figure 5: Wuhan CTF Finance Centre: Genius loci with three-dimensional pedestrian links with the community

Looking at the site from above, it is immediately obvious that the Wuhan CTF Finance Centre project is not the **typical “carved-out plot” commonly seen in earlier generations of mega-towers**; it is much more a node with multiple connections to the surrounding area. It is a high-density development with a plot ratio of eight, much higher than the more typical 2.5 or 3 common in Generation Three towers. The plans allow for the release of a startling 53,000m² of land for the construction of a city park, while increasing the supply of office space by 80 per cent when compared to similar projects.

Wuhan CTF Finance Centre’s design stresses its connection to the urban and community environment on every level, and in doing so, the design demonstrates the project’s commitment to providing public space. The project will accommodate a total gross floor area of 532,000 m², configured as a vertical city, with office, retail and residential functions. An additional 200,000 m² will be provided for car parking spaces and back-of-house functions at the basement levels. The offices will be housed in the 648m high, 118-storey mega-tower with a total floor area of 327,000m² floor for lease or sale. The remainder of the development will include four 90m residential towers located at the four corners of the site, and a 100,000 m² four-level retail podium which will connect to the office and residential components of the project.

5. KEY CHALLENGES AND STRATEGIES ADOPTED

This template is used to provide you with the formatting specifications needed for preparing electronic versions of your papers. All margins, page numbers, column widths, line spacing and font styles are prescribed, please do not alter them.

5.1 Connecting a significant business and retail hub to different communities

The planning and design of Wuhan CTF Finance Centre involved much more than the rather linear concept of **“creating a magnet” to draw in the working population of the new CBD.** This project casts its net to a much wider demographic: connection to the cross-river rail and underground road network will provide rapid and convenient transportation links for members of the university and the high-tech research community living and working in the nearby Wuchang district, allowing them to mingle with business people working in the tower.

The retail portion of the development is also being positioned as a family and children’s mall – the planned children’s education and learning facilities will extend the value of the development to yet another demographic and bring life into the tower outside of office hours.

These unique links will connect the surrounding residential neighbourhoods and the main city with a less congested, greener and more vibrant urban space – a place which does not exist in the current city fabric – providing the entire city with new green space.

5.2 Providing a safe and enjoyable venue for community interaction

The at-grade level of both the project and the park sites encourages the unrestricted flow of pedestrians and designated urban spaces for where the public, shoppers, members of the university and business communities and more can interact. Most of the external vehicular traffic will be at the underground level, which will reduce the amount of traffic-related air pollution in the at-grade portion of the development. The above-grade tree bridge network also allows convenient pedestrian movement between the functional, recreational and transportation portions of the site.

The numerous open spaces give the circulating pedestrians various opportunities for relaxation and other activities. The city park provides not only a large green space, but also a large stage for different activities like art exhibitions, sports events and a vibrant public space for children and adults alike.

5.3 Controlling the design and maintaining the future built environment

Your submission must provide the details of the work to readers. It should be clearly divided into sections, with heading/ sub-headings, so that readers can follow the logical development of work. Using headings is a great way to organise the paper and to increase its readability, so make sure to format them correctly.

From the start, it was essential that the developer proactively controlled the urban design rights of the surrounding area, in order to maintain the desired overall environment and set a baseline for the planning and integration of activities for different communities. One strategy which provides these safeguards is to take up the design of the city park and its pedestrian connections with the the project.

During the project's initial land sale deal, the developer also bought another 25,000m² of retail GFA under the city park site – this will allow direct below-grade connections to the development. To ensure that the functionality of the development and the connected areas is truly harmonious into the future, the demarcation of maintenance responsibilities in connected by non-project site areas must be carefully considered, otherwise this harmonious concept could rapidly unravel.

5.4 Bringing a mega-tower office project to life beyond office working hours

Most CBD and mega-tower projects across the world face a common problem – the notion of the vacated city – or “**dead city**” – after office hours and on non-working days. To allow effective, continuous and constant use of the area, regional retail and residential elements were planned into the project. These discrete elements will allow different communities to enjoy various activities around the clock, providing multiple uses for this public space which can be enjoyed at different times of day.

6. CONNECTING WITH EACH OTHER

Merging “work”, “play” and “live” destinations is not a particularly innovative concept these days. Wuhan CTF Finance Centre's uniqueness lies in its connectivity, which will feature:

- A metro/ tram transportation hub, including three metro/ tram lines at the basement level, street level and above-grade viaduct levels;
- Six pedestrian connection points to adjacent developments at the basement level, including to retail facilities which will be provided in an adjacent future development;
- Six pedestrian connection points with current and future metro and rail lines;
- Two pedestrian links to the city park to the east at two levels;
- Six pedestrian connection points which will connect to future commercial developments, the city park, the cultural centre to the north and the current promenade park;
- Connections to public and cultural facilities in the vicinity;
- Public loop roads at the above-grade and basement levels.



Figure 6: Wuhan CTF Finance Centre: underground vehicular loop road with community parking at B2&3

Connectivity does not strictly mean “transportation”; the concept also involves the creation of connections between people. Wuhan CTF Finance Centre seeks to create a space that the surrounding community can enjoy around the clock, through the provision of public open space and numerous services and facilities. Business clubhouses and office rest lounges will be located throughout the building; retail facilities will feature family- or child-based themes to help stimulate interest and attract people to the property; and the development will be well connected to green spaces. Residential facilities will also provide private open green spaces at the deck level and exclusive clubhouse facilities for residents.

Given the project’s proximity and accessibility to the major commercial, residential and educational areas of Wuhan and its strong pedestrian, road and rail transport links, this project has the potential and the capacity to attract people into the neighbourhood – creating a community and providing Wuhan citizens with unprecedented opportunities for fun, leisure and learning.

The tower itself has been designed specifically to define and draw people to the area, rather act as an outright display of power. Its enormous height will make it a natural icon – this is unavoidable – but an icon which serves rather than displays. Wuhan CTF Finance Centre will serve as a nexus for new development and a place where people can gather and connect with one another.

The tower’s structure consists of a central concrete core with corner setbacks at various levels which echo the shuttle lift stacking, and perimeter moment frames comprised of composite columns, belt trusses and perimeter spandrel beams. The tower’s structure will be fully integrated with a versatile energy-efficient façade system which will be put through stringent wind load analyses, with the aim of minimizing the materials used for the structure.



Figure 7: Wuhan CTF Finance Centre: A “mega-hub” for work, live and play

coordinate, liaise, negotiate and enter into dialogue with a wide array of people and companies – from government departments to transportation engineers to contractors and beyond – all in the specific and unique context of modern-day China.

With Wuhan CTF Finance Centre, a number of specific challenges were encountered. While unique to the project, firms seeking to undertake these projects in the future should be aware that these types of challenges will certainly reoccur in other mega-tower projects in China. These include:

- Multi-disciplinary design challenges which occur during the design, development and implementation stages. These can include the need to create large amounts of specialized building materials, which can rapidly escalate costs.
-
- The need for large teams of consultants and specialists. While necessary, these teams must be unified by a unified, strong leadership team.
-
- Exceptionally complex designs involving enormous amounts of information. Potential solutions involve the use of Building Information Modelling to resolve potential design clashes, and factory-fabricated products to decrease construction times.
-
- Numerous logistical barriers and other hurdles exist in terms of obtaining the various necessary statutory approvals from government bodies. Flexible schedules need to be utilized and keen attention paid to the time lag between design approval and statutory approval.

Firms operating in China must seek solutions to these and other issues quickly, as over the next five years, **71 per cent of the world's completed super-tall and mega-towers** will be located in China.

8. CONCLUSION

The world has come a long way since the first tall buildings scraped the sky over Chicago. In most parts of the **world, the “good old days” of a building being a symbol of power and pride are gone forever. Today, self-contained, standalone towers** are becoming an anachronism, with their importance to the cities of today in rapid decline.

This is not to say that mega-towers are irrelevant. Far from it – in Asia especially, they have a vital important role to play in the urban environment. The mega-towers of the future – Generation Four and whatever comes next – will still be icons that embrace and celebrate the achievement of creating incredible buildings, but they will also, more importantly, celebrate their connection to the neighbourhood, embrace the public and generate living, thriving communities.

Do We Design Our Cities?

Eugenio Maria FONTAN YANES^a, Jorge BENEITEZ^b

^a Enzyme Apd, Hong Kong SAR, e.fontan@weareenzyme.com

^b Enzyme Apd, Hong Kong SAR, j.beneitez@weareenzyme.com

ABSTRACT

Architecture and Cities are a manifestation of our relation with space and nature. It is not just a mechanism of making money and profit.

The Quality and Environmental Performance of a building is determined by its very first Design.

Nowadays we have tools at our disposal that allow us to Optimize Time, Resources, Cost, Energy consumption during construction and life cycle, etc. We know passive techniques that optimize sustainable performance. **Why we don't implement these techniques in our Design?**

A Smart Design Process is the one that integrates all this considerations within the space we want to live in.

How to project our city? Right now the spaces we live in are the result of different disciplines poorly connected and not coordinated. The design of a city is a single process, it is the design of different parts and aspects of the same thing. We need to think in an integrated way when designing buildings and cities from the very beginning. **A building doesn't become sustainable when adding a solar panel and a city doesn't improve just adding trees..**

How we achieve it? Every architectural design of any scale, from interior renovation to mix use or master planning, should propose Technical **and Environmental "objectives" related with the conceptual ideas of the project.**

All aspects would afterwards be coordinated with specific consultants of each discipline such structure, MEP systems, energy performance, facility management, etc. Such coordination and development would involve the Design Team and every consultant as a cooperating Team Work.

Tools that allow the integration of works in a collaborative way such Building Information Modelling and other tools that analyse performance of the building should be implemented at the beginning of the project, should be part of the Design process.

We can Design the cities we live in.

Keywords: design process, climatic responsive architecture, sustainability

1. INTRODUCTION: ABOUT OUR CITIES

When starting to design an architectural project at University they used to tell us that understanding the environment was the most important step of the whole process. It was the way to understand the right questions **and give the appropriate answers. It doesn't matter** the scale of a project, the environment and time that we live are claiming for accurate answers for specific problems.

Good design is often not about giving a good answer but more about formulating the right questions. Our city is the result of how do we give answer to all questions. How do we answer to social demands, private space, economical revenue, regulation, connectivity inside the city, relationship of the urban fabric with the surrounding environment.. How do we design our cities?

2. THE DESIGN PROCESS

2.1 About the design process

Let's first of all define the process of developing a project till it becomes real. We are going to call this whole process "the design process". To agree in a very simple way of understanding how a project becomes real we divide this process in three stages: Design Stage, Design Development and Final result or Outcome.

We can generally call the beginning of any project the early Design stage. The moment in which we start thinking and proposing our intentions, necessities, expectations, principles and constraints.

After this first little step the design needs to go through a long process to become reality which is the development of the initial design. The result and outcome of a project will then depend on that process and the initial design. We need to ask the right questions to get the right answers.

A smart design process is the one that enhance all our intentions and allow the final result to be what we expected. A bad design process is the one that worsens the intentions and principles of the design and creates a worse outcome.

A smart design process is also the first sustainable strategy, is how we optimize resources for the creation of a new project.

2.2 The early design: Making the right questions

Before start designing we need to have a clear vision of the ideas, constraints, benefits, etc., that will influence our design.

Government bodies establish constraints and regulations to ensure minimum requirements for every project. Some regulations are there at the first place to protect the users from greedy developers that build poorly in order to maximise benefits. Economical considerations are also very important. We must ensure that the investment on a project must create some revenues, so developers also will keep on investing on the community.

The environmental considerations are not yet a must in every project but we must make them become a valuable asset of our design. Regulation bodies have the capability of making environmental strategies mandatory.

What about the social and private space quality?

We need to understand which are the questions so we can design the proper answers. The challenge of designers is to give answer to these questions to make them complement each other without making sacrifice and satisfying **all demands that involve the project, "Yes is more" (Bjarke Ingels. 2009)**

2.3 The Design development: Multidisciplinary challenge.

Through the process to become reality our design is going to have to adapt to different demands. The design development is done by different teams during the process. It is always a multidisciplinary task.

Apart from the Architect in the case of a building we have structural consultants, fire consultants, MEP (Mechanical, Electrical and plumbing), landscape, etc.. How do we coordinate all these disciplines in between them? Are we using the right tools and platforms for this purpose?

The sustainable considerations of our design will be rather optimized or ruined. How are we ensuring that the development is making them to become real at the end?

The building process will also determine the result. Was that phase also taken in consideration while defining our design? Sometimes this process change extremely the original design. The more we have in consideration this development at the early design stage of a project the less it will be affected negatively in the future.

2.4 The Outcome

What is the outcome that we have? How the process affected the design principles? Does it fits all our demands and constraints? How is the performance of our project once is real?

Sometimes a non appropriate design can be the responsible for poor development. A poor early design can be the cause of a bad development and a bad result.

Inefficient coordination can be as well the responsible of over cost and delays during construction process. It can ruin most of the strategies implemented on the early design stage.

3. THE CURRENT SCENARIO (PROCESS A)

3.1 The process A

How is the current design process that we commonly see in our cities? Let's have a look to the case of Hong Kong as an example of a common process that happens in a lot of cities around the globe.

3.2 Analysis of current design stage

Which are the main ideas, constraints, benefits, etc., that are influencing our design decisions?

There are different voices calling for different answers. Clients/ developers usually search for economical answers and investment return. Regulation bodies like BD (Building Department) search for standard and performance requirements. But Regulation Bodies could also request environmental and social solutions. How can designers give answers to the right questions if governments or developers are not asking for them?

Hong Kong is well known for the use of huge amount of energy for balancing the energy gain of our buildings. Developers are not interested in improving the quality of their projects so the energy performance is more efficient.

Sometimes seems that the design of Hong Kong projects is just a result of bad coordinated questions and aggressive economical considerations ignoring environmental and social aspects.

3.3 A Multidisciplinary development

When developing the project all different disciplines need to evolve with it and need to be coordinated so the information is appropriately shared. How good or bad is this coordination happening in a city like Hong Kong?

After design is signed off by a client very often the project starts to gain detail while approaching the GBP (General Building Plans) submission (BD). For achieving the level of development that the GBP submission requires disciplines should be developed in parallel. It is very common that the coordination is poor and not well organized and this means that the information that teams are using is not updated and basically not the same. For instance, platforms like BIM (Building Information Modelling) which is a great coordination tool, are poorly implemented in Hong Kong projects right now causing a huge amount of mistakes and over costs.

All this overlapping of a bad coordination and errors lead to over costs and delays during the execution of the project. Fixing errors on site can lead to major design changes as well.

At this stage of the process if considerations regarding energy performance or sustainable strategies were not taken at the design stage it is quite late to implement them now.

3.4 Analysis of our outcome.

After the whole development of the project does it looks or performs as the early design intended? Was the design we proposed at the beginning the appropriate answer to our intentions, constraints, etc.? Did we asked the right questions?

How is the performance of our project now that has been completed?

Which is the feedback of the final users? Did we designed our city after all? Or the project has become the result of bad coordinated process after inappropriate design premises?

As a conclusion **we can see that the early design doesn't take in consideration the right questions and a poor coordinated development lead to a bad outcome full of errors and over costs.**

4. SMART DEVELOPMENT (PROCESS B)

4.1 The process B

We need the best design to evolve through an efficient and smart process to get the best result. Basically we need to understand the potential and weaknesses of the process A. Let's define a smart design process.

4.2 About Smart Design

As we proposed before, first we need to identify and ask the right questions to design the right answers.

Government bodies have the authority to demand sustainable and social goals. Without this support designers have a little power of decision on these matters. Designers have just the option to show how these strategies do not have to be more expensive or to prejudice other project aspects. But the regulatory bodies have a crucial role here.

Following these goals a sustainable construction methodology should be implemented at the design stage.

Passive energetic saving strategies should be part of the concept design as methodologies to increase the energetic performance without increasing costs.

Quality for social and private space. Space in Hong Kong is expensive. But small spaces can have quality as well. We need to propose more quality social spaces for the city. Which is the design strategy for Hong Kong?

The early design needs to have in consideration the development. If the design has in consideration the realistic constraints of the different disciplines that will develop the project then the result will match the expectation of the early design in a more effective way.

The conclusion is that we need to understand and coordinate the right questions to give the right answers when doing a design.

4.3 Appropriate Development

An appropriate development requires an effective coordination. The coordination of information and documentation is crucial for the project development.

We need to implement the right collaboration platforms to avoid errors during the process. BIM platform is a methodology that allows interdisciplinary coordination during the development of a project. It is also very efficient in terms of documentation production. Authorities should ask for the implementation of this methodology in Hong Kong projects and designers have the responsibility of implementing in their projects as well.

Keep track on the environmental strategies implemented on the design stage. Some features of BIM platform, and several different softwares, are the evaluation energy performance. Implementation of energy evaluation methods to maintain the environmental and energetic goals of the design should be mandatory.

Hierarchy in the process of communication and responsibility during the process is also very important to avoid misunderstandings on the process. Also regarding the establishment of common goals and objectives, leadership and managing expectations among the teams is crucial for an efficient development.

Only by using these principles we will save over costs, problems fixing on site and major design changes.

4.4 Benefits

The final result will benefit from an appropriate development and a smart design. The outcome will match the goals of our early design thanks to an appropriate design process. Only in this way our cities will benefit from our projects and we will actually design our cities.

5. IMPLEMENTATION: FROM A TO B

5.1 Improving the Design

Identify right questions and coordinate them properly. Coordinate all demands.

Social demands for public spaces need to be asked by the regulation bodies.

Minimum quality for both public and private spaces shall be demanded by government.

Sustainable construction methodologies shall be part of the main design intentions and supervised by regulatory bodies.

Passive energetic design strategies should be implemented as part of the design and supervised by regulatory bodies.

The development needs to be taken in consideration at this stage. A multidisciplinary team can design having in consideration the development.

5.2 How a development becomes smart?

Implement collaborative working platforms such as BIM for the development of projects for better coordination of documentation in between teams.

Implement energy evaluation techniques and require them as mandatory by regulatory bodies for a better achievement of sustainable strategies on the design

Implement communication tools that allow all teams to be coordinated and establish a clear hierarchy of communication through teams.

5.3 Outcome B: key benefits and conclusion

Result will match the design intentions and goals. Over cost due to errors during works development on site will be highly reduce.

Better environmental and social spaces for the city.

Have an efficient process is the first sustainable efficient strategy: to optimize resources, time and money without losing quality.

Design our city is a collective responsibility that needs to be assumed by the regulatory bodies. Designers can propose important improvements in their projects that the city will benefit from. Little strategies implemented in small projects can make a huge change together.

In this paper the questions have a higher importance than answers. The answers need to be provided by every designer. There is not such a correct answer but an appropriate question. Environmental and social questions are always left to a second position compare to those that ask for economical benefits.

We can design our cities but the right questions needs to be done and the smart process needs to be implemented.

REFERENCES

- [1] Bjarke Ingels. 2009 Yes is More: An Archicomic on Architectural Evolution. Cologne, Germany. Taschen GmbH

Sustainable Residential Building Developments Towards Neighbourhood Level: **From A Hong Kong Private Developer's Perspective**

Kevin NG^a, Edward CHAN^b

^a Henderson Land Development Co. Ltd., Hong Kong SAR, kevin.ng@hld.com

^b Henderson Land Development Co. Ltd., Hong Kong SAR, edward.cw.chan@hld.com

ABSTRACT

Hong Kong, as a high-rise high-density metropolitan city, Hongkongese living in tiny residential units and surrounded by other tall buildings is not uncommon. Scarce supply of land in Hong Kong leading to many of new residential developments are either re-developed inside a small site in old district or large scale housing estate developments in new districts or nearby new MTR stations.

Spatial and regulatory related planning constraints are primary concerns for private developers to review whether the new development is financially viable. Financially sustainable business operation is crucial for the continuous housing development by the private sector. However, social, environmental and financial sustainability are not mutually exclusive.

New residential buildings in old districts are usually be developed as a single tower, which is playing an important role in the urban renewal of Hong Kong. Housing estate development considers the environmental sustainability to a broader level. The development itself may not be able to form a self-sustained community. Hence, the elements leading to sustainability shall be extended from housing estate to district level. Environmental considerations and interactions with the neighbourhood are the crucial parameters driving a genuine sustainable design, construction and operation of a new residential development.

The approaches and success factors of sustainable urban renewal and large scale residential estate development are exemplified by some recent projects which have been accredited by both local and national green building assessment schemes. Signature urban renewal development project and a large scale residential development project obtained with LEED Neighbourhood Development were also be introduced so as to explain how sustainable residential development is extended from the conventional building level towards neighbourhood level.

Keywords: sustainable residential development, neighbourhood development, private developer

6. INTRODUCTION

1.1 Private housing in Hong Kong

Hong Kong, as a high-rise high-density metropolitan city, Hongkongese living in tiny residential units and **surrounded by other tall buildings is not uncommon. Hong Kong's natural terrain is characterised by rugged** uplands flanked by steep slopes. A layer of soft, weathered rock covers the bedrock in most places, slope debris mantles the natural hillsides, and alluvium fills many of the valleys. Most of the flat land being developed are reclaimed land and scattered throughout Hong Kong Island, Kowloon peninsula and new towns of New Territories.

Up to the end of 2015, the population of Hong Kong was 7,324,300. However, most of the lands in Hong Kong are undeveloped, whilst the built-up land accounts for only 24.2% of the total land area in Hong Kong (1,105.7km² in 2015), in which only 3.7% of the total land areas in Hong Kong being used for private and public residential usages. Hence, each person in Hong Kong can occupy equivalent to around 5.6 square metres of land. Scarce supply of land in Hong Kong leading to many of new residential developments are either re-developed in a small site in old district or large scale housing estate developments in new districts or nearby new MTR stations.

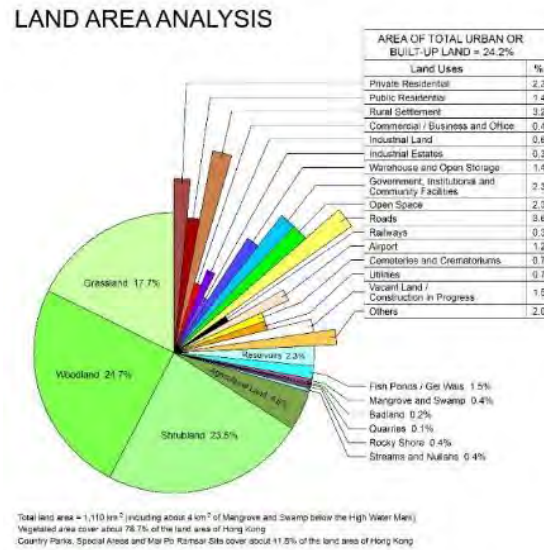

Private sector housing is playing an important role in Hong Kong. At the end of March 2015, private residential stock amounted to about 1.5 million housing units, in which the amount is larger than that of public rental housing (789,300 units) and government subsidized sale flats (398,600 units) up to March 2016. Hence, the visions and approaches of sustainable residential building developments are influential to the overall living environment from the residential unit interior level to the community and neighbourhood levels.

1.2 Sustainable residential development: Private **developer's** perspective

From the private development perspective, the planning, design and construction of each new development project is for the people and for the future. Well maintained building can be used for decades or even to hundred years. Hence, each well-planned sustainable development shall take account various building lifecycle factors. New development also aims to improve the built environment in the vicinity, such as daylight access, air ventilation, noise, hygiene, comfort and safety of its urban neighbours.

New residential buildings in old districts are usually be developed as a single tower, which is playing an important role in the urban renewal of Hong Kong. Housing estate development considers the environmental sustainability to a broader level. The development itself may not be able to form a self-sustained community. Hence, the elements leading to sustainability shall be extended from housing estate to district level. Environmental considerations and interactions with the neighbourhood are the parameters driving a genuine sustainable design, construction and operation of a new residential development.

From the private developer perspective, developer can be dedicated to the role as a corporate citizen. Developer shall consider and act on the social, economic and environmental impacts of the business and contribute to community. Spatial and regulatory related planning constraints are primary concerns for private developers to review whether the new development is financially viable. Financially sustainable business operation is crucial for **the continuous housing development by the private sector. This is particularly important for developer's continuous** investment of land and old building acquisition, design and construction of good quality building projects, as well as leading the industry ahead to improved liveability, healthy environment and well-being. In each building development, social, environmental and financial sustainability are not mutually exclusive.

No matter people are living in the old districts or new towns, various sustainable factors are influencing the residents and communities. On the environmental aspect, residents are concerning the energy and water consumption, air ventilation, health and safety factors inside their residential units. Besides, residents are also looking for environmentally-friendly common areas, such as the circulation lobbies, club house, podium and ground **level open space, as well as the supporting facilities inside the site. People's expectation** has already extended from the tiny space to the shared common areas in the past decades. Nowadays, as a corporate citizen, each building development shall extend the planning and design notions to the community level, which aims to hand-in-hand with the neighbours and share the benefits achieved from social and environmental sustainability.

7. SUSTAINABLE URBAN RENEWAL PROTOTYPE: THE GLOUCESTER

2.1 Development parameters

Situated in the old downtown area – Wan Chai, with high density and busy traffic, The Gloucester is a typical “urban renewal” residential project in Hong Kong. The Gloucester is a 34-storey 177-units residential tower sitting on a 3-storey carpark podium, with an aquarium-style indoor heated skypool on top floor as the building’s iconic feature over Victoria Harbour. The site constraints were turned into opportunities in creating a vibrant city life with comfort and convenience. The greatest challenge of design was to create an enjoyable yet environmentally-friendly living space within the old urban district.

2.2 Sustainable design considerations

The tower is enveloped with prefabricated façade with low-e tinted Insulating Glazing Units (IGU) to optimize the natural daylight, acoustic and thermal performance and to command a panoramic view over Victoria Harbour. It provides the residents with a host of recreational amenities and a podium garden articulated with vertical/ horizontal greenery at a green ratio over 30%.

The predominantly north-south facing building layout offers low heat transmissions to the interiors from the unfavourable east and west sides, appropriate window-floor ratios for natural daylight and a wide variety of flat layouts. Careful consideration is given to façade lighting design of indirect LED lights, striking a good balance between architectural elegance, and light pollution to neighbourhood. Energy efficient equipment, water saving and rainwater recycling are widely used in residential units. Waste sorting facilities and food waste composting facilities help to reduce loads to public landfill.

Porous podium façade and landscaped podium garden diverted natural wind from the harbour side to the narrow streets behind the site such that the micro-climate of the neighbourhood is highly improved. Indoor air quality monitoring in public area and effective natural ventilation shape a healthy living environment. Besides, the extended building separation of The Gloucester and the sister development Mira Moon Hotel improved the daylight access to the adjacent residential buildings substantially.

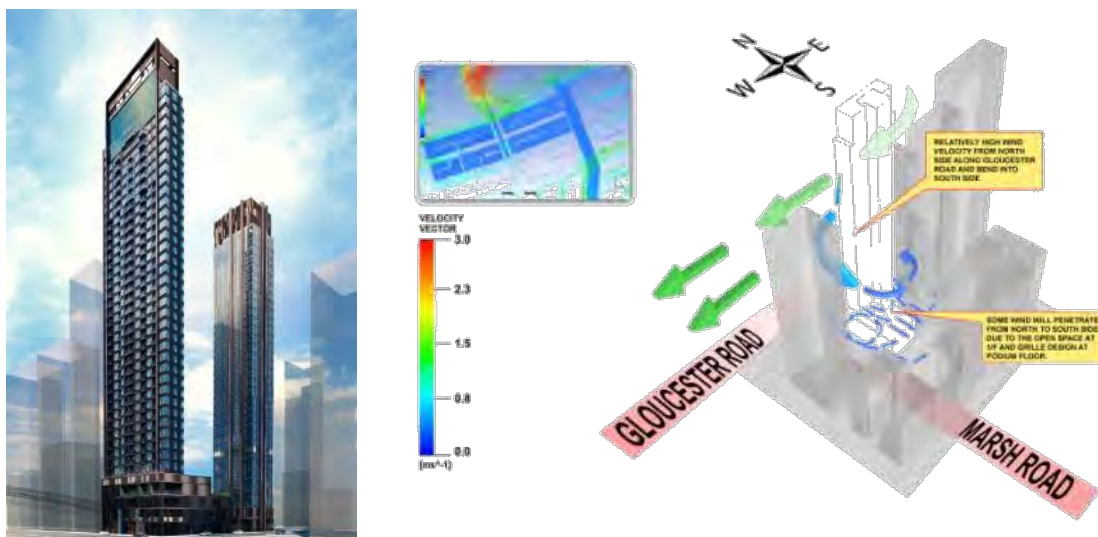

8. SUSTAINABLE LARGE-SCALE RESIDENTIAL DEVELOPMENT: DOUBLE COVE

3.1 Development parameters

Double Cove is located on a unique twin-cove peninsula which offers sweeping views across Tolo Harbour. The development comprising 21 residential towers, and offering tranquil living environment for over 3,500 households, with flat mix ranging from unit in 50m² to 320m². In addition, there will be 25,000m² of commercial and club house facilities as well as car parking with electric vehicle chargers, cycling track and jogging path around the site perimeter. Ample green space (>50% of site area) is available in the development.

The residential towers all lie along the perimeter of the development in a stepped layout from south to north, creating a larger sense of space and view for residents. Walkways, cycle paths and sitting-out areas are also available to encourage exercise within the community and promoting social cohesiveness.

New urbanism and sustainable buildings are the principles which must be collectively considered in order to attain such a quality standard. Connectivity or walkability is one of the key features. Double Cove provides a 24-hour covered footpath on the podium level allowing residents and public to move freely to the MTR Station and the Public Transport Terminus.

Double Cove residential development was awarded a Grand prize in Quality Building Award (Multiple Buildings Category) in 2016 and certified in September 2015 as Hong Kong's first LEED-Neighbourhood Development, demonstrating sustainable certification being applied beyond just the green building blocks.



3.2 Driving for green lifestyle: **'Extended Home'** with enjoyable spaces beyond the "Flat"

The vision of Double Cove is to set a New Benchmark for large-scale residential development in Hong Kong. The main focus of Double Cove development is on creating a high quality development set within beautifully landscaped park and gardens. This does not only give the development its unique sense of place, but it also creates a backdrop to the distinctively designed towers.

The idea of 'Living in a Park' by Architect, Lord Richard Rogers, became the main theme of the development and formed the key driver in many aspects of the design which echoed with the vision of the development - "Driving for Green Lifestyle".

Enhance low carbon living

Provision of electric vehicle parking spaces in public parking spaces, residential carpark and garden units with self-contained parking spaces with 32A medium speed charging facility encourages use of electric vehicles. Communal bicycle rental is available to encourage cycling as a sustainable means of transportation. A public twenty-four hours walkway with direct access to the MTR/ public transportation connecting to each residential tower and nearby developments encourage healthy and low carbon lifestyle.



Creating a comfortable and healthy environment

- Minimize view obstruction by creating view corridors for the neighbours.
- Enhance air quality through computational studies and creating optimal building separations.
- Ample planting and water features to reduce urban heat island effect.
- Air quality monitoring, hybrid ventilation and north-facing skylight in shopping arcade shaped an innovative and healthy public environment.



Promoting health and well being

- Communal bicycle rental service with electronic parking/ rental facilities encourage eco-transportation inside the site and connect into the nearby public cycling tracks.
- Extensive cycling track within the site 1,360m, connecting to other districts.
- Extensive jogging path within the development 2,302m, connecting outside.
- Energy efficient equipment, water saving and rainwater recycling are widely used.
- Waste sorting facilities and food waste composting facilities help to reduce loads to public landfill.

3.3 From “Green Building” to “Green Neighbourhood”

Site planning: Nature and cityscape consideration

The masterplan concept is a response to the site and the neighbourhood, in particular to views of the harbour and the natural surroundings. The central park creates a major ‘Green Lung’ within the development and also visual relieve for the surrounding development. The towers are mainly arranged in pairs in two curvilinear ‘wings’, enclosing the park. This arrangement creates a series of view and ventilation corridors through the site. The elevated towers with air ventilated lowest two-stories, descending in height towards Tolo Harbour, create a cityscape which is more in-keeping with the natural surroundings.



Making the sustainable living community a reality

The development was planned and achieved with LEED Neighbourhood Development (ND) elements. Double Cove was designed as a compact development and close to neighbourhood, and developed with optimized development ratio that suit the usage needs and improved environment. Healthier community was featured with comfortable living residential units and walkable street network, together with bicycle track and storage. Sustainable design was also supported by computational heat island analysis (first done for a residential project in Hong Kong) to review the heat island mitigation for the site and the nearby community.

Individual green building was designed to encourage low carbon living style by means of achieving over 10% of energy saving accordance with ASHRAE 90.1-2007, reducing potable water for irrigation by 50% and reducing potable for sewer conveyance by 20%. The site was designed to promote natural habitat together with long term conservation plan. Environmentally consciousness was achieved by extensive deployment of greenery. About **50% of the site area is designated as “green area” which includes preserving existing woodland and creating woodland extension plus green roofs, green walls, water features and landscaped amenities.**

Enhance air ventilation in and around communities

Voluntary district-wide Air Ventilation Assessment (AVA) was conducted for the development site and the district, though not statutorily required. Besides, micro-climate, outdoor thermal comfort and natural ventilation under mid-season and summer wind conditions in and around the development using computational fluid dynamic simulations were conducted to assist the site planning and building design, so as to achieve optimized micro-climate performance both within the site and the neighbours.

3.4 Landscape design and management

Landscape planning, design concept and surrounding environment

Total landscaped area, including woodlands, green roofs, green walls, sky gardens, water features and landscaped amenities constituted around 50% of total site area. 8,800m² existing woodland; 16,000m² recreated woodland extension; 26,000m² green roof, green wall, water feature, landscaped amenities; 2779 trees to be planted (756 nos. on grade, 1274 nos. on podium, 749 nos. native species) on grade.

Various types of landscape and associated features being deployed in the development, such as reserved existing woodland and creation of woodland extension, well planned tree protection measures, soundscape integrated landscape design, green roof on shopping arcade, vertical greening scattered inside the development, bio-climatic eco-garden with various local and well adapted plant species, large landscaped amenity area contains recreational and cultural elements, distributed water features and greenery to create passive cooling and breezeway, as well as unique green hedge fence wall. Before the commencement of construction, archaeological investigations were carried out by archaeologists to ensure that the priceless antiques can be well protected and handed over to Antiquities and Monuments Office (AMO).



REFERENCES

- [1] Hong Kong Yearbook 2015, HKSAR Government
- [2] http://www.pland.gov.hk/pland_en/info_serv/statistic/landu.html
- [3] <http://www.housingauthority.gov.hk/en/about-us/publications-and-statistics/hong-kong-the-facts-housing/index.html>

New Exposition of Sustainability – Linking People, Building and Community

Gary CHEUNG^a, Teri TAN^b, Alvin LO^c, Gary LEUNG^d, Chris KWAN^e

^a Arup, Hong Kong SAR, gary.cheung@arup.com

^b Arup, Hong Kong SAR, teri.tan@arup.com

^c Arup, Hong Kong SAR, alvin.lo@arup.com

^d Nan Fung Development Ltd., Hong Kong SAR, gary.leung@nanfung.com

^e Link Asset Management Ltd., Hong Kong SAR, Chris.HS.Kwan@linkreit.com

ABSTRACT

77 Hoi Bun Road is a new grade A office-cum-retail development situated in the rezoned business district of the Kowloon Bay Action Area in Kwun Tong, Hong Kong, with a total GFA of approximately 82,000m². The project aims to become part of the green driving forces that are transforming the current Kwun Tong industrial district into a new dynamic and vibrant CBD2, which is in line with the Hong Kong Government's visionary initiatives for the Kowloon East areas as set out in its Policy Address in 2011-2012: a smart city that thrives on the use of data and advanced technologies, a sustainable green community with low carbon footprint, and high connectivity to public transport nodes by means of walking.

The project team adopts many innovative design ideas to enhance the building performances in terms of sustainability, social benefits to the community as well as health considerations. From building orientation and massing, envelope design, landscaping throughout the inside and outside of the building, people's circulation, diverse functional programme, innovative technologies, to the pursuit of work-life balance and community engagement, the project exemplifies an integrated design approach involving rigorous exchange of professional expertise with seamless coordination among various design disciplines which lead to many constructive dialogues with the client to achieve a high performance office and retail architecture. As a result, the project will become an iconic landmark in the CBD2 when it is completed in 2019. Unique green features in the building includes varying width of solar responsive shading devices optimized by computer simulation technique, sky garden with fitness equipment for the office community, air induction unit (AIU), naturally ventilated carbon filters, solar dehumidification system, to name just a few.

The proposed development has been registered with the world-wide recognized sustainable framework like LEED and BEAM Plus for the highest Platinum rating. The project will also be one of the few pioneers in Hong Kong to address the health and wellness issues of the building users, which will be assessed to achieve a WELL Certification by the International WELL Building Institute in USA, the leading healthy building label in the world.

Keywords: high-performance building, community empowerment, climatic responsive architecture

1. INTRODUCTION

In the Policy Address 2011-2012, the Chief Executive announced that the Hong Kong Government would transform Kowloon East (KE) into another attractive Central Business District (also known as CBD2) to sustain economic development (The Government of the Hong Kong Special Administrative Region, 2011). To expedite the plan, the Hong Kong Government was considering relocating the existing government facilities in the two action areas of KE. One of them is known as Kowloon Bay Action Area (KBAA) (The Government of the Hong Kong Special Administrative Region, 2013).

To achieve the envisaged commercial and office hub in the district, KBAA has been planned based on a number of guiding principles including: (a) to cater for territorial needs and generate public benefits; (b) to make efficient use of land resources; (c) to promote smart city and green neighbourhood; (d) to deliver quality urban design and integrate with surrounding urban context with place-making strategy; (e) to enhance pedestrian network; and (f) to ensure implementability (Development Bureau, 2016).

Despite the grand vision of the HK Government, the polluted air, heat and noise generated from surrounding industrial buildings and busy road networks cannot be totally mitigated at the moment.

Given the above vision and challenges, the proposed development aspires to create a pleasant and desirable environment for the future users, which addresses air quality and acoustics, whilst holding the vision that the **building will act as a “green lung” and “pedestrian hub” to its immediate environment. Apart from environmental sustainability, the building design framework is further extended to address the issues of green community and people’s health and wellness, aiming at linking people, building and community together.**

1.1 Integrated design approach

The proposed Commercial Development at 77 Hoi Bun Road will provide approximately 82,000m² of office and retail floor areas to the new CBD2, comprised of 17 levels of Grade A offices, 3 levels of retail podium, 3 levels of basement carpark, a roof garden and a podium sky garden to be shared by the office community and retail customers.

At the project commencement stage, sustainability workshops were held between the client and all the consultants together with the future facilities manager to align the expectations of different parties to set up clear and achievable goals for the new development. These early engagement exercises provided an open forum to the team to have open dialogues to thoroughly understand the strengths and weaknesses of every possible design solution from different perspectives, and only the best options acceptable by everyone were then adopted in the final designs.

2. LOW CARBON, GREEN COMMUNITY

2.1 Pedestrian hub and landscape design

Being the first commercial development in KBAA and situated at the crossroad between KBAA and the waterfront, and between Ngau Tau Kok MTR (Mass Transit Railway System in HK) Station and Kai Tak, 77 Hoi Bun Road would become a busy pedestrian hub in the future CBD2 of KE. Potential footbridge linking the public terrace to the upcoming Action Area provides a flexible connection in the pedestrian network, an essential component that enhances pedestrian connectivity in KE.

To further enhance the walkability for the neighbourhood and enrich the pedestrian experience, building setbacks, public spaces, green walls and extensive landscaping are utilised to create transition areas between the heavily trafficked road and the development. Lush landscaping in these areas **serve as an effective “air purifiers” and “sound barriers” to filter air pollution, noises and excessive solar heat gain, ensuring desirable outdoor open spaces and indoor environment.**

Feature green walls at pedestrian level improve streetscape and provide visual focuses for pedestrians approaching from both the Action Area and waterfront facing the Victoria Harbour and the new Cruise Terminal. Other outdoor greenery, building setback and canopies at various locations are also utilised to create a pleasant pedestrian zone around the building. Special attention has been given to the design of these transition areas between outdoors and indoors to ensure good air quality, comfortable and green surrounding can be experienced by the pedestrians as they approach the building, whilst desirable indoor environment quality (IEQ) with good thermal comfort and healthy building environment are provided once inside the building – **an “Urban Oasis” amidst the currently harsh industrial setting surrounding the site.**

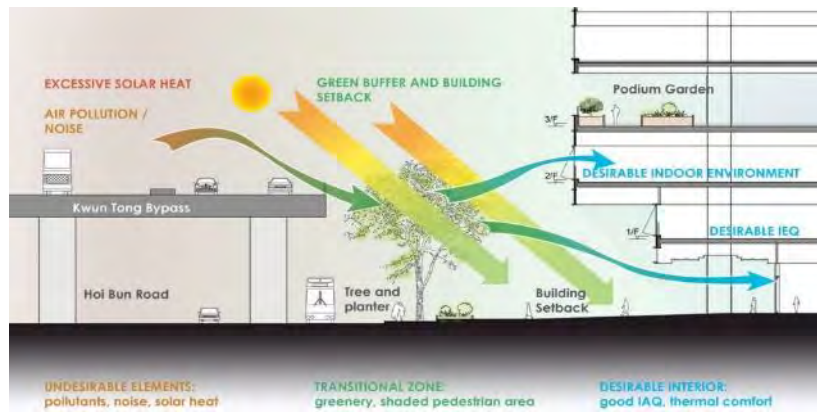

Figure 99: Concept of transition area

2.2 Spaces for green community

A wide range of communal areas and green spaces have been distributed throughout the building to form part of the green community. Well integrated into the building form, the harmonious spatial quality of these areas create a well-balanced interior and exterior. Building users or people from the community can freely encounter nature at various locations; allowing for spontaneous interactions with the sustainable facilities that will enrich the daily experience.

Once inside, biophilia accesses to urban greenery, health and active transportation feature heavily. Making up 30% of the site area, gardens are interspersed at G/F event plaza, terraces on 1/F, 2/F, 11/F, 21/F, while the roof and 3/F podium are largely dedicated to greening.

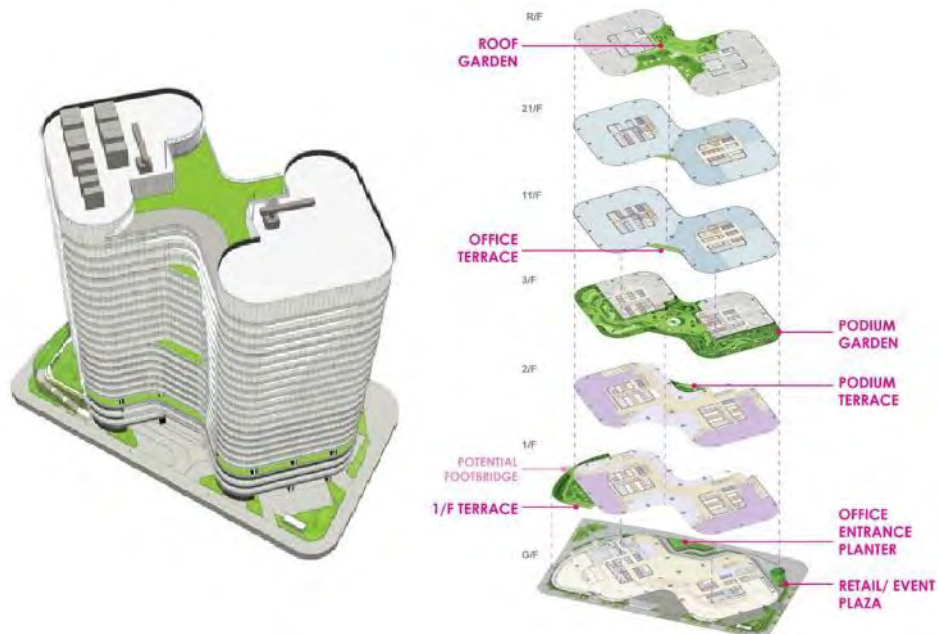

Figure 2: Communal area and green spaces

3. HEALTHY DESIGN

Sustainability is a major trend in the building industry. It can be reflected from the international sustainability building rating systems such as BREEAM in UK, LEED in US, BEAM Plus in Hong Kong, CGBL in China, etc. The systems usually focus on the environmental related issues such as climate change, energy and carbon reduction, pollution, water conservation, etc. However, there is critique that these systems cannot fully address the human health issue in buildings (Wargo, 2010). To respond to the challenge, the project team introduced numerous initiatives to

encourage a healthy environment and life style through the building design. These address concepts of air, water, nourishment, light, fitness, comfort and mind (International WELL Building Institute, 2015).

3.1 Cleaner air

Adjacent to the Kwun Tong Bypass and heavy vehicle traffic, outdoor air quality is a concern. EPD's Indoor Air Quality Certification Scheme and WELL Air Quality Standards were used to guide the filtration system design. As a start, the primary air handling units (PAUs) are placed on the opposite side of the Bypass, and elevated from the traffic through their placement on 3/F and R/F. Prior to occupancy, flush out and filter replacement will be carried out. In operation, carbon and MERV13 filters in the PAUs target the removal of nitrogen dioxide and small particulates such as PM2.5, while duct ionisers and MERV13 filters primarily treat volatile organic compound (VOCs), formaldehyde and particulates in the recirculated air of the air handling units. Fan coil units in common areas will have the capacity to install carbon filters in the future. Low-emitting materials will be used in the paints, coatings, adhesives, flooring, insulation, furniture and furnishing of the interior to minimise VOCs and formaldehyde.

The innovative Air Induction Units (AIU), carbon filter and pollutant-reducing plants are proposed to enhance the outdoor air quality by serving as an air curtain in the occupied zones of the 3/F podium garden

3.2 Occupant comfort

Enhanced fresh air provision, humidity control through adopting the solar dehumidification, good acoustics and glareless type light fixture improves the indoor comfort of the office spaces. Positive pressure sensors ensure that main entrances are kept cool and free from pollutants. To improve thermal comfort of outdoor areas, especially during hot summer days, AIUs enhance the thermal comfort in the podium gardens, while fans will serve the drop-off waiting area.

3.3 A work life balance approach – energising garden

To promote work-life balance in the future community in the building, easy access to the exercise facilities can motivate more people to take up the health habit. Therefore, an energising garden is designed on the 3/F Sky Garden, where outdoor recreational facilities are provided to allow people to do physical exercise, or to take breaks away from their work environment.

The Sky Garden is divided into passive and active zones, where diverse activities from yoga, stretching, relaxation, cycling and jogging can occur. To raise public awareness on sustainability and attract more people to do exercise, kinetic bicycles will be provided and the jogging track will be paved with tiles equipped with electricity generator. For every step, electricity will be generated and recorded for the achievement made. Further, cycling amenities like basement bicycle parking and showers can encourage cycling for reducing transport energy to the transport nodes or the nearby Kwun Tong promenade.

3.4 Healthy staircase

To encourage the use of staircase, an accessible stairs is provided with signage, enhanced lighting and artwork to encourage occupants to take the stairs instead of vertical transportation, minimising energy consumption.

4. SUSTAINABLE DESIGN

4.1 Passive design – solar responsive shading devices

High-rise, high density are the characteristics of Hong Kong built environment (Ng, 2009). The building solar heat gain can be affected by both self-shading effect due to the built-form and the shading effect by the external surrounding buildings. Owing to the complex and dynamic interaction between buildings and the sun position, there is no quick tool to calculate the facade solar heat gain.

However, thanks to the state-of-the-art computer modelling technique, the solar heat gain can now be visualised as shown in Figure 3. Variation due to the shading effects was observed on the facade. Based on the analysis, the envelope was classified into 3 different zones in which depths of the horizontal overhangs are determined with reference to the respective solar heat gain. Excessive solar heat gain is thus mitigated through the optimisation of

shading. Combined with high performance glass, the building design targets to achieve Overall Thermal Transfer Value (OTTV) of about 18W/m², significantly lower than the code requirement of 24W/m².



Figure3: Computer modelling and visualisation of building solar heat gain

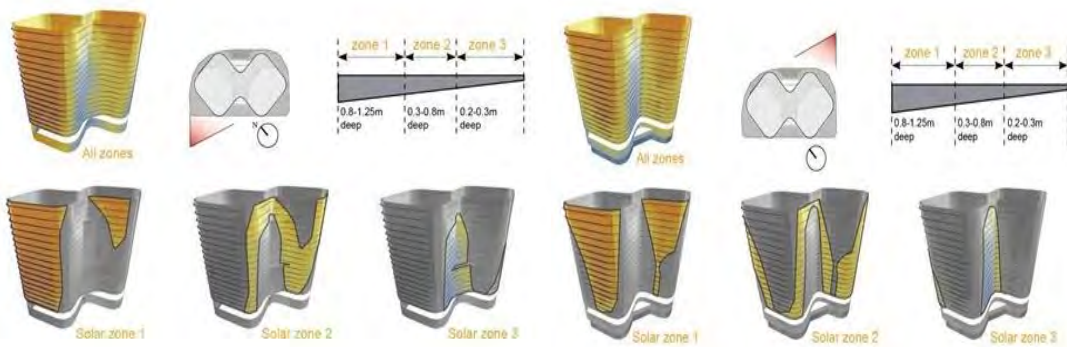

Figure4: Illustration of solar shadings in different zones

4.2 Active and renewable system design

The HVAC systems have incorporated a dehumidification system integrated with solar hot water panel specifically designed for Hong Kong context where it is humid for most of the year. The desiccant system can absorb the water moisture in the air and then regenerated using solar hot water. The renewable energy generated is equivalent to 2% of annual building consumption. Other implemented carbon reduction measures include variable speed drive chillers, heat recovery system, LED lighting for office spaces, regenerative unit for lifts, etc. Compared to the Baseline of Building Energy Code (BEC) 2012, the project building targets to reduce energy use by 33.4%. The detailed breakdown of energy reduction is illustrated in Figure 5

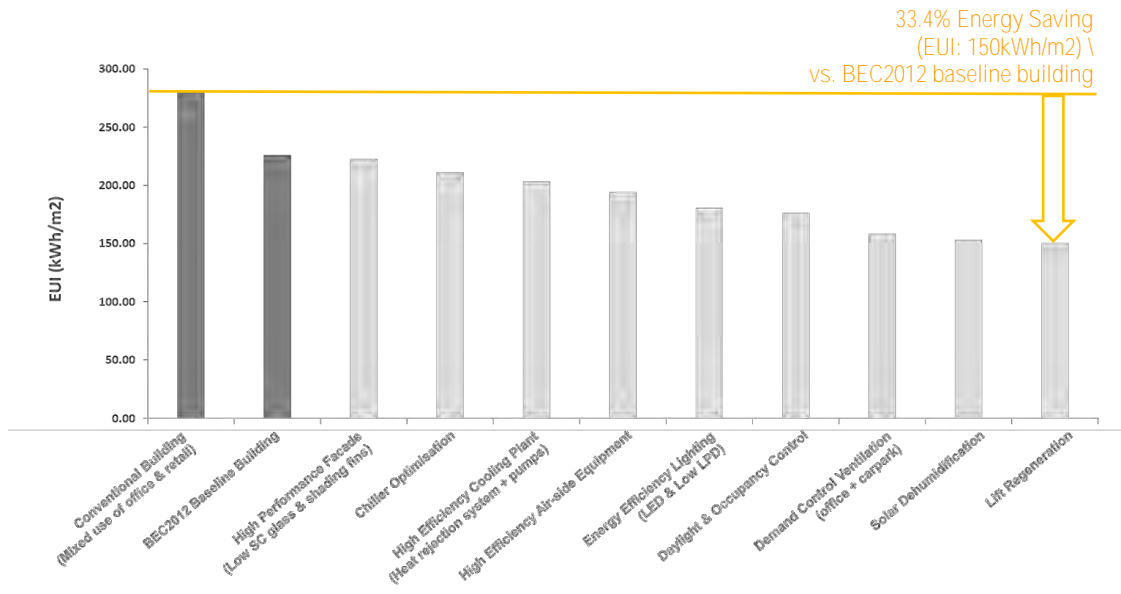

Figure5: Energy reduction breakdown

4.3 Operational performance

A detailed measurement and verification plan, testing and commissioning requirements, as well as having an independent commissioning agent will ensure the sustainable operations are maintained. Intelligent BMS allows 24x7 real-time monitoring of electricity and water meters and the data recorded is converted into meaningful information for performance display in the office entrance lobby. They communicate to staff and visitors how the building is performing, provide sustainability information and tips in a simple, real-time and interactive manner. **Other information like health diet, exercise and community activities update will also be shared to raise users' health awareness.**

Furthermore, to echo the smart vision of the district, mobile apps will also be **developed for users' access to a world of real-time parking information, e-queuing for restaurant, shop recommendations and more.**

4.4 Water saving

Since the greenery accounts for more than 30% of the site area, the water demand for irrigation will be huge. Thus, to utilise water resources wisely and effectively, rainwater recycling system is proposed to reduce the potable water use for irrigation make-up. Rainwater is collected on roof and ground floor under the pervious paving. After treatment in the plant, the rainwater will be stored in the tank for irrigation use. Cooling tower bleed-off for flushing and water efficient sanitary fittings further mitigates potable water use.

5. CONCLUSIONS

This paper introduced the design methodology and implemented sustainable design features for the project. Through the integrated design process, the team has identified the major challenges and formulated the design framework based on environmental sustainability, green community and human health.

Last but not least, the proposed development has been registered with the world-wide recognized sustainable framework like LEED and BEAM Plus for the highest Platinum rating, for recognition of the tremendous efforts by client in conjunction with the consultants to contribute to the environment. The development will also be one of the pioneering projects in Hong Kong to address the health and wellness issues of the building users, and it will be assessed under WELL Building Standard, a performance-based system for measuring, certifying and monitoring criteria for the built environment that would affect the well-being and health of the building users. The WELL Certification is offered by the International WELL Building Institute in USA, a leading healthy building label in the world.

REFERENCES

- [1] Ng, E., 2009. Policies and Technical Guidelines for Urban Planning of High-Density Cities – Air Ventilation Assessment (AVA) of Hong Kong. *Building and Environment*, 44, 1478-1488.
- [2] Wargo, J., 2010. *The Green Building Debate: LEED Certification where Energy Efficiency Collides with Human Health*. North Haven, Connecticut, US.
- [3] The Government of the Hong Kong Special Administrative Region, 2011. 2011-2012 Policy Address. Hong Kong.
- [4] The Government of the Hong Kong Special Administrative Region, 2013. 2013-2014 Policy Address. Hong Kong.
- [5] International WELL Building Institute, 2015. *The WELL Building Standard, Version 1*. New York, NY.
- [6] Development Bureau, 2016. *Planning and Engineering Study for the Development at Kowloon Bay Action Area – Feasibility Study: Preliminary Outline Development Plan*. Hong Kong.

Sustainable Workplaces in High Density Urban Areas

Ryusuke KOJIO^a

^a TAKENAKA CORPORATION, Japan, kojio@takenaka.eu

^a TAKENAKA EUROPE GMBH, Germany, kojio@takenaka.eu

ABSTRACT

Recently in Japan various methods of green design, construction and operation of buildings have been developed. This paper introduces two recent award-winning projects, which demonstrates how careful consideration and refined design and construction techniques can achieve a sustainable urban environment. The projects are both multifunctional buildings with vast office floor areas, yet they both offer a comfortable landscape of workplace environment through “utilizing natural sources” and “encouraging human communication”.

Supertall Compact City: Abeno Harukas

Abeno Harukas is a super tall building with 60 above ground floors and five basement floors and, at a height of 300m, is the tallest building in Japan. Completed in 2014, ‘Supertall Compact City’ integrates the huge activities of sprawling cities into one supertall building. The following three elements are key to attracting people and further to generate conditions in which people get together: three-dimensional routes affording various choices, networks of ‘Eco-voids’, and three-dimensional networks of greenery.

100X100m: A pioneering eco-friendly model - Meiji Yasuda Life Insurance Building

This integrated office facility combines the main office of a life insurance company with lodging for trainees. Completed in 2011, the office spaces are divided into four large and small sections with floors on staggered levels interconnected around a continuous spiral core at 1.2-meter intervals. An atrium measuring 35-by-35 meters in the centre of the building, contains a light court of 17-by-17 meters, which attracts abundant light and outdoor air creating an environment in which people can communicate with nature as they work.

In order to create “architecture for sustainable society” it is extremely important to offer a rich and varied living/working space and quality environment not just reducing environmental burdens. This idea applies not only to major projects but also smaller size buildings.

Keywords: high-performance building, energy saving, nature

1. INTRODUCTION

The workplace environment in Japan in recent years has advanced to a different stage. From focusing on efficiency or functionality of closed work spaces, it has now become essential to create ‘collaboration space of open organization’ rather than ‘divisional cooperation of closed organization’. (Konno et al., 2012)

The two projects (Image 1 and 2) introduced here are both multifunctional buildings with significant office floors areas, yet they also provide a comfortable landscape of an open workplace environment simply by means of “utilizing natural sources” and “encouraging human communication”.



Image 1: Abeno Harukas Image



Image 2: Meiji Yasuda Life Insurance New Toyoko Building

2. ABENO HARUKAS: SUPERTALL COMPACT CITY – 300 M HEIGHT

Situated in Osaka, heavily dense urban area, Abeno Harukas was planned and realized as a super tall building with 60 aboveground floors and five basement floors, covering a total floor area of 306,000m². At a height of 300m above the ground, it is the tallest building in Japan, and was completed and opened in 2014. (See Figure 1)

2.1 Environmental design

High-level CO₂ reduction targets were established to achieve a low carbon emission building (See Figure 2,3), and the architects and engineers worked to achieve these targets especially by means of multiuse function of the building as well as utilizing natural sources and its height.

Utilizing multi-functionality

The load levelling of heat source demand by multi-functionality of the building use, and the energy recovery from utilizing heat interchange and height of the building greatly increases the energy efficiency of the entire building.

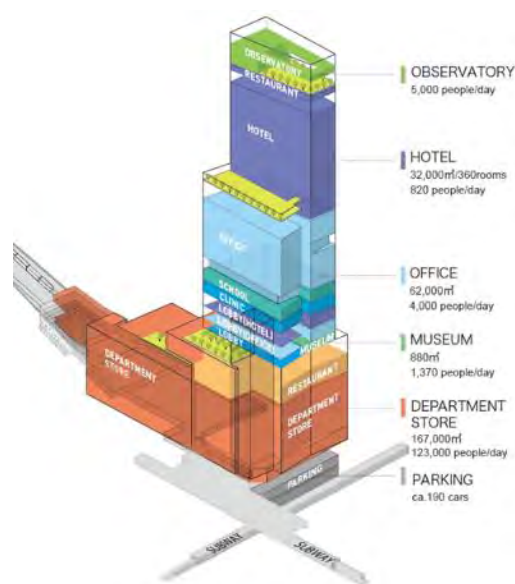

Figure 1: Building composition

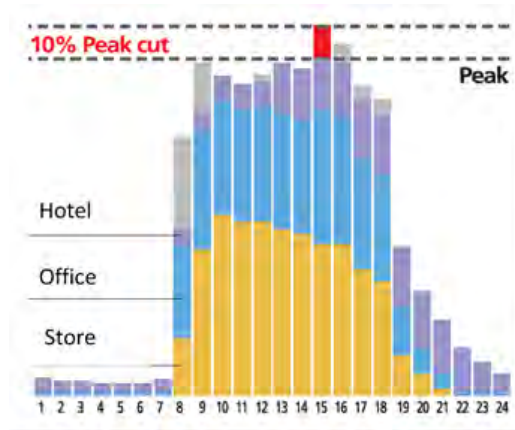

Figure 2: Peak cut

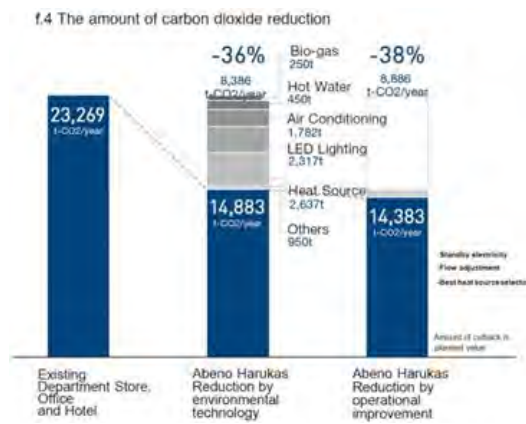

Figure 3: CO₂ reduction

“eco-voids”

The building is exposed to the outdoor air and natural light by making use of “eco-voids”, which stimulate sensitivity and creativity of the office staff, while they simultaneously reduce environmental burdens with “passive technology” which decreases energy required for lighting and air conditioning. (See Image 3 and Figure 4.)



Image 3: Eco-voids

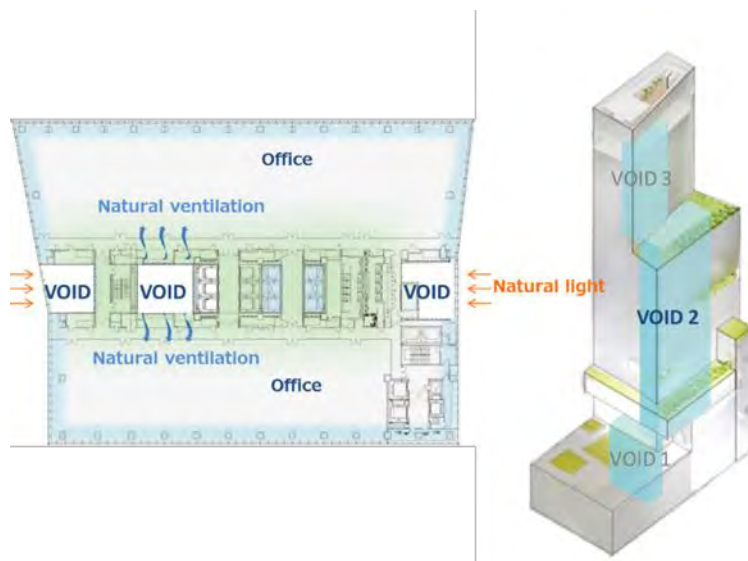

Figure 4: Eco-voids and Effects

2.2 Three-dimensional sky gardens x voids x trajectories

The shuttle elevators (6 times 60 passengers units) installed in the corner of the building convey large numbers of people to the three lobbies located high above in the air (Air Junction), creating vertical circulation that provides an extension to urban transport. Trajectories further branch off from the lobby floors, establishing a complex network of multifaceted spaces. These selectable trajectories incorporate the city's dynamism. (See Figures 5, 6)

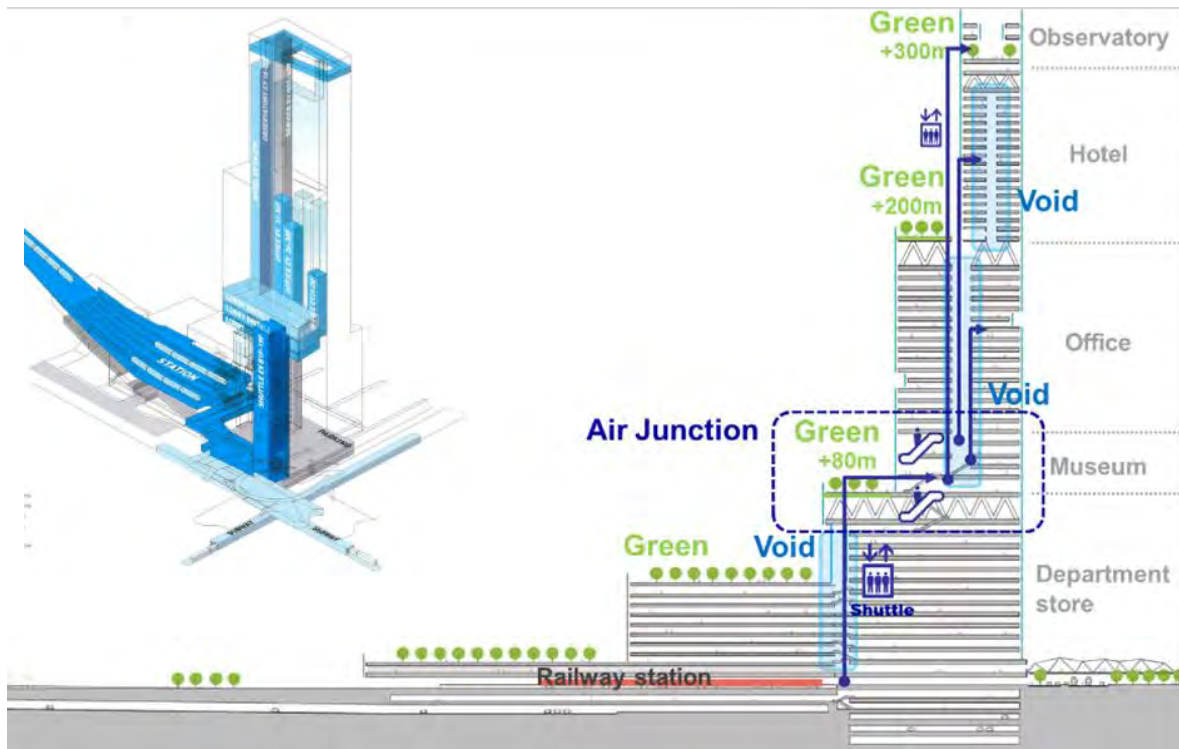

Figure 6: Green – voids – trajectories

The floors of the building are set back further and further the higher they are, making it possible to create several roof gardens. People can find their own spots within these roof gardens and the surrounding green spaces, each spending time in their own way. (See Images 4, 5.)



Image 4: 58th floor Observation deck



Image 5: 16th floor Sky garden

3. MEIJI YASUDA LIFE INSURANCE NEW TOYOCHO BUILDING

A pioneering environmentally friendly model office building: 100X100m office

In the eastern part of Tokyo, the integrated office facility combines the home office of a life insurance company with lodging for trainees. The office spaces are divided into four large and small sections with floors on staggered levels interconnected around a continuous spiral core at 1.2-meter intervals. It was completed in 2011. (See Image 6.)



Image 6: Front façade

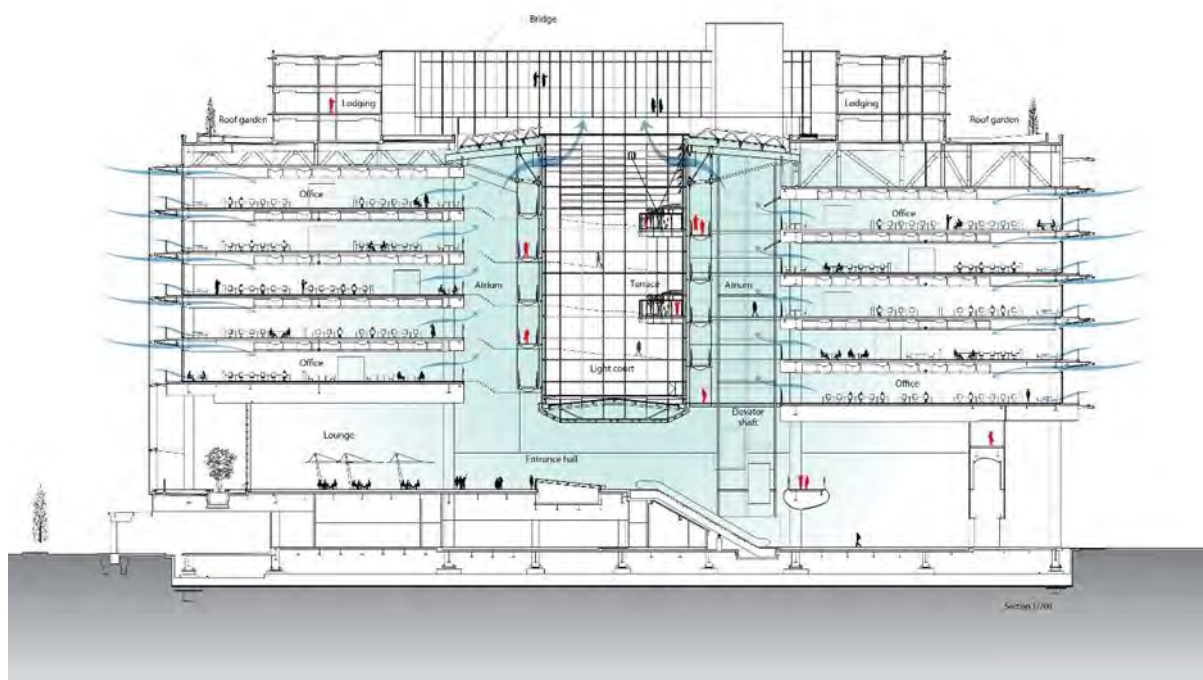

Figure 7: Section

3.1 Communication with nature

Atrium and light court

An atrium measuring 35-by-35 meters in the centre of the building with the office floors arranged around it contains a light court of 17-by-17 meters in its centre that draws in abundant light and outdoor air creating an environment in which people can communicate with nature as they work. (See Figure 7)

Natural ventilation

Natural ventilation is provided through outdoor air intakes controlled by dampers on the balconies around the outside perimeter of the building and by windows that can be closed or opened at will. Fresh outdoor air passing through the office spaces is discharged from the centre of the upper section of the atrium and solar chimneys. The atrium serves as an environmental facility combining architectural and equipment planning in pursuit of a comprehensive reduction of CO₂ emissions.

3.2 Spiral office configuration

A low-rise planar configuration with 100-by-100-meter floors was chosen to enable flexible responses to office reorganizations and increases/ decreases in numbers of staff as well as changes in department layouts without hindering intervening floors. (Figure 8, 10)

The office portion of the building is divided into two large and two small column-free areas comprising continuous floors arranged in a spiral formation on staggered levels 1.2 meters apart. As the images below show, the seamless work places can be clearly seen. (See Images 7, 8, 9, 10, 11)

3.3 CO₂ reduction

CO₂ emission from the entire building (office, training, conference area): 53% reduction from the average level of office buildings in Tokyo. (Figure 9)

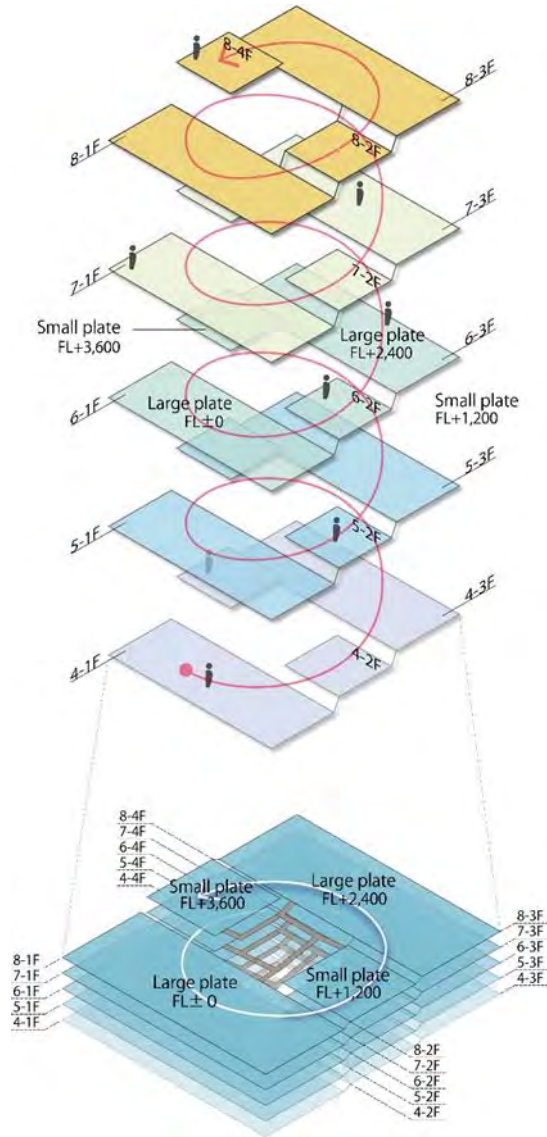

Figure 8: Spiral floors

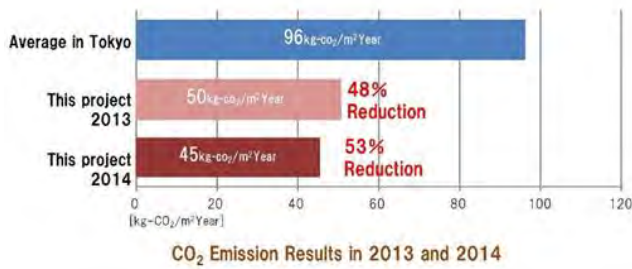

Figure 9: CO₂ Emission

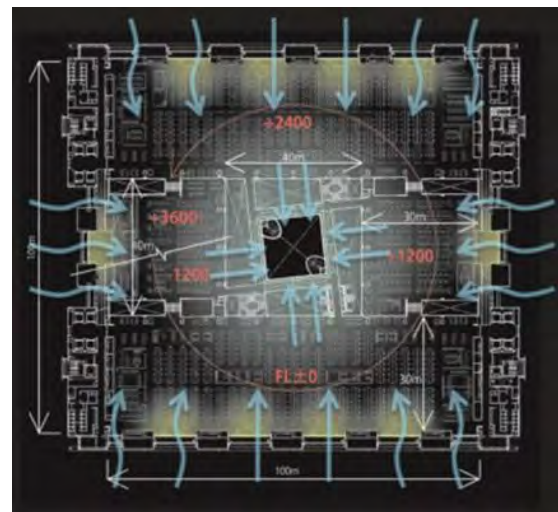

Figure 10: Natural ventilation for 100m X 100m space



Image 7: Entrance hall



Image 8: Inner void/ atrium



Image 9: Outer void/ Light court



Image 10: Flying slopes



Image 11: Flying slopes

4. PRACTICES ON PROJECTS IN SMALLER SCALE

Smaller scale workplaces present different challenges for our organization, however we have been able to find ways to provide “Sustainable works” to the society in many regions. In Germany, for example, despite having to comply with the stringent legal requirements there, we suggest, plan and realize some greener solutions.

“Communication and collaboration” is almost always a key factor in enriching an office environment, and atria, courtyards, voids, terraces and the like are considered to achieve the most beneficial way to support this. While providing a space for get-together, environmental effects of the space are always carefully devised, to take account of factors such as daylight, natural ventilations etc. (See Figures 11, 12)



Figure 11: Natural ventilation simulation

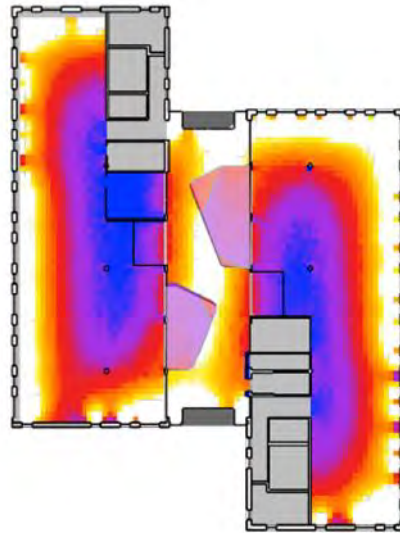

Figure 12: Natural light simulation

5. SUSTAINABLE ARCHITECTURE: THE BEST PRACTICES

“Sustainable architecture” should have been originally “architecture that was designed for a sustainable society, and the best practice for sustainable architecture must be architecture that predicts new architectural possibilities [2]” (Kodama, 2003), whereby it is quite important to have rich and quality living/working space, not just reducing the burden on the environment. The following two main issues are to be always emphasized in our works: the creation of a highly efficient and high-quality workplace, and the reduction of the environmental loads utilizing all the blessings of nature.

“Living in harmony with nature” would be always what we want to realize when planning and building ..., just like Japanese traditional-style buildings. So our aim to design is ‘Modesty to live with nature’.

REFERENCES

- [1] Kodama, Y., 2003. Sustainable architecture – the Best practices, Journal of Architectural Institute of Japan Complete papers No. 1, 2003.02
- [2] Konno, N and Hua Y., 2012. Workplace design for intellectual creation. Nihon Roudou-kenkyu-zassi (Japan Labor Research magazine) No.627, 48
- [3] Shinkenchiku BIG COMPACT ABENO HARUKAS SUPERTALL COMPACT CITY, No. 89-11 2014.09
- [4] Shinkenchiku SUSTAINABLE ARCHITECTURE, No. 80-6 2005.05

Poster Session

Estate Revitalization Scheme Ping Shek Estate: Pilot Project Completed

WONG Man-lung^a, LAM Ho-yin^b

^a Hong Kong Housing Department, Government of the HKSAR, Hong Kong SAR, ml.wong@housingauthority.gov.hk

^b Hong Kong Housing Department, Government of the HKSAR, Hong Kong SAR, ricky.lam@housingauthority.gov.hk

ABSTRACT

Ping Shek Estate is a public rental housing estate owned by the Hong Kong Housing Authority (HKHA). It has been built over 40 years ago and was completed in 1971. HKHA decided to implement the Estate Revitalization Scheme in 2010 to rejuvenate the estate. According to the four core values of the HKHA, namely, caring, customer-focused, creative and committed, the estate facilities and environment were brought up to current standards.

Through the Scheme, traditional characteristics of the Estate were preserved and facilities renewed. The main improvement works included the provision of new lifts and escalators to enhance barrier-free access, a covered performance stage for special festive and community events, and covered walkways connecting main activity pockets, tactile guide-paths, and other activity zones so that the estate could provide a better living environment for tenants of all ages.

The main purpose of this project is to “preserve and enhance”. Hence no tree was felled during construction but more greeneries were introduced. Building-integrated photovoltaic (BIPV) panels were installed to generate electricity for solar lightings. Natural lighting was used in a Well Being Centre and automatic irrigation system was used at green roof; and all these served to save electricity as well as reduce carbon emission.

With the change of population profile and living habits of residents, vacant market stalls were changed into a “Well Being Centre” for community use and surplus car parks were converted into a “Shopping Lane” with four new shops added.

The project demonstrates how a carefully planned and implemented revitalization project can help to transform our built environment to suit the changing needs of people and community. The project was successfully completed in 2014. It also received the Finalist Award in the Green Building Award 2014.

Keywords: sustainable neighbourhood, energy saving, green economics

1. BACKGROUND



Ping Shek Estate is a public rental housing (PRH) estate owned by the Hong Kong Housing Authority (HKHA). Once situated in a remote locality, Ping Shek Estate is now conveniently accessible by the Mass Transit Railway (MTR) and other means of public transport. Built in the 1970s, the Estate is now housing about 12,000 people in 4,574 domestic flats. About $\frac{1}{3}$ of the tenants living in the estate are over 60 years old, and there are around 930 elderly households.

The estate area is about 54,000 m², with 7 domestic blocks surrounded by generous open space. Five of the domestic blocks are 28 storey high with lift service for even floors above the 5th floor and the two 8 storey low blocks are with no lift service. A large central podium with a one-storey carpark underneath extends as the lowest floor of the two low blocks. Ping Shek Estate has an ample supply of car parking spaces as well as 6,700m² of retail areas and comprises a restaurant low block, ground floor shopping arcades and a cluster of market shop stalls.

Over the years, a number of maintenance and improvement works e.g. concrete repairing, re-roofing etc. have **been implemented through the Housing Department (HKHA's executive arm) to maintain the estates' original designed functionality**. But for an **estate of 40 years old, due to changes in the population profile, tenants' activity patterns and developments in the vicinity over the years**, the original estate design and provisions have become outdated. Some of the provisions and amenities have to be **brought closer to current standard to meet the tenants' needs**. After assessing that the Estate can stand structurally safe and are economically viable to be retained for another 15 years, HKHA had decided to implement an Estate Revitalization Scheme (ERS) for the Estate.

2. REVITALIZATION CONSIDERATIONS

Ping Shek Estate's mature community, convenient location, relatively spacious layout, and possibilities to optimize the commercial facilities are among the unique characteristics which present an opportunity for the HKHA to consider a revitalization project taking into account the views of tenants and their activity pattern.

2.1. Putting people first

Ping Shek Estate did not have a prominent main entrance, and the estate as a whole lacked an identity. Tenants commonly remarked that the estate blocks, retail shops and estate amenities appeared somewhat outmoded. Both pedestrian and vehicular traffic near the Choi Hung MTR exit at Clear Water Bay Road were heavy where they criss-cross the estate road.

As old age sets in, living in building blocks without lift service and moving around the estate with different platform levels would, for some **1/3 of Ping Shek Estate's population, not as effortless as before**. **Elderly tenants** characteristically would spend more of their **time hangout out in the estate common areas enjoying each other's company**: here in Ping Shek Estate gathering outdoor for morning Tai Chi, playing chess or chatting with neighbours in the shade of trees, and taking grand children to the playground are daily routines for the elderly. Ping Shek Estate has pockets of recreation ground scattered in the open space, but they were designed many years ago modeled on a much different estate population profile. Our aim is to provide a better living environment to meet the needs of our tenants.

2.2. Scope of work

The ERS brought the estate provisions and amenities closer to more recently completed estates as far as **practicable and enhanced tenants' living environment through an optimum scope of work that is cost-effective, benefit tenants' activity pattern and not causing unnecessary nuisance to tenants –**

- Gave the entire estate a facelift and an identity through creating visual interest and functional landmarks;
- Provided barrier-free access and improved connectivity within the estate;
- Converted existing public areas to quality communal space and enhanced greening;
- Adapted under-utilized retail premises and carpark to better uses to optimize their commercial potential and enhanced the estate amenities;
- Improved common areas inside domestic blocks including ground floor lift lobby and corridors at typical floors;
- Enhanced home safety paying particular attention to the special needs of elderly and physically impaired tenants; and
- Saved resources through use of renewable energy.

3. DESIGN SCHEME

3.1. Estate common areas

The passage connecting the Choi Hung MTR station abutting Clear Water Bay Road was modified as the estate main entrance serving as a visual and functional landmark for Ping Shek Estate, with a lift and escalators added to facilitate access. Most of the vehicular traffic was diverted away from this part of the estate road and traffic calming features were installed to ensure safe pedestrian crossing. The overall design of the entrance area was given a decorative touch of “stones” to echo the estate name (Ping Shek Estate 坪石邨) and create a visual landmark.



A portion of the carpark next to the new estate main entrance was converted into a shopping lane of small grab-and-go shops. The new shops realized the retail potential brought by the pedestrian traffic from the estate main entrance, and the atmosphere of a vibrant shopping lane in turn enhanced the ambience of this area.



A weather-protected network of pedestrian walkways running through the entire estate provided unobstructed access to all blocks from the estate entrances. The works involved the addition of about 500m long covered walkway of lightweight structure and modification to the existing walkways to align the design. The walkways were formed into activity pockets at suitable locations, e.g. pavilions, chess or bird-cage corners, shaded seating areas and lead to walking trails, Tai Chi garden etc. Community play areas were designed to integrate rather than segregate activities of the elderly and the kids, where fitness equipment for the elderly was placed close to or **intermingled with children's** play equipment. Other estate amenities such as ball courts, lighting and furniture were also refurbished based on current standard.



The spacious podium square occupies a central position in the estate. As it is effectively the roof structure of the carpark underneath, possibilities of planting trees or major alteration works were excluded. The relatively dull paving was replaced with finishes of a more-lively pattern and planters, and flower beds or landmark icon were put there to turn the area into a visually interest focal point. For the square to double as a central event plaza, a covered stage for festive and community functions was also added.

A new lift tower was added to the restaurant block. The covered area under restaurant was brightened up with better lighting and fitted with seating / chess tables, and ample room was left to accommodate group activities as this is a popular morning exercise area.

The shopping provisions were reviewed to meet the tenants' needs. The shopping arcade was given a refreshed look through aligning the shop front design while preserving the characteristics of the old shops. The market stalls were refurbished with the awnings replaced by an orderly canopy design.

Commercial premises of low retail value were put to better communal use. A few of the long-standing vacant market stall were converted to a small multi-purpose hall, serving primarily a memory corner of the estate and a **meeting place for tenants, and can be readily used as a "well-being centre" for charitable organizations to provide regular health services for the elderly, or turned into a study room for youngsters during examination time.**



The roof of the market stall visually had been in a rather run-down state, and turning it into a green roof substantially improved the views of the domestic flats facing the market stalls; the greening project was also extended to the roof of the two low blocks. In addition, automatic irrigation system was installed at the green roof. This would reduce future operation cost for the green roof. A communal farm was provided at a suitable location in the estate open area. The greening ratio of Ping Shek Estate as a whole had risen from the existing 21% to some 23%.

Building-integrated photovoltaic (BIPV) panels were installed on top of new covered walkway. In addition to solar bollards, use of natural lighting in the Well Being Centre and automatic irrigation system at green roof, all served to save electricity as well as reduced carbon emission.



3.2. Block common areas

Another new lift tower was added to each of the two low blocks, and lift modernization works were carried out to the five high blocks.

The external facades of the blocks were redecorated with a new colour scheme that had given a different accent colour to each of the seven blocks according to the block names.



The ground floor lift lobbies were given a facelift, with seating benches provided to turn it into comfortable waiting areas. Tiling panels with accent colour were added to the lobby wall to create visual interest. Existing metal louvers were modified to make full use of day-lighting and lighting design was enhanced. False-ceiling was installed to hide unsightly pipeworks and the randomly fixed electric fans were replaced by ceiling fans to improve ventilation. Besides these, the security counter, letter boxes and notice boards were replaced based on current standard.



In response to tenants' feedback, canopies at the corridor ends of each floor to the high blocks were installed to reduce rain penetration. The paving and lighting design were modified to brighten up the internal courtyards of the high blocks. Corridor lighting was progressively replaced with energy efficient light fittings.

3.3. Domestic flats

The domestic flats were further enhanced in the following areas-

- Laundry racks were installed to replace bamboo pole holders;
- Grab rails were fixed inside bathrooms for elderly tenants;
- Ramps were added at flat entrance for wheelchair users;
- Modifications works were carried out to particular flats according to the specific needs of elderly tenants or tenants who are physical impaired.

4. COMMUNITY HEARTWARE

Our society is devoting more attention and resources to green and healthy living, enhancing home comfort and enabling elderly persons to be integrated with young generation to strengthen community bonding. The Ping Shek Estate revitalization project is not just about improving the building fabric, it is also about bringing vivacity to the estate and instilling a caring neighbourhood, which is only possible if the communal services are enriched to dovetail the improved living environment and meet the diversified needs of tenants of all ages.

Ping Shek Estate has a range of communal facilities: schools, kindergartens, new immigrant social services centres, a nursery, a neighborhood elderly centre and a popular youth centre operated. As the project was taken forward, we had enlisted the support of various government departments and non-government organizations in identifying further opportunities to provide **multi-faceted communal support services of Ping Shek Estate's tenants e.g. bring in mobile Chinese medical and care services etc.** content

5. PUTTING IDEAS INTO ACTION

It is recognized that the estate involves sitting tenants and many of Ping Shek **Estate's tenants have in fact grown up and grown old with the estate.** The revitalization project would be bringing changes to their living environment and how to put ideas into action was a real challenge.

A strong project team involving the Client (HKHA), **Housing Department's staff in the Estate Management, Building Works, Structural Engineering, Building Services Engineering Sections,** and consultant teams was formed to implement the project. Other stakeholders including the estates Estate Management Advisory Committee (EMAC) members, Focus Group members, Legislative Council members, District Council Members and some Non-government Organizations were all invited to participate actively throughout the project implementation.

Continuous communication and coordination among project team and various stakeholders through Partnering Workshops, monthly Project Coordination meeting, bi-weekly Consultants Meeting, bi-monthly EMAC meetings, quarterly Focus Group Meetings, ad-hoc meeting and even use of WhatsApp to resolve problems and keep all parties well-informed of the work progress so that everyone could make timely feedback and preparation. Special emphasis had been placed on planning the timing and phasing of works so as to minimize disturbance to local residents according to their living habits.

The overall project costs about HK\$280.85M and the estate was expected to sustain for more than another 15 years. Instead of total redevelopment, the revitalization scheme saved a vast amount of energy, material, cost and time that could be involved in the demolition and re-provision of a new estate. The facilities were successfully **upgraded to suit the aging population and maintain the residents' living quality, which could eliminate any resources required for relocation, saved society's resources and contributed to the continual of social sustainability.**

The project started in 2010 and completed in 2014. The project proved to be very successful. It was completed on time and within budget. Throughout the project, various stakeholders including residents, commercial tenants, Legislative Council members, District Council members and EMAC members gave very positive feedback on the management and to the new facilities and outlook of the estate.

The Study of Pavement Reconstruction Corresponding to Microclimate Cooling Efficiency in Elementary School Campus

KAO Kuo-sheng^a, LIN Hung-chun^b, LI Yen-yi^c, CHUNG Po-ren^d, LIN Chia-hsiung^e

^a Department of Computer and Communication, SHU-TE University, Taiwan, kks@stu.edu.tw

^b Grad. School of Architecture and Interior Design, SHU-TE University, Taiwan, nny97912000@gmail.com

^c Grad. School of Architecture and Interior Design, SHU-TE University, Taiwan, hamalee@stu.edu.tw

^d Graduate School of Architecture, National Cheng Kung University, Taiwan, benjamin6686@gmail.com

^e Department of Interior Design, SHU-TE University, Taiwan, azeman0819@gmail.com

ABSTRACT

In today's environment, the main reasons of "heat island effect" are causing by the architectural design techniques or design on the pavement. The imperfect building and the pavement in the environment will generate heat retention effect. Specific elementary school campus is chosen for integrated environmental assessment. The environmental improvement projects and the pavement design are taken into consideration at the stage of campus planning and design. These are all the factors affecting the campus microclimate. For the school with partial constructions, the renovation projects are categorized and the scientific method is adopted for collecting the data. The benefit assessment of the overall environmental factors can be used as decision-making for the future campus improvement. The goal of campus environmental quality and sustainable development will be achieved through these effective campus design techniques.

The impact of environmental benefit assessment is carried out by practical measurement and numerical analysis. Stationary and mobile meteorological stations have been taken to analysis surface heat flux distribution of the case. The campus transform will lead to quality increased of the environment and also affect the situation of indoor living comfort. According to the preliminary results, the effective items of reconstruction projects have great influence on campus temperature. The campus microclimate modes are discussed and integrated accordingly. The analytics results are built up with the understanding of variations between the reconstruction items and campus micro-environment. Eventually, the actions will be implemented to the following cases need to be improved and strengthened in a timely manner.

Keywords: micro-climate, pavement heat flux, campus reconstruction

1. RESEARCH BACKGROUND AND LITERATURE REVIEW

In addition to the provision of a design concept for future, educational and model teaching space, a sustainable campus responds to the concept of a thermal and wind environment on campus in terms of architecture environment change. Its level of **change is tied to the strength of the campus' temperature adjustment mechanism. Thus, this study aims to analyze the performance of the "pavement heat flux" for an integrated environmental evaluation that incorporates campus selection.** With the analysis of variance before and after the architecture change, this study further analyzes changes made to the urban campus environment responding to the requirement for sustainability.

According to the results of relevant studies that surveyed campus users about their perception regarding the **sustainable development of campus, "a healthy environment" is the first evaluation indicator set. This indicated that academic and research institutions believe the pursuit of "environmental sustainability" should be built on the basis of protecting "human health."**

The Ministry of Education of the Republic of China (2003) defined a "green campus" and "sustainable campus" as reflecting a school that is equipped with environmental awareness and implementation capabilities of rebuilding technologies for green buildings and ecological campus environment meeting the principles of sustainability, ecology, environmental protection and health. Chiang & Su (2004) explained two key factors required to realize the building of ideal, sustainable campuses as proposed below by the MOE:

“An ecological campus environment:” This refers to a campus focusing on ecology and co-existing with ecology to ensure biodiversity, an ecological and cultivation environment of native plants, clean indoors and outdoors environment, and the cycle of sustainable environment.

“Green building technology:” This concept focuses on the protection of a green environment incorporating the design of health-protecting buildings and the development of new energy sources. For example, the overall design shall emphasize ambient sound, lighting, heat, air, water and other composite issues to improve the features of structure and equipment.

During the promotion process, various studies discussed indoor environmental quality to address a sustainable campus and the vitalization and reutilization of campus space, but sustainability has always been ignored. Partial rebuilding, construction, and evaluation after construction of a sustainable campus can be defined and qualified. Thus, this study especially uses the selected campus environment to evaluate and analyze changes before and after rebuilding and the impact of construction in order to understand the campus environment improvement items, and the sources and variances of micro-environmental factors that exert impacts.

2. RESEARCH METHOD

2.1. The school sample

A school with a permeable pavement rebuilding project was initially inquired for a questionnaire survey to investigate coordination made before and after by the school. After the school agreed, actual measurement and analysis were carried out. The analytical results were then provided for the building of sustainable campuses in other schools. the logical development of work. Using headings is a great way to organise the paper and to increase its readability, so make sure to format them correctly.



Physical Environment						
Total Area of Campus	Area of Building Coverage	Building Coverage Ratio	Area of Green Land on Campus	Green Coverage Ratio	Area of Improved Permeable Pavement	
(m ²)	(m ²)	(%)	(m ²)	(%)	(m ²)	Increased Ratio (%)
17,233	16,569	96.1%	3,188	18.5	815	25.6
Before Rebuilding				After Rebuilding		
						

Table 1. Basic information on elementary school

2.2. Measurement intervals

Expected sampling values shall be derived during both day time and night time in order to analyze the variances of micro-climate at different times. Thus, the sampling of micro-climate environmental factors was set at 8:00-10:30 am, 12:00-14:30 pm, and 18:00-20:30 pm. At each interval, we finished collecting the sampling data within three

hours to reduce variances caused by time delay. As shown in previous studies on heat islands, the variance of development of a micro-climate shall be comprehensively evaluated. Basic climate variance of topography is caused by radiation flux and changes, especially when it is a clear cloudless day. In short, clear skies are good for the development of heat islands. As a result, this study conducted in situ measurements on clear-sky days.

2.3. Determination of measurement points

The area for actual measurement was the improved area for achieving a sustainable campus; in order to ascertain the distribution of comprehensive environmental factors, a checked coordinate system was used to divide the base into several arrays. According to the scale of area, a distance between 10-25 meters was set and the coordinate location was positioned with a GPS to ensure accuracy of measurement sites. During measurement, if an accurate point cannot be found, a new sampling point will be set within a distance of ten meters. Sampling points outside the distance are removed and recorded, as shown in Figure. 1.



Figure 1: Determination of measurement points

2.4. Measurement method

A mobile direct reading device is used for outdoor mobile monitoring. Sampling sites were selected at the center of road to avoid the shielding effect of buildings. When sampling, a sensor shall be kept at the distance 2 m higher from the ground and 50 cm above a human head to reduce the reflection impact of heat radiation. Measurements of in situ micro-climate factors were carried out by a group of two persons, as shown in Figure 2.

When measuring, climate conditions shall include low wind speed and less and lower clouds (measurements were stopped on rainy days). In order to understand the variance of high and low temperature in this area, measurements were carried out during both day time and night time. When measuring temperature, humidity, wind speed and wind direction, due to the use of a direct reading device, we needed to consider the issue of higher sensitivity. Records were not kept until readings on the device became stable; at the same time, photos of the skies and surrounding environment were also taken. While recording values, we conducted steps such as cross-examination and error corrections for conditions at that time, and sampling items to minimize error values. Environmental features at that time were recorded in detail for the acquisition of comprehensive data for the compiling and analysis of a micro-climate map, as shown in Diagram 3. A small weather watch station was installed on the roof of a campus building; the central point of the measurement area was designated as the sampling point for monitoring temperature, humidity, solar radiation and sunlight intensity. Please see Figure 3.



Figure 2: In-situ measurement photo



Figure 3: A small weather watch station

3. MEASUREMENT RESULTS

3.1. Measurement results of the campus

In the rebuilding of campus environment, the main influential items include landscape, educational meaning, and the thermal environment on campus. Environmental rebuilding levels are tied to the adjustment mechanism of **campus temperature control**. Consequently, this study integrates factors of “pavement heat flux” to present a comprehensive environmental evaluation of the selected campus. Additionally, with variance comparison before and after rebuilding, we analyzed environmental sustainability that responds to the urban campus environment changes. Through the use of a database on actual measurements, an analysis was conducted for deriving the initial values. A contour map was then compiled with a Surfer software algorithm for each physical and environmental factor. Background information plus overlay analysis of the environmental map show the distribution of environmental factors in the area to allow us to understand how “pavement heat flux” was distributed before and after campus rebuilding. Diagrams 5 to 16 present the tests and measurements of the campus environment.

Temperature Contour Map 08:00						
	Before Rebuilding			After Rebuilding		
Reduced Temperature Effect	Current	atmospheric temperature	Abs-ratio	Current	atmospheric temperature	Abs-ratio



0.8°C	29.1°C	31.2°C	1.007	28.3°C	31.3°C	1.010
Temperature Contour Map 13:00						
Reduced Temperature Effect	Before Rebuilding			After Rebuilding		
	Current	atmospheric temperature	Abs-ratio	Current	atmospheric temperature	Abs-ratio
-1.7°C	28.7°C	34.6°C	1.020	30.4°C	34°C	1.012
Temperature Contour Map 17:00						
Reduced Temperature Effect	Before Rebuilding			After Rebuilding		
	Current	atmospheric temperature	Abs-ratio	Current	atmospheric temperature	Abs-ratio
1°C	28.4°C	31.6°C	1.011	27.4°C	32°C	1.015

Table 2: Contour map of micro-climate in elementary school before and after rebuilding

3.2. Analysis of environmental factors

Analytical results of data collected from Pucian Elementary School: The square at the front gate and the hard court in the middle of campus buildings are found to have higher temperature in the morning due to the larger area of hard pavement with quick heat absorption. The building layout on campus also leads to the difficulty to achieve proper ventilation. The rebuilt area replaced some hard pavement surface with rocks, but the area was limited to the botanic garden, which features high temperature and humidity. The comparison of pavement rebuilding shows the temperature was decreased by 0.8°C.

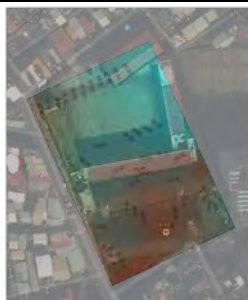
During noon time, the area at the center of the buildings has the highest temperature where wind from outside cannot reach. The rebuilt area and plants in the southeast side of the campus had low temperature and high humidity. The reduced temperature effect is poor. The monitoring comparison identifies the decrease of temperature by -1.7°C.

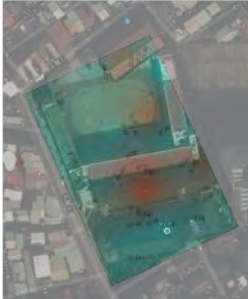
According to the night time temperature trend, the large area of the sports field directly receives sunlight, and the red soil on the top absorbs heat and then releases heat during the night time. So, the temperature of the sports field is higher. Heat dissipation causes reduced humidity of the hard pavement in the courtyard. The grassland at the rebuilt area is not impacted by the hard pavement, but due to the distribution of more plants in this area, humidity here is higher than in the other areas on campus. The average measured temperature is about 27°C with 1°C reduction.

4. **DISCUSSION AND SUGGESTION** This study incorporates the partial rebuilding program of sustainable campus promoted by the MOE. For partial rebuilding of campus environment of elementary schools, we selected a school that rebuilt its permeable pavement for a comprehensive environmental evaluation. Through tests and monitoring of regional micro-environments, we are able to understand the impact of sustainable campus building. We conducted the comprehensive analysis of pros and cons before and after rebuilding, and found a direct impact of the variance of partial improved construction on the thermal and wind campus environment. Through the initial value analysis of the actual measurement database, the effective contribution of permeable pavement for the temperature trend has been identified as the regional dissipation factor among campus buildings to effectively reduce the regional heat island **effect. Overall, an understanding of pavement heat flux” distribution can be facilitated. In the end, the analytical results can be provided for the reference of other partial campus rebuilding designs.**

The sampling time of this study for the impact and effectiveness evaluation before rebuilding was between October and early December; data after rebuilding were also collected during the spring (around March) for a comparison. When necessary, we will provide data collected in the summer time to make the study more comprehensive.

REFERENCES

- [1] Hsing-Hao Chen. 2007. **A Study on Assessment of Sustainable Campus's Physical Environment** for Elementary Schools in Taiwan.
- [2] Che-Ming Chiang, Hsing-Hao Chen, Chih-Chien Pan. **A Study on the Assessment Indicators for Physical Environment of Sustainable Campuses: The Case of Elementary Schools in Taiwan.**
- [3] Australian Government Department of the **Environment and Heritage. 2015. "Australian Sustainable Schools Initiative".** BOECKER, J. HORST, S. KEITER, T. LAU, A. SCHEFFER, M. TOEVS, B. REED, B. (2009) **The Integrative Design Guide to Green Building: redefining the practice of sustainability.** John Wiley & Sons Ed., 2009

Kai Tak Development – Migrating Towards Vision

YING Fun-fong^a, Sunny LO^b

^a Civil Engineering and Development Department, Government of the HKSAR, Hong Kong SAR, ffying@cedd.gov.hk

^b Civil Engineering and Development Department, Government of the HKSAR, Hong Kong SAR, sunnysplo@cedd.gov.hk

ABSTRACT

Kai Tak Development (KTD) is a major harbourfront development at the heart of Hong Kong adopting sustainable development and environmentally-friendly concepts. Its land use and development planning have gone through **extensive public engagement exercises leading to a blueprint for the vision being “A distinguished, vibrant, attractive and people-oriented community by Victoria Harbour”**. KTD is also the catalyst for re-energising the surrounding older districts and creating a new Central Business District for Hong Kong.

With the implementation timeframe spanning over a decade, KTD has already witnessed the completion of its first package of public works projects starting from 2013. These projects include bio-remediation at the Kai Tak Approach Channel and Kwun Tong Typhoon Shelter together with associated drainage works which have notably improved the water quality and mitigated the odour issues associated with the water bodies. Additional footbridges and revamp of existing pedestrian subways have enhanced the walking experience and connectivity between KTD and its neighbourhood. New buildings at KTD comprising the Trade and Industry Tower, Energizing Kowloon East Office building, schools and sewage pumping stations have met the Building Environmental Assessment Method Plus, or BEAM Plus, green building ratings. Kwun Tong Promenade and Runway Park Phase 1 at the former runway tip have become favourable rendezvous for the public to enjoy the waterfront. In addition, continual efforts are maintained with a view to promoting sustainable built environment through application of District Cooling System, development of extensive green web with signature open spaces, revitalisation of heritage discovery, and opening up harbourfront area for public enjoyment. This paper attempts to elucidate how KTD is planned and **implemented in the quest for sustainability being the impetus of Hong Kong’s economic growth**.

Keywords: Kai Tak development, public engagement, sustainability

1. INTRODUCTION

The transformation of Kai Tak from a former airport to Hong Kong’s single largest urban development of about 323 hectares has opened a new opportunity to showcase Hong Kong’s “World City” qualities. Under the planning vision for Kai Tak Development (KTD), Kai Tak is intended to be a “distinguished, vibrant, attractive and people-oriented community by the Victoria Harbour.” It also bears a strategic role in stimulating the regeneration of older districts in its vicinity. The location of Kai Tak is shown in Appendix A.

In recent years, increasing attention is being paid to enhancing the urban design aspects of strategic projects in Hong Kong. With its array of projects of different nature and its prominent harbourfront location, KTD has exceptional potential to be developed into a high-quality community. A holistic implementation approach has been adopted with emphasis on sustainability and quality urban design under a focused brand, instead of the conventional project-by-project approach driven primarily by functional considerations, to ensure that Hong Kong is further developed on a par with other competing cities around the world.

2. PLANNING WITH THE COMMUNITY

Kai Tak is located in southeast Kowloon with the former runway projecting over 2 kilometres (km) into the harbour. On 6 July 1998, the former Kai Tak Airport retired after **77-year of service as Hong Kong’s gateway to the world**. Being the largest available site at the harbourfront, Kai Tak offers a good opportunity to create a quality living environment in the urban area, and its interplay with the Victoria Harbour will cultivate a unique sense of place. Given its size and prominent location by the Victoria Harbour, the scope of redevelopment and planning intention for KTD had been the subject of a decade-long public deliberation.

To take heed of public aspirations to protect the Victoria Harbour as natural heritage of Hong Kong, the Government conducted an extensive public engagement exercise between 2004 and 2006. After three rounds of large-scale

public participation, general consensus was reached on the development scheme for KTD based on the principle of **“zero reclamation”**. **Details of the scheme were eventually** incorporated into the Kai Tak Outline Zoning Plan (OZP) approved under the statutory planning process in November 2007.

In terms of built development, KTD is intended under the approved OZP to provide about 2.9 million square metres (m²) and 2.3 million m² of domestic and non-domestic gross floor area respectively. It will accommodate an estimated total population of about 130,000 with population intake starting from 2013. The broad land uses under the approved Kai Tak OZP is summarised in Table 1 and shown in Appendix B.

Uses	Approximate Area and Percentage	
	Area (Hectares)	Percentage (%)
Commercial	14.00	4.33
Comprehensive Development Area	9.62	2.98
Residential	34.69	10.74
Government, Institution or Community	37.85	11.71
Open Space and Amenity Area	102.89	31.84
Other Specified Uses	54.21	16.77
Major Road etc.	69.94	21.63
Total Area	323.20	100.00

Table1: Schedule of land uses and areas

3. EVOLUTION AND SYNERGY WITH SURROUNDING DISTRICTS

Adjacent to Kai Tak are several built-up districts including Kowloon City, Wong Tai Sin and Kwun Tong within Kowloon East. All of them are mature urban development areas mainly for residential and industrial use with a wide range of community and recreational facilities. Following the economic restructuring in recent decades and **Government’s policy initiatives to hasten the redevelopment/conversion process, the Kowloon Bay and Kwun Tong areas within Kowloon East has been gradually transformed into a distinct office node with a critical mass of offices further to the traditional “Central Business District” in Central. Under the current strategic planning, the office clusters and government node in Kai Tak will create noticeable synergy with the office belt transformed from the former industrial areas in Kowloon Bay and Kwun Tong, and provide an excellent opportunity for their evolution into a modern and premier business district in Kowloon East.**

4. KEY URBAN DESIGN FEATURES

4.1. distinguished and attractive urban form

KTD is mainly surrounded by major trunk roads generating heavy traffic noise. In this regard, land uses with non-noise sensitive receivers, such as commercial and government, institution/community sites are located along the periphery of KTD, providing a shield to the inner residential sites. In principle, residential, office, retail and hotel developments are planned to mix with the sports and leisure activity nodes to ensure sustainable development and minimize cross-district traffic. **The “podium-free” design concept has been adopted to** enhance air ventilation, visual penetration and street level activities. Also, residential developments of suitable density are laid out in parcels with an average size of about 1 hectare each to create more intimately scaled urban street blocks.

4.2. A comprehensive green web

KTD seeks to improve the quality of living for the local population and cultivate a sense of belonging. Serving as a green web for sustainable development, KTD is characterized by a continuum of interconnected green spaces within KTD and its adjoining districts, and an extensive framework of tree and shrub planting. About 100 hectares of the land, which is about one third of the Kai Tak area, will be developed into green area and open space. This includes the 24-hectare Metro Park on former runway to become the prominent harbourfront park in Hong Kong. Other signature open spaces within KTD include the Station Square, Sung Wong Toi Park and Runway Park.

Moreover, KTD with about 11 km of continuous waterfront promenade will open up the harbour for public enjoyment. The scale of the promenade, occupying almost one-seventh of the waterfront of the Victoria Harbour, offers endless opportunities in the landscape design, with direct interface with the Kai Tak Cruise Terminal, Metro Park, Kai Tak Sport Park and a variety of other developments.

4.3. Connecting the neighbourhood

KTD is bounded by existing major road infrastructures such as the Prince Edward Road East and Kwun Tong Bypass. In addition, as a legacy of the former airport where security considerations took priority over pedestrian accessibility, there are limited connections with the surrounding districts. Through redevelopment of the former airport site, pedestrian circulations through an integrated network of open space, at-grade connections, footbridges and subways have been designed to maximize accessibility and mobility within KTD and further enhance connectivity with the surrounding districts and accessibility to the waterfront. A total of 25 numbers of new and enhanced connection points (Appendix C) will be provided between KTD and surrounding districts. For those existing pedestrian links subject to enhancement, thematic designs such as aviation history, street scene and etc., are adopted to highlight the culture and heritage of particular localities and to strengthen their function as welcoming entrances to KTD.

4.4. Preserving the heritage

KTD is dedicated to embracing not only its aviation history of being an ex-airport site but also the cultural and socio-economical significance of the neighbourhood districts in the development of Hong Kong. In this connection, the Kai Tak OZP was amended in 2012 to cater for the in-situ preservation of the remnants of Lung Tsun Stone Bridge (the Bridge) which was unearthed after the Kai Tak OZP had been formulated and approved in 2007. The historical significance of the Bridge remnants is attributable to its function as a pier for Qing Dynasty officials and garrison deployed at the Kowloon Walled City arriving on marine transport from 1875 until 1910s. Land parcels adjoining the preservation corridor were also rezoned to Comprehensive Development Areas for which the future developers would be mandated to submit master layout plans to demonstrate the relationship of their proposed developments with the preservation corridor.

Several signature open spaces (Appendix D) are also intended to preserve the unique “heritage” of Kai Tak as far as possible. With a nod to the aviation history of Hong Kong, part of the original Kai Tak Runway is retained and integrated into the planning of the parks. Substantial steel works with rustic finishes are used in the Kwun Tong Promenade to acknowledge the cargo handling area once established thereat. The drainage channel serving as a major flood relief path passing through the ex-airport site will be revamped to form the adorable Kai Tak River with extensive riverside hard and soft landscaping works. To date, the Kwun Tong Promenade and Runway Park Phase 1 have been completed and open for public enjoyment.

5. SUSTAINABLE INFRASTRUCTURES Environmentally friendly transport

The sustainable railway transport is planned as the backbone of public transport service for KTD (Appendix E). In this regard, the main developments in KTD are located in the former north apron area which will be served by the Shatin-to-Central Link (SCL) railway where two of its stations will be situated within Kai Tak. Subject to further study and consultation, an Environmentally Friendly Linkage System (EFLS) linking up the SCL stations and different areas/activity nodes of KTD is reserved in the OZP. As an essential component of the integrated multi-modal linkage system, the proposed EFLS would provide efficient intra-district connectivity services within Kowloon East, especially for those areas not served by the existing or planned MTR networks, and facilitate inter-district travelling through interchanges with the existing MTR Kwun Tong Line.

The section of the strategic Route 6 passing through KTD is planned in the form of depressed road or tunnel to significantly reduce noise, air and visual impact to the developments in the vicinity. In addition, local roads within KTD are all non-through roads (Appendix F) that can minimise the amount of through traffic and hence the traffic and environmental impacts.

5.2. Breeze through the grid

To promote natural ventilation in Kai Tak and to allow wind to penetrate the existing built-up areas in the hinterland, the new development area in KTD is laid out in a grid with breezeways (Appendix G) to capture the prevailing wind from the southeast. The development sites are divided in a manner to avoid wall effect. The space between the residential neighbourhoods will be mainly pedestrian streets with a width of 10 metres (m) to allow better air circulation and improve the townscape. Where necessary, set back of building lines from the site boundaries and building separation will be mandated to improve townscape and air circulation. These requirements are incorporated into the Kai Tak OZP for statutory control and under conditions of land lease and Government land allocations for mandatory enforcement.

5.3. High efficiency cooling

The District Cooling System (DCS) (Appendix H) is one of the major infrastructure facilities in support of the sustainable and environmentally-friendly development at Kai Tak. To promote energy efficiency and conservation, the Government is constructing a first-of-its-kind DCS in KTD to serve a planned total of about 1.73 million m² of non-domestic air-conditioned gross floor areas. The DCS is an energy-efficient air-conditioning system, consuming 35% and 20% less electricity as compared with traditional air-cooled air-conditioning systems and individual water-cooled air-conditioning systems using cooling towers respectively.

Implementation of the DCS in KTD will bring about significant environmental benefits. Due to better energy efficiency, the maximum annual saving in electricity consumption upon completion of the entire DCS project is estimated to be 85 million kilowatt-hour, with a corresponding reduction of 59 500 tonnes of carbon dioxide emission per annum. Apart from energy saving, as chiller plants and the associated electrical equipment will no longer be necessary, each individual user building subscribing to the district cooling services will gain further benefits such as reduction in total building cost by about 5-10%, more flexible building designs and a more adaptable air-conditioning system to the varying demand.

5.4. Sustainable waterways

Given the considerable length of a continuous harbourfront, Kai Tak should be a suitable location for the provision of water-land interface to facilitate waterborne activities within particularly the two adjoining water bodies, namely the Kai Tak Approach Channel (KTAC) and the Kwun Tong Typhoon Shelter (KTTS), embayed by the former runway and the adjoining breakwaters. Nevertheless, poor water circulation within these two water bodies and continuous inflow of polluted water for decades due to expedient connections had caused water pollution and contaminated sediments deposited at the seabed, resulting in odour nuisance and other environmental problems. Upon the implementation of KTD, a 3-pronged approach has been adopted to mitigate the environmental problems by means of rectifying the expedient connections in the hinterland, bioremediation treatment of the contaminated sediments, and creation of a 600 m opening at the former runway to enhance tidal flushing effect within KTAC and KTTS.

Bioremediation treatment (Appendix I) is a cost-effective engineering solution to tackle the contaminated sediments. Basically, dredging was limited to localized pollution hotspots, followed by injection of calcium nitrate solution as an oxidant into the seabed to accelerate degrading the odorous substances into mainly odourless and harmless gases, thus reducing the offensive smells and improving the water quality. As a result, the burden on the reception sites for disposal of dredged materials can be substantially reduced. Recent field monitoring results indicates that the water quality within KTAC and KTTS has been improving significantly since the completion of the rectification of expedient connections and bioremediation treatment. There is more to be done. In lieu of the originally proposal to create a 600 m opening at the former runway which would result in the generation of huge construction waste, a recent study on other possible sustainable alternatives has revealed that further interception of the inflow at the immediate upstream of KTAC and creation of mechanical flushing by means of pumping seawater from the KTAC into the harbour side of the runway could achieve similar environmental performance as the originally proposed 600 m opening. Further development and design of this alternative inception and pumping scheme are underway.

6. GREEN BUILDING DESIGN

In Hong Kong, more than half of the total annual energy use is in the form of electricity consumption, with buildings accounting for about 90% of the city's electricity use. Promoting green buildings and enhancing building energy saving are priority considerations of KTD. Employment of low carbon and sustainable design is a mandatory requirement in all government and private buildings projects in Kai Tak, which is required to achieve at least Gold ratings under the Hong Kong Building Environmental Assessment Method (BEAM) Plus.

6.1. Government, Institute and Community (G/IC) building projects

As the first completed government offices building in Kai Tak, the Trade and Industry (TI) Tower project located at former north apron is set for demonstration purpose. Emphasis of the project has been placed on greening and energy conservation. With the energy efficient features and renewable energy technologies adopted in the building, the total electricity consumption of the building is anticipated to be approximately 25% less than normal office building. Major sustainable features in the project include double glazing and sunshades, integrated photovoltaic panels and photovoltaic panel, solar hot water system, solar chimney system, daylight sun-tube, solar tracking optic fibre light pipe and anidolic light pipe, lift regenerative power, automatic refuse storage system, drip irrigation system, water saving sanitary devices, use of material with recycled contents as well as adaptive and modular **design for office area. In addition, the rectangular office tower is articulated with vertical greening. A "green ribbon"** is formed through a series of vertical terraces on the façade as it extends up to the office tower and the roof garden. By achieving credits in various sustainable aspects, the TI Tower has achieved provisional Platinum rating under BEAM Plus as well as Platinum level under LEED® accreditation.

The Kai Tak Cruise Terminal Building at the tip of former runway is an iconic, highly functional and efficient terminal. The 42-m wide span column-free layout of the terminal building allows for maximum flexibility in the utilization of space, which can be configured in various layouts during non-peak season, optimizing the usage of the building. Design of the Cruise Terminal Building adopts a sustainable construction approach incorporating a large number of precast components and post-tensioning structures that extend beyond low energy consumption to the overall long term sustainability performance of the building. The project has also achieved provisional Platinum rating under BEAM Plus. Appendix J shows the overview of the major green buildings mentioned above.

The temporary building structure accommodating the Energizing Kowloon East Office (EKEO) is also a champion of sustainability by using a raft of integrated green building technologies and features, lean construction methods and low embodied energy materials to become Hong Kong's first low carbon temporary office. It revitalises a piece of unattractive land on a site under the Kwun Tong Bypass. This innovative and green EKEO building is the first temporary office building which is given final Platinum rating under BEAM Plus.

Through building disposition to bring in natural lighting and enhance ventilation while reducing heat gain, adoption of various green features and energy saving measures, many other G/IC buildings include Kowloon City No. 1 and No. 2 Sewage Pumping Stations have accredited with the final Platinum rating, Kai Tak Fire Station and Kai Tak Nullah No. 1 and No. 2 Desilting Compounds with the provisional Platinum rating, and Po Leung Kuk Stanley Ho Sau Nan Primary School and S.K.H. Holy Cross Primary School with the provisional Gold rating under BEAM Plus.

6.2. Residential and commercial building projects

In 2015, new greening clauses were formulated for incorporation into land sale conditions to mandate the requirement for private residential and commercial building projects within Kai Tak to secure provisional Gold rating or above under BEAM Plus as well as to provide smart water meter systems, electric vehicle charging facilities and additional greenery. To take further steps in building Kai Tak into a more sustainable and liveable community, there are also mandatory requirements on provision of real-time parking information in commercial car parks at appropriate sites.

In 2016, "De Novo" was completed as the first residential building project within Kai Tak, with provisional Platinum rating granted under BEAM Plus for its sustainable building design. This project is also renowned for being a pilot Flat-for-Flat scheme introduced under the prevailing Urban Renewal Strategy as an alternative choice to compensate domestic owner-occupiers affected by the Urban Renewal Authority's redevelopment projects. It has been an exemplar demonstrating the application of green building design concepts in private development projects.

7. CONCLUSION

With its unique background and history as a well-known former international airport of Hong Kong, Kai Tak is in no doubt a huge, highly diversified and complex redevelopment project with various challenges. Built on its blueprint formulated by accommodating public aspirations through extensive community engagement programmes, KTD showcases the success in consensus building for a mega size development project. Given the holistic implementation approach, which has been supported by orchestrated development with measures focusing on environmentally friendly infrastructure, green buildings and heritage conservation, KTD is now on the move to realise its planning vision through shaping a distinguished, vibrant, attractive and people-oriented community by the Victoria Harbour.

8. APPENDIX

- A – Location Plan
- B – Kai Tak Outline Zoning Plan
- C – Pedestrian Connectivity with Hinterland
- D – Signature Open Spaces
- E – Transportation Network
- F – Road Network
- G – Breezeways at KTD
- H – District Cooling System (DCS)
- I – Bioremediation Treatment
- J – Green Government, Institute and Community Building Projects

Appendix A



Location Plan

Appendix B

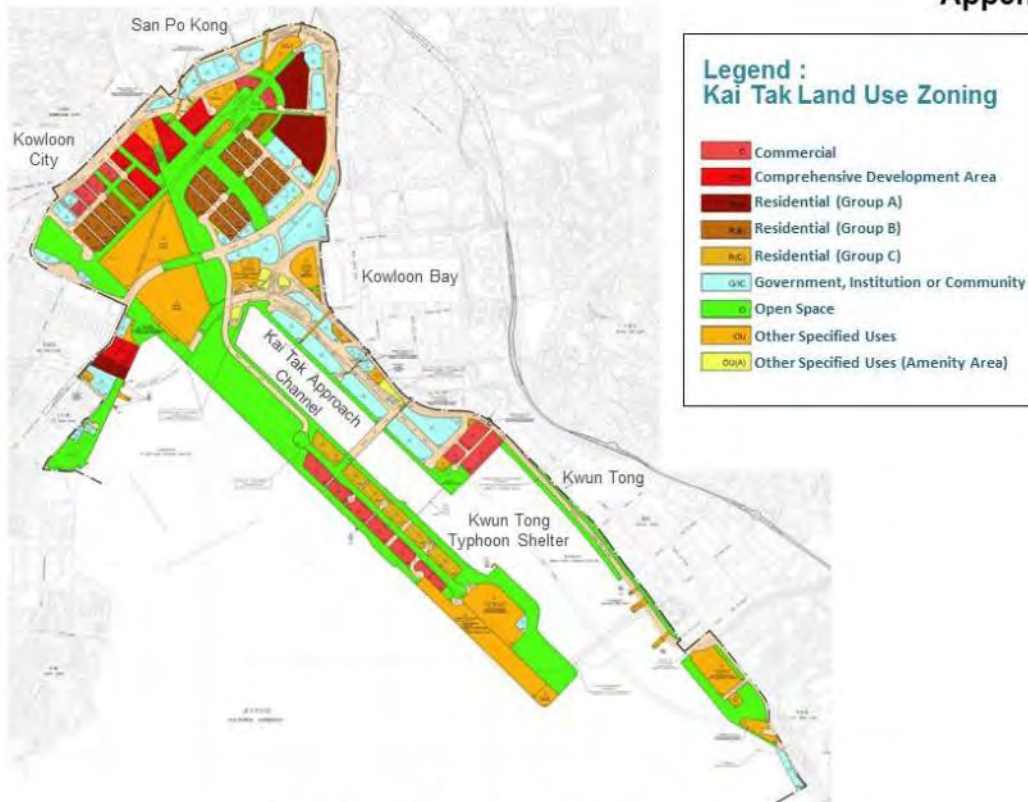

Kai Tak Outline Zoning Plan

Appendix C



Pedestrian Connectivity with Hinterland

Appendix D



Signature Open Spaces

Appendix E

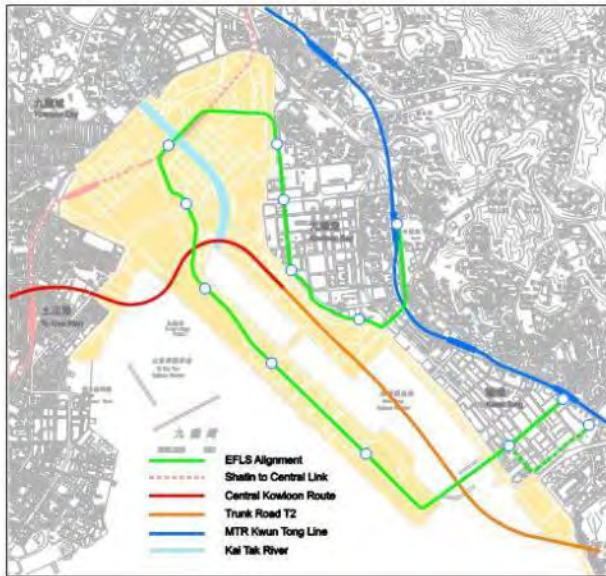

Transportation Network

Appendix F



Local Roads in Kai Tak

Appendix G



Capturing southeast prevailing winds

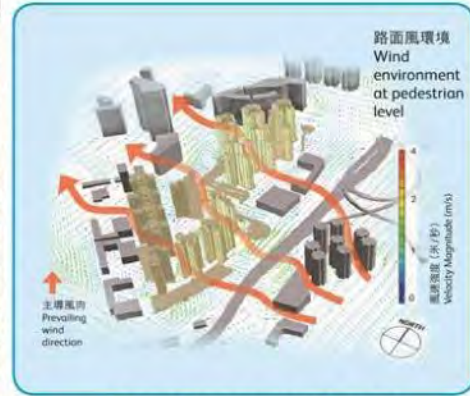

Managing micro-climate

Breezeway and Air Ventilation at Kai Tak

Appendix H



North Plant

District Cooling System

Appendix I



Before Treatment at KTAC



After Treatment at KTAC

Bioremediation Treatment

Appendix J



Kai Tak Cruise Terminal Building



Trade and Industry Tower



Energizing Kowloon East Office Building



Kowloon City No.1 and No.2 Sewage Pumping Stations

Green Government, Institute and Community Building Projects

Sustainable Interior Environments for Historic Buildings: A Case Study of the Presidential Palace of San Anton, Malta

Amber WISMAYER^a, Carolyn S. HAYLES^b, Nick MCCULLEN^c

^a University of Bath, United Kingdom, ambwism@gmail.com

^b INSPIRE @ UWTSO, Mount Pleasant Campus, United Kingdom, carolyn.hayles@uwtsd.ac.uk

^c University of Bath, United Kingdom, n.j.mccullen@bath.ac.uk

ABSTRACT

Historic buildings are notoriously difficult to adapt to suit contemporary requirements. Users retain modern expectations for functionality and comfort, whilst conservationists impose restrictions on adapting these buildings to suit these demands. Meanwhile, building professionals aspire to design sustainable interior environments for the occupants.

In this study, we assess the design of rooms in the Presidential Palace of San Anton in Malta, a historic building that currently serves diverse functions, including residential and administrative. This 17th century palace epitomises the climatic challenges for achieving functionality and comfort for occupants of heritage buildings in the Mediterranean and similar climates.

Although many of the rooms in the palace contain original fixtures and fittings, a significant proportion of its furnishings and window treatments are reproductions with no historic value. The latter could be substituted with aesthetically sympathetic solutions that would improve the functionality and comfort of these spaces.

In this paper, the results of a survey to establish how the internal layout of the rooms in the palace, their furnishings (furniture, appliances, and other movable articles including lighting and floor rugs), doors, windows and window treatments work for the occupants in their current design, is presented. Recommendations for improving the sustainability of these spaces are made.

Keywords: design process, energy saving, comfort and functionality

1. INTRODUCTION

It has been emphasised that public buildings should serve as role models in the shift towards eco-refurbishment, thus incentivising the market (Economidou et al., 2011). The Presidential Palace of San Anton would offer an excellent means of leading the eco-refurbishment of heritage buildings by example in Malta.

The primary residence and main office base of the President of Malta, San Anton Palace (SnAP) incorporates a variety of uses and an architectural configuration characteristic of palace heritage building typology. It was, therefore, selected as a case study for this research. The large-scale seventeenth century palace is a complex multi-functional building, catering to residential, administrative, office and service uses simultaneously. The diversity of this working palace must merge harmoniously with the need to maintain the highest standards of heritage protection. It therefore presents a challenging case study, albeit comparable in its characteristics and layout to other buildings classified within the same typology.

2. CONTEXT

2.1. Occupant comfort and behavior

Users' actions to improve internal comfort conditions account for a significant percentage of energy used in buildings (Yang et al., 2014). The drive to improve energy efficiency is, therefore, often paired with the objective of improving occupant comfort: unfortunately, green design does not necessarily equate to comfortable design. Paul and Taylor (2008) provided an indication of this through a study that examined the comfort and satisfaction perspectives of users of one green and two conventional buildings. Their research found no link between green design and comfort. This result was supported by a post-occupancy survey carried out by Hedge and Dorsey (2013), which identified issues regarding perceived health and performance in one of the two LEED Platinum

buildings studied. Whilst the building was energy efficient and sustainable, there were concerns regarding variability in air temperature, freshness, and quality.

There is clear merit in ensuring appropriate occupant comfort. The advantages include better user satisfaction and productivity (Wagner et al., 2007). It has also been shown that both greenness as well as comfort influence property value (Zhao et al., 2015). These factors result in financial spin-offs, which validate addressing energy efficiency and occupant comfort on an economic level alone. Moreover, a relationship has been recognised between user health and building parameters, including physical comfort conditions (McMullen, 2007). **The inherent characteristics of a building, therefore, translate into the occupants' perception of comfort by generating an indoor climate that directly impacts users. Another aspect comprises the occupants' initiative in taking action to increase their comfort levels.** Occupant behaviour plays a pivotal role in reducing building energy use (Ben and Steemers, 2014).

Research has highlighted the impact of occupant behaviours, such as interactions with lighting, apertures and appliances, on adaptability and energy use (Yan et al., 2015). Therefore, low energy consumption in buildings cannot be guaranteed through technology alone: rather, it should be supported by the appropriate interaction of occupants with the building (Hong et al., 2015).

2.2. Heritage building assessment

Heritage buildings present particular challenges that may be addressed in-part through retrofit decisions derived from socio-technical and behavioural data (Chiu et al., 2014). Addressing occupant behaviour holistically is crucial in developing successful eco-refurbishment strategies, since this provides the highest energy saving potential of all retrofit solutions in protected housing (Ben and Steemers, 2014). However, not only is there a dearth of information in the literature on occupant interactions with heritage buildings, but the impact of users is difficult to identify accurately for various reasons, including behavioural diversity (Yu et al., 2011).

Design variables relating to physical building parameters such as position and size of windows, surface treatments and building layout, have been flagged as having an effect on energy performance (Yasa et al., 2014). **These factors may be best identified through a comprehensive building survey. Users' perception of comfort, as well as their expectations and satisfaction, may be gauged through interviews with building occupants.** The retrofit of heritage buildings should, therefore, include detailed architectural assessment, as well as occupant consultation.

3. METHODOLOGY

3.1. Building survey

A detailed field investigation was conducted to obtain an understanding of the: Architectonic qualities of SnAP, and the vernacular techniques utilised in its planning and construction; as well as Factors that impact on the internal environment.

The architectural survey of the case study provided a record of all elements influencing its energy profile, both directly and indirectly, including: Internal height; Lighting strategies; Apertures; HVAC systems; Floor, walls and ceiling surface materials; Passive environmental design features, such as courtyards and loggias; Room orientation and use; and Basement levels. This data was collated for the entire palace, except for the private quarters.

3.2. Interviews with palace occupants

The scope of the survey was to investigate and establish occupants' perception of comfort, functionality, satisfaction and expectation in the context of the building's existing use framework. The information gathered from participants was critical in exploring the impact of occupancy behaviour on energy demand.

A pilot schedule was developed based on an awareness of appropriate practice and published data. The interview design introduced participants to relevant factors before they were asked to formulate a general perception of comfort and functionality. The survey comprised 4 sections with a total of 21 both closed and open-ended questions. **The first section provided a background of the respondent's roles and experience at SnAP, thereby contextualising**

the responses to subsequent questions. This included recollection of changes to the building. The next section assessed the following criteria for each room used by the respondent: frequency of use; tasks performed; actual **room use; frequency of occupants' movement; number of occupants; general perception of the occupant's comfort.** Section 3 provided detailed insight into the interior design in terms of room layout, furnishings, doors, windows and **fenestration systems. The final section explored the participants' general perception of comfort and functionality at SnAP.**

Once trialling of the pilot schedule was completed, a cross-section of the staff and residents at the palace were contacted to take part in the survey. All those invited agreed to participate, constituting a representative sample of the different user groups of SnAP. The respondents comprised approximately 30% of the population, and provided feedback on a varied range of rooms. Prior to conducting the interview, an introductory statement was provided to participants. The brief outlined the research and emphasised the **importance of the respondent's contribution.** It also defined terminology, ensuring a consistent understanding amongst participants. The interview was recorded and transcribed, thereby collating shared data into an effective and structured framework.

In order to contextualise the information compiled (particularly with regards to ratings) the air temperature, relative humidity (RH) and MET office readings were recorded on interview days in order to frame the comfort levels discussed by the respondents. MET office readings were taken from the Malta International Airport station, located approximately 6.7km away from SnAP. The air temperature and RH were measured using a portable data logger of accuracy +/- 0.1°C and ±3%, and resolution 0.1°C and 0.1%, respectively which took readings every 5 minutes.

4. RESULTS AND DISCUSSION Building survey

The internal height (i.e.: distance from finished floor level to the underside of the ceiling slab) has been found to have particular relevance when assessing natural ventilation and airflow (Li et al., 2013). As expected, most rooms were found to have high ceilings, characteristic of this building typology. Although this passive design technique was introduced to promote comfort levels, the large volumes created tend to make the rooms harder to heat or cool through artificial means, thereby exacerbating energy use.

A diverse mix of bulbs was identified, comprising a combination of tungsten filaments (70%), compact fluorescents (29%) and LEDs (less than 1%). Despite an on-going conversion to energy-saving bulbs, little effort has been made to address the lighting strategy. Consequently, poor lighting conditions have been flagged in a number of rooms. Notably, the lighting strategies in some of the office spaces have not been designed to meet the particular needs of the users: for example, light fittings are not placed such that desks are well-lit. The solution lies in the installation of a system that provides appropriate lighting levels at minimal energy demand, complemented by a layout that maximises natural lighting. It is recommended that the lighting layout should be designed with consideration of the furniture layout and the positioning of windows, and should incorporate energy-saving fittings/bulbs.

Apertures mainly comprised timber frames with single glazing, complemented by louvered shutters. This aesthetic is original to the building design, and must be retained in conformity with architectural heritage preservation legislation. Apertures generally do not feature large areas of glazing, and external louvered shutters provide shading as necessary. The traditional timber louvered shutters are in fact an important passive design mechanism that, if used appropriately and as intended, may improve internal climatic conditions considerably. On the other hand, the single glazing timber window type is rarely conducive to a well-sealed building envelope.

For the purposes of this survey, an HVAC system was defined as any system used to artificially heat or cool a room, including air-conditioning units, ceiling/floor fans and fireplaces. Most rooms in the palace feature air-conditioning units and/or ceiling/floor fans. The overwhelming majority of air-conditioning units were on when the rooms were assessed, even if the rooms were not occupied.

Flooring finishes range from original flagstones (39%) and marble tiles (8%), to parquet (5%) and fitted carpeting (19%). In order to mitigate over-heating, the latter two were not included in the original building design. They have, presumably, been installed for aesthetic purposes but are generally unsuitable for the local climate.

A number of passive environmental design features were identified through the architectural assessment of the case study. These included: Central courtyards; Loggias; Flat roofs having traditional structural configuration with

insulating properties; Thick double-skinned external masonry walls with rubble-filled cavity; Use of inherent building materials and finishes which promote natural cooling (such as flagstone flooring); Well-positioned windows and doors (both external and internal); Louvered apertures; and Surrounding indigenous trees and vegetation. The cumulative impact of these on energy efficiency has not been established to-date.

Room-uses (i.e.: predominant use of a room) were classified into predefined categories including: state room, office, multi-purpose (where use varies frequently, for instance from a guest room to an office), guest room (temporary residence), private quarters (permanent residential rooms including ancillary facilities), service room (including kitchen, pantry, locker room), security room, workshop, chapel, storage, garage, toilet, lift, passage and loggia. Secondary uses were identified through interviews with building occupants. The room-use survey proved crucial in developing an understanding of the mixed-use nature of SnAP, which directly impacts energy use and comfort concerns. It highlights the various groups of building occupants, as well as their distinct behavioural patterns and comfort requirements.

The building survey clearly demonstrates that the palace presents a highly complex environment for a number of reasons. Firstly, the multi-functional nature of SnAP demands that a variety of uses and users interface harmoniously. This is compounded by the secondary uses of a number of rooms. Moreover, an extensive diversity of room parameters has been identified. Finally, the building also features a number of passive design strategies, the impact of which has not yet been evaluated. These facets should be addressed in an integrated manner and at varying levels: A master plan of uses at a macro-scale should be consolidated with, for instance, a detailed lighting strategy at micro-scale.

4.2. Interviews with palace occupants

Although participants could recall only recent changes, and more specifically changes affecting them directly, the great majority had an awareness of changes to the structure and/or layout of SnAP. This clearly indicates a high level of activity in this context. The foremost modifications mentioned included room restoration or redecoration, and shifts in room use, predominately related to office space. The fragmented redistribution recalled by participants implies that a holistic room-use strategy at SnAP is lacking.

It was established that a number of rooms are multi-functional in nature, having both a primary and secondary use. Moreover, it was found that higher-ranking management personnel tend to move around the palace quite frequently, utilising several rooms for meetings and events. The lack of designated meeting spaces was emphasised as a concern.

An analysis of the use criteria highlighted shared offices as having a high number of users and footfall levels. Most office users spent 8 hours or more in the rooms per day. This suggests that these spaces greatly merit a strategy for an interior design layout promoting comfort and functionality for occupants.

A number of issues relating to poor comfort levels were identified: in particular, a lack of natural light and ventilation, and uncomfortable levels of temperature and humidity were reported. The results clearly indicate that in order to improve comfort, occupants resorted to routinely using artificial lighting and air-conditioning, and also endeavoured to open doors and windows for ventilation whenever possible. These findings correlate well with the literature study, which identified a strong link between occupant comfort and behaviour, and energy use.

The majority of respondents felt that the room layout was not appropriate to function (64%) and nor did it maximise comfort (75%). Results indicate that the rooms cannot suitably meet the demands imposed, both in terms of number of users, as well as technological requirements. Participants were not satisfied (68%) with the furnishings of the rooms citing, amongst others, poor lighting (both natural and artificial) and insufficient storage space. Although most occupants did move furnishings (82%) in order to improve functionality, there was concern regarding the possibility of damaging items of value, both heritage and financial. Moreover, it was found that 47% of users preferred to move themselves to another space to improve comfort, rather than move the furnishings. This was generally related to improving light, ventilation, temperature and acoustic conditions in order to temporarily alleviate discomfort, and is a clear indication that the room layout is not appropriate to its use.

Windows have been rated as the preferred adaptive interactivity (Barlow and Fiala, 2007). Despite the express wish of users to do so, in a number of cases, it was not easy, practical or possible to open/close windows, shutters

and curtains. Reasons for this included the physical attributes, security or privacy, and the juxtaposition of conflicting uses. It may be argued that opening windows when the outside temperature is greater than that inside may negatively affect the comfort levels of the internal environment. However, the inability to use apertures excludes the possibility of night purging, and of allowing natural ventilation as necessary.

This restriction has induced occupants to resort to alternative means of ameliorating the internal environment, as evidenced by the high dependence on the use of air-conditioners. Rather than taking action to discourage this practice, there is a concerted move towards installing new units, and replacing ceiling fans.

Approximately 53% of participants open windows and doors for ventilation, and of these the majority (67%) also resorted to HVACs for cooling. The reasons given for not opening apertures were generally due to factors beyond **the participant's control (pollution, impractical, privacy, security, no windows)**. **Where possible, occupants always** opened or closed shutter/blinds/curtains for comfort (86%) and functionality (93%). However, it was found that artificial light was also being used extensively. Good quality lighting is pertinent to providing a comfortable environment for occupants. It is, therefore, critical that the lighting strategies are custom-designed to address the unique conditions of each room use and layout.

The overarching perception of comfort at SnAP was negative. Participants clearly felt that the palace did not effectively meet the functional demands emanating from the present uses. Satisfactory light and temperature levels were the major cause for concern. This is acutely aggravated by frequent and piecemeal changes at the palace. **Despite the appreciation for the building's heritage value, users generally felt awkward about the presence of** valuable artefacts and furniture in the space they occupy.

5. CONCLUSION

Energy use in buildings is not solely a technical issue but, rather, one with a social dimension, and feedback from occupants regarding behaviour and comfort is a vital building block in green retrofits. In designing a strategy for improving building performance, it is important to establish the expectations and requirements of users, as well as their perceptions of, and interactions, with the existing building layout and fabric. The approach taken is, therefore, well validated by the wider literature.

Preliminary observations indicate that steps could be taken to naturally improve indoor comfort levels, and facilitate energy-conscious behaviours. Appositely, frequent and fragmented changes are being executed in an effort to better accommodate existing and new uses. It is therefore being recommended that any sustainable strategy should incorporate a Change Control Mechanism underlined by a Standard Operating Procedure, which flags specific indicators to be addressed.

The methodology adopted throughout this study aimed at being as inclusive as possible, thus imparting three major benefits. Firstly, it was designed to engage occupants in the eco-refurbishment process at an early stage, such that they feel empowered and cooperate in bringing about positive change. Secondly, it motivated them to respond correctly during the interviews. Thirdly, a positive climate, supporting future behavioural change, is created as part of this process.

The results of the interviews strongly highlight a negative user perception of comfort and functionality of this particular heritage building interior, and the resultant behaviour of occupants aims at improving their environment. Simple measures designed by our predecessors to provide a comfortable indoor environment are no longer used, and have been replaced with an ever-growing dependence on active mechanisms. This highlights the importance of re-visiting the passive design features inherent to the original building design, and developing a strategy for maximising their potential through a sustainable building interior.

REFERENCES

- [1] Barlow, S. and Fiala, D., 2007. Occupant comfort in UK offices: How adaptive comfort theories might influence future low energy office refurbishment strategies. *Energy and Buildings*, 39, 837-846. Insert your references here.
- [2] Ben, H. and Steemers, K., 2014. Energy retrofit and occupant behaviour in protected housing: A case study of the Brunswick Centre in London. *Energy and Buildings*, 80, 120-130.
- [3] Chiu, L. F., Lowe, R., Raslan, R., Altamirano-Medina, H. and Wingfield, J., 2014. A socio-technical approach to post-occupancy evaluation: Interactive adaptability in domestic retrofit. *Building Research & Information*, 42, 574-590.
- [4] Economidou, M., Atanasiu, B., Despret C., Maoi, J., Nolte, I. and Rapf, O., 2011. **Europe's buildings under the microscope: A country by country review of the energy performance of buildings.** Buildings Performance Institute Europe.
- [5] Hedge, A. and Dorsey J. A., 2013. Green buildings need good ergonomics. *Ergonomics*, 56, 492-506.
- [6] Hong T., D'Oca, S., Turner, W. J. N. and Taylor-Lange, S. C., 2015. An ontology to represent energy-related occupant behaviour in buildings. Part I: Introduction to the DNAs framework. *Building and Environment*, 92, 764-777.
- [7] Li, Q., You, R., Chen, C. and Yang, X., 2013. A field investigation and comparative study of indoor environmental quality in heritage Chinese rural buildings with thick rammed earth wall. *Energy and Buildings*, 62, 286-293.
- [8] McMullen, R. 2007. *Environmental Science in Building.* Palgrave Macmillan, Basingstoke.
- [9] Paul, W. L. and Taylor, P. A., 2008. A comparison of occupant comfort and satisfaction between a green building and a conventional building. *Building and Environment*, 43, 1858-1870.
- [10] Wagner, A., Gossauer, E., Moosmann, C., Gropp, T. & Leonhart, R., 2007. Thermal comfort and workplace occupant satisfaction: Results of field studies in German low energy office buildings. *Energy and Buildings*, 39, 758-769.
- [11] **Yan, D., O'Brien, W., Hong, T., Feng, X., Burak Gunay, H., Tahmasebi, F. and Mahdavi, A., 2015.** Occupant behaviour modelling for building performance simulation: Current state and future challenges. *Energy and Buildings*, 107, 264-278.
- [12] Yang, L., Yan, J. & Lam, J. C., 2014. Thermal comfort and building energy consumption implications – A review. *Applied Energy*, 115, 164-173.
- [13] Yasa, E., Fidan, G. and Tosun, M., 2014. Analysis of historic buildings in terms of their microclimate and thermal comfort performances: Example of Konya slender minaret madrash. *Journal of Architectural Engineering Technology*, 3.
- [14] Yu, Z., Fung, B. C. M., Haghghat, F., Yoshino, H. and Morofsky, E., 2011. A systematic procedure to study the influence of occupant behaviour on building energy consumption. *Energy and Buildings*, 43, 1409-1417.
- [15] Zhao, D.X., He, B.J., Johnson, C. and Mou, B., 2015. Social problems of green buildings: From the humanistic needs to social acceptance. *Renewable and Sustainable Energy Reviews*, 51, 1594-16

Café des Visions: How to Anticipate and Consolidate Urban Negotiation through Art; a Practice-based Artistic Research

Anna GRABER^a

^a *Café des Visions, Switzerland, annagraber@swissonline.ch*

ABSTRACT

The Art in Public Spheres project *Café des Visions* establishes forums at unconventional locations in the public sphere to test new ways of discussing and working out together how public spaces shall be designed and used.

The goal is to link ideas and spaces by gathering implicit knowledge from people on the street by using their everyday experience in public spaces as expertise and to make this knowledge artistically visible in a way that allows it to be put at the disposal of creators and users of public spaces while at the same time challenging and blurring their traditional roles. Or with the words of the French sociologist Henry Lefebvre: 'City consumers shall become city producers.'

The artistic intervention *Café des Visions* serves as a nomadic research station transforming urban non-places into mobile village squares. Wishes for the restructuring of a specific public space are gathered there by interviewing guests at the café. The guests are invited to draw their wishes on the ground with white water-soluble paint. This gesture of inscribing the site with requests directly connects idea and space.

Café des Visions treats the constructed and the lived cities as if they were white spots on maps of ancient explorers. Data is gathered from drawings and logbooks, by semi-structured interviews and photographic investigation as well as by documenting the collected wishes. After the Café's intervention, the data is qualitatively analysed. The results are drawn typographically and published as city mappings on which wishes superimpose the grid of houses and streets.

The outcomes show everyday knowledge closely linked to the actual discourse in urban sociology or public space/public life studies. The artistic intervention provides knowledge created by open thinking, which is the starting point of any creative process and can serve as a first step in city development processes.

Keywords: sustainable neighbourhood, participatory city planning, urban negotiation, art contribution

1. INTRODUCTION

Public spheres reflect the value systems of an urban society. Anyone observing an urban space is confronted with a built environment and with people who move in it. The architecture of the buildings, the design of the street furniture, the available free space, the design of green areas as well as dealing with mobility determine who is welcome to stay, how everyone moves and how everyone treats each other. It shows how much weight an individual voice is given in the ongoing process of the negotiation of needs. Today as well as in the future, the greatest challenge to urban societies is to integrate interests and needs of different players and to tackle the related negotiation process so that social resources are freed and existential problems can be addressed.

In German-speaking countries the structural substance of the city centres and the organisation of the space date from the Middle Ages. The city foundations at that time were based on two premises: first, the freedom of the market and, secondly, a democratic society, which formed an antithesis to the feudally organised country. Cities were thus from the outset places of trade. The behaviour of people in public spaces is therefore the behaviour of customers in the marketplace. In contrast to this, public spheres served to shape public opinion in order to counterbalance the government's decisions. Coffee houses in the 18th century were meeting points where news circulated and where the social class of citizens discussed and became a political class. These bourgeois public spheres disappeared as the incremental coalition of business and politics took over public spheres. The public and the private mingled in favour of a permanent relationship of bargain and sale. The political stratum of citizens becomes reduced to a class of customers. The market overgrows democracy. This fact manifests itself in the design of public spaces as well. They are reduced to transit zones that connect places of consumption.

Modern architecture has solved the hygienic problems of medieval towns and restructured the space. This development culminated in the Fordist separation of living and working. Individual traffic was needed to overcome the distances between industrial and residential areas. The streets were widened and pedestrians confined to narrow channels between monotonous, oversized facades and overwhelming traffic. Public places are designed multifunctionally: they are asphalted, greened and sparsely furnished with a few benches positioned in a way that individuals or couples can sit side by side to enjoy the view. This setting inhibits communication. On the whole, these sites are not perceived as alive and are therefore avoided. Spontaneous contact does not occur.

2. RESEARCH TOPIC AND GOALS

From these discussions the following research question results:

What kind of city life should be designed to trigger a civic and sustainable development? How can art contribute to urban negotiation?

Three hypotheses lead to the research approach:

- People on the street own an expertise for the use of public spaces that consists of their everyday experience. This knowledge is often implicit.
- The implicit knowledge about public spaces is a source for the negotiation process within urban planning as well as for creating new forms of using public space.
- Collecting the implicit knowledge and making it artistically visible allows it to be put at the disposal of creators and users of public spaces to discuss, challenge and blur their traditional roles.

The goal is to build bridges between bottom-up and top-down planning to find resources and innovation potential for designing, building and living cities.

3. METHODOLOGY

The research is structured into two steps. The first one is planned around the question how the perception and the concept of public spheres can be changed by the means of art. Three types of experiments will be conducted:

- Collecting wishes: People on the street are asked about their wishes for a specific public place in order to tap into their implicit knowledge; their wishes are collected, discussed and artistically transformed into city mappings.
- Interventions in public spaces; they help develop and test new ways of interaction and cultural life.
- A cultural translation of transit zones will produce public spaces portraits.

The second step will trigger new ways of collaboration for designing public spheres. The experiment will consist of creating transdisciplinary forums to work out a charter of the values of public spaces and to initiate projects where unconventional collaborations are tested to build bridges between top-down planning and bottom-up projects.

This paper focuses on the first step and will describe an intervention and a collection of wishes with the art in public spheres project Café des Visions in the city of Zug, Switzerland, and Vienna, Austria.

3.1 Café des Visions: an artistic intervention as research station

As a mobile village square, Café des Visions moves from place to place by means of a bike trailer and questions its respective locations about their potential as social spaces. Designed as a coffee lounge, the Café invites passers-by to relax, at the same time serving as a forum where ideas can be developed and discussed.

What's your wish for this place in particular?

How should it be designed?

What should take place here?

What do you think would this place need to make it different from others, so that you would like to spend time here?

Café des Visions is also a city studio and a city laboratory, a place where wishes and visions take shape. The media and materials required for this process are available at the bar. At the Café, guests are invited to express their wishes and/or sketch them out. Wishes, desires, requests and visions are produced and collected by painting them on the ground with white water-soluble paint, transforming the place into a participatory installation, the spatial tattoo. This gesture of inscribing the site with requests directly connects idea and space and makes this relation artistically visible. On the project website www.cafe-des-visions.ch, the ideas are collected virtually and can be discussed and further developed.

The Café is made out of stackable lounge chairs and tables, which fit into a bicycle trailer that serves as a bar. Café des Visions travels from one place that has potential for change to the next that seems to need transformation. When set up, it occupies real space and simultaneously, by means of collecting visions, constitutes an ideal space. In this way, it takes the question of how space should be designed and used to where people actually are and where changes are taking place.

Café des Visions treats the constructed and the lived cities as if they were white spots on maps of ancient **developers. Information is gathered by observing, collecting and drawing. After the Café's intervention on each particular site, the data is qualitatively and quantitatively analysed. The results are published as a map of the city, typographically designed with the collected information being placed exactly where it was gathered in the grid of the city, thus mapping the neighbourhoods and the wishes located in them.**

3.2 Combining idea and space

Café des Visions is focusing on two different types of public spaces:

- Neuralgic points: neuralgic points are places of transit people pass by unconsciously in the centre of a city, accepting them to be either vast or hostile, traversing them as quickly as possible although the geographical location and the design of these spaces indicate that – in early days or in the concept of the public architecture – they were meant to be a place where people rest or meet.
- Urban wastelands: urban wastelands are open spaces between two areal utilisations, for example the Stadionbrache Hardturm in Zurich, which are made publicly accessible but were not constructed as such or have no infrastructure to invite people to stay or initiate activities.

Both kinds of spaces are chosen by the methods of observation, photographic investigation, interviews with interested parties and reading literature on the history of the specific place. *Café des Visions* understands its respective location as a constructed and social space that is constantly changing because of the presence of people at a specific time. It asks the visitors about their personal view of the place, their emotional ties to it and their knowledge of its history, which it puts in relationship to the already established known history of the place. People are considered to be experts on the spaces they pass every day. The collected knowledge is an everyday knowledge, the collected social potential shows innovation that is rooted in everyday life – a portrait-collage of the 'genius loci'.

3.3 Artistic methods

Within the different phases of the project, Café des Visions works with various methods borrowed from ethnography and urban sociology that have been adapted to the artistic process. These strategies form a framework allowing the Café des Visions to reach people in a holistic way.

The unexpected presence of the participatory installation invites passers-by to come closer and take a seat. The seats were developed with sculptural techniques and the installation serves the objectives of city-sculpturing and space-tattooing. In this way, it speaks to people in a language that goes beyond the verbal.

Appropriation and production of space by Henry Lefebvre

The French professor of sociology (1901–1991) **postulated a 'differential space' 4 as an objective for dissident urban development, which means that an urban situation is based on the coexistence of differences that have a potential for productive exchange. Appropriation and production of space are strategies to transform the 'abstract space' of profit orientation into a differential space. The mobile elements of the Café des Visions allow a quick**

appropriation of public spaces. Every visitor helps to expand the appropriation and produces a temporary social space. Appropriation and production of space are also used to create an atmosphere that facilitates passers-by and citizens to get into a dialogue to collect information.

Collecting information: Information is gathered by observing, interviewing, drawing sketches and collecting oddities and finds in a metaphorical botanic specimen container: photographic investigation, documentation of the actions in the Café and of the collection of wishes, sketches, diary/logbook. Research in archives and precise description.

Observing: participant observation, a data collection method for qualitative research (ethnology), applied to the process of choosing a space as well as to being on tour with the Café des Visions.

Interviewing: semi-structured interviews (based on Flicks's concept of qualitative social research 5 applied to choosing a space as well as to being on tour with the Café des Visions.

Counting, classifying, evaluating: The collected wishes are discussed and arranged from different points of view, which results in texts and graphics (methods borrowed from 'Public Space/Public Life Studies', Jan Gehl, Birgit Svarre 6.

Mapping: the painted wishes are typographically assembled on a map of the city and laid exactly onto the edificial structures of the respective urban district. The mapping is inspired by the psychogeography of Guy Debord 7.

3.4 Framework for the experiment

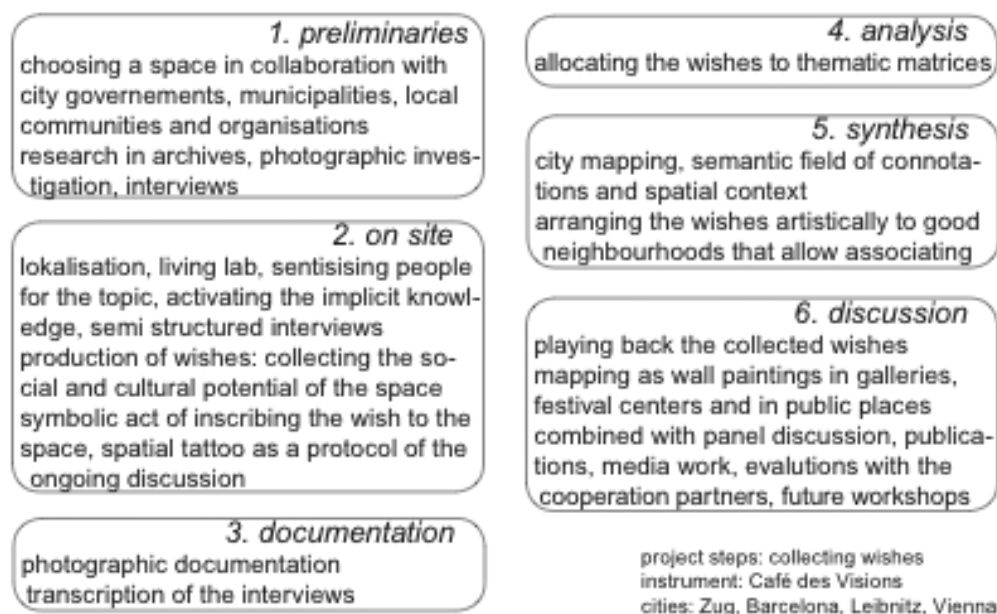

Figure 1

4. OUTPUTS AND OUTCOMES

Since 2012, *Café des Visions* has been travelling to various cities in Europe. Two examples may show the variety of the discussions resulting from these trips. The first one is from a roundtrip to twelve locations in the city of Zug, Switzerland. The conceptual design of the greater area mapping was made in collaboration with the city development department and with the department for culture. The results were published on a forum within public space, on a panel discussion and as publication.

Surrounded by mountains, Zug is a picturesque city at the lakeside. The city centre dates back to the Middle Ages and is surrounded by modern architectural ensembles. Selected pieces of dialogue show the quality of the statements made by passers-by.

The second example is from the Seestadt Aspern in Vienna, Austria, a smart city, which is going to be constructed within the next twenty years as one of the most ambitious projects of actual city planning in Europe. Here, the debate about the site was established by the act of painting the wishes voiced by passers-by onto the ground. The intervention was planned with the committee of the festival urbanize! and with the district management at Seestadt Aspern. The results were shown as a wall painting at the festival centre combined with a panel discussion and played back via the district management to the participating people at Seestadt Aspern.

4.1 Dialogues and a spontaneous forum in the city of Zug

On 21 June 2014, *Café des Visions* was a guest in the urban district of Herti, situated at the eastern city boundary. **Compared to Zug's rich villa districts, this neighbourhood is multinational and its inhabitants belong to the lower middle class.** The *Café* was set up in the backyard of a shopping centre built in the seventies; there is a fountain with artwork, benches and trees, and the square is flanked by a fast-food restaurant, a parish, a home for the aged and the entrance to the shopping centre.

A passer-by who is already a grandfather reported how the former 'Allmend' (a common green space) was rezoned for urbanisation on the condition that a social mix should be ensured in the resulting settlements by constructing subsidized housing, cooperatives and condominiums. He spoke of the vision of that former generation and expressed his wish that the place become a village square where strangers could mix with locals. Later on, a passer-by read this wish on the ground and said: 'This idea with the stranger is not working, they meet here smoking hashish.'

'They planned everything correctly. There are trees, water and seating. And yet the place does not live', analysed an architect doing his weekend shopping. Finally, she wished for boxes of wild roses by the walls of the parish centre.

A group of children suggested a waterslide from the church roof to the fountain, a water fight once a week, a football field with goals, in short, space for activity and motion. Later, the children began to drum on the lounge chairs and evoked the desire for a music garden, a sound game area with logs for instruments and people spontaneously playing music together.

A former landlady wanted room to talk, talk, talk. An artist suggested pimping the bare walls. Others wanted a party on the weekend, more people, more seating, more shade or a finer surface for wheelchairs.

'Zug has other problems: overpriced homes', said a man waiting in the café lounge for his wife to bring his dinner, 'nobody cares about the design of public spaces. Certainly not the politicians.' This statement made two adjacent groups arrange their chairs in a circle and discuss till dark what issues were pending in Zug, among the participants: Zug's city developer Regula Kaiser.

The contexts indicated in these talks can also be found in the discourse of urban sociology, psychology and philosophy.

The idea of the music garden was created by open thinking. After Mihaly Csíkszentmihályi, fluid thinking is at the beginning of each creative process – in everyday life just as much as in the 'great creativity' he examined and which leads to relevant inventions in all scientific fields.

The encounter with the unknown is one of the topics of urban sociology. 'The urban city is a place where different lifestyles, beliefs and cultures can co-exist and at the same time occur in a productive dialogue with each other', writes Walter Siebel. Thus, the confrontation with the stranger is important for Siebel. Through his differentness, the foreigner questions cultural certainties. Even if city residents do not approve of his otherness or feel even repelled by it, they develop a resigned tolerance towards it since they are constantly confronted with it. In cities that represent interfaces of different cultures, Csíkszentmihályi found a great innovation potential.



Figure 2: Café des Visions, collecting wishes at Zug 2014, photo Anna Graber

Finally, the little spontaneous Forum has roots in the Greek agora as a place of debate where no one was allowed to be brought to justice for a divergent opinion. The philosopher and sociologist Jürgen Habermas described as early as in 1962 the disappearance of the bourgeois public sphere in the sense of a democratic critical counterweight to government and economy.

For the place at Herti 42 wishes were made. They can be classified into the following categories: architecture, design and infrastructure 12, socio-environment 14, nature 8 and culture 8.

For each place, the Café des Visions is stationed, two types of recommendations are deduced:

- wishes that initiate a change from a non-place to a place: shadow, more benches, movable seating that allows eye contact during a conversation, a well as meeting point like in an ancient village, a pitch or anything that triggers physic activity,
- wishes that show the special potential of a place: roses in troughs made of wood hanging on the scraggy concrete walls from the parish would give atmosphere to the place or art, that pimps up the concrete walls. More people at the weekend were wished and also to let the young generation more organize their own projects as a possible solution. A music garden would make the place unique. People could meet by playing music, jamming, experimenting or listening.

In the end of the café's journey the city-mapping is drawn. It is meant to show a vision for possible development, not in the sense of a list of assessment criteria but in the sense of a mapped potential, where wished are positioned **"in good neighbourhood" to allow an associative reading of the city and to find new possibilities for combinations** with every reading. (c.f. annex)

Zug has a tradition of reflecting and debating the issues of city development. People easily joined the discussion with verbal statements. The painting served as a summary of their discussions for the next people to come. On the whole journey 383 wishes have been collected. They can be classified into the following categories: architecture, design and infrastructure 122, socio-environment 118, nature 79 and culture 64. The design of the public spaces cannot match to the level of the discussions.

4.2 A spatial tattoo as ongoing dialogue at the Seestadt Aspern, Vienna

What do people who live in a city that is still being built wish for? In Vienna, a smart city that will eventually house 20,000 inhabitants is being constructed over the next twenty years. The best planners, like Johannes Thovat, who made the masterplan, or Gehl Architects, who designed the concept for the public spaces, are involved to create a completely sustainable city. By now, 6400 people live in the quarter already finished. The city will grow around it in the form of a spiral.

In October 2015, Café des Visions spent four days on the Hannah Arendt Platz, a public square planned to become central to the whole city once it will be finished. It is situated between the main square and the school and is divided into different zones: a smooth green hill that constitutes an area for playing and relaxing, an open plaza with some trees and benches meant to become a multifunctional zone e. g. for markets, and a third zone furnished with long tables and benches.

Asked about his wishes for the new Hannah Arendt Platz, a man answered: **'What should I wish for, we have everything here.'** The dialog on the space started by children and as the adults joined in pointed out fundamental questions of marketing monopoly, of how city life can grow in a place without a history, of the responsibility of architects. People wish for a city life as they know it from their previous place of residence. The zone for appropriation that is part of the concept of the public space is not yet understood by the residents and is seen as sandy spots that should be greened.

At the Seestadt Aspern, people were attracted by the installation of the Café des Visions and came looking for something to happen in the vacant space. The act of painting wishes onto the ground initiated individual processes of reflecting the perception of public spheres. The spatial tattoo reflected a first discussion on the relation between individuals or groups and the development of the space. It emerged step by step with every painted wish. In this way, the mapping is like a record of this collective process and shows the specific conditions of these city pioneers. In total, 187 wishes were made. They can be classified into the following categories: architecture, design and infrastructure 81, nature 45, socio-environment 36 and culture 25.

Architecture, design and infrastructure: a noticeably great number of persons, 23, wished for more shops, stalls with take-away food and vegetable markets. They mentioned the monopoly held by one multiple shop, which is also one of the investors for the first ten years, and a fringe area of ten kilometres which prevents even a kiosk at the lakeside. They also want to have small cafés and bars, i. e. a Café Cardamom or a student bar that would bring young people to the Seestadt.

A bigger group of wishes challenged and questioned the architecture: that human dimensions should be respected, which means constructing no higher than a tree, they asked for more innovation in architecture, individually designed houses instead of copy-paste architecture, the construction of cities by respecting the needs of all **demographic groups, for 'closing the door to keep out the wind' (not increasing the wind's speed by constructing small channels between high rises)**, for an evaluation of the buildings after a period of five years involving the inhabitants. 17 wishes concerned playgrounds and sports, 15 wishes were about safety in traffic: less cars or no cars at all, decrease in speed on the street in front of the school, a speed limit of 30 km/h, a play street, safe biking especially for families, car sharing. The Seestadt Aspern already has a mobility concept stipulating that car traffic must not exceed 20% of total traffic. The need for innovative handling of car traffic is immense.



Figure 3: *Café collecting wishes at Seestadt Aspern Vienna 2015, photo Anna Graber des Visions*

Nature: in other cities, the wishes concerning nature are always mentioned first and constitute the biggest group. At the Seestadt, the main issue in this category was public green space instead of asphalt and concrete: walking on natural ground, trees to give shade, wild flowers with rich blossoms that attract insects and butterflies. A little girl painted a bee – in the whole area, not one insect was to be seen. The areas around the trees should be greened with grass and wild flowers or with plants in big pots. Water, a pond and a fountain for kids to play were mentioned. A young mother wished to have a farm with animals like cows and pigs.

Socio-environment: in this category, the main concern was creating urbanity: the space should be appropriated, city life should grow. It should be the people who write the history of the place, the uniting pioneer-spirit should be preserved. Other statements included: the city life of a small town, facelook, encounters of the heart, public disputes and controversy, there is few to negotiate, prevention of a ghetto, transparent communication, to be asked and included in the development process.

Culture: city life shall be initiated by culture, identity, i.e. an artwork, a connection to the history of the place, to the former airport (where great pilots are said to have been able to pick up a handkerchief from the runway out of the flying plane) shall be established, a lighthouse, a room for concerts as a meeting point, the possibility of making music everywhere in the city, an open stage with concerts every noon with a diversified program, a radio station, windflowers, poetry, fairy dust. Many wishes and paintings showed a great desire to express oneself openly in the city and in contact with others.

The way people used *Café des Visions* as a space for encounter and discussions showed how little they are involved in the planning of the new city.

	Criteria Group	Criterion	Wishes
Environmental Quality	Global and Local Environmental Impacts	Life Cycle Assessment	
		Ground Water and Soil Protection	
		Changing Urban Microclimate	
		Biodiversity and Interlinking	2%
		Habitats Assessment of Environmental Risks	
	Resource Consumption and Waste Generation	Land Use	
		Total Primary Energy Demand and Proportion of Renewable Primary Energy	
		Energy-Efficient Development Layout	
		Resource-Efficient Infrastructure	
		Local Food Production	5%
		Water Circulation Systems	
Economic Quality	Life Cycle costs	Life Cycle Cost	
		Fiscal Effects on the Municipality Value Stability	
	Financial Performance	Value Stability	
		Efficient Land Use	
Sociocultural and Functional Quality	Social Qualities	Social and Functional Mix	18%
		Social and Commercial Infrastructure	41%
	Health, Comfort and User Friendliness	Objective/Subjective Safety	1%
		Public Space Amenity	4%
		Sound Emissions and Sound Insulation	
	Functionality	Open Space Offer	12%
		Inclusive Access	
		Development Layout and Flexibility	2%
	Aesthetic Quality	Urban Integration	
		Urban Design	3%
Use of Existing Structures			
Art in Public Space		5%	
Technical Quality	Quality of technical Implementation	Information and Telecommunication Infrastructure	0.5%
		Energy Technology	
		Efficient Waste Management	
		Rain Water Management	
		Maintenance, Upkeep and Cleaning	
	Traffic / Mobility	Transport System Quality	2%
		Motor Transport Infrastructure Quality	2%
		Public Transport Infrastructure Quality	0.5%
		Bicycle Infrastructure Quality	2%
		Pedestrian Infrastructure Quality	

Wishes for the Seestadt Aspern arranged to the DGNB Systematic for Sustainable Neighbourhoods (NSQ12)
187 interviewees = 100%

Figure 4



Figure 5: Anna Graber, Mapping Seestadt Aspern, wall picture at the festival urbanize!, 3mx2m, pigments and acrylics on the wall, Vienna

<p>schema 1 cities - wishes - subjects</p>	<p>Wien</p>
<p>architecture, design, infrastructure inviting to linger</p>	<p>Leibnitz</p>
<p>architecture, design, infrastructure activity, sports</p>	<p>Zug</p>
<p>architecture, design, infrastructure uniqueness spontaneously developed concepts</p>	
<p>architecture, design, infrastructure traffic</p>	
<p>architecture, design, infrastructure city planning</p>	
<p>culture</p>	

Figure 6

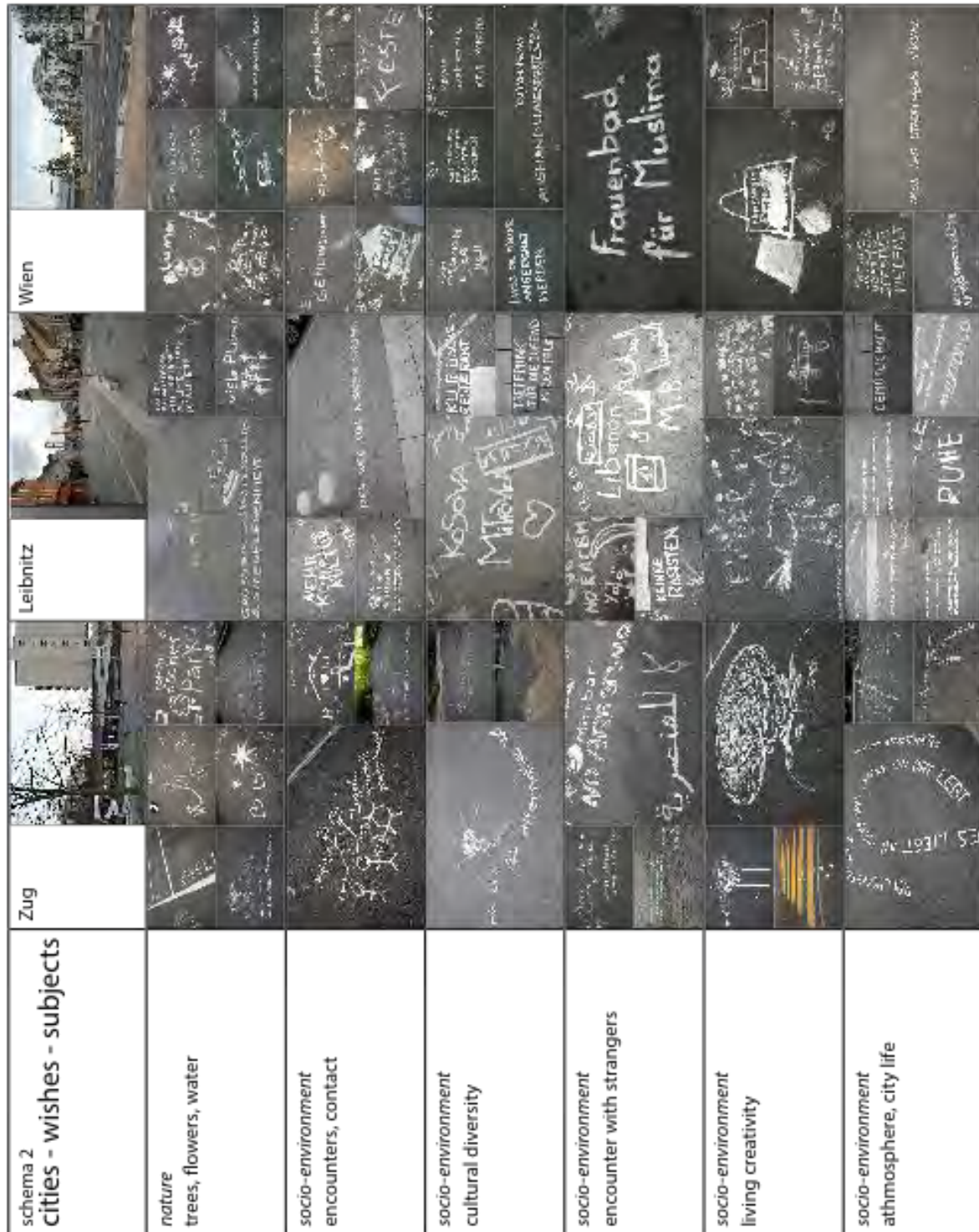

Figure 7

5. CONCLUSION

From the above-mentioned social demands of users, demands on the design of public spaces can be derived. The simplicity of some wishes just show, that the basic needs are not met yet. People want to be invited to linger. The most frequently mentioned wishes at the Café are easily met and not expensive: green that gives the place its atmosphere, shade and comfortable seating. Places that beckon also promote communication. This requires movable seating that allows eye contact during a conversation and a flexible group size to speak at a pleasant distance.

A music garden is an example of an unconventional idea that has the potential to give a place a unique atmosphere. It would become unique and different from others and give passers-by a real choice as to where they wish to spend their time.

The moribund public described by Habermas needs new meeting points that are suitable and not commercially oriented. If there is no gap between customers and service providers, humans meet at eye-level. The responsibility for the place is then shared by everyone.

Therefore, *Café des Visions* recommends that every neighbourhood should have a village square that is planned and constructed by the inhabitants. How this can be achieved is shown at Park Fiction, a public park on the riverbank of the Elbe in Hamburg. With the support of the two artists Christoph Schäfer and Cathy Skene, the neighbourhood fought against the planned building complex and created, by means of an artistic production of wishes a park with unique elements like a flying carpet made of grass surrounded by an Alhambra mosaic – the person who made this wish thought the Alhambra to be the most beautiful place in the world. The park was constructed by a collaboration of specialists and ten years after the inauguration it is still maintained by the neighbourhood.

An artistic collection of wishes with its discussions on the **street involves people, that wouldn't take part at** conventional participatory meetings. It directly connects ideas and spaces. With the artistic method of open thinking an important step of a planning process for a public space can be made accessible to many people, it can build a bridge between professional planners and users in advance and provide a base for an ongoing collaboration. It brings back the imaginary to planning and to public spaces and it makes the creation of city live to an oeuvre in the sense of Henry Lefebvre.

REFERENCES

- [1] Gehl Habermas, J., 1990, Strukturwandel der Öffentlichkeit. Frankfurt am Main, p. 55 and p. 86
- [2] Habermas, J., 1990, Strukturwandel der Öffentlichkeit, Frankfurt am Main, p. 125
- [3] Gehl, J., 2012, Leben zwischen den Häusern, Berlin, p. 74
- [4] Gehl, J. und Gemzøe, L., 2013, How to study public life, New York
- [5] Lefebvre H., in Lewitzky, U., 2005, Kunst für alle?, Hamburg
- [6] Flick, U., 2007, Qualitative Sozialforschung, Reinbeck
- [7] Gehl, J., und Gemzøe, L., 2013, How to study public life, New York
- [8] Guy Debord
- [9] Csíkszentmihályi, M., 2010, Kreativität, Stuttgart, p. 356
- [10] Siebel, W., in Lewitzky, U., 2005, Kunst für alle?, Hamburg
- [11] Siebel, W., 2015, Die Kultur der Stadt, Berlin 2015
- [12] Csíkszentmihályi, M., 2010, Kreativität, Stuttgart, p. 443
- [13] Habermas, J., 1990, Structural transformation of the public, p. 57 <http://park-fiction.net> on 20.09.2016
- [14] Lefebvre, H., 2016, Das Recht auf Stadt, Hamburg, p. 31; german translation
- [15] rom Le droit à la ville, Paris 1968

Track 11: Sustainable Neighbourhoods: Applications and Case Studies

Session 5.8: Sustainable Neighbourhoods - Case Study Review (1)

Learning from The Lessons of Transit-Oriented Development to Improve Urban Planning in China

Frederic Daniel DU VERLE^a, Becky PY LOO^b

^a Archimedialab, Germany / Mainland China, f.du.verle@gmail.com

^b The University of Hong Kong, Hong Kong S.A.R, bpyloo@hku.hk

ABSTRACT

A holistic evaluation of the built environment's sustainability should not be limited to common efficiency criteria such as construction standards or energy consumption. It should also consider the sustainability of its direct and indirect impacts of people. Transit oriented-**development (TOD) neighbourhood's built environment has proved to** contribute to more sustainable transportation, but Loo and du Verle (2016) push beyond the realm of transportation to consider the potentially sustainable benefits of TOD for city planning. Practical experience and studies in China show that despite China's efforts to turn to a more sustainable society, its urban development faces many challenges. Cities and towns still mainly follow a grid-pattern road network and wide multiple-lane vehicular roads. Planners and policymakers have little flexibility for interventions, leaving room for private developers to develop super-sized blocks as "typical" development that is far beyond the actual density or energy-saving expectations for sustainable development.

This work explores the possibility of transferring the TOD's built environment characteristics and approach to non-TOD Chinese neighbourhoods (as major transit stops may not be implemented or found everywhere) in order to improve their sustainability not only through promoting walking and more sustainable travel options but also by improving the quality of the overall built environment. The neighbourhood-scale approach helps to integrate policies and design guidelines for a more sustainable environment while preserving the interests of stakeholders. A fully integrated sustainable approach should be established through a highly collaborative planning platform involving every actor, from government to stakeholders, and guided by clear quantitative reference systems.

Keywords: transit-oriented development, built-environment, China

1. TOD OPPORTUNITIES BEYOND SUSTAINABLE TRANSPORTATION

Transit-oriented development (TOD) **has been seen as an efficient policy to address modern urban planning's** issues through the promotion of sustainable urban transportation aiming to reduce greenhouse gas (GHG) emissions to a certain level by a certain date, or as low as possible by fighting electricity and transport fuel, identified as the main cause of carbon emission (Brown, Sothworth and Sarzynski, 2008). This application of TOD does not offer a fully sustainable solution to transportation challenges around the world. By focusing mainly on carbon reduction targets, the social and economic aspects that composed the sustainable approach are often **neglected (Loo and Chow, 2006; Preston and O'Connor, 2008).**

A life cycle approach brings a more comprehensive sustainability by not only tackling down the effect but also looking at the causes for a change of development forms and behaviour. Applied to TOD, a life cycle approach would mean to use principles that can reduce indirectly the need of transportation but also offer a full range of alternatives in addition to the mass transit around which the neighbourhood is organised. The United Nation [U.N.] (2014) identified five (5) main principles to improve sustainability of neighbourhoods: 1 – **“adequate space for street and an efficient street network”, 2 – “high density”, 3 – “mixed land use”, 4 – “social mix” and 5 – “limited land-use specialisation”.** **These principles are applied in a TOD through the management of the three (3) core dimensions** of its built environment (density, diversity, and design).

Chinese urbanisation is facing important challenge that has urged for a more sustainable change. Many Eco-Cities projects have been developed in China in the past decades, but for those that are implemented, they often results in failure for different reasons such as lack of policy support and coordination between the different parties. Eco-cities are often based on a pilling up of new technologies aiming for at zero-emission target that is complicate to reach when applied at different local contexts. Most of the time, planning results into a standard form of development that creates super-sized blocks (of 500 to 800 metres long on each side) that are far from being sustainable. The use of green technologies only is not enough to create a sustainable environment. On the other hand, Loo and du Verle (2016) have highlighted the potential of TOD's principles beyond the realm of transportation by identifying different types of TOD neighbourhoods from a same city. In this paper, we are going deeper and explore the possibility to transfer TOD's 3D characteristics into a non-TOD neighbourhood to see whether sustainability can be increased without the presence of transit stations.

2. TRANSIT-ORIENTED DEVELOPMENT PRINCIPLES AND VALUE

TOD policy is a tool to create a healthier community development model with a stronger economy while reducing the carbon footprint and greenhouse gases (GHG) emissions by being centred around a quality public transport station in order to offer a more sustainable alternative form of transportation; this is achieved by creating a mix of housing, retail and/ or commercial development and amenities, which are all integrated into a walkable neighbourhood to create opportunity and feasibility of trips through better accessibility (Handy, 2002, Cervero, 2009, Loo, 2009, Loutzenheiser, 1997). To ensure its good implementation TOD's built environment is commonly defined by the 3Ds as core elements to support its sustainability (Cervero and Kockelman, 1997). In addition to the direct benefit related to the increase of public transport usage, TOD generates a lot of indirect co-benefits, such as helping to have fewer cars in the streets that affect different aspects of the development, e.g. its liveability, quality of life, social equity, and many others (Cutts et al, 2009; de Nezele et al, 2011; Litman, 2006). Many of those co-benefits, and many more, can be directly associated with the 3Ds of the TOD (Loo and du Verle, 2016). Some studies, following more closely the principles of the UN, add two (2) more dimensions to bring the core characteristics of the built environment to 5Ds, by considering the distance to transit and destination access. However, in their study, Loo and Du Verle (2016) found that variables defining these additional dimensions could also be classified in one of the original 3Ds. Hence, destination access or accessibility is often explained by the variables measuring the number of intersections, the different types of public transport and the number of lines available, or the number of exits to a transit station. These same variables can also respectively be classified as part of the density, diversity or design dimension. In view to avoid any redundancy of variables or misclassification the use of the 3Ds was preferred over the 5Ds.

Many good lessons of TOD can be found to create a better environment in a neighbourhood where a transit station has been built or to support the ridership of the mass transit. To ensure the success of a TOD its mass transit has to be made successful through policy development and organisation of its surrounding built environment to justify the existence of a transit station. Those successful examples show how after changes in the built environment (densification, increase of the different activities, new design connecting to the mass transit, etc.), the new neighbourhood together with efficient mass transit system make possible the creation of a more sustainable environment. Beside projects such as the redevelopment around the BART stations in the San Francisco Bay area (National Research Council [U.S.], 1980), Hong Kong is a good example, with many successful TOD neighbourhoods, where the built environment's characteristics are carefully considered and integrated to mass transit station planning with programme strategies such as the Rail-cum-Property model of the MTR Corporation (Cervero & Murakami). The 3Ds play an important role in the sustainability of those new neighbourhoods. However, those examples are always centred on neighbourhoods including a mass transit stations. Yet, when often in new development or new neighbourhood, there may not be a lack of sustainability, there is no immediate possibility to integrate it with a mass transit system.

3. TRANSFERRING/ APPLYNG TRANSIT-ORIENTED DEVELOPMENT PRINCIPLES IN NON-TRANSIT-ORIENTED DEVELOPMENT AREAS

3.1. The three dimensions (3Ds)

The 3Ds bring valuable co-benefits for a more sustainable development; they also are the core characteristics of the built environment that help to identify TOD into different categories. To apply TOD principles in a non-TOD

area the 3Ds characteristics have to be transferred to that area. TOD has been categorized into different types defined by the nature of their functions identified through the characteristics of their built environment and, on their integration to the mass transit system. However, 3Ds variables cannot be independently analyzed directly from non-TOD neighbourhood as the classifications of the TOD-neighbourhood show that they are the result of complex association of different variables coming from each dimension and not only from one of them. In a development where there is no transit-station neighbourhoods that can be used as reference to identify the different neighbourhoods, key centres are identified. In non-TOD areas, those 'centres' are a development pole with key functions (i.e. economic pole, educational pole, administrative and institutional pole, etc.) that structure the development. The non-TOD centres (or neighbourhoods) can be compared to TOD categories by the nature of their functions for the application of TOD principles.

3.2. Relevancy of local context

Loo and du Verle (2016), highlight the importance of using the district-level analysis for TOD, as even within a same given city, it is not a homogenous group, especially when even in a dense city all residents are not within a walking distance (defined as 500 metres) of a transport station. Often, study of TOD and its transportation system use the regional or city scale to analyse the stock of the different transportation systems and how they work together into a coherent network. In this study the analysis is not looking at the transportation aspect of TOD but rather at the built environment that is best understood at the neighbourhood scale. Moreover, a local context helps to clarify the identification of the neighbourhood and the possible interventions of the government.

3.3. Methods

The authors explore how it is possible to apply TOD principles through the transfer of its built environment's 3Ds characteristics, to neighbourhoods without transit stations in view to see if that can increase their sustainability. In previous research five (5) types of TOD have been identified in Hong Kong (Loo and du Verle 2016). These five types of TOD were identified through a principal component analysis that reorganized the variables of each 3Ds into factors that describe the different type of TOD neighbourhoods. Among the 20 collected variables classified into one of the three dimensions (density, diversity, or design) by Loo and du Verle (2016), most of them consider sustainable principles listed by the UN (accessibility, social mix, etc.). The variables used were the following for the density dimensions: 01 – Population density, 02 – Employment density, 03 – Residential development intensity, 04 – Commercial development intensity, 05 – Mixed commercial-residential development intensity, and 06 – Overall development intensity. For the diversity dimensions the variables used were: 01 – Comprehensive development, 02 – Diversity of land uses, 03 – Household size, 04 – Diversity of housing types, 05 – Levels of other public transit services, 06 – Convenience of other public transit, and 07 – Income. Finally, for the design dimension the variables identified were: 01 – Road connectivity, 02 – Road density, 03 – Open space, 04 – Covered walkway (to the mass-transit station), 05 – Expressways (in the neighbourhood), 06 – Exit system (of the mass-transit station), and 07 – Retail (within the mass-transit station)

The nature of each TOD-neighbourhood is compared to the nature of non-TOD neighbourhoods from the case study to find the most relevant categories to be matched together for the transfer of the 3Ds from one into the other. TOD categories that are mostly defined by their mass transit station or their integration to the station (e.g. Station-type TOD and integrated-type TOD) are automatically discarded. Once the different types of TOD are selected, their 3Ds variables are listed to be extracted and analysed from the non-TOD neighbourhoods. Once again, variables that are directly connected to the mass transit station are not applicable in the case of a non-TOD neighbourhood and are discarded. The case study is a masterplan for a new development in China from the professional experience of one of the author, which aimed to reach Eco-City standards. This case study has been chosen, even though it is not yet totally built or occupied by any resident, because of the knowledge of its planning details, creation process involving different parties, and reduced gap between the context of the two case studies.

4. RESULTS OF A CASE STUDY IN CHINA

4.1 Presentation of the case study

The masterplan follows the “eco2city” approach developed by The World Bank and based on a “Life Cycle Approach” to create a resilient local economy supported by strong ecological integration. This approach is a guide

for the use of powerful sustainable tools and planning process, such as the important “Charrette” (an advanced type of workshop) for a comprehensive collaborative platform for every party to be integrated into a more successful planning (Roggema et al., 2014). The study case is a 5 km² university town at the entrance of a 100 km² new town to be developed on the newly reclaimed land on the East coast of the Nantong municipality, in Jiangsu. The was developed and organised between strong centres of activity, to support its own development until it can be later fully integrated to the rest of the city. The major roads crossing the site are one of the most important consideration, they connect the inhabitants of the future new town to the regional road and to the potential future train station. The new planning has also to integrate existing built or under construction infrastructures from a previous government’s plan. Various factors restrained the modification of the plot size. Therefore, the planning focused on increasing the sustainability of the development from within the super-sized block by planning for the use of local resources for constructions and greening, the integration of the plot to the road and the use of new technologies as some of the solutions to improve the sustainability.

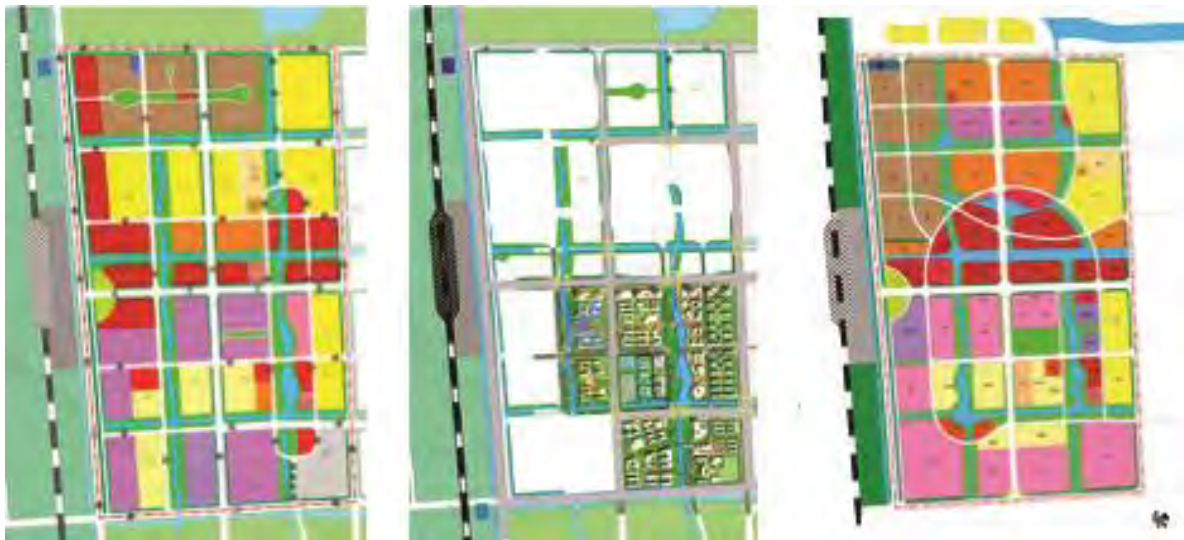

Figure 1: Nantong’s masterplans - From left to right: original land use plan, existing or under-construction plan, company’s final land use proposal

In this case study, six (6) types of neighbourhoods are classified into centres based on the nature of their functions and, none of them can be classified as TOD because of the absence of certainty of a mass transit station within or close to the neighbourhoods. The different centres identified are “matched” with TOD neighbourhood following the description of their nature as it is presented in Table 1, which helps to select the relevant TOD-neighbourhoods for comparison.

TOD neighbourhoods types	Nantong’s centres types
CBD-type	- Business incubator and retails centre - Commercial and retails centre
Balanced-Type	- Living centre
Residential-Type	- Residential centre
N.A.	- Factory and production centre
N.A.	- University centre

Table 1: List of the different types of neighbourhoods found in the projects compared with corresponding types of neighbourhoods identified from the different categories of TOD.

The 3Ds’ variables available in the case study are listed in Table 2, with the type of TOD in which they are found. Some variables were discarded because of the lack of data or simply because they were directly related to the transit station (e.g. number of station exits). Two categories of centre (“factory and productions centre”, and the “university centre”) cannot be represented by any type of identified TOD-neighbourhoods. The variables selected showed the importance of the physical aspect of the built environment in this analysis, especially because the

project is also too recent to integrate complete and valid socio-economic variables. Interestingly, a similar number of variables for each dimensions (density, diversity and design) have been selected which, help to provide a more comprehensive and balanced study of the 3Ds, when other research may focus on one (or two) particular dimension and neglect the others.

Original 3Ds variables	Indicators	TOD-Type
(Density-1) Population density	Number of residents / land area	Residential-Type
(Density-2) Commercial development intensity	GFA of commercial use / land (ground) area for this use (m2 per km2)	CBD-type
(Density-3) Overall development intensity	Total GFA / total land (ground) area (m2 per km2)	CBD-type
(Diversity-1) of land uses	Simpsons Index of land uses (Loo and Lam,)	Balanced-Type
(Diversity-2) Levels of other public transit services	Total number of bus lines* / land area (km per km2)	CBD-type
(Design-1) Road connectivity	Number of road junctions / total area	CBD-type
(Design-2) Road density	Road length / total area (m per km2)	CBD-type, Balanced-Type
(Design-3) Open space	Share of built open space / land area	Balanced-Type

Table 2: List of remaining 3Ds' variables of selected TOD categories transferrable to non-TOD neighbourhoods

Due to the early planning stage of the study case not enough data is available to measure many variables that defined some of the type of TOD neighbourhoods identified. The few remaining available variables measuring the “residential-type” and “balanced-type” neighbourhoods are too reductive and have a too high value on the Skewness test. All the remaining variables that can be collected and retained from the study case are corresponding to the CBD-type. The variables compared to the characteristics of the centres identified during the planning process of the case study suggest that the CBD-type neighbourhood is more easily transferable in early planning stage to a non-TOD neighbourhood for the improvement of its sustainability. The variables explaining the CBD-type of neighbourhood highlight the importance of increasing road and transport connectivity through higher number of junctions, road length density, number of public transport lines, all in a denser development within the boundaries of the neighbourhoods or centre. This means that such accessibility must be implemented within the super-sized block of Chinese new planning projects. Therefore, an important work about accessibility and design integration to its surroundings must be done on these super-sized blocks. Despite the limitations of the study case and lack of data available, these preliminary findings highlight important points in the planning strategy that requires the collaboration of the different parties involved in the planning process.

4.2 Discussion about the dynamics of three parties involved in planning in China

Eco-city projects in China are often failing because of the lack of coordination between the three parties of a project, which are 1 – the (local and central) government; 2 – the stakeholders; and 3 – the planners.

Since 2012 the central government in China has shown its involvement for the development of Eco-City for triggering the country's shift toward a more sustainable development (Yu, 2014). However, even supported by an elaborate assessment system, the policies applied remain limited and continue to promote a traditional development model by being based on the same economic development policy since the 1980's and with mostly only incentive actions which are often ignored by local governments (Yu, 2014; Li, Zhang and Li, 2011). Local governments are subjected to a lot of pressure from higher levels to increase regional GDP, also used for the evaluation of the local government and senior leader, and to manage the region with a limited revenue coming mostly from land leasing and the tax system (Yu, 2014). Therefore, cities by growing faster become more complex with more levels of governance that require delegation of power. This context generates important conflicts for policy development of a city, resulting in a major challenge to create a real coordination, transparency and accountability of Chinese cities development (Hald, 2009).

Meanwhile, a “marketized” planning is being developed with the increasing involvement and influence of stakeholders set free by the lack of regulation and weak control capacity of the municipality for planning. In practice, it is easy to observe that developers often impose their own schemes of development, aiming for a minimum cost and quick financial return, to a government struggling to reach its economic development goal. They strengthen the standard development model by increasing the comfort and luxury but with a total lack of basic sustainable approach. Life span or energy savings become strange concepts and distant from the local population that can no longer understand the need or the advantages of a more sustainable approach (Yu, 2014).

Government’s planners have a really “engineering approach” to support this whole process of “marketized” planning, offering more flexibility to developers. This results in a fragmented planning, organised into super-sized blocks that each independent developer builds following its own strategy. The main challenge of private firms is to integrate their projects to the rest of the development. Therefore, planners should focus on the development of collaborative platform to 1 – to increase population awareness toward sustainable planning, 2 – show to the government alternative economic and framed planning development and, 3 – involve stakeholders for ensuring their investment into the project and reassuring them about its profitability. The case study presented here is the results of such collaborative approach, allowing full participation of all the parties, trying to reach a certain level of sustainability of the projects despite compromises.

5. LESSONS LEARNT AND FUTURE DIRECTION

In this paper, we investigated **the recognition of TOD’s value beyond transport impacts to increase the sustainability** of new development. In this first approach, it seems that one particular type of TOD would be more appropriate to use for the transfer of its built environment characteristics in a non-TOD neighbourhood. If it is confirmed that will be a great opportunity to increase quality of life and other sustainable dimensions of a neighbourhood through the **co-benefits of the TOD’s 3Ds (Cutts et al, 2009; de Nezelle et al, 2011; Litman, 2006)**.

However, in China, new development projects, though aiming at a more sustainable approach, are in too many aspects following the super-sized block planning model. This contradiction is often forced by a marketized planning that is required to ensure the continuity of any projects in the Chinese context. Until the super-sized block with unique land use is abolished, a clear effort of collaboration between the different planning parties of a project is required to create a better integration and coordination. Meanwhile, statutory planning guidelines should be implemented to support the increase of sustainability through the transfer of built environment characteristics using the various TOD-neighbourhoods identified as reference guidelines into comparable non-TOD neighbourhood. This new scheme, rather than drastically undo the super-sized block, should regulate them from inside by considering them as small neighbourhoods (the size of which being almost comparable to small TOD neighbourhoods). These guidelines should aim at the regulation of each super-sized block following the benchmark of a corresponding type of TOD-neighbourhood based on the nature of their functions for increasing their standards following principles such as the level of accessibility through design guidelines prescribing the number of public roads and intersection to be built within the super-sized block, or how to integrate it to its surroundings and the main roads. A more effective political structure, avoiding internal competition, is needed to support these development and implementation policies. Municipal governments, policy-makers and the population need to recognise the **co-benefits of TOD’s built environment, to ensure its application through a clear local statutory planning guidelines**, supported by a reliable and quantifiable sustainable planning evaluation system that establish normative standards. Such standards already exist in architecture such as the LEED program (in USA), or the DGNB (German Sustainable Building Council) that include urban planning criteria (e.g. type of land use of the site – **criterion #15 in Germany**). **Until such guideline are implemented, “Charrette” has been proved to efficiently integrate all the parties within a project, and despite the need for compromise, it can ensure its full realisation for a potential better success.**

REFERENCES

- [1] BROWN, M., SOUTHWORTH, F. & SARZYNSKI, A. 2008. Shrinking the carbon footprint of metropolitan America. Washington, DC: The Brookings Institution.
- [2] CERVERO, R. 2009. Public Transport and sustainable urbanism: Global lessons. In: CURTIS, C., RENNE,
- [3] ROGGEMA, Rob et al. (2014) The Design Charrette - Ways to Envision Sustainable Futures, Springer Dordrecht Heidelberg New York London. Journals

- [4] Cervero, R., & Kockelman, K. (1997). Travel demand and the 3Ds: Density, diversity, and design. *Transportation Research D*, 2(3), 199-219.
- [5] CERVERO, R. & MURAKAMI, J. 2009. Rail and Property development in Hong Kong: experiences and extensions. *Urban Studies*, 46, 2019-2043.
- [6] Cutts, B.B., Darby, K.J., Boone, C.G., & Brewis, A. (2009). City structure, obesity, and environmental justice: An integrated analysis of physical and social barriers to walkable streets and park access. *Social Science & Medicine*, 69, 1314-1322.
- [7] de Nazelle, A., Nieuwenhuijsen, M.J., Anto, J.M., Brauer, M., Briggs, D., Braun-Fahrländer, C., ... Lebrecht, E. (2011). Improving health through policies that promote active travel: A review of evidence to support integrated health impact assessment. *Environment International*, 37(4), 766-777.
- [8] HALD, May (2009) Sustainable Urban Development and the Chinese Eco-City – Concepts, Strategies, Policies and Assessments, FNI Report 5 for the Fridtjof Nansen Institute.
- [9] HANDY, S. L. 2002. Accessibility- VS. mobility-enhancing strategies for addressing automobile dependence in the U.S. European Conference of Ministers of Transport. Paris.
- [10] Li Lijuan, ZHANG Bo and Li Shanyong (2011) Quantitative study of eco-city in Northwest China, *Procedia Engineering* 21 (2011), 345-353
- [11] LI Yu (2014) Low carbon eco-city: New approach for Chinese urbanisation, *Habitat International* 44 (2014), 102-110
- [12] Litman, T. (2010). *Evaluating Public Transportation Health Benefits*. Victoria, BC: Victoria Transport Policy Institute.
- [13] **Loo, B.P.Y. (2009a) "Transport, Urban". In R. Kitchin & N. Thrift (Eds) International Encyclopedia of Human Geography. Oxford: Elsevier, 468.**
- [14] Loo, B.P.Y., & Chow, S.Y. (2006). Sustainable urban transportation: Concepts, policies, and methodologies. *Journal of Urban Planning and Development-ASCE*, 132(2), 76-79.
- [15] Loo, B.P.Y. and du Verle, F.D. (2016 - in press) Transit-oriented Development in Future Cities: Towards a Two-level Sustainable Mobility Strategy. *International Journal of Urban Sciences (IJUS)*. DOI: 10.1080/12265934.2016.1235488
- [16] Loutzenheiser, D. R. 1997. Pedestrian access to transit: Model of walk trips and their design and urban form determinants around Bay Area Rapid Transit stations. *Transportation Research Record*, 40-49.
- [17] NATIONAL RESEARCH COUNCIL (U.S.) 1980. An assessment of the Bay Area Rapid Transit (BART) impact program, Washington, D.C. :, National Academy of Sciences.
- [18] Preston, J. & K. O'Connor (2008) "Revitalized transport geographies." In R. Knowles, J. Shaw & I. Docherty (Eds). *Transport Geographies: Mobilities, Flows and Spaces*. Malden: Blackwell, pp. 227-237. Discussion Notes:
- [19] UNITED NATION [U.N.] (2014) A new strategy of sustainable neighbourhood planning: five principles. Discussion note 3 – urban planning. United Nation Habitat.

A Green Campus Master Plan - The Chinese University of Hong Kong (CUHK)

FUNG Siu-man^a, Thomas YUEN Ka-yiu^b, Stephen HO Kin-wai^c

^a The Chinese University of Hong Kong, Hong Kong SAR, smfung@cuhk.edu.hk

^b The Chinese University of Hong Kong, Hong Kong SAR, thomasyuen@cuhk.edu.hk

^c The Chinese University of Hong Kong, Hong Kong SAR, stephenho@bld.msmail.cuhk.edu.hk

ABSTRACT

Found in 1963, The Chinese University of Hong Kong (CUHK) has developed from a student population of about 3,000 to 28,000 in 2016. In the course of development, the Campus Master Plan (CMP) has provided an exemplary sustainable framework to balance the growth of the University in achieving teaching and research excellence under her unique college system and campus environment. The CMP consists of six key planning precepts:

- Making a sustainable campus
- Places for education and research activities
- Enhancing college life
- A pedestrian friendly campus
- Conserving places of value
- A landscape of vital importance



Keywords: green campus, master plan, sustainable neighbourhood

1. INTRODUCTION

The mission and vision of CUHK:

- To assist in the preservation, creation, application and dissemination of knowledge by teaching, research and public service in a comprehensive range of disciplines, thereby serving the needs and enhancing the well-being of the citizens of Hong Kong, China as a whole, and the wider world community; and
- To be acknowledged locally, nationally and internationally as a first-class comprehensive research university whose bilingual and multicultural dimensions of student education, scholarly output and contribution to the community consistently meet standards of excellence.

Found in 1963, CUHK with a suburban campus of about 137 hectares has developed from a student population of some 3,000 to a population of about 28,000 in 2016. Following the initial development plan by W. Szeto & Partners, a master planning process is being carried out in response to the strategic objectives to address the increased student population and the changing requirements of the academic disciplines.

The CUHK Campus Master Plan (CMP) is an exemplary framework to balance the growth of the University in **achieving teaching excellence and research achievements via CUHK's unique college system** and campus environment. In the process, consultations and engagements are conducted with the stakeholders to gather their aspirations and feedbacks.



2. CUHK CAMPUS MASTER PLAN

The vision of the Campus Master Plan (CMP) is to enable the University to be an exemplar of sustainable development by balancing the enhancement of its campus environment with the conservation of its natural heritage. The CMP is conceived as a living and continually developing document and it consists of six key planning precepts as detailed in the following sections:

2.1 Making a sustainable campus

The University pledges its commitment to continuously improve the environmental quality of the campus, putting the principles of sustainable design at the heart of campus development, and has been acclaimed for her innovations and efforts, e.g. Green Building design excellence, measures for recycling, uses of renewable energy, energy conservation, wastes management, tree and ecology preservation, and carbon audit on existing buildings, etc.

Reporting to the Campus Planning Committee chaired by the Vice-Chancellor, the University's dedicated offices such as the Campus Development Office, Campus Planning and Sustainability Office, and Estates Management

Office collaborate to carry out the campus planning, building and infrastructure construction, sustainability education and operations including energy audit and incentive schemes, etc. Green Building design principles are implemented to ensure that the built environments are friendly, inclusive and sustainable.

With the concerted effort and the implementation of the Energy Saving and Conservation Plans, the University has reduced energy and general waste progressively in the past years.

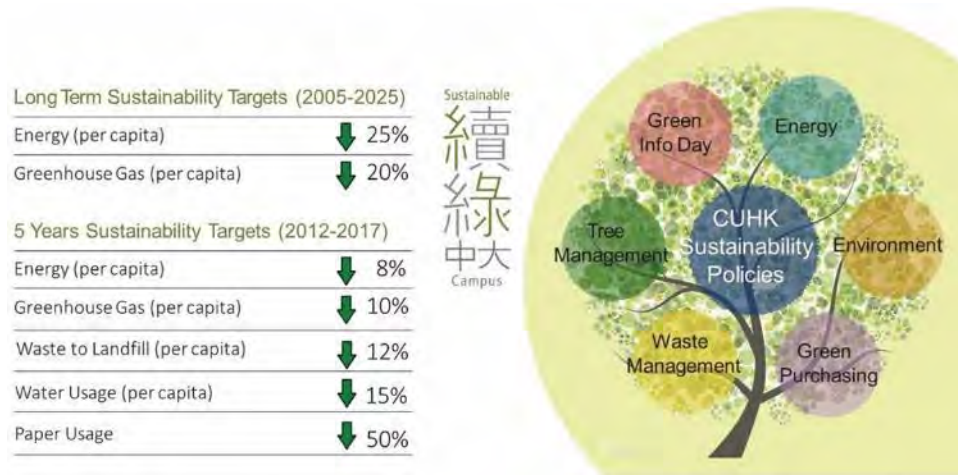

The University has adopted many initiatives in reducing the overall carbon emission. Weiyuan Lake 未圓湖, a genius Loci for Chung Chi College at the foothill, is used as a storage tank of natural rainfall. It helps to regulate the micro-climatic of the surrounding built environment and reduce the energy used for cooling. It is also home to over 200 plant species including over a third of all tree species in Hong Kong. After purification and sedimentation, the grey water from this alternate source is used for irrigation, street cleaning, A/C cooling and contributes about 27% of the daily water consumption of the University. In the reduction of energy and water consumption, other initiatives such as installation of daylight/ motion sensors to control lighting & AC, energy efficient LED lighting fittings, roof gardens, electric vehicles & charging points, wind turbines for street lighting, district cooling/water-cooled chiller system, solar water panel & photo-voltaic panels in student hostels, water-saving fixtures and reuse of used water collected are also adopted.



2.2 Places for education and research activities

The CMP develops the concept of clustered and zoned development for disciplinary teaching and research activities with a view to strengthening connectivity between the existing and new facilities. While the academic facilities are zoned in proximity clusters to encourage social interaction and academic collaboration, dedicated

landscape features, open spaces and vertical transportation devices were planned in parallel to enrich the Walking Campus experience. This enables the efficient use of resources, convenience of access and optimizes the land use.

In designing these facilities consideration such as natural day lighting, visual comfort, indoor environment quality, thermal comfort, acoustics, natural ventilation are implemented such as window wall/ skylight to maximise natural day lighting, roof greening for enjoyment, acoustic windows, etc.

2.3 Enhancing college life

Of all Hong Kong universities, CUHK is the only one that offers a college experience. College programmes and activities complement the formal curricula by delivering whole-person education and pastoral care. The college system also encourages intimate interaction among teachers, students and alumni.

CUHK was established in 1963 as a University with a federal constitution. To the constituent colleges of Chung Chi, New Asia, United and Shaw, Morningside, S.H.Ho, C.W.Chu, Wu Yee Sun and Lee Woo Sing have recently been added, bringing up the total number of colleges to nine. The spatial organization of the University and the colleges is expressed in terms of their facilities as well as the clustering and scale of buildings in association with the planning of open space and circulation spines.

While CUHK's administration and academic facilities are mostly located in the Central Campus along the axis of the University Mall, the colleges are planned in a satellite pattern, maintaining their identities with different culture, architectural expressions and building clusters. Scale of the colleges ranges from 300 to over 3,000 students. Apart from the hostel blocks, the college complexes provide a variety of indoor and outdoor amenities, activities and gathering spaces. In the design and operation of these facilities, Green Building and 'Eco-Habitat' design principles are adopted to encourage whole-person development and interactions outside the classrooms.



College life is a vital part of student wellbeing and education in CUHK; dedicated programmes are conducted in Colleges to cultivate environmental awareness of the students and to achieve a green and energy conscious living style. In some new hostel blocks, 'Smart meter on Progressive rate Scale for Top-up' are installed for students to keep track of their electricity consumption for bedroom A/C, fridge, fan or heater, etc.

Campaigns in Colleges such as 'Love Food Hate Waste @ CUHK' guided students to reduce their Leftover Meal 剩宴 to more than 20% per year and trained more than 50 student ambassadors (有衣食達人) in the practice of 'Green Living'. 'Green Student Societies' are organized and 'Year-End Hostel Check-out Scheme' also recycles more than 10,000kg of clothes, paper glass, household ware, etc. from 34 hostels.

2.4 A pedestrian friendly campus

The CUHK campus was found on a hilly terrain with a level difference measuring over 150m from the Mass Transit Railway along Tolo Harbour to the mountain top where two founding colleges and their iconic water towers are located. While vertical circulation poses a major challenge on campus, the CMP plans to reinforce the major pedestrian spines and connect the various campus terrains by creating a complete and desirable network through link bridges, covered walkways, grand steps and communal gathering spaces. This walkway infrastructure is further assisted by lifts and escalators in new buildings built along the major circulation routes.

Pedestrian-Friendly Campus

- Enhanced connectivity promote **Walking Campus**
- **Vertical Links:** lifts, bridges and escalators to increase mobility through CUHK's hilly campus



Green Transport

- Largest fleet of electrical vehicles in HK with Exhausted-free Electric Scooters, Electric Bus, Electric Medium Goods Vehicles & Electric Vans



Cycling Track

- 1400m cycling track from the Northern MTR exit to Area 39 as a green alternative of transport across campus



2.5 Conserving places of value

The CMP recommends the establishment of a methodology for identifying places with unique values that should be conserved; and assess the implication of any intervention to a 'Place with Culture Significance'. This helps to enhance and extend the identity of the University while maintaining coherence in the campus environment.

Preserving WeiYuan Lake 未圓湖 Genius Loci for Chung Chi College

The luxuriant campus is home to over 200 plant species including over a third of all tree species in Hong Kong



Preserving Habitats

CUHK is home to variety fauna 131 bird species are recorded on campus, representing about 30% of the 448 species in HK



Minimising Tree Removal

The Jubilee Garden had its design modified in 2013 to preserve existing trees in situ



2.6 A landscape of vital importance

The CMP promotes a green and humanistic framework to promote the enjoyment of the landscape and visual amenity of the surroundings by creating a comprehensive open space network within the campus. The Landscape Strategy Plan recommends the treatment of different types of landscape zones, identifies new nature trails within the campus to enhance the greenery and to supplement hard landscape works.

Under the steering of the Campus Development Office and Campus Landscaping Enhancement Committee, a new round of Campus Landscape Master Plan studies is being carried out with consultants to review the landscape opportunities and constraints, and to refine the strategy and plan for sustainable development.



3. SUSTAINABILITY ACHIEVEMENTS AND AWARDS

ACHIEVEMENTS

2016

- **FuturArc Green Leadership Award 2016**
(Merit Award - Institutional for Library Extension)
- Recognised as Hong Kong Green Organisation, HKAEE

2015

- **Green Building Awards 2014 for 4 CUHK projects**
- 'U Green Awards 2014-15' from UMagazine

2014

- **2009 & 2014 Gold Awards for (Sectoral Award - Public Organization and Utilities), HKAEE**
(CUHK is the 1st public organisation that has won the gold award, and won it twice)
- 'U Green Awards 2013-14' from UMagazine

2013

- **FuturArc Green Leadership Award 2013**
(The WINNER - Institutional for An Integrated Teaching Bldg)

2012

- **Merit Award of the Commendation Scheme on Source Separation of Commercial and Industrial Waste from EPD**

• Various years of Class of Excellence, WasteWiSe Label & EnergyWiSe Label, HKAEE

Platinum / Gold rating for 11 new building projects

	<ul style="list-style-type: none"> • Library Extension Building • FuturArc Green Leadership Award 2016 – Merit Award • Green Building Award 2014 – Merit Award • HK-BEAM 2013 – Platinum • Indoor Air Quality Certification 2014 – Excellent
	<ul style="list-style-type: none"> • An Integrated Teaching Building • Green Building Award 2014 – Merit Award • FuturArc Green Leadership Award 2013 • HK-BEAM Plus – Provisional Gold
	<ul style="list-style-type: none"> • Wu Ho Man Yuen Building & Yasumoto International Academic Park • HK-BEAM 2015 – Platinum • MIPIM Asia Gold Award - BEST Urban Regeneration
	<ul style="list-style-type: none"> • Student Hostel for Wu Yee Sun College • Green Building Award 2014 – Finalist • HK-BEAM 2014 – Platinum • Indoor Air Quality Certification 2014 – Excellent
	<ul style="list-style-type: none"> • Student Hostels Block A3 & A4 in Area 39 • Green Building Award 2014 – Finalist • BEAM Plus v1.1 for New Buildings
	<ul style="list-style-type: none"> • Student Hostel for C.W. Chu College • HK-BEAM 2015 – Platinum
	<ul style="list-style-type: none"> • Student Hostel for Lee Woo Sing College • HK-BEAM 2013 – Provisional Gold
	<ul style="list-style-type: none"> • Lo Kwee-seong Integrated Biomedical Sciences Building • HK-BEAM 2013 – Platinum • Indoor Air Quality Certification 2013 – Excellent
	<ul style="list-style-type: none"> • Pommerenke Student Centre • HK-BEAM 2013 – Gold • Indoor Air Quality Certification 2014 – Excellent

4. NEW CHALLENGES AHEAD

Universities are complex organizations with multiple roles and functions. They are not institutions of higher learning where knowledge is created, disseminated and exchanged; but also communities both consuming and supplying services from and to industry, corporations and professions. At the same time, the increasing mobility of students, rising interflow of the world populations, advancement in information and communication technologies, enhanced human connectivity have shifted the traditional geographical boundaries of industries and transformed the higher education landscape globally.

For CUHK to stay competitive, face new challenges and excel, we shall require a world-class environment that supports the academic endeavours in the information age through strategic allocation of human, financial and physical resources. Our goals are to foster a sustainable campus with professional design and management of our facilities and infrastructure to support the University's strategic developments.

CUHK has lately received the Green Building Award 2016 (Merit Award in Green Building Leadership Category) from the Hong Kong Green Building Council in recognition of her commitments in sustainable campus planning and Green Building design. To meet the tough challenges ahead, some key strategies for continuous research and development are as follows:

- Enhance campus infrastructure and facilities to support new university initiatives;
- Build and maintain a green and sustainable campus to meet challenges in Hong Kong and globally in the post-COP21 era;
- Use space more efficiently to promote social and academic exchanges and to meet new teaching and research needs;
- Strengthen IT infrastructure and governance for e-learning, effective data sharing and management;
- Promote green living for the university community; and
- Pursue advancements in sustainability planning and design through knowledge transfer, research and development.

REFERENCES

- [1] CUHK Strategic Plan 2016-2020
- [2] Images and Tables courtesy of: CDO, CPSO, ISO, EMO & WS College of CUHK
- [3] Presentation for HKGBC Green Building Award 2016 – Green Building Leadership
- [4] The Chinese University of Hong Kong, Campus Master Plan Report, January 2010

Stepping Up to the Water-Energy Nexus Challenges at Tai Po Water Treatment Works

Jeffrey LAI Siu-ming^a, Alan MAN Hoi-leung^b, Henry MAK Kei-choi^c

^a Water Supplies Department, Government of the HKSAR, Hong Kong SAR, siu_ming_lai@wsd.gov.hk

^b Black & Veatch Hong Kong Ltd., Hong Kong SAR, manhl@bv.com

^c Beexergy Consulting Ltd., Hong Kong SAR, henry.mak@beexergy.com

ABSTRACT

The expansion of Tai Po Water Treatment Works (WTW) forms part of the overall strategy to enhance the resilience of water supply in Hong Kong. The project involves upgrading the existing water treatment facilities and constructing additional components in order to increase the output capacity of the WTW from 400 Million Litres per Day (MLD) to 800 MLD. Tai Po WTW incorporates sustainable features in the existing and new water treatment facilities, particularly in the aspects of water management and energy efficiency.

Alternative water sources (such as rainwater, grey water and used sample water, etc.) will be exploited to minimize use of potable water in the WTW. Rainwater and sampling water from the water treatment process will be collected for use in landscape irrigation, toilet flushing and cooling tower in the WTW. A life cycle cost analysis has been conducted to confirm the economic viability of using the alternative water sources.

The water treatment process and delivery of fresh water produced from the WTW to the customers is electricity-consuming. Tai Po WTW is designed to provide a gravity flow conveyance system in the treatment process in order to minimize energy use. High efficiency pumps are used for conveying fresh water to service reservoirs and service water for dosing chemicals in the treatment process. A water energy model has been made to compare the energy intensity of Tai Po WTW against the benchmarks established by the Electric Power Research Institute (EPRI) and the Water Research Foundation (WRF) regarding the energy consumption in the production of fresh water from municipal water treatment works. The comparison shows that the energy performance of Tai Po WTW is on a par with the best performing water treatment works in the world.

Keywords: Tai Po water treatment works, energy, water management

1. INTRODUCTION

Tai Po water treatment works (WTW) and Sha Tin WTW are two major WTWs in Hong Kong, of which the total treated water output serves over 3 million people. As Sha Tin WTW has been in service since the 1960s, Water Supplies Department (WSD) plans to carry out in-situ re-provisioning of Sha Tin WTW. To maintain reliable water supply in the territory during the partial shutdown of Sha Tin WTW for re-provisioning, it is necessary to carry out the Tai Po WTW Expansion Project to increase its treatment capacity from 400 million liters per day (MLD) to 800 MLD. Upon completion of the expansion works, with the increased treated water output capacity, Tai Po WTW can take up part of the existing load of Sha Tin WTW for supplying fresh water to significant parts of Kowloon, Central and Western districts of Hong Kong Island (see Figure 1). This will pave the way for the in-situ re-provisioning of the Sha Tin WTW. Over the long term, the expansion will allow a more balanced distribution of treatment capacity territory-wide and enhance the reliability and flexibility of the water supply in Hong Kong. In addition, WSD targets to improve the treated water quality of the expansion treatment facilities by using ozone to achieve 4-log inactivation (i.e. 99.99% inactivation) of cryptosporidium and giardia.



Figure 1: Supply zone of Tai Po WTW

Apart from meeting the water supply objectives mentioned above, since sustainable development is gaining greater awareness and of interest to the people of Hong Kong, WSD aims to set a good example to the community by incorporating various sustainable features in the existing and new water treatment facilities of Tai Po WTW under the expansion project, particularly in the aspects of water management and energy efficiency.

2. WATER MANAGEMENT

2.1 Introduction

Water is one of the most treasurable resources. Therefore, as the government department responsible for the water supply in Hong Kong, WSD attributes significance to water management in the Tai Po WTW Expansion Project.

In Tai Po WTW, a considerable quantity of sludge (i.e. the residual removed from the raw water during the treatment process) is generated every day. The sludge still has high water content. To minimize the loss/ wastage of water, the sludge is designed to undergo further treatment so as to collect the water in the sludge and return it to the inlet for re-treatment.

Furthermore, WSD carried out a comprehensive study on the feasibility to use alternative water sources for the non-potable applications including landscape irrigation, toilet flushing and cooling systems in Tai Po WTW. Some possible alternative water sources in Tai Po WTW include (a) raw water or partially treated raw water, (b) rainwater, (c) ground water and (d) used sample water. The study revealed that rainwater and used sample water were two alternative water sources which were technically and economic viable for non-potable applications. More details regarding the alternative water sources are discussed in paragraphs 2.2 – 2.7 below.

2.2 Rainwater

A rainwater harvesting system will be installed in Tai Po WTW. There are many design considerations for the rainwater harvesting system. For example, the harvesting areas must be restricted to clean surfaces, like building roofs, to ensure that only relatively simple treatment are required for harvesting rainwater. In addition, the quantity of rainwater harvested will depend on the harvesting area and the seasonal variation of rainfall. Too small a system may not be cost-effective while too large a system may incur high maintenance cost and become a wastage during the dry season. The system should therefore be designed to an optimized capacity with thorough consideration of the site constraints, rainfall variation and cost.

2.3 Used sample water

For monitoring the quality of the treated water against the required standards, sample water will be taken from various locations of the treatment process for analysis. Excess or uncontaminated sample water will return back to the treatment process. Sample water which is highly contaminated after analysis will be disposed of, while slightly contaminated sample water will be used for non-potable applications. A schematic diagram showing of the conveyance and collection arrangement of the sample water is shown in Figure 2 below.

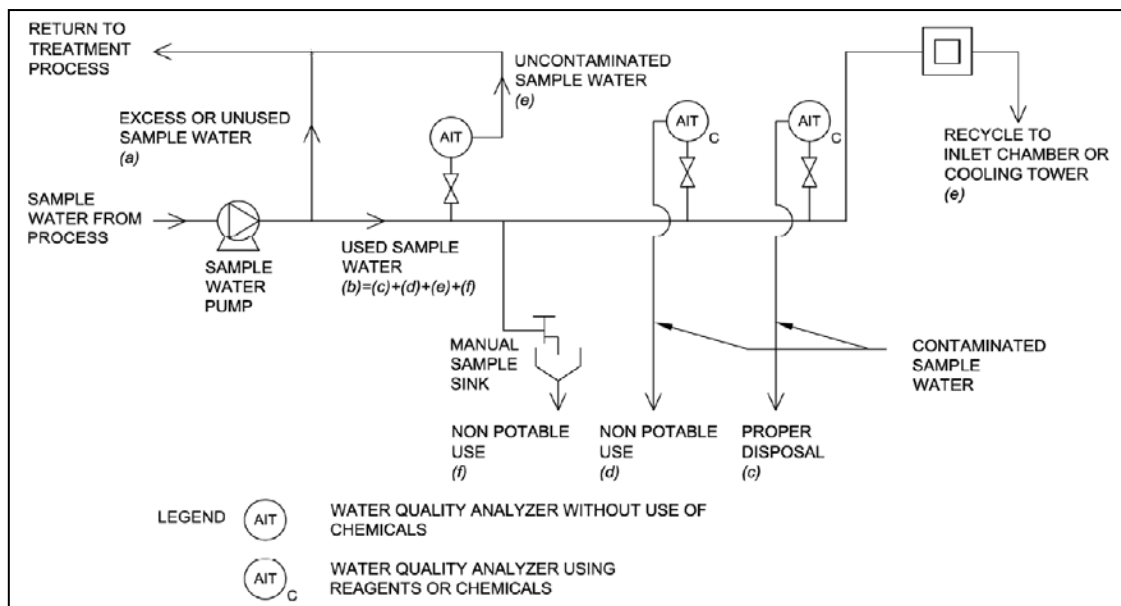

Figure 100: Conveyance and collection arrangement of sample water

2.4 Water use for irrigation

The total proposed landscaping area in Tai Po WTW is about 10,000 square metres (m²). The estimated total daily water demand for irrigation of the landscaping area is about 75 cubic metres (m³).

With reference to the rainfall statistics from the Hong Kong Observatory between year 1980 and 2010, the irrigation water requirement is determined based on the following assumed annual rainfall pattern:

- About 40 percentage (%) of the days in a year with rainfall exceeding 7.5 millimetres (mm) (i.e. heavy rainy days);
- About 15% with no rainfall (i.e. no rain days); and
- About 45% with average rainfall of 3.1 mm (i.e. moderate rainy days).

In heavy rainy days, no further irrigation to the planters is required. In no rain days, no rainwater can be harvested and used sample water will be used for irrigation. In moderate rainy days, the rainwater harvesting system will collect rainwater for irrigation. Due to the limitation of the sizes of the storage tanks, only 10.5 m³ rainwater can be harvested. The deficiency will be provided by used sample water.

For landscape irrigation application in Hong Kong, the quality of irrigation water must meet the public health requirements. These requirements impose limits on: biological oxygen demand, suspended solids, e.coli, pH and also residual chlorine. E. coli levels need to be kept at non-detectable level, with a total chlorine residual to minimize health risks due to usage with proximity to human contact and aerosols that can be inhaled. Therefore, a small water treatment package is provided to treat the harvested rainwater and used sample water before being used in irrigation. The package is comprised of strainer, storage tank, UV sterilizer, chlorinator, sand filter and irrigation pump and pressure tank unit.

2.5 Water use for cooling

Water for cooling system is another non-potable application in Tai Po WTW. There are cooling towers in the Administration Building and Ozone Generation Building (OGB). Sample water from clarity bowls will be conveyed to the cooling tower at the Administration Building. Harvested rainwater and used sample water collected from various treatment process buildings will also be conveyed to the cooling tower at the OGB. The estimated quantity of water reused in these cooling towers is around 75 m³ per day.

2.6 Water use for flushing

Both harvested rainwater and used sample water will be used for flushing purpose in Tai Po WTW. Compared with irrigation and cooling, the quantity used for flushing is relatively small.

2.7 Life-cycle cost analysis

A preliminary life-cycle cost analysis has been carried out to determine the cost effectiveness of rainwater harvesting and reuse of used sample water. The total annual water saving of the rainwater harvesting and used sample water recycling systems is about 47,000 m³ and the estimated payback period is around 20 years.

3. ENERGY EFFICIENCY

3.1 Energy efficient features

Generally, one of the major energy consumptions in WTW is pumping energy. To minimize the pumping energy, a gravity flow conveyance system for the treatment process should be adopted as far as possible. Tai Po WTW is located within a limited footprint on a hill. A multi-level configuration approach for the treatment process is adopted to maximize land utilization. The multi-level configuration approach is to stack a number of treatment units on top of each other (see Figure 3), which poses additional difficulty on the design of the treatment process. With the endeavour of the WSD project team, a one through gravity flow conveyance system with only one pumping station at the end is provided in Tai Po WTW. The pumping station pumps the treated water from Tai Po WTW to service reservoirs located in Kowloon.

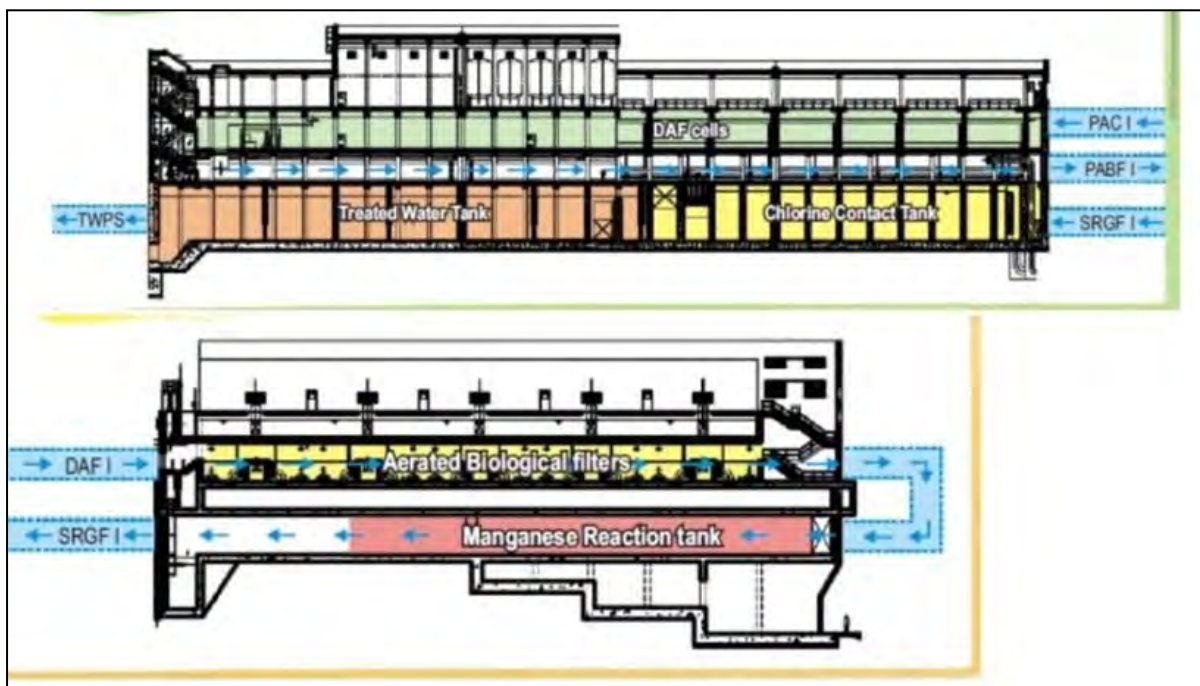

Figure 3: Multi-level configuration approach

The hydraulic profile for Stream II is illustrated in the schematic drawing attached in Appendix A. The high level at the inlet chamber is about 107.30 metres above Principal Datum (mPD) and the low level at the suction culvert of the treated water pumping station is down to 94.80 mPD. In addition, pumps with high efficiency will be adopted in the treated water pumping station of Tai Po WTW. A special coating instead of the standard epoxy coating will be applied to the internal surface of the treated water pumps to further improve the efficiency.

Other energy saving features in Tai Po WTW include:

- Light Emitting Diodes (LED) lighting will be used in the new buildings in Stream II to replace the existing lighting in Stream I progressively.

- Variable Speed Pumps will be adopted for different types of pumps in the treatment process, such as backwash pumps, filtrate transfer pumps, sludge thickener feed pumps, etc;
- Security and area lighting will be modified to achieve zone control and dimming control;
- Building and Energy Management System will be installed to control and monitor the building services; and
- Photovoltaic panels will be installed on the roof of the new buildings to generate electricity for use in the WTW.

3.2 Water energy model

To determine whether the operation of Tai Po WTW is energy efficient and what improvement can be made, the project team conducted a benchmarking exercise to compare the energy consumption of Tai Po WTW with other water treatment works around the world.

The Final Report on Electricity Use and Management in the Municipal Water Supply and Waste Industries (The EPRI Report 2013) [1] published in 2013 by the Electric Power Research Institute (EPRI) and the Water Research Foundation (WERF) provides a benchmark for comparison with the performance of Tai Po WTW. In 1996, a joint study was carried out by the EPRI and WERF. The results published describe the link between water and energy; how electricity is used in the water/wastewater industries and how the facilities are managed efficiently. In 2013, the report was updated to take into account new treatment process options using a bottom up approach in determining the Energy Intensity (EI) values (in kWh/million gallons/day) for various water supply unit processes. The EPRI Report 2013 used engineering judgement and was cross-checked with actual water/wastewater treatment plant data in the United States. The EPRI Report 2013 highly recommended that any water treatment plant could be benchmarked against a database of known values, thus providing a valid comparison.

The EI values of various unit process of Tai Po WTW operated at 800MLD (i.e. both Stream I and II are under operation) is determined by projecting the actual operation data of the existing Stream I as well as making reference to the technical information of the proposed equipment used in Stream II. A comparison is made with the data in the EPRI Report 2013. A summary of comparison is shown in Table 1.

	EI values of Stream I & II of Tai Po WTW based on flow at 800MLD		EPRI Report 2013 EI values at 800MLD	
Treated Water Pumping	63,049	43.5%	168,126	55.1%
Processes	69,593	47.9%	98,498	32.3%
Building Services	12,471	8.6%	38,174	12.6%
Total	145,113	100%	304,798	100%

Table 1: EI values of Stream I + II of Tai Po WTW vs. the EPRI Report 2013 data

Using the EPRI Report 2013 data as a baseline, Tai Po WTW appears to be more energy efficient. When the expansion project is completed and Stream II is put into service, actual EI measurements will be carried out to verify the above results.

4. CONCLUSION

With the above-mentioned water management and energy efficient features and other environmental enhancement works in the Tai Po WTW expansion project, WSD will apply for assessment under the Building Environmental Assessment Method (BEAM) Plus aiming at accreditation to achieve the gold or above rating in the planning, design, construction, commissioning, management, operation and maintenance of buildings of the WTW.

WSD anticipates that Tai Po WTW can serve as a good example for promoting sustainable infrastructure development.

5. APPENDICES

Appendix A - Hydraulic Profile of Stream II

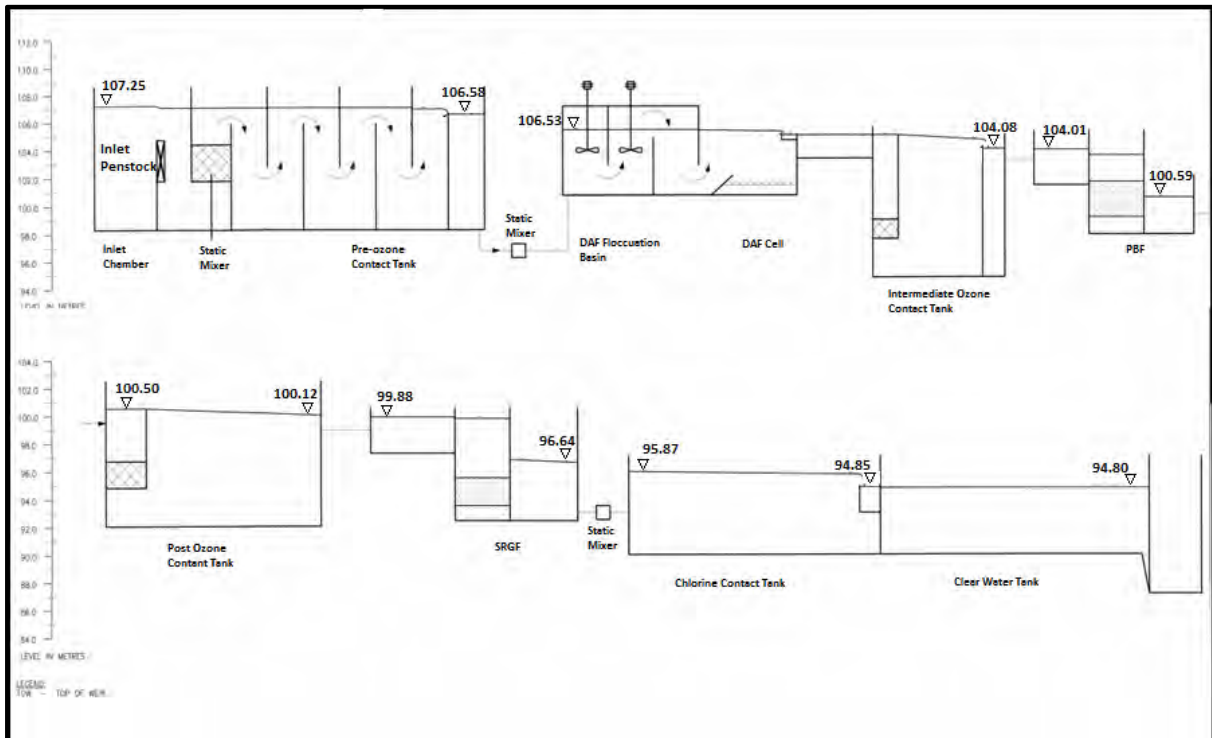

REFERENCES

- [1] BOECKER, J. HORST, S. KEITER, T. LAU, A. SCHEFFER, M. TOEVS, B. REED, B. (2009) The Integrative Design Guide to Green Building: redefining the practice of sustainability. John Wiley & Sons Ed., 2009

Development Strategies for The Green Industry in Pingtung County

KUO Wu-wei^a, HSU Wen-chi^b, CHANG Kuei-feng^c, WANG Yu-jie^d

^a Pingtung County Government, Taiwan, a001549@oa.pthg.gov.tw

^b Pingtung County Government, Taiwan, a000466@oa.pthg.gov.tw

^c Pingtung County Government, Taiwan, a001811@oa.pthg.gov.tw

^d Pingtung County Government, Taiwan, a001642@oa.pthg.gov.tw

ABSTRACT

The ample sunlight in Pingtung County is advantageous for the development of its photovoltaic industry. Pingtung County Government, in recent years, has proactively developed green energy, including efforts to promote the Aqua Solar Farm program, the installation of photovoltaic systems on rooftops of public buildings and schools, green architecture, etc. What's more, the government established Taiwan's first and only floating solar power station on a detention pond in early 2016. As of the present time, a total renewable energy generating capacity of 125 MW has been installed in Pingtung County, and an annual growth of 50 MW is expected.

In addition, an intelligent green and energy efficiency industry cluster is forming in the Pingtung Export Processing Zone, which coupled with the Liukuaicuo Industrial Park to be established in the near future, will position Pingtung as Southern Taiwan's stronghold for the development of this industry. In light of this, the "Intelligent Green and Energy Efficiency Industry Guidance Project" was initiated to further strengthen the soft power of local industries. To assist Pingtung-based businesses with industrial transformation and development, this Project focuses on four approaches: 1. value-added application and promotion of green and energy efficiency technologies; 2. joint development and promotion of technologies and services; 3. establishing an innovative system for the application of intelligent green and energy efficiency technologies, and providing guidance on the system; and 4. designing intelligent green and energy efficient products and providing guidance for innovative services, in the hope of boosting the development of local green and energy efficiency industry, and in turn facilitating the formation of local industry clusters and R&D alliances.

Keywords: energy use, energy saving, green industry

1. INTRODUCTION

In recent years, global warming has had a significant impact on climate patterns. In light of this problem, countries around the world have actively invested in the expansion and promotion of the green energy industry, bringing huge business opportunities for its respective sectors. Due to its limited natural resources, a significant portion of **Taiwan's energy supply is reliant on imports from other countries. In addition, faced with the decommissioning of its Maanshan Nuclear Power Plant in 2025, the possibility of a gap in Taiwan's energy supply chain has become a challenge which is confronting both the central and local governments.** In 2009, Typhoon Morakot inflicted severe damage upon Pingtung by flooding nearly 1,075 hectares of aquaculture facilities and leaving several townships and villages without electricity for as long as two months. Pingtung County Government implemented the "Aqua Solar Farm Program" (Figure 1) to provide guidance for the upgrading and transformation of the fish farming industry, which has been relying on groundwater for lengthy periods. Pingtung County Government also **established the "Guangtsai Wetland" green energy demonstration zone in Pingtung's Linbian Township, hoping to nurture the development of green energy-related industries such as photovoltaic power, marsh gas, wind power, biomass energy, and fuel cells.** In addition to the Guangtsai Wetland green energy demonstration zone, the **government also established Taiwan's first floating solar power station on a detention pond in 2016 at Jiadong Township's Dawuding Pumping Station (Figure 2).** The government continues to push for the establishment of related facilities.



Figure 1: Aqua solar farm program facilities



Figure 2: Taiwan's first floating solar power station

Furthermore, Pingtung County Government plans to establish the “Pingtung County Liukuaicuo Industrial Park”, and has selected a property consisting of 19.75 hectares located to the south side of the Pingtung Export Processing Zone founded by the Ministry of Economic Affairs. Through the development of this industrial park, it is hoped that companies related to renewable energy will be attracted to set up offices in the park. By collaborating with the Pingtung Export Processing Zone, a green energy supply chain is expected to be built, thereby forming a cluster effect for the industry.

2. PINGTUNG'S STRATEGY FOR DEVELOPING ITS GREEN ENERGY INDUSTRY

Pingtung possesses many natural advantages for developing its green energy industry. The county is exposed to abundant sunlight throughout the year, reaching as many as 2,400 hours in terms of sunshine duration – ranking it second in Taiwan in 2015. The powerful katabatic winds which blow from October to April provide a source for generating wind power. Pingtung County also boasts the second longest coastline among all the counties in Taiwan, being adjacent to major bodies of water such as the Pacific Ocean, the Bashi Channel, and the Taiwan Strait. The strong Kuroshio Current is also a possible source for ocean current energy. In addition to the aforementioned natural resources available within its environment, one of the biggest advantages Pingtung County has for developing a renewable energy industry is its solid foundation in agriculture – the abundance of kitchen waste and manure from farm animals facilitates the development of marsh gas power and biomass energy utilization.



Figure 3: Pingtung county government establishes the green energy project office

Actively complying with the central government's green energy policies, the Pingtung County Government established the Green Energy Project Office (Figure 3) to manage the achievements and results obtained from the implementation of green energy projects by county government agencies. It establishes a platform for communication and coordination, creating a single-window system to accept inquiries, provide investment for green energy industries, offer services for the installation of green energy facilities, and assist in overcoming administrative obstacles. The project office has set a goal of installing 58.5 megawatts (MW) of renewable energy facilities in 2016-2017, as well as creating 234 employment opportunities, and 300 millions output value per year. We seek to promote renewable energy diversity.

In addition to establishing the Green Energy Project Office to actively promote renewable energy policies, the **Pingtung County Government drafted the "Pingtung County Self-governing Ordinance on Green Buildings" in 2016**, seeking to promote the installation of solar panels on townhouse communities and apartment buildings. Apart from publicly-owned buildings and schools, the ordinance requires that publicly-owned factories and new buildings intended for public use must abide by green building regulations. Furthermore, the number of pig farmers in Pingtung County comprise one-fourth of Taiwan's total population. To avoid the pollution of water bodies and air by the large volume of animal waste created daily, Pingtung County Government has recently been working on utilizing the marsh gas produced from the wastewater discharged from pig farms to generate power.

Based on the above, the types of renewable energy promoted by Pingtung County Government include solar power, marsh gas power, and ocean current power. The location for the placement of solar panels includes poultry houses, farm facilities, green buildings, publicly-owned buildings, and schools; the primary location of marsh gas production are livestock farms; and for ocean current power generation, the electricity-generating equipment will be placed in the sea in the vicinity of Eluanbi Lighthouse – along the path of the Kuroshio Current. The following table contains information on the types of renewal energy generators, locations for deployment, and objectives regarding **Pingtung's green energy policies**:

Type of Renewable Energy	Location	Installation Objective for 2016 (MW)	Completed as of Sept. 19, 2016	
			MW	(%)
Solar Power	Poultry Houses	30	8.7	29%
	Other Farm Facilities	20	6.85	34.25%
	Green Buildings, Publicly-owned Buildings, Schools	5	8.234	164.68%
	Detention Ponds,	1	0.5	50%
Marsh Gas Power	Livestock Farms	1	0.015	1.5%
Ocean Current Power	Sea near Eluanbi Lighthouse	1.5	0	0%
Total		58.5	24.389	41.69%

Table 1: Green energy project office renewal energy equipment type, deployment location, and objective

3. GREEN ENERGY PROMOTIONAL PLAN AND CONTENTS

Through a short-term 4-year plan running from 2016 to 2020, Pingtung County Government is investing effort in the promotion of solar power, marsh gas power, and ocean current power. Each year, it sets the objective of installing renewable energy generation equipment with a combined capacity of 50 MW. Some of the proactive measures include: (1) Coordinating with the green energy policies of central government agencies by establishing the Green Energy Project Office to determine the county's vision, goals, and strategies for relevant green energy projects; (2) Drafting the division of duties and responsibilities regarding affairs related to the promotion of green energy policies for agencies and institutions affiliated with Pingtung County Government in order to duly supervise the promotion carried out by the affiliates; (3) Constructing a platform for communication and coordination, as well as the management and tracking of annual objective achievement rates; (4) Establishing a single-window system to accept inquiries, provide investment services for green energy industries, offer services for the installation of green energy facilities, and assist in overcoming administrative obstacles; (5) Handling affairs such as researching

and providing suggestions on regulations related to green energy, industry technology, along with market surveys, assessment, and analysis; (6) Formulating regulations governing subsidies and incentives for promotions related to green energy projects; (7) Drafting memorandums and proposals for promoting green energy policies to secure funds and subsidies from the central government; (8) Organizing promotional campaigns and investment seminars related to green energy projects.

In the long run, Pingtung County Government seeks not only to develop new energy sources, but also to promote energy conservation. In the future, it will continue to implement policies such as solar power, ocean current power, stream current power, marsh gas power, and wind power. It will also assist in the development of different kinds of green energy technology, integrating different fields to achieve the most effective results through synergy. The promotion of energy conservation policies will also start with Pingtung County Government. This involves the planning of energy measures in line with local characteristics, seeking to gradually change the electricity-use habits of county residents, thereby establishing a trend for energy conservation. The government also encourages the decommissioning and replacement of high energy-consumption equipment to reduce the load on Pingtung County in the coming years. Hopefully, by working in coordination with measures on both the supply and demand side, the county is expected to achieve its vision of a 2025 carbon-emission-free Pingtung.

4. CONCLUSION

In recent years, through approaches such as strengthening microgrids, generating electricity using marsh gas, and the Aqua Solar Farm Program, Pingtung County Government is gradually implementing its objective of promoting green energy. In the future, it will continue to boost the volume of green electricity by continuing to develop diversified renewable energy sources such as aqua solar farms and marsh gas power generation. By introducing the development of composite energy-generation – ocean current power and stream current power generation – which coexists with agriculture and aquaculture, Pingtung County Government seeks to become home to sustainable green energy development in the future.

REFERENCES

- [1] Chiang, C. P. and Pan, H. C., 2016. Aqua Solar Farm Program: Tsai Ing-wen: Pick up the Pace and Follow the Footsteps of the Private Sector. United Daily News (February 19, Reporters: Chiang Chi-ping, Pan Hsin-chung). Retrieved from <http://udn.com/news/story/9485/1511209>
- [2] Lin, R. Y., 2015. Aqua Solar Farm Program: Rekindling a New Opportunity for Pingtung's Fish Farming Industry. WANT Daily Special Report (December 15, Reporter: Lin Rwei-yi). Retrieved from <http://www.chinatimes.com/newspapers/20151215000889-260301>

Strategic Planning for Sustainable Neighbourhoods: A Case Study from Palestine

Sameer ABU-EISHEH^a, Muhannad HAJ HUSSEIN^b, Deemah SALAMEH^c

^aAn-Najah National University, Palestine, sameeraa@najah.edu

^bAn-Najah National University, Palestine, haj_mj@hotmail.com

^cAn-Najah National University, Palestine, deemah_salameh@yahoo.com

ABSTRACT

Since the establishment of the Palestinian National Authority in 1994 on parts of the West Bank and Gaza, considerable developmental efforts have been observed. New neighbourhoods have evolved in order to cope with lifting the zoning restrictions put previously for decades by the Israeli occupation authorities, overcome the shortage in dwelling stock, and satisfy the demand for providing residential space for citizens and hundreds of thousands of Palestinian returnees from abroad. In the emerging State of Palestine, there are considerable limitations of land that could be used for development, scarcity of energy, water, and material resources, in addition the environmental pollution, persistent economic challenges, and new lifestyle trends. These factors need to be considered in planning and developing of the neighbourhoods. This paper aims to identify the strategic framework that will guide the efforts that will assist in achieving the goal of having sustainable neighbourhoods in Palestine. Sample regional and international sustainable neighbourhood planning and development efforts have been investigated. Strategic planning approaches have been utilized as related to neighbourhood development in Palestine, where SWOT analysis has been conducted to derive the strengths and weaknesses, as well the opportunities and threats, in order to lay the foundation to identify the most important issues that should be tackled in the strategic framework. Moreover, the focus group approach has been adopted and case study has been conducted in order to evaluate the ability of the stakeholders to set policies, plan, design, and implement sustainable neighbourhoods. Consequently, the strategic goals and objectives and the strategic framework highlighting the strategies and actions that need to be implemented over the medium term, whether related to setting policies, regulations, planning guidelines, and design standards, are set, where responsibilities have been proposed. The resulting strategic planning framework would guide the efforts to realize sustainable neighbourhoods in Palestine.

Keywords: sustainable neighbourhood, strategic planning, palestine

1. INTRODUCTION

The neighbourhood is a basic planning entity in modern residential planning theories. However, the literature demonstrates different approaches that tackle the application of sustainability to neighbourhoods. The Egan Review (Office of the Deputy Prime Minister, 2004) highlights sustainable communities as those which “meet the diverse needs of existing and future residents, their children and other users, contribute to a high quality of life and provide opportunity and choice. They achieve this in ways that make effective use of natural resources, enhance the environment, promote social cohesion and inclusion and strengthen economic prosperity”.

In the recent years, there has been increasing interest in sustainable communities. In its proposed new strategy of sustainable neighbourhood planning, UN-Habitat (2014) has suggested five principles to be considered to achieve sustainable neighbourhood. These include adequate space for streets and an efficient street network, high density, mixed land-use, social mix, and limited land-use specialization.

Numerous studies have been published addressing sustainable communities, sustainable development, and sustainable neighbourhoods. These have illustrated the concepts, policies, and applications of sustainability in developed and developing countries. Research has been published illustrating regional experience in this context as well. However, the concept of sustainable communities and its application to the neighbourhoods in Palestine is relatively new.

The Palestinian Higher Green Building Council (PHGBC) was established in 2010. It aims to encourage green and sustainable architecture and building in Palestine by introducing the main green building design strategies through their published guidelines (Palestinian Higher Green Building Council, 2013) and capacity building programs.

2. NEIGHBOURHOOD DEVELOPMENT IN PALESTINE

The establishment of the Palestinian National Authority (PNA) on parts of the West Bank and Gaza in 1994 had led to massive developmental efforts by the Palestinians in order to deal with the challenges inherited due to 27 years of Israeli occupation. The Palestine Liberation Organization (1994) has prepared the first Palestinian Developmental Plan for the period 1994-2000. The plan gave priority to correct the distortions caused by the occupation, especially in the infrastructure and the housing sectors. The Ministry of Public Works and Housing, established after the formation of the PNA, has the primary responsibility of the management and implementation of national infrastructure and publicly supported or managed housing.

The Palestinian Housing Council (PHC) was formed in Jerusalem in 1991, slightly before the establishment of the PNA, as a non-profit organization, dedicated to help alleviating the shortage of housing and contribute to the development of the housing sector, by providing long-term loans for housing projects. However, the private sector and individual investors have been leading most of the residential development in Palestine. Official statistics indicate that about 60% of the households own their housing units, which they obtain mainly through their savings, and secondarily through loans from banks (Palestinian Central Bureau of Statistics, 2009). Based on the estimates for 2015, about 548,100 Palestinian households are in need of housing over the next decade. It is expected that the cumulative deficit at the end of 2019 will reach about 294,000 housing units (Abu Obaid, 2013).

New housing projects have evolved in order to cope with lifting the zoning restrictions put previously for decades by the Israeli occupation authorities, overcome the shortage in dwelling stock, and satisfy the demand for providing residential space for citizens and hundreds of thousands of Palestinian returnees from abroad.

During the last decade, a new trend in housing projects evolved, where neighbourhood-based residential developments start to spread rapidly compared with individual developers building-based developments. In 2006, the first new town in Palestine was established, Rawabi, as an initiative to build a new population centre for Palestinians and as a courageous economic initiative that integrates international best practices for urban master planning, sustainable environmental policy, regionally-suited architecture, and state-of-the-art infrastructure for residents, enterprises, and visitors.

In 2009, Al Etihad neighbourhood near Ramallah was inaugurated as the first integrated neighbourhood in Palestine. After that tens of new neighbourhoods in the suburbs of major Palestinian cities are observed, especially in central area of the West Bank of Ramallah-Al Bireh-Beituniya, including Al Reehan neighbourhood.

3. RESEARCH MOTIVATION AND OBJECTIVES

In the emerging State of Palestine, there are considerable limitations of land that could be used for development, scarcity of energy, water, and material resources, in addition the prevailing environmental pollution, persistent economic challenges, and new lifestyle trends. These factors need to be considered in planning and developing of the sustainable neighbourhoods. It has to be stated that there was recently a study conducted on the process of neighbourhood strategic planning in Palestine, but did not address the sustainability concerns (Fares, 2014).

This paper aims to formulate the strategic framework that will guide the efforts that will assist in achieving the goal of having sustainable neighbourhoods in Palestine. The neighbourhood level is highlighted as numerous developments on such level have been observed during the past few years, and where a number of developers have been considering aspects of sustainable neighbourhoods. The neighbourhood is the unit where the impacts towards sustainable development can be easily realized, compared with consideration of citywide or individual building sustainable development.

The objectives of this paper include the following:

- Analyse and understand the sustainable neighbourhood developmental related issues, especially on the local level.
- Identify sustainable neighbourhood domains and actors in the Palestinian context.
- Formulate a national strategic plan framework for sustainable neighbourhoods.
- Propose relevant recommendations to start implementing the proposed framework.

4. METHODOLOGICAL APPROACH

Strategic planning approaches are utilized in this research as related to neighbourhood development in Palestine. Strategic analysis is conducted first to derive the strengths and weaknesses, as well the opportunities and threats, in order to lay the foundation to identify the key issues that need to be tackled in the strategic framework. In such framework, the goals and objectives to achieve sustainable neighbourhood are formulated based on the analysis outcome, and consequently, strategies and actions are defined.

The followed tools include conducting relevant meetings with focus groups and the developer representatives in a selected newly developed neighbourhood case study in order to evaluate the current conditions and the potentials and threats as related to being a sustainable neighbourhood. Moreover, the approach includes conducting interviews with key stakeholders to understand their viewpoints and assess their ability to set and implement policies, regulations, plans and actions, and execute sustainable neighbourhoods. Figure 1 shows the research methodology.

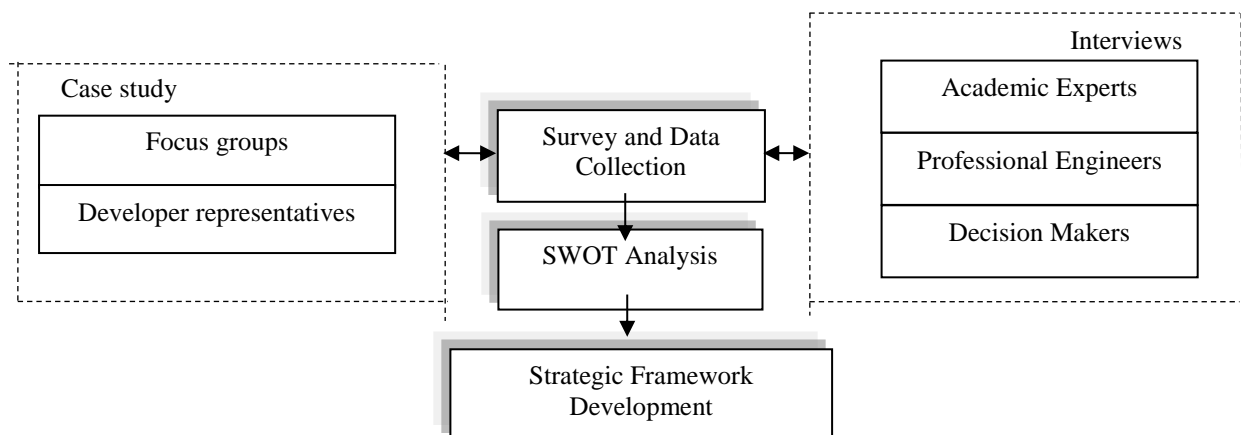

Figure 101: Illustration of research methodology

5. CASE STUDY SETTINGS

For this research, Al Reehan Neighbourhood has been selected as the case study, which is one of the new neighbourhoods where the developer has attempted to adopt and implement sustainability concepts and practices. It is located about 7 km north of the city of Ramallah, at the heart of the West Bank, on a land with area of 250,000 m². It has been developed for the past six years by Palestine Investment Fund (PIF), which is the sovereign development fund for the State of Palestine. It includes about 1800 **housing units, with a variety of apartments'** spaces ranging from 100-260 m² to fit the requirements and capabilities of the various Palestinian income and social groups. It has been designed to accommodate about 8,000 people.

In order to ensure an integrated community, the neighbourhood has been designed to accommodate the key services and facilities needed by the population such as a commercial centre, a school, a kindergarten, a mosque, a park, and a playground. In addition, its unique location has attracted investors to build the largest private specialized hospital in Palestine. Table 1 illustrates the sustainability issues and some of their elements that Al Reehan Neighbourhood has adopted.

Sustainability issues	Sustainable elements	Category	Description
Environmental sustainability	Water	Clean water	Potable new network of 8520m length.
		Waste water	Collection system constructed and a waste water treatment plant installed (closed container system based, with capacity of 500m ³ /day, located in the project lowest point, and minimum pumping system required). Treated water is not used till now in the project.
		Storm water	Special network, collection from streets and buildings' roofs. Collected water not used yet
	Renewable energy	Heated water	All units have solar system for hot water.
		Generating energy	PV system installed for commercial centre, covering 30% of its needs, with ability to be adjust its angle seasonally.
	Transport	Roads network	Different streets widths (14m, 16m, 20m). Internal cul-de-sac streets for social and environmental reasons. Paved pedestrians sidewalks, ability to add bike lanes.
		Public transport	Shuttle bus services exist between the neighbourhood and Ramallah city. No bus stations exist yet.
	Land	Land use	About 40% public space, 30% residential area (multi-storey buildings and villas); 30% green area.
		Materials	Reused the uprooted rocks from the site as gravels for roads and stones for building the residential units.
Economical sustainability	Water		Available system for using storm water and recycled water for irrigating the green areas.
	Energy		Using PV system, thermal insulation.
Social sustainability	People	Social fabric	Different residential unit areas for different family sizes, different social levels, different residential units (100-260m ²) and types (villas and apartments). Strong relationship between residents.
		Public participation	Participation in all decisions related to the neighbourhood, strong loyalty to the neighbourhood.
Political sustainability	Land		Protecting the Palestinian land from confiscation by Israeli occupation.

Table 1: Sustainability issues and elements adopted in al reehan neighbourhood

6. STRATEGIC ANALYSIS

The strategic assessment is based on analytical diagnosis of both the internalities and externalities related to new neighbourhoods in Palestine. The analysis is derived from the outcome of the meetings with Al Reehan Neighbourhood case study developer and focus groups, and the interviews with key actors.

Three meetings were held with the relevant case study parties; a meeting was held with the developer representatives, and two other focus group meetings were held; one with a group of current residents, and the other with a group of prospect residents, who have registered to purchase residential units in the neighbourhood. Interviews were held with academic experts, professional engineers, decision makers, and developers.

SWOT analysis was conducted to guide the identification of the positives and negatives within the internal and external neighbourhood environment, in order to define the key issues, formulate the goals and objectives, and then determine strategies and key actions to ensure achieving sustainable neighbourhoods in Palestine. The analysis was conducted for each of the six domains of the sustainable neighbourhood separately, including energy, air, water, land, transport, and people. Analysis conducted for one example of these, energy, is presented hereafter. The findings of the research, combining the perspectives of developers, key actors, and current and prospect residents, in this regard are illustrated in Table 2.

<p>Strengths</p> <ul style="list-style-type: none"> • Use of solar system for hot water. • Use of solar panels in the commercial centre. • Proper location of the waste water treatment plant with no need for pumping. • The buildings are insulated. • Using a central system for gas utility. 	<p>Weaknesses</p> <ul style="list-style-type: none"> • No use for solar energy in streets lighting. • No utilization of the roofs of the residential and public buildings to install solar panels. • Limited use of environmental friendly products in buildings that reduces energy consumption. • No proper awareness to use energy saving electrical devices.
<p>Opportunities</p> <ul style="list-style-type: none"> • Electricity Sector Organizing Council incentives to encourage renewable energy initiatives. • Favourable environmental factors enabling potential utilization of renewable energy. 	<p>Threats</p> <ul style="list-style-type: none"> • High initial cost for establishing energy friendly systems. • Limited internal support and external fund devoted for sustainability-related development.

Table 2: SWOT analysis for Al reehan neighbourhood case study for the energy domain

7. STRATEGIC PLANNING FRAMEWORK

Based on the outcome of the analytical diagnosis of the related domains for sustainable neighbourhoods in Palestine, the strategic framework is formulated. This framework includes defining the strategic goals and objectives as well as the strategies and actions that need to be implemented over the short- and medium-term are set and presented. These include the strategies and actions related, among others, to setting policies, regulations, planning guidelines, and design standards.

Table 3 illustrates a summary of the goals, objectives, strategies and actions for sustainable neighbourhood defined for each of the considered domains.

The indicated strategic framework illustrate that specific strategies and actions have to be considered and implemented in order to achieve the aim of having sustainable neighbourhoods. To turn such strategies into actions, relevant organizations possess the ability and should have a leading role to lay the foundations towards sustainable neighbourhoods. Such organizations have the potential and the basis needed to lead the change through their organizational knowledge, intellectual capital, and capacity.

The research has laid the basis for a time- and budget-based action plan, in addition to a monitoring and evaluation plan with relevant Performance Indicators (PIs) for the base year and the coming five years to measure the progress towards achieving the goals and objectives stated in the strategic framework.

Goals	Objectives	Strategies	Actions
Clean air and healthy environment	1. Reduced emissions to least possible values 2. Improved quality of internal environment	1. Reduction of pollution sources	<ul style="list-style-type: none"> • Develop the guidelines of the PHGBC for construction of buildings into regulations • Encourage active transportation (walkable and bike-enabling streets) and public transportation • Provide closed and separated containers for trash
		2. Encouraging green concepts	<ul style="list-style-type: none"> • Green open and plantable areas • Plant rain fed trees and fast growing trees • Increase public awareness on greening
	3. Achievement of better internal environment	<ul style="list-style-type: none"> • Design wide and deep windows • Adopt natural ventilation inside buildings • Implement thermal insulation in buildings 	
Efficient energy use	1. Reduced depend-ency on fossil energy 2. Improved efficiency use of energy	1. Increase the share of generated renewable energy	<ul style="list-style-type: none"> • Solicit government and external support of renewable energy projects, and the purchase of surplus produced energy with preferential prices • Use of photovoltaic panels in street lighting • Maximize utilization of efficient solar system in producing hot water • Support using smart energy-saving systems
		2. Decrease energy consumption	<ul style="list-style-type: none"> • Conduct public awareness on the efficient and sustainable energy and use of energy saving electrical devices and bulbs

Goals	Objectives	Strategies	Actions
			<ul style="list-style-type: none"> • Encourage the use of new efficient insulating techniques and materials in buildings
Integrated and cohesion community	1. Strengthened social relations among residents	1. Encourage mixed social levels	<ul style="list-style-type: none"> • Provide various apartment sizes • Develop and support affordable housing • Provide residents with special needs, elderly and kids with proper facilities
	2. Easily reached vital needs	2. Encourage vital needs satisfaction for social infrastructure	<ul style="list-style-type: none"> • Provide public facilities like meeting space, playgrounds, parks, etc. • Provide on-site jobs for the neighbourhood residents • Activate residents committees
Sustainable transport system	1. Improved active transport	1. Achievement of walkable streets and neighbourhoods	<ul style="list-style-type: none"> • Give priority access to pedestrians and cyclists over other vehicles across the neighbourhood • Provide daily needs in walkable distances • Providing neighbourhood public/recreational facilities
	2. Reduced car dependency	2. Encouragement of public transportation	<ul style="list-style-type: none"> • Provide scheduled bus service • Subsidize public transport • Support provision of new buses
Efficient land use	1. Optimized use of land	1. Achieved mixed land use	<ul style="list-style-type: none"> • Provide different functions in the same area • Introduce regulations encouraging optimized land use • Provide interconnected safe and efficient streets
		2. Promotion of high density neighbourhoods	<ul style="list-style-type: none"> • Encourage multi-storey buildings • Encourage the provision of various apartments sizes
Sustainable water system	1. Efficient water use Achieved	1. Increase water harvesting and re-use practices	<ul style="list-style-type: none"> • Encourage building wells for rain water harvesting • Encourage use of treated water in irrigation • Implement systems to separate grey from black water
		2. Reduce water consumption	<ul style="list-style-type: none"> • Conduct public awareness campaigns on water conservation • Support using smart water supply/irrigation systems

Table 3: Goals, objectives, strategies and actions for sustainable neighbourhoods

8. CONCLUSIONS AND RECOMMENDATIONS

This study provides an overall framework that would guide the efforts to realize sustainable neighbourhoods which can be adopted in neighbourhood development in Palestine. Water, energy, air, people, land and transportation are the main domains that are considered in developing sustainable neighbourhoods. Using a case study, as well as interviews with key actors, an attempt is made to identify internal and external positive and negative impact factors, and facilitate the arrival of the proposed strategic planning framework for sustainable neighbourhoods.

It is recommended to adopt this framework after proper debate with the relevant key actors. All involved actors have to be engaged in the detailed strategy development and action plan implementation. First, the relevant ministries such as the Ministry of Public Works and Housing and Ministry of Local Government, the municipalities, and the semi-public institutions, such as the Palestinian Housing Council and the Palestinian Higher Green Building Council, have to exhibit a leading role in supporting sustainable neighbourhoods, through devising relevant policies, legislations, and regulations. Developers and investors should be pioneering in initiatives that will result in sustainable neighbourhoods. Professional societies, such as the Engineers Association, and technical experts need to conduct awareness campaigns and train engineers and planners, as well as developers, on various sustainable neighbourhoods' domains issues.

REFERENCES

- [1] Office of the Deputy Prime Minister, 2004. *The Egan Review: Skills for Sustainable Communities*. Crown, London.
- [2] UN-Habitat, 2014. *A New Strategy of Sustainable Neighbourhood Planning*, retrieved from: http://unhabitat.org/wp-content/uploads/2014/05/5-Principles_web.pdf [Retrieved on 15 September 2016].

- [3] Palestinian Higher Green Building Council, 2013. *Green Buildings Guidelines*. The Association Engineers-Palestine, Ramallah.
- [4] Palestine Liberation Organization, 1994. *The Palestinian Developmental Plan: 1994-2000*. PLO, Tunis.
- [5] Palestinian Central Bureau of Statistics, 2009. *Housing Projections up to 2017*, Ramallah.
- [6] Abu Obaid, M., 2013. *Evaluation of Housing Projects in the West Bank-Case Study in Nablus, Ramallah, and Jenin Cities*. M.Sc. Thesis, An-Najah National University, Nablus.
- [7] Fares, S., 2014. *Neighborhoods Strategic Planning: Directions for Future Development*. M.Sc. Thesis, An-Najah National University, Nablus.

Session 6.8: Sustainable Neighbourhoods - Case Study Review (2)

Urban Regeneration Introduced with Resilient City Concept - A Case Study of Pingtung City in Taiwan

CHANG Kuei-feng^a, LEE Ju-yii^b, NI Kuo-chun^c, PU Po-yen^d

^a Pingtung County Government, Taiwan, a001811@oa.pthg.gov.tw

^b ECG International, ecg@ms14.hinet.net

^c Pingtung County Government, Taiwan, a001189@oa.pthg.gov.tw

^d Pingtung County Government, Taiwan, a250915@oa.pthg.gov.tw

ABSTRACT

The core researcher area for this study is the basins of Gaoping River. This multidisciplinary research project coordinates the history, culture, industry, ecology and community to facilitate green living and sustainable autonomous management community network.

The aim is to renew the usage for air force military villages, adopt green architecture technology and green energy, water resource recycling as well as respond to climate change in hope of constructing a consummate and diversified ecological system for harmonious co-habitation between human and the nature.

The resources in the area can be classified in two streams. In ecological environment, there are around 50 species of birds, 31 species of fish in wetland habitation. In terms of humanities resources, the most important construction is an old iron bridge for steam train built in 1911. It was the longest iron bridge in Asia. The land connecting the iron bridge to the city includes the 44-hectare air force villages engraved with history memory of the bygone era. The main theme for this Oasis program is culture and its role as the ecological nodes between Kaohsiung City and Pingtung, an autonomous management community with a consummate environmental protection system.

The methodology for this research is based on trait analysis and value evaluation. The trait analyses are:

- Landscape trait analysis and evaluation
- Community vitality development and management
- Vision for lifestyle and ecology as well as action strategy

The value evaluation depends on professional platform and citizen participation.

The major results of the program to transform vision to an action strategy combining the public with the government are:

- A basin living circle to restore the dialogue between the river and community
- The trip to trace back the past and reconstruction of historical space and memory place
- Ecological restoration for the river basin and water resource network
- Sustainable resource development implemented by the adaptation of deep rooted action combining public facilities and neighborhood.

Keywords: inclusive eco-design, landscape, Gaoping River

1. INTRODUCTION

The program is part of “four-leaved clover vitality program” of Pingtung City proposed by Vision Integrated Platform Program of Pingtung County. The scope of the program is based on left bank of Gaoping River basin and Liukuaicuo as the core. In the area, there are living, ecological and productive complete life circle of water front wetland, military dependents' village, old iron bridge of Siadanshui River and industrial park. By complete planning, **vital cultural landscape, financial evaluation of operation and residents' participation, it becomes “national” cultural park** in the program to reinforce local characteristics and develop tourism mechanism, result in **residents' resource sharing** and carry out environmental and ecological sustainability.



Figure 1: Scope of plan

Concept of program of cross-field integration is based on five items: connection, stability, highlight, preservation and development. We connect old iron bridge of Kaohsiung City on right bank of Gaoping River and Jiuqutang cultural and tourist path program and integrate rich natural and human ecology to establish cross-field human history, tourism and recreation and environmental education life circle of Pingtung and Kaohsiung. We stabilize basin network and precaution system and construct the theme of Gaoping River basin and human environment based water space to brighten, revive, vitalize and extend water bank network to the communities.

The program preserves human ecology and common historic memory of Gaoping River and coordinates history, humanity, tourism, recreational, historical and cultural landscape and environmental education place. It develops green industry, brand agriculture and welfare and by cross-field integration, it constructs new portal of Gaoping and new site of southern Taiwan planning to establish Gaoping River basin and green jade home.



Figure 2: Concept of program

The following sections propose the thematic and action programs of different phases. By analysis of historic background and current programs, we explore the steps of future execution, methods and expected result to carry out sustainable operation and local spirit.

2. REVIVAL OF BASIN HOME LIFE CIRCLE UPON DIALOGUE BETWEEN RIVER AND TOWN

The program includes Gaoping riverside park, Yun Peng community, Ta Wu Ying area, Pingtung Airport, Pingtung export processing zone, wetland, Siadanshui River old iron bridge and industrial park. It has diverse resources of rich ecology, humanity, history and industry. The integration of left bank of Gaoping River responds to the development of right bank and it enhances the development of the surrounding by total dimension.

According to the unofficial history, during the time **when the iron bridge did not exist, people's life relied on water** and frequently used water channel as important measure of transportation. They could thus approach the river and completely pictured the home in natural environment.

In the area of the program, **in the past, the relationship between people's life and river was close. Nowadays, due** to the issues such as river regulation and prevention of flood and wind disaster, protecting embankments are mostly applied to solve the problems and it separates people, life and water bank. Left and right banks of rivers become the routes for cars passing rapidly and they are distant from the land. Living landscape of basin of river gradually replaces infertile sands and farms of cultivation. Borders of the rivers are restricted by protecting embankments. It becomes difficult to reach the area beyond protecting embankments and the internal and external space of protecting embankments is rigid.

Action program of future basin life circle aims to create the benefits of infrastructure and support, vitalize the river area and reduce the distance from people and environment. Attraction is the priority. It constructs the river environment of ecology, production and life, reinforces the ecological diversity of river and river embankment in the surrounding and introduces the concept of super protecting embankment. Thus, river and people coexist. It is **different from current situation in which people's production is only based on cultivation and breeding. The** attraction and type of activity should respond to current culture and resources. How to connect the rivers with present life circle and coordinate the towns is the significant concern.

It also develops the construction and type of route with low impact on environment. For instance, protective coloration, green protecting embankment, multi-levels planting and ecological technique are applied to landscape protecting embankment design to effectively enhance biological diversity and the playfulness of recreational activities at river bank and protecting embankment. In addition, it introduces green energy based tourist shuttle bus, bike and creates ecology-friendly Green Park Way with low impact to result in positive education place. By route control, it restricts emission and pollution of waste gas, limits the vehicles and promotes green energy transportation. The previous measures will lower the original limit of protecting embankment, connect horizontal resources, maintain ecological environment and function as improvement of vertical lines.

Green Park Way can be the horizontal extension of tourist shuttle bus and bike path. The surrounding towns, resources of left and right banks, culture and industry respond to the nodes of different regions and the cross is at the vertical green protecting embankment. It enhances the association between internal and external space of protecting embankment and establish two-way dialogue. The program installs route guidance system, coordinates transportation and network system and connects mass transportation, p-bike of Pingtung, shuttle bus and parking lot as human-based network which breaks through the boundary between rivers and towns. Upon life, ecology and production, it triggers the development and process of the region.

The action program includes 5 phases: Step 1, future transportation plan and development plan investigation; Step 2, left bank basin and investigation on resource points of towns; Step 3, green park way network program – road reconstruction and extension of protecting embankment; Step 4, integration of related transportation and related measures; Step 5, preparation of infrastructure and support of community and integration of tourist resources. From basic investigation to installation of infrastructure, it creates basin home life circle upon dialogue between river and towns.

3. TRIP TO TRACE BACK THE PAST AND RECONSTRUCTION OF HISTORICAL SPACE AND MEMORY PLACE

The Gaoping River was originally called "Siadanshui River". In 1913, "Siadanshui River iron bridge" with the passing of train was above it and it was the significant construction. After the accomplishment of iron bridge, according to the Japanese official journal, it was "the first long bridge of Japan and it resembles the rainbow in the distance and it was the splendid construction in southern Taiwan".

Nowadays, the Kaohsiung City Government, Pingtung County Government and local people all agree with the cultural and tourist value of old iron bridge of Gaoping River. Besides the planning of two bank wetland park to enhance ecological education and recreational function, it should connect two bank industrial resources and **landscape characteristics by the circulation to recall the residents' spatial memory, vitalize the old iron bridge of Gaoping River and regional economic development.** In 2008, Pingtung County Government accomplished the reuse construction of the part of Pingtung of iron bridge and launched the passing.

As to the part of Kaohsiung of old iron bridge, Kaohsiung City Government finished "integrated planning of development and operation of Gaoping River old iron bridge cultural and tourist path industry" in 2012 and the program coordinates cultural landscape resource and horizontal alliance of local industry from perspective of resource integration of Gaoping River basin and introduces several plans to completely plan and construct the part of Kaohsiung.

In the future, the surrounding of the railway will be planned and changed. Because of the position change of taking off and descending, the construction limitation of the buildings around Pingtung Military Base on the left is liberated **and it will enhance the related development. Air force military dependents' villages around the airport and iron bridge include Lin Yun Three Village and Da Peng Seven Village. The area includes military dependents' villages constructed after the war.** The type of construction and arrangement reveal the significance of time and it is different from another area of Pingtung City. Sheng Li, Zhong Jen New Village are the colonial buildings of the Japanese Colonial Period. **They can be the representatives of military dependents' village of colonial style and after war in Pingtung area.**

Currently, Ministry of National Defense intends to deal with idle land by sales and this program suggests vitalizing **military dependents' villages by land change and volume transfer. With population aging and great number of people moving out, it is one of the issues to remain the history and revive idle land in Gaoping area.** Military dependents' village is between Siadanshui River old iron bridge park and Pingtung City. The location is precious for the saturated town space. Although at present, there are mostly the broken buildings and damaged cultural landscape, we find the possibility of renewal and innovation.

In comparison to Pingtung Military Base on the left and military dependents' village on the east, land of Taiwan Sugar Corporation is currently used for animal husbandry and agriculture. In the future, it will be constructed as green energy industrial park. Siadanshui River old iron bridge park will be an important entrance of the area. The cultural line connects the unchanged cultural land on left bank and future important development area.

The goal is to revive the time and structural aesthetics of the historic interests in order to reconstruct the natural gap of Siadanshui River old iron bridge. It is the connection between left and right banks. In addition, it provides diverse recreational life projects and completely associates construction and resources of left and right banks and it creates the opportunities for the young generation to return to the hometown and change of population and industrial structure. It is the future direction.

The action program includes five phases: Step 1, **investigation on land ownership of air force military dependents' village, Liu Kuai Tso farm of Taiwan Sugar Corporation and the surrounding of railway;** Step 2, reuse of idle land; Step 3, evaluation of vitalization program and the following related measures; Step 4, human-based environment construction of railway; Step 5, connection program of left and right banks of old iron bridge; by action program with steps, it revives cultural and historic idle space and memory.

4. RIVER BASIN AND ECOLOGICAL REPOPULATION OF WATERWAY RESOURCE NETWORK

Water source of Gaoping River basin is rich and it is the main source for irrigation, drinking water and groundwater in Gaoping area. Current long-term problems of basin are the following: flying sand of riverbed during dry season, back-silting of river course or lower riverbed due to coying of sandstone. In addition, vegetables and fruit are cultivated on benchland, there is emission of breeding waste water, reduced number of migratory birds, low biological diversity, pollution of pig farms on left and right banks, industrial and family waste water, eutrophication of water and high quantity of ammonia and nitrogen. It indirectly influences quality of tap-water in Gaoping area.

In the future, in order to improve ecology of river basin and have balanced benefit between human-based use and natural ecology, this program will construct slope analysis on Gaoping River of the region. According to flow and direction of water, it classifies human interference space from high to low levels as criteria of spatial planning and propriety. Based on analytical result, public facilities in and out of river embankment, industrial model, space and type of road will coexist with river. It matches the diversity of Gaoping River and it will reach the balanced benefit between humanity and ecology.

The planning aims to avoid human activity based thoughts and attempts to revive natural ecology system of the **bank of Gaoping River to "return to" the bank of Gaoping River and establish basic values upon river** ecology. It follows the direction of flow as spatial planning of the bank, adopts low impact facility, permeable basal disc facility and low obstacle natural succession design. From perspective of natural environment, it uses the river land beyond protecting embankment.

Based on human interference level of activity space, in different sections of river, it establishes human interference space from high to low levels. Low-level human interference space: ecological reserve area and natural exploration park and it includes transition zone, bird watching area and wetland; medium level of human interference space: including mobile stores, camping area and space of outdoor activities in natural environment; high-level human interference space: compound space of large-scale activities and it avoids the idle space and when the land is not frequently used in ordinary days, the impact on the nature is low.

Besides recreational landscape space on the bank, for the concern of flood prevention, we should construct protecting embankment, river dam (cross-sectional structure) or river course dredging construction. In order to maintain diverse river course space, in the design of construction, we should pay attention to characteristics and flexibility of river. It avoids the border, provides natural habitat and leads to biological diversification.

According to concept of the action program, there are the following four steps: Step 1, investigation on water of Gaoping River and ecological resources; Step 2, Gaoping River slope analysis and propriety analysis of human activities; Step 3, basin ecological repopulation and recreational space design; Step 4, connection between surrounding water network and resources. Hence, this program creates sustainable Gaoping River basin of sustainable ecology.

5. ROOTING ACTION OF CONSTRUCTION TO CARRY OUT SUSTAINABLE DEVELOPMENT OF RESOURCES

The area of this program is based on profound history. After the first group of immigrants who arrived and cultivated the land, there were different types of groups, such as Minnan, Hakka and relatives of military. They were on the land with different beliefs and cultures and it results in unique and rich cultural landscape resources.

Great number of temples, old houses and old trees are the characteristics of the left bank area of Gaoping River (including Pingtung County, Pingtung City, Jiouru Township, Ligang Township, etc.). They are preserved completely with historical significance. The area is one of those with the richest historical resources in Taiwan. The famous one is the oldest Three Mountain Kings Temple which is located in the lane of Jiouru Township and it is the temple worshipped by Hakka people.

In recent years, Pingtung County implements village renewal program and the applications are based on local community development associations. There are also the items of agricultural transformation, village space reconstruction and manufacturing and promotion of agricultural products. It has successfully promoted several

communities and completely developed local characteristics. The well-known agricultural products include lemons **and bananas. There are also local sales of farmers' associations and fairs, lemon cooperative, banana institute** and agricultural experimental station for technical promotion and upgrading and the related measures such as industrial guidance.

Since the area is spatial and the resource network is loose, the development of the rich industrial and cultural resources is mostly based on single region and it lacks complete and cross-region program. Local characteristics are not highlighted and it is not favorable for tourism development. In addition, there are no connection among tourist sites, resource stations and network of routes and related measures. Local stores do not have interaction with the industrial circle. Community development cannot effectively enhance local environmental, cultural and industrial quality.

In the future, in order to fulfill sustainable development of local life circle, we must rely on complete coordination, use infrastructure and support, and carry out and execute sustainable resources. It requires total examination and integration to vitalize local historical space. By upgrading of public space quality and combination of transportation network, it reinforces the approachability of foreign tourists, strengthens effective use of local resources, constructs ecology-friendly recreational space and promotes green community. Based on local policy, it can implement green energy facilities and transform public and industrial space into demonstration points of new industry.

It also corresponds to infrastructure. By planning annual marketing activities, it enhances local reputation and further coordinates cultural, recreational and historical resources. It relies on packaging and promotion of cultural and innovative measures. With community participation, it fulfills local life, production and ecology to implement related sustainable guidance program from top to bottom, enhances local force and cultivates community independence to deal with negative effect caused by minority population structure to construct total sustainable circulation system of the area.

Based on the previous complete planning, it establishes the steps of action program, accomplishes it by phases, effectively coordinates the resources of different fields and sustainably operates and develops Pingtung area: Step 1, integrate industrial, cultural, historic, landscape and artistic resources of different communities; Step 2, community participation and implementation of activities from bottom to top; Step 3, construction of sustainable facilities; effective use of resources from top to bottom; Step 4, annual cross-field marketing; Step 5, implementation of sustainable guidance of life, ecology and production.

6. EXPECTED RESULT

Short-term benefits, integration of original open space, enhancement of use rate of idle space and spatial reconstruction: by establishment of human based system, it creates friendly interface of original open space. It integrates cultural and historic resources and natural resources to reinforce regional tourism effectiveness.

Long-term benefits: in recent years, regarding city-township development, Pingtung area has significantly upgraded landscape quality of the city. According to original location characteristic and industrial and economic conditions, it plans blueprint of future space and proposes function position and development strategy of individual regions. Thus, with global climatic change and competition of international cities, Pingtung area can still be a place for peaceful life and work.

This study aims to highlight left bank portal of Gaoping River and coordinates local resources and construction to expand the development benefit to the whole Pingtung area in order to carry out 2025 development program of Pingtung.

REFERENCES

- [1] "11 chapters of Taiwan History" published by the National Museum of History
- [2] Basic Investigation of 14 Historic Interests in Pingtung County and Study on the Scope.
- [3] Connection and Passing of Gaoping River-Program of Cultural and Tourist Path of Old Iron Bridge and Jiuqutang.
- [4] **History and Change of Military Dependents' Villages in Pingtung City: Taking Da Peng Seven Village and Lin Yun Three Village as Examples.**

- [5] **Tamio, T., Lin, P.Y. (trans.), "Taisho Culture" (Taipei: Yushan Publishing, December 2010).**
- [6] The Second River Situation Investigation of Gaoping River, the Seventh River Management Office, Water Resources Agency, Ministry of Economic Affairs.

The District Cooling System at the Kai Tak Development

CHAN Pak-cheung^a, LO Siu-kuen^b, NG Ting-sing^c

^a Electrical and Mechanical Services Department, Government of the HKSAR, Hong Kong SAR, pcchan@emsd.gov.hk

^b Electrical and Mechanical Services Department, Government of the HKSAR, Hong Kong SAR, sklo@emsd.gov.hk

^c Electrical and Mechanical Services Department, Government of the HKSAR, Hong Kong SAR, tsng@emsd.gov.hk

ABSTRACT

The HKSAR Government is taking the lead to implement a first-of-its-kind district cooling system (DCS) in Hong Kong at the Kai Tak development (KTD). KTD is a huge development project spanning a total area of over 320 hectares that covers the ex-airport and nearby areas. The planned total public and private non-domestic air-conditioned floor area in KTD amounts to about 1.73 million square metres which will require a large demand for air-conditioning of about 284 megawatt of refrigeration (MW_r).

The DCS project is to construct a large scale centralized air-conditioning system. Chilled water is produced at the central chiller plant rooms and distributed to the consumer buildings in KTD through an underground chilled water pipe network. The project is implemented in three phases. The first two phases were completed and the final phase of the project is expected to be completed by 2022. The DCS at KTD has been put in operation since Feb 2013 to provide cooling services to the Kai Tak Cruise Terminal building.

DCS is the most energy efficient centralized air-conditioning system, consuming about 35% less electricity as compared to traditional air-cooled air-conditioning system, and is suitable for promoting building energy efficiency in new development areas. Upon completion of the project, the DCS at KTD is expected to achieve an annual saving of about 85 million kilowatt-hour in electricity consumption. Apart from energy saving, DCS will also help to mitigate the heat island effect in KTD by eliminating the heat rejection of separate air-conditioning system from individual buildings. Other benefits for individual consumers include reduction in upfront capital cost, more flexible building design, no noise and vibration arising from the operation of heat rejection equipment & chillers and a more adaptable air-conditioning system to the varying demand.

Keywords: DCS, KTD

1. INTRODUCTION

The HKSAR Government is taking the lead to implement a first-of-its-kind district cooling system (DCS) in Hong Kong at the Kai Tak development (KTD). KTD is a huge development project spanning a total area of over 320 hectares that covers the ex-airport and nearby areas. It comprises various types of buildings including commercial and office buildings, hospitals, hotels, schools, sport facilities and government buildings. The planned total public and private non-domestic air-conditioned floor area in KTD amounts to about 1.73 million square metres which will have a large demand for air-conditioning of about 284 megawatt of refrigeration (MW_r).



Figure 1: The Kai Tak development (KTD)

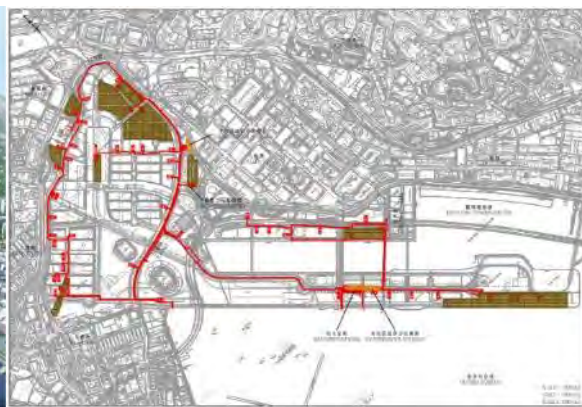

Figure 2: The DCS at the KTD

2. CONFIGURATION OF DISTRICT COOLING SYSTEM

A DCS consists of a central chiller plant, an underground chilled water-pipe network, substations in consumer buildings and the seawater supply system for heat dissipation.

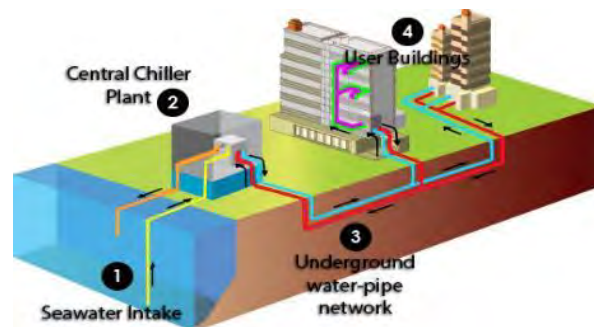

Figure 3: Configuration of DCS

3. THE DCS AT THE KAI TAK DEVELOPMENT

3.1 The DCS arrangement

The DCS project at the KTD is to construct a large scale centralized air-conditioning system which consists of two central chiller plants, namely the North Plant and the South Plant cum the seawater pump room, the underground chilled water distribution piping network, the seawater supply and discharge piping network. The cooling capacities of the North Plant and the South Plant would be 162MWr and 122MWr respectively. All plant rooms are mainly underground structures for the chiller plants and pipework installations. Chilled water is produced at the chilled water plant room and distributed to the user buildings in KTD through the underground chilled water pipes. The total length of the underground chilled water pipes is over 40 kilometers.



Figure 4: The North Plant located at Shing Kai Road



Figure 5: The South Plant located at the underground of Ex-runway of Kai Tak Airport.

3.2 A bank of chillers

Centralized chillers play an important role in an energy efficient and reliable air-conditioning system. Taking the North Plant as an example, upon completion of the whole DCS, there will be 14 nos. of chillers in total, ranging from 1.4MWr to 17.5MWr. With such combination of chillers, breakdown of any one chiller will not cause adverse effect to the operation of DCS, hence making it a more reliable system than traditional air-conditioning system. In addition, chillers with different cooling capacities could meet the varying cooling demand, thus making DCS more energy efficient than traditional air-conditioning system.



Figure 6: The installed 1.4MW and 4.3MW chillers at the basement floor of North Plant



Figure 7: The installed 17.5MW chiller at the basement floor of South Plant

3.3 Chilled water piping network

In order to increase the reliability of the DCS, the underground chilled water piping network is designed to be a 3-pipe system or in ring circuit forming a dual-feed supply. In a 3-pipe system, two of the pipes are duty supply or return pipes while the other pipe is a standby pipe. The standby pipe can be used as a supply or return pipe to maintain the district cooling services when one of the duty pipes is damaged or under maintenance. The dual-feed supply enhances the reliability of the system such that if the supply from one side of the network is not available, chilled water can still be supplied to the consumer substations from the other side.



Figure 8: 3-Pipe system of underground chilled water piping in Open Trench

3.4 DCS pipes protection

The DCS pipelines were constructed with open trench excavation or trenchless method. The trenchless method was adopted when there were prohibitively existing site constraints for constructing any open trench. In which, about 1km of DCS pipes were constructed by heading method or hand dug tunnel. Over 5km of DCS pipes were constructed by pipe jacking method with the use of Tunnel Boring Machines (TBMs). The largest TBM size used was 2,800mm in diameter which was the largest one ever used in pipe-jacking in Hong Kong. It was used to construct two nos. of 350m long subsea tunnels under the Kai Tak Approach Channel.



Figure 9: DCS pipes laying inside the underground tunnel



Figure 10: Two subsea tunnels (350m) constructed with TBM

The underground chilled water pipes are insulated with closed cell polyurethane insulation with 60kg/m³ minimum density and 0.025W/ m°C maximum initial thermal conductivity. The polyurethane insulation is able to withstand 300kPa minimum compressive strength. The heat loss in the piping network directly affects the energy efficiency of the DCS. To reduce the heat loss of chilled water in piping network, factory-prefabricated insulation with 65mm thick polyurethane is used and considered as optimum for the DCS pipes insulation. With this insulation, the estimated annual energy loss of chilled water distribution network can be limited to within 0.5% of the maximum cooling load.



Figure 11: Insulation of DCS Pipelines

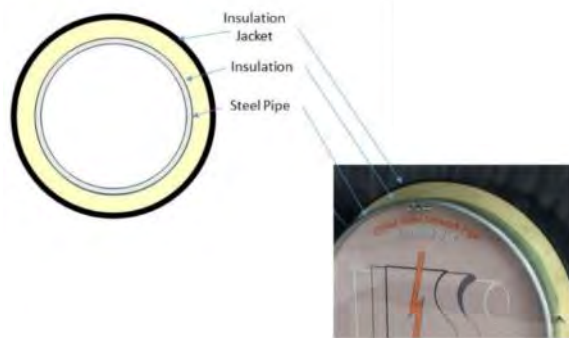

Figure 12: Cross-Section of Chilled Water Pipe

3.5 Consumer substation

The cooling energy required by each consumer building are **transferred from the DCS to the individual building's** central air-conditioning system via plate type heat exchangers installed inside the substation of the consumer buildings. The primary side of the heat exchanger is connected to the DCS distributing chilled water pipes and the **secondary side is connected to the consumer's chilled water system. Under normal operating conditions, the** designed chilled water supply and return temperatures of heat exchanger are shown below. It is desirable for both the DCS plant operator and the consumers to meet the designed temperatures in order to achieve energy efficient DCS plant operation and reliable chilled water supply to the consumers.

- | | |
|--|---|
| <p>a. At the primary chilled water side of the heat exchanger, i.e. DCS side:</p> <ul style="list-style-type: none">• Supply Temperature = 5°C• Return Temperature = 13°C | <p>b. At the secondary chilled water side of the heat exchanger, i.e. consumer side:</p> <ul style="list-style-type: none">• Supply Temperature = 6°C• Return Temperature = 14°C |
|--|---|



Figure 13: The heat exchangers in DCS substation



Figure 14: The energy meter in consumer building

3.6 Energy management and monitoring

The system performances of DCS in KTD are monitored by an automatic computerised system, namely the District Cooling Instrumentation, Control and Communication Systems (DCICCS). DCICCS consists of the optical fibre network for data transmission and the automatic computerised monitoring system for central-control and remote-monitoring. The monitored data are transmitted through optical fibre network connected from all substations to the Control Rooms of North Plant and South Plant. In the Control Rooms, the DCS plant operator is able to carry out the remote-monitoring to get the real-time system performance from all substations and all chillers plants, such as the chilled water supply & return temperatures of all substations, the readings of energy meter of consumer buildings and the Coefficient of Performance of the whole DCS.



Figure 15: The control room in North Plant

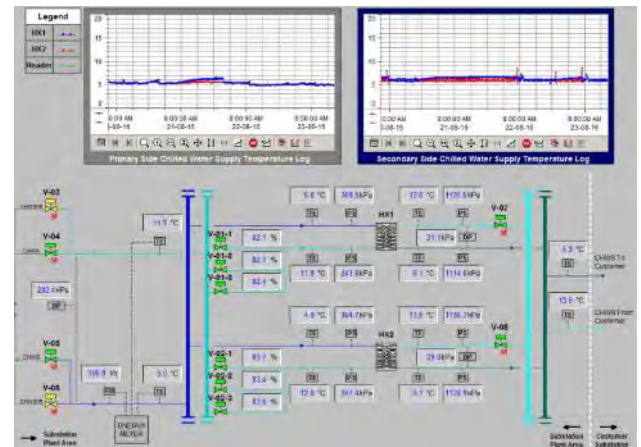

Figure 16: Remote monitoring the substation by CICC

4. BENEFITS

DCS is the most energy efficient centralized air-conditioning system, consuming about 35% less electricity as compared to traditional air-cooled air-conditioning systems, and is suitable for promoting building energy efficiency in new development areas. Upon completion of the project, the DCS at the KTD is expected to achieve an annual saving of about 85 million kilowatt-hour in electricity consumption. DCS is also a more adaptable air-conditioning system to the varying demand as compared with individual air-conditioning systems. Each consumer building may adjust its contract cooling capacity, without carrying out extensive modification works for the building in question.

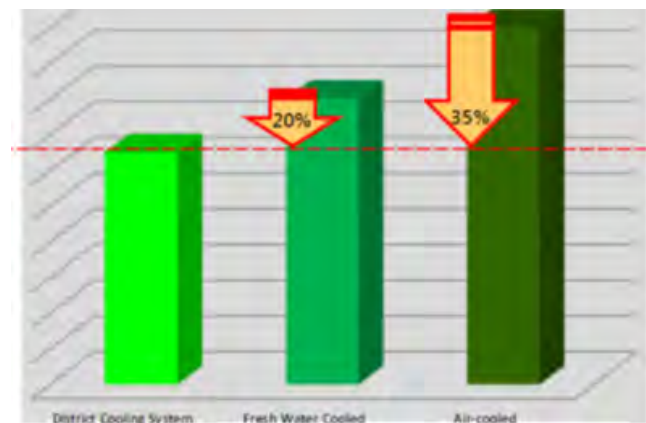

Figure 17: Most energy efficient centralized air-conditioning

Apart from energy saving, DCS will also help to mitigate the heat island effect in KTD as heat rejection no longer generates from separate air-conditioning systems of individual buildings. Also, the DCS can contribute to the vision of achieving low carbon economy.



Figure 18: Mitigate heat island effect



Figure 19: More flexible in building design

Other benefits for individual consumers include reduction in upfront capital cost for installing chiller plants at their buildings which account for about 5-10% of the building cost, more flexible building design as they do not need to install their own chillers and the associated electrical equipment as well as elimination of noise and vibration arising from the operation of heat rejection equipment and chillers.

5. IMPLEMENTATION OF DCS AT THE KAI TAK DEVELOPMENT

The project is implemented in three phases. The Phases I & II were completed and the Phase III is in progress. The DCS at KTD has been put into operation since February 2013. The whole project is expected to be completed by 2022.

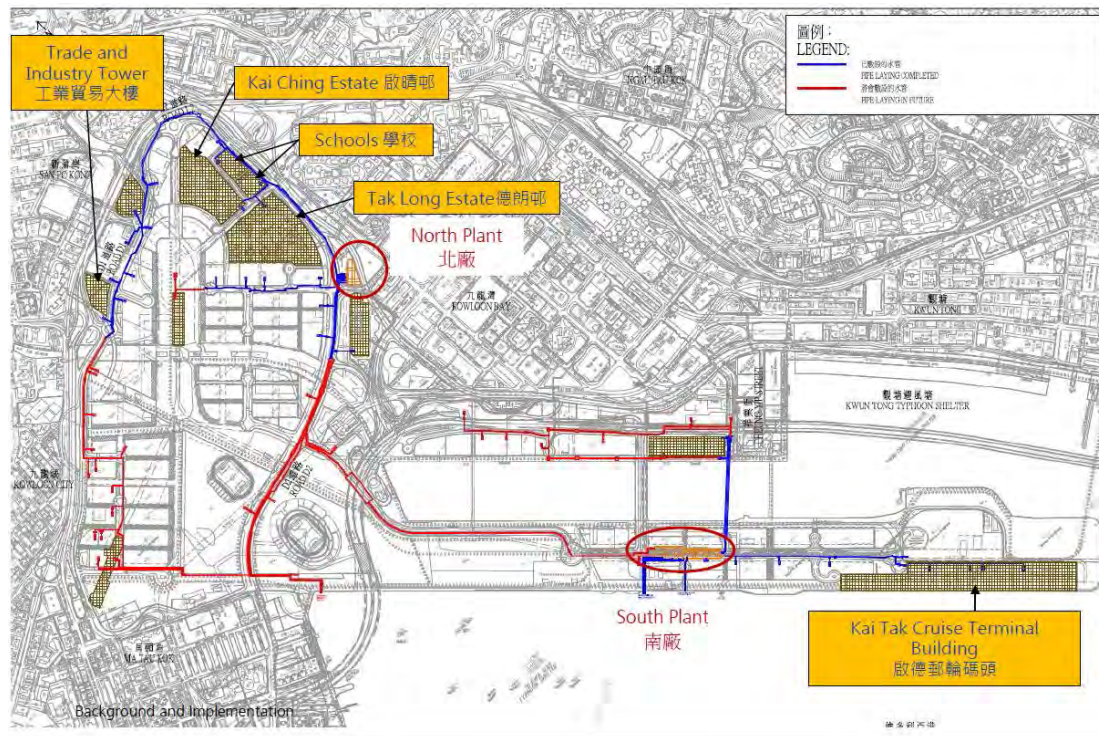

Figure 20: The consumers of DCS at KTD as at mid-2016

In mid-2016, the DCS at KTD is providing services to five consumers, namely the Kai Tak Cruise Terminal, Ching Long Shopping Centre (serving Kai Ching Estate and Tak Long Estate), the Trade and Industry Tower and two primary schools. Following the development of KTD, the number of consumers of DCS will be increased progressively in coming years. In 2017-2019, five more consumers will be connected to DCS, including the **Shatin to Central Link (SCL) Kai Tak Station, the SCL To Kwa Wan Station, the Hong Kong Children's Hospital, the Electrical and Mechanical Services Department Headquarters, and the Kowloon East Regional Headquarters and Operational Base cums Ngau Tau Kok Divisional Police Station.**

6. THE DISTRICT COOLING SERVICES ORDINANCE AND THE CHARGING ARRANGEMENT & TARIFF LEVELS

The district cooling services charges have been set at a competitive level comparable to the cost of individual water-cooled air-conditioning systems using cooling towers, which is one of the most cost-effective air-conditioning systems available in the market. The charging arrangement intends to recover both the capital and operating costs from DCS consumers over the project life, which is estimated to be 30 years, as taxpayers should not subsidise such air-conditioning charges. To implement the charging arrangement, the District Cooling Services Bill was introduced to the Legislative Council (LegCo) on 15 October 2014 and the Bill was passed at the LegCo meeting of 25 March 2015. The District Cooling Services Ordinance (Cap. 624) was gazetted on 27 March 2015. Under the District Cooling Services Ordinance, the district cooling services charges comprised: (a) the capacity charge (to cover the capital cost and the operation & maintenance costs of DCS); (b) the consumption charge (to cover the cost that vary with the actual consumption of district cooling services by the consumer); (c) the capacity overrun charge; and (d) the surcharges for unpaid charges. The capacity charge rate (tariff level in 2016/ 2017) effective from 1 April 2016 is HK\$118.93 per kilowatt refrigeration. It is levied according to the contract cooling capacity agreed before provision of district cooling services. The consumption charge rate is HK\$0.1941 per kilowatt-hour refrigeration. It is levied according to the actual cooling energy consumption of the building in a month.

7. CONCLUSION

DCS is the most energy efficient centralized air-conditioning system, and is suitable for promoting building energy efficiency in new development areas. It is expected that the whole project will be completed around 2022 and will achieve an estimated annual saving of 85 million kilowatt-hour (kWh) in electricity consumption. The DCS project commenced in early 2011 and the DCS at KTD has been providing services to consumer buildings since 2013. The construction of the remaining phase of the DCS project is in progress and will be completed along with the growing needs of air-conditioning of the new buildings which are coming up progressively.

REFERENCES

- [1] Siu-kuen Lo and Ting-sing Ng, 2015. 'Implementation of District Cooling System Development in Hong Kong and its Challenges', paper presented.
- [2] Patrick Cheung, Siu-kuen Lo and Chun-yue Ma, 2014. 'Implementation of District Cooling System in Hong Kong : Challenge and Experience', paper presented
- [3] Siu-kuen Lo, 2011. 'Engineering Design for Power Supply to District Cooling System of Kai Tak Development', paper presented
- [4] Alvin Lo, Barry Lau, Vincent Cheng and Patrick Cheung, 2014. 'Challenges of District Cooling System (DCS) Implementation in Hong Kong', paper presented
- [5] International District Energy Association (2008), District Cooling Best Practice Guide First Edition, USA.
- [6] International Energy Agency (2004), District Heating and Cooling Connection Handbook, France.

Study on Business Scheme of a Community-wide Decentralized and Self-reliant Energy Network - Allocation of Co-benefits and Evaluation of Socio-environmental & Economic IRR

Ryota KUZUKI^a, Shuzo MURAKAMI^b, Toshiharu IKAGA^c, Takahiro KAWAYOKE^d, Yuichi IKUTA^e, Tsutsumi KOMIYAMA^f

^a Tokyo Gas Co., Ltd., Japan, kuzuki@tokyo-gas.co.jp

^b Institute for Building Environment and Energy Conservation, Japan

^c Keio University, Japan

^d Nikken Sekkei Research Institute Co., Ltd., Japan

^e Ministry of Environment, Japan

^f Nihon Sekkei Co., Ltd., Japan

ABSTRACT

Creating low-carbon, resilient cities and communities are major common issues worldwide. Community-wide decentralized and self-reliant energy network harmonized with centrally controlled grid energy such as power and gas is one of the effective measures to be further promoted.

In the past studies, in addition to energy benefit (EB) such as energy cost savings, non-energy benefits (NEBs) were evaluated into monetary value to show considerable cost-benefit ratio (B/C). But there is still large hurdle for implementing community-level decentralized self-reliant energy network caused by large initial investment and long-term pay-back period. To promote it in many communities, financial independence of the business scheme is necessary.

This study focuses on feasibility of a community-wide decentralized and self-reliant energy network in consideration of various co-benefits and proposes an original business scheme and feasibility evaluation process as follows;

- Public-private partnership business scheme
This study proposes a PPP business scheme consisting of several key actors.
- Proper re-allocation of cost and co-benefits among stakeholders
This study proposes re-allocation of cost and co-benefits (EB and NEB) among stakeholders in consideration of flows of payment and receipt through adjusting tariffs, taxes, subsidies between stakeholders.
- Target setting in terms of environmental, social and economic aspects
Taking NEBs into account, SE-IRR (socio-environmental and economic internal rate of return) is originally defined and introduced for feasibility study.

A Case study is carried out to verify the proposed business scheme of community-wide decentralized and self-reliant energy network to an actual urban district in Tokyo including potential several redevelopment projects.

Keywords: community-wide energy utilization, distributed energy systems, co-benefits

1. INTRODUCTION

1.1 Expectations for a self-supporting decentralized energy network and problem of industrialization

For sustainable-city/ community development, worldwide efforts are exerted to achieve a substantially low level of carbonization. These efforts are also expected to contribute to other fields such as the activation of communities' economic activities and energy security. In IPCC's 5th report (April 2014), Adoption of the Paris Agreement (December 2015), these various benefits are taken up as "co-benefits".

Despite the considerable concern of municipalities and proposals from business enterprises, and so forth, however, in many countries, number of projects as self-supporting business are rare at present. This is partially because (1) The scope of business as well as business leaders are unclear, (2) The manner to judge investment decisions has

not been well-developed, and (3) There is no function to fairly allocate and coordinate costs/benefits among stakeholders.

While previous studies failed to cover the above-mentioned problem regarding business planning, this study focuses on the feasibility of a self-supporting decentralized energy network business, as Figure 1 shows an image, comprising community-wide public-private partnership entities, aiming to make a specific proposal to the following matters:

- Business entities responsible in terms of public benefit aspects and public-private partnership-type business schemes
- Method of allocating various benefits brought by the business to each stakeholder
- Performance index proving the feasibility as a sustainable business in the community

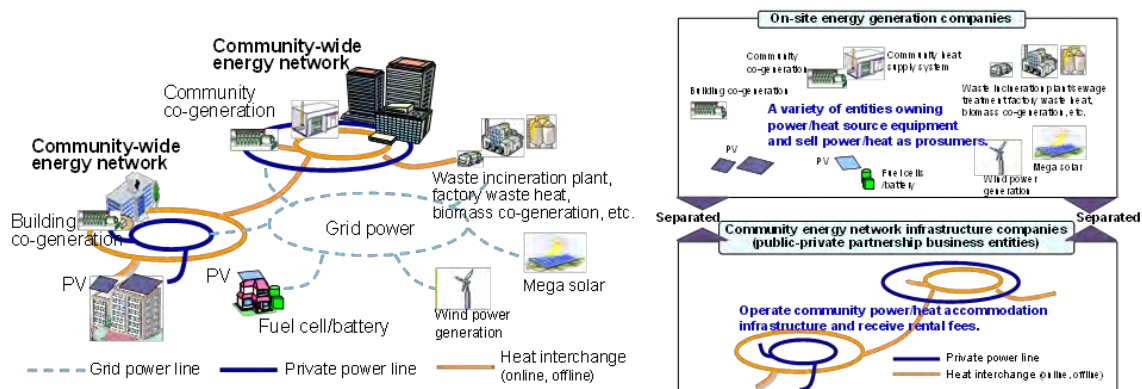

Figure1: Image of community-wide decentralized energy network and public-private separation concept

2. PROPOSED BUSINESS SCHEME

To enhance the independence of building- and block-level energy, consumers will probably have more on-site power/ heat sources allowing self-supporting operation.

On the other hand, when the separation of electric power production from its distributor, these power/ heat source owners may act as producers of more electric power/ heat than is self-consumed at ordinary times and allocate and sell them to adjacent buildings/ blocks will be paid for quicker returns on investments. In such cases, a mechanism of power/heat conveyance line networks being built as community infrastructure, with rental fees to be paid by users, is considered to be effective.

Hence, this study uniquely tries to suppose a public-private partnership business form embodied by two entities different in nature: one is mainly a private sector' "on-site energy generation companies" having a point of contact with end-use consumers as well as having and operating power/heat sources for production/ selling and the other is a "community energy network infrastructure company" serving the public good/interests and undertaking the ownership and management of infrastructure for power/ heat conveyance.

Figure 2 shows an overall image of the business scheme consisting of stakeholders of these business entities

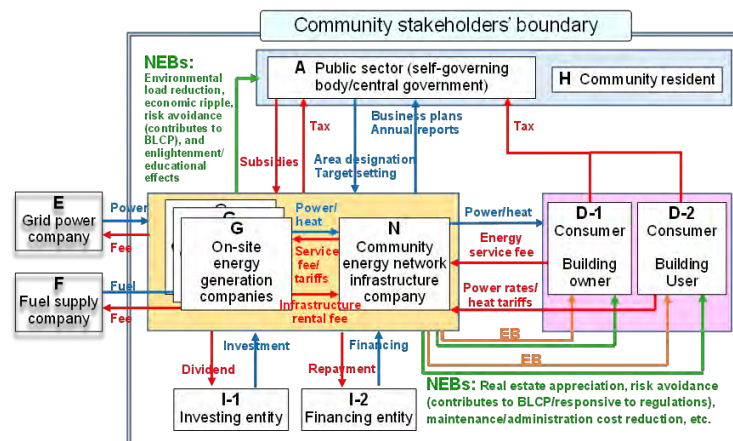

Figure 2: Shows an overall image of the business scheme consisting of stakeholders of these business entities

3. METHODOLOGY OF EVALUATING BUSINESS SCHEME

Figure 3 shows the flow of evaluating the business scheme. The flow is roughly divided into three steps as mentioned in the following 3.1. to 3.3.;

3.1 Verification of an overall community area

First, in accordance with the assumption of future building use composition and total floor areas for respective applications in targeted community areas, the case where these just satisfy the current standard for buildings is deemed to be BAU. Next, using a literature method, the maximum power load (kW) to be maintained for functioning as BLCPP during disasters and other emergency times is calculated.

Based on the above, the quantity (kW) of co-generation to be adopted and the total length (m) of heat conduits/private power lines are determined for the estimation of costs required for adoption, with the following as a guide obtained through the introduction of a self-supporting decentralized energy network:

- CO₂ reduction rate of 20% or more of the BAU case
- Energy independence (power) of 100% or more
- Project B/C (= (EB + NEB)/C) is 1 or more.

3.2 Cost and co-benefit allocation to stakeholders

Policy for allocation of costs among stakeholders

The cost required for businesses is divided into facility improvement/ replacement investment and maintenance/ administrative/management expenses. Next, subsidy rates, and so forth, under ongoing subsidy programs of the central government and municipalities to assist ESCO business and low carbonization measures/policies are factored in to assume cost allocation among stakeholders. Figure 4 (left) images cost sharing policy in the case where the public sector helps with one-third of the facility improvement / replacement investment.

Policy for allocation of co-benefits among stakeholders

In case a community-level energy business is put into practice under the business scheme outlined in Figure 2, diverse co-benefits can be expected. Mizuishi et al. pointed out in their study the necessity to reallocate non-energy benefits (NEB) since they do not always belong fairly to stakeholders.

This study uniquely proposes to consider where the co-benefits brought by business intrinsically belong and, at the same time, allocates them among stakeholders in proportion to the above-mentioned ratio of cost sharing. Figure 4 (right) outlines the concept

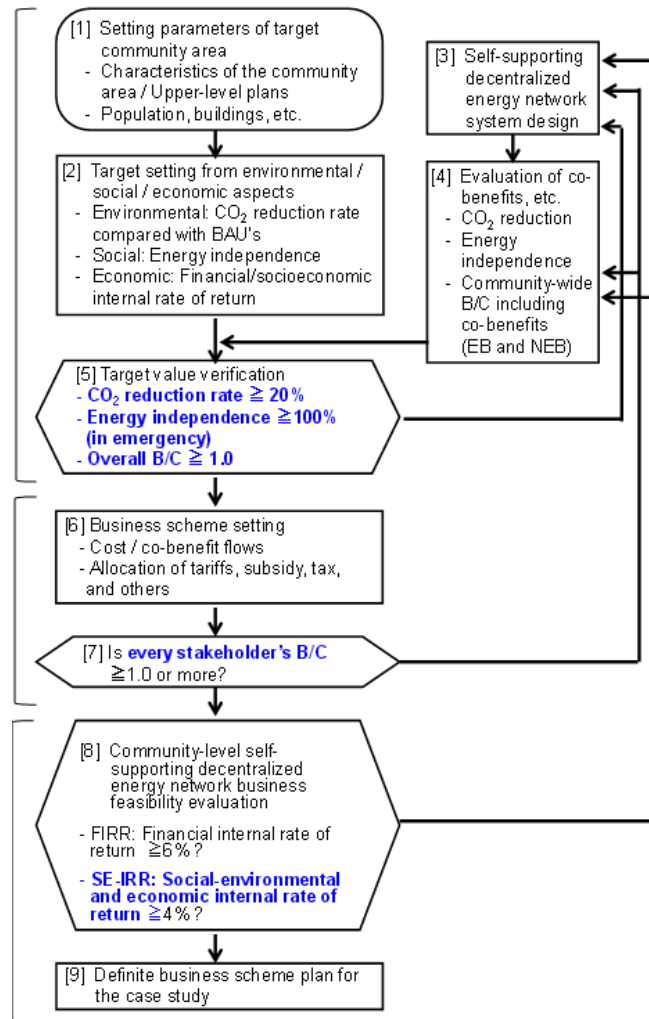

Figure 3: Flow of evaluating business scheme

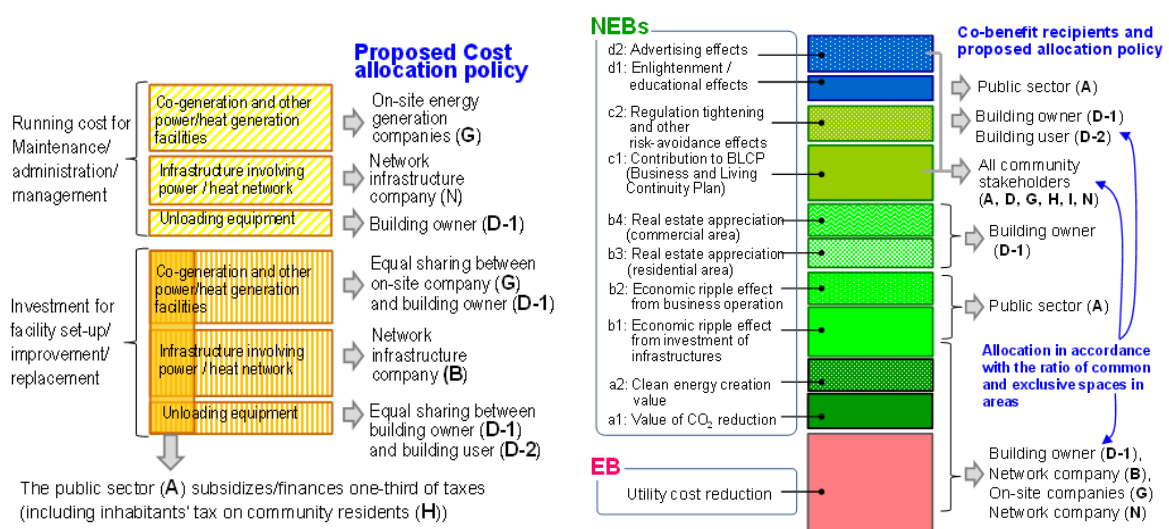

Figure 4: Policy of allocation of cost and co-benefits (EB and NEBs) among stakeholders

3.3 Evaluation of business entities' FIRR and SE-IRR

In order that the self-supporting decentralized energy system may be established as an independent business in the community concerned, it is necessary to prove that initial investments in business equipment for community-level co-generation and other businesses can be recovered by earnings through subsequent management. As an index to judge this, in addition to FIRR (financial internal rate of return) used in conventional business investment evaluation, this study, as mentioned below, uniquely proposes to newly define and use SE-IRR (social, environmental and economic internal rate of return), which takes into consideration the high-level contribution to public interests and takes co-benefits (EB and NEBs) into account.

SE-IRR defined r to establish:

$$\sum_{t=0}^n \frac{EB_t + NEB_t - C_t}{(1+r)^t} = 0$$

n :	Business period (in years)
r :	Discount rate
EB_t :	Amount of utility costs reduction enjoyed by business entities in FY t
NEB_t :	Indirect benefits enjoyed by business entities in FY t
C_t :	Costs of business entities in FY t corresponding to EB_t/NEB_t

This study defines, as its own index, SE-IRR, which considers NEBs brought by the low carbonization measures of previous studies presented, as follows, to propose its use for community energy network infrastructure company (N) evaluation.

Concerning the target level of SE-IRR, Technical Guide to Cost/Benefit Analysis for Public Work Evaluation (General) (June 2009), published by the Japanese Ministry of Land, Infrastructure, Transport and Tourism (MLIT) proposes the concept of Economic Internal Rate of Return (EIRR) considering direct/indirect benefits in a variety of public works as well as advocates possibilities to judge the investment efficiency of a business by comparing it with the social discount rate and desires such as a rate of 4.0% to be used for both. Following this, this study considers 4.0% appropriate for SE-IRR very much serving the public good/interest in particular among community energy businesses.

4. CASE STUDY

4.1 Overview of the case study community area

Figure 5 describes the target community area of a case study. This area is one of the bases for strengthening international competitiveness in central Tokyo and is a block of about 16 hectares where urbanized areas are mixed with redevelopment counterparts around a railway station. Main points of the assumption in this case study are given below.

- Business operations targeting an estimated building gross floor area of 710 thousand square meters
- In each of C-2 to C-4 blocks, in which large-scale integrated development is expected, introduction of co-generation at every redevelopment project
- In each block, along with well-established plazas, decks, and others facilities, laying of private power lines and heat interchanging pipelines

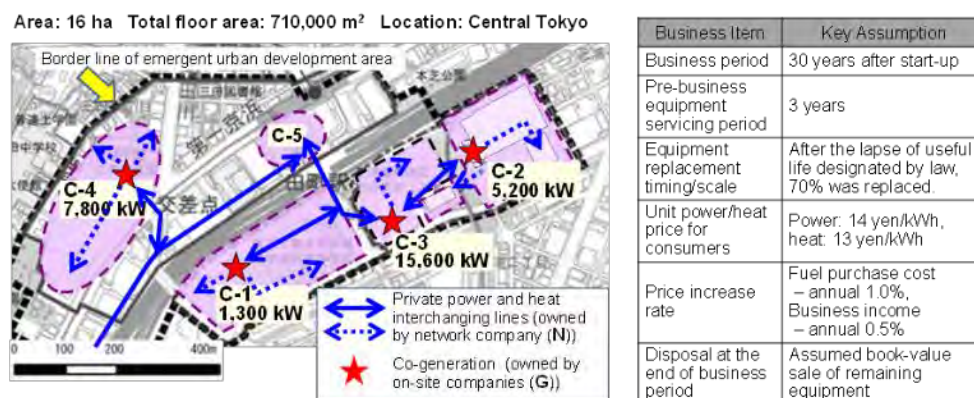

Figure 5: Overviews of the community area and key assumptions for the case study

4.2 Main results of the case study

Rate of CO₂ reduction

The CO₂ emissions reduction rate of the target community area as a whole can be expected to account for 28% of BAU.

Energy independence

Energy independence of the target block as a whole was examined for 2 types different emergency levels (several hours to one day and over one day to several days) and both were found to be over 100%.

Overall B/C

As shown in Figure 6, B/C of the entire business was 0.87 in the evaluation of EB alone, while B/C = 1.64 can be expected if co-benefits (EB and NEBs) are taken into account.

B/C evaluation for each of the stakeholders among which cost and co-benefits have been allocated

In compliance with the policy stated by Figure 4, cost and co-benefits (EB and NEBs) were reallocated through the flow adjustment of power rates, heat tariffs, subsidies, taxes, interest, and dividends among stakeholders as shown in Table 1, producing the result given in Figure 7. For every stakeholder, B/C exceeds 1.0 and the difference in B/C among stakeholders ranged between 1.4 and 3.9, or within 3 times. In addition to this, consumers (D-1), network companies (N), and on-site generating companies (G) may expect to recover shared costs only from EB. This is because, among co-benefits, the economic ripple/risk avoidance effect as NEBs returns mainly to the public sector (A) and, as its reward, costs accounting for one-third of initial investment were allocated. At this time, B/C of the public sector (A) is also 1.4, clearly highlighting the reasonability of cost sharing.

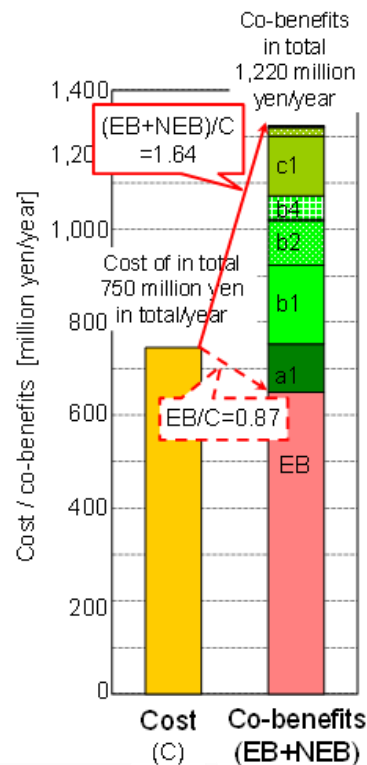

Figure 6: Overall B/C

Allocation policy items		Assumption
Public sector (A) and business operator (G and N)	Subsidies from the public sector	Subsidies to one-third of business operator (G and N) investment in equipment
	Rate of business operators' tax burden	40% including fixed asset/city planning and corporate taxes. Notwithstanding, 0% was assumed for business equipment of a network company (N) since it may probably be disposed of by the self-governing body.
consumer (D-1, D-2) and business operator (G and N)	Power rates/ heat price	Not to be coordinated. (Under an assumed contract for long-term connection, pay rate shall be deemed equal to BAU's.)
Financing (I-1, I-2) and business operator (G and N)	Interest	3% Notwithstanding, 1% is assumed for network companies (N) since they may enjoy long-term continual use by consumers (D-1 and D-2), debt guarantee from the public sector (A), and so forth.

Table 1: Proposed adjustment for re-allocation of co-benefits

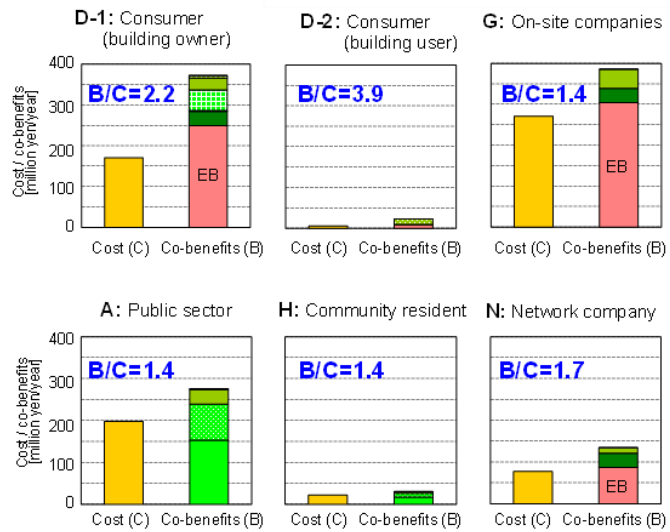

Figure 7: Proposed allocation of cost and co-benefits among stakeholders

Evaluation of business entities' FIRR and SE-IRR

Figure 8 shows the profit/loss transition of business operators (G and N) during the business period to be used in FIRR and SE-IRR calculations.

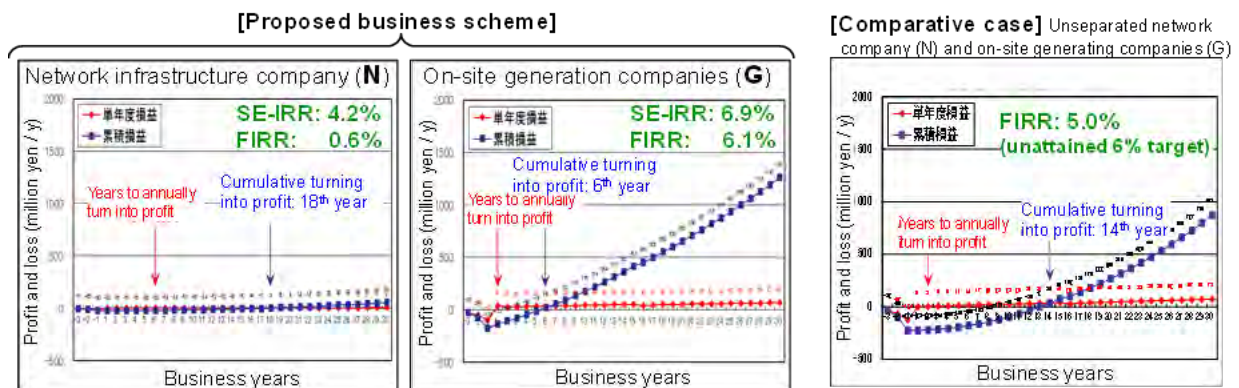

Figure 8: Financial performance of companies (G, N and unseparated case)

FIRR of on-site generation companies (G) was calculated at 6.1%, so the participation of a wide variety of private entities may be expected. On the other hand, network infrastructure companies (N) that totalled 4.2% in SE-IRR, satisfying the target value of 4% or more, may be judged to establish their business. Meanwhile, from Figure 8, the number of years to cumulatively realize a profit was found to be 6 for on-site generation companies (G) and 18 for network infrastructure company (N).

Figure 8 (right) shows a comparative case which constitutes both the network infrastructure company (N) and on-site generation companies (G) as one business entity. FIRR becomes 5.0%, lower than that of proposed case on-site generation companies (G) separated from the network infrastructure company (N) since it cannot be adjusted by consigned forwarding charges, and the number of years to cumulatively realize a profit becomes 14, indicating the difficulty to motivate private entities regarding the case.

5. CONCLUSION

Concerning how community-level independent decentralized energy network business can be established as a community's self-supporting project, this study proposed a business scheme considering co-benefits (EB and NEBs) as well as a series of evaluation methods and verified them through case studies.

ACKNOWLEDGEMENT

This paper is a part of the outcome of the academia, industry and government **collaborative research “Energy Innovative Town” (led by Shuzo Murakami, President of the Institute of Building Environment and Energy Conservation)** in the Japan Sustainable Building Consortium. The authors are greatly acknowledging the support of everyone involved.

REFERENCES

- [1] IPCC: CLIMATE CHANGE 2014 Mitigation of Climate Change (IPCC 5th Assessment Report Working Group III), 2014.4
- [2] Japan Sustainable Building Consortium (JSBC): Smart Energy Town Research Committee Report, March 2012
- [3] Mizuishi, et al.: By-Stakeholder Cost/Benefit Analysis Considering Indirect Energy Benefits (NEB) and Consideration about NEB Reallocation – Studies on a Decentralized Energy System-Based Low Carbonization of Cities/Communities, Journal of Environmental Engineering, No. 684, pp.175-181
- [4] The Ministry of Land, Infrastructure, Transport and Tourism: Technical Guide to Cost/Benefit Analysis for Public Works Evaluation (General), June 2009
- [5] The Urban Renaissance Headquarters: Special Priority Urban Renewal Areas under the Act on Special Measures Concerning Urban Renaissance
- [6] UNFCCC: Adoption of the Paris Agreement, 2015.12

Policy Framework and Instruments for Green Transformation in East Asia

Vincent CHENG^a

^a Arup, Hong Kong SAR, vincent.cheng@arup.com

ABSTRACT

The world has witnessed the largest global collaboration on combating global warming due to the excessive carbon emission associated with human activities. Many governments have made commitments on emission reduction and taken the necessary actions in addressing the problems. At government level, policies have been formulated to change the operations of industry, business and individuals to more sustainable manner. Developing low carbon society/ economy is becoming the prevailing initiative worldwide.

Asia has no exception on advocating this green movement. For those more developed East Asia economies such as Japan, Korea, Singapore, Hong Kong and Tai-wan, sustainable development is considered as the key national agenda not only for the sake of enhancing the environmental performance but also as the strategies on enhancing the social and economic benefits. Policies on directing the industry to the practice of sustainability are in place to increase the competitive advantages in global arena. Developing/ emerging countries, such as China take this agenda as the imperative for the survival of the nation on their process of urbanisation. Priority of policies has been channelled to the solutions/ strategies that can help resolving the environmental crisis.

In the quest for solutions, policy of the government plays the pivotal role, channelling the limited resources to address the most pressing issues. Implementation of policies, reflected by the adoption of appropriate instruments and institutional arrangements are critical to execute the policies. The success of the green movement will hinge on the prioritization of policies and its effective implementation. This paper develops a model to study the framework of sustainability policy on building sector that are prevailing in East Asian countries, highlighting the key agenda addressed and the effectiveness of these policies.

Keywords: policy and regulation, green transformation, urbanisation

1. INTRODUCTION

1.1 Rapid urbanization

Urbanization in the past few decades has accelerated the human activities for industrial and commercial productions that exacerbated the environmental problems. In Asia, regional urban economies (Japan, Korea, Taiwan, Singapore, Hong Kong and China to less extent) have developed through environmentally exploitive model in their urbanization process. As a result, many cities are now confronted with immense environmental challenges and some are facing multiple crises of liveability. Access to clean land, water and air are in jeopardy for cities in early urbanization stage. Environmental crises from air pollution and water contamination to waste generation are prevailing and affecting the daily life, in particular those poorest of the poor or society without society equity.

In parallel, cities are also facing adverse effects of climate change, which is escalating year by year, affecting everyone on earth. The risks of catastrophic natural disasters such as flooding, hurricanes or drought will hit severely those regional developing countries that are less prepared. The buildings, infrastructure and government and social supporting facilities are vulnerable to extreme weather. The cost for repairing the aftermaths is prohibitively high for those less affluent countries.

With more and more Asian developing countries undergoing their urbanization in faster pace, the outlooks of resolving environmental and climate change problems are not too promising. The world is facing more and unprecedented challenges in our history. It is imperative that we understand the problems and their root causes, and taking the actions in collaboration to resolve them.

1.2 Urban challenges in context

People move from rural areas to city in search of better livelihood and improved quality of living. City not only provides the basic necessities of shelter, food and water but also working opportunities to meet their enjoyment of urban consumption. Social security and communal supporting facilities can meet the needs on health care and education requirements. Yet, these expectations do not come naturally, and a worse-off situation is not uncommon in many cases in Asia, where people have to live in urban slum, suffering from the polluted environmental conditions of air, water and land. It has been argued that urban environmental challenges are the price for urbanization and had happened in all developed countries during their urbanization process. Some accept that these problems will only appear at the early stage of economic development and disappear when countries get richer. **Yet such “develop first, clear up later” strategy may not be workable for the current developing countries of the region due to two reasons.** Firstly the pace of urbanization is unprecedented and the environmental consequence could be too difficult to clean up later on. Secondly, compounded to the local environmental challenges is the global climate change. The combine effects could be disastrous.

Globally, there are little agreements on defining urban environmental challenges as different regions/ countries have different problems to face. Based on the scale and extent, urban challenges can be characterized in three types:

- Global climate change
- City-regional environmental challenge
- City-local liveability deterioration

Climate change is a newly emerging challenge. Asia and the Pacific in particular is the region most affected by natural disasters. Earthquakes, floodings and tsunamis are known threats. Global climate change makes the affected countries more vulnerable. The impact of disasters on urban areas of regional countries can be devastating. Urban agglomerations with high population density are experiencing high mortality levels in case of disaster.

Problems of urban environmental degradation affecting the daily life of city dwellers are equally daunting. Air and water quality are threatening millions of people in the region, causing significant economic losses every year. Even the waste is becoming a key agenda for governments and policy makers.

In principle, enhancing the liveability is the interest and under the jurisdiction of city. It has the authority and incentive to make the city more appealing to its citizens. Yet, many developed cities in region are facing degradation in the built environment because of ineffective urban planning and poor management of urban facilities. Too many and too concentrated built-up areas causing heat build-up within the city and too little greenery to improve the quality of the ecological system.

These challenges have to be worked out from different levels and different stakeholders. Better urban practices and governance could help to reduce the burden if not eliminate the problems.

Scale	Challenges	Typical Issues	Causes
Global	Climate Change	CO ₂ Emission, Global Warming; Extreme Weathers	Mass-consumption Lifestyles
City/ Regional	Environmental Degradation	Air, Water and Waster Pollutions; Energy and Resource Security	Rapid Urbanization
City/ Local	Liveability Deterioration	Urban Heat Island; Urban Form	Urban Planning

Table 1: Urban challenges

2. POLICY FRAMEWORK

In response to the urban challenges, there is always a case for reviewing the policies that affect buildings and construction in Asia. They are reviewed under the broad agenda of sustainability. These agenda include carbon emission, energy consumption, waste management and air quality, etc. In recent years, many governments have adopted the requirement for new regulations that a Regulatory Impact Assessment (RIA) should be undertaken. A

RIA consists, typically, of identification and clear statement of the purpose of the regulation, its risks, fairness and benefits which, if possible, should be valued. However, the main issue for the RIA is assessing the costs that are imposed on society and any other indirect effects. The review might adopt the principles of the RIA approach, but look retrospectively at the regulations in operation and not just at the proposals.

In 2004, HKSAR Government has conducted an exercise on establishing the policy framework of “Sustainable Construction”. The objective is to find out the options on the effective policy framework to implement sustainable development. The framework developed out of the study, has looked into the issues from three perspectives to arrive at the policy options, namely the policy priorities, policy instruments and institution arrangements.

Policy priorities - a clear statement of its objectives, i.e. what it is that wants to achieve. Expressing objectives as “priorities” is important since not all the desired achievements are likely to be practicable within the foreseeable time-frame;

Policy instruments, which is used to achieve the priority policies;

Institutional arrangements, which are required to successfully identify and formulate the priorities for policy, specify the appropriate policy instruments and implement them; and in due course, undertake their view.

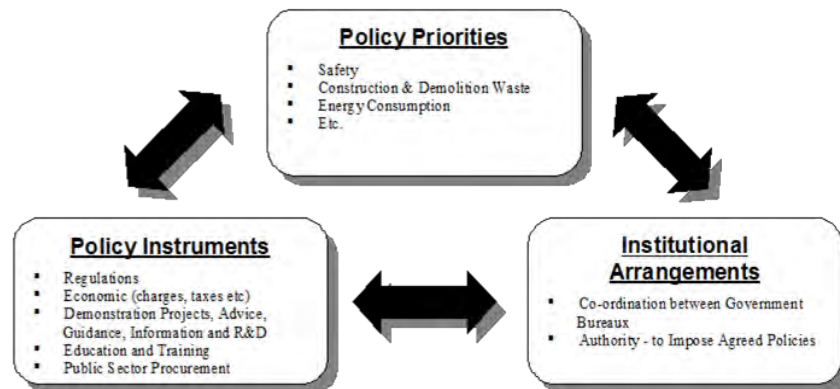

Figure 1: Policy framework for sustainable development

This framework provides a tool to study the policies on sustainable development systematically, on their rationale, implementation strategy and effectiveness across different countries. As many Asian countries share significant similarity on urban contexts and some on legal systems, they could provide valuable information for the policy makers when they conduct the RIA of their own.

3. POLICY PRIORITIES

In recent years, policy proposals are debated and pursued in some Asian countries without the existence of an overarching sustainability policy framework. Driven by more complex and complicated policy challenges, persistent problems, and conflicting interests, the desire for rooting policy-making in the available stock of knowledge and applying supporting techniques and procedures has grown. The issue for the governments, however, is how to ensure that the approaches are coordinated properly and implemented consistently with the sustainable development objectives. The developments of policy in Asian cities have shown some characteristic and share some similarities.

3.1 A moving target

Achieving sustainable development is a moving target. The key policy issues change with our understanding on the problem. The approach adopted by the EU on formulating the priority can be a good reference. This involves prioritizing a limited number of sustainable construction actions. Of course, EU priorities may well differ from Asian countries', although they are certainly relevant to the local circumstances. The EU established a high-level committee to review the possible areas for priority action and make appropriate decisions. To some extent, the Kyoto protocols and other international collaborations have fulfilled the role of information provider for the problems of the building and construction industry in this region, at least in large part. Regional and local forums were organized to discuss the policy issues on sustainable development and coordination for actions. There was no

shortage of information on the issues to be dealt with. Top items of the list are the climate change resilience, carbon emission reduction, environmental degradation, energy efficiency and renewable energy etc. The task outstanding is to prioritize them as a preliminary to taking the necessary actions.

Issues of Sustainable Development	China	Japan	Singapore	Hong Kong
Climate Change	Law on the Desert Prevention and Transformation (2001)	Act on Promotion of Global Warming Countermeasures (1998);		Resilient
Carbon Emission	Energy Conservation Law (2007)	Energy Conservation Law	Energy Law	Fuel-Mix; Energy Efficiency
Environmental	Environmental Protection Law (1989)	Basic Law of Environmental Pollution Control (1967); Basic Environmental Law (1993)	Environmental Protection and Management Act (1999); Environmental Pollution Control Act (1999)	
Liveability	Eco-City	Japan's Strategy for a Sustainable Society (2007)	Singapore Green Plan (1992); Sustainable Singapore Blueprint (2015)	Sustainable Building Design; Air Ventilation
Smart City	Renewable Energy Law (2005), ICT	Renewable Portfolio Standard (2003)	ICT	ICT
Others	Clean Product Promotion Law(2012); Government Procurement Law (2003)	Waste Management and public Cleansing Law (1970); Green Purchasing Law (2000)	Water Recycle	

Table 2: National plans and policy priorities on sustainable development of Asian countries

Issues on political environment also are affecting the priority of policy of a nation. For some democracies in Asian countries, the continuity of policy may have problems with the change in the administration. Technologies can also affect the priority. For instance, the commercialization of PV in the market and most recently the IoT technology are changing the landscape of sustainable development in Asia.

3.2 Prioritisation of policy issues

Globally, the policy objective of sustainable development is driven by the vision of a clean, healthy environment, and a strong economy. In recent years, the priorities of policy on sustainability of some developed Asian countries are extending from purely environmental issues such as air pollution, carbon emission and energy use to issues on society sustainability such as liveability, mobility and connectivity of people. The objective is to create communities that are more people-friendly as well as environmental friendly. This concept has expended the low-carbon development to sustainable development on encompassing the social and economic considerations, in additional to the environmental concerns. In the process of this green transformation, many regional megatrends have also driven the changes, including rapid urbanisation, economic integration, rising income and changing consumption pattern etc. These drivers of policy change have characterised the prioritisation of policy for sustainable development in the region. Some characteristics were observed on the regional leaders on their objectives in advocating sustainable developments:

- Regional integration – For regional leadership
- Top down national plan – For enhancing national competitiveness
- Green GDP – For addressing the environmental pressure
- Bottom up public engagement – For inclusive society and social equity
- Green consumption – For capacity building on green transformation

4. IMPLEMENTATION INSTRUMENTS

4.1 Leadership issues

The challenges for addressing the issues of sustainable developments, such as environmental problems, economic growth, poverty reduction, social development, equity and living standard are complex and inter-connected. Governments are better at institutionalising sustainability than any other sectors. And, if we are looking to achieve large scale transformation, the government sector is the obvious one to select. UNDP observed that active and effective governance requires institutions that are capable of delivering reliable and quality services by directing the talent, creativity and resources of people, business societies in shaping the changes we need. If public funds are required, the government can allocate and invest wisely, and manage public goods, including land and other natural resources equitably, for the benefit of all. Therefore, integrated policy and budget are critical to allocate resources to strategic national goals, rather than to individual ministries or departments.

Business clearly also has a critical role to play, and at its best demonstrates its capacity and will to advance the sustainability agenda. The private sector, however, cannot make the transition from a waste-based (resulting from our consumption behaviour) economy to a low-carbon economy without the rules of game to regulate/ facilitate the market that the economic life does not destroy the planet that provides us with food, air and water. The private sector can produce the goods and provide the services efficiently. Innovations and efficiency are what private sector is good at. Cross-sector partnering can only happen with the involvement of Government for the public-private partnership model.

4.2 Key policy initiatives and instrument applications

East Asia's dynamic economic performance has provided the opportunity for the green transformation. The regional economies have developed their own model of implementation arrangement, resulting in different extends of government/ private involvement. Key initiatives on policy initiatives and the corresponding instruments are found in Table 3.

Countries/ city	Instruments
Singapore (Liveability)	Sustainable Singapore Blueprint (2009) (2015) Green Mark Incentive Scheme (2015)
Japan (Energy Efficiency)	Feed-in-Tariff Scheme for Renewable Energy (2009) Tax for Climate Change Mitigation (2012) Low Carbon City Act (2012) Act on Energy Consumption Performance of Buildings (2016)
Korea (Green Growth)	Recycling Industry Promoting Loan (2012) Green Building Incentive Ordinance (2013) Renewable Energy Financing Programme (2015, 2016)
China (Eco-City)	Eco-city demonstration projects (2010) Feed-in-Tariff Scheme for Renewable Energy (2011) Green building direct subsidies (2012) Tax Rebate for Wind Energy Producers (2013)
Hong Kong (Green buildings)	HK-BEAM (1996) & BEAM Plus (2009) Energy Efficiency (Labelling of Products) Ordinance (2009) Buildings Energy Efficiency Ordinance (2013)

Table 3: Key policy and instruments for sustainable development in Asia

In particular, **China decided to implement a “Green” GDP programme with the political shift in priority towards a more environmentally sustainable economic model.** Effort has been turned to the building of sustainable (or low carbon) developments in China's urban transformation. With strong leadership and support from the Central Government, the policy of Green Urbanism in China is moving in the right direction, the principles of which are now being put into practice. Over 100 eco-cities are now being built in cities across China.

Bottom-up approach is also gaining more and more ground in developed economies across Asia in arriving at the creation of sustainability policies. These policies, in particular, those related to the environment of the local

community, have to receive support from the local society itself. Enhancing the liveability of urban space is a good example. The bottom-up approach has also been widely introduced as a counterbalance to the national culture, and primarily aims at empowering the local population to participate in whatever development process may have conflicts. Regular and in-depth consultation with stakeholders is an important part of the process in arriving at new policy initiatives. Singapore and Hong Kong are examples that favour a bottom-up approach for formulating the strategies for sustainable development.

5. SUMMARY

Right governance is pivotal to the success of implementing sustainable development. At government level, a policy framework should be in place to direct the stakeholders. At the top of the framework, policy priority should be formulated. There are many drivers (external and internal ones) that are influencing the priority in Asia. Creating business or technology advantages for the countries for developed countries while those developing countries will have to focus on addressing the environmental challenges created by urbanization. The policy instruments should also be in place to implement the policy. Other than regulations, economic instruments are becoming popular to engage the key stakeholders.

On policy implementation, applying right instruments by the government is the key to success. At the early stage of green movement, regulations should be in place to control the business operation and individuals. When the green market is form, the government can consider apply economic instrument, which is proved to be effective on incentivizing the market. Some business, such as green building is now working effectively as market solution.

The institutional arrangement is also important. Normally, the government-led situation is common. There should be the right mechanism that link up the policy making process and the implementation of work. Private sector can also lead and in most case the support from the civic groups are also important.

REFERENCES

- [1] Clark H (2013), The Importance of Governance for Sustainable Development, Remarks by Helen Clark, UNDP Administrator, on the occasion of the Singapore Lecture Series.
- [2] ESCAP (2010) Urbanization Trends in Asia and the Pacific, Factsheet.
- [3] ESCAP, UN-Habitat (2015) The State of Asian and Pacific Cities 2015 Urban transformations - Shifting from quantity to quality
ESCAP, UNEP, UNU, IGES (2016) Transformation for sustainable development - promoting environmental sustainability in Asia and the Pacific
- [4] Jacob K, Weiland S, Ferretti J, Wascher D, Chodorowska D (2011) Integrating the Environment in Regulatory Impact Assessments, OECD,
- [5] OECD (2005), Regulatory Impact Analysis in OECD Countries Challenges for Developing Countries.
- [6] OECD (2010), Regulatory Policy and the Road to Sustainable Growth

Session 7.8: Sustainable Neighbourhoods – Processes and Application

Current Challenges of Urban Energy Planning in a Norwegian Municipality

Eirik RESCH^a, Inger ANDRESEN^b

^a Norwegian University of Science and Technology, Norway, eirik.resch@ntnu.no

^b Norwegian University of Science and Technology, Norway, inger.andresen@ntnu.no

ABSTRACT

Transitioning urban areas into sustainable communities is an important part of combating the current energy and emission challenges facing the world. The Norwegian municipality of Oslo has set ambitious energy and emission reduction goals for the coming decades. This analysis seeks to uncover how these goals are incorporated in the planning practice in the municipality.

Through in-depth semi-structured interviews with four energy planners employed in or related to this municipality's current urban development, this issue was explored. The data gathered from the interviews was analysed in relation to existing literature to reveal underlying problems, and what the potential benefits of a more integrated approach between the two planning agencies can yield.

Results from the interviews reveal that there are underlying challenges regarding system definitions, transformation of existing urban areas, making the right prioritizations, and indicate that integration between departments to reach common goals has potential for improvement. The urban planning department focuses mostly on other, non-energy related aspects of planning. From the data gathered it is clear that a stronger implementation of energy assessment in the urban planning practice can be beneficial for achieving the energy and emission reduction goals set by the municipality. New assessment methods and tools need to be developed and current tools should be stronger implemented in decision chains. Results are valuable for any government with similar challenges. As urban planning decisions will often have long-lasting implications this issue is pressing.

Keywords: energy use, policy and regulation, design process

1. INTRODUCTION

Cities all over the world are in the process of transitioning existing built areas into sustainable societies reducing local pollution and emissions that contribute to global warming, as set out in the Paris agreement. The goals set in this agreement, as well as the specific goals set by many local governments, are ambitious and require well-informed knowledge to identify measures that are most effective to support greenhouse gas mitigation.

The Norwegian municipality of Oslo has recently published its greenhouse gas (GHG) emission reduction goals (Oslo kommune, 2016). The overall goal is to achieve a reduction of GHG emissions of 95% by 2030 compared to 1990 levels. Achieving such an ambitious goal require dedicated integrated planning across sectors and scales, and a solid knowledge basis on which decisions can be made. The planning of cities consists on the one hand of professional objective assessments and calculations, while on the other hand there are political considerations that have to be taken into account. In energy planning, as in most areas, there is often a gap between the two. This paper seeks to identify current challenges of urban energy planning in Oslo municipality from the perspective of energy planners. Based on in-depth interviews with selected energy planners, as well as analyses of political documents and other literature, we present and discuss some of the challenges of reaching ambitious GHG emission goals.

1.1 Urban energy planning

Urban growth consists of different urban planning processes that include different aspects such as housing type and volume, traffic system, infrastructure, services, etc. The growth patterns are traditionally handled as several non-related sub-systems and processes, as opposed to a single system (Kuronen et al., 2010). Despite the high

complexity of the energy sector, it can be studied in a meaningful way through an integrated assessment approach and a system-of-systems perspective (Agusdinata and DeLaurentis, 2008). Urban planning is, however, still treated as planning that considers only the spatial characteristics of a certain area (Kuronen et al., 2010), and energy planning is carried out only after the spatial plans are made. This practice is common despite that there is clear evidence of urban form affecting energy use (Weisz and Steinberger, 2010). An inter-organizational structure is argued by Korhonen (2004) to be an important element in successful urban planning, but is traditionally not part of the process, resulting in environmental management not being handled with a systems understanding. In a review paper (Keirstead et al., 2012), six approaches to urban energy system modeling were identified; technology design, building design, urban climate, system design, policy assessment, and integrated land-use and transportation. **They conclude that “there is significant potential for urban energy systems modeling to move beyond single disciplinary approaches towards a sophisticated integrated perspective that more fully captures the theoretical intricacy of urban energy systems”.**

1.2 Greenhouse gas accounting and system boundaries

Transitioning to zero-emission cities requires an increase in energy efficiency (reduction in consumption) and a **shift to renewable energy sources, for all of the city’s activities. These activities include energy generation and energy use, as well as considering the import and export of goods that have associated emissions from their production and transportation.** The energy consumption includes energy use for industry, transport, and buildings. **Energy generation happens both within and outside of the municipalities’, and energy may therefore be imported or exported across the borders of the municipality, thus representing credit or debit in the CO₂-account of the municipality.** The imported and exported goods are hard to account for and are therefore normally not taken into account in cities’ emissions accounting.

Renewable electricity from hydropower is abundant in Norway, and associated emissions from electricity production are small. Norway produces a surplus of electrical hydropower in a normal year. However, electricity is exported and imported with the European market and the actual electricity mix is, therefore, a more complex issue; what the marginal emissions are per kWh is a topic under discussion (Graabak et al., 2014). The municipality of Oslo has chosen not to allocate any emissions to the use of electricity from the grid. Within this definition, the used electricity is therefore not seen as a problem, but rather the remaining activities such as transportation, industry, waste generation and district heating plants. Still, the municipality has a focus on energy efficiency related to **electricity use. The reason expressed for this is that it will “free up” electricity for other purposes such as electric vehicles and energy-intensive industries, as well as “be made available for export to other countries”.** In addition, there are economic benefits of energy efficiency. Energy efficiency is in this way used as a proxy for reduction of greenhouse gas (GHG) emissions, but at the same time, there are by definition no emissions associated with it. The Climate- and Energy Strategy of Oslo is, therefore, twofold; an increase in energy efficiency and a reduction of direct emissions within the municipal borders. When assessing GHG emissions it is vital to set the system boundaries defining what to account for and what to exclude from the calculations. The system boundary definition will decide which actions will be taken to move towards the goals.

1.3 Political guidelines

The Climate- and Energy Strategy for Oslo municipality (Oslo kommune, 2016) was approved by the city council in June 2016. The overarching goal is a 50% reduction in GHG emission by 2020, and a 95% reduction by 2030, compared to 1990-levels. There are 16 target areas, whereof 10 are directly concerning emission reductions, and **4 are concerning the municipality’s governance towards emission reductions.** The remaining two target areas encompass energy efficiency in buildings and water-based heating and cooling systems.

The Norwegian Planning and Building Act is the legal binding document for planning and building permits in Norway. In addition to this, there are national guidelines that supplement and elaborate on expectations from the national level to the local. The Norwegian Ministry of Local Government and Modernization have national guidelines on Integrated Residential-, Land-use-, and Transport planning released in 2014 (Ministry of Local Government and Modernisation, 2014). The guidelines seek to promote better resource efficiency and the development of sustainable cities and communities through compact urban development coupled with sustainable modes of transportation. Also, they state that the development of new residential areas should be evaluated together with the need for infrastructure. Similar goals are stated in the Climate- and Energy Strategy.

2. METHODS

The empirical basis of the paper is based on three in-depth semi-structured interviews. In one of the interviews there were two interviewees, and in the two remaining there was one, thus in total, four persons were interviewed. The informants were specifically selected based on their central roles in the energy planning and the Climate and Energy Strategy of Oslo municipality. The interviews took place in the offices of the informants or at the university and lasted approximately one and a half hours each. An interview guide was adapted for each interview. The interviews were recorded and transcribed. When analysing the interviews, a phenomenological approach was chosen, with a focus on the interpretation of the expressed statements in the context of the planning literature, the political goals and guidelines and the GHG emission accounting systems described in Section 1. The interviews were first read and highlighted, then, information was extracted, categorized, and compared. Finally, the findings from the interviews were analysed in the context of the issues outlined in Section 1.

3. RESULTS

The interviews revealed some challenges that were experienced by all informants as well as some that were pointed out by some interviewees. This section includes a synthesis of the content as expressed by the interviewees as well as descriptions of underlying challenges that were discovered.

3.1 Challenges in transforming existing built areas

The informants pointed out the special challenges of transforming existing areas. Different reasons were given to explain this; **zoning restrictions; inhabitants' unwillingness to make changes, and long payback times for investments in the upgrade of buildings and energy infrastructure.** They voiced the need for planning instruments for application in already existing areas, especially to tackle problems associated with the structure of ownership.

Oslo has a goal of densification, and to achieve a compact mixed-use urban environment. This goal was described as challenging to reach in some parts of the city due to active resistance from the people living in the area, which significantly slows the rate of densification. In these areas, there is strong resistance to building both taller than and close to existing houses.

3.2 Poor integration between energy planning and land-use planning

Although the integration between energy planning and land-use planning has been agreed upon and stated in documents, the integration has not been transferred into practice. However, the interviewees note that there is an increasing focus on this issue, but the practical implications are still very subtle. The integration mainly takes place in the form of interdisciplinary working groups and meetings. Still, the experience of some of the interviewees is that land-use planning is happening almost completely separate from energy planning. During land-use planning, **all other concerns, such as the contractor's desire for profit, the municipality's concerns for good urban development, roads, and infrastructure,** are prioritized. Energy planning is mainly done by the utility companies, and only after the zoning plans are set by the municipality.

Integrating transportation and land-use planning is considered very important, and to be the main tool available to the municipality for reducing transportation-related energy. On the other hand, the importance of focusing on energy efficiency of stationary energy use in land-use planning is questioned by some, but at the same time encouraged and wished for. Building close to public transportation hubs together with increased density and strict building energy codes are considered to be more important. On a stronger inter-organizational planning structure, opinions were mixed; both open to future reorganizations, and an emphasis on the need for dividing areas of responsibility.

3.3 Comparing the incomparable and the need for a common understanding of greenhouse gas emissions

A central problem mentioned by all interviewees was the challenge of comparing the incomparable. This can be **synthesised in the following way: "We don't have the common underlying understanding and agreed upon framework for comparing different options in the right way".** Since there are many variables affecting energy use, it was considered hard to assess impacts of different options. It was also expressed as a concern that there is not

a common agreed upon framework for greenhouse gas emission accounting. This is related to the setting of system boundaries; that setting different boundaries will either lead to emissions not being counted, being counted differently, or that the emissions are shifted. It was voiced that this can put a specific energy solution in a negative light, disavouring its use and that it might also lead to overall wrong prioritization on the municipal level.

There was no disagreement about the choice of not attributing any emissions to waste incineration in the district heating system. It was reasoned that the emissions are allocated to the waste sector which means that they are included elsewhere in the calculations. Also, it was argued that the waste handling system in Oslo was considered **to be “particularly good”, and further improvements are planned. The heat from incineration is therefore considered** to be waste heat. It was, however, pointed out by one interviewee that defining district heating as 100% renewable makes it hard for other options to compete, and in some cases, it might lead to a suboptimal solution being chosen.

Three informants described a concern that central energy solutions are disfavoured due to the way energy use in buildings is accounted. District heating solutions are said to be disfavoured in some cases because it is defined as delivered energy rather than primary energy, while delivered energy is what is taken into consideration in calculations. An example used was that local heat pump systems are often preferred over central heat pump systems due to the system boundary of delivered energy.

The fact that electricity had been defined by the municipality as having zero emissions was set forward as a more difficult topic. One of the interviewees particularly considered this to be a central problem, explaining that a consequence of such a definition is that there are no incentives for reducing electricity consumption to reduce emissions. There are two separate goals being promoted, one is energy efficiency and the other is emissions reduction. Although an underlying motivation for energy efficiency is the reduction of emissions, it is not counted as such by the municipalities. In this framework, they are incomparable, and improving one of them will not have any effect on the other. For instance, substantial subsidies are given for installing PV panels, when in fact, it is not helping the municipality to get any closer to the emission reduction goal. It was said that if the goal of improving energy efficiency is to reduce emissions, then the framework is not right. The interviewee argued that since the electricity from hydropower is part of the Nordic and European markets, a carbon component that is related to the actual electricity mix is needed. It was noted that the exact component related to a marginal use might not be possible to calculate, but there is a need for discussion of the principles on which this definition is made, which may lead to more well-informed incentives.

When being asked about what tools and assessment methods that could support a more holistic planning in the municipality, one of the interviewees expressed that, although such tools are welcomed and needed, there were doubts about the feasibility of creating them. Moreover, the belief in the benefits of such tools were limited. The opinion was that it is not hard to agree on the basic principles for an environmentally friendly city, such as mixed-use areas that have most services within 5-10 minutes of walking distance, placing housing close to public transport infrastructure, making electrical vehicles attractive, and strict building energy codes. Together, it was said, they will result in an energy efficient, climate-friendly city, and to calculate and quantify the effects can be demanding. Even if it is possible, it was questioned whether such calculations are necessary.

3.4 Prioritizations of actions made on insufficient basis

There was a concern that there is not a good basis on which important decisions on prioritization of resources are **being made, expressed by one informant, saying that we are not doing enough cold, “cynical”, objective evaluations** on what measures will be important in reaching the goals. It was stated that choices are too often made to promote spectacular, visible lighthouses and that there is too little focus on what actually has an effect. Examples of this included the willingness to support research and infrastructure for hydrogen, and the subsidies on PV panels; both of these measures not **being coupled to the GHG emission reductions set by the municipality’s definition. It was** reasoned that when the municipality is setting such bold goals, money should be more deliberately spent on reaching those goals.

4. DISCUSSION

The scope defined by the municipalities will have a big effect on the outcome of GHG emissions accounting, and can to a large extent determine where the focus is put on energy and emissions reductions. Since Oslo is not allocating any emissions to the electricity or waste incineration in district heating, there is a danger of not putting enough effort into reducing emissions from these sources, and thus encouraging consumption of these. Oslo municipality argues that they do focus on both energy efficiency in buildings, decreasing energy consumption from heating (mostly based on electricity and district heating), and on reducing emissions from the district heating facility. These goals are also clearly stated in their Climate- and Energy Strategy. This reveals that the municipality has a systems view on their sustainability approach that surpasses their emissions accounting. Nevertheless, a **contradiction arises when two of the target areas by the municipality's definition are not related to GHG emission reduction**, but rather on energy efficiency in buildings and water-based heating and cooling systems. Fossil fuels are being phased out from these two areas, which will soon render them emission free by this definition. We argue **that there is an inconsistency in the municipality's reasoning**, in that both electricity and waste incineration in district heating are considered to be emission-free, while at the same time energy use for heating and cooling in buildings is given high priority. It is possible that having two separate goals, achieving higher energy efficiency and reducing emissions, might not be the best way of mitigating climate change. By using a conversion factor between electricity demand and emissions, such as the ones described in Graabak et al. (2014), the GHG reduction potential of reduced energy use can be compared with other GHG reduction efforts to assure that each area receives the prioritization that will have the most effect on emission reduction. We should, therefore, have a scientific basis for the effect of these measures, and align our goals and actions thereafter.

When building district heating infrastructure based on the assumption that it is utilizing waste heat to recover energy, one should be careful that the infrastructure dependence on district heating does not make the municipality dependent on having a supply of waste beyond that which can be expected in the future. Especially since the municipality has a goal of reducing upstream waste, the future impacts of these two possibly conflicting efforts should be considered. An analogy can be drawn from research showing that there is a far greater benefit in reducing food waste than in recycling it for energy recovery (Hamilton et al., 2015).

In the interviews, it became clear that energy planning follows after land-use plans are developed. This is consistent with Kuronen et al. (2010) and signifies improvement potential in a stronger integration of the two sectors (Korhonen, 2004). Efforts in the municipality should thus be continued in this area. Stronger inter-organizational integration could also be considered, as argued by Korhonen (2004).

A concern was expressed in the interviews regarding the importance of achieving, and the feasibility of achieving, an integrated model for urban energy planning and land-use planning. Although the difficulties of isolating variables and creating such a model are documented in literature (Weisz and Steinberger, 2010), as described in Section 1, integrated assessment has proven successful despite the complexity of the energy sector (Agusdinata and DeLaurentis, 2008). While there is still a need for improvement of models, there is significant potential for urban energy systems modeling to move from single disciplinary approaches to a sophisticated integrated perspective (Keirstead et al., 2012). Quantifying to what extent different measures are successful can lead to the formation of more effective strategies.

The difficulty in transforming existing built areas is a barrier to reducing transport, renewing energy solutions, and altering urban form. There is thus a need for planning tools that reduce the challenges associated with this transformation.

We do not argue that cities should be planned only according to energy and emission reduction, but that a large fraction of the planning process can be done in this way, and that it is possible to make better quantitative integrated solutions than the ones used for the decisions taken today in the planning practice.

5. CONCLUSION

From the interviews, it was found that there are some underlying challenges and areas of conflict that materialize as hindrances to reaching the goals set by the municipality. The energy planners find it hard to achieve the goal of a zero-emission city without a clear framework for evaluating alternatives and a holistic calculation tool for determining the effects of policy choices. There is thus the need for the development of such a tool and a scientific discussion on how to evaluate alternatives in a holistic way.

This research is part of a work to map the needs of municipalities in the transition to sustainable cities. The work will continue in other municipalities. Thereafter, based on the results we will develop methods and tools that will tackle the obstacles discovered.

REFERENCES

- [1] AGUSDxxINATA, D. B. & DELAURENTIS, D. 2008. Specification of system-of-systems for policymaking in the energy sector. *Integrated Assessment*, 8.
- [2] GRAABAK, I., BAKKEN, B. H. & FEILBERG, N. 2014. Zero Emission Building And Conversion Factors Between Electricity Consumption And Emissions Of Greenhouse Gases In A Long Term Perspective. *Environmental and Climate Technologies*, 13.
- [3] HAMILTON, H. A., PEVERILL, M. S., MÜLLER, D. B. & BRATTEBØ, H. 2015. Assessment of Food Waste Prevention and Recycling Strategies Using a Multilayer Systems Approach. *Environmental science & technology*, 49, 13937-13945.
- [4] KEIRSTÉAD, J., JENNINGS, M. & SIVAKUMAR, A. 2012. A review of urban energy system models: Approaches, challenges and opportunities. *Renewable and Sustainable Energy Reviews*, 16, 3847-3866.
- [5] KORHONEN, J. 2004. Theory of industrial ecology. *Progress in Industrial Ecology, An International Journal*, 1, 61-88.
- [6] KURONEN, M., JUNNILA, S., MAJAMAA, W. & NIIRANEN, I. 2010. Public-private-people partnership as a way to reduce carbon dioxide emissions from residential development. *International Journal of Strategic Property Management*, 14, 200-216.
- [7] MINISTRY OF LOCAL GOVERNMENT AND MODERNISATION 2014. *Statlige planretningslinjer for samordnet bolig-, areal- og transportplanlegging*.
- [8] OSLO KOMMUNE 2016. *Byrådssak 33/16, Tilleggssak til Klima- og energistrategi for Oslo*. In: BYRÅDET (ed.).
- [9] WEISZ, H. & STEINBERGER, J. K. 2010. Reducing energy and material flows in cities. *Current Opinion in Environmental Sustainability*, 2, 185-192.

Citylab Action: Guiding Sustainable Urban Development

Jonas LIND^a, Josefin WANGEL^b, Ann-Kristin BELKERT^c, Tove MALMQVIST^d

^a KTH Royal Institute of Technology, Sweden, jonas.lind@sgbc.se

^a Sweden Green Building Council, Sweden, jonas.lind@sgbc.se

^b KTH Royal Institute of Technology, Sweden, josefin.wangel@abe.kth.se

^c Sweden Green Building Council, Sweden, ann-kristin.belkert@sgbc.se

^d KTH Royal Institute of Technology, Sweden, tove.malmqvist@abe.kth.se

ABSTRACT

This article reports on the development of the certification scheme Citylab Action. The process of development is described, design considerations for the scheme are accounted for, and results from a pilot study, in which twelve projects are testing the first part of the scheme, are provided. The scheme has been developed through an iterative process, involving more than 400 practitioners and experts. First a draft definition of sustainable urban development was formulated, based on an analysis of how urban development can contribute to national and international goals for sustainable development. The draft was then discussed in a series of workshops, after which the resulting comments and suggestions were used to develop the draft definition into a draft scheme. This resulted in the definition of 17 objectives for sustainable urban development. Moreover, ten effects were defined, clarifying what the scheme ultimately seeks to support.

The first version of the guide was released in October 2015. In essence, the guide defines what is important to consider when planning an urban development project. The guide was also complemented with a program for urban development projects, in which urban development projects that want to focus in sustainability can share knowledge and experiences. A pilot version of the program is running January to December 2016. The next step in developing the scheme is to follow up on the pilot, as well as to complement the scheme with indicators and criteria for certifying the planning process, as well as for ex-post evaluation of the performance of the urban development projects.

Keywords: sustainable neighbourhood, certification scheme, pilot-study

1. INTRODUCTION

Certification schemes for sustainable neighbourhoods work through establishing a number of criteria and related indicators, supporting specific processes (e.g. public consultation) and features (e.g. solar panels) as well as for ex-post performance evaluation (e.g. kWh/m² and year). Several studies have dug into these systems, identifying a few re-occurring challenges such as the balance between different dimensions or impact categories/spatiality of sustainability and the balance between mandatory and non-mandatory criteria

Since 2010 there has been an on-going discussion in the Swedish built environment sector about the need for a certification scheme for sustainable urban development, developed for the Swedish context. Within this discussion different international certification schemes were evaluated, showing that while certification schemes are seen as having clear benefits, they need to be complemented with a forum for learning and exchange. This article reports on the development of the certification scheme Citylab Action. The process of development is described, design considerations for the scheme are accounted for, and results from a pilot study, in which twelve projects are using the first part of the scheme, are provided.

2. DEVELOPING CITYLAB ACTION

2.1 Beta-testing BREEAM communities

To investigate whether BREEAM-C (BREEAM Communities) would be suitable for a Swedish context Sweden **Green Building Council (SGBC) and the project “Nordic Built - Nordic Urban Development” arranged a series of beta-tests.** The beta-tests were carried out in cooperation with 22 urban development projects in Sweden which tested themselves against the **BREEAM-C’s manual to evaluate whether, and for what aspects, compliance with the certification scheme would lead to a more sustainable urban development or not.** In order to collect the different

views and opinions on BREEAM-C all beta tests were thoroughly documented. Moreover, a SWOT-analysis of using BREEAM-C in Sweden was carried out, the contact persons for each of the participating urban development project was interviewed [see 9] and a two-day concluding workshop was held when all beta-tests had been conducted. The concluding two-day workshop gathered partly the same persons as the interviews but also others that had been involved in the beta-tests. These evaluations together with the overall result from the beta-tests were the main basis when deciding whether to develop a Swedish certifications scheme or not. The results from the beta-tests, SWOT-analysis, interviews, and workshop pointed in two main directions. On the one hand, the participants recognised a number of positive effects of using a certification scheme. Certifying an urban development project is an opportunity to promote both the urban area being developed and the municipality as a whole, something that was seen as a way to attract both inhabitants and companies to the municipality. Using a certification scheme was also seen as providing a structure for integrating sustainability considerations into the **development process. This involved both using the certification as a 'checklist' to make sure that all** aspects are considered, but also using the certification scheme as an argument to implement actions which would be difficult to get realised otherwise. On the other hand, the respondents and workshop participants also raised some drawbacks of using BREEAM-C as a certification scheme in Sweden. BREEAM-C is based on a British context that in several ways do not correlate to the Swedish planning context resulting in a need for major adaptations. These differences include legislation, standards, praxis, the organisation of planning etc. An adaptation would also have needed to consider the differences in how different aspects of sustainability is handled in the two countries. Moreover, besides from commenting on the manual as such, several participants also voiced a need for a network for people working with sustainable urban development, to facilitate knowledge sharing between different actors and urban development project, something that BREEAM-C did not support. SGBC could thus conclude that while there was a clear recognised added value of a certification scheme, especially if it was complemented with a networking components, these values were of a general character and not related to BREEAM-C as such. Consequently, instead of adapting BREEAM-C to a Swedish context, SGBC decided to develop a new certification scheme.

2.2 Developing a new system – Guide, programme and certification

The creation of a new Swedish certification scheme started with the definition of draft core issues. These were based on the **conclusions of the governmental investigation "The Delegation for Sustainable Cities" [12], national environmental objectives, the beta tests and other workshops from earlier in the project [10] [11] etc.** The draft core issues were then discussed during ten open workshops in 2014-2015, lead by the research project Decode and co-organised with ten municipalities, involving about 400 people from government agencies, municipalities, developers, real estate companies, energy companies, consultants, architects, research institutes, universities, politicians etc. Using the core issues as starting point, the workshops focused on what to include in a certification scheme and transforming the core issue into concrete measures and desired outcomes.

After the workshops the draft core issues were handed to fifty experts on urban development for further **development. SGBC's members (real-estate owners, municipalities, property developing companies, consultant companies etc...) were also involved through monthly web-meetings.** Parallel projects working with sustainable urban development such as C/O City and Södertörnsmodellen also contributed to the development. The expert group handled all comments and suggestions. In June 2015 a demo version was released followed by a five-month referral process to which 18 of SGBCs member-organisations provided feedback. Additional input to the revision came from the UN Sustainable Development Goals (SDG) established in September 2015. In October 2015 the **first version of Citylab Action's "Guide for Sustainable Urban Development" could be released. The Guide is not yet developed for certification but concentrates on what sustainability issues that are important and how to work with these issues to create a more sustainable urban development.**

As concluded in the beta tests of BREEAM Communities, there was a need for something more, which a guide or a certification scheme could not fulfil: a need for knowledge sharing between different actors and urban development projects. The program Citylab Action was thus developed to support public and private stakeholders to develop their project specific sustainability programs and action plans. The aim of the program was also to facilitate a sharing of knowledge, experiences and ideas within the Swedish built environment sector.

3 INTRODUCING CITYLAB ACTION

3.1 The guide

The Guide is structured in three main parts: Desired Effects (Table 2) stipulate the intended outcome, and as such work as a definition of a sustainable city; the Sustainability Issues (Table 1) provide a concretization of what issues projects need to work with in order to realise the Desired Effects; and the Working Process (Table 2) which formulates aspects regarding management, participation and innovation throughout the project, which are fundamental to turn visions into reality.

Category	Issues	Issues elaborated
<i>Spatial and integrated urban qualities</i>	1 Built environment	Resource-efficient use of land to create a physically connected and socially integrated city.
	2 Cultural values	Preservation and use of existing cultural values and heritage.
	3 Functions	Diversity in design and functions (housing, service, culture, work-places).
	4 People	A good living environment with a minimized environmental footprint for residents, visitors and workers.
<i>Proximity and accessibility to functions</i>	5 Transport	Proximity and accessibility to urban functions and support sustainable transport (walking, biking, public transport, and delivery).
	6 ICT	Development and provision of information and communication technologies and data to support sustainability.
	7 Places	Access to safe and secure public and semi-public places in built and natural environments for people no matter ethnicity, gender, disabilities or age.
	8 Schools	Good indoor and outdoor environment in schools and preschools.
<i>Air, light and soundscape</i>	9 Air	Good air quality.
	10 Light	Good lighting conditions in support of orientation, road safety, security and aesthetics.
	11 Soundscape	Noise management so as to avoid negative health effects such as stress, hypertension, sleeping and concentration difficulties or general discomfort.
<i>Multifunctional green areas and climate adaptation</i>	12 Green areas	Multifunctional green areas and ecosystem services providing good quality of air, soundscape, and microclimate, supporting physical, psychological and social wellbeing.
	13 Climate adaptation	Increased robustness and decreased vulnerability for future extreme weather events, sea level rise and increase in temperature.
<i>Sustainable resource use</i>	14 Material flows	Low resource use and the establishment of circular flows of biological renewable and technical non-renewable resources.
	15 Products	Choice of products and materials that minimize emissions of hazardous substances to air, water and soil, and that creates possibilities for good working conditions.
	16 Water	A reliable and efficient water supply system, and a sustainable management of storm and sewage water.
	17 Energy	Minimized use of energy, coming from renewable energy sources with delimited impact on health and environment, and with close to zero GHG emissions.
	Synergies and conflicts	Conflicts between project targets and local, regional, national or international targets; Synergies and conflicts between project targets; Risk analysis for not reaching the targets; Identification of success factors

Table 1: Sustainability issues in Citylab action

Desired effects	Working process
1 Health and wellbeing	<i>Organisation</i> Management, skills staffing and coordination of sustainability.
2 Equality and social cohesion	
3 Participation and influence	
4 Safe living environment	<i>Collaboration</i> Strategies, processes, tools and methods for coordination of the different actors involved in the project.
5 Good livelihoods	
6 Attractive city-life	
7 Resource management	<i>Participation</i> Strategies for participation of inhabitants and local actors, and for how to handle conflicts of interest.
8 No negative climate impact	
9 No negative environmental impact	
10 Resilience and flexibility	<i>Innovation</i> Strategies to promote innovation.

Table 2: Desired effects and working process

Citylab Action's "Guide for sustainable urban development" looks quite different from other certification schemes. The Guide is not a "technical manual", stating how many points or what grade a certain action is worth or equal to and there are just a few issues that are formulated in quantitative terms. Instead the idea of the guide is to be a structure for the collaboration between the actors involved in an urban development project and support the process of transforming visions about sustainable urban development into concrete action. It should also be adaptable to different projects of different sizes and with different sustainability challenges. Indeed, this flexibility also brings about with challenges when it comes to certification, for which assessment criteria and indicators will need to be established.

3.2 The Program

As previously mentioned, one important part of the idea of Citylab Action is also to facilitate a sharing culture so **that different actors within the Swedish built environment sector learn from each other's mistakes and successes.** In order to do that a Program was developed, based on the Guide, to support urban development projects with sustainability ambitions. The Program builds on the pedagogical concepts of the flipped classroom and peer learning. During a 12-month period, participating projects meet at six two-day meetings. At every meeting one process theme and several sustainability issues from the Guide is discussed (see Table 3). Also, external experts are invited to speak and different exercises are arranged to make it possible to try new methods or to get new perspectives. The participating projects then starts their internal discussions about how they work with the issues and themes in their respectively projects and how to develop that work. After the meeting the work continues at home, where every project formulates their own targets, action plans and strategies to follow up the targets and actions. At the next meeting the participating projects presents their targets, action plan and strategies for follow-up for each other in so called peer-groups, letting individuals from the projects sit down and discuss the different **projects' respective difficulties and share ideas for the development. At the sixth and final meeting the projects present their final results: a sustainability program for the project and a plan for implementation and follow-up.**

	Meeting 1	Meeting 2	Meeting 3	Meeting 4	Meeting 5	Meeting 6
	2016:01	2016:03	2016:05	2016:08	2016:10	2016:12
	Uppsala	Göteborg	Eskilstuna	Norrköping	Helsingborg	Malmö
Process theme	Organisation	Participation	Collaboration	Innovation	Implementation	
Sustainability Part 1	Conditions for sust. development	Place and connectivity	Mixed, heterogeneous city	Energy use and renew-able energy	Social life and sustainable behaviour	
Issues	1-17	1-4	3, 5-8	17	4, 7-8	Presenting sustainability program
Sustainability Part 2	Sustainable opportunities and life quality	Ecosystem services and green structures	Sustainable transport, mobility and ICT	Resource management	Sustainable quality of life	
Issues	1-17	12-13	9-11	14-16	4, 7-8	

Table 3: Structure and content of Citylab action programme

To promote the sharing culture of Citylab Action, only projects that have been participating in the Program can be certified. However, a project does not have to certify or try to certify according to Citylab Action to participate in the program.

4. PILOTING CITYLAB ACTION

In January 2016 a pilot-version of the program was launched. Twelve different urban development projects (Table 4) participate in six two-day meetings, running January to December 2016.

Participating projects	New development	Retrofitting with new development	Mostly housing	Mixed use	Mostly business	Municipality
Barkarbystaden TRE	x			x		Järfälla
Campus Albano	x			x		Stockholm
Drottning H		x	x			Helsingborg
Falsterbokanalen	x			x		Vellinge
Lommarstranden	x		x			Norrälje
Masthuggskajen	x			x		Göteborg
Norrälje Hamn	x			x		Norrälje
Rosendal	x			x		Uppsala
Skeppsbron	x			x		Jönköping
Solna Business Park		x			x	Solna
Stadsläkning Lagersdal		x	x			Eskilstuna
Täby Park	x			x		Täby

Table 4 Overview of projects participating in the pilot version of the program

At the time of writing this paper 4 out of 6 meetings have taken place, implying that all findings must be treated as preliminary. The findings presented here are mainly based on the evaluations that participants have been asked to fill in after each meeting. With a response rate of around 50 %, a vast majority (95 %) have found the program valuable and would recommend others to participate. All parts of the program; lectures, exercises, working within the project group, discussing issues in mixed groups; are popular with 85-98 % saying it was valuable for the project. Several of the contact persons for the participating projects have also expressed their satisfaction about the program, pointing to that it gives a needed structure to the sustainability work, that it gives the project an otherwise missing forum for discussions between the involved actors, and that it makes it possible to ensure that **sustainability is integrated in the project and does not become “bolt on” project.**

Since the Program is based on the Guide, the pilot version of the program is also a test of the first version of the Guide. The Guide has not yet been evaluated in any structured manner apart from that the participants in the Program has been encourage to give comments by post-it notes during the meetings as well as in a digital platform between the meetings. The comments have so far been focused on formulations of specific sentences, aspects missing among the issues and questions about what, more specifically, is meant with certain formulations.

Participants in the Program express that they find the Guide useful (also see [19]) as a checklist to ensure that they do not miss any important issues. The desired effects are here crucial and used at every meeting and by the projects back home to evaluate objectives and planned actions to see whether the project as a whole steer towards all desired effects or just some of them. Finding ways to optimise the actions to steer towards more than one of the desired effects at a time. One of the urban development projects even reorganised their organisation after the first meeting in the program. The new organisation was based on the recognition that to ensure that sustainability not becomes a special interest guarded by a certain group, it must be integrated into the entire organisation.

5. CONCLUDING DISCUSSION

Looking at the preliminary results of the evaluation of the pilot version of the Program, the participants seem satisfied with how the Guide and the Program helps them with formulating their own objectives, action plans and strategies for follow-up. Based on the evaluation we can also draw the preliminary conclusion that the Guide and the Program together seem to cater for the two key functions of a certification scheme requested by the participants in the beta-tests and workshops: a structure and a checklist for action, and a forum for sharing of knowledge, ideas and experiences. This shows that involving the target group early in the process of creating Citylab was important in order to create something that suited the needs of both private and public stakeholders.

Even though participants express a satisfaction of the Guide and the Program there are work left to do. First of all, the Guide needs to be developed with assessment criteria for both the planning phase and to evaluate ex post performance. Moreover there is a need to establish routines for continuous evaluation and development of the Guide and the Program in order to keep it up to date with how technology and society develop. Finally, given that it is the Program that is the most innovative part of Citylab Action, the knowledge sharing and learning aspect of the system would benefit from deeper theorizing.

REFERENCES

- [1] Wangel, J., Wallhagen, M., Malmqvist, T., Finnveden, G., 2016. Certification systems for sustainable neighbourhoods: What do they really certify? *Environ. Impact Assess. Rev.*, 56, pp. 200-213.
- [2] Sharifi, A., Murayama, A., 2013. A critical review of seven selected neighborhood sustainability assessment tools. *Environ. Impact Assess. Rev.*, 38, pp. 73–87.
- [3] Berardi, U., 2013. Clarifying the new interpretation of the concept of sustainable building. *Sustainable Cities and Society*, 8, pp. 72–78.
- [4] Zhou, C., Dai, X., Wang, R., Huang, J., 2011. Indicators for Evaluating Sustainable Communities: A Review. *Shengtai Xuebao/Acta Ecologica Sinica*, 31, pp. 4750–4759
- [5] Haapio, A., 2012. Towards sustainable urban communities. *Environ. Impact Assess. Rev.*, 32 (1), pp. 165–169.
- [6] Sharifi, A., Murayama, A., 2014. Neighborhood sustainability assessment in action: cross-evaluation of three assessment systems and their cases from the US, the UK, and Japan. *Build. Environ.*, 72, pp. 243–258.
- [7] Garde, A., 2009. Sustainable by design?: insights from U.S. LEED-ND pilot projects. *J. Am. Plan. Assoc.*, 75 (4), pp. 424–440.
- [8] Kyrkou, D., Karthaus, R., 2011. Urban sustainability standards: predetermined checklists or adaptable frameworks? *Procedia Engineering*, 21, pp. 204–211.
- [9] Lind, J., 2014. BREEAM Communities – Dyra prestigeprojekt för internationell marknadsföring eller smidigt verktyg som standard för stadsplanering?, Stockholm: Degree project at KTH Royal Institute of Technology.
- [10] Sweden Green Building Council, 2014. Slutrapport Betatester Resultat från stadsutvecklingsprojekt som har testat och utvärderat BREEAM Communities, Sundbyberg: SGBC.
- [11] Björk Jónsdóttir, S. et al., 2016. Nordic Built - Nordic Urban Development, u.o.: NORDIC INNOVATION PUBLICATION.
- [12] Delegationen för hållbara städer, 2012. Femton hinder för hållbar, Statens offentliga utredningar: (english version available at: <http://www.boverket.se/contentassets/b70dc5ef8b9f456fac54ad82fc135448/barriers-to-sustainable-urban-development.pdf>)
- [13] Decode, 2016. DECODE – Community Design for Conflicting Desires, u.o.: Final Report Vinnova Challenge-driven Innovation.
- [14] UN, 2015. Sustainable Development Goals. [Online] Available at: <http://www.un.org/sustainabledevelopment/sustainable-development-goals/>
- [15] C/O City, 2015. C/O City, Urbana ekosystemtjänster, Stockholm: Final Report Vinnova Challenge-driven Innovation.
- [16] Södertörnsmodellen, 2016. Södertörnsmodellen, Stockholm: Final Report Vinnova Challenge-driven Innovation.
- [17] Strayer, J. F., 2012. How Learning In An Inverted Classroom Influences Cooperation, Innovation And Task Orientation. *Learning Environ Res*, 15(2), pp. 171-193.
- [18] Mazur, E., 1997. **Peer Instruction: A User's Manual**. Upper Saddle River, N.J.: Prentice Hall.
- [19] Liljefors, P., 2016. Social sustainability in Swedish urban development – what does it mean? A case study of three Citylab Action pilot projects. Degree project at KTH Royal Institute of Technology.

The Break-Even Point: Impact of Urban Densities on Value Creation, Infrastructure Costs and Embodied Energy

Serge SALAT^a

^a Urban Morphology and Complex Systems Institute, France, serge.salat@gmail.com

ABSTRACT

This paper, based on the science of complex systems applied to cities, presents new findings on the impact of density on urban space economy: urban spatial expansion and value added creation *versus* additional urbanization costs. The paper proposes a new metric, the hierarchy coefficient in Pareto distributions, to describe the distribution of densities across urban space.

Based on case studies in London, Paris, New York, and a Chinese city, Zhengzhou, the paper reveals striking mathematical regularities, independent of the cities and their history, in the distribution of people, jobs, and energy densities within the urban space. This hidden order behind the apparent randomness of urban data points towards universality classes in the organization of cities. These findings have important policy implications for coordinating land use, transport, and economic policies in particular by determining a break-even point beyond which urban expansion costs more than the derived benefits.

Keywords: density, energy efficiency, agglomeration economies, complex urban systems

1. DECOUPLING

In economic and environmental fields, decoupling is becoming increasingly used in the context of economic production and environmental quality. When used in this way, it refers to the ability of an economy to grow without corresponding increases in environmental pressure. In many economies, increasing production (GDP) raises **pressure on the environment**. A “decoupled” economy is able to increase GDP growth while decreasing its negative impact on environment.

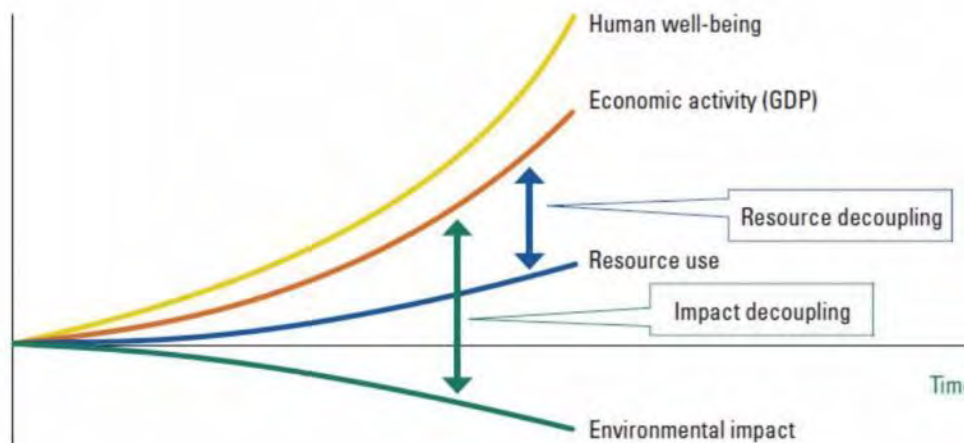

Figure 1: Decoupling human development and economic growth from escalating resource use and environmental degradation: resource decoupling: less resource use per unit of output; impact decoupling: less environmental impact per unit of output. source: International Resource Panel 2011.

This paper describes how shaping residential and economic densities at metropolitan scale is a powerful policy lever for decoupling.

2. THE SPIKY GEOGRAPHY OF URBAN PRODUCTIVITY

2.1 The 80/20 Rule in urban spatial economics

The 80/20 Rule is observed in many social and economic phenomena. Vilfredo Pareto was the first to see in the early 1900s that 80% of Italy's land was owned by only 20% of the population. More recently, Pareto's Law or Principle, known also **as the 80/20 rule, has been turned into the Murphy's Law of management: 80% of profits are produced by only 20% of employees; 80% of customer service problems are created by only 20% of consumers; 80% of decisions are made during 20% of meeting time; and so on.** The 80/20 Rule describes the same phenomenon: in most cases four-fifths of our efforts are largely irrelevant. The 80/20 Rule structures social networks: 80% of links on the Web point only to 15% of Webpages; 80% of citations go to only 38% of scientists; 80% of links in Hollywood are connected to 30% of actors.

The 80/20 Rule structures also the global economy. Today only 600 urban centers generate about 60 percent of global GDP. Among these, the top 10 cities with 2% of the world population generate about 11% of the world GDP. Only one city at the top of the global economy, Tokyo, generates about 20% of the top ten cities cumulated GDP. The 80/20 Rules structures also intra urban economic space. Within a city, 20% of the urban land produces 80% of the city's GDP. Inner London with 20% of Greater London area produces 70% of its GVA and concentrates 56% of all Greater London private sector jobs. This is due to strong agglomeration and localization economies.

2.2 Bumpy and spiky economic landscapes

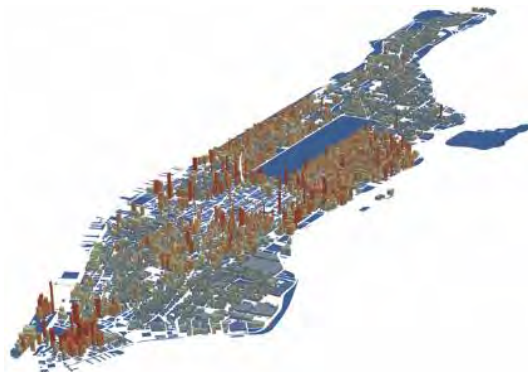

Figure 2: Left: residential far in manhattan. source: urban morphology and complex systems institute.

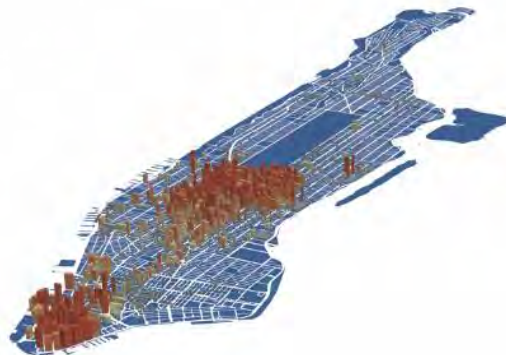

Figure 3: right: office far in manhattan. office space in manhattan (66 km²) corresponds to 60 % of the entire new york city office space while NYC spans 780 km² of emerged land with 8.5 million inhabitants. this office space is concentrated in only 6 km² of plots, which roughly correspond to 9 km² of urban land. source: urban morphology and complex systems institute.

Urban productivity results from a complex interaction of processes, including economies of scale and economies of agglomeration and localization induced by cost savings, location advantages, specialization premiums, and by the higher intensity of interactions between people and companies. Agglomeration forces translate into bumpy and spiky urban economic landscapes. In competitive cities, such as London and New York, one third of the jobs are agglomerated in about 1% of the metropolitan area creating intense knowledge spillovers, while the other two-thirds are clustered around transit stations. High densities of jobs increase productivity, competitiveness and job

creation: 29% of Inner London office space is concentrated in less than 1% of its area, in the City of London (450,000 jobs in 2.9 km² with a growth of 30% during the last decade); 60% of New York City office space is concentrated in 9 km² in Manhattan, that is in about 1% of NYC area. These extreme concentrations peak at 150,000 jobs/km² and are made livable by high quality public space like in London's Canary Wharf or in the project of Hudson Yards in Manhattan.

2.3 Pareto distributions: the hidden order of spiky economic landscapes

Within the high spike of wealth and economic might of Central London (309 km²), the Square Mile of the City of London (2.9 km², 10% of Central London, 1% of Inner London, and less than 0.2% of Greater London) concentrates a disproportionate part of economic power in an extreme spike. The Square Mile of the City of London generates £45 billion in economic output in 2014, equivalent to 14% of London's output and 3% of the UK's total GDP. The cascade of spikes within spikes, The City of London spiking extremely high within the high spike of Inner London, points to a fundamental property of the 80/20 rule when applied to urban spatial economy: the rule applies at all scales; there is no characteristic scale; the rule is scale-free.

The new science of networks has shown that this scale free property is the intrinsic order to the number, size, and shape of the various attributes of networks (Barabasi 2014). And then in turn there is an intrinsic order of spaces and places that depend on urban networks. As summarized by Michael Batty, "in essence, the distribution of elements that compose the city - the hubs or nodes that sustain them - present us with highly skewed distributions, reflecting the essential economic processes of competition that drive a city's functions and determine its form and structure (Batty 2013)." These distributions usually describe large number of small objects and small number of large, following what are called scaling laws that, in turn, are usually configured as power laws, also called Pareto distributions in economy.

Power laws reflect processes that scale, that in some sense are self-similar, and this signature of a system's function implies that the system's subsystems, components, elements, are ordered hierarchically. These scaling processes generate urban growth and underpin the city's evolutionary architecture (Batty 2013), opening up our theory and model of urban economy to the world of complexity theory, to forms that associate a high level of order in their macro-structure with a high level of diversity and randomness in their details.



Figure 4: Inverse power laws: the hidden order of spiky economic landscapes. people, jobs, and economic densities, office space density, accessibility to jobs, rents, subway network centralities, and so on, across the urban space (Salat and Bourdic 2015) follow skewed distributions that are modeled by inverse power laws known in economy for a long time under the name of Pareto distributions. They comprise a few large and very large values (in green on the left) and a 'long tail' of small values on the right.

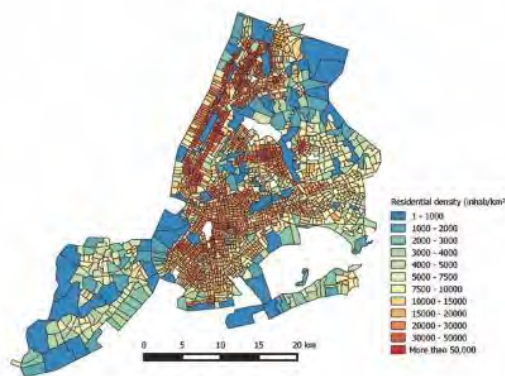

Figure 5: Left: The map of residential density in New York is aligned on the geography of transit accessibility to jobs. The higher the number of jobs a location has access, the more it is developed. Source: Urban Morphology and Complex Systems Institute.

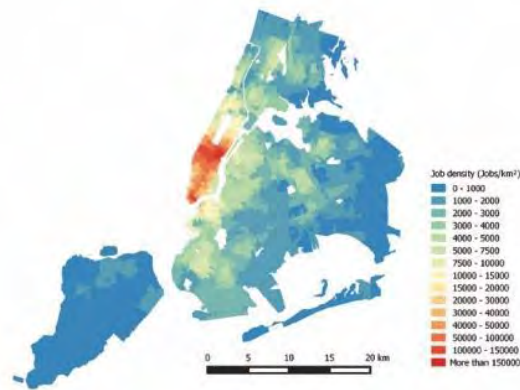

Figure 6: right: New York jobs are mainly concentrated in midtown and in lower manhattan with densities above 150,000 jobs per km² in these 2 economic engines of New York. Source: Urban Morphology and Complex Systems Institute.

Densities in New York are articulated by power laws. Residential density in New York is extremely concentrated and aligned with the geography of transit accessibility to jobs, with a density above 18,000 people/km² on the densest 150 km².

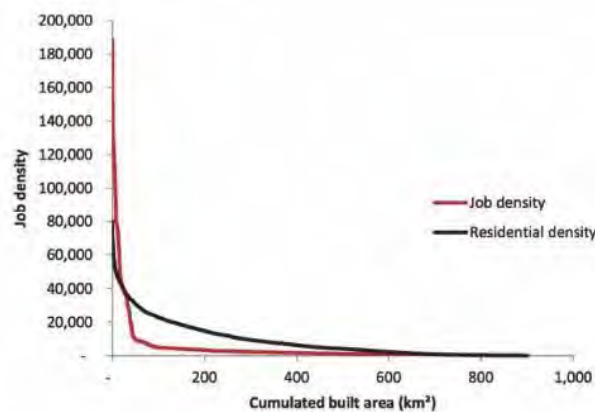

Figure 7: The jobs density distribution across New York urban space follows a power law of hierarchy exponent -1 (in a rank size analysis) while office density is even sharper in its spatial hierarchy with a hierarchy exponent -1.7. Residential densities are distributed more evenly than jobs with a hierarchy coefficient of -0.74. Source: Urban Morphology and Complex Systems Institute.

New York and London as well as Paris have the same distribution of jobs densities – a power law with an exponent -1 – which points towards what is called a universality class in physics, that is a convergence of different phenomena towards the same geometric structure. In statistical mechanics, a universality class is a collection of mathematical models, which share a single scale invariant limit. While cities, such as Paris, London, and New York, may differ dramatically at small scales, their behavior will become increasingly similar as the limit scale is approached. In particular, asymptotic phenomena such as critical exponents will be the same for all cities in the class. Studies of cities as percolation systems with phase transition points may explain these universality classes in urban systems.

3. THE SPIKY LANDSCAPE OF URBAN ENERGY

The spiky economic landscape translates into very high energy density spikes. The geography of energy consumption in competitive cities is extremely uneven, and this is an important key to energy efficiency as the highest spikes of energy density are also the highest spikes of economic density. Like the urban economy, the urban energy is scaling according to Pareto distributions. Urban GDP and urban energy consumption/unit of urban land are highly concentrated in peaks in the cores of global cities while peripheries are less energy intensive but produce much less added value. The ratio of added value to energy inputs measures the different energy productivities across the urban space. The bumpy and spiky distribution of both energy consumption and value added per unit of land has important consequences for the choice of modes of decentralized energy supply, which varies between high energy intensity centers and low energy intensity peripheries.

3.1 The hidden order of urban energy landscapes

New York City energy landscape presents a high level of variation at each scale, from NYC scale (780 km² of emerged land), to block scale, and to fiscal plot scale (200 m²). It is a scale-free landscape with no characteristic average value for the energy use on a plot of land. These energy density variations of 100-fold within the same city matter and have strong impacts on the possible types of energy mix in each neighborhood. A power law orders the energy densities in New York. This is the signature of a scale free distribution of energy consumption across the urban space.

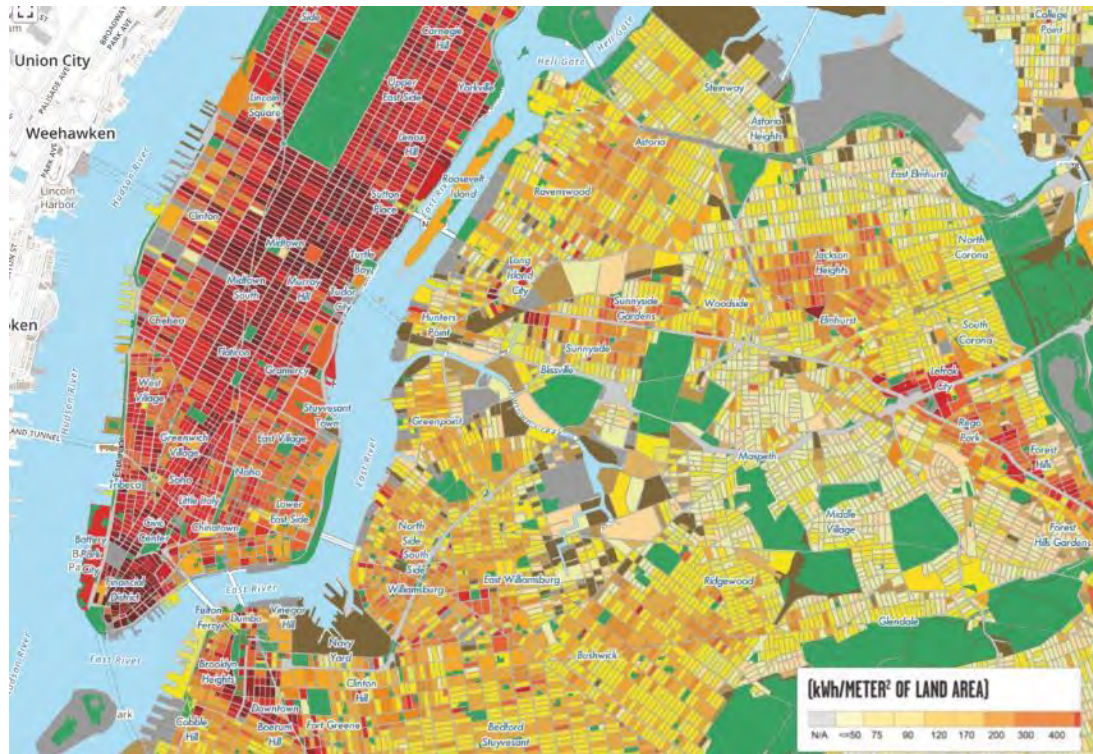

Figure 8: The map above represents an estimate of the total annual building energy consumption at the block level and at the tax lot level for New York City, and is expressed in kilowatt hours (kWh) per square meter of land area. A mathematical model based on statistics, not individual building data, was used to estimate the annual energy consumption values for buildings throughout the five boroughs.

Map created by Shaky Sherpa of Sustainable Engineering Lab (formerly Modi Research Group). Data Source: Spatial distribution of urban building energy consumption by end use B. Howard, L. Parshall, J. Thompson, S. Hammer, J. Dickinson, V. Modi

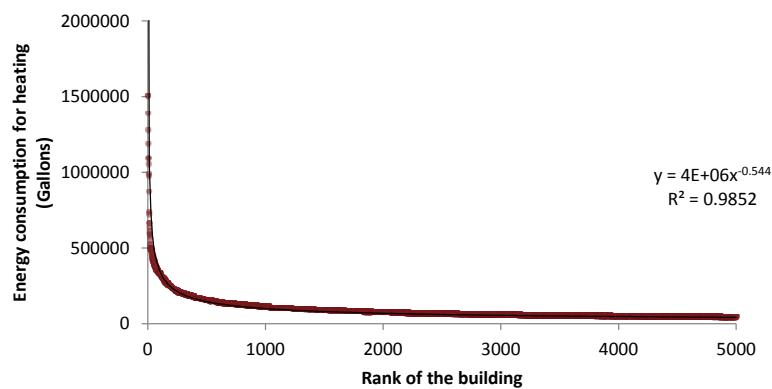

Figure 9: Heating energy by building in NYC. The energy consumption is ranked from the highest consuming large-scale office towers (on the left) to the long tail of residential houses (on the right). The distribution describes both the scale free structure of NYC urban fabric (here described by buildings) and the scale free structure of NYC building's energy consumption across the urban space. Source: Urban Morphology and Complex Systems Institute.

3.2 Spikes of economic density and energy correspond to higher energy efficiencies

As shown in the following maps, London's energy and economic landscapes reflect each other with peaks of high concentrations in the City of London and the Docklands (Canary Wharf).

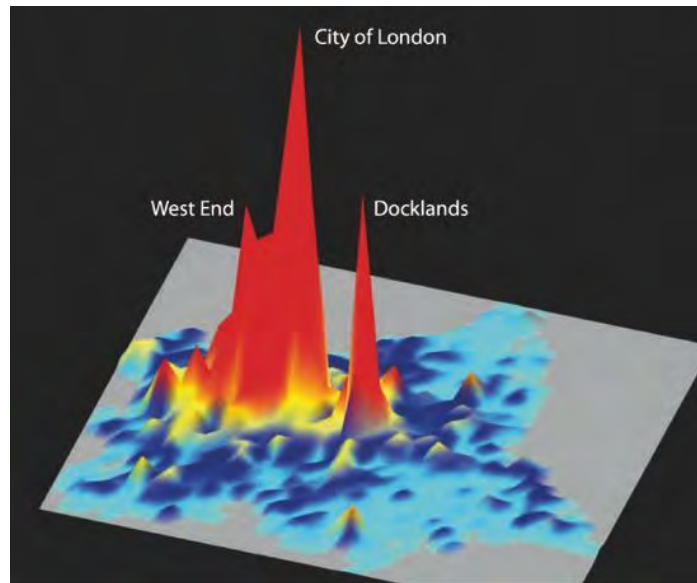

Figure 10: London energy landscape is characterized by a high spike of energy density (here electricity per unit of land) of more than 300 MW/km² in the city of London.



Figure 11: Distribution of workplace densities in London, using census output areas, with a peak of 150.000 jobs per km² in the square mile of the city of London. Source: Urban Morphology and Complex Systems Institute.

The following charts show that in terms of energy productivity (GVA/E), the City of London stands out due to its agglomeration economies and specialization.

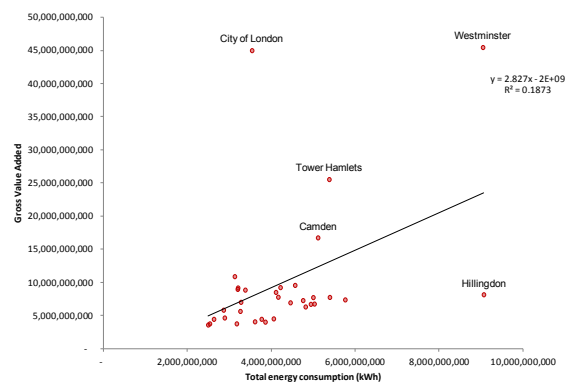

Figure 12: Left: GVA and total energy consumption in London boroughs. Source: Urban Morphology and Complex Systems Institute.

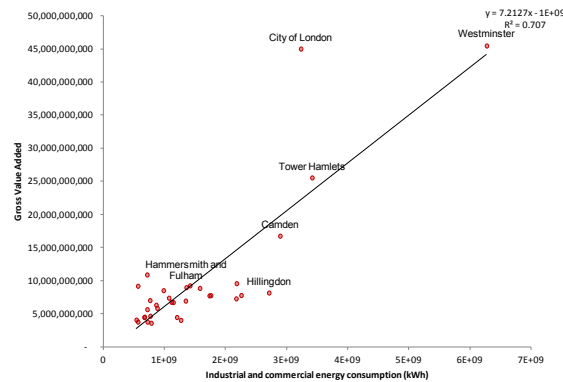

Figure 13: Right: GVA and industrial and commercial energy consumption in London boroughs. Source: Urban Morphology and Complex Systems Institute.

4. THE BREAK-EVEN POINT

In economics and business, specifically cost accounting, the break-even point (BEP) is the point at which cost or expenses and revenue are equal: there is no net loss or gain, and one has "broken even." Understanding the hierarchies in GDP creation across the urban space and the variations of costs of networks across urban space, allows determining a break-even point. There is a limit radius where further spatial expansion at low density produces less value added than it costs in infrastructures.

Our empirical research has shown that urban GDP is, like jobs densities, distributed according to a Pareto principle with 20% of urban land producing 80% of urban GDP while 80% of the urban land produces only 20% of the GDP. This is verified with the differences in GDP between Inner London and Outer London, and has been verified under the form on an inverse power law of exponent -1 in a detailed study of Zhengzhou in China and is more broadly confirmed by the universal power law with an exponent close to -1 that organizes the distribution of jobs densities in the urban space in Paris, London and New York. The Pareto structure of urban economic space derives from two combined self-reinforcing effects: the Pareto distribution ordering jobs distribution across the urban space, and the higher productivity per job in the left part of the Pareto curve because of strong agglomeration economies in this left part. Urban GDP follows a power law of exponent about - 1.

Networks lengths/km² and costs/km² decrease also with urban expansion because of their fractal nature but more smoothly (Batty and Longley 1994, Salat et al. 2011, Salat and Bourdic 2015). They decrease at the power - 0.5 for subway systems, due to the core and spokes structure of these networks (Salat and Bourdic 2015), and more generally with a scaling exponent depending on the fractal nature of the specific network (Batty 2013).

Thus as GDP decreases more sharply than infrastructure costs with spatial expansion, beyond a certain radius, infrastructure lengths and costs (and embodied energy in infrastructures) become higher than additional economic output. As a result, urban land is less and less economically productive and more and more costly in terms of infrastructures, and embodied material and energy when moving away from the urban core. This pattern is captured in the following charts.

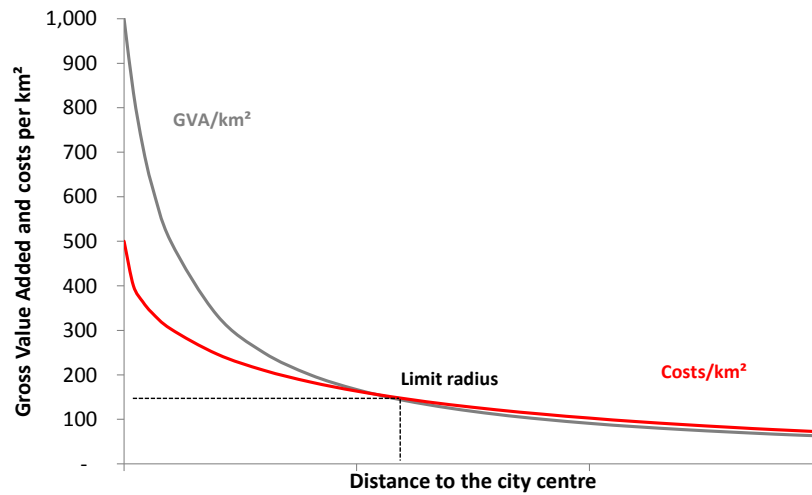

Figure 14: GVA/km² versus infrastructure costs/km² Source: Urban Morphology and Complex Systems Institute based on international benchmarks of infrastructure costs per km² linking urban density and pavement costs, water network costs, waste water network costs (Bourdic and Kamiya 2016, Müller et al. 2013).

The decrease in densities when moving away from the urban core induces also higher infrastructure costs per capita. The following chart describes the relationships between economic productivity (measured per capita) and infrastructure costs per capita.

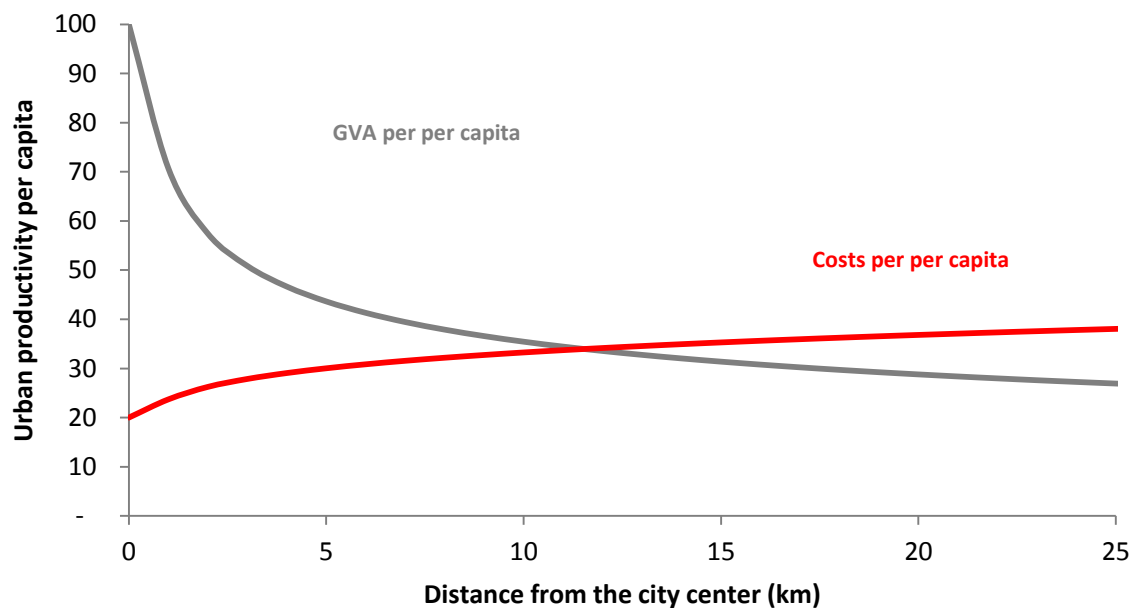

Figure 15: GVA and costs per capita across urban space. Source: Urban Morphology and Complex Systems Institute.

5. CONCLUSION

Sprawl is thus a highly inefficient pattern where costs become higher than economic benefits after a break-even point. Sprawl is central to our wasteful use of water, energy, and land. To move from sprawl toward more compact urban forms, urban connectivity and density must be intensified through changes in regulatory urban planning. Increasing densities around transit nodes will foster energy and resource productivity, decoupling urban economic growth from infrastructure costs and energy embodied in infrastructures.

REFERENCES

- [1] Barabasi, A.-L. 2014. *Linked: How Everything Is Connected to Everything Else and What It Means for Business, Science, and Everyday Life*, Basic Books.
- [2] Batty, M. and Longley, P. 1994. *Fractal Cities: A Geometry of Form and Function*, Academic Press. Available for download at <http://www.fractalcities.org>
- [3] Batty, M. 2013. *The New Science of Cities*, MIT Press.
- [4] Bourdic, L., Kamiya, M. 2016. **The Economics of the 'Three-Pronged Approach' to Urbanization: Planned City Extension, Legal Framework, and Municipal Finance**, Urban Morphology Institute, Paris / Urban Economy Branch, UN-HABITAT.
- [5] International Resource Panel, Fischer-Kowalski, M., Swilling, M. 2011. *Decoupling Natural Resource Use and Environmental Impacts from Economic Growth*. Nairobi: UNEP
- [6] Müller, D.B., G. Liu, A.N. Lovik, R. Modaresi, S. Pauliuk, F.S. Steinhoff, and H. Brattebo. 2013. **"Carbon Emissions from Infrastructure Development."** *Nature Climate Change*.
- [7] Salat, S. with Labbé, F. and Nowacki, C. 2011. *Cities and Forms – On Sustainable Urbanism*, CSTB and Hermann.
- [8] Salat, S. and Bourdic, L. 2015. **L'Économie spatiale du Grand Paris. Connectivité et création de valeur**, Urban Morphology Institute and Complex Systems Institute and Caisse des Dépôts.

Barriers and Needs for Energy-Efficient Refurbishment at District Level

Tarja HAKKINEN^a, Samo GOSTIC^b, Nusrat JUNG^c

^a VTT Technical Research Centre of Finland Ltd., Finland, tarja.hakkinen@vtt.fi

^b ZRMK, Slovenia, samo.gostic@gi-zrmk.si

^c VTT Technical Research Centre of Finland Ltd., Finland, nusrat.jung@vtt.fi

ABSTRACT

This paper aims to address the need and barriers involved in the development for energy-efficient refurbishment at the district level and making conclusions about the need for improved processes. By district-level refurbishment, we mean concurrent renovation of several buildings in a same district/neighbourhood with the view to achieving cost savings, financial benefits and a more efficient use of Renewable Energy Sources (RES). Also, full optimization and performance of the nearly zero energy buildings (nZEBs) require aspects such as the consideration of load-matching and grid interaction. District-level refurbishment projects may enable a better understanding of these aspects. On the other hand there may also be significant barriers related to several factors such as legal issues regarding town planning and building permission practices; legal issues regarding practices, taxes and fees of energy generation; presence of several owners; simultaneous presence of several actors including energy companies; lack of actors able to initiate and integrate; lack of business models for profitable work in district-level projects; lack of experience in using collaborative delivery models; lack of tools for energy assessment at district level; lack of process descriptions for district-level refurbishment, and lack of design methods for optimization of grid interaction and load matching.

To understand these barriers, interviews in eight European countries were conducted. The results show that most of the questions addressed are relevant to at least to some extent. Different actors in various European regions emphasize somewhat different aspects. However, the most significant problem was found to be the involvement of many owners in district-level refurbishment projects with differing interests and their difficulty in forming an agreement. Related to this, the lack of actors who would initiate the project and motivate owners, and other stakeholders were also imperative. Besides, current legislation causes significant hindrances for refurbishment at the district level in many countries.

Keywords: sustainable neighbourhood, design process, energy saving

1. INTRODUCTION

Currently, nearly zero energy buildings (nZEB) methods and technologies are implemented in a single building and not yet at the district level. To fully optimize the nZEB performance, aspects such as grid interaction and load matching are necessary since peak loads and voltage deviances require a proper synchronization of electricity consumption and production. Optimizing nZEB requires demand-side management, electric storage capabilities, and also minimization of energy delivered to the building. The presence of an existing grid or grid connection is not mandatory since district level refurbishment projects can benefit by sharing renewable energy resources, such as biomass-based micro combined heat and power (mCHP), solar for hot water and heating, or geothermal energy. They can then take advantage of load matching at a building group level to fulfil the yearly energy balance (Salom et al. 2014; Sartori et al. 2012). The focus is already shifting from single buildings towards nZEB neighbourhoods/districts. As defined by (Marique & Reiter 2014) nZEB neighbourhood is where the annual energy consumption and transportation of inhabitants are balanced by renewable energy production on site.

The main prerequisite for local distribution system as pointed out by (Salom et al. 2011) is that the energy system should be designed according to the electricity demand of the grouped buildings while considering load variations between the buildings. Load marching indicators can inform designers, architects and engineers in comparing different design options which would make use of planned integrated technology (such as mCHP), sizing of storage devices, strategies of sizing storage devices factoring in the events such as grid breakdown, etc. With a step ahead, **Ala-Juusela et. al proposed positive energy neighbourhoods, where 'the annual energy demand is lower than annual energy supply from local renewable energy sources,'** aiming to support even wider generation and distribution networks. Energy positive neighbourhoods can display key performance indicators including annual

mismatch ratio, maximum hourly supply, maximum hourly deficit and a monthly ratio of peak hourly demand in comparison to lowest peak power demand (Ala-Juusela et al. 2015).

Significant risks and barriers for energy efficient districts renovations include insufficient support from residents, collapse of available infrastructure, failure of new technology, not too many examples to follow, principle-agent problems, negative externalities, financing, etc. (Ahvenniemi et al. 2013; Sepponen & Heimonen 2016). The primary motivation to understand the barriers affecting refurbishment of districts is to build upon solutions such as financing possibilities, new business models such as ESCO, customer-oriented renewable model, utility-oriented model, heat entrepreneurship model, on-bill financing model, energy leasing model, etc. to support energy-efficient refurbishment at a district level.

1.1 Objective

The purpose of this study was to identify barriers pertaining successful renovation of multiple buildings in districts/neighbourhoods in seven European countries. To understanding the complex relationships between stakeholders in reference to district refurbishment in various European countries, the following barriers were considered and assessed in (1) Legal issues regarding town planning and building permission practices; (2) Legal aspects regarding practices, taxes and fees of energy generation; (3) Presence of several owners; (4) Simultaneous presence of several actors including energy companies, designers and consultants; (5) Lack of players able to initiate and integrate; (6) Lack of business models for profitable work in district-level projects; (7) Lack of experience in using collaborative delivery models; (8) Lack of tools for energy assessment at district level; (9) Lack of process descriptions for district-level refurbishment and (10) Lack of design methods for optimization of grid interaction and load matching.

2. METHOD

Interviews were carried out in eight northern and middle European countries including Finland, Germany, The Netherlands, Slovenia, Lithuania, Latvia, Poland, and Austria. The aim of the interviews was to understand specific barriers preventing the district level refurbishment. We also intended to ascertain if there are significant differences or several similarities among different European countries. Such findings are further useful in the future for developing business models to attain benefits of energy-efficient refurbishment at a district level and to spike interest through collaboration among stakeholder groups in Europe.

The interviews were conducted as face-to-face meeting or teleconferences. The duration of the meeting lasted for about an hour. In total 67 stakeholders (interviewees) from the above countries participated one at a time. However, in Poland and Lithuania, the stakeholders were interviewed as a group. In those cases, the individual responses were also recorded. The number of participants per European country is presented in Table 1. The interviewees were asked to categorize themselves among eight categories based on the role of their company and their particular role in the enterprise, as categorized in Table 1 (A) Building owners with large building portfolios; (B) Designers and consultants actively engaged in district refurbishment projects; (C) Energy company; (D) Town planning and building permission authority; (E) Renewable energy technology service provider; (F) Contractors and developers engaged in district level refurbishment projects; and (G) Maintenance and building managers as **illustrated in Figure 1. The interviewees were selected by the consortium teams part of 'Mobilization of innovative design tools for the refurbishing of buildings at district level' (MODER) project** which is present in each of the eight European countries except in Lithuania and Poland.

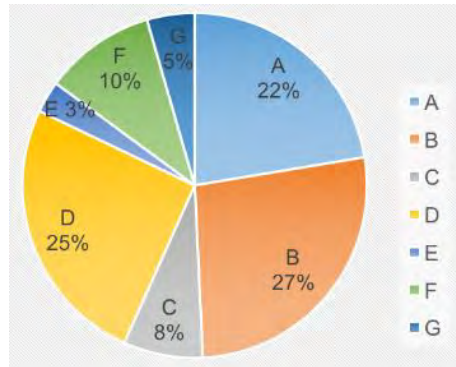

Figure 102: Percentage of respondents per category from all countries

The interviewees were provided with a set of barriers for assessing (as presented in Table 2) and the interviews were semi-structured to take advantage to document the experiences of interviews. They were also asked to determine the importance and validity of the claimed barrier on the scale of 1-5, where five was deemed very important and one as not relevant to their point of view. The list of presumed barriers is based on an extensive literature review which will be published in the future study and could not be included due to space limitation.

S.No.	Country name	No. of participants	Number of respondents per category (a.-g.)
1	Finland	23	5(A); 4(B); 3(C); 5(D); 2(E); 2(F) ; 2(G)
2	The Netherlands	6	2(A); 2 (B); 2(D)
3	Slovenia	13	2(A); 4(B); 2(C); 4(D);1(G)
4	Germany	4	2(A); 1(B); 1(D)
5	Lithuania	10	2(A); 4(B); 3(D); 1(F)
6	Poland	5	1(A); 1(B); 1(D); 2(F)
7	Austria	2	1(B); 1(D)
8	Latvia	4	1(A); 1(B); 2(F)

Table 19: Participants/ interviewees from each European country

S.No.	List of barriers presented as questions and discussion points to the interviewees based on extensive literature review
1	Legal and institutional barriers related to town planning and building permission practices
2	Legal and institutional barriers related to the practices, taxes and energy generation fees
3	Presence of several owners
4	Simultaneous presence of several actors
5	Lack of activators or integrators
6	Lack of business models
7	Lack of proper procurement and delivery models
8	Available energy performance tools at district level
9	Designing process and methods for refurbishment at district level
10	Design methods for the optimization of grid interaction and load matching

Table 20: List of presumed barriers presented as a set of questions to the interviewees

3. RESULTS

The cumulative results of all countries are presented in Figure 2 illustrating the importance of each barrier discussed in Table 2 and Figure 3 presents the standard deviation in the responses. This section will discuss each of the barriers selected as the most pertinent in each of the country.

The legal and institutional barriers associated with town planning and building permission process in Germany and Finland were found to be imperative. Typically, the planning processes are slow in Finland, because when a larger scale change is proposed which can influence the landscape of the site, local actors may oppose the change, which leads to further delays. The building approval process for multiple land plots at the same time is difficult to attain, but, municipalities, in general, were found to be supportive of energy efficient refurbishments. The Netherlands have strict laws protecting the rights of the tenant which are seen positively, at the same time it was found difficult for the building owner's/ housing associations to come to an agreement with the residents on needed refurbishments leading because it leads to increased rent. Similar legislation barrier was observed in Slovenia, at times 100% of the tenants/owners in a building are required to be in agreement on major renovations. Thus, we need to develop practical guidelines to support the large scale refurbishment process.

Legal and institutional barriers related to the practices, taxes, and fees on energy generation at a district level were seen as an obstacle in Finland, Germany, and the Netherlands. Most of the urban areas in Finland and Germany are connected to district heating, local energy generation in such scenario is not supported. In Finland taxation was seen as a barrier; when capacity is larger than 100kVA and the generation exceeds 800MWh. If even a part of the generated local electricity goes to national net the whole generation needs to be reported. The limit is so high that it causes no problems on building level but may decrease the profitability on district level refurbishment cases. Similar types of problems were described by the interviewees in Germany.

Legal issues on energy taxation and net metering in the Netherlands have been a significant barrier for energy generation via the photovoltaic installation of roofs which discourages the owners to share access production. The energy subsidies in the Netherland also vary from town to town each year. Increased administrative burden discourages owners to have collecting heating systems, which leads to each household having their gas boilers. The price of energy is rather low in Slovenia, leading to low interest in the implementation of renewable energy. The taxation and fees were not found to be a barrier in Lithuania and Latvia.

In general, the presence of several owners in refurbishment projects brings a lot of hindrances and barriers for smoothly proceeding processes because of different interests and financial possibilities in all countries. The availability of convincing information about the profitability of simultaneous refurbishment projects might help to solve the problem. Examples of successful projects with transparent results on costs and benefits are required.

However, the simultaneous presence of several actors was not seen as an important barrier if a leading body is presented. In the case of no one driving the process it becomes difficult from the administrative point of view for housing associations in all countries. An absence of facilitator at the district level in energy efficient refurbishment was found to be a barrier. For example, housing managers, building owner with large portfolios, ESCO companies, municipalities, etc. could play a role of an integrator or an activator for strong cases. This issue was not seen in Latvia, The Netherlands, and Austria, mostly the housing associations, lead such processes.

Lack of business models was seen as a critical barrier in Slovenia and the Netherlands, but not in Germany. The opinion on the presence of business models was rather divided among all other countries since it was seen as very case depended on. In some cases, business models work, and in some, they don't depend on the externalities of the project leading to differing opinions. Financial models should always be presented together with the technical refurbishment plans to private owners to guide the probability of investment in long term. Lack of procurement and delivery models was perceived differently by all interviews; again it's a process driven method which varies case by case. It was seen as an important barrier and not so important at the same time. In Slovenia, implementation of pilot projects was seen as a vital step to encourage district refurbishment project mainly due to the complex interaction between banks, owners, and municipalities.

Availability of energy performance assessment tools is crucial to foresee the energy saving potential to convince stakeholders to consider refurbishment as a profitable long-term investment. The better information a business model would have on energy conservation potential more are the chances of it being successfully implemented. There are tools available in most of the countries, but not all of them can handle a large amount of data on districts, also most of the time the data on the district level is not open to the public, which makes it more difficult to conduct the initial assessment. Some respondents expressed that these tools are not able to provide very accurate savings, of course, predictability can go only so far as the actual consumption also depends on the individual household practices.

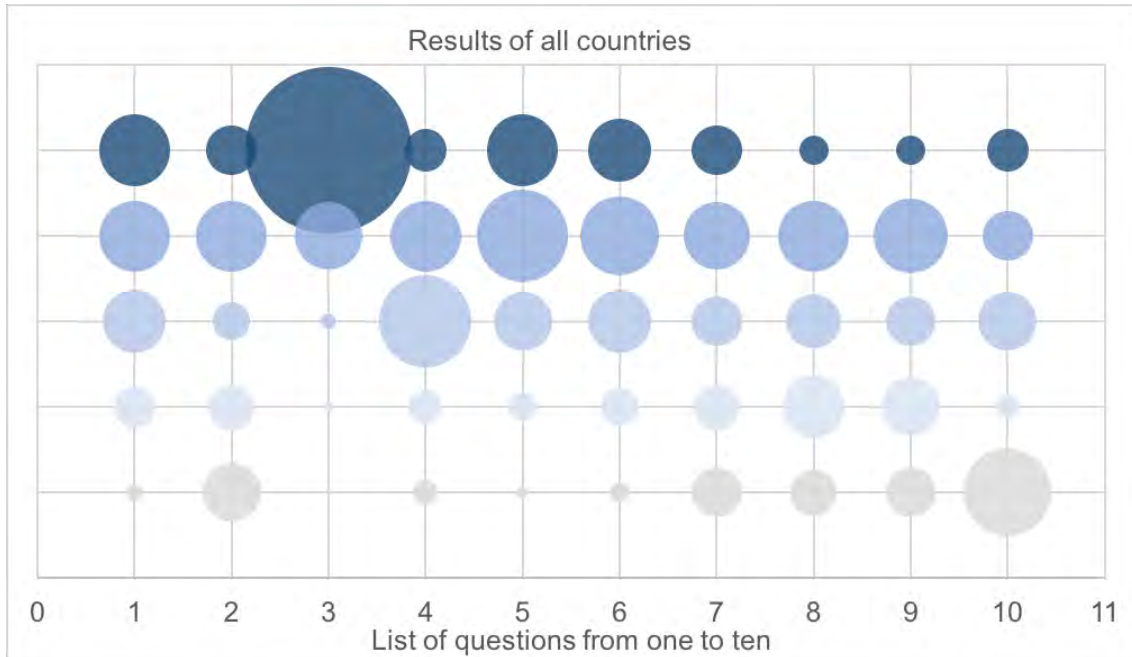

Figure 103: The size of the bubbles represents the number of answers and the colour gradient of grey to blue represents the scale from least important to most important

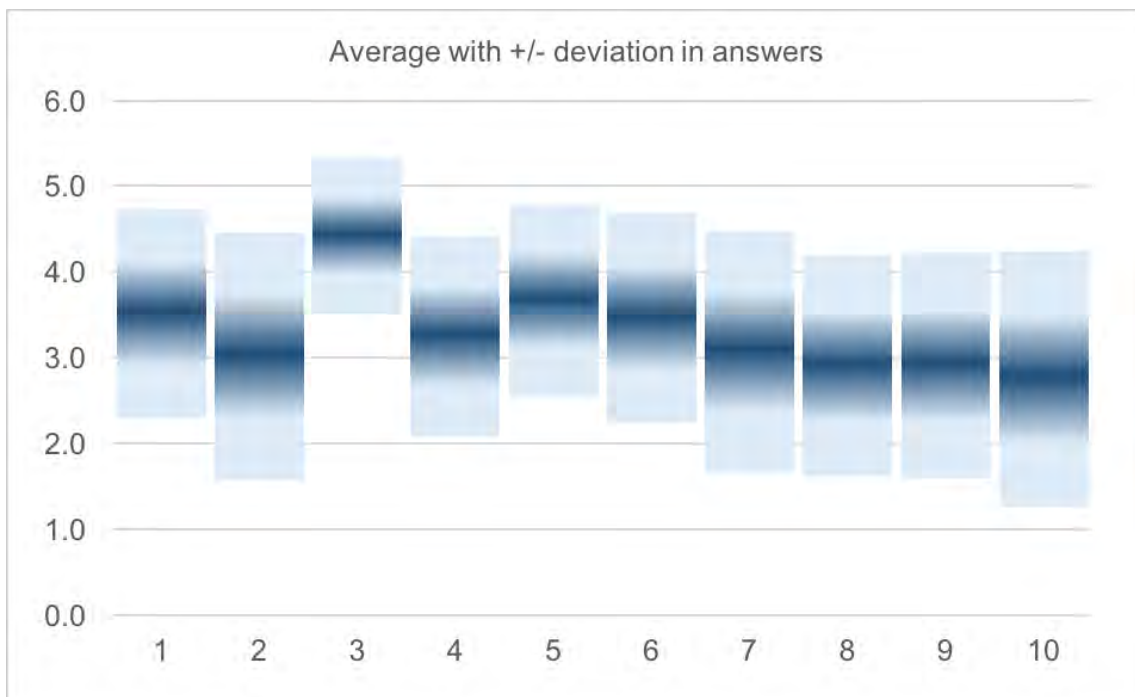

Figure 104: Deviation in interviewee responses

Designing process and methods for refurbishment at district level were seen as an obstacle but was not found to be a very significant barrier. Reason being that there are example projects in most of the countries, but at the same time analysis, legislation and license related issues are a single building oriented. Thus, in general, there is a lack of suitable models showing the comparison of energy savings between single building renovation versus collective buildings. On the other hand, design methods for the optimization of grid interactions and load matching are imperative from the technical perspective, but it was not observed as a barrier. It was noted that many interviewees were not familiar with problems which may occur in case set of buildings have their shared network. Thus, even though it was not observed as a barrier, prediction models for load matching are very much needed to evaluate the supply and demand including peak loads.

4. CONCLUSION

Interviews were conducted in eight European countries including Finland, Germany, The Netherlands, Slovenia, Lithuania, Latvia, Poland, and Austria. In total, 67 stakeholders were interviewed which included building owners with large portfolios, energy companies, designers, consultants, town planning and building permission authorities, renewable energy providers, contractors, developers and maintenance managers. Most of the interview were from Finland and least from Austria. The opinions of the interviewees were found to be very dissimilar because it was dependent on their experience on participation in district refurbishment projects and the role of their organization in those project.

The three most important barriers perceived by all interviews include presence and collective agreement of several owners to start district refurbishment projects, lack of activators or integrators and institutional and legal obstacles related to town planning and building permission practices. In Germany, barriers connected to regulations were not observed. In Poland, lack of energy assessment tools at district level was not seen necessary. For the Netherlands, agreement between the owners and lack of adaptable business models were considered as barriers. Slovenia and Lithuania somewhat had similar restrictions related to change in laws because of common ownership transition into distributed ownership.

It was noted that lack of assessment tools at district level was not found to be a significant barrier, but it is likely that the interviewees didn't have much experience in using any tool or being involved in the project which used such tools. We need more advanced district energy models which can predict the occupant behaviour also presented by (Yamaguchi et al. 2003). Pilot studies such as that of (Kilkiš 2014) have successfully demonstrated in matching the heating and cooling demand with waste heat/low-temperature energy resources leading to a reduction in high exergy resources. A second follow-up publication of this study will further explore the results of interviews in greater detail, along with business models to reduce the recognized barriers.

ACKNOWLEDGMENTS

The work presented in this document has been conducted in the context of Horizon 2020 programme of the European community project MODER (n° 680447). MODER is a 36-month project that started in September 2015 and is funded by the European Commission as well as by the industrial and research partners. Their support is gratefully appreciated. The partners in the project are SWECO (Finland), VTT Technical research centre of Finland Ltd (Finland), Fraunhofer Institute for Building Physics IBP (Germany), Siemens (Germany), REM PRO (Latvia), WE (the Netherlands), Ertex Solar (Austria), ZRMK (Slovenia), Finnenergia (Finland), and LEAG (Slovenia). In addition to the authors of this paper, the interviewers and rapporteurs of interviews in different countries were as follows: Jaakko Ketomäki, Tarja Mäkeläinen, Mia Ala-Juusela, **Marjana Šijanec Zavrl** (rapporteur of the Slovenian interviews), Jyri Nieminen (Lithuania and Poland), Erik Alsema (The Netherlands), Ervins Palmbahs (Latvia), Dieter Moore (Austria) and Hans Ernhorn (Germany).

REFERENCES

- [1] Ahvenniemi, H. et al., 2013. Market Barriers for Energy Efficient City Systems in Five European Countries. In N. Hauser, Gerd; Lützkendorf, Thomas; Eßig, ed. Sb 13 Implementing Sustainability - Barriers and Chances. Munich: Fraunhofer IRB Verlag 2, pp. 33–34. Available at: <http://www.irbnet.de/daten/rswb/13049012410.pdf>.
- [2] Ala-Juusela, M., Crosbie, T. & Hukkalainen, M., 2015. Defining and operationalising the concept of an energy positive neighbourhood. *Energy Conversion and Management*, 125, pp.133–140. Available at: <http://dx.doi.org/10.1016/j.enconman.2016.05.052>.
- [3] **Kilkiş, Ş., 2014. Energy system analysis of a pilot net-zero exergy district.** *Energy Conversion and Management*, 87, pp.1077–1092.
- [4] Marique, A.F. & Reiter, S., 2014. A simplified framework to assess the feasibility of zero-energy at the neighbourhood/community scale. *Energy and Buildings*, 82, pp.114–122.
- [5] Salom, J. et al., 2014. Task 40 Annex 52 NET ZEB: Analysis of load match and grid interaction indicators in net zero energy buildings with simulated and monitored data, Available at: <http://econpapers.repec.org/RePEc:eee:appene:v:136:y:2014:i:c:p:119-131>.
- [6] Salom, J. (Irec) et al., 2011. Understanding Net Zero Energy Buildings: Evaluation of load matching and grid interaction indicators. *Proc. Build. Simul. 2011*, 6, pp.14–16. Available at: http://www.bounceinteractive.com/bs2011/bs2011/pdf/P_1787.pdf.
- [7] Sartori, I., Napolitano, A. & Voss, K., 2012. Net zero energy buildings: A consistent definition framework. *Energy and Buildings*, 48, pp.220–232. Available at: <http://dx.doi.org/10.1016/j.enbuild.2012.01.032>.
- [8] **Sepponen, M. & Heimonen, I., 2016. Business concepts for districts' Energy hub systems with maximised share of renewable energy.** *Energy and Buildings*, 124, pp.273–280. Available at: <http://dx.doi.org/10.1016/j.enbuild.2015.07.066>.
- [9] Yamaguchi, Y., Shimoda, Y. & Mizuno, M., 2003. Development of district energy system simulation model based on detailed energy demand model. *Proceeding of Eighth International IBPSA Conference*, pp.1443–1450. Available at: <http://citeseerx.ist.psu.edu/viewdoc/download?doi=10.1.1.156.3147&rep=rep1&type=pdf>.

Building Regulations and Urban Policies as Incentives for Application of District Cooling Systems in Singapore

SHI Zhongming^a, Jimeno A FONSECA^b, Arno SCHLUETER^c

^a ETH Zurich, Future Cities Laboratory, Singapore-ETH Centre, Switzerland, shi@arch.ethz.ch, ETH Zurich, Chair of Architecture and Building Systems, Switzerland, shi@arch.ethz.ch

^b ETH Zurich, Future Cities Laboratory, Singapore-ETH Centre, Switzerland, fonseca@arch.ethz.ch, ETH Zurich, Chair of Architecture and Building Systems, Switzerland, fonseca@arch.ethz.ch

^c ETH Zurich, Future Cities Laboratory, Singapore-ETH Centre, Switzerland, schlueter@arch.ethz.ch, ETH Zurich, Chair of Architecture and Building Systems, Switzerland, schlueter@arch.ethz.ch

ABSTRACT

Existing district cooling projects display the potential to increase energy efficiency and reduce energy costs for cooling applications. The application of district cooling systems both is affected by and affects urban zoning, urban and architectural design and economic parameters. This paper analyses the status quo of planning and building regulation and urban policies as direct and indirect incentives for the application of district cooling systems (DCS). The paper aims at proposing strategies to facilitate the connection of more users to DCS in Singapore. We collect the planning and building regulations related to DCS in Singapore. Additionally, we retrieve more information from the video recordings of a discussion by experts on DCS in Singapore and China for first-hand experiences of the practice side. As a result, we will provide an assessment of the status quo of planning and building regulations and relevant urban policies concerning DCS in Singapore and suggest changes that may improve the efficiency of DCS and incentivize developers and proprietors to consider such system.

Keywords: district cooling, policy and regulation, building codes

1. INTRODUCTION

The global trend calls for serious and responsible actions on carbon emission reduction. Singapore has pledged to reduce CO₂ emissions by 36% in 2030 at COP21 (Ho 2015). The growing population and a potential increase in energy consumption also challenge this determination. District cooling systems (DCS) offer a solution for better energy performances as well as resilience-related, economic and environmental benefits (UNEP 2014). Research and application demonstrate multiple benefits of DCS with respect to architectural design, urban design and occupant comfort. These benefits include space saving, noise reduction and building program with complimentary temporal occupancy patterns.

Space savings in DCS refers to the space freed up by removing cooling facilities from the building rooftops and basements. It improves aesthetic and efficiency of the building and the city. Cooling towers on the rooftop can be replaced by sky gardens or terraces; chillers in the basement can be replaced by interconnected underground pedestrian tunnels. For example, the ship-like infinity pool floating over the three towers of Marina Bay Sands would not be realized without the district cooling systems. In addition, the removal of cooling facilities takes away the noises and the heat rejection into the urban environment especially street canyons.

DCS desires a stable consumption of the cold produced. Offices, for example, consume mainly in the daytime while residential buildings consume mainly at night. Thus, to maintain a stable and constant consumption pattern throughout the day, a mixed-use of various building programs with various types of occupancy, usage, time-of-the-day and weather conditions is beneficial (Tey 2010; Fonseca & Schlueter 2016).

Two of the main DCS providers in Singapore are Keppel DHCS and Singapore District Cooling (SDC). Keppel DHCS started operations in June 2000. Currently, it operates four cooling plants located at Changi Business Park, Biopolis One North, Woodlands Water Fab Park, and Mediapolis One North in Singapore. SDC, a subsidiary of the local electricity-utility started operations in May 2006 (Tey 2010). Currently, SDC operates two plants at the Marina Bay Business District. As part of a special urban policy for the development of the Marina Bay Business District, most buildings in the area are mandatorily required to connect to DCS (Zhuang 2016).

2. DIRECT AND INDIRECT INCENTIVES FOR DCS

A series of incentives have been adopted globally to promote energy efficiency in buildings and reduce their carbon emissions. Olubunmi, Xia & Skitmore (2016) categorized the incentives as internal incentives and external incentives. The internal incentives are human well-being related incentives, market demand-related incentives, gratifying incentives, altruistic incentives, and persuasion and inspirational incentives (Olubunmi, Xia & Skitmore 2016). **These incentives highly rely on the developer's internal willingness to care about the human well-being and the green benefits.** The external incentives include financial incentives and non-financial incentives. Financial and fiscal incentives are usually immediate financial remissions, like tax returns or fee waivers (Brilhante & Skinner 2015). Non-financial incentives include promotion and awareness incentives and economic incentives. Promotion and awareness incentives are services and assistances offered by the government as well as some pilot projects. Economic incentives concern peak pricing policies (Brilhante & Skinner 2015) and additional Gross Floor Area (GFA) (Shapiro 2011).

This paper focuses on the external incentives granted to the developers during the design and construction of buildings for connections to DCS. In Singapore, besides the incentives directly applied to the developers for the **connections to DCS, there are also "hidden" benefits triggered by doing so. For example, DCS frees up the rooftop space, which can be used as public spaces or rooftop green.** In Singapore, a green rooftop cannot only add economic and aesthetic values to the project but also raise the building height limit enforced by the Urban Redevelopment Authority (URA). We categorize the former as direct incentives and the latter as indirect incentives.

2.1 Direct incentives

The incentives directly applied for the adoption of district cooling systems are called direct incentives. Direct incentives usually come in the form of cash or tax rebate, discounted application fees, or additional allowance of gross floor area. Both Building Construction Authority (BCA) and URA have initiated several schemes of such direct incentives over the past decade to improve the energy performance and appearance of buildings in Singapore. These incentive schemes include the Green Mark Incentive Scheme by the BCA with cash incentives (BCA 2009) and the LUSH program 2.0 by the URA with extra gross floor area allowances (URA 2014). None of the existing incentive schemes in Singapore is focused on the adoption of district cooling systems.

2.2 Indirect incentives

Indirect incentives benefits are **the result of the DCS's influence on various aspects of the building projects.** Though there are no direct incentives, several building regulations and urban policies function as indirect incentives for the developers to decide to connect to the district cooling plants in Singapore.

Rooftop: As presented in Section 1, DCS's free up rooftop space in buildings can be used as public space or for rooftop greenery. In Singapore, a green rooftop can not only add economic and aesthetic values to the project but also lower the height restrictions enforced by URA. Rooftop is considered as one of the key urban design element (URA 2016a). URA grants bonus Gross Floor Area (GFA) for outdoor refreshment areas on landscaped rooftops of both new and existing commercial and mixed-use developments within the Orchard, the Downtown Core planning areas as well as parts of Singapore River (URA 2014). URA grants GFA exemption for rooftop pavilions when they are integrated into the rooftop landscape design occupying at least half of the rooftop space (URA 2014). For non-landed residential developments, rooftop landscapes meeting the criteria can be counted to meet the overall greenery provision and relieve the needs of spaces for on-ground greenery (URA 2016b).

Underground: When meeting certain criteria, URA grants GFA exemption for underground pedestrian links to rapid transit system stations (URA 2016c). Additionally, URA grants extra GFA allowances for activity-generating uses within the underground pedestrian links from Rapid Transit Systems (RTS) stations to existing development beyond the GFA allowed by the Master Plan. However, this additional GFA is not transferable and cannot be used to form future redevelopment of the site (URA 2001). The activity-generating uses include commercial uses like retail and eating outlet (URA 2016c).

Energy efficiency and noise control: DCS's have been proved in practice to increase the energy efficiency of buildings significantly (Tey 2010). Energy efficiency accounts for the majority of the points in the BCA Green Mark rating system (BCA 2013). The BCA Green Mark Scheme is a benchmarking scheme that evaluates environmental

performance of building projects (BCA 2016). Additionally, points are also awarded for the performance of noise level (BCA 2013). Projects meeting the Green Mark criteria can be granted cash incentives and GFA incentives by BCA and URA (BCA 2009; URA 2009).

2.3 Voices from practices

This section outlines positions and experiences of developers and operators of district cooling systems in Singapore and China (Happle 2016). Participants include academic researchers and DCS providers.

Except for the mandatory cases, the main drivers for building owners/ developers to connect to a DCS are the increased freedom of building design and improved energy efficiency which allows to better meet the requirement of Green Mark ratings (Happle 2016). These aspects are both related to the building regulations and the urban policies discussed as indirect incentives in the previous section.

Residential building excluded from the mandatory connection: Although most of the building projects are mandatorily connected to DCS, residential buildings are exempted from this obligation. Unlike offices where cooling is needed on a daily basis, the occupancy pattern of residential buildings is more versatile. Personal living habits such as a short trip away from home can alter the cooling need. Also, the in-taking stations in the building take up GFA and the additional piping systems to distribute cold in the building generate costs. Additionally, the district cooling systems remove the air-conditioner ledge of the split-units, which doesn't count as GFA but is sellable. These are some of the reasons that undermine the economic profits potentially brought by the connections to district cooling systems.

Electricity tariff: To maintain a stable cooling need, various buildings with different occupancy pattern are needed. In Singapore, the electricity tariff defined by the Energy Market Authority fluctuates over the day. A cooling provider would thus rather generate and store cold during low tariffs and sell it out during peak time than generating all in the peak time as needed. Residential buildings have higher cooling demand during the night when there is the low tariff. This is another reason that the residential buildings are not preferred.

3. DISCUSSION

Interdependencies on different levels: When introducing a comparatively new technology to a new context, technical feasibility is usually the first issue to be tested and solved upon application. However, to keep the system operating in a much more complicated context, it requires many other issues to think about, like business, policy-making urban planning, urban design, building design, and operations. For example, since the mid-1990s, URA, Singapore Power and Dalkia have conducted feasibility studies to identify district cooling as an urban utility and its commercial viability for the Marina Bay Business District (Tey 2010). Afterward, in the urban planning process, the application of district cooling system requires establishing a link between the urban and energy aspects, e.g. density arrangements corresponding energy strategies (Cajot et al. 2016). In the building design process, it needs back-and-forth negotiations **between the district cooling engineers and the architects for the building's connection** to the network. However, beyond all these, an operational business model with a reasonable charging strategy is the one that keeps the system running. This model should give considerations to the benefits of all the related stakeholders, like the cooling provider, the customers, etc.

Policy matters: Building projects like Marina Bay Sands connect to DCS to free up the rooftop space from cooling towers for architectural design freedom, e.g., the rooftop infinity pool. More importantly, one of the reasons that the developers voluntarily choose to connect to district cooling plant is to meet the requirement of a higher Green Mark certification (Happle 2016). Policy matters. However, it is admitted that since there was no information from the **developers' side, it is not sure that the other indirect incentives are effective. Except for cases with mandatory connection requirement, for the developers or the customers, decisions to connect to the district cooling plant are usually profit-driven.** Thus, there are three directions that building regulations and urban policies could be adapted to incentivize more projects to join. One is to strategically introduce direct incentives of GFA or cash rebate. Another **one is to increase the indirect incentives to make such "hidden incentives" more attractive and "visible".** And finally, one is to tighten up the requirement of energy efficiency, noise control, green rooftop, and underground pedestrian networks to **"force" the projects within the service radius to join.**

Residential or not? As discussed in the introduction, it requires buildings with various occupancies, usage, and time-of-the-day to maintain a stable cooling demand pattern to the system. So far, all the district cooling plants in Singapore are located in business districts mainly with office buildings. Office buildings have high cooling demand mainly in the daytime of weekdays while residential buildings usually have intensive cooling demand at night and weekends. Thus, the cooling need of residential buildings can be considered complementary to that of office buildings. However, in Singapore, residential buildings are currently either excluded from the mandatory requirement of connection to DCS or not “embraced” by district cooling providers. Multiple economic reasons including the electricity tariff and the increased investment together with the versatile occupancy pattern mainly lead to this situation. Though economic issues are highly important in practices, mixed-use developments also offer urban qualities. Based on challenges like “eyes-on-the-street” of Jane Jacobs in the 1960s (Jacobs 1961) and experiences generated from projects like La Defense in Paris, business districts worldwide benefit from being mixed-use and all-day vibrant. To achieve such goal, residential buildings are indispensable. So, in the process of urban design within the service radius of a district cooling plant, residential buildings should not be excluded merely for the sake of the reasons discussed above. However, whether a residential building should be connected to the plant can be optional and on a case-by-case basis. Possible strategies of regulations and policies include bonus GFA or cash rebate and tariff discount to developers and DCS providers of residential buildings. In this way, the additional investment on the facilities for DCS connection can be fully or partially compensated by the bonus GFA

4. CONCLUSION AND OUTLOOK

This paper reviews the status quo of DCS applications and relevant building regulations and urban policies as direct and indirect incentives in Singapore. Experiences and voices from the practice side are valued and addressed. It is once more underlined that the application of district cooling system is multifaceted and more than merely a technical, a commercial or a policy issue. Exemplified for residential buildings, the interactions between aspects of energy systems and urban qualities become apparent. When introducing a comparatively new technology like district cooling system we can observe its influences on other aspects such as urban design issues of density deployment, building programs, etc. Urban design and district cooling systems should, therefore, work in synergy to increase the energy efficiency and urban quality. Last but not the least, policy matters. Building regulations and urban policies can work as direct or indirect incentives to promote voluntary connections. However, any adaptations of such regulations and policies should be carefully evaluated before coming into force.

Future studies on district cooling systems will include ideas, and experiences from all the stakeholders involved in the lifespan of a building project. This includes cooling providers, policy-makers, developers and district cooling customers.

REFERENCES

- [1] BCA 2009, ‘Green Mark Incentive Scheme’, available from: https://www.bca.gov.sg/GreenMark/others/Guideline_for_Green_Mark_Cash_Incentive_Scheme_v3.pdf.
- [2] BCA 2013, ‘Framework-BCA Green Mark for residential buildings (Version RB/4.1)’, available from: https://www.bca.gov.sg/GreenMark/others/gm_resi_v4.1_R.pdf.
- [3] BCA 2016, ‘About BCA Green Mark Scheme’, available from: https://www.bca.gov.sg/GreenMark/green_mark_buildings.html.
- [4] Brillhante, O & Skinner, J 2015, ‘Review of some incentive mechanisms being used by some European Municipalities to promote sustainable housing.’ Available from: http://www.ihs.nl/fileadmin/ASSETS/ihs/Marketing/prospective_students_pages/ECO_and_MFUI/Incentive_mechanism_municipalities_sustainable_construction.pdf.
- [5] Cajot, S, Schlueter, N, Peter, M, Page, J & Marechal, F 2016, ‘Establishing links for the planning of sustainable districts’, Expanding Boundaries: Systems Thinking in the Built Environment: Sustainable Built Environment (SBE) Regional Conference Zurich, pp. 502-512.
- [6] Fonseca J & Schlueter A 2016, ‘Assessing the performance and resilience of future energy systems at neighbourhood scale’, Expanding Boundaries: Systems Thinking in the Built Environment: Sustainable Built Environment (SBE) Regional Conference Zurich, pp. 96-100.
- [7] Happle, G 2016, video recording, ‘Roundtable on challenges of future district energy in Singapore’, Singapore.

- [8] Ho, O 2015, 'S'pore calling for universal climate deal', *Straits Times*, 21 November. Available from: <http://www.straitstimes.com/singapore/spore-calling-for-universal-climate-deal>.
- [9] Jacobs, J 1961, *The death and life of great American cities*, New York.
- [10] Olubunmi, A, Xia, B & Skitmore, M 2016, 'Green building incentives: a review', *Renewable and Sustainable Energy Reviews*, 59, pp1611-1621.
- [11] Shapiro Shari 2001, 'Code green: Is "greening" the building code the best approach to create a sustainable built environment?' *Planning & Environmental Law*, 63.6 pp. 3-12.
- [12] Tey PK 2010, 'District cooling as an energy and economically efficient urban utility-its implementation at Marina Bay Business District in Singapore.' Available from: [http://www.singaporepower.com.sg/irj/go/km/docs/wpcccontent/Sites/Singapore%20District%20Cooling/Site%20Content/Overview/documents/DCS%20Paper%20\(Jun%2010\).pdf](http://www.singaporepower.com.sg/irj/go/km/docs/wpcccontent/Sites/Singapore%20District%20Cooling/Site%20Content/Overview/documents/DCS%20Paper%20(Jun%2010).pdf).
- [13] UNEP 2015, 'District energy in cities: Unlocking the potential of energy efficiency and renewable energy'.
- [14] URA 2001, 'Guidelines for Underground Pedestrian Links to Rapid Transit System (RTS) Stations', available from: <https://www.ura.gov.sg/uol/circulars/2001/may/dc01-13.aspx>.
- [15] URA 2009, 'Green Mark gross floor area incentive scheme for private developments that achieved higher-tier Green Mark ratings', available from: www.ura.gov.sg/uol/circulars/2009/apr/dc09-04.aspx.
- [16] URA 2014, 'An overview of the LUSH Programme', available from: www.ura.gov.sg/-/media/User%20Defined/URA%20Online/media-room/2014/jun/pr14-35a.pdf?la=en.
- [17] URA 2016a, 'Key urban design elements', available from: <https://www.ura.gov.sg/uol/urban-planning/vision/Key.aspx>.
- [18] URA 2016b, 'Development control parameters for residential development', available from: <https://www.ura.gov.sg/uol/publications/technical/dc-handbooks/dc-parameters-for-residential-development>.
- [19] URA 2016c, 'Development control parameters for non-residential development', available from: <https://www.ura.gov.sg/uol/publications/technical/dc-handbooks/dc-parameters-for-non-residential-development>.
- [20] Zhuang, J 2016, 'Keeping Marina Bay Cool', *Skyline*, Issue 04, pp. 10-13.

Poster Session

The Exploration of Sustainable Neighbourhoods - A Case Study of Shenyang

LI Li-hong^a, WANG Zhuo^b

^a Shenyang Jianzhu University, Mainland China, lilihong022@126.com

^b Shenyang Jianzhu University, Mainland China, 376308612@qq.com

ABSTRACT

Sustainable neighbourhoods have become more and more popular in the world recently, but they encounter numerous obstacles when developed in China, the obstacles are mainly as followed: policy system, legislation system, management mode and living concepts of residents and others. Firstly, sustainable neighbourhoods are interpreted in this paper, and the worldwide successful experience of sustainable neighbourhoods at the present stage is summarized. On this account, based on the specific circumstance of Shenyang, the sustainable neighbourhoods are designed from the aspect of how to strengthen the controlling by legal and policy system and technical architecture, how to build the target monitoring and feed respective interests, and how to innovate cooperation and safeguard mechanism, and so on. And the planning concept and control strategy of the sustainable neighbourhoods in Shenyang are built in this paper so as to promote the sound and fast development of sustainable neighbourhoods in Shenyang and even China.

Keywords: sustainable neighbourhoods, exploration, Shenyang, planning concept, control strategy

1. PREFACE

With the continuous improvement of people's living standard in our country and increasing awareness of environmental protection, residents have been putting more emphasis on the green, ecological and sustainable living environment, but there are barely Sustainable neighbourhoods of real sense in our country. Then, how to develop a sustainable neighbourhood of persistence, vitality, catering for the need of residents and benefiting posterity and other areas has become the right question which urgently to be solved. And this is also what this paper focuses on.

At the beginning of the solution, the sustainable neighbourhood must be comprehended all round and in depth. Given the potentially wide reverberations, there is hardly a clear definition of the sustainable neighbourhood. But represented by Bristol Accord, the understanding of sustainable neighbourhoods by research institutions and scholars at home and abroad can be summarized as the following eight key points (Evans 2011), as shown in the Figure 1.



Figure 1: Understanding on the connotation of the sustainable neighbourhood

In short, sustainable neighbourhoods emphasized on reducing the negative effect on resources and environment, creating a healthy and comfortable living environment, and the harmonious coexistence between human and nature.

2. THE DEVELOPMENT STATUS OF SUSTAINABLE NEIGHBOURHOODS AT HOME AND ABROAD

In 1898, the British scholar Howard put forward the idea of "garden city", he thought that there must be both good social economy environment and comfortable natural environment in human community, which is acknowledged as the bud of the conception of sustainable neighbourhoods in western society. Since 1987, when the World Commission on Environment and Development put forward the concept of sustainable development formally, the concept of sustainable neighbourhoods has gradually been transforming from the theoretical level to practical level, and ideas of sustainable development has been enjoy more and more popular support.

In 2009, the US Housing and Urban Development, Department of Transportation and the Environmental Protection Agency set up a joint cooperation group in support of the development of sustainable neighbourhoods from the policy and funding. By 2012, the group has received more than 7700 applications and been required for the amount of aid over 102 billion US dollars. There exists great potential and broad prospects for sustainable neighbourhoods.

Among the many sustainable neighbourhoods in the world, Hammarby Lake City, Stockholm Royal Seaport in Sweden and Sustainable Seattle in the United States have attracted worldwide attention because of their exploration on sustainable neighbourhoods from different perspectives.

2.1 Hammarby Lake City

Sweden has always been at the forefront of building sustainable neighbourhoods, and Hammarby Lake City has become the most representative example of sustainable neighbourhoods in Sweden because of its success in the applications of new technology. In the phases of planning and construction, Hammarby Lake City was designed in accordance with the circular metabolism proposed by Girard Heber, that is, all metabolites outputted from a city or an area (including waste water, rubbish, exhaust Etc.) must be re-used to produce energy, materials, or as a plant nutrient to re-enter the area. This is the so-called "Hammarby model". The model emphasizes the recycling of energy, waste and water, and reducing the generation of metabolites from the community, to achieve its planning target of "twice as good", which means reducing environmental impact in half compared to the early 1990s.

To this end, the managers developed the Hammarby environmental program, which contains nine categories as the energy, transportation, materials, water, land utilization, waste recycling, contaminated soil, lake restoration and noise (Jiao et al 2013), to achieve the planning objectives by controlling these indicators. And in the process of implementation, the Hammarby environmental program is continuously modified and improved in accordance with the views of developers and residents and other parties.

Up to now, although the Hammarby Lake City has not yet been fully completed, but the analysis of tracking indicators indicates that some of the project planning objectives have truly achieved, while in some respects, there are targets of serious failure (WÖrjan 2008). In this way, the construction of Stockholm Royal Seaport in Sweden is provided with valuable experience.

2.2 Stockholm Royal Seaport

Stockholm Royal Seaport began construction in 2010, and expected to be completed in 2025. It is positioned as a multi-purpose community which can effect the environment positively. Based on the reflection of the failure objectives in the Hammarby Lake City, Sweden made the following improvements on Stockholm Royal Seaport.

Stockholm Royal Seaport gave full play to the advantage that most of the land ownership is owned by the Stockholm Government. so when signing the land transfer contract, the government had clearly imposed restrictions on land developers on such indicators as building materials, building energy consumption, the proportion of renewable energy and so on (Fraker 2013). As a result, the government urged the establishment and implementation of the plan of Stockholm Royal Seaport effectively.

For the better cooperation between the participants of the project, the government of Stockholm organized developers, builders, suppliers, consultants, technical consultants, etc. to hold several seminars for providing advice and suggestions for Stockholm Royal Seaport. More importantly, the government of Stockholm set up a policy-making committee to develop policies for different processes during the planning and development phase, and a follow-up control committees to control and amend planned targets of the project, and an action committee to urge the implementation of the plan (WÖrjan 2008). Through the approach of third-party supervision, the planning and construction of Stockholm Royal Seaport is carried out effectively.

2.3 Sustainable Seattle

Sustainable Seattle is one of the most influential sustainable neighbourhoods in the world dedicated to realizing urban communities with "long-term cultural and economic development, environmental health and vitality".

Sustainable Seattle is located in Seattle, United States, and developed by a civil community organization. The organization is dominated by voluntary residents, and focuses on instilling residents with the concept of the sustainable neighbourhood. In order to arouse the sense of identity and participation, the organization, through the studies of seminars and polls (Holden 2014), set up sustainability indicators of the community, including environmental, demographic, economic, cultural and social development, to guide and evaluate Sustainable Seattle.

Sustainable Seattle has penetrated the concept of "public participation" into the daily life of the residents. Residents established a fixed recycling center to promote things for things, increasing the economy and reducing the generation of garbage and environmental load. Residents travel also maximize the use of public transit or carpooling to reduce vehicle usage patterns. In addition, garbage charging system also prompted to reduce the production of non-reusable waste (Holden 2014), so that residents can implement a cost-effective attitude to life effectively.

Sustainable Seattle has been named "the World's Most Liveable City". From the international perspective, it is a model of best practice for sustainable neighbourhoods.

Based on empirical analysis of sustainable neighbourhoods abroad, these sustainable neighbourhoods are supported by not only the new technologies such as green building and renewable energy from the hardware level, but also a comprehensive, effective and cycling safeguard mechanisms of the life cycle of the project. In addition, the government has provided an effective impetus for these sustainable neighbourhoods in terms of policy, legal and technical standards systems to facilitate the achievement of objectives. Under this mechanism, the participants have cooperated with each other and have a clear responsibility to ensure the ecological benefits of sustainable neighbourhoods.

3. ANALYSIS OF THE CURRENT SITUATION OF SUSTAINABLE NEIGHBOURHOODS IN SHENYANG

The research on sustainable neighbourhoods started late in China, until the late 20th century, some scholars began to conduct some systematic studies. At the practical level, our country has made certain achievements in the hardware of sustainable neighbourhoods, that is, the relevant policies, standards and technical system of infrastructure construction. Taking green building for example, in January 2013, the National Development and Reform Commission jointly Ministry of Housing and Urban issued the "Green Building Action Plan", which clearly promote the building industrialization as one of the ten key tasks. Shenyang, as a national demonstration of construction industry modernization, its maturing technology of prefabricated construction, will contribute to sustainable neighbourhoods in Shenyang from the technical level. However, at the software level, compared with the management measures, ecological culture, etc. communities in Shenyang still have a wide gap.

From the macroscopic point of view, due to the lack of policy system, defects of legal system, backwardness of management mechanism, in addition with the contradictions between environmental goals and economic interests of each parties, there are still prominent constraints in the development of sustainable neighbourhoods in Shenyang.

From a microscopic point of view, the current form of communities in Shenyang are mainly the property management led by real estate investor, including high homogeneity of apartments and villas, mixed communities and affordable housing districts, removal settlement area, etc. These communities differ in terms of infrastructure and management. What's worse, the awareness of environmental protection of the residents is generally weak, participation is relatively low, and the atmosphere of sustainable development in these communities is not strong.

These factors comprehensively lead to the embarrassment that there is hardly real sustainable neighbourhood in Shenyang. Therefore, solving the problems above, is an effective way to promote sustainable neighbourhood development in Shenyang. So, it is the key to explore an effective solution from the aspect of software. Only in this way, can Shenyang and even China achieve sound and rapid development of sustainable neighbourhoods.

4. SUGGESTIONS ON THE PLANNING OF SUSTAINABLE NEIGHBOURHOODS IN SHENYANG

For the planning and construction of sustainable neighbourhoods in Shenyang, there is many successful experiences can be learned from sustainable neighbourhoods abroad.

4.1 Strengthen the control of policy, legal and technical system

First of all, for the governments, there is a lack of the measures and efforts on land development and supervision. In the use of the overall statutory detailed planning to achieve the controlling of the project, the land transfer agreement is an effective policy tool. Taking Shenyang as an example, the government did not introduce a set of planning or standards of sustainable development. So for most of the projects, there is not such a program based on protecting the environment. At the same time, when signing the land transfer agreement, the government cannot constrain developers from the aspects as environmental and energy standards of the land, the control conditions of resource conservation and recycling and others. Under this circumstance, developers often tend to start from their own economic benefits, or applying technology superficial, or simply stacking a pile of technology, and energy conservation and recycling cannot be achieved from a global perspective.

In 2015, the "Several Policy Measures to Promote the Modernization of Construction Industry in Shenyang" was introduced by Shenyang Municipal Government, which proposing the new strategy of "Internet + modern building" for the first time, putting prefabricated residences as one of the conditions of land transfers, promulgating varieties of technology standards of prefabricated buildings and so on, in order to promote the development of prefabricated buildings from the policy provisions and technical standards.

But it should be noted that, when the government playing a guiding and restraint role, relevant laws and regulations and more scientific and applicable technical specifications should also be supported, which is the current lack for Shenyang. Following the national level of the legal system and macro-oriented policy, according to the natural, social, economic situation of Shenyang, the all-round, multi-level and three-dimensional regulations, target plans and technical specification systems can be established by Shenyang Municipal Government, so that it can provide a strong basis that promoting the development of sustainable neighbourhoods in Shenyang.

4.2 Constructing the target monitoring and feedback mechanism of the sustainable neighbourhood

What can be found from the successful experience of sustainable neighbourhoods abroad is that, the mechanisms for setting, monitoring, evaluating and improving goals of sustainable neighbourhoods is extremely important. Shenyang is lack of not only legal, policy and technical guidance, but also appropriate mechanisms. And, for Shenyang, there is no scientific planning process to develop environmental objectives before the project, no monitoring and feedback on the objectives during the project, no scientific evaluation and improvement of the objectives after the project, and the ecological benefits of sustainable neighbourhoods is out of the question. So, combining with the characteristics of Shenyang, establishing a comprehensive and scientific goal-tracking mechanism to control sustainable neighbourhoods throughout the lifecycle is particularly important.

Before the establishment of this mechanism, the status of Shenyang should be investigated. Something like potential energy, resource users and greenhouse gas emissions should be forecasted by scenario analysis, cost-benefit analysis, life cycle assessment, etc. On the basis of this, adding into the strategic guiding ideology, the overall target and strategy of sustainable development in Shenyang can be formulated. Considering the specific

geographical environment, environmental technology and financial status of communities in Shenyang, the targeted targets can also be formulated.

At the same time, Multi-party monitoring platform that aiming at the implementation of the target in the whole life cycle of sustainable neighbourhoods ought to be established. The government acts as prosecutor to prosecute the implementation of policies, while others such as developers, contractors, suppliers, property management companies, etc. must appoint their clear responsibilities for Internal oversight and publicity. The monitoring platform can effectively solve the lack of feedback and defect of output deviation caused by unidirectional transmission of information. It is also possible to make real-time improvements to the target during the project, evaluate the objectives at the end of the project. So that the indicators, as well as the overall strategy of sustainable development of Shenyang can be adjusted timely. Using a cycle of planning, monitoring, evaluation and improvement, targets of the project are able to be revised constantly to maximize the sustainable eco-efficiency of sustainable neighbourhoods.

4.3 Balance the interests of all parties

The development of sustainable neighbourhoods requires the participation of all sectors, and interests of all parties should be coordinated to balance by the government. Participants should develop the planning programs jointly to avoid risk at the beginning to improve operability and success rate of sustainable neighbourhoods.

While, the most significant conflict is between environmental goals and economic interests. The promotion of environmental indicators means the increase of **costs**. **Taking green building as an example, it is defined in “Several Policy Measures to Promote the Modernization of Construction Industry in Shenyang” that, in the administrative area, prefabricated building technology should be used in the real estate projects, and the overall prefabrication rate must be more than 30%. Based on a prefabricated building using prefabricated sandwich panel to reach 30% of the prefabrication rate, compared with a traditional cast-in-place concrete building, the costs of developers will increase by about RMB 160 yuan per square meter (Li et al 2015), which is contrary to its goal of pursuit of maximizing economic benefits.**

So the direct financial compensation can be used by Shenyang municipal government to reduce the pressure on the developers. But for the current financial pressure in Shenyang, relevant policy measures should be more introduced to mobilize market compensation (Shen & Song 2012). Through financial support to the developers, their enthusiasm for sustainable neighbourhoods can be enhanced, and the quality of construction can also be improved.

4.4 Innovate the collaboration safeguard mechanism of sustainable neighbourhoods

After balancing the interests of all parties, in order to ensure the inherent continuation of sustainability of the project, the participation of residents in Shenyang into sustainable neighbourhoods ought to be changed as well. There is no right without **obligation**. **From the planning stage, “resident participation system” should be advocated as the starting point of constructing the interests safeguard mechanism of sustainable neighbourhoods in Shenyang.** Sustainable Seattle and other foreign successful experience shows that, public participation is the basic guarantee system for the development of sustainable neighbourhoods. The traditional "from top to bottom" development mechanism of sustainable neighbourhoods in Shenyang should be reversed. And the Innovative safeguard **mechanism ought to be established, which is based on the “from bottom to top” development mechanism including the planning processes from the government to experts and management process participated by the residents. So that the “trinity” collaborative mechanism can be established (Cai 2005; Sun et al 2015), and its operating mechanism is shown in the Figure 2.**

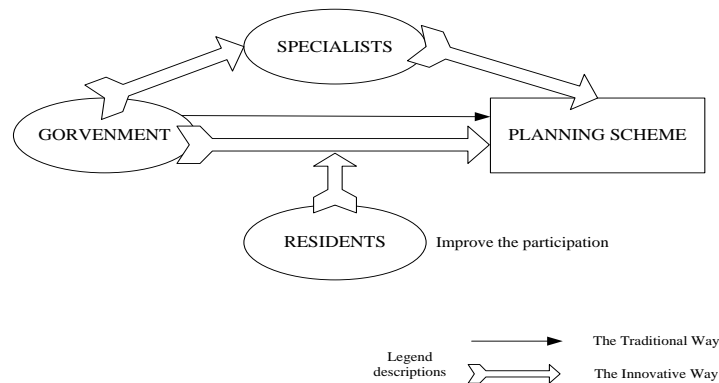

Figure 2: The "Trinity" collaborative mechanism of sustainable neighbourhoods in Shenyang

Under this collaborative mechanism, the construction of sustainable neighbourhoods in Shenyang should be based on the people-oriented technical measures such as perfect public transportation and ecological landscaping. Under the premise of ensuring the comfort of the residents' lives, boot mechanism should be more used to change the lifestyle of the residents. on the basis of energy cascade billing and garbage charges, economic incentives such as renewable energy power transactions should be increased as well, in order to enhance the concept of sustainable development like "from bottom to top" into residents' minds. This fundamental change is the focus of the sustainable development of sustainable neighbourhoods.

5. CONCLUSION

From the perspectives on controlling of the policy, legal and technical system, target monitoring and feedback mechanism, the interests of all parties, coordination mechanism and so on, the planning concept and control strategy of sustainable neighbourhoods in Shenyang is designed innovatively in this paper. Therefore, from the point of view of research, the theoretical and practical suggestions for the future development of sustainable neighbourhoods in Shenyang are provided in this paper.

However, due to the complexity of the implementation, the long-term of the development cycle, the large sums of uncontrollable factors and many other issues existing in the development of sustainable neighbourhoods in Shenyang, the viewpoints of this paper also need to be revised and perfected in practice. And there still need unremitting efforts of scholars to study on how to maximize the ecological benefits of sustainable neighbourhoods, and how can sustainable neighbourhoods exert more positive effects on the society, economy, ecology and other fields.

REFERENCES

- [1] Cai. Q., 2005. A Study on Microcosmic Process of Community Public Participation in Sustainable Development. Seeker, (10), p.94-96.
- [2] Evans, N., 2011. Lost in Translation-The Bristol Accord and the Sustainable neighbourhoods Agenda. European Journal of Spatial Development, December (44).
- [3] Fraker, H., 2013. Hammarby Sjöstad, Stockholm, Sweden. The Hidden Potential of Sustainable Neighborhoods. Island Press/Center for Resource Economics.
- [4] Holden, M., 2014. Sustainable Seattle. Springer Netherlands.
- [5] Jiao, Z. et al., 2013. Partnership for Sustainable neighbourhoods. World Environment, (2), p.44-47.
- [6] Li, L.H. et al., 2015. Calculation of Assemble Integral Building Reasonable Assembly Rate. Construction Economics, 36(7), p.91-94.
- [7] Shen, L.F. & Song, T.P., 2012. The Costs **Compensation & Benefits Share for "Low Carbon Housing" Based** on Industrialization. paper presented at the China Engineering Management Forum.
- [8] Sun, N. et al., 2015. Path to Public Involvement in Urban Environmental Management under the New Urbanization. Resources & Industries, 17(1), p.43-47.
- [9] Wörjan, S., 2008. Situations of opportunity – Hammarby Sjöstad and Stockholm City's process of environmental management. Corporate Social Responsibility & Environmental Management, 15(2), p.76–88.

Track 12: Emerging Green Construction Technology and Materials

Session 4.6: Green Construction Technologies (1)

Watering Type and Water Consuming Assessment of the Green Construction Fence in Taichung City, Taiwan

CHEN Chen-chun^a, CHAO Yu-chan^b, LAI Wan-ting^c

^a Feng Chia University, Taiwan, gregcouger1022@gmail.com

^b Feng Chia University, Taiwan, chaodan2@gmail.com

^c Feng Chia University, Taiwan, lsipbl@gmail.com

ABSTRACT

The green construction fence, green wall, can reduce the impact to the urban landscape cause by the construction site. However, keeping the plants survive usually consumes lots of water.

This study had surveyed 35 green walls in Taichung city, Taiwan. The result indicates that the two most used watering types are “delaminate watering by gravity with drilled PVC pipe”, 62.8%, and “delaminate watering by drip irrigation system”, 22.9%. And the plants were watered for 33.2 minutes, two times a day on average.

Base on the interview and field investigation, the average yield of water was 29.6 L/m²-a day, which is 2.96 times to the references, thus the green wall was regarded as a hyper-water consuming structure. Therefore, this study aimed to assess which watering type is better and its' actual water consumption by doing an onsite experiment with an 1:1 scale green wall.

The watering type includes two parts: the watering system and the watering frequency. This study evaluated the appropriate watering frequency and water yield of two watering systems by measuring the soil humidity and observing how the plants grow or even died.

In conclusion, to keep the plant survive, the drip irrigation system is the better watering system for the green wall. The best watering frequency and the limit yield of water for each plant for the green wall in Taichung city is: (1) Shrub: 11.73 L/m², each 2 days; (2) Herbaceous plants: 8.93 L/m², each 2 days; (3) Succulent plants: 9.73 L/m², once a week; (4) Fern plants: 5.31 L/m², each 2 days.

When building a green construction fence, the drip irrigation system would be the better choice. And using appropriate watering frequency for different plants is also suggested. The green construction fence will have better benefit if built with water retention materials and water recycle system.

Keywords: green construction technology, watering type, water consuming

1. INTRODUCTION

The main function of the construction fence is to protect citizen from the possible risks and danger, however it also makes oppressive and cold images that impact the urban landscape. Therefore, the local government in Taiwan had promoted the decoration of construction fence by vertical greening for years. However, the green wall has few defects, such as (1) Choosing the unsuitable plants for the green wall; (2) Fail to create friendly walking environment for passengers; (3) Inappropriate management and maintenance; (4) Unsuitable water recycle system.

The related reference and early research mostly focus on the suitable plants choosing and the visual preference. According to Hong (2011), the yield of water using on the green wall is 7.58 L/m² per day, however it is only an estimated number. Therefore, this paper aimed to get precise water consumption of green wall and explore the feasible way to reduce the water consumption by field investigation and onsite experiment with an 1:1 scale model.

2. FIELD INVESTIGATION

In order to know construction detail of the green wall, such as the watering system, watering frequency, structure, materials and the choice of plants using, as a database for the onsite experiment, this study surveyed 35 cases of green wall in Taichung city, Taiwan.

2.1 The watering type

The watering type contains two parts: (1) The watering system; (2) The watering frequency. According to field investigation, the average area of the green wall is 78.5m², and the two most used watering system (Table 1) are “delaminate watering by gravity with drilled PVC pipe”, 62.8%, and “delaminate watering by drip irrigation system”, 22.9%. And the plants were watered for 33.2 minutes, two times a day on average.





The watering system	Delaminate watering by gravity with drilled PVC pipe	Delaminate watering by drip irrigation system	Spray from the top	Watering by manpower
Picture				
Ratio	62.8%	22.9%	5.7%	8.6%

Table 1: The watering system using on the green wall in Taichung City

2.2 The choice of plants

The field investigation result also indicated that the green wall usually uses 1~5 species of plants, and 54.29% green wall use 3 plant species (Figure 1). There are four plants most used in 35 cases (Figure 2): (1) Golden Dewdrop, 20.34%; (2) Spengeri Asparagus, 23.32%; (3) Rhoeo spathaceo, 13.56%; (4) Tuber Sword Fern, 13.71%.

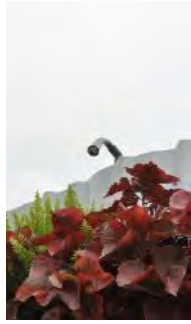
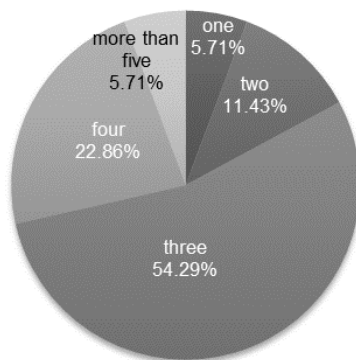

Figure 1: How many species using on green wall

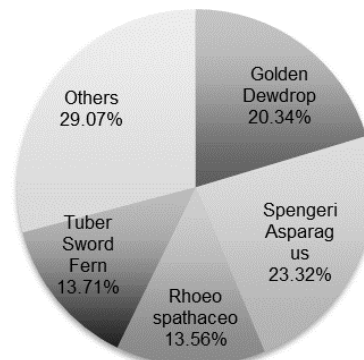

Figure 2: The using ratio of plants

2.3 The average yield of water used on green wall

This paper surveyed the watering type settings and structure details of green wall by interview and field investigation (Table 2) to figure out how much water did the construction site use on the green wall. And the average yield of water was 29.6L/m²-a day for the 35 cases, which is 2.96 times to the references, thus the green wall was regarded as a hyper-water consuming structure.

Item	Description
Watering Frequency	Watering twice per day, mostly at 8 - 10 o'clock a.m. and 4 - 5 o'clock p.m.
Water Time	According to the timer settings, the water supply lasts 15 minutes, 30 minutes or 45 minutes each time

Quantity of Pump	Mostly using 1/2 or 1 hp motors, one set for 50m ² on average, at most 3 sets
Pumping Efficiency	Referring to various manufacturers' catalogues, the motor pumping efficiency is influenced by the pipe diameter and pumping depth, the maximum yield is 20-50L/min, the average is 35 L/min

Table 2: The current condition of watering mode by field investigation

3. ONSITE EXPERIMENT

In order to know the suitable watering type for the green wall, this study built an 1:1 scale green wall to assess how much water was needed to keep the plants survive. The field investigation and the onsite experiment are all operated in Taichung City, Taiwan. Thus the climate is considered as a control variable, and the mean annual temp of Taichung City is 22.6°C, the mean annual rainfall is 1712.1mm, the mean annual RH is 79.8%, and the global radiation is 3.25 kWh/m²-day. The onsite experiment is operated during September to December, 2013, and the experimental settings are described below.

3.1 Onsite experiment settings

The experimental site located at the southward terrace on the 8th floor of Jong Chin Building, Feng Chia University. Based on field investigation, this study set the experiment green wall as Figure 3 by using two different watering systems: (1) Delaminate watering by gravity with drilled PVC pipe; (2) Delaminate watering by drip irrigation system, and four different plants: (1) Golden Dewdrop, shrub; (2) Spengeri Asparagus, herbaceous plant; (3) Rhoeo spathaceo, succulent plant; (4) Tuber Sword Fern, fern plant.

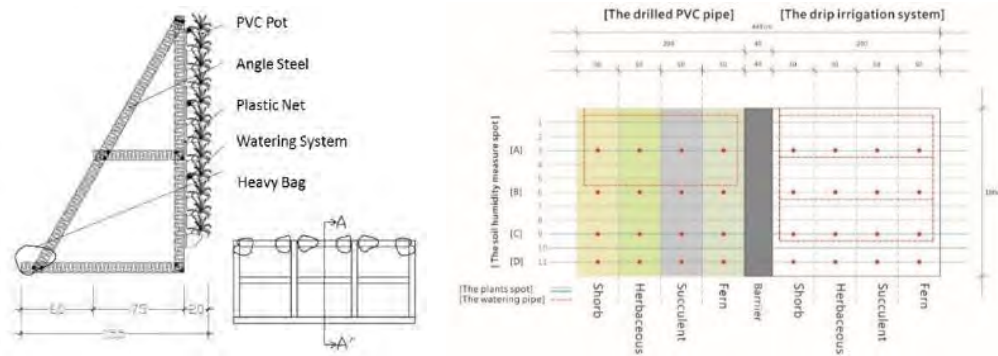

Figure 3: The experimental green wall structure and the watering system settings

Referred to the reference, this study appropriately reduced the watering frequency to watering everyday with 11.25 L/m² water. And researchers watered the green wall at 9:00am to prevent the heat hurts the plants. In this study, the watering frequency was the main control variable. If it rains, the experiment was restarted in two days after rain. The soil humidity should keep between 40~60% (M. X. GU, 2012) to assure the plants all grow well, so this paper used Rixen M-700 to measure the soil humidity as quantitative data.

3.2 The effects of different watering system

When using the same source and watering for the same time, the effects of watering system can be affected by” water pressure, the diameter of pipe, et al.”, therefore this paper measured how much yield that the watering system watered the plants. Watering by drip irrigation system has better efficiency as Figure 4 shows, it can provide more water for the plants than watering by gravity with drilled PVC pipe when using the same source and watering for the same time.

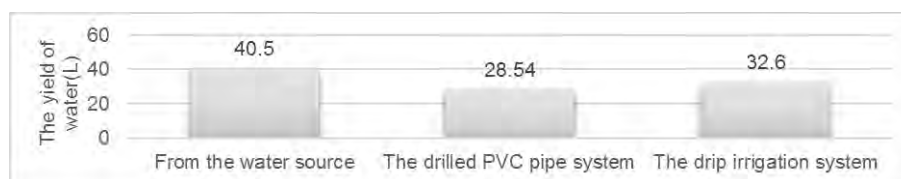

Figure 4: The provided water yields from the water source and different watering system

When watering the green wall everyday with 11.25 L/m², the average soil humidity of different watering system was almost the same. Which means the watering system doesn't have obvious efficiency difference in this watering frequency (Figure 5). Furthermore, when comparing the average soil humidity of different spots (Figure 6), the average soil humidity of all the D spots were higher than the other spots. That is because the water always runoff by gravity.

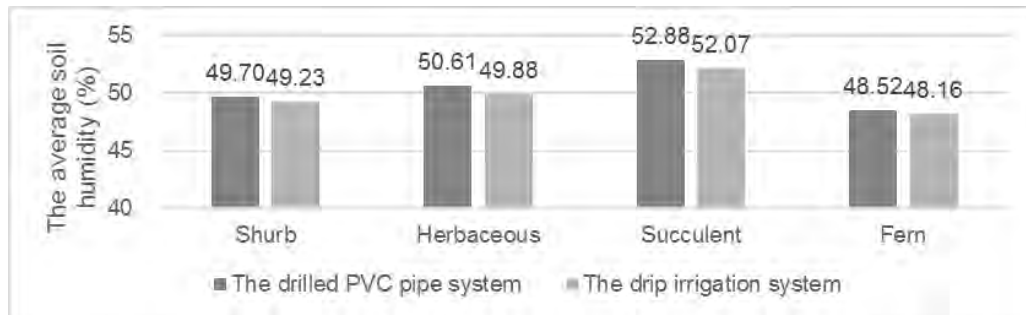

Figure 5: The average soil humidity of different plants when watering everyday

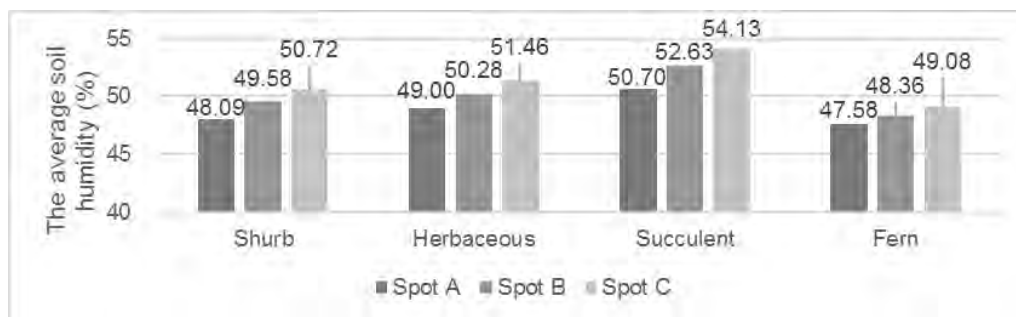

Figure 6: The average soil humidity of different spot when watering everyday

When the frequency was watering the green wall each 2 days with 11.25 L/m², the average soil humidity was still affected by gravity. However, when the frequency was watering the green wall every 3 days or 4 days (Figure 7) with 11.25 L/m², the average soil humidity of D spots by watering with the drilled PVC pipe were lower than the other spots, but the average soil humidity of d spot by watering with the drip irrigation system were still higher than the other spots. Overall, when using the same water source and watering for the same frequency, the drip irrigation system is better than the drilled PVC pipe.

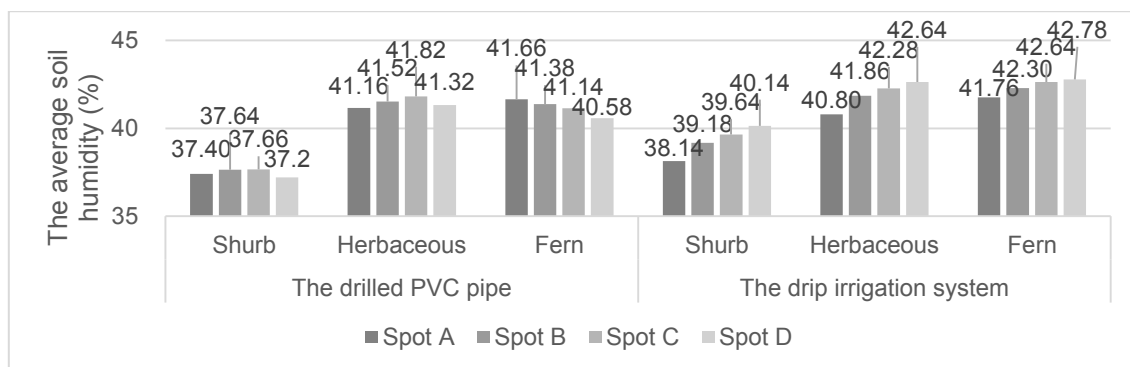

Figure 7: The average soil humidity of different spot when watering every 4 days

3.3 The suitable watering frequency

According to the measuring result, the maximum soil humidity was 54%. The soil humidity of shrub decreased 8% per day, and the shrub withered when the soil humidity went down to 33 - 36%. Therefore, the suitable water frequency for shrub was watering each $(54-36)/8 = 2.51$ days, that is the shrub should be watered each 2 days when using 11.25L/m² yield of water. By the same method, this paper discovered that the herbaceous plant and

the fern plant should be watered every 3 days. Therefore, the suitable watering frequency is to watering the green wall each 2 days with 11.25L/m². In this frequency, only succulent plants could rot and die, but other plants all grow well without being withered or shrivelled.

3.4 The water consumption of different plants

This study collected the water which wasn't absorbed by the plants to know the suitable yield of water for each plants in different watering frequency. The single plant took 0.45m² on the green wall in the experiment, and the actual water yield for different plants in watering everyday could be calculate as Equation 1.

$$\text{The water absorbed by the plants (L) / plant area (m}^2\text{)} = \text{water consumption (L/m}^2\text{)}$$

Equation 1

The Rhoeco spathaceo is a kind of succulent plants, and it could rot then die when the soil humidity was higher than 45%. This study had replaced the dead items and changed the watering frequency, then figured out that the suitable watering frequency for it is watering once a week.

Overall, the suitable watering frequency and the water consumption for different plants are: (1) Shrub: 11.73 L/m², each 2 days; (2) Herbaceous plants: 8.93 L/m², each 2 days; (3) Fern plants: 5.31 L/m², each 2 days; (4) Succulent plants: 9.73 L/m², once a week.

3.5 The water conservation materials

To decrease the water consumption, the green wall should have suitable water recycle system and water conservation materials. As Figure 8 shows, there is about 50% water wasn't absorbed by the plants in watering every day or each two days. And the Figure 9 shows that when using water conservation materials, the water runoff on the ground had decreased from 52% to 28%.

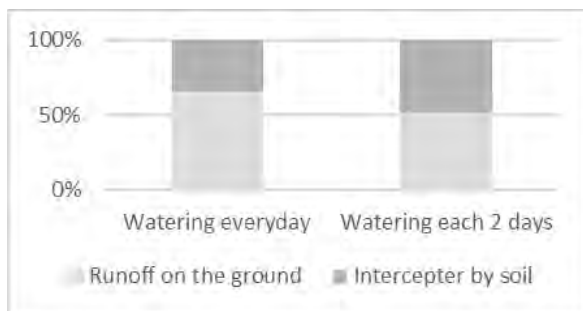

Figure 8: The runoff and absorbed water

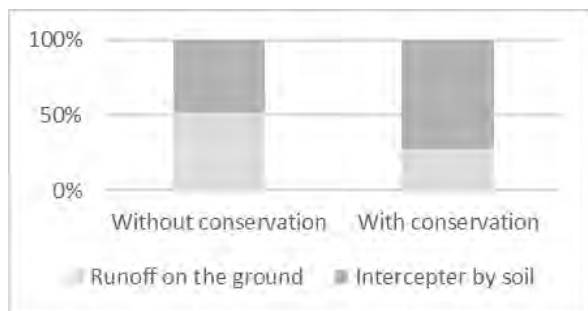

Figure 9: The conservation materials effect

4. CONCLUSION

The onsite experiment results indicate that to keep the plants survive, the drip irrigation system is the better watering system because it can provide more water when using the same water source and watering the same time.

There should be appropriate water conservation materials and irrigation water recovery mechanism for green wall. According to this experiment, if a green wall had no water conservation materials, over 50% water would runoff directly. When the green wall had water conservation materials, the runoff water could be reduced to below 30%. Therefore, if any water recycle system could be applied, the water consumption could be reduced effectively.

This paper figures out the green wall should take different watering frequency when using different plants. In order to take consideration to plant survival and reduce water consumption, the suitable watering frequency and the limit yield of water for each plant for the green wall in Taichung city are: (1) Shrub: 11.36 L/m², each 2 days; (2) Herbaceous plants: 8.93 L/m², each 2 days; (3) Fern plants: 5.31 L/m², each 2 days; (4) Succulent plants: 9.73 L/m², once a week.

REFERENCES

- [1] B. F. Lee, 2006. How to Maintain and Manage the Landscape Plantings. Journal of the Landscape Architects Society, vol. 58, pp. 57-70.
- [2] K.C. Hong, 2012. Research on the Performance of Green Fencing for Building Construction Projects. Master thesis. National Taipei University of Technology.
- [3] M. X. GU, 2012. Ch7 the Plants and the Soil. The Agronomy Lecture, from the Department of Plant Industry, NPUST.
- [4] T.F. Hsu, 2010. The Evaluation of Selecting the Low-Maintenance Plants on Outdoor Vegetation Wall in Taichung City. Master thesis. Tung Hai University.
- [5] T.L. Hsieh, 2013. The Assessment of the Green Fence at Construction Site in Taichung City. Master thesis. Tung Hai University.

Low Carbon Construction Implementation in a Public Housing Development and the Implication to the Life Cycle Decision Making Tool

Felix WONG Yat-hang^a, TANG Yu-tin^b

^aAECOM Asia Co. Ltd., Hong Kong SAR, felix.yh.wong@aecom.com

^aAECOM Asia Co. Ltd., Hong Kong SAR, felix819@hotmail.com

^bAECOM Asia Co. Ltd., Hong Kong SAR, yt.tang@aecom.com

ABSTRACT

A combined Life Cycle Assessment (LCA) and Life Cycle Costing (LCC) Study was undertaken to quantitatively measure the environmental impacts and cost implication of (1) an existing public housing block (50-year life); (2) an existing private sector residential block (50-year life) and (3) Integer Concept Tower (50-year and 75-year life) in 2003. The study measured the environmental impacts generated from the whole building life cycle stages including, raw material extraction, building material manufacturing, transportation, building operation, repair and maintenance, and disposal. However, the study did not quantitatively measure the environmental impact of on-site activities, except construction wastage. In 2013, Low Carbon Construction Plan was conducted for a new local public housing development in Hong Kong. The project develops the first low-carbon construction implementation plan for new housing development. The analysis included the entire 2.5-year construction period including (1) supply-chain; and (2) on-site construction. The project accounted and reported of the potential greenhouse gas emissions, possible offsets and removals for construction contract stage at the new public housing development in Hong Kong. This paper will report the findings and carbon reduction of the low-carbon construction measures and the implication of the life cycle carbon footprint of recent housing development in Hong Kong.

Keywords: climate change, green construction technology, life cycle assessment

1. INTRODUCTION

1.1 Life cycle assessment study in 2000s and the limitation on addressing public housing development in Hong Kong in 2010s

A combined Life Cycle Assessment (LCA) and Life Cycle Costing (LCC) Study quantitatively measured the life-cycle energy consumption, greenhouse gas emission, waste generation and cost implication of three 40-storey residential towers in Hong Kong - (1) an existing public housing block (50-year life); (2) an existing private sector residential block (50-year life) and (3) the Integer Concept Tower (50-year and 75-year life) in 2003 (Figure 1) (Amato, et al., 2003). One of the environmental indicators the study measured was the greenhouse gas emission generated from the whole building life-cycle including, raw material extraction, building material manufacturing, transportation, building operation, repair and maintenance, and disposal stage. Figure 2 shows the life-cycle greenhouse gas emission per construction floor area of the three 40-storey residential tower types. The building operation stage and repair and maintenance stage of the existing public housing block (50-year life) emitted 56% and 25% of the life-cycle greenhouse gas emissions, respectively. On the other hand, the building operation stage and the repair and maintenance stage of the existing private-sector residential block (50-year life) emitted 38% and 36% of the life-cycle greenhouse gas emissions, respectively. The result shows that the 50-year operational stage of existing public housing block emitted higher proportion of greenhouse gas emission (56%) than the existing private sector residential block (38%). It is because existing public housing block had a higher population density than private sector block in 2000s. The study concluded that energy efficiency, renewable energy generation, varying and improving how the housing to be run and maintained could greatly reduce the overall life-cycle environmental impacts and life cycle cost of the existing public housing block (Amato, et al., 2003).



Figure 1: (1) Existing public housing block; (2) Existing private sector residential block and (3) The Integer Concept Tower (left to right) developed in 2000s in Hong Kong

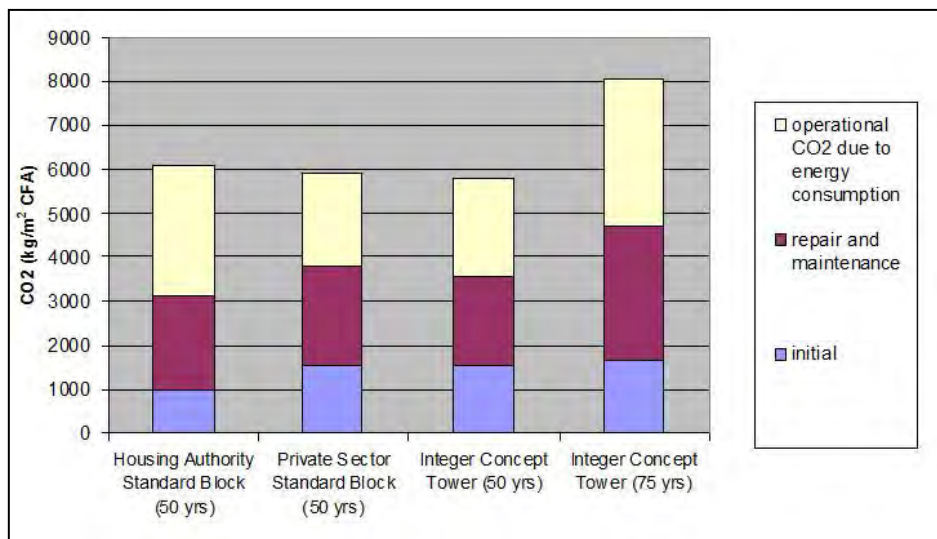

Figure 2: Life-cycle greenhouse gas emission per construction floor area of three residential tower types (Amato, et al., 2003)

In view of the conclusion of the above study, the newly-designed public housing blocks developed in 2010s incorporated numerous energy-efficient features and renewable energy system to reduce greenhouse gas emissions from the building operational stage. For instance, new public housing development completed in 2013 applied electronic ballast, T-5 fluorescent tubes and LED lighting on the lighting of the communal area. A two-level lighting control system was deployed in the lighting in the lift lobbies and corridors. The system could sustain a lower but acceptable level of lighting under normal conditions and could switch on the extra lighting when required. Those lighting control had reduced the energy consumption of lighting in communal area by 30% (Hong Kong Housing Authority, 2015). Renewable energy system in form of a photovoltaic system and lift with regenerative power generated 2% of energy consumption of the communal building services installation of the public housing block. Those energy efficiency measures reduce the carbon footprint of the building operation of newly-designed public housing developed in 2010s.



Figure 2: Two-level lighting control system (normal mode: 50 lux; triggered mode: 85 lux) (left); Roof photovoltaic system in a public housing development in 2010s (right)

In view of the construction stage, the previous life cycle study did not measure the greenhouse gas emission of on-site activities, except construction wastage. The construction contract period, including supply chain and site operation, can contribute a lot of the life-cycle greenhouse gas emissions of a public housing development.

1.2 Low carbon construction plan of public housing development

In 2013, Low Carbon Construction Plan was completed in a new local public housing development. The construction was commenced from 2010 and completed at 2013. The new public housing estate is comprised of 6 housing blocks of 35-40 storey residential buildings accommodating 5,204 units, car park, commercial centre, community youth service centre and elderly day centre.

This paper will report the findings and carbon reduction of the low-carbon construction measures and the implication of the life cycle carbon footprint of the new housing development in Hong Kong. Accounting covers the whole construction contract period, including:

- Supply Chain
 - Raw-material extraction,
 - Transportation from the extraction site to factory,
 - Building-material manufacturing in factory
 - Transportation from factory gate to the construction site; and
- Site Operation – construction activities in the local housing development

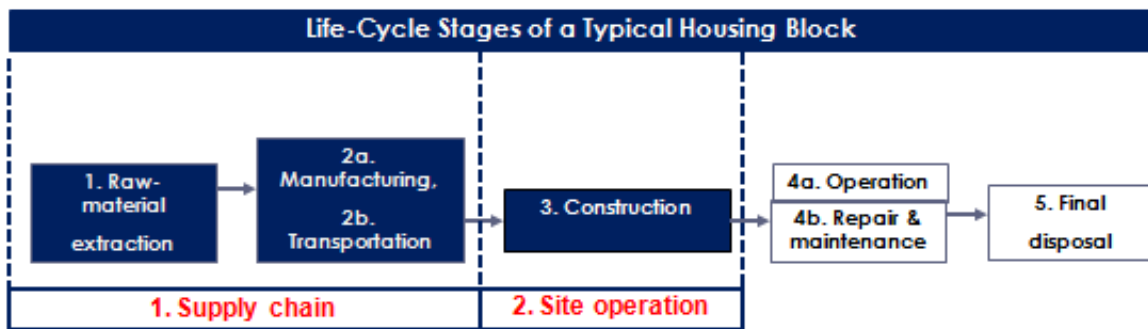









Figure 3: Life cycle stages in the construction contract period

2. ACCOUNTING METHODOLOGY AND RESULT OF CARBON REDUCTION

The accounting of greenhouse gas emission for the Low Carbon Construction Plan began in March 2011. The study took the below accounting methodology for the reduction of the low-carbon measures of the new local public housing development. Table 1 includes the low-carbon construction measures of the Low Carbon Construction Plan, their accounting methodology and their carbon reduction.

	Low Carbon Construction Measures	Accounting Methodology	Carbon Reduction
	<ul style="list-style-type: none"> • Volumetric Precast Bathroom (VPB) • Volumetric Precast Kitchen (VPK) 	Life Cycle Assessment (Cradle to Site Stage) <ul style="list-style-type: none"> a. Raw-material extraction b. Transportation from extraction site to prefabrication factory c. Manufacturing of VPB/ VPK and precast elements at prefabrication factory 	2854 tonne CO ₂ -e

	<ul style="list-style-type: none"> • Precast façade • Precast wall • Precast stair • Precast tie beam • Precast landing • Precast refuse chute • Precast beam and column for carpark 	<p>d. Transportation of VPB/ VPK and precast elements from prefabrication factory to construction site</p>	<p>4329 tonne CO₂-e</p>
 	<ul style="list-style-type: none"> • Semi-precast slab with fabric reinforcement 	<p>Life Cycle Assessment (Cradle to Site Stage)</p> <ol style="list-style-type: none"> a. Raw-material extraction b. Transportation from extraction site to prefabrication factory c. Transportation of fabric reinforcement from Hong Kong to prefabrication factory d. Manufacturing of prefabrication elements at prefabrication factory e. Transportation from prefabrication factory to construction site 	<p>1400 tonne CO₂-e</p>
	<ul style="list-style-type: none"> • Marine mud material into useful building element 	<p>The accounting measured the reduction of carbon footprint for transportation of the paving materials made in factory to site and the transportation of waste marine mud to public fill and the electricity consumption of convey belt and mixer.</p>	<p>487 tonne CO₂-e</p>
	<ul style="list-style-type: none"> • Early electricity supply from grid 	<p>The accounting measured the reduction of carbon footprint between electricity from grid and from diesel generator during construction period.</p>	<p>1866 tonne CO₂-e</p>
	<ul style="list-style-type: none"> • Recycling and waste sorting facilities on each block 	<p>The accounting measures the reduction of carbon footprint from recovery of materials from waste recycling and sorting. The waste recovered includes steel bar, concrete, plastic bottles, paper and aluminium cans.</p>	<p>2394 tonne CO₂-e</p>
<p>Reuse of concrete to produce temporary site drain</p> 	<ul style="list-style-type: none"> • Volume of reused water and water saving 	<p>The accounting measures the reduction of carbon footprint from water reuse for vehicle washing facilities and dust control during construction period and water saving</p>	<p>3.8 tonne CO₂-e</p>





Waste sorting facilities			
	<ul style="list-style-type: none"> • Diesel bobcat\ forklift/ truck with biodiesel fuel (B5) 	<p>The accounting reports the carbon emission reduction due to the use of biodiesel B5 for replacement of normal diesel. Biodiesel was blended in the diesel. In Hong Kong, most of the biodiesel is sourced from the collected cooked oil from restaurant. In Hong Kong situation, biodiesel is more environmental friendly as it reuses waste cooked oil from restaurants.</p>	0.5 tonne CO ₂ -e
	<ul style="list-style-type: none"> • Solar hot water system for staff showering 	<p>The accounting reports the reduction in carbon emission when using solar hot water system in addition to electrical water heater.</p>	4.8 tonne CO ₂ -e
	<ul style="list-style-type: none"> • Food waste decomposer for staffs 	<p>The accounting reports the carbon reduction from food waste decomposer in compare to landfill decomposition. Food-waste-decomposer was adopted to convert the food waste into fertilizer which can be used in tree planting or donated to nearby school or communities.</p>	0.4 tonne CO ₂ -e
	<ul style="list-style-type: none"> • Tree planting for hoarding greening 	<p>The accounting reports the carbon absorption from trees pre-planting on construction site.</p>	2.2 tonne CO ₂ -e
	<ul style="list-style-type: none"> • Electric site car 	<p>The accounting reports the carbon reduction in carbon emissions when using electric car to replace petroleum site car as contract car.</p>	2.2 tonne CO ₂ -e
	<ul style="list-style-type: none"> • Computer Document Management System 	<p>The accounting reports the carbon reduction in carbon emissions in paper saving.</p>	0.9 tonne CO ₂ -e

Table 1: Low carbon construction measures of the low carbon construction plan and accounting methodology

3. CARBON REDUCTION FROM THE LOW CARBON CONSTRUCTION PLAN

Low Carbon Construction Plan reduces a total of 13,345 tonne CO₂-e for the construction contract period of the new public housing development which accommodates over 5,000 residential units. The total carbon reduction from Volumetric Precast Bathrooms, Volumetric Precast Kitchens, prefabrication elements and semi-precast slabs are 8,583 tonnes CO₂-e. Most of the carbon emission reduction result in carbon emission in raw-material extraction stage. It is because far less formwork and better quantity and quality control occur in prefabrication manufacturing in a factory environment. For instance, 12 sets of steel formwork were used during the whole production period to produce 4,910 numbers of Volumetric Precast Bathrooms, which is far less than the quantity of formwork required in in-situ construction. (Wong

& Tang, 2012) Some low-carbon construction measures are implemented in small scale. Examples are diesel bobcat/forklift/truck with biodiesel fuel (B5), electric site car, tree planting for hoarding greening and food waste decomposer for staffs. The carbon reduction can potentially be increased if all diesel fuels would be replaced with biodiesel (B5) and all site cars would be replaced by electric cars in the future project.

4. IMPLICATION TO THE LIFE CYCLE CARBON FOOTPRINTS GREENHOUSE GAS EMISSION OF HOUSING DEVELOPMENT

The new local public housing development adopts both low-carbon construction measures and energy-efficient features. The pioneer low-carbon construction approaches include Volumetric Precast Bathroom, Volumetric Precast Kitchen, various precast construction elements; semi-precast slab; marine mud building elements; early grid connection; recycling and waste sorting facilities; reused water and water saving; use of biodiesel; solar hot water for staff showering; food waste decomposer; hoarding greening and electric site car. The energy-efficient features include electronic ballast; T-5 fluorescent tubes; LED lighting; two-level lighting control system for lift lobbies and corridors; renewable energy system in form of a photovoltaic system and lift with regenerative power. Both low-carbon construction measures and energy-efficient features reduce the carbon footprint of both construction and building operation stages.

In consideration of the carbon emission from both supply chain, site operation and building operation, Figure 4 shows the comparison of the life cycle greenhouse gas emission per construction floor area of the public housing block of 2003 study and the new local housing development with Low Carbon Construction Plan completed in 2013.

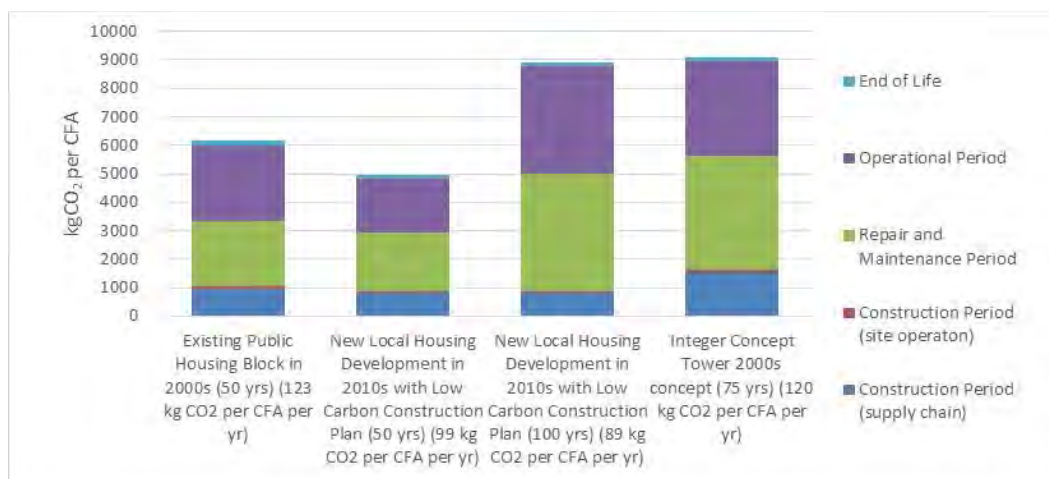

Figure 4: Life cycle greenhouse gas emission of the new local housing development with low-carbon construction plan and energy-efficient measures compared to existing public housing block and integer concept tower developed in 2000s

The life-cycle greenhouse gas emission of the new local housing development accounts both carbon reduction of Low Carbon Construction Plan, energy efficiency and renewable energy systems. The life-cycle greenhouse gas emission can be reduced by 19.4% under 50 years of operational life with Low Carbon Construction Plan, various energy efficiency and renewable energy systems. Low Carbon Construction Plan reduces 15.9% of the greenhouse gas emissions of construction contract stage while energy efficiency and renewable energy system reduce 29% of the greenhouse gas emissions of building operational stage. The operational life of new housing buildings could be at least 100 years according to recent research and development work (Mak, 2010). In consideration of the extended 100-year life, the indicator in form of life-cycle greenhouse gas emissions per construction floor area per year can be adopted to compare building with different operational life. The local housing development in 2010s with Low Carbon Construction Plan and energy efficiency measures with extended 100-year life can reduce life-cycle greenhouse gas emission to 89 kg per construction floor area per year while the life-cycle greenhouse gas emission of public housing block (50-year life) and Integer Concept Tower (75-year life) in 2003 study emitted 123 kg and 120kg per construction floor area per year. 28% and 26% greenhouse gas emission can be reduced from the Low Carbon Construction Plan and energy efficiency measures.

5. CONCLUSIONS

This paper takes into account the carbon reduction from the Low Carbon Construction Plan and the implication of the life-cycle carbon footprint of housing development in Hong Kong. Most of the carbon reduction come from prefabrication plan for the local public housing development. The carbon reduction can potentially be increased if the small-scale measures can apply in project-scale. Low Carbon Construction Plan reduces 15.9% of greenhouse gas emission of construction contract period. The study does not take into consideration the implication from varying and improving how the housing is run and maintained. The study does not take into consideration the life-cycle cost implication of the Low Carbon Construction Plan. Analysis can be made on the cost-effectiveness of various low-carbon construction measures. Guidelines can then be set up to direct the whole construction industry towards sustainable and low carbon construction in a cost-effective manner.

ACKNOWLEDGMENT

The study was supported by the China State Construction Engineering and Hong Kong Housing Authority. The support is gratefully acknowledged.

REFERENCES

- [1] Environment Bureau, HKSAR Government. , 2011. Hong Kong's Climate Change Strategy and Action Agenda - Consultation Document, Hong Kong: Environment Bureau, HKSAR Government.
- [2] Environmental Protection Department and the Electrical and Mechanical Services Department, 2010. Guidelines to Account for and Report on Greenhouse Gas Emissions and Removals for Buildings (Commercial, Residential or Institutional Purposes) in Hong Kong, HKSAR: 2010.
- [3] Amato, A., Frewer, R. & Humphrey, S., 2003. A Comparative Sustainability Assessment of Standard Housing Blocks in Hong Kong and Proposed Integer Concept Tower Alternative. International Journal of Construction Management, pp. 93-108.
- [4] Hong Kong Housing Authority, 2015. Initiatives in Planning and Construction of New Housing Estates. [online] Retrieved at: <https://www.housingauthority.gov.hk/mini-site/hasr1314/en/common/pdf/05.pdf>
- [5] Mak, J., 2010. Seminar on Research and Development Work: Structure and Geotechnics. [online] Retrieved at: <http://www.housingauthority.gov.hk/en/common/pdf/business-partnerships/quality-housing/quality-housing-seminar/QualitySeminarStructure2010.pdf>
- [6] Wong, F. & Tang, Y., 2012. Comparative Embodied Carbon Analysis of the Prefabrication Elements compared with In-situ Elements in Residential Building Development of Hong Kong. International Journal of Civil, Environmental, Structural, Construction and Architectural Engineering, 2(6).

Use of Incineration Bottom Ash for Road Construction in Singapore

HO Nyok-yong^a, Kelvin LEE Yang-pin^b, YAP Cheng-chwee^c, TONG Kum-kong^d, LIM Chong-teik^e

^a Samwoh Innovation Centre, Singapore, nyokyong.ho@samwoh.com.sg

^b Samwoh Innovation Centre, Singapore, kelvin.lee@samwoh.com.sg

^c Land Transport Authority, Singapore, yap_cheng_chwee@lta.gov.sg

^d Land Transport Authority, Singapore, tong_kum_kong@lta.gov.sg

^e Land Transport Authority, Singapore, lim_chong_teik@lta.gov.sg

ABSTRACT

Every year, about 600,000 tonnes of incineration ash is produced in Singapore. The ash comprises bottom ash and fly ash. The bottom ash contains less leachable metals of concern and soluble salts and has a great potential for utilization. In 2008, Samwoh participated in a trial initiated by Land Transport Authority to evaluate the use of bottom ash in road construction. The study comprises laboratory tests and field trial to evaluate the properties of the bottom ash which was processed using a patented technology. The bottom ash was used for the construction of road base and subbase. The test results showed that the processed bottom ash meets all the relevant regulatory requirements.

Keywords: incineration bottom ash, road construction, road base and subbase.

1. INTRODUCTION

Singapore is a small city state with one of the highest population densities in the world. A key challenge is the limitation of land for waste disposal. One of the main strategies adopted by the government is to dispose the waste at waste-to-energy (incineration) plants to reduce waste volume by about 90%.

Every year, about 600,000 tonnes of incineration ash is produced (National Environment Agency, 2015). The ash comprises about 80-90% of bottom ash and 10-20% of fly ash. Incineration bottom ash (IBA) contains less leachable metals of concern and soluble salts and has a great potential for utilization. A key concern on the use of IBA is its potential leaching effect. The IBA has to be properly processed for safe applications. In 2008, Samwoh participated in a trial initiated by Land Transport Authority (LTA) to evaluate the use of IBA in road construction as **part of LTA's Green Pavement initiative**.

This paper presents the findings of a study which involves IBA processing, laboratory tests and construction of a field trial to evaluate the engineering and environmental properties of IBA. The ash was processed using a patented technology. Laboratory tests such as particle density, water absorption, maximum dry density, California bearing ratio, toxicity characteristic leaching test, dioxin and furan analyses were conducted to ascertain the quality of the processed IBA. Subsequently, a field trial was performed to determine the field performance of the ash which was used for the construction of road base and subbase. The test results are presented in this paper.

2. PROCESSING OF IBA

The processing of IBA involves ageing, screening to remove foreign materials such as unburned materials, ferrous and non-ferrous metals, crushing, sieving into the required size and chemical treatment using a patented process which is a commercially well-proven process to produce treated ash that meets regulatory leaching limits and be safely used in applications such as structural fill or road base.

The IBA was allowed to age for about 8 to 12 weeks from the time of arrival at the storage yard. Ageing allows swelling, hydration, carbonation, and oxidation aging reactions to occur. After the ageing process, the IBA was processed via the following processes:

- Preliminary screening to remove oversize and unburned materials
- Removal of ferrous and non-ferrous metals
- Crushing to break down the IBA into smaller particle size
- Sieving of IBA to the required size

- Chemical treatment
- Stockpile of the processed IBA at the storage area

After the IBA was processed, the ash was mixed with water and some additives using a pugmill mixer to enhance the bearing capacity of the IBA for base and subbase application.

3. LABORATORY TESTS

Laboratory tests were conducted on the processed IBA to determine its engineering and environmental properties. The results are described in the following sub-sections.

3.1 Engineering properties

The results for the engineering properties are shown in Table 1.

Properties	Results	Test Method
Particle density (oven dry)	1.62 Mg/m ³	SS 73:1974
Water absorption	22.5%	SS 73: 1974
Maximum dry density	1.48 Mg/m ³	BS 1377-4:1990
Optimum moisture content	24.9%	BS 1377-4:1990
California bearing ratio (soaked)	180%, 193%	BS 1377-4:1990
Plasticity index	8%	BS 1377-2:1990

Table 1: Engineering properties of processed IBA

From Table 1, the results showed that the processed IBA is relatively lightweight as compared to granite (conventional aggregate used for road construction in Singapore) which has a particle density of about 2.6 Mg/ m³. The IBA is highly absorptive with water absorption of more than 20% and the optimum moisture content required for compaction is about 25%. In order to provide adequate bearing capacity for the base/ sub-base application, the processed IBA was treated with additives for strength enhancement. The CBR (soaked) showed more than 180% which meets the LTA specification requirement (LTA, 2010) of minimum 30% for subbase and the CBR is comparable to conventional graded granite aggregate base. As such, the processed IBA will provide good bearing capacity for subbase and road base applications.

3.2 Environmental properties

The environmental characteristics of the IBA samples were determined according to Toxicity Characteristic Leaching Procedure (US EPA Method 1311) and dioxin/ furan analyses (US EPA Method 1613). The tests were conducted on unprocessed and processed samples. The results are shown in Tables 2 and 3.

Test constituent	Unprocessed IBA			Processed IBA			Maximum Concentration
	Batch 1 (4 Sep 08)	Batch 2 (16 Sep 08)	Batch 3 (2 Oct 08)	IBA 1	IBA 2	IBA 3	
Arsenic	<0.03	<0.03	<0.03	<0.03	<0.03	<0.03	5
Barium	0.28	0.35	0.35	0.36	0.33	0.38	100
Cadmium	<0.0025	0.054	0.093	0.072	0.055	0.058	1
Chromium	<0.0045	<0.0045	<0.0045	<0.0045	<0.0045	<0.0045	5
Copper	0.62	1.21	2.05	1.71	1.80	1.93	100
Cyanide	<0.06	<0.06	<0.06	<0.06	<0.06	<0.06	10

Fluoride	1.4	1.2	0.91	1.4	1.3	1.2	150
Iron	<0.02	0.23	<0.02	<0.02	<0.02	<0.02	100
Lead	<0.035	<0.035	<0.035	<0.035	<0.035	<0.035	5
Manganese	0.16	3.33	3.75	3.22	2.45	3.68	50
Mercury	0.0056	<0.0003	<0.0003	<0.0003	<0.0003	<0.0003	0.2
Phenolic Compounds	<0.15	<0.15	<0.15	<0.15	<0.15	<0.15	0.2
Selenium	<0.05	<0.05	<0.05	<0.05	<0.05	<0.05	1
Silver	<0.005	0.016	0.02	0.023	0.023	0.026	5
Zinc	0.012	13.6	19.9	7.60	3.92	5.51	100
Nickel	0.019	0.41	0.29	0.38	0.19	0.24	5

Table 2. Results for toxicity characteristic leaching procedure (mg/L)

Congener	Unprocessed IBA			Processed IBA		
	Batch 1 (4 Sep 08)	Batch 2 (16 Sep 08)	Batch 3 (2 Oct 08)	IBA 1	IBA 2	IBA 3
2378-TCDF	0.9500	0.6500	1.2900	1.1643	1.1517	0.8049
12378-PCDF	0.8850	0.5950	2.5450	0.7739	0.8141	0.6150
23478-PCDF	20.4000	7.9500	43.9000	11.3610	12.3165	9.8295
123478-HxCDF	5.0000	3.7800	18.0500	2.9490	2.9712	2.4939
123678-HxCDF	5.6600	2.5100	15.5900	2.9055	2.7507	2.2383
234678-HxCDF	7.7700	2.7100	28.7700	3.1872	3.0042	2.5950
123789-HxCDF	1.7800	1.0200	4.6500	0.5232	0.4818	0.3297
1234678-HpCDF	4.8940	1.3830	14.4770	1.3211	1.2938	1.1436
1234789-HpCDF	0.4100	0.1480	1.2180	0.1247	0.1217	0.1101
OCDF	0.0269	0.0072	0.1112	0.0054	0.0050	0.0047
2378-TCDD	1.4000	0.7000	5.5000	2.2650	2.3910	1.4610
12378-PCDD	4.1000	4.8000	0.0000	9.4470	9.6990	4.9140
123478-HxCDD	1.4500	1.1900	4.5400	0.8202	1.1178	0.5457
123678-HxCDD	4.4200	7.0500	14.7000	2.7771	3.3243	2.0928
123789-HxCDD	2.2400	2.3100	6.6300	1.9068	2.4177	1.4982
1234678-HpCDD	5.3700	5.7860	17.3460	2.7274	3.0417	2.2299
OCDD	0.1823	0.1086	0.6195	0.0587	0.0575	0.0496
Total	66.9	42.7	179.9	44.3	47.0	33.0

Table 3: Dioxin/furan results (WHO-TEQ, pg/g)

Based on Table 2, no distinct changes were found in the results for the Toxicity Characteristic Leaching Procedure between the unprocessed and processed IBA. The results showed that all the unprocessed and processed IBA samples meet the regulatory requirements.

The test results for the dioxin/ furan analyses are shown in Table 3. They are expressed in terms of WHO toxic equivalent value (TEQ). The unprocessed IBA showed less than 200 pg TEQ/ g of dioxin/ furan and the processed IBA samples showed less than 50 pg TEQ/ g of dioxin/ furan. Based on regulatory requirements, the limit for dioxin/ furan contained in the IBA is 1000 pg TEQ/ g for road construction applications. The results showed that all the unprocessed and processed IBA samples meet the requirement.

4. FIELD TRIAL

Further to the laboratory tests, a field trial was constructed which comprises two test sections of 50m length each as shown in Figure 1. The processed IBA was used as a substitute for conventional materials approved by the LTA for the construction of road base and subbase. The assessment was conducted with respect to groundwater monitoring as well as pavement testing.

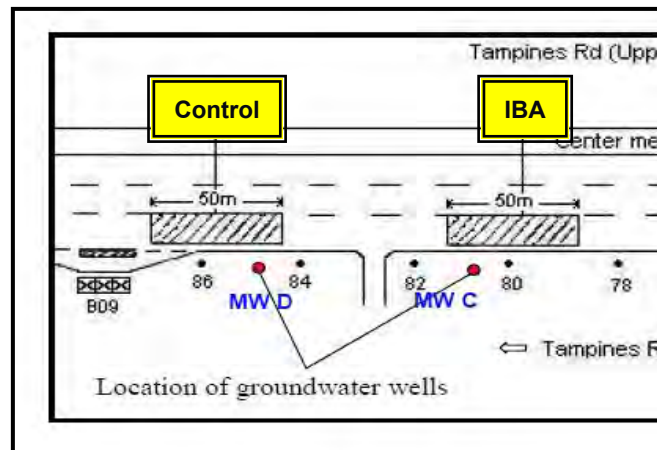

Figure 1: Location of test sections

4.1 Groundwater monitoring

Groundwater samples were collected from the groundwater wells, MW C and MW D as shown in Figure 1. A total of four groundwater tests were carried out over a period of 1 year, namely, before construction of the test sections and three times after construction. The tests conducted include conductivity, total organic carbon, total nitrogen, total phosphorus, total hardness, pH, heavy metals, dioxin and furan, as well as organic constituents.

Some of the results are shown in Table 4. In comparison with the results before construction, most of the results obtained after the construction showed a reduction in the concentration for each groundwater well. The results taken after the construction did not show any significant changes.

Type of Test	MW C				MW D			
	Before construction	After construction			Before construction	After construction		
	19/02/09	28/04/09	28/10/09	26/01/10	19/02/09	28/04/09	28/10/09	26/01/10
Conductivity (ms/cm)	17.5	7.37	6.42	9.24	11.1	1.16	1.19	1.00
Total organic carbon (mg/L)	52.6	30.7	26.6	26.7	20.1	6.6	6.2	5.8
Total nitrogen (mg/L)	34.8	29.5	34.9	37.8	29.8	5.2	5.3	8.1

Total phosphorus (mg/L)	0.11	0.03	0.06	N.D.	N.D.	0.04	0.06	0.03
Total hardness (mg/L)	2664	988	884	1217	1627	290	349	309
pH	-	-	6.9	6.9	-	-	6.7	6.7

Note: N.D. means "Not detected" where the result is less than the limit of reporting

Table 4: Groundwater test results

4.2 Pavement performance monitoring

The pavement performance condition was evaluated with respect to riding quality in terms of the International Riding Index (IRI) using a multi-laser profiler and structural strength using a deflectograph shown in Figure 2.



Figure 2: Left: laser profiler; right: deflectograph

The IRI is a roughness index that is widely used to express road roughness on a common internationally recognized scale. IRI is calculated from a mathematical function of the pavement longitudinal profile and is expressed as the average longitudinal road profile that represents the vertical response of a hypothetical quarter-car traveling at 80km/h to the measured longitudinal road profile. The calculation has been documented in ASTM E1926. The test results are shown in Figure 3.

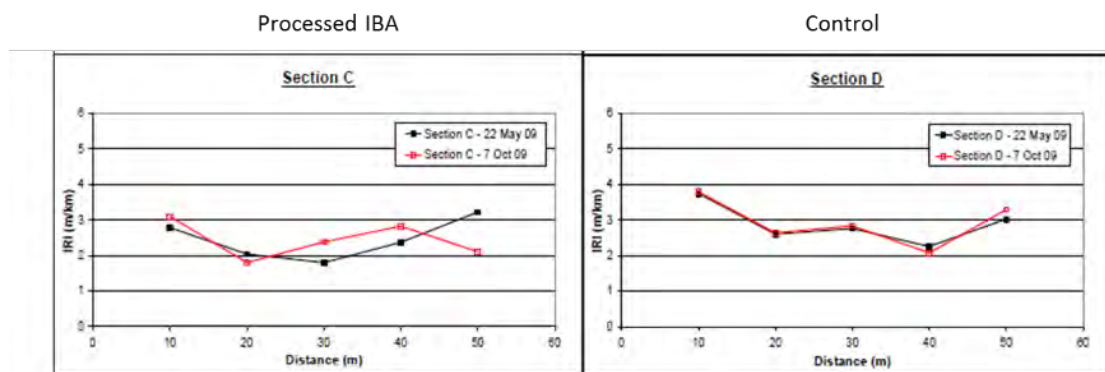

Figure 3: IRI results

The results showed that the IRI is less than 4m/ km which meets the LTA specification requirement (LTA, 2010). The two test sections showed similar performance in terms of riding quality.

The structural strength of the test sections was measured using a deflectograph which works on the principle that as a loaded wheel (of about 100kN) passes over the pavement, the pavement deflects and the size of the deflection is related to the strength of the pavement layers and subgrade. It is an automated deflection measuring system and a fully self-contained lorry-mounted system, whereby measurements of deflection are taken at approximately 4m intervals in both wheel-paths while the machine is in motion. The test results are shown in Figure 4.

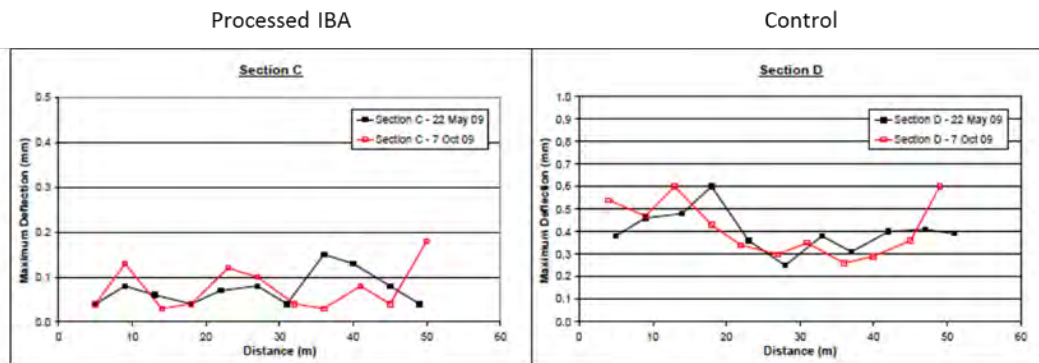

Figure 4: Deflection results

The results showed that the deflection measurements for the processed IBA are significantly lower as compared to the control section. This implied that the former showed higher structural strength as compared to the latter.

5. CONCLUSIONS

This paper presents the results of a study that was carried out to evaluate the use of processed IBA for the construction of road pavement. The key findings are summarized as follows:

- Laboratory tests –The processed IBA meet the regulatory requirements for Toxicity Characteristic Leaching Procedure and dioxin/ furan analyses. It also showed a high CBR which will provide good bearing capacity for road construction.
- Groundwater tests – The test results obtained after the construction of the test sections were generally better or comparable to the results before the construction. This implied that the processed IBA is safe for usage.
- Pavement performance tests - The test results showed that the test sections showed similar IRI and meet the LTA requirement of not more than 4m/ km. In the case of structural strength, the processed IBA showed higher structural strength as compared to the control section.

Based on these findings, it can be concluded that the processed IBA can provide a good substitute for conventional paving materials for road construction.

REFERENCES

- [1] American Society for Testing and Materials. ASTM E1926-08 (2015). Standard Practice for Computing International Roughness Index of Roads from Longitudinal Profile Measurements. West Conshohocken, PA, 2015.
- [2] British Standards Institute. BS 1377-2:1990. Methods of Test for Soils for Civil Engineering Purposes. Classification Tests. BSI. London, UK, 1990.
- [3] British Standards Institute. BS 1377-4:1990. Methods of Test for Soils for Civil Engineering Purposes. Compaction-related Tests. BSI. London, UK, 1990.
- [4] Environment Protection Agency. EPA Method 1311. Toxicity Characteristic Leaching Procedure. 1992.
- [5] Environment Protection Agency. EPA Method 1613. Tetra-through Octa-chlorinated Dioxins and Furans by Isotope Dilution High Resolution Gas Chromatography (HRGC)/High Resolution Mass Spectrometry (HRMS): Revision A, 1990.
- [6] Land Transport Authority. Materials and Workmanship Specification for Civil and Structural Works. Revision A1, June 2010.
- [7] National Environment Agency. EPD Report 2015. Environmental Protection Division. Annual Report, 2015.
- [8] Singapore Standard. SS 73:1974. Methods of sampling and testing of mineral aggregates, sand and fillers. Singapore, 1974.

Exploring the Relationships between Construction Phases and Sustainable Construction Principles

Olabode Emmanuel OGUNMAKINDE^a, William David SHER^b, Kim MAUND^c

^a University of Newcastle, Australia, olabode.ogunmakinde@uon.edu.au

^b University of Newcastle, Australia, willy.sher@newcastle.edu.au

^c University of Newcastle, Australia, kim.maund@newcastle.edu.au

ABSTRACT

Efforts continue to embed sustainable construction within the built environment; however, little attention has been **given to construction professionals' understanding of the relationship** between the principles of sustainable construction and construction phases. With different professionals involved throughout the project life-cycle, achieving sustainable principles at different stages may be difficult. This emphasises the need to explore these **professional's understandings of the relationships between sustainable construction and construction phases**. This paper examines literature to establish this relationship as understood by construction professionals. Evidence is presented of a mutually inclusive relationship between the principles of sustainable construction and construction phases. This study highlights the limited understanding of the framework for describing these relationships.

Keywords: construction phases, sustainable construction, sustainable development

1. INTRODUCTION

Sustainable development (SD) has attracted the attention of policy makers, researchers, government and non-government organisations across the world. SD is **'development that meets the need of the present without compromising the ability of future generations to meet their own need'** (WCED, 1987: 66). Numerous attempts at achieving SD have been discussed. In 2015, Agenda 2030 was signed to reinforce commitment to SD. Intensive efforts have been made in this regard and continue to be supported by several industries including the construction industry.

The construction industry has been criticised for those of its activities that conflict with SD principles (Pearce, 2005). Construction consumes 50% of natural resources (European Commission, 2001). Kibert (2012) identified resources as including land, materials, water, energy and ecosystems, stating that "the energy invested in building materials and construction is significant, amounting to 20 percent of the total life-cycle of the facility" (p. 4). This emphasises the need for resource efficiency and alternative construction approaches. Sustainable construction (SC) is **seen as the industry's approach to achieve SD** (Abidin, 2010, Hoffman and Henn, 2008). The Conseil International du Batiment (CIB) defined SC as **"...creating and operating a healthy built environment based on resources efficiency and ecological principles"** (Kibert, 2012: 8). Achieving sustainability in construction requires a holistic approach. Although construction phases are generally viewed as sequential, alternative sequences are possible. Several researchers (Ahadzie et al., 2006, Lim and Mohamed, 1999, Takim et al., 2003) have identified these phases as conception, planning, design, tender, construction and operation. The success of any construction project depends on them (Ahadzie et al., 2006).

Construction professionals' **decisions** are important in achieving SC. The principles of SC provide a decision making charter for them throughout the construction life-cycle (Kibert, 2012). Achieving SC principles may be challenged by their understanding and interpretation of these principles. Some view SC as a process or the management of a process/ system (Ogunmakinde et al., 2016a). Kibert (1994) opined that professionals treat SC principles in isolation. This compromises understandings of their interconnectivity. Some studies address the links between sustainable principles and their application in construction. This paper explores the relationship between construction phases and the principles of SC.

2. SUSTAINABLE DEVELOPMENT

The landmark SD definition by WCED deals with meeting peoples' present needs without compromising their future. Some have criticised this as being too basic (Oskamp, 2002) and several refined definitions have emerged. SD can be described as "enhancing quality of life and thus allowing people to live in a healthy environment and improved social, economic and environmental conditions for present and future generations" (Ortiz et al., 2009: 29). Most definitions emphasise the importance of striking a balance between environmental conservation, social equity and economic profitability. Decision making is central (Dernbach, 2003) and must include economic, social and environmental concerns to achieve SD (Emas, 2015).

2.1. Sustainability

Much has been written about sustainability. Newport et al. (2003) observed that it is not instinctively understood and well-communicated. Similarly, Arif et al. (2013) described it as a concept lacking an accepted definition and focus, resulting in numerous definitions and differing interpretations. Pearce (2005) defines sustainability as something that accommodates conventional financial concerns, as well as environmental and social effects (known as the 'triple bottom line'). Their integrations, interactions and relationships are emphasised elsewhere (Hutchins and Sutherland, 2008, Tam, 2008). Sustainability is all encompassing and requires concerted efforts from various spheres to provide comfort to all sentient beings.

2.2. Construction and construction phases

Construction is the art or manner of building something. It involves processes that use land, water, energy and materials. Du Plessis (2002: 4) described construction as 'the broad process/ mechanism for the realisation of human settlements and the creation of infrastructure that supports development'. It requires both skilled and unskilled labour in joining different components. Irurah (2001) identified four levels of construction as site activity, comprehensive project cycle, business of construction and human settlement creation. Site activities (the most common interpretation) lead to the actualisation of buildings while the project cycle includes feasibility, design, construction, operation, decommissioning, demolition/ deconstruction and disposal (Du Plessis, 2007). The process of construction consists of many sequential stages.

Construction phases are similar but dependent on size and scope. The timeframe for each phase varies as different activities are required in each phase. Table 1 categorises these as pre-construction, actual construction and post construction. Ahadzie et al. (2006), argues that the success of any construction project depends on these phases. Ankrah (2007) noted that **the construction phase could determine a projects' success. It is important that construction professionals recognise the contribution of each phase in achieving results that are desired and sustainable.**

Construction phases	Author (s)	Category
Briefing, Sketch plans, Working drawings, Site operations and Feedback	(Royal Institute of British Architects, 2013)	Pre-construction Actual construction
Planning/ Design, Schematic design, Design development, Construction documents, Bidding, and Construction	Infrastructure and Facilities Planning Section of Michigan State University, USA.	Post construction
Conception, Planning, Design, Tender, Construction, and Operations	(Ahadzie et al., 2006, Lim and Mohamed, 1999, Takim et al., 2003)	

Table 1: Construction phases

2.3. Sustainable construction

SC is generally used to describe pre-construction, construction, and post construction processes. Persson et al. (2008) listed these processes as preliminary design, detailed design, engineering, planning and procurement and the phases as operation, maintenance, refurbishment, reconstruction, demolition and recycling. Huovila and Koskela (1998) opined that **SC is the building sector's response to the challenges of SD. Achieving sustainability in construction is challenging and SC remains a way industry meets present needs without compromises.** SC

addresses social, economic and environmental issues of buildings (Kibert, 2012) which suggests synergy with SD principles.

It is pertinent to note that resource efficiency, construction activities and construction phases are critical to SD. Ogunmakinde et al. (2016b) summarised SC as the effective management of all construction activities, resources and phases to create a safer built environment that meets present and future needs. Adopting SC involves integrating all the principles of SD into the construction activities of a project life-cycle, with every stakeholder being responsible for sustainable practices (Matar et al., 2008, Shen et al., 2008). Clients also play important roles by appointing professionals to practice SC (Abidin and Pasquire, 2007, Fadeyi et al., 2012). Construction professionals are responsible for providing sustainable buildings. Their understanding of SC informs their decisions which, in turn, affect the overall success (Abidin, 2010). Understanding decision-making processes and their relationships are pertinent when implementing SC (Rydin et al., 2007). Therefore, **SC principles, construction phases and decisions by construction professionals alongside clients' requirements and government mechanisms** are requisites of SD.

2.4. Sustainable construction principles

SC literature focuses on three main themes; resource efficiency, environmental protection, and waste minimisation. These encompass the overarching requirements of the construction industry in achieving SD. In 1994, the CIB articulated **seven simplified principles of SC to include 'reduce resource consumption; reuse resources; use recyclables resources; protect nature; eliminate toxics; apply life-cycle costing; and focus on quality'** (Kibert, 2012: 8). Hill and Bowen (1997) condensed these into social, economic, biophysical and technical principles. They are **to be considered by construction professionals and other stakeholders throughout a project's life-cycle** (Hill and Bowen, 1997, Matar et al., 2008). According to Kibert (2012), the **principles inform stakeholders' decisions at each phase of design and construction**. Al-Yami and Price (2006) emphasized the synergies and balances between the social, environmental, economic and political facets of construction in achieving SC. This depends on the **interrelationship between SC principles, construction phases, and the resources required throughout a project's lifecycle** (Kibert, 2012). Discovering how to integrate these areas is essential in solving built environment issues, highlighting the importance of SC to sustainable environments (Kibert, 1994).

3. METHODOLOGY

This study reviewed relevant academic literature relating to sustainable construction and construction phases. An electronic search of Google Scholar and other databases (including Scopus, Elsevier and Science direct) was **conducted using keywords such as "construction phases", "sustainable construction", "green construction technology", "sustainable development", and "sustainable construction principles"**. These searches identified several publications (journals, conference papers and theses) and a selection was made based on their contents. Overall, the conceptual linkages between SC principles and construction phases were reviewed. The manner in which these links can be used to achieve SC were then developed as a framework and presented in Figure 1.

4. RELATIONSHIP BETWEEN CONSTRUCTION PHASES AND SUSTAINABLE CONSTRUCTION PRINCIPLES

SC principles have been identified in section 2.4 while construction phases include planning, development, design, construction, use and operation, maintenance, modification and deconstruction. Understanding their relationship is important when implementing SC principles. The application of SC principles at the corresponding phase(s) is core to SC. In view of this, construction phases have been categorised as pre-construction; actual construction and post construction.

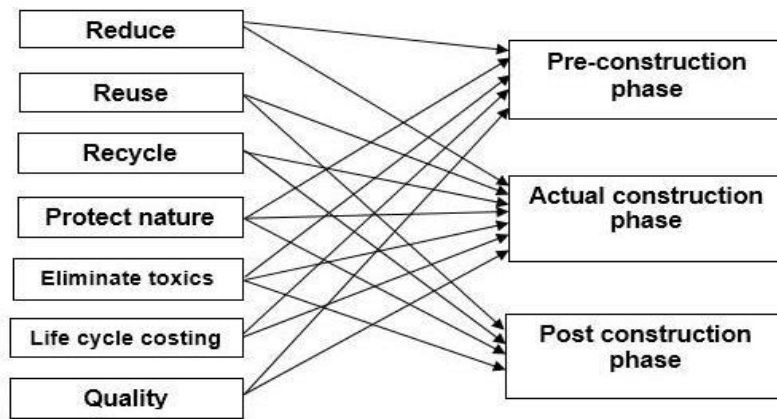

Figure 1: Framework for the relationship between SC principles and construction phases

The relationship between SC principles and construction phases is shown in Figure 1 and Table 2.

Reduce resource consumption (reduce): this principle addresses overconsumption, regarded as the main problem of sustainability (Kibert, 1994). It is aimed at decreasing resource and energy input in the consumption and production processes (Yong, 2007, Su et al., 2013). Several authors (Liu, 2012, Zhijun and Nailing, 2007, Su et al., 2013) emphasise material reduction, use of fewer resources and minimising the input of primary energy, particularly at the planning and design stages, to reduce waste and achieve efficient production and consumption. For SC, specification and use of durable materials with low maintenance requirements are vital at the pre-construction and actual construction stages.

Reuse resources (reuse): this is associated with processing and effective use of resources (Shi et al., 2006). Components used before are used again for the same purpose (European Union, 2008). Few processes are required for such reuse. Therefore, it has considerable environmental benefits including reduced energy consumption, fewer resources and less labour (Castellani et al., 2015). Reuse can revive local economies, reduce environmental impacts and create jobs (Castellani et al., 2015, Stahel, 2013). This should reduce dependency on virgin materials (Liu, 2012), **lengthen a product's life span and minimise waste** (Shi et al., 2006). Su et al. (2013) however stressed that frequent maintenance of reused products is necessary especially at the post-construction stage.

SC Principles	Construction Phase	Author(s) and year
Reduce	Pre-construction Actual construction	Yong (2007); Su et al. (2013); Shi et al. (2006); Liu (2012); Zhijun and Nailing (2007); Ghisellini et al. (2016); Damen (2012); European Union (2008).
Reuse	Actual construction Post construction	Shi et al. (2006); European Union (2008); Castellani et al. (2015); Stahel (2013); Liu (2012); Su et al. (2013).
Recycle	Actual construction Post construction	Duran et al. (2006); Moreno et al. (2014); European Union (2008); Van den Berg and Bakker (2015); Ghisellini et al. (2016); Murray et al. (2015); Shi et al. (2006); Su et al. (2013); Birat (2015);
Protect nature	Pre-construction Actual construction Post construction	Kibert (1994).
Eliminate toxics	Pre-construction Actual construction Post construction	Pacheco-Torgal and Jalali (2011); Liang and Ho (2007); Kibert (1994);
Life cycle costing	Pre-construction Actual construction	Fuller (2010); International Standard Organisation (2006); Sterner (2000); Ashworth and Hogg (2014); Clift (2003); Flanagan and Jewell (2008).
Quality	Pre-construction Actual construction	Arditi and Gunaydin (1997); Kibert (1994); Ashokkumar (2014).

Table 2: Relationship between SC principles and construction phases

Use recyclable resources (recycle): In the construction industry, recycling “takes place as long as construction and demolition wastes producers find it cheaper than landfilling and as long as users of construction aggregates find recycled aggregates cheaper and of similar quality than newly quarried aggregates” (Duran et al., 2006: 305). It requires considerable energy and does not include energy recovery (Moreno et al., 2014, European Union, 2008) and provides the last opportunity to recover the value of a material at the end of its life (Van den Berg and Bakker, 2015). This recovery operation (Ghisellini et al., 2016) may be applied to products or materials that cannot be reduced and reused. Murray et al. (2015) and Van den Berg and Bakker (2015) averred that recycling is mandatory and fundamental to achieving sustainability. It helps reduce the consumption of virgin materials (Shi et al., 2006, Su et al., 2013), and reduces wastes which include useable and potential materials (Birat, 2015). Thus materials could be recycled during actual construction or post construction based on the need and use of such material.

Protect nature: this principle is associated with protecting and preserving the natural environment and its ecological systems. Natural resources are extracted and manufactured into materials which are used for construction processes. These activities negatively affect the environment and ecosystems and can lead to resource depletion, pollution and destruction of flora and fauna. Protecting nature requires intelligent interventions (Kibert, 1994) and should be considered throughout the construction phases.

Eliminate toxics: use of non-toxic materials is as important as sustainable resource consumption is to SC (Pacheco-Torgal and Jalali, 2011). Air and water pollution in buildings results from materials releasing toxic fumes and contaminating water (Pacheco-Torgal and Jalali, 2011, Liang and Ho, 2007). Kibert (1994) emphasised the elimination of toxins in the interior and exterior of built environments as key to SD. Causes of toxicity include; use of some chemicals in paints, insecticides for wood, and asbestos. Liang and Ho (2007) studied the toxicity of building materials during a fire and found, for example, that polyethylene foam and polyurethane foam are highly toxic. They recommended that these materials be avoided due to their high toxicity and combustible nature. Liang and Ho (2007) noted a lack of awareness amongst design team members as one of the problems associated with the use of toxic materials. They recommended the specification of non-toxic materials during planning, design and construction stages. Therefore, elimination of toxins is appropriate at the pre-construction, construction and post construction stages.

Life cycle costing (LCC): this principle is aimed at determining the overall cost associated with a project over time including acquisition, installation, operation, maintenance, refurbishment and disposal costs (Fuller, 2010, International Standard Organisation, 2006). According to Sterner (2000), LCC is executed at the design phase to allow changes and comparison of different options. At the design phase, several decisions including material selection, cost parameters of the scheme, and functional elements are determined. Ashworth and Hogg (2014) argued that LCC is most effective during pre-construction. They asserted that design changes may easily be incorporated at the conceptual and preliminary design stages while Clift (2003) and Fuller (2010) advocated early consideration of LCC to obtain maximum benefit. However, it is important that precise information, estimates, and decisions are made at the design stage because of its impacts on projects LCC (Flanagan and Jewell, 2008). LCC ensures cost efficiency of projects by reducing cost overruns, material waste, and risks.

Quality: this principle is **vital to the success of construction projects. It can be defined in terms of a building's** aesthetic, functional and stability characteristics. Its purpose is to meet the requirements set by clients, design teams, constructors, and regulatory bodies (Arditi and Gunaydin, 1997). It recognises excellence in design and construction being an important element of SC (Kibert, 1994). Ashokkumar (2014) noted that quality project outcomes can be achieved at the design and construction phases. However, quality must be ensured throughout a project including its visible and non-visible portions. Poor quality construction may result in additional costs, delay, structural failure, injury, loss of resources, and even death. These reduce sustainability but good quality construction improves durability, economic viability, and resource efficiency whilst reducing maintenance.

5. CONCLUSION

This study has reviewed literature on SC and construction phases. It revealed seven SC principles including reduce, reuse, recycle, protect nature, eliminate toxics, lifecycle costing and quality. It also categorised construction phases into pre-construction, actual construction and post construction. The study developed a framework of the relationships between SC principles and construction phases. Although there is limited understanding of this relationship by construction professionals, the framework could improve their understanding and the

implementation of SC principles. The paper also reveals the phase(s) where each principle could be applied for best effect. The relationship between SC principles and construction phases is mutually inclusive and critical in achieving SC. It is recommended that construction professionals first understand the context of sustainability, SC, SD and then familiarize themselves with the relationship between SC principles and construction phases. This will enhance their understanding and application of the principles in future construction projects.

REFERENCES

- [1] ABIDIN, N. Z. 2010. Investigating the awareness and application of sustainable construction concept by Malaysian developers. *Habitat International*, 34, 421-426.
- [2] ABIDIN, N. Z. & PASQUIRE, C. L. 2007. Revolutionize value management: A mode towards sustainability. *International Journal of Project Management*, 25, 275-282.
- [3] AHADZIE, D., PROVERBS, D. & OLOMOLAIYE, P. 2006. Development of research instrument for project managers performance measures in mass house building projects.
- [4] AL-YAMI, A. M. & PRICE, A. D. 2006. A framework for implementing sustainable construction in building briefing project.
- [5] ANKRAH, N. A. 2007. *An investigation into the impact of culture on construction project performance*. University of Wolverhampton.
- [6] ARDITI, D. & GUNAYDIN, H. M. 1997. Total quality management in the construction process. *International Journal of Project Management*, 15, 235-243.
- [7] ARIF, M., SYAL, M., FLOREZ, L., CASTRO, D. & IRIZARRY, J. 2013. Measuring sustainability perceptions of construction materials. *Construction Innovation*, 13, 217-234.
- [8] ASHOKKUMAR, D. 2014. Study of Quality Management in Construction Industry. *J. IJRSET*, 2319-8753.
- [9] ASHWORTH, A. & HOGG, K. 2014. *Added value in design and construction*, Routledge.
- [10] BIRAT, J.-P. 2015. Life-cycle assessment, resource efficiency and recycling. *Metallurgical Research & Technology*, 112, 206.
- [11] CASTELLANI, V., SALA, S. & MIRABELLA, N. 2015. Beyond the throwaway society: A life cycle-based assessment of the environmental benefit of reuse. *Integrated environmental assessment and management*, 11, 373-382.
- [12] CLIFT, R. 2003. Metrics for supply chain sustainability. *Clean Technologies and Environmental Policy*, 5, 240-247.
- [13] DAMEN, M. A. 2012. *A resources passport for a circular economy*. Masters, Utrecht University.
- [14] DERNBACH, J. C. 2003. Achieving sustainable development: The centrality and multiple facets of integrated decisionmaking. *Indiana Journal of Global Legal Studies*, 10, 247-285.
- [15] DICKIE, I. & HOWARD, N. 2000. *Assessing environmental impacts of construction: Industry consensus, BREEAM and UK Ecopoints*, Building Research Establishment Garston.
- [16] DU PLESSIS, C. 2002. Agenda 21 for sustainable construction in developing countries. *CSIR Report BOU E*, 204.
- [17] DU PLESSIS, C. 2007. A strategic framework for sustainable construction in developing countries. *Construction Management and Economics*, 25, 67-76.
- [18] DURAN, X., LENIHAN, H. & O'REGAN, B. 2006. A model for assessing the economic viability of construction and demolition waste recycling—the case of Ireland. *Resources, Conservation and Recycling*, 46, 302-320.
- [19] EMAS, R. 2015. The Concept of Sustainable Development: Definition and Defining Principles. *Florida International University*.
- [20] EUROPEAN COMMISSION, D.-G. F. E. 2001. *Promoting a European Framework for Corporate Social Responsibility: Green Paper*, Office for Official Publications of the European Communities.
- [21] EUROPEAN UNION, E. 2008. Directive 2008/98/EC of the European Parliament and the Council of 19 November 2008 on Waste and Repealing Certain Directives. *Official Journal of the European Union L*, 312, 22.11.
- [22] FADEYI, M., JALLOW, A., ANUMBA, C. & DULAIMI, M. 2012. Process Management Approach for Achieving Total Building Performance: Essential Requirements for Sustainable Construction.
- [23] FLANAGAN, R. & JEWELL, C. 2008. *Whole life appraisal: For construction*, John Wiley & Sons.
- [24] FULLER, S. 2010. Life-cycle cost analysis (LCCA). *National Institute of Building Sciences, An Authoritative Source of Innovative Solutions for the Built Environment*, 1090.

- [25] GHISELLINI, P., CIALANI, C. & ULGIATI, S. 2016. A review on circular economy: The expected transition to a balanced interplay of environmental and economic systems. *Journal of Cleaner Production*, 114, 11-32.
- [26] HILL, R. C. & BOWEN, P. A. 1997. Sustainable construction: principles and a framework for attainment. *Construction Management & Economics*, 15, 223-239.
- [27] HOFFMAN, A. J. & HENN, R. 2008. Overcoming the social and psychological barriers to green building. *Organization & Environment*, 21, 390-419.
- [28] HUOVILA, P. & KOSKELA, L. 1998. Contribution of the principles of lean construction to meet the challenges of sustainable development. 6th Annual Conference of the International Group for Lean Construction. Guarujá, São Paulo, Brazil, 13-15.
- [29] HUTCHINS, M. J. & SUTHERLAND, J. W. 2008. An exploration of measures of social sustainability and their application to supply chain decisions. *Journal of Cleaner Production*, 16, 1688-1698.
- [30] INTERNATIONAL STANDARD ORGANISATION, I. 2006. ISO 15686-5: 2006 Building and constructed assets - Service life planning: Part 5 -Whole-life costing. In: ISO (ed.) Draft ed. Geneva.
- [31] **IRURAH, D. 2001. Agenda for Sustainable Construction in Africa. An Invited Contribution to CIB's Agenda for Sustainable Construction in the Developing World and Agenda 21 on Sustainable Construction.**
- [32] KIBERT, C. J. 1994. Establishing principles and a model for sustainable construction. Proceedings of the First International Conference on Sustainable Construction, Tampa Florida, November, 6-9.
- [33] KIBERT, C. J. 2012. Sustainable construction: green building design and delivery. *Green Building Design and Delivery*. John Wiley and Sons.
- [34] LIANG, H.-H. & HO, M.-C. 2007. Toxicity characteristics of commercially manufactured insulation materials for building applications in Taiwan. *Construction and Building Materials*, 21, 1254-1261.
- [35] LIM, C. & MOHAMED, M. Z. 1999. Criteria of project success: an exploratory re-examination. *International journal of project management*, 17, 243-248.
- [36] LIU, J. Y.-S. 2012. Circular economy and environmental efficiency—the case of traditional Hakka Living system. *Procedia-Social and Behavioral Sciences*, 57, 255-260.
- [37] MATAR, M. M., GEORGY, M. E. & IBRAHIM, M. E. 2008. Sustainable construction management: introduction of the operational context space (OCS). *Construction Management and Economics*, 26, 261-275.
- [38] MORENO, M., BRAITHWAITE, N. & COOPER, T. 2014. Moving Beyond the Circular Economy. *Proceedings of Going Green-CARE Innovation*.
- [39] MURRAY, A., SKENE, K. & HAYNES, K. 2015. The circular economy: An interdisciplinary exploration of the concept and application in a global context. *Journal of Business Ethics*, 1-12.
- [40] **NEWPORT, D., CHESNES, T. & LINDNER, A. 2003. The “environmental sustainability” problem: ensuring that sustainability stands on three legs. International Journal of Sustainability in Higher Education**, 4, 357-363.
- [41] **OGUNMAKINDE, O., SHER, W. & MAUND, K. 2016a. Construction Professionals' Perception of Sustainability in Developing Countries. Australasian Universities Building Education Association. Pullman Cairns International hotel: Central Queensland University.**
- [42] **OGUNMAKINDE, O., SHER, W. & MAUND, K. 2016b. Obstacles to Sustainable Construction in Developing Countries. Australasian Universities Building Education Association. Pullman Cairns International hotel: Central Queensland University.**
- [43] ORTIZ, O., CASTELLS, F. & SONNEMANN, G. 2009. Sustainability in the construction industry: A review of recent developments based on LCA. *Construction and Building Materials*, 23, 28-39.
- [44] OSKAMP, S. 2002. Summarizing sustainability issues and research approaches. *Psychology of sustainable development*. Springer.
- [45] PACHECO-TORGAL, F. & JALALI, S. 2011. Nanotechnology: advantages and drawbacks in the field of construction and building materials. *Construction and Building Materials*, 25, 582-590.
- [46] PEARCE, D. 2005. Do we understand sustainable development? *Building Research & Information*, 33, 481-483.
- [47] PERSSON, U., RODRIGUES, M., HEILMAN, V., AUZIANE, G., BALOI, D. & LANDIN, A. 2008. Ten years of sustainable construction—perspective from a north construction manager and a south architect point of view. Proceedings of the World Sustainable Building Conference, Australia.

- [48] ROYAL INSTITUTE OF BRITISH ARCHITECTS, R. 2013. *Work Stages* [Online]. Available: https://www.liverpool.ac.uk/media/livacuk/facilities-management/policies-and-procedures/RIBA_workstages.pdf [Accessed 20 August 2016].
- [49] RYDIN, Y., AMJAD, U. & WHITAKER, M. 2007. Environmentally sustainable construction: knowledge and learning in London planning departments. *Planning Theory & Practice*, 8, 363-380.
- [50] SHEN, L., SONG, S., HAO, J. & TAM, V. W. 2008. Collaboration Among Project Participants Towards Sustainable Construction- A Hong Kong Study. *Open Construction and Building Technology Journal*, 2, 59-68.
- [51] SHI, L., XING, L., BI, J. & ZHANG, B. 2006. Circular Economy: A New Development Strategy for Sustainable Development in China. Proc. of Third World Congress of Environmental and Resource Economists, Japan.
- [52] STAHEL, W. R. 2013. Policy for material efficiency—sustainable taxation as a departure from the throwaway society. *Phil. Trans. R. Soc. A*, 371, 20110567.
- [53] STERNER, E. 2000. Life-cycle costing and its use in the Swedish building sector. *Building Research & Information*, 28, 387-393.
- [54] SU, B., HESHMATI, A., GENG, Y. & YU, X. 2013. A review of the circular economy in China: moving from rhetoric to implementation. *Journal of Cleaner Production*, 42, 215-227.
- [55] TAKIM, R., AKINTOYE, A. & KELLY, J. 2003. Performance measurement systems in construction. 19th Annual ARCOM Conference, 423-432.
- [56] TAM, V. W. 2008. On the effectiveness in implementing a waste-management-plan method in construction. *Waste Management*, 28, 1072-1080.
- [57] VAN DEN BERG, M. & BAKKER, C. 2015. A product design framework for a circular economy. Proceedings of the PLATE Conference, Nottingham, UK, 17-19 June 2015, Nottingham Trent University: CADBE.
- [58] WCED, U. 1987. Our common future. *World Commission on Environment and Development* Oxford University Press.
- [59] YONG, R. 2007. The circular economy in China. *Journal of material cycles and waste management*, 9, 121-129.
- [60] ZHIJUN, F. & NAILING, Y. 2007. Putting a circular economy into practice in China. *Sustainability Science*, 2, 95-101.

Session 5.6: Green Construction Technologies (2)

Innovative Building Technologies and Technical Equipment Towards Sustainable Construction: A Comparative LCA and LCC Assessment

Alexander PASSER^a, Gernot FISCHER^b, Richard DEUTSCH^c, Petra SÖLKNER^d, Sebastian SPAUN^e

^a Graz University of Technology, Austria, alexander.passer@tugraz.at

^b Graz University of Technology, Austria, gernot.fischer@tugraz.at

^c Graz University of Technology, Austria, richard.deutsch@tugraz.at

^d Austrian Cooperative Research, Austria, petra.soelkner@gmx.at

^e Austrian Cooperative Research, Austria, spaun@voezfi.at

ABSTRACT

Increasingly common building sustainability assessments include more and more the environmental, economic and socio-cultural performance in addition to the functional and technical ones. However, the influence of construction technologies and their technical building equipment as well as the way in which they vary depending on different energetic standards have not been described systematically in literature. For this reason, we evaluated the influence of these aspects and the impact on the environmental and economic performance of residential buildings.

The life cycle performance of 45 variants of a residential building was evaluated by applying the methodology of life cycle assessment (LCA) and life cycle costing (LCC) using quantitative assessment indicators proposed by the current European framework (EN 15643). The variants consist of four main construction types (brick, concrete, wood-chip concrete and prefab timber wood construction) in combination with different energetic standards (low to plus energy) and different technical building systems (pellets, heat pump, solar heating and photovoltaic). This led to a model that displays the existing technical variety in Europe.

The comprehensive results show a high optimization potential for the life cycle performance of buildings in general. However, the variation of the technical building equipment and energy standards lead to a higher improvement potential than the use of different construction techniques. Results also indicate that the use of a plus energy standard does not prove to be optimal in all cases.

Keywords: life-cycle assessment, embodied energy, building technologies

1. INTRODUCTION

The international energy agency (IEA) and the European Commission (EC) aim to achieve an 80% reduction of global emissions by 2050. In order to mitigate energy consumption in the building sector, several regulations and directives have been implemented on a European and country level. On a European level, specific measures to reduce energy demand have been introduced with the Energy Performance of Building Directive (EPBD) in 2002 and its recast in 2010. This EPBD, the Energy Efficiency Directive (EED) and the Renewable Energy Directive (RED) are designed as a package of measures that create the conditions for significant, long term improvements in the energy performance of buildings.

There is a clear trend of investing in the design of more energy-efficient buildings, and paying more attention to the embodied energy and related embodied impacts of such building concepts, taking the whole life cycle into consideration (e.g. the activities of IEX Annex 57). In the current literature on buildings LCA (e.g. [4], [5], [6]), a cross building related assessment of different energy standards and the influence of technical and/ or different construction materials can hardly be found [7], [8], [9]. The recently published European framework for the sustainability assessment provides a clear guideline on how to assess and report the environmental impacts in a transparent way. According to this framework, the building is to be assessed based on a functional and technical equivalent and the environmental assessment is to be based on the methods of Life Cycle Assessment (LCA).

There is also no systematic description of the construction technologies and technical building equipment influence on the variation of different energetic standards (e.g. low energy, nearly zero energy or plus energy). For this

reason, we evaluated the influence of these aspects and the impact on the environmental and economic performance in the case of a single-family house, which served as case study.

2. METHODOLOGY

The aim of the paper is to analyze the economic and environmental performance of the case study using Life Cycle Assessment (LCA) and Life Cycle Costing (LCC). These methods are used to quantify the difference in design options by using different construction materials, different energy systems and different energy standards. The whole variety of different combinations shows 45 scenarios, which were evaluated on their life cycle performance. The assessed scenarios consist of four main construction types (brick, concrete, wood-chip concrete and prefabricated timber wood construction) in combination with different energetic standards (low to plus energy) as well as different technical building systems (pellets, heat pump, solar heating and photovoltaic). The LCA and LCC analyses show which parts of the building are responsible for the main environmental and economic impacts.

2.1 Description of the case study

Different design options were created using a real single family house project [12], [13]. The case study is a two-storey building with a gross floor area of 220sqm (ground floor and first floor). This building design is the basis for all different scenarios. Within all the scenarios, the external dimensions and the cellar were kept the same- which is limited by the Austrian building code and therefore needs to stay the same. For these design targets, different construction materials and different insulation materials were used to model and calculate the energy demands according to Austrian standards. The energy demand of the different buildings has been calculated using certified energy performance software. For brick and wood chip concrete constructions, two scenarios, which do not need insulation materials to fulfil the low-energy standard, were additionally assessed. Table 1 shows the materials that were used to model the different building scenarios.

Construction material	Symb	Insulation type with symbol			
		EPS	Rock wool insulation	Wood-fibre insulation	Without additional insulation
Bricks	B	E			1
Concrete	C	E			
Mantle block (wood-concrete)	M	E		W	1
Wood solid	Ws		R		
Wood-frame construction	Wf		R		

Table 21: Construction materials and insulation materials with codes

As a first step, different energy standards were defined from a heating demand perspective based on ÖNORM H 5055, according to which the different design options should be a “low-energy” building with a heating demand of about 40 [kWh/m²a] (code L and S) and a “passive-house” building with a heating demand of about 10 [kWh/m²a] (code P and E - see Table 2). These various technical systems for the different energy standards are shown in Table 2.

Technical system	Low-energy standard			Passive-house standard		
	40 [kWh/m ² a] HWB _{ref}			10 [kWh/m ² a] HWB _{ref}		
	x-L-x-H	x-L-x-P	x-S-x-Si	x-P-x-H	x-P-x-P	x-E-x-H
Pellet boiler		Pellet boiler 10 kW	Single item (logs) 25 kW		Pellet boiler 10 kW	
Heat pump	Ground-water 10 kW _{th}			Compact unit Air-Air 1.8 kW		Compact unit Air-Air 1.8 kW

Solar thermal panels			Panel area 45 m ²			Panel area 10 m ²
PV panels						61 m ² PV panels, 6 kWp
Floor heating	yes	yes	yes		yes	
Additive system (backup)				Electric radiator 6 units		Electric radiator 6 units
Mechanical ventilation incl. heat-recovery				yes	yes	yes
Storage system (heating and hot water)	170 l Buffer storage	1000 l Heating storage 200 l WW-storage	7000 l Heating storage 300 l WW-storage	200 l Buffer storage	1000l Heating storage 200 l WW-storage	500 l WW-storage

Table 22: Technical systems

The heat pump, pellet boiler, solar thermal panels, single item wood furnace and photovoltaic (PV) in the scenarios were evaluated for the different energy standards (see Table 2). **Additionally, a “sun-house” concept was analyzed.** In this concept, solar thermal collectors provide at least 50 % of the heating energy needed.

The different construction and insulation materials were then combined with the technical systems in a scenarios matrix to a total scenario set of 45 variants. For the presentation of the results, codes for the different scenarios are used to identify the different measures. The first digit represents the construction material (code B, C, M, Ws, Wf; see Table 1), the second the energy standard (code L, S, P, E; see Table 2), the third the insulation type (code E, R, W, 1; see Table 1); and the fourth the technical system (code H, P, Si; see Table 2).

2.2 Environmental performance

The environmental performance calculations of the different scenarios are based on EN 15978 and ISO 14040. The scenarios have been assessed by the use of LCA for the whole life cycle, pictured in Table 3. The materials for the different construction techniques were quantified and modelled for modules A1 – A3. For the reference study period (RSP) of 100 years, the different replacement scenarios (module B4) were assessed based on an expert survey. Furthermore, the end of life stage (C3 – C4) was modelled on the basis of the expert survey (disposal, incineration, recycling, etc.) for the various materials.

The results from the energy simulation were used to quantify the operational impacts (B6) of the related energy use. For the life cycle impact assessment (LCIA), the ecoinvent database v2.2 and EPD (2013) model were used.

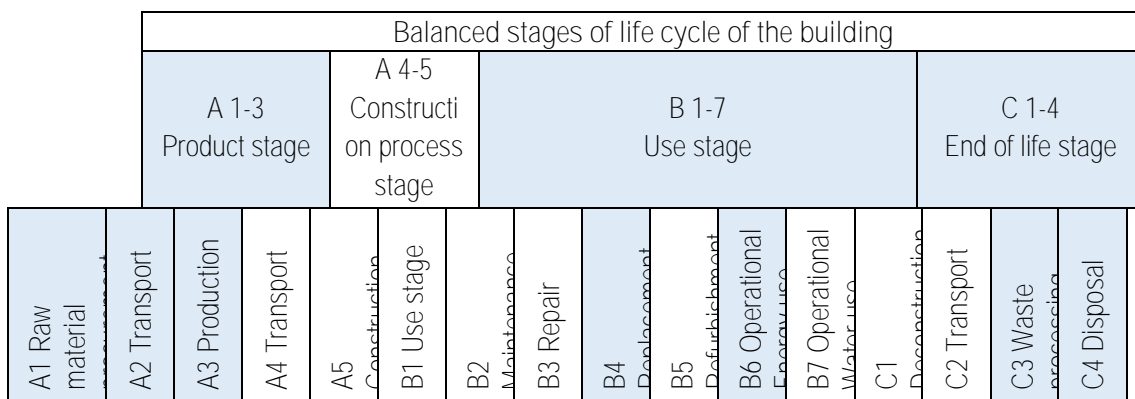

Table 23: Life cycle stages

2.3 Economic performance

The economic performance is based on a detailed calculation of the initial construction costs according to ÖNORM B 1801-1 and 1801-2 [17], [18] for the same life cycle stages as pictured in Table 3, system boundaries, as used for the calculation of the environmental performance, but with a RSP of 50 years. Table 6 provides an overview of the relevant calculation parameters based on the Austrian sustainable building council (ÖGNI), which refers to the German DGNB/ BNB.

Electricity price	0,17 €/kWh
Pellets price	0,25 €/kg
Wood price	0,16 €/kg
Discount rate	5,5 %
Inflation rate	2,0 %
Escalation rate	4,0 %

Table 24: Calculation parameters for LCC

3 RESULTS AND DISCUSSION

3.1 Environmental performance

The environmental performance results are shown in Figure 2. Due to space constraints, only the GWP results are presented. Results for the non-renewable portion of Cumulative Energy Demand can be found in [20]. The different life cycle stages (A1-A3, B4, B6 and C3-4) are highlighted in different colors, to illustrate the difference between the phases. Negative environmental impacts are only pictured for the scenarios in plus-energy standard (Code x-E-x) due to the energy production onsite. The results also show the significant difference between the embodied and operational impacts in the different scenarios.

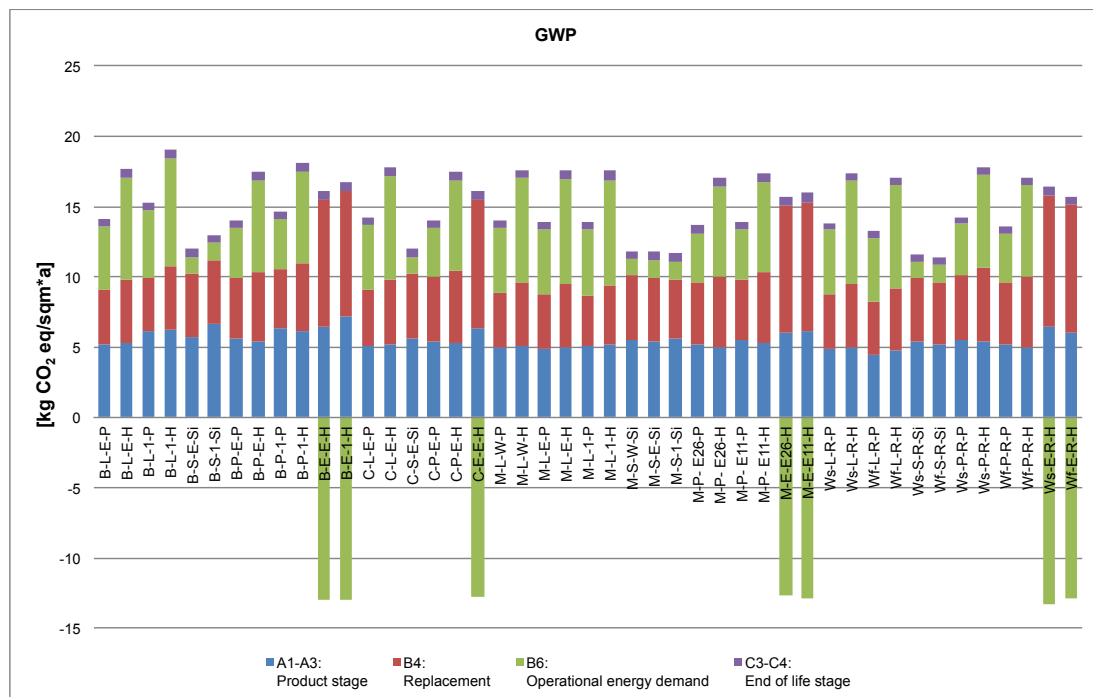

Figure 1: Global warming potential (kg CO2eq/m2a)

3.2 Technical system

The environmental performance results are quite spread out among the different energy systems (Figure 2). For these systems, the operational energy use (B6) dominates the environmental impacts and differs according to the chosen energy carrier. However, the assessed indicators do not suggest a clear preference for a single technical system, as some environmental indicators run counter. Particularly for the heat pump systems, ODP intensity is caused by the cooling refrigerants.

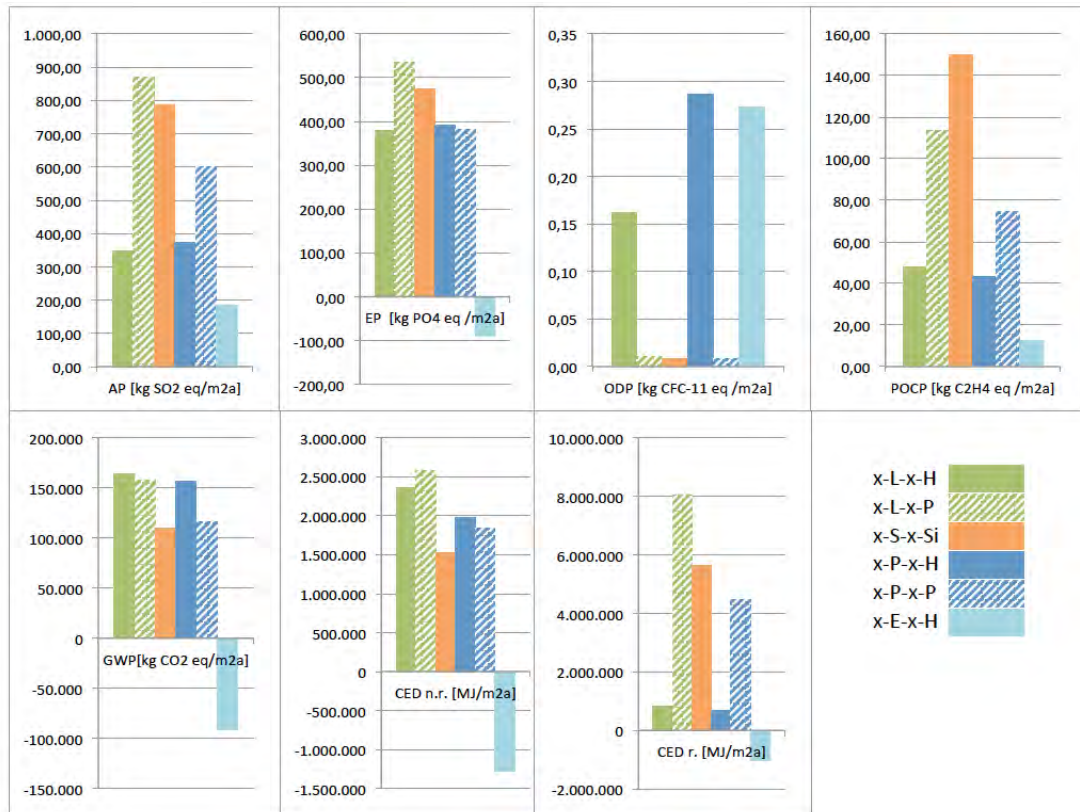

Figure 2: Results for the technical system over the whole life cycle

3.3 Economic performance

The economic performance results based on the LCC calculations are presented in Figure 3, which shows the total net present value per sqm. gross floor area.

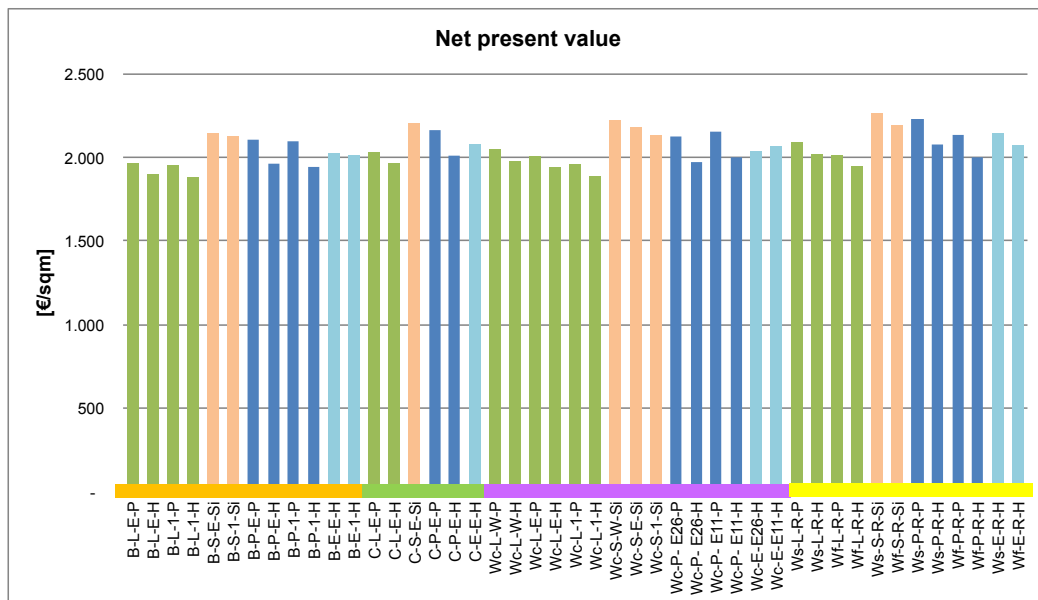

Figure 3: Net present value

Life cycle costs of the different construction techniques and technical systems are rather similar. However, the results also indicate that construction costs are very dominant when calculated based on a high discount rate (i.e. 5.5%) combined with low energy costs. Thus, according to these results, the additional investment and related replacement costs for better energy standards and energy performance hardly pays off over a life time of 50 years.

4 CONCLUSION

The comprehensive results show a high optimization potential for the life cycle performance of buildings in general. The findings indicate that the choice of different construction technologies and building materials does not lead to as high an improvement potential as the variation of the technical building equipment and the energy standard. However, in every case the results show an increasing importance of material related embodied impacts. Due to the current trend towards more and more energy efficient buildings, the role of materials within environmental assessments will increase dramatically and should therefore be researched more precisely.

In the plus energy buildings case, authors recommend evaluating the aspect of primary energy factors and LCA allocation rules for delivered and exported energy in detail, as the environmental performance results can change with different scenarios.

Regarding the sensitivity analysis of the environmental and economic performance results, authors do not agree with the functional unit defined as gross floor area, which is standardized for economic calculations. Results differ with highly insulated buildings due to the increase in wall thickness, so a more adequate functional unit is currently under assessment.

ACKNOWLEDGMENTS

The authors would like to thank the scientific committee of SBE16 Hamburg for awarding the contribution with an Outstanding paper award, which served as a basis for this contribution. Due to the page limit, we were only able to present a small excerpt of the work, which is based on the research project “Ökovergleiche”. **Last but not least**, the authors would like to thank all partners for their efforts.

REFERENCES

- [1] Charlier, Dorothée ; Risch, Anna: Evaluation of the impact of environmental public policy measures on energy consumption and greenhouse gas emissions in the French residential sector. In: Energy Policy Bd. 46 (2012), S. 170–184
- [2] EC: Directive 2010/31/EU of the European Parliament and of the Council of 19 May 2010 on the energy performance of buildings, 2010
- [3] D’Agostino, Delia: Assessment of the progress towards the establishment of definitions of Nearly Zero Energy Buildings (nZEBs) in European Member States. In: Journal of Building Engineering Bd. 1 (2015), S. 20–32
- [4] Cabeza, Luisa F. ; Rincón, Lúcia ; Vilariño, Virginia ; Pérez, Gabriel ; Castell, Albert: Life cycle assessment (LCA) and life cycle energy analysis (LCEA) of buildings and the building sector: A review. In: Renewable and Sustainable Energy Reviews Bd. 29, Elsevier (2014), S. 394–416
- [5] Hernandez, Patxi ; Kenny, Paul: From net energy to zero energy buildings: Defining life cycle zero energy buildings (LC-ZEB). In: Energy and Buildings Bd. 42 (2010), Nr. 6, S. 815–821
- [6] Lasvaux, S. ; Schiopu, N. ; Habert, G. ; Chevalier, J. ; Peuportier, B.: Influence of simplification of life cycle inventories on the accuracy of impact assessment: application to construction products. In: Journal of Cleaner Production Bd. 79 (2014), S. 142–151
- [7] Dahlstrøm, Oddbjørn ; Sørnes, Kari ; Eriksen, Silje Tveit ; Hertwich, Edgar G.: Life cycle assessment of a single-family residence built to either conventional- or passive house standard. In: Energy and Buildings Bd. 54 (2012), S. 470–479
- [8] Lewandowska, Anna ; Noskowiak, Andrzej ; Pajchrowski, Grzegorz: Comparative life cycle assessment of passive and traditional residential buildings’ use with a special focus on energy-related aspects. In: Energy and Buildings Bd. 67, Elsevier B.V. (2013), S. 635–646
- [9] Passer, Alexander ; Kreiner, Helmuth ; Maydl, Peter: Assessment of the environmental performance of buildings : A critical evaluation of the influence of technical building equipment on residential buildings (2012), S. 1116–1130
- [10] CEN: ÖNORM EN 15643-1 Sustainability of construction works - Assessment of buildings, Part 1: General Framework, ASI (2010)
- [11] ASI: ÖNORM EN ISO 14040: Environmental management - Life cycle assessment - Principles and framework (2006)

- [12] Mötzl, Hildegund: Ökovergleich von Gebäuden – Teilprojekt: Ökobilanzierung der Haustechniksysteme, 2014
- [13] Sölkner, P. ; Oberhuber, A. ; Spaun, S. ; Preininger, R. ; Dolezal, F. ; Passer, A. ; Fischer, G.: Innovative Gebäudekonzepte im ökologischen und ökonomischen Vergleich über den Lebenszyklus, 2014
- [14] ASI: Energy performance of buildings - Documents relating to the energy certificate - Findings, expertise, advice and recommendations, 2011
- [15] CEN: ÖNORM EN 15978:2012-10-01-Nachhaltigkeit von Bauwerken - Bewertung der umweltbezogenen Qualität von Gebäuden - Berechnungsmethode, 2012
- [16] Hischer, Roland ; Weidema, Bo ; Althaus, Hans-Jörg ; Bauer, Christian ; Doka, Gabor ; Dones, Roberto ; Frischknecht, Rolf ; Hellweg, Stefanie ; Humbert, Sébastien ; u. a.: Implementation of Life Cycle Impact Assessment Methods Data v2.2 (2010), 2010
- [17] ASI: ÖNORM B 1801-1:2009 06 01- Bauprojekt- und Objektmanagement - Teil 1: Objekterrichtung, 2009
- [18] ASI: ÖNORM B 1801-2: 2011 04 01 - Bauprojekt- und Objektmanagement - Teil 2: Objekt-Folgekosten, 2011
- [19] Passer, Alexander ; Kreiner, Helmuth ; Smutny, Roman ; Kaufmann, Philipp: Adaptation of DGNB-Methodology to Austria - Lessons Learned from the first Certificates. In: World Sustainable Building Conference - Helsinki 2011 : Finnish Association of Civil Engineers RIL, Proceedings, Vol. 1, 2011
- [20] PASSER, ALEXANDER; FISCHER, GENOUT; SÖLKNER, PETRA; SPAUN, SEBASTIAN, 2016. Innovative building technologies and technical equipment towards sustainable construction – a comparative LCA and LCC assessment, paper presented at the International Conference on Sustainable Built Environment, SBE16 Hamburg, Hamburg, 7-11 March.

A Peer-To-Peer Reviewing Framework for Selecting Construction Material Suppliers Using the Integration of Building Information Modelling and Web-Map Service

CHEN Po-han^a, NGUYEN Thanh-chuong^b

^a National Taiwan University, Taiwan, pohanchen@ntu.edu.tw

^b National Taiwan University, Taiwan, d00521034@ntu.edu.tw

ABSTRACT

Selecting construction material suppliers is an important task in a construction project. The location of material is crucial to the supplier selection process because the transportation distance from the material extraction or manufacturing place to the project site significantly affect both transportation cost and material delivery time. **Therefore, an accurate estimation of material's transportation distance is important. To support the supplier selection process, this paper presents a peer-to-peer reviewing framework for selecting construction material suppliers using the integration model of Building Information Modelling (BIM) and Web-Map Services (WMS).** Using Autodesk Revit API and Google Maps API as the development tools, this research converts the integration model and the framework into a BIM-integrated plugin in Autodesk Revit. The plugins can help automate calculations, and provide a detailed plan of material cost and transportation. From that, the project manager can select a material supplier with the best price and reduce the risk of transportation delay.

Keywords: construction materials, suppliers selection, BIM, Web-Map Service

1. INTRODUCTION

1.1 The linear process of selecting construction materials and material suppliers

Traditionally, a construction material is often selected in the design stage by the designer. In later phases, the material is approved by the project manager or owner. The material supplier is selected in the bidding stage. A material supply plan is then provided by the chosen supplier. The process of material and supplier selection is linear, which can be illustrated in the following figure.

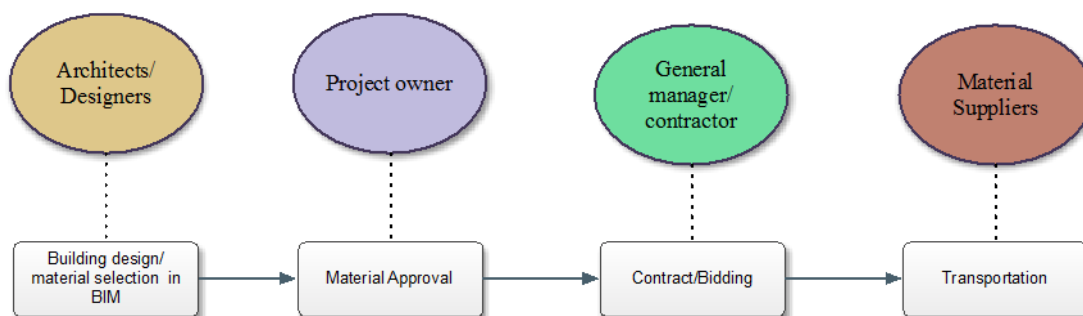

Figure 1: Traditional material and supplier selection process

There are some problems in this linear process. First, in the design stage, the designer and project owner choose the construction materials with less information of the materials availability, cost, and transportation plan when the suppliers are not selected. It means that if a material is not available, or its cost is higher than expected, the material **selection process has to be restarted**. **Second, if the material transportation plan from the supplier doesn't match with one from the project manager, there is a possibility of project delays or conflicts.**

1.2 The importance of material location to project's cost and schedule

Construction materials contribute for a significant part of project cost: it is estimated that the cost of materials procurement can account for 60 - 65% percent total cost of a construction project. Therefore, the selection of material suppliers is important to the success of a project. Poor planning in material production and supply operations could result in problems in the project cost, schedule, and quality management.

There are many factors that affect the decision of selecting a material supplier. Some of the most important factors are the material cost and the plan of material supply chain. Ahmadian stated that transportation cost is considered as the dominant decision variable in the transportation planning of construction material. It is stated that transportation cost accounts for 10 - **20% total budget of a project. Material's location is the key factor to calculate** transportation cost. The longer the distance from material to project site is, the higher cost, time and human works have to be spent for transporting the material. Therefore, material location is important in the decision of selecting the supplier.

Material location also affects the planning of material supply. Delay in construction material transportation, especially those in critical or near-critical activities can have significant impacts on the completion of a project. The longer transportation is, the longer time is spent on the transportation. However, the delivery time not only depends on the travel distance, it also depends on other factors such as transportation modes (vehicle availability and capacity, travel speed etc.). When the volume of material is tremendous, the management of material delivery schedule becomes more complicated and uncertain.

Construction material's location also affects the environmental impacts of the building. Construction transportation activities generate a large amount of or CO₂ emission. Those activities can have negative health and environmental consequences, generating water, air and noise pollutions. The use of regional materials, which are closed to project site, can reduce transportation activities and the associated pollution. It can also reduce vehicles activities, which put less stress on infrastructure development, and contribute to healthier local economy, as well as showcases the uses of the resources and specialties of the local region.

The importance of material location is reflected in some green building standards, such as in credit MRc5 of the LEED (Leadership in Energy and Environmental Design) standard by the U.S. Green Buildings council.

In conclusion, material transportation distance plays an important role in material cost and supply plan. Therefore, an accurate estimation of calculating the transportation distance is critical to the selection of material supplier.

1.3 Problems in calculating material transportation distance

Distance from project site to material location is the key to calculate transportation cost and time. However, there has been no effective method for this calculation. The traditional method is by personal experiences or calculating in paper maps, which takes time and very accurate. Another method by Wu to estimate the distance between material extraction place and project site by using Zip code. This method has low accuracy, because Zip code is used to present a region, not a particular place.

Another method of measuring the travel distance is by calculating the direct straight-line distance between two places, such as in the study of Irizarry (2013). The distance between point A and point B is calculated by the following formula:

$$\sigma_{AB} = \sqrt{(x_A - x_B)^2 + (y_A - y_B)^2}$$

However, this method of distance calculation has low level of accuracy. In the real situation the route between the suppliers and project sites are usually not straight. Therefore, the straight distance from supplier to project site are usually shorter than the real travel distance of transportation.

Therefore, to determining the travel route is crucial in material procurement planning. In other words, it is one important variable of the material supplier selection process. Finding a different approach in specifying transport distance is essential.

1.4 Web-Map services

Web-Map Services (WMS) are the process of requesting map images from a map server with GIS databases through the web interface. Compared to traditional maps, WMS has many advantages: free and interactive (i.e., being able to zoom, pan, turn on/off layers, etc.) with easy access through a web browser. Using maps delivered by GIS system, WMS such as Google Maps can provide a route planner under "get directions". By analysing the geographic conditions and transportation mode, WMS can help specify the best available travel route for driving, **public transit or walking....**

2. LITERATURE REVIEW

Supplier selection is an interested topic to researchers and scholars. Safa et al. developed an integrated construction materials management (ICMM) model to support the supplier selection process. Ahmadian et al. identified several main factors that affect the transportation of material including: travelling distance, weight, dimension, mode of transportation, and terms of delivery. Among those factors, travelling distance and mode of transportation are two factors from the material suppliers that needed to be considered. Inadequate transportation capacity is also a cause of delay in material delivery.

3. RESEARCH OBJECTIVES

The study aims to develop a peer-to-peer reviewing framework for selecting construction material suppliers using the integration of Building Information Modelling and Web-map Service. The framework is based on the concept of Integrated Project Delivery. The reviewing framework using the plugins can help project owner and manager to choose the best supplier based on the following criteria:

- Total material cost (including based cost, transportation cost etc)
- Transportation plans
- **Green Building compliance (LEED's regional material credit MRc5.2) of the material.**

With the plugins, a detail and transparent plan of material cost and transportation is provided. From that, it can reduce the risk of redo and uncertainty in the material and supplier selection process.

4. METHODOLOGY

A framework of peer-to-peer reviewing framework for selecting construction material suppliers using the integration of BIM and WMS is developed. In the study, Microsoft C# programming language is used to develop the integration model of BIM-WMS as a Revit plugin to support the reviewing framework.

The research use Revit API (Application Programming Interface) to develop the model as a BIM plugin. For WMS services, Google API is selected as a development tool.

4.1 Integrated Material Selection (IMS) approach to support peer-to-peer reviewing framework

The BIM-WMS **integrated tool is used in the design stage, it can help enable the process called "Integrated Material Selection" (IMP). Integrated Material Selection is based on the principle of Integrated Project Delivery (IPD).** It requires the participations of designers, project owners, project managers, contractors, material suppliers and other stake holders from early stages of the project. The concept of integrated material selection using BIM-WMS model is illustrated in the following figure:

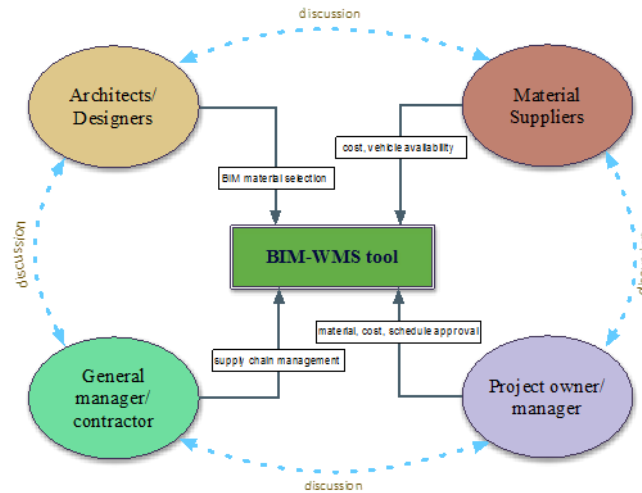

Figure 2: Integrated material selection approach using BIM-WMS tool

In contrast with the linear process of traditional material and supplier selection, in this study, all parties can use BIM-WMS tool to calculate the selection of material is done in early design stage.

4.2 BIM-WMS integration UI

Using Revit API and Google Maps API, the Autodesk Revit plugin of BIM-WMS integration is developed to support the framework.

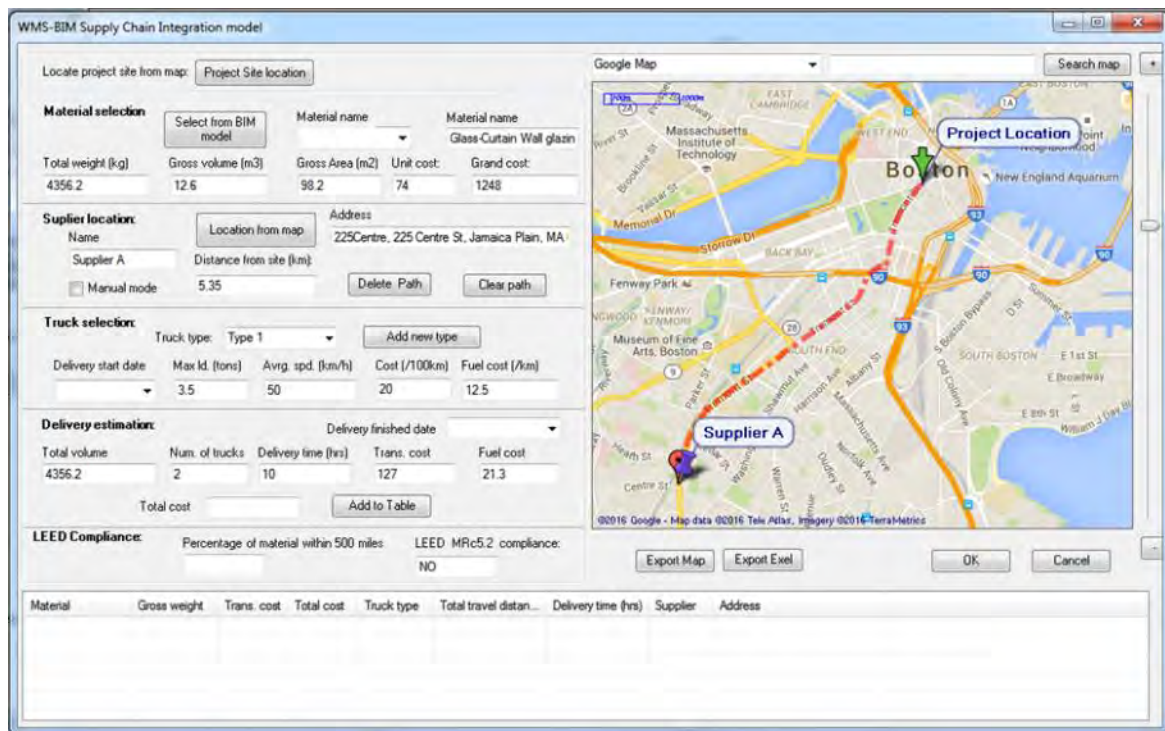

Figure 3: The Revit plugins user interface

By using Revit API to access BIM's material information and using Google Maps API to calculate travel distance from site to supplier's location, the plugins can help:

- Calculate material schedule (weight, volume etc.)
- Calculate material total cost (including based cost, transportation cost, fuel cost)
- Estimate transportation plan (delivery time, vehicle requirements etc...)

4.3 The peer-to-peer reviewing framework

The peer-to-peer reviewing framework can be illustrated in the following figure:

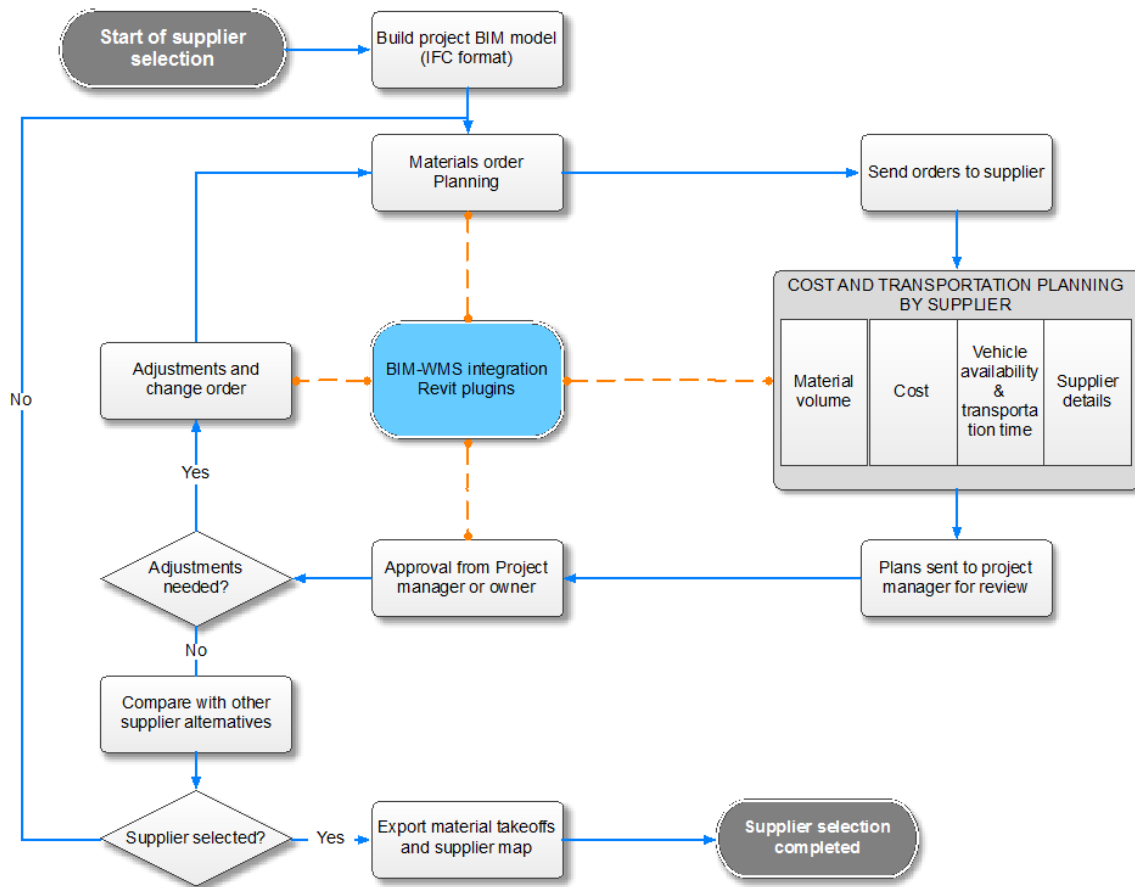

Figure 4: Framework of peer-to-peer reviewing for supplier selection process using the integration of BIM-WMS

From design stage, all stake holders can use the BIM-WMS plugin as a tool to estimate material cost and transportation plan:

- Architects build the BIM models with BIM tools and with considerations of aspects such as aesthetics, compatibility with other components etc.
- Project owners/managers use BIM-WMS tool to compare different options of materials, and approve on material type, cost and schedule.
- Various material suppliers provide different options of materials, with information about the location, availability, based cost, transportation of materials. This information can be used in BIM-WMS tool to help project designers, managers and contractors to select the most reasonable material for their project.
- General managers/ contractors can check information provided in BIM-WMS tool to verify about cost and supply chain management plan.

5. CONCLUSION

Selecting material suppliers are critical to the success of a construction project. The peer-to-peer reviewing framework can help reduce the risk of redo, cost overrun and delay in the construction project.

Because selecting material supplier is a complicated process which involves many factors, the proposed framework and system only address some of the most critical problems, such as the estimation of material transportation cost and time, and the integrated collaboration in the material selection process. In the supplier selection process, the proposed system should be used in combination with other techniques and methods to get the best results.

REFERENCES

- [1] A. Akbarnezhada, T. H. Rashidi, and S. T. Wallera, "Importance of Planning for the Transport Stage in Procurement of Construction Materials," 2014.
- [2] F. F. A. Ahmadian, A. Akbarnezhad, T. H. Rashidi, and S. T. Waller, "Accounting for Transport Times in Planning Off-Site Shipment of Construction Materials," *J. Constr. Eng. Manag.*, vol. 142, no. 1, p. 4015050, 2016.
- [3] H. P. Tserng, S. Y. L. Yin, and S. Li, "Developing a Resource Supply Chain Planning System for Construction Projects," *J. Constr. Eng. Manag.*, vol. 132, no. 4, pp. 393–407, 2006.
- [4] H. S. Scholman, *Subcontracting by main contractors*. Amsterdam, Netherlands: Economic Institute for the Building Industry, 1997.
- [5] M. Safa, A. Shahi, C. T. Haas, and K. W. Hipel, "Supplier selection process in an integrated construction materials management model," *Autom. Constr.*, vol. 48, pp. 64–73, Dec. 2014.
- [6] W. Wu, "Integrating Building Information Modeling and Green Building Certification: Bim-Leed application Model Development," University of Florida, Florida, 2010.

Improving the Supply Chain of Housing Industrialization from Transaction Costs Perspective: A Literature Review

WU Hongjuan^a, Queen K QIAN^b, Henk VISSCHER^c, Ad STRAUB^d

^a OTB Research Institute for the Built Environment, Delft University of Technology, The Netherlands, h.wu-2@tudelft.nl, whj1110working@163.com

^b OTB Research Institute for the Built Environment, Delft University of Technology, The Netherlands, k.qian@tudelft.nl

^c OTB Research Institute for the Built Environment, Delft University of Technology, The Netherlands, h.j.visscher@tudelft.nl

^d OTB Research Institute for the Built Environment, Delft University of Technology, The Netherlands, a.straub@tudelft.nl

ABSTRACT

Sustainable development has been the focus of all major industries in the world, especially in the construction industry. As one of the sustainable construction modes, housing industrialization (HI) is now absorbing a growing number of attentions that lead the industry to go green. However, the implementation of HI in China is far from satisfactory due to its low economic efficiency. This paper attempts to improve the HI supply chain from a new perspective-transaction costs (TCs). First, it provides an objective understanding of status quo of HI in particular in China. Then, the study outlines the basis of TCs theories and supply chain management theory, compiling literature review of the application of TCs and supply chain management in other fields to states the feasibility of their application in HI area. A theoretical framework is developed to explain the relationships and overlaps among these three areas. Analysis of the state of research in application of TCs in HI supply chain management is expected to help optimized the governance structure of HI supply chain.

Keywords: housing industrialization (HI), supply chain management, transaction costs (TCs)

1. INTRODUCTION

Nowadays, the sustainable development has been the theme of the world. Building is a resource and labour intensive industry, where takes up 24% of raw materials consumption, and accounting for around 40% of primary energy consumption worldwide (Dong and Ng, 2015, IEA, 2014). It is vital for these aspects to be reformed in order to save energy and resources. There has been much work done in the past to look for optimal solutions to remedy these issues. One of such propositions is to apply industrialization in housing construction. Housing industrialization (HI) is a concept originated from manufacturing industry. As Egan (1998) highlighted, the construction sector necessitates a manufacturing process to be developed within its production which can lead to high performance. With the inspiration of the Egan report, the profile of HI has been increased and its implementation has been significantly expanded both in academia and industry. Many terminologies are associated with HI in the global construction industry. It is often referred to as: 'prefabrication', 'preassembly', 'modularization', and 'offsite fabrication' in the US (Song et al., 2005, Egan, 1998); 'off-site production' in the UK (Pan et al., 2012); 'off-site manufacturing' in Australia (Blismas and Wakefield, 2009); 'prefabrication' in Hong Kong (Jaillon, 2009) and Singapore (Park et al., 2011) and 'industrialized building' in Malaysia (Kamar et al., 2009). In this paper, HI is specifically defined as a business strategy that transforms the traditional construction process into a manufacturing and assembly process in order to reduce cost, time, and improve the quality of the product/ service. This is achieved by engaging people, embracing new technologies, and translating clients' needs into building requirements through new contractual working relationships across the whole supply chain (Nadim and Goulding, 2011).

Over last several decades, HI has been developed as one of the innovative approaches to overcome the traditional site-based construction drawbacks and being widely applied around the world. Today, Japan is the world's largest practitioner of industrialized construction with some companies producing over 70,000 manufactured homes a year (Arif et al., 2012). European countries, such as the UK, Ireland and Scotland, are experiencing a significant boom in industrialized houses. For instance, over 30% of the new homes built today in the UK are prefabricated; in Ireland and Scotland, industrialization rate is projected to rise to nearly 70% in a few years (Blismas and Wakefield, 2009). Leveraging lean management strategies, several Swedish construction companies start to transform their conventional site-based construction workflow into a lean-embedded off-site production and on-site assembly

workflow. Through these measures, the workforce, project design and delivery are envisioned to be benefited from continuous effectiveness and efficiency improvement of HI (Jansson, 2010).

With sustainable development becoming a profound global challenge, exploration has also been made in China to **seek for sustainable development goals**. The China' National Development and Reform Commission (NDRC), in **collaboration with the China's Ministry of Housing and Urban-Rural Development (MHURD)** published its Green Building Action Program (2013) with implementation of HI being one of the prominent themes (MOHURD, 2013). This program aims to reform the industrial practices through promoting the application of HI in major cities in China. Driven by the market and policy, HI is increasingly emphasized in China. Nevertheless, it was noted that China had not gained enough momentum to push HI forward due to an incomplete supply chain causing loads of environmental and social problems. HI develops rapid in recent years in China, few research has tried to improve the economic performance from a holistic view. To achieve high benefits and high efficiency within an innovative industry, it is essential that economic aspects are addressed throughout the whole supply chain (Blair et al., 2005). The theory of supply chain management, which takes a systemic view of the production activities of autonomous production units (subcontractors, suppliers in construction, etc.), can help seek for a holistic solution to improve HI (Mao et al., 2013).

Economic efficiency and supply chain management have, in recent years, become two of the most important performance-related issues within the construction industry. This study is an attempt to develop a combined framework, aiming to understand the current state of HI implementation and improve the economic performance of HI supply chain from a Transaction costs (TCs) perspective.

2. LITERATURE REVIEW

2.1 Transaction costs application in HI

The concept of TCs has a broad range of definitions and empirical evidences (Demsetz, 1968, Barzel, 1985, Allen, 1991, North, 1990). TCs refer generally to costs of trade beyond the materials cost of the product, such as the costs of searching for projects, estimating, project partners, negotiation, monitoring, regulatory approval and dealing with any deviations from contract conditions (Antinori and Sathaye, 2007, Li et al., 2015). In other words, TCs are costs beyond the direct costs (market price times volume) but incurred in making a trade (Antinori and Sathaye, 2007). In the theory of TCs, there are three key constructs that reflect the fundamental representation of it: assets specificity, uncertainty, and governance mechanism (Grover and Malhotra, 2003). In this study, we specifically refer to TCs in terms of risk, time delay, uncertainty, and information searching, setting up costs as well as learning costs. Compared with conventional construction, new procurement processes and extra tasks involved in HI require the support of new rules and institutions, and in turn, cause TCs, which are often invisible.

TCs has been around for nearly seven decades, and it has seen a wide application in various disciplines (Mundaca and Neij, 2006, Grover and Malhotra, 2003). Since HI is essentially a kind of innovative construction mode that combing the process of conventional construction into manufacturing, this study will first summary the TCs-relevant researches in manufacture and construction industry to learn experience (see Table 1).

Research fields	Key findings	Reference
Manufacture industry	Asset specificity is related to lower in-firm transaction costs.	Walker and Poppo (1991)
	Supplier-specific investments are negatively related to perceived buyer dependence.	Sriram et al. (1992)
	Transaction costs are positively related to collaboration propensity.	
	Outsourcing alter the configuration and boundary of an organization and change the economic contribution that an organization makes to the economy.	McCarthy and Anagnostou (2004)
	Vertical integration by unconnected firms correlates with better economy performance.	Signorini et al. (2015)
Construction industry	Factors that affect TCs in construction projects are identified.	Qian (2012) Li et al. (2015)
	TCs to the public sector and the winning bidder vary between countries and sectors, and they are significantly higher in small projects.	Dudkin and Vallila (2005)
	Identifying factors that affect partnership performance using a TC framework.	Jobin (2008)
	Transaction costs in transport PPPs depend on the procurement mechanism used in each case.	Soliño and Gago de Santos (2010)

Table 1: Key studies applying TCs theory in manufacture and construction industry

From the perspective of TCs economics, well-designed institutional structures may lower TCs and provide net social benefits (Levine et al., 1995). Williamson (1985) believed that when the economic organizations have selected the appropriate governance structures, the transaction cost will low down; otherwise they need to pay for higher transaction fee, or even lead to transaction failure. The basic concepts of TCs theory applied to the manufacture industry broadly (Table 1) shows a high correlation with vertical integration in the organization, which is the core concept of supply chain management. Besides, some scholars believe that considerable opportunities within the manufacture industry for evaluating supply chain management issues from the TCs perspective (Grover and Malhotra, 2003). Therefore, TCs can also be applied as a new perspective to unearth the hidden rules in the HI industry to update its supply chain.

2.2 Supply chain management in the HI industry

Supply chain management has been introduced during the 1990s, which provides a clear statement that it is a question of a whole chain of organizations (Fredrik Olsson, 2000). According to Cooper et al. (1997), this study defines the supply chain management of HI crossing organizational borders as: Supply chain management of HI is the integration of business processes from original suppliers through end users that provides products, services and information that add value for housing customers.

The theory of supply chain management has been extensively researched and applied in the manufacturing industry. However, the application of it is comparatively new in construction field. Since 1990s, there has been an emerging number of people who have been interested in applying supply chain management theory in project organization. They characterized the deficiencies of it and proposed solutions in order to improve the coordination of the often many subcontractors and suppliers in the construction chain (Segerstedt and Olofsson, 2010). The benefits of supply chain in construction and barriers in its implementation, has been very well documented (Ahmed et al., 2002, Tiwari et al., 2014). It has been found that construction industrial chain management offers new approaches to reduce the costs and increase the reliability and the speed of facility construction.

It has been brought out that although supply chain management for an individual organization is an emerging field of research in the construction management discipline, less attention has been devoted to investigate the nature of the HI supply chains and their organizational economic performance (London and Kenley, 2001).

According to the concept of supply chain defined by Christopher (1999), this paper specifically defines HI supply chain as a set of organizations producing activities. It associated with the flow and transformation of HI from raw materials stage, through upstream and downstream linkages, producing value in the form of products and services in the hands of residents. Here we built a normalized supply chain of HI (Figure 1), which looks across the entire supply chain, rather than just at the next entity or level. It consists of numerous stakeholders, and there are some basic components of HI supply chain: (1) Nodes: they are all stakeholders in the HI industry, such as developer, contractor, supplier and government department. (2) Chain: each chain links several stakeholders and represents transaction behaviour among them. The chain in this study contains three kinds of flow: materials, information and capital. During operation process, this supply chain works in a loop state. The materials recycle plant plays as an important role to make this chain restart, which significantly improve the sustainability of HI.

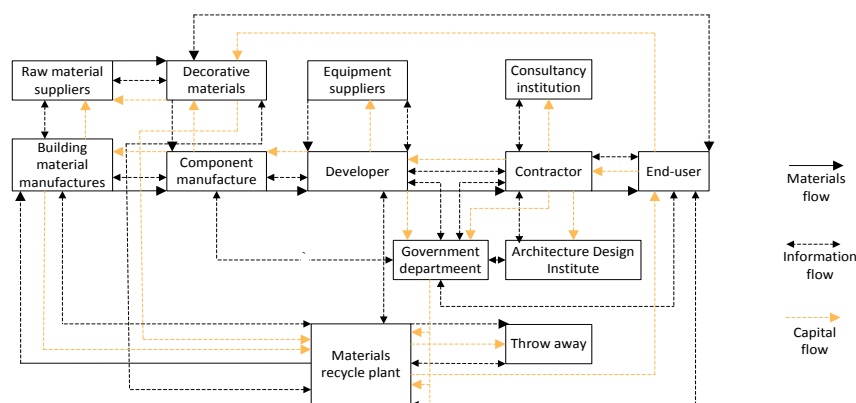

Figure 1: The normalised supply chain of HI (by the authors)

2.3 The framework to improve the HI supply chain using TCs

Under the theme of this programme, there are three major theories connected as the research basis, housing industrialization, transaction costs and supply chain management. The research question of this program is in the intersection among the three fields. Although this is quite a vacant field that is worth working on, studies on the supply chain of HI project from TCs perspective is still very limited. To fill this gap, we can first build the theoretical framework (Figure 2) using the overlap area between each two theories as the starting point.

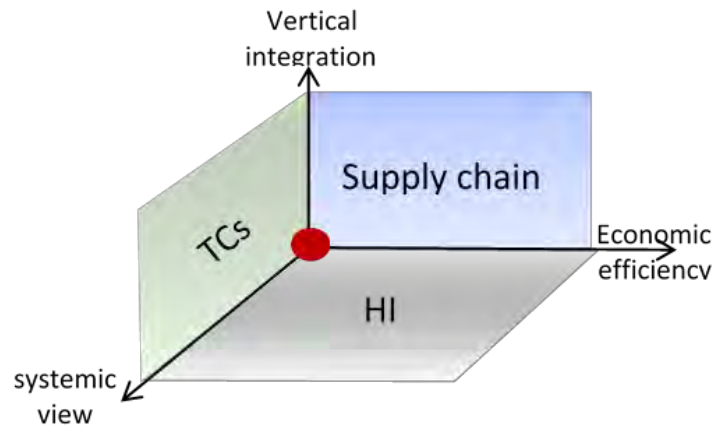

Figure 2: A theoretical framework combining HI, TCs and supply chain management

3. DISCUSSIONS

From Figure 2, we could find that there are common topics existing as the link between each two areas:

HI & supply chain management

HI is a research area that attracted loads of attention recent years. In the transforming period of China's construction industry from conventional construction to industrialization, a systemic view is needed. Supply chain, a vertical integration of constructors, end-users, the government and the market, which can provide a more objective view to achieve global optimization of HI (Mao et al., 2013).

TCs & supply chain management

Transaction costs are important because they affect the organization of economic activity or "vertical integration". Vertical integration, viewed as a continuum, is exactly the core of supply chain management (Hobbs, 1996). According to the TCs theory, one of the determinants of vertical integration is the nature and level of TCs. A change in the TCs arising from the exchange of a product may lead to a change in the management of that supply chain (Hobbs J E, 1996). Therefore, there is a correlation between TCs and supply chain management (Grover and Malhotra, 2003). Nevertheless, the combined application of TCs and supply chain in HI even the whole construction industry is very limited.

HI & TCs

Profits are the key motivation to maintain the operation of market, HI is no exception. Most researchers in this area prefer to study on the cost control to help enterprises boost profits in HI implementation. However, the actual cost of a construction project consists not only the production cost. There are also hidden costs, transaction costs (TCs), are often obscure, but they may affect the final decisions (Qian et al., 2015). The transaction paradigm has indeed received considerable attention by academics and has been applied to a variety of construction-related topics including project organization and governance. However, in the field of HI, only a few have given the attention to the importance in regards to the economic efficiency of HI projects. Most studies fail to systematically measure the TCs in the HI supply chain. Such knowledge gap is significant and it relates to the challenges faced by Chinese enterprises in producing more buildings, delivering higher quality, providing better affordability and improved economic efficiency.

4. CONCLUSIONS

TCs is chose in this paper as a new angle to understand and improve the supply chain of HI. It aims to summarize the literature of supply chain management in HI area from TCs perspective to propose a framework. The constructs of TCs and the feasibility of its application in both manufacture and construction industry is introduced. TCs is emphasised to evaluate HI supply chain integration mechanisms for the efficiency of the project economic performance. The results are expected to build a framework for scholars and managers who are working in HI field to rethink about the direction of this industry. This study also goes further exploring the key links where redundant TCs occurred on HI supply chain, which provides a guidance of HI supply chain optimization. The need to meet **customers' needs and create value while organizing HI supply chain in high level will provide challenges and opportunities**, so issues discussed here will remain on the agenda.

REFERENCES

- [1] AHMED, S. M., AZHAR, S. & AHMAD, I. 2002. Supply-Chain Management in Construction: Scope, Trends and Barriers. *Delhi Business Review-An International Journal of Society of Human Transformation & Research*, 3, 4-10.
- [2] ALLEN, D. W. 1991. What Are Transaction Costs?, 14 *Res. L. & Econ*, 1.
- [3] ANTINORI, C. & SATHAYE, J. 2007. Assessing transaction costs of project-based greenhouse gas emissions trading. Lawrence Berkeley National Laboratory, Berkeley, California.
- [4] ARIF, M., GOULDING, J. S. & RAHIMIAN, F. P. 2012. Promoting Off-Site Construction: Future Challenges and Opportunities. *Journal of Architectural Engineering*, 18, 75-78.
- [5] BALAKRISHNAN, S. & WERNERFELT, B. 1986. Technical change, competition and vertical integration. *Strategic Management Journal*, 7, 347-359.
- [6] BARZEL, Y. 1985. Transaction costs: are they just costs? *Zeitschrift für die gesamte Staatswissenschaft/Journal of Institutional and Theoretical Economics*, 4-16.
- [7] BLAIR, J., PRASAD, D., ZEHNER, R. & HYDE, R. Triple bottom line assessment and sustainability: A method of performance evaluation. *The 2005 World Sustainable Building Conference*, 2005. 1-8.
- [8] BLISMAS, N. & WAKEFIELD, R. 2009. Drivers, constraints and the future of offsite manufacture in Australia. *Construction Innovation: Information, Process, Management*, 9, 72-83.
- [9] CHRISTOPHER, M. 1999. *Logistics and Supply Chain Management: Strategies for Reducing Cost and Improving Service Financial Times*: Pitman Publishing. London, 1998 ISBN 0 273 63049 0 (hardback) 294+ 1× pp.
- [10] COOPER, M. C., LAMBERT, D. M. & PAGH, J. D. 1997. Supply chain management: more than a new name for logistics. *The international journal of logistics management*, 8, 1-14.
- [11] DEMSETZ, H. 1968. The cost of transacting. *The quarterly journal of economics*, 33-53.
- [12] DONG, Y. H. & NG, S. T. 2015. A life cycle assessment model for evaluating the environmental impacts of building construction in Hong Kong. *Building and Environment*, 89, 183-191.
- [13] DUDKIN, G. & VÄLILÄ, T. 2005. Transaction costs in public-private partnerships: A first look at the evidence. *EIB Economic and Financial Report*, 3.
- [14] EGAN, J. 1998. *Rethinking construction: The report of the construction task force*. DETR, London.
- [15] GROVER, V. & MALHOTRA, M. K. 2003. Transaction cost framework in operations and supply chain management research: theory and measurement. *Journal of Operations management*, 21, 457-473.
- [16] HOBBS, J. E. 1996. A transaction cost approach to supply chain management. *Supply Chain Management: An International Journal*, 1, 15-27.
- [17] IEA, I. E. A. 2014. *FAQs: Energy Efficiency*. <http://www.iea.org/aboutus/faqs/energyefficiency>: IEA.
- [18] JAILLON, L. C. 2009. *The evolution of the use of prefabrication techniques in Hong Kong construction industry*. Department of Civil and Structural Engineering, The Hong Kong Polytechnic University.
- [19] JANSSON, G. 2010. *Industrialised housing design efficiency*, Luleå tekniska universitet.
- [20] JOBIN, D. 2008. A Transaction Cost-Based Approach to Partnership Performance Evaluation. *Evaluation*, 14, 437-465.
- [21] KAMAR, K., ALSHAWI, M. & HAMID, Z. Barriers to industrialized building system (IBS): The case of Malaysia. In *BuHu 9th International Postgraduate Research Conference (IPGRC)*, Salford, United Kingdom, 2009.

- [22] LEVINE, M. D., KOOMEY, J. G., MCMAHON, J. E., SANSTAD, A. H. & HIRST, E. 1995. Energy efficiency policy and market failures. *Annual Review of Energy and the Environment*, 20, 535-555.
- [23] LI, H., ARDITI, D. & WANG, Z. 2015. Determinants of transaction costs in construction projects. *Journal of Civil Engineering and Management*, 21, 548-558.
- [24] LONDON, K. A. & KENLEY, R. 2001. An industrial organization economic supply chain approach for the construction industry: a review. *Construction Management & Economics*, 19, 777-788.
- [25] MAO, C., SHEN, Q., PAN, W. & YE, K. 2013. Major Barriers to Off-Site Construction: The Developers' Perspective in China. *Journal of Management in Engineering*, 130801050844006.
- [26] MCCARTHY, I. & ANAGNOSTOU, A. 2004. The impact of outsourcing on the transaction costs and boundaries of manufacturing. *International Journal of production economics*, 88, 61-71.
- [27] MOHURD, T. M. O. H. A. U.-R. D. O. T. P. S. R. O. C. 2013. Green Building Development Plan. the National Development and Reform Commission of the People's Republic of China.
- [28] MUNDACA, L. & NEIJ, L. 2006. Transaction costs of energy efficiency projects: A review of quantitative estimations. Task report under Work Package 3. EuroWhiteCert project.
- [29] NADIM, W. & GOULDING, J. S. 2011. Offsite production: a model for building< IT> down</IT> barriers: A European construction industry perspective. *Engineering, Construction and Architectural Management*, 18, 82-101.
- [30] NORTH, D. C. 1990. *Institutions, institutional change and economic performance*, Cambridge university press.
- [31] PAN, W., GIBB, A. G. & DAINTY, A. R. 2012. Strategies for integrating the use of off-site production technologies in house building. *Journal of Construction Engineering and Management*, 138, 1331-1340.
- [32] PARK, M., INGAWALE-VERMA, Y., KIM, W. & HAM, Y. 2011. Construction policymaking: With an example **of singaporean government's policy to diffuse prefabrication to private sector**. *KSCE Journal of Civil Engineering*, 15, 771-779.
- [33] QIAN, K. Q. 2012. Barriers to Building Energy Efficiency (BEE) promotion: a transaction costs perspective. The Hong Kong Polytechnic University.
- [34] QIAN, Q. K., CHAN, E. H. & KHALID, A. G. 2015. Challenges in Delivering Green Building Projects: Unearthing the Transaction Costs (TCs). *Sustainability*, 7, 3615-3636.
- [35] SEGERSTEDT, A. & OLOFSSON, T. 2010. Supply chains in the construction industry. *Supply Chain Management: An International Journal*, 15, 347-353.
- [36] SIGNORINI, G., ROSS, R. B. & PETERSON, H. C. 2015. Governance strategies and transaction costs in a renovated electricity market. *Energy Economics*, 52, 151-159.
- [37] SOLIÑO, A. S. & GAGO DE SANTOS, P. 2010. Transaction costs in transport public-private partnerships: Comparing procurement procedures. *Transport Reviews*, 30, 389-406.
- [38] SONG, J., FAGERLUND, W. R., HAAS, C. T., TATUM, C. B. & VANEGAS, J. A. 2005. Considering prework on industrial projects. *Journal of construction engineering and management*, 131, 723-733.
- [39] SRIRAM, V., KRAPFEL, R. & SPEKMAN, R. 1992. Antecedents to buyer-seller collaboration: An analysis from the buyer's perspective. *Journal of Business Research*, 25, 303-320.
- [40] TIWARI, R., SHEPHERD, H. & PANDEY, R. 2014. Supply chain management in construction: a literature survey. *International Journal of Management Research and Business Strategy*, 3, 7-28.
- [41] VRIJHOEF, R. & KOSKELA, L. 1999. The four roles of supply chain management in construction. *University of California Berkeley*, 6, 169-178.
- [42] WALKER, G. & POPPO, L. 1991. Profit centers, single-source suppliers, and transaction costs. *Administrative science quarterly*, 66-87.
- [43] WILLIAMSON, O. 1985. *Williamson OE The Economic Institutions of Capitalism*. NY: Free Press.

A Research Proposal to Improve the Environmental Performance of the Building Industry by Increasing the Innovation Activity of Small Contractors

Karen Jane MANLEY^a, Timothy ROSE^b

^a Queensland University of Technology, Australia, k.manley@qut.edu.au

^b Queensland University of Technology, Australia, tm.rose@qut.edu.au

ABSTRACT

The World Building Council for Sustainable Development has singled out the building industry as an urgent problem **where there are 'large and attractive opportunities' to reduce energy** use at a lower cost and higher return than other sectors, given an appropriate investment in innovation (WBCSD, 2009, 1). Focus on the building industry is critical as it is the single largest contributor to climate change (UNEP, 2014, 16). It is the biggest consumer of energy amongst end-use sectors, and generates more greenhouse gas emissions than the transport sector (IPCC, 2014b, 47, IPCC, 2014a, 21-23).

A shift to more sustainable building is seen as an essential part of urban renewal focused on reduced environmental impacts. Such a shift will require significant innovation, yet the building industry is renowned as an innovation laggard, rated second-last amongst all 17 Australian industries (ABS 8158.0, 2014). An exciting opportunity for fast-tracking innovation leading to sustainable buildings has been discovered by the research team. Through this study, they will divert attention given to large firms and iconic projects, where change is ponderously slow and impacts are marginal, to small contractors where change can be adopted much more rapidly and where major impacts are much more likely. The role of small contractors is significant. In fact, 98.5% of all Australian contractors are small, employing less than 20 people; yet they generate nearly half **of the industry's output and employ 62%** of workers in the industry (ABS 8155.0, 2015, ABS 8165.0, 2015).

Small contractors provide the most efficient lever for improving the sustainability of buildings. Small contractors are ubiquitous specialist intermediaries in the building industry, linking product manufacturers and distributors with **building owners and users. From an innovation system's perspective, the critical role of small contractors is clear;** they hold a strategically important position within the industry and represent a focal point in the innovation system where the benefits of improved innovation activity to support environmental objectives would have strong multiplier effects. This role has not previously been examined in any depth, particularly with regard to environmental sustainability. The paper outlines a robust research proposal to address this gap in the literature.

Keywords: innovation, building contractors, environmental sustainability

1. INTRODUCTION

This paper presents a research **proposal to investigate the research question 'How can the innovation activity of small contractors be increased to improve the environmental performance of the building industry?'** This conceptual paper contributes to the global frontier of knowledge by (1) Presenting new theory optimised for investigation of built environment sustainability problems, addressing a long-standing gap in the literature concerning the operationalisation of the socio-technical systems approach to understanding sustainability transitions; and (2) Presenting a robust method of undertaking valid and reliable research in response to the aim of improving the environmental performance of the building industry, by increasing the innovation activity of small contractors. This aim has considerable significance given recent statistics concerning the built environment.

Research conducted by the United Nations Environment Program shows 'over a third of all CO₂ emissions come from building construction and operations, over a third of all energy and material resources is used to build and operate buildings, and over a third of total waste results from construction and demolition activities' (UNEP, 2011, 352). On the bright side, recent advances in know-how, technologies and policies are creating excellent opportunities for addressing unsustainable practices (IPCC, 2014b, 102). By marshalling the latest advances in innovative practices, this proposal offers a cost-effective approach for addressing globally escalating resource

scarcity due to unsustainable use of the ecosystem. The study adopts the highly authoritative OECD definition of innovation as the implementation of a new or significantly improved product or process, including changes to marketing and organisational methods (2005). Innovation is widely considered to be a key driver of environmental improvement (UNEP, 2011).

This project will be a world-first in-depth study of the role of small contractors in facilitating environmental innovation in the building industry. The project employs Australia as a case study, where the role of small contractors is similar to that in other developed countries. In Australia, small contractors contribute nearly twice as much value in the building industry as either medium or large contractors (ABS 8155.0, 2015). Also, the building industry has the largest number of small firms amongst all Australian industries, who contribute the second-highest value to the Australian economy. The challenge is for small contractors in the building industry to deliver this prodigious output sustainably, requiring a significant investment in innovative practices.

Although small contractors represent a significant opportunity to address unsustainable building, they need policy assistance to animate and maximise their contribution. This is because small contractors have imperfect information about the climate challenge, the contribution they could make, and the benefits of innovation. The outputs provided by this proposed study are intended to address this information shortfall through a vigorous education campaign run with industry associations.

The key to unlocking the potential of small contractors lies in the need to develop new theory that captures emerging best practice in value-creation. **The proposed project's practical** benefits are completely predicated on the scientific significance of the theory work. A new Synthesised Theory of Service-Dominant Innovation will be developed by the research team to shape educational interventions that quantify the return on environmental innovation to small contractors, and (2) Map successful pathways towards achieving sustainable outcomes. This Synthesised Theory provides the vehicle to significantly improve innovation performance of the building industry and respond to Australia's **environmental problems**.

Using the new Synthesised Theory, the proposed study will pursue the following detailed objectives and outcomes to achieve its aim of improving the environmental performance of the building industry through increasing the innovation activity of small contractors:

Objective	Outcome
1. To advance social science by developing a Synthesised Theory of Service-Dominant Innovation for the building industry	<i>Advanced Social Science</i>
2. To improve the efficacy of Service-Dominant Logic by developing measurable items for new institutional and belief constructs	<i>Advanced Service Dominant Logic</i>
3. To refine and validate Synthesised Theory by conducting 20 case studies of firm-level environmental innovation by small contractors in the building industry	<i>Synthesised Theory</i>
4. To test the predictive power of the new Synthesised Theory by (a) Developing 10 Demonstration Booklets quantifying the firm-level benefits of sustainable building innovation, and showing the paths to success, and (b) Developing new Design Tools that encourage organisational change to improve innovation performance	<i>Demonstration Booklets and Design Tools</i>
5. To advance academic knowledge by publishing articles in leading journals such as <i>Research Policy</i> , conferences such as the Academy of Management meeting, and industry magazines such as <i>Business Review Weekly</i>	<i>Academic and Industry Publications</i>
6. To maximise the benefit of the Demonstration Booklets and Design Tools by vigorously promoting results through Capstone Symposia in the three most populated Australian states (NSW, Victoria, Queensland), organised with leading industry associations, such as the Master Builders Association	<i>Capstone Symposia</i>
7. To enhance knowledge diffusion with the building industry by producing content for industry magazines and advisories for industry associations.	<i>Magazine Content and Association Advisories</i>

Table 1: Objectives and outcomes

The study will address the: conceptual problem of improving the scope of services theory; empirical problem of reducing the impact of the building industry on climate change; management problem of the best way of driving environmental innovation; and policy problem of encouraging energy efficient building production.

2. LITERATURE REVIEW

Existing theoretical approaches to innovation have focused on the manufacturing industry. Unfortunately, learnings from the manufacturing sector do not readily apply to service-dominated contexts (Ordanini and Parasuraman, 2010), such as the building industry. The building industry is defined here as equivalent to Building Construction and Construction Services in Division E of the Australian and New Zealand Standard Industrial Classification (ANZSIC). These two subdivisions interpret the building industry by types of contractors, comprising main contractors and trade contractors providing general and specialised building services respectively, including: building, mechanical, air-conditioning, heating, fire, security, plumbing, electrical, carpentry, glazing, earthmoving, concreting, bricklaying, roofing, tiling, plastering, painting and decorating.

The issue of whether the building industry provides a service or a product is hotly debated in the construction management literature. The majority view is that contractors manage the production process – making them service providers – with material and equipment suppliers providing products (De Valence, 2011). The proposed research adopts this view, meaning a theory that addresses innovation in services is required to maximise the value of the empirical work. Emerging literature in the business management discipline focuses on the growing importance of service-dominant innovation and value co-creation within networked systems, where customers demand total solutions (Lusch et al., 2010). This service-dominant view suits the complexity of the building industry where production is service-intensive, project-based and delivered by multiple organisations.

Increasing emphasis on services in modern economies has given rise to Service-Dominant Logic (SDL) (Lusch et al., 2010) which is a conceptual framework that positions services as central to all innovation processes. SDL is gaining popularity because traditional approaches to understanding service innovation were based on product innovation theory, giving misleading results (Ordanini and Parasuraman, 2010). Product innovation theory rests **on formalised R&D processes, which are often absent in service innovation, replaced by 'softer' creative processes.** Existing literature on service innovation also fails to account for the complexities of the building industry context, because it is more focused on other industries such as tourism, health or telecommunications. The research team will develop a new Synthesised Theory of Service-Dominant Innovation drawing in-part on SDL, by combining fresh insights from business management and construction management disciplines to provide a new in-depth value-creation framework. **The new Synthesised Theory aims to capture the drivers of 'grassroots' innovation which** is increasingly argued to typify successful construction innovation (Loosemore, 2015). Consistent with SDL thinking, grassroots innovation relies on a capable motivated workforce capitalising on their day-to-day interactions with other firms and thinking across projects.

The proposed study will be the first time that the environmental innovation potential of small contractors has been comprehensively examined in the Australian building industry. The closest existing literature is that by Manley (2008) on which the current study builds. This previous work provides an introduction to small firm innovation **in the building industry, providing a solid platform for the current study's specific focus on environmental innovation** by small contractors, given their strategic importance in addressing climate change.

3. THEORETICAL FRAMEWORK

It is argued here that the best approach to framing the current study of environmental innovation by small contractors is a Synthesised Theory of Service-Dominant Innovation for the building industry, because it captures emerging approaches to value-creation in service industries, at the same time exploring the belief drivers of firm-level capabilities within a given institutional context. A new Synthesised Theory will be developed, drawing in part on existing SDL as developed by Lusch and Vargo (2010). At present SDL is not a developed theory, rather a set **of axioms about economic exchanges based on 'intangible resources, co-creation of value and relationships'.** The proposed study will advance SDL; developing it into an innovation theory suitable for the built environment. SDL has never before been applied to the building industry. The closest existing literature comprises three studies that apply SDL to similar contexts comprising multiple industries, consulting firms and public transport authorities (Wikstrom et al., 2009, Rahikka et al., 2011, Peters et al., 2012, Hartmann et al., 2014) respectively. None of these studies adopt the strategic focus of the current proposal on environmental innovation by small contractors.

A recent study by Ordanini and Parasuraman (2010) develops an innovation theory based on SDL capabilities and tests it in the hotel industry. This new work is seminal in that it moves away from product-based innovation theories,

and service innovation theories derived from them. The research by Ordanini and Parasuraman validated key constructs associated with SDL, which focus on a range of specialised capabilities. A more recent conceptual paper by Lusch and Vargo suggests the value of explicitly incorporating institutions within SDL (2016). Institutions are defined as established practices and are highly context specific. The proposed study will develop new Synthesised Theory that extends the validated capability constructs developed by Ordanini and Parasuraman; updating them to account for the role of beliefs in their formation, the passage of time and different industry contexts. The principal scientific work lies in developing new institutional and belief constructs and measured items. Learnings derived from these two new constructs are **critical to the study's development of a high-impact educational campaign**.

The proposed study abandons a traditional view of firm performance to embrace a multi-level theory and the deeper insights provided (Lichtenthaler, 2011). Hence, SDL is a firm-level construct, institutions are a system-level construct and beliefs are an individual-level construct. The current paper thus develops the new theory shown in Figure 1.

The model shows that firm-level innovation outcomes are driven by firm capabilities and institutional context, with **managers' beliefs being a key influence on firm capabilities**. The model is consistent with previous simple models that realistically, but more crudely show innovation as the result of factors internal and external to the firm (Manley, 2008). It is also consistent with the resource-based view (RBV) of the firm which focuses on capabilities; open innovation literature which focuses on collaborative arrangements with other organisations and knowledge integration; and the democratising innovation literature which focuses on customer orientation.

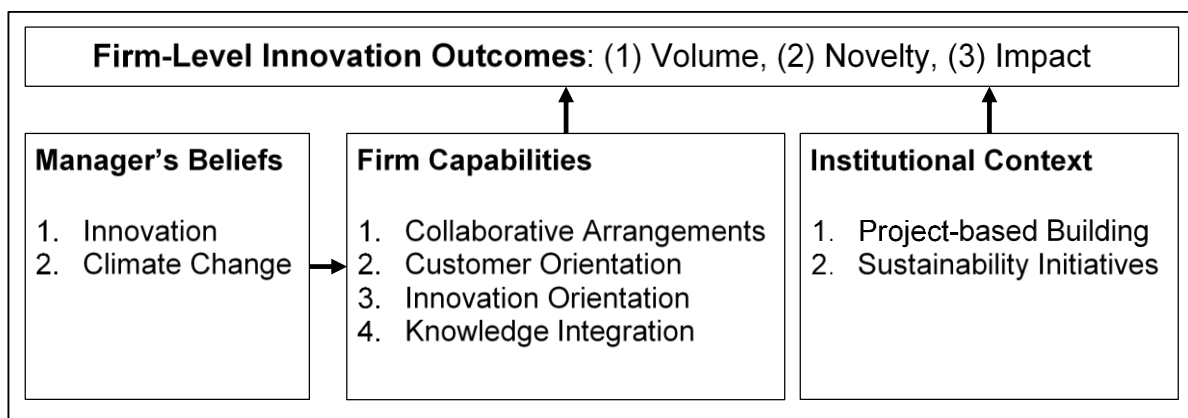

Figure 1: Synthesised Theory of Service-Dominant Innovation
(Based on Ordanini and Parasuraman (2010), Vargo and Lusch (2016) and Lichtenthaler (2011))

6. APPROACH AND METHODOLOGY

The proposed project adopts a rigorous qualitative research design featuring theoretical development, case studies, action research, and Capstone Symposia over a three years program.

Stage 1	Theoretical Development	3 months
Stage 2	Empirical Validation by Case Studies: <ol style="list-style-type: none"> 1. case study logistics – select and establish contact with 20 firms 2. case study performance – theory-led interviews and firm visits 3. cross case analysis – using directed content analysis 4. theory refinement – reflection on the match between theory and empirics 5. write and publish academic papers in leading journals 	13 months 2 months 5 months 2 month 2 month 2 months
Stage 3	Testing Synthesised Theory through Action Research Activity A: Demonstration Booklets <ol style="list-style-type: none"> 1. assist 10 firms with quantifying innovation benefits 2. write/diffuse booklets based on innovation benefits and theory-led drivers 3. diffuse booklets Activity B: Design Tool Intervention <ol style="list-style-type: none"> 1. tailor generic Design Tools to make them applicable to context 2. select appropriate tools and adapt to 10 firms 3. implement tool in each firm, document process and assess impact Write and publish academic papers in leading journals	6 months 2 months 3 months 1 month 8 months PhD student 3 months 5 months 3 months
Stage 4	Knowledge Diffusion within the Building Industry: <ol style="list-style-type: none"> 1. undertake Capstone Symposia in Sydney, Melbourne and Brisbane 2. write and publish content for industry magazines 3. write advisories for industry associations 	3 months

Table 2: Research design and timeline

Stage 1: Theoretical development

Objective: To extend the specification of SDL into a multi-level innovation theory

Methods: Theoretical extension is based on the addition of two new constructs - institutions and beliefs - as drivers of firm-level service innovation, alongside the previously validated construct of capabilities and firm-level innovation outcomes. The extension work accounts for institutions around project-based building and sustainability initiatives. The extension work also accounts for beliefs about innovation and climate change. All of the extension work will be based on the procedure pioneered by Chen and Manley (2014). A well-structured and comprehensive literature search will be undertaken to identify relevant and validated measured items, using directed content analysis, resulting in two parsimonious and comprehensive sets of items.

Outcomes: A Synthesised Theory of Service-Dominant Innovation that advances the frontiers of knowledge in social science and better frames empirical work in similar contexts compared to existing theories.

Stage 2: Empirical validation by case studies

Objective: To advance the knowledge base for innovation in service-dominant contexts

Methods: The theoretical model developed by the project will be empirically tested using a case study approach. The literature indicates the value of qualitative research, suggesting that between 4 and 10 case studies are optimal for theory building and testing (Eisenhardt, 1989). The project will conduct two sub-projects: Sub-project A is 'learning from success' and Sub-project B is 'learning from failure'. Both studies focus on the relationships of small contractors with the rest of the supply chain. 'Success' and 'failure' is determined by whether the innovation met the firm's expectations or not. In each sub-project, 10 case studies will be conducted, falling within the recommended range. The population for both sub-projects will comprise small contractors across Australia, who have been engaged in environmental innovation of any type, comprising product, process, marketing or organisational, at any level of novelty, comprising new to the firm, market or world (OECD, 2005, 47 & 57). The innovation must have taken place in the past three years to aid recall.

The sample will be drawn using databases maintained by industry associations and related building award programs. Early investigation has allowed pre-identification of most of the required cases. The evidence for each case study will be triangulated across: (1) A face-to-face semi-structured interview, framed by the synthesis theory developed by the project, with a senior manager in the firm; (2) Observational data gathered by firm visit/technical tour; (3) Documents provided by the firms. In both sub-projects, learning is facilitated by the synthesis model constructs and underlying measurement items which will provide a subtle, fine-grained and insightful view of innovation drivers. Twenty case studies will be conducted. This high number of cases is required given the acknowledged complexities of project-based production and innovation processes, together with the focus on learning from failure as well as success.

Outcomes: A new and validated theory of firm-level service-dominant innovation that is novel, complete, parsimonious and applicable to the building industry, supported by 20 case studies.

Stage 3: Testing synthesised theory through action research

Objective: To test the value of the new theory in directing efforts to quantify the benefits of environmental innovation by successful small contractors and effectively help unsuccessful small contractors to implement tools to improve their innovation performance.

Methods: The Action Research is organised around two distinct activities. Activity A involves the project team using the newly developed Synthesised Theory to frame further investigation of the 10 successful innovators from Sub-project A, to help them quantify the benefits of their environmental innovations, and then publish their stories. Each story will include appropriate packaging and reporting of the theory-led innovation drivers uncovered in Stage 2. These stories will be published in Demonstration Booklets following the format of the influential Construction Excellence program in the UK (Egan, 1998). One thousand professionally developed and printed copies of the 10 booklets will be produced. The booklets will be vigorously promoted to other small contractors to encourage their innovation efforts. Diffusion of booklets will be by the research team through the Capstone Symposia (Stage 4), by industry associations through seminars, and by small contractors through their networks.

Activity B involves the project team using the newly developed Synthesised Theory to guide development of new Design Tools to be used in further investigation of the 10 unsuccessful innovators in Sub-project B. The project team will help the firms to implement the new Design Tools which aim to create organisational change that improves innovation activity, its environmental impact and the return to the firm. The new tools will be based on recent ideas emerging from Columbia Business School. The study takes these marketing ideas and develops new tools such as journey mapping, 360 empathy, co-creation, ethnographic interviews, storyboarding, concept anchors and elicitation posters (Liedtka et al., 2014), that are applicable to an innovation context in the building industry.

Outcomes: (1) Refinement of the new Synthesised Theory to improve its predictive power (2) Development and validation of new Design Tools to create organisational change (3) 10 easy-to-read and highly publicised Demonstration Booklets quantifying the benefits of environmental innovation by small contractors in the building industry, including theory-led insights about latent innovation drivers; (4) 10 documented firm-level interventions to improve innovation performance, framed by new Design Tools.

Stage 4: Knowledge diffusion within the building industry

Objective: To vigorously promote the firm-level benefits of environmental innovation by small contractors

Methods: Based on 10 Demonstration Booklets and 10 Design Tool interventions, three national Capstone Symposia will encourage environmental innovation. The symposia will be organised with the main industry associations in three states, with whom the research team have good relationships, such as the Housing Industry Association and the Master Builders Association. Presentations from the research team, industry associations and small contractors will be given. Plenty of time will be allowed for discussion with the audience of 100+ small contractors in each state. This discussion will be recorded, transcribed and analysed.

Magazine content and association advisories will also be written and distributed in Stage 4, in part based on the symposia learnings, which will also feed into new research directions. The advisories are particularly important to

knowledge diffusion, as is the industry association support of this proposal, where these two factors promise widespread impact. The research team and industry association leaders are passionate about running an intense and wide-reaching educational campaign based on magazine content and association advisories, together with the three national symposia, 10,000 Demonstration Booklets and on-going industry association seminars.

Outcomes: A 25% increase in environmental innovation by Australian small contractors following the educational campaign, which the research team will test on a sample provided by Master Builders Association members in Queensland, with a pre and post survey.

7. CONCLUSIONS

This conceptual paper is based on a desk-top study of secondary sources to justify and design a proposed program of research. The contributions of the paper comprise (1) An assessment of the role of small contractors in environmental innovation, (2) A new theoretical approach to understanding the latent drivers of best practice and (3) A field work-method to understand the beliefs and capabilities that support leading small contractors.

The Synthesised Theory of Service-Dominant Innovation developed here is both useful for the proposed study and has more general applicability as a more nuanced approach to assessing the beliefs and capability of leading firms engaged in constructing a more sustainable built environment.

The current paper makes a theoretical contribution to the understanding of firm performance in an important empirical setting. Future research by the author will involve execution of the proposed study. A limitation of the paper is that the effectiveness of the proposed theory and methods is yet to be tested empirically.

REFERENCES

- [1] ABS 8155.0 2015. Australian Industry 2013-14, Canberra, Australian Bureau of Statistics.
- [2] ABS 8158.0 2014. Innovation in Australian Business, 2012-2013, Canberra, Australian Bureau of Statistics.
- [3] ABS 8165.0 2015. Counts of Australian Businesses, Canberra, Australian Bureau of Statistics.
- [4] Chen, L. & Manley, K. 2014. Validation of an instrument to measure governance and performance on collaborative infrastructure projects. *Journal of Construction Engineering and Management*, 140, 04014006.
- [5] De Valence, G. 2011. Market types and construction markets. In: DE VALENCE, G. (ed.) *Modern Construction Economics*. Abingdon: Spon.
- [6] Egan, J. 1998. *Rethinking Construction: The Report of the Construction Task Force*. London: Department of the Environment, Transport and the Regions.
- [7] Eisenhardt, K. M. 1989. Building Theories from Case Study Research. *The Academy of Management Review*, 14, 535-550.
- [8] Hartmann, A., Roehrich, J., Fredriksen, L. & Davies, A. 2014. Procuring complex performance: the transition process in public infrastructure. *International Journal of Operations and Production Management*, 34, 174-194.
- [9] IPCC 2014a. Summary for Policymakers. In: WORKING GROUP III (ed.) *Climate Change 2014: Mitigation of Climate Change. Fifth Assessment Report of the Intergovernmental Panel on Climate Change (IPCC)*. UK: Cambridge University Press.
- [10] IPCC 2014b. *Climate Change 2014: Synthesis Report*, Geneva, Intergovernmental Panel on Climate Change.
- [11] Lichtenthaler, U. 2011. Open innovation: past research, current debates, and future directions. *Academy of Management Perspectives*, 25, 75-93.
- [12] Liedtka, J., Ogilvie, T. & Brozenske, R. 2014. *The designing for growth field book*, New York, Columbia University Press.
- [13] Loosemore, M. 2015. *Grassroots Innovation in the Construction Industry*. Construction Innovation. John Wiley & Sons, Ltd.
- [14] Lusch, R., Vargo, S. & Tanniru, M. 2010. Service, value networks and learning. *Journal of the Academy of Marketing Science*, 38, 19-31.
- [15] Manley, K. 2008. Against the odds: Small firms successfully introducing new technology on construction projects. *Research Policy*, 37, 1751-1764.
- [16] OECD 2005. *Oslo Manual. 3rd Edition. Revised Guidelines for Collecting and Interpreting Innovation Data* - Paris: Organisation for Economic Cooperation and Development/Eurostat

- [17] Ordanini, A. & Parasuraman, A. 2010. Service innovation viewed through a service-dominant logic lens: A conceptual framework and empirical analysis. *Journal of Service Research*, 21, 00.
- [18] Peters, L., Johnston, W. & Pressey, A. 2012. Involving clients in innovation: exploring expectation, knowledge and competency gaps. *Proceedings of the 28th Annual Industrial Marketing and Purchasing IMP 2012 Conference*. Rome: IMP Group.
- [19] Rahikka, E., Ulkuniemi, P. & Pekkarinen, S. 2011. Developing the value perception of the business customer through service modularity. *Journal of Business and Industrial Marketing*, 26, 357-367.
- [20] UNEP 2011. *Towards a Green Economy: Pathways to Sustainable Development and Poverty Eradication*, Geneva, United Nations Environment Program.
- [21] UNEP 2014. *Greening the building supply chain*, Geneva, United Nations Environment Program (UNEP).
- [22] Vargo, S. & Lusch, R. 2016. Institutions and axioms: an extension and update of the service-dominant logic. *Journal of the Academy of Marketing Science*, 44, 5-23.
- [23] WBCSD 2009. *Energy Efficient Buildings: Transforming the Market*, Geneva, World Business Council for Sustainable Development,
- [24] Wikstrom, K., Hellstrom, M., Artoo, K., Kujala, J. & Kujala, S. 2009. Services in project-based firms - four types of business logic. *International Journal of Project Management*, 29, 113-122.

Mongolia's First Cooperative Transformation Attempt on Built Environment through Greening Kindergarten Building

Nergui DORJ^a

^a Mongolia Green Building Council, Mongolia, dnergui@m-icp.com

ABSTRACT

The Parliament of Mongolia adopted the Green Development Policy in 2014 followed by the adoption of Mongolia's Long-term sustainable development concept (2016-2030) in the beginning of 2016. One of fundamental focus of these policies is an adoption of green building principles into practice in the local context.

Despite several efforts mainly initiated by international agencies and private sector in the past, no cooperative attempts as such have been successfully demonstrated and scaled-up to date.

At the request of the Government of Mongolia (GOM) and with the support of the Global Green Growth Institute (GGGI), Mongolia Green Building Council (MGBC) has carried out a range of policy and technical research and preparatory work to develop the business case and demonstration design for Mongolia's first green public kindergarten.

The main specifics of this project were: (i) close cooperation among different stakeholders, including education users; (ii) preparation of comprehensive package for demonstration and replication of green kindergarten buildings in Mongolia; (iii) use as much as possible locally produced innovative green products and technologies; (iv) undertake cost and benefit analysis of green kindergarten using CAPEX, NPV and other methodologies; (v) preparation of recommendation on potential financing mechanisms to fund the demonstration and replication of green kindergartens; (vi) Preparation of design and technical guidelines for green kindergarten for the Government use.

It was concluded that building a green kindergarten has a positive net social benefits, including greener built environment which can have a greater community impact towards creation of sustainable community through increased energy and heat efficiency, lower CO2 emission, hereby healthier living environment and saving natural resources, even though its initial investment can be higher than that of traditional non-green kindergarten buildings.

1. INTRODUCTION

1.1 Background

Mongolia is a country in North-East Asia with extreme continental climate. Its economy is largely dependent on the mining sector and seasonal agriculture. 40 percent of the total population of Mongolia lives in the capital city - Ulaanbaatar and 67 percent of Mongolia's population is under 35. The demand for pre-school education is higher than its supply and therefore it is considered as one of government policy priorities to build more pre-school facilities to ensure all children have an access to quality pre-school education. In addition, existing pre-school facilities had been built without taking account child health impacts of educational buildings, any environmental sustainability and resource efficiency matters.

Mongolia as one of United Nations member states, committed to green and sustainable development. This commitment has been manifested in numerous policy documents, including "Green Development Policy of Mongolia" and "Long-Term Sustainable Development Concept – 2030" both adopted by the Parliament in 2014 and 2016 respectively. The greening buildings through introduction of green building rating system is one of policy mechanisms to be used for achieving the strategic objective #1 of Mongolia's Green development policy.

1.2 Objective

Against this background, the Ministry of Environment and Tourism (MET) and the Global Green Growth Institute (GGGI) jointly initiated to implement a project on Design and Implementation Planning of Green Kindergarten in Mongolia which could become a model educational facility that are child and environmentally friendly. The team of

newly established professional association - Mongolia Green Building Council and the Buildings Technology LLC (BT), the engineering company has been selected to undertake this task of designing first ever in Mongolia green kindergarten building with 125 child capacity in the district where mainly low income families reside.

The main purpose of this paper is to describe the main points and findings of the assessment and design of green kindergarten building through collaborative efforts involving all relevant stakeholders and making a contribution in creation of sustainable built environment in the country.

2 COOPERATION AMONG RELEVANT STAKEHOLDERS

The output of this project is a result of collaborative efforts of MGBC, BT, and Government working group on greening educational facilities, GGGI, representatives of professional associations, building sector and education users. The cooperation among relevant stakeholders began from the very beginning in November 2015 with numerous consultative and capacity building events where the main objective of the project introduced and voices of stakeholders on the need for greening educational facilities and technology options available were heard. In total of such 15 consultative and capacity building events organized by the project team during first 6 months of this project which resulted in final selection of green kindergarten technology options.

3 BUILDING TECHNOLOGY OPTIONS

The following main principles have been used to defining and deciding on green kindergarten building technology solutions:

- Resource efficiency and technology availability locally
- Technology friendliness from both educations users and environment perspectives
- Cost effectiveness
- Overall green building principles, including indoor air quality, comfort ability, use of renewable energy, safety and requirements for outdoor environment
- Encourage local innovation

A comparative analysis has been carried out by a group of architects, construction engineers and other relevant building and infrastructure experts for existing ordinary kindergarten technologies with suggested greener technologies within the framework of final technology design. It shall be noted that the existing building code of Mongolia is used as a benchmark for this analysis.

Based on this analytical work, the design and engineering team prepared the set of building technologies: (1) reinforced concrete frame; (2) floor heating system – TABS; (3) mechanical (AIS-1,2,3 ASS-1-5) and ordinary ventilation system (OSS-1-11); (5) solar system with 32 kW peak capacity; (v) decentralized grey and waste water treatment system; (6) addressable and scalable fire alarm system with monitoring cameras, internal communication, warning and timing system; (7) automated control system with weather station, CO2 sensor and room temperature and humidity sensors.

Regarding architectural planning, below building materials considered most suitable for this kindergarten:

	Building units	Ordinary		Green	
		Materials	Remarks	Materials	Remarks
1	Wall	Light block /360mm/	Brick structure /380mm/ feasible	Euro-block, main block /200mm/	Recyclable and environmentally friendly
2	Insulation	Styrofoam /100mm/	Negative impact on the environment and public health	Mongolia made sheep-wool insulation /100mm/	Has no negative impacts on public health and recyclable
3	External facade	Screen, plaster and paint	Annual maintenance is required, operational cost is high	Air layer /150mm/	Recyclable, long-lasting, annual maintenance is not required, minimal operational cost
4	Window	Ordinary vacuum windows	High level of heat loss	Triple layers of glasses, insulated aluminum frame and low exposure external glass	Minimal heat loss
5	Floor	Ordinary wooden floor covered by carpets	Heat loss from the floor	Heated floor	Comfortable for children and warm from the floor

6	Internal wall covering	Oil-based paint	Negative public health impact	1.1 meters tall lower wall cushion and emulsion paint for the upper sections	No negative on children's health, safe and minimal smell
7	Roof	Ordinary metal or black paper		Green roof	Decrease of CO2 emission, energy saving

Table 1: Comparison of building materials for ordinary and green kindergartens
Source: MGBC and BT, 2016 Final design, technology options and financing

The quality of building insulation is most important as Mongolia's weather is extreme continental with -25 to over -40 winter temperature. For this reason, an innovative insulation material shown in two images below produced in Mongolia by Mongolian companies using sheep wool was selected for insulation.

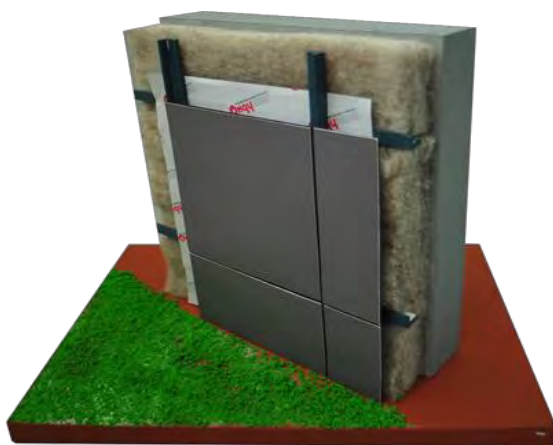

Image 1: Sheep wool insulation for wall
Source: Ecowool LLC, 2015



Image 2: Wool insulation for kids convenience
Source: "People in Need", 2014

4. COST-BENEFIT ANALYSIS

After all technologies and building materials selected, the cost-benefit analysis (CBA) for green kindergarten project has been undertaken to find out whether this project is viable and sound investment or not in Mongolia condition from net social benefits perspective. The Capital expenditure (CAPEX) and Net present value (NPV) methods used for the analysis and for doing so the following assumptions have been made:

- The building lifetime is 40 years as instructed by the Ministry of Education, Culture and Science (MECS)
- Social discount rate is 3%
- Inflation rate is 1% annually

The CBA expert-team suggested the below results of their findings:

- Initial investment cost for green kindergarten is 26% higher than the initial investment cost of ordinary kindergarten
- Operational and maintenance costs are expected to be twice lower compared with ordinary kindergarten buildings
- Initial investment payback period is 14 years
- NPV is 1.192 Billion Mongolian tugrugs (MNT) which is equivalent of approximately 596.000USD
- Heating expenses is expected to be 50% lower than that for ordinary kindergarten buildings
- Reduction of electricity costs is 95%
- Water efficiency: 16.6% in drinking water supply; 99.5% cost reduction for waste water treatment
- 91.8-120 tons of CO2 reduction
- Reduction of costs related to child sickness
- Eventual reduction of pressure on public funds
- Positive net social benefits

5. POTENTIAL FUNDING MECHANISMS

One of tasks of this project was to carry out an assessment of potential and preferred funding sources for construction of green kindergarten. Based on data available, the following funding mechanisms suggested as potential funding sources:

- State budget
- Local budget
- Grants of international agencies
- Concessional loans from international development banks
- Mixed funding of grants and concessional loans
- Public-private partnerships
- Private sector funding
- Special purpose bond

After potential funding mechanisms identified, an assessment of each funding source was carried out to ensure the government takes it into consideration the most preferred funding courses while making a decision on construction of green kindergarten.

The criteria such as resource availability, expected time to lead to prepare a project and to execute a project, transaction costs and risks have been used for the assessment of funding sources and the result of this assessment suggested that the state budget, concessional loan from international bank and mixed funding of grants and concessional loans from international agencies are likely to be most potential funding mechanisms for construction of green kindergarten.

6. DESIGN SPECIFICS AND PUBLIC PROCUREMENT

This kindergarten building location plan is fully complied with local requirements and standards and is includes space provisions for safety and numerous distance connections to ensure independent movement and activities of kids. Classroom locations were chosen with optimal lighting and ventilation provisions that suit to the local climate conditions. The green house is planned and it will be located in the west side of the facility with 9 to 16 hours of daylight. This will allow children to have an opportunity to get close to the natural environment as **Mongolia's long cold winter from Nov-March** cannot provide the opportunity for children to play and have any activities outside of the kindergarten facility during this time of the year. Heating and moisture controls of the green house shall be connected to, and monitored by the smart monitoring system /BMS/ of the facility.

As specified in section 2, child and environmentally friendly technologies have been selected for designing this kindergarten. The Figure 1 shows the External lot planning of this kindergarten as an example of design specifics.



Figure 1: External lot planning
Source: MGBC and BT, 2016 Final design, technology options and financing

The planned kindergarten is going to be a public kindergarten and therefore it was necessary for the project team to looking into public procurement procedures and regulations. The team found out that the greening of kindergarten building is very much in line with public procurement procedures as it can ensure the efficient and accountable use of public funds. The only one issue that was necessary for the project team while implementing this project and the government procuring entity in the future shall be taking into account was the technical specification of the bidding document. The project team after carefully reviewing the model bidding document of the government developed a model technical specification for green kindergarten which reflects all technology and building material options. This model technical specification can be used as it is, otherwise can be slightly modified according to specific local conditions and requirements by government producing entities in the future.

7. CONCLUSION

This assessment identified the importance of closer cooperation of relevant stakeholders to successfully run a project and also smooth start of a green building project combined with national capacity efforts on green building.

The CBA done from net social benefits perspectives suggested that the green kindergarten project is cost effective and has positive net social benefits with twice reduced operational and maintenance costs and is resource and energy efficient.

The state budget, concessional loans and a mixed funding of grants and concessional loans from international agencies are most preferred funding sources for construction of green kindergarten building.

The final design of green kindergarten building meets all required standards and building code of Mongolia and the building is designed to be child and environmentally friendly.

Any public procurement shall be organized in line with public procurement procedures and regulation. The technical specification is an important part of the bidding document of the procurement. Therefore, the project team developed the model technical specification for green kindergarten based on the selected technologies and building materials which can be used as it is or can be slightly modified depending on specific local conditions and requirements.

REFERENCES

- [1] Mongolia Green Building Council (MGBC). and Building Technology LLC (BT)., (2015) Design and Technology Options Analysis
- [2] Mongolia Green Building Council (MGBC). and Building Technology LLC (BT)., (2016) Capacity Building of Multiple Stakeholders and Cost-benefit Analysis of Green Public Kindergarten Facilities in Mongolia
- [3] Mongolia Green Building Council (MGBC). and Building Technology LLC (BT)., (2016) Financing Mechanisms for Green Educational Buildings in Mongolia
- [4] Mongolia Green Building Council (MGBC). and Building Technology LLC (BT)., (2016) Final Design, technology option and financing
- [5] Mongolia Green Building Council (MGBC). and Building Technology LLC (BT)., (2016) Engineering, procurement and construction
- [6] **Nergui, D. (2016) "Importance of Introducing Green Building Rating System to Ensure Energy Efficiency", North East Asia Mayors Forum – 2016, Ulaanbaatar, pp 10-13.**
- [7] Ecowool LLC. (2015) Photo album: Using wool padding for walls with iron and concrete, [online], Available: <http://ecowool.mn/work-en> [2015]
- [8] People in Need. (2014) Wool insulation is safe, [online], Available: <http://www.pin-mongolia.org/clanky/-----/------.html> [2014]

Session 6.6: Green Construction Materials (1)

Naturally Ventilated Earth Timber Constructions

Andrea KLINGE^a, Eike ROSWAG-KLINGE^b, Christof ZIEGERT^c, Patrick FONTANA^d, Matthias RICHTER^e, Johannes HOPPE^f

^a Roswag Architekten, Germany, klinge@zrs-berlin.de

^b Roswag Architekten, Germany, roswag@zrs-berlin.de

^c Ziegert Seiler Ingenieure, Germany, ziegert@zrs-berlin.de

^d Bundesanstalt für Materialforschung und -prüfung (BAM), Germany, patrick.fontana@bam.de

^e Bundesanstalt für Materialforschung und -prüfung (BAM), Germany, matthias.richter@bam.de

^f Bundesanstalt für Materialforschung und -prüfung (BAM), Germany, johannes.hoppe@bam.de

ABSTRACT

Earth, timber, fibre boards and insulation materials based on wooden and other natural fibres offer a variety of properties, beneficial for eco innovative constructions, that are able to improve the energy and resource efficiency of buildings.

Due to their porosity natural building materials are vapour active and therefore able to buffer moisture. In combination with highly insulated and airtight but vapour permeable building envelopes, modern earth-timber constructions provide stable relative humidity levels indoors and can therefore be naturally ventilated, while achieving highest energy efficiency standards. Experimental evidence suggests that monitored pilot buildings in Berlin do show healthy indoor air humidity levels (around 50%) in wintertime, while mechanically ventilated buildings demonstrate significantly lower values (around 25%), which have to be considered as unhealthy and uncomfortable.

The application of building materials being poor of chemical emissions, particularly volatile organic compounds (VOC) and radon, improves the indoor air quality further, so that intermittent ventilation twice a day will be sufficient to provide healthy indoor air quality, however, the air quality in critical rooms (e.g. small bedrooms), demonstrating a smaller air volume, should be monitored if appropriate ratios of room size to occupancy level cannot be realised.

Through nighttime ventilation in summer, vapour active earth-timber constructions provide evaporative cooling (humidity adsorption at nighttime and desorption during the day). As a result indoor temperatures of earth-timber buildings range around 8 °C below the outside temperature peak, when an appropriate glazing ratio is reflected.

The EU funded research project [H] house is investigating various construction materials regarding water vapour adsorption as well as emission and absorption of harmful substances. Based on this investigation new wall constructions are designed to provide a healthier indoor environment.

Keywords: indoor environmental quality, climate control through natural materials, natural ventilation

1. INTRODUCTION

Occupant's health, wellbeing and also productivity are relying on the indoor environmental quality of our built environment. Renovated and new low energy buildings, developed to be highly airtight, are demonstrating unforeseen shortcomings with regards to increased relative humidity (RH) levels and higher concentration of air pollutants. Reduced air exchange rates increase these problems and are likely to cause damp problems and condensation resulting in mould growth, and, in the worst case, in disorders and outbreak of allergic reactions.

To overcome difficulties with moisture, dwellings nowadays are fitted out with mechanical ventilation systems despite associated constraints such as space requirements, additional costs, system maintenance as well as compromised occupant health, comfort and control. The main criteria for ventilation are as following:

- Control of indoor air humidity;
- Absence of harmful substances;

- Provision of fresh air.

In case of protection against overheating in summer the provision of cooling through heat pumps or other active system is often allowed for, resulting in additional energy demand for the system operation, increased space requirements and an uplift in construction and maintenance cost. It is assumed that through application of appropriate materials, the requirements on all aspects mentioned above can be satisfyingly fulfilled.

The EU funded project [H] house aims to develop eco innovative partition walls providing affordable solutions for a wide-spread application. In this study natural building materials have been compared to conventional materials to identify their potential to improve the indoor environment quality, while limiting the use of technology.

Special emphasis was placed on the improvement of earthen plasters through the addition of aerogels with regards to both, the moisture buffering capacity as well as the adsorption of airborne pollutants. For the moisture adsorption especially velocity and overall moisture uptake were investigated in greater detail.

Comprehensive experiments at material but also at component level have been undertaken to provide a database for the numerical prediction of appropriate material combinations that are able to react to different scenarios, since available surface area, occupation density, air volumes but also the construction of the building envelope might differ significantly between projects.

Accompanying experiments with regards to the emissions of the materials as well as to their adsorption potential of airborne pollutants have been conducted to identify materials that generate the most positive effects on the living environment.

In addition, experimental data coming from the monitoring of a dwelling in Berlin fitted out with earth plasters and wood fibre based partition walls has been evaluated in relation to indoor air temperatures and RH levels.

2. MATERIALS AND TEST METHODS

2.1 Material selection

The material selection was based on an in-depth market analysis focused on natural building materials for internal partition walls, characterised through hygroscopic properties. In addition, natural building materials with no or limited data collection were shortlisted to close a scientific gap. Special emphasis was placed on earth plasters modified with aerogels. In the experimental campaign, the contribution to the water vapour adsorption of one type of aerogel granulate (CMSGI) and two types of aerogel powder (CMSPI and NDPI) was investigated.

For benchmarking purposes, also conventional construction materials have been included. In total approx. 100 materials, grouped into their function of assembly, have been investigated (Table 1).

2.2 Water vapour sorption tests

The voluntary test procedure is determined in DIN 18947 to identify the capacity of earth plasters to adsorb moisture from the **air via the specimen's surface within set time intervals. Based on the time in which s specified** amount of moisture has been adsorbed, the water vapour sorption class (WS I – WS III) of (only) plasters can be classified. For wall build-ups the 12 hour test procedure was extended to five adsorption and desorption cycles.

2.3 Emission tests

The materials listed in Table 1 were screened for potential emissions prior to the standard tests to estimate the compounds to be expected. Final emission tests ((S)VOCs, radon) for single materials (six types) and 13 combinations of them were carried out in specially designed test chambers over a testing period of 28 days. They were conducted following the requirements of prEN 16516 and evaluated against the German AgBB scheme, in the absence of harmonised evaluation procedures.

Formaldehyde and VOC-analyses were carried out according to ISO 16000-3 and -6 and radon measurements in accordance with a procedure developed by Richter et al.

Function	Material	Thickness [mm]
Finishing materials	Earthen paint, marble powder paint, brush applied earth plaster, dispersion paint	0.5 - 2
Render	Aerogel modified earth plaster, earth plaster	3 – 15
Reinforcement	Flax fibre -, glass fibre – and system compatible reinforcement	0.5
Adhesive	Earth - and system compatible adhesives	2 - 3
Wall lining boards	Earth dry - and cellulose boards, wood fibre -and wood fibre sandwich boards, plywood, gypsum plaster – and - fibre boards, OSSB	12.5 - 31
Insulation	Wood fibre -, flax fibre - and hemp insulation, sheep's wool, straw, recycled clothes, mineral - and glass wool	40 - 80
Load bearing walls	Cross laminated timber	100
Non-load bearing, dry lining and solid walls (boards or blocks)	Dry lining walls based on wall lining boards (as above), earth blocks, wood fibre insulation blocks with cellulose honeycombs core, wood or gypsum fibre sandwich boards with flax core, compressed straw board, AAC	60 - 120

Table 25: Overview of investigated materials.

2.4 Adsorption of airborne pollutants

For adsorption tests according to ISO 16000-24 the chamber supply air was spiked with 1-pentanol, hexanal, butyl acetate, n-decane and α -pinene representing important indoor air contaminants in specified concentrations ranging between 200 and 500 $\mu\text{g}/\text{m}^3$, being higher than usually measured in indoor air to ensure a distinct determination of the reduction of the test chamber air concentration caused by the material.

The air-purifying performance of the material was determined by monitoring the difference of the inlet and outlet concentration of the test chamber. Tests were carried out for more than nine materials (six single earth plasters with and without aerogel addition, three multi-layer specimens composed of different materials).

2.5 Monitoring of real spaces

Monitoring data has been obtained from three different flats located in Berlin during August 2012 to September 2012 and during November 2012 to January 2013. The flats were either fitted out with natural or conventional building materials. Measurements were carried out with a miniature sensor and data logging system (iButton®) i-buttons, measuring external temperature, indoor air temperature and indoor and outdoor RH.

3. RESULTS

3.1 Water vapour sorption tests

Experimental results shown in Figure 1 and Figure 2 demonstrate that modified and pure earth plasters are characterised through an outstanding water vapour adsorption capacity, which is up to three times higher in comparison to gypsum plasterboards, as evidenced also in [9], [10]. Also earth dry boards, earth cellulose and wood fibre boards demonstrate exceptional moisture buffering potential. Gypsum fibre boards range between earth plasters and gypsum plaster boards.

Additional tests have been performed for other single layered materials, but also at component level (Figure 3.), investigating the potential of entire wall build-ups not only for the immediate moisture uptake but also their potential to provide a comfortable and healthy environment due to seasonal changes. Materials were tested in the most common thickness used for standard partition wall applications and although they differ, a direct comparison of specimens seems useful to identify the most capable materials and their combination. For the first cycle, results

are similar to those for wall linings boards, however in the consequent cycles and increase in moisture uptake is noticeable for wall constructed from natural building materials.

3.2 Emission tests

For all tested materials and material combinations low to very low emissions of formaldehyde, VOC and SVOC were determined. Only two of the 19 material combinations did not meet the strict requirements of the AgBB evaluation scheme. The radon exhalation from the earthen materials was low, first of all for earth plasters.

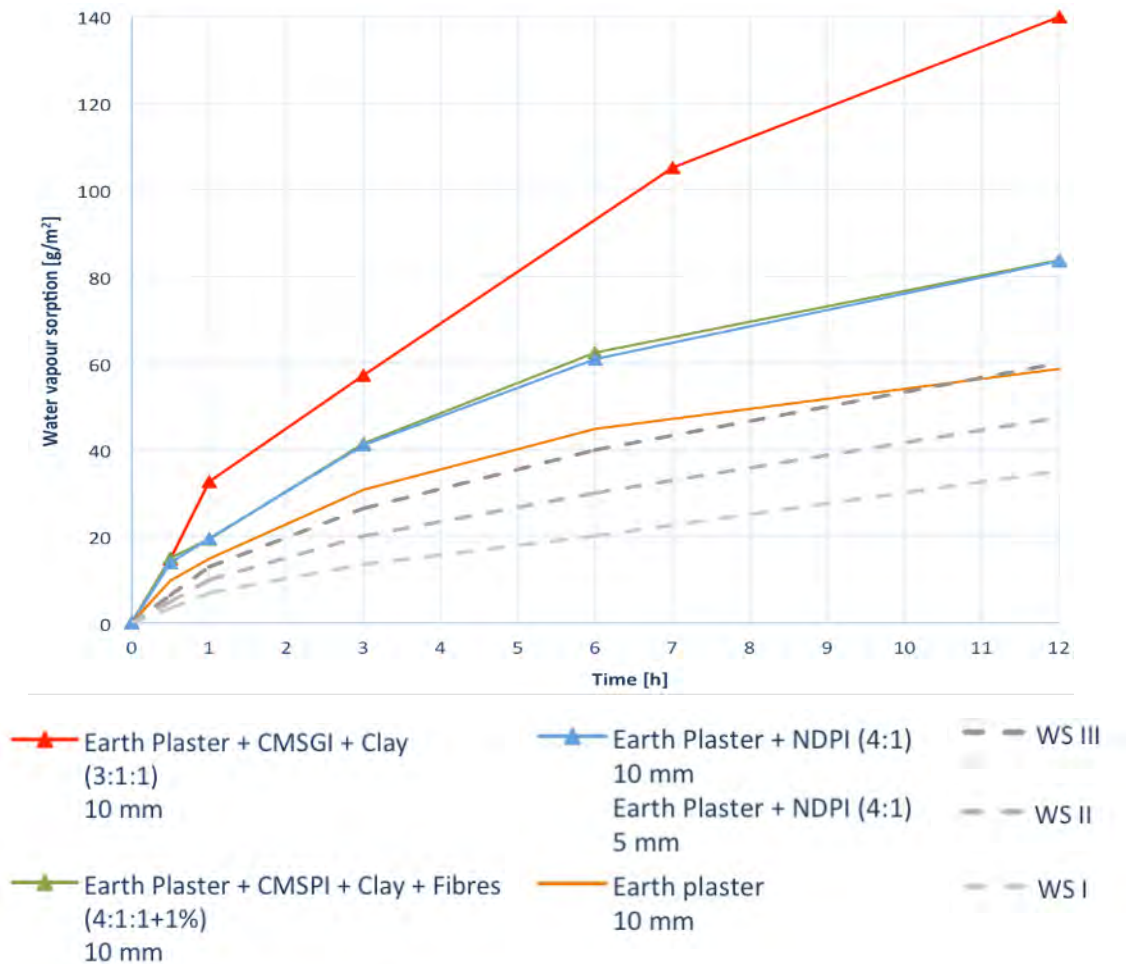

Figure 105: Results of water vapour sorption tests (DIN 18947) of modified and pure earth plasters (mix proportions by weight).

3.3 Adsorption of airborne pollutants

The results from adsorption tests demonstrated significantly different results for pure and modified earthen plasters in comparison to wall lining boards specifically designed for the adsorption of airborne pollutants. It could be shown that the addition of aerogels considerably increased the adsorption of the spiked contaminants. The best performance was observed for ND_{PI} and CMS_{GI} modified plasters similar to the water adsorption behaviour. In general, the polar compounds showed the strongest affinity for all the materials, the non-polar compounds have hardly attached.

3.4 Monitoring of real spaces

Figure 4 shows an extract from the monitoring of the results measured in a South facing living room in a flat fitted out with earth plasters and other natural building materials. RH levels were relatively stable during both periods. Indoor air temperatures were ranging always in comfortable levels, even though outdoor temperatures were above 33 °C. For the other flats, fitted out with conventional building materials relatively low humidity levels indoors during winter and higher indoor air temperatures during summer have been monitored.

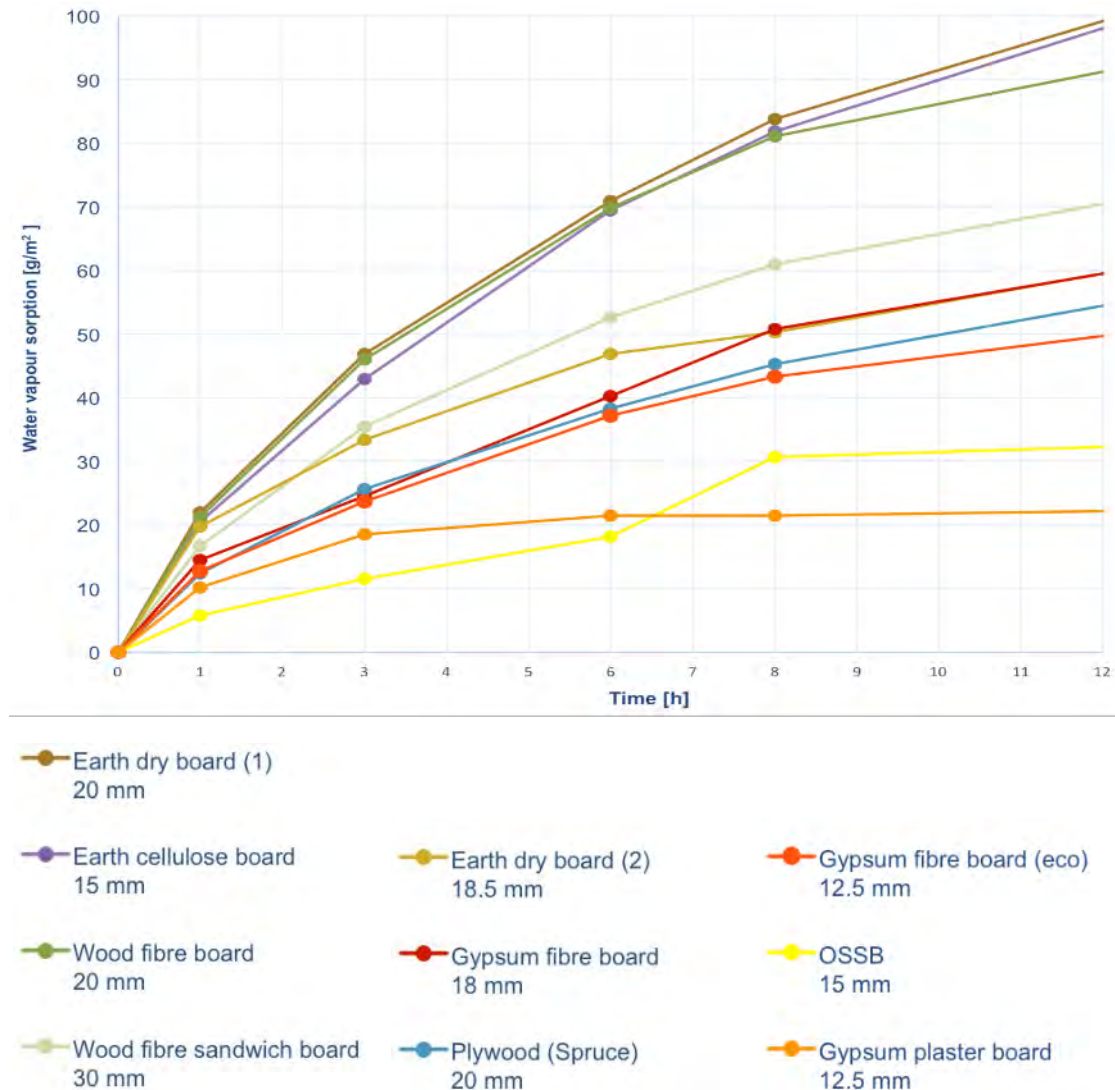

Figure 106: Results of water vapour sorption tests (DIN 18947) of wall lining boards

4. DISCUSSION

4.1 Water vapour sorption tests

Figure 1 shows the potential of aerogels to increase the moisture adsorption of earthen plasters. While the addition of aerogel type ND_{PI} (powder) increased the moisture adsorption only insignificantly, the specimen modified with aerogel type CMS_{GI} (granulate) demonstrated a significant increase of moisture adsorption (> 130%) after 12 hours in comparison to pure earth plasters. In addition the adsorption speed of the pure plaster was increased by approx. 100%. The addition of aerogel type CMS_{PI} (powder) achieved similar results compared to the specimen modified with aerogel type ND_{PI}, although a modified earth base plaster of 5 mm was applied, resulting in a higher plaster thickness in total. The outstanding results of the specimen CMS_{GI} enriched with aerogel granulate are most likely related to the structure of the aerogel itself. However, the amount of aerogel granulate that could be integrated into the mixture while meeting the requirements of DIN 18947 is approx. three to five times higher in comparison to both aerogel powder types, contributing significantly to the increased moisture adsorption.

The comparison of wall lining boards in **Figure 106** demonstrates the remarkably high moisture adsorption capacity of earthen dry and cellulose boards as well as wood fibre boards in comparison to standard gypsum plaster and gypsum fibre boards. For the earth based boards the clay minerals are mainly responsible for the outstanding adsorption results, whereas for the wood fibre boards it is their high porosity and respectively high surface area. The adsorption capacity of gypsum fibre boards ranges between earth plasters and gypsum plaster boards, offering robust and good solutions, when budget and construction time becoming key factors.

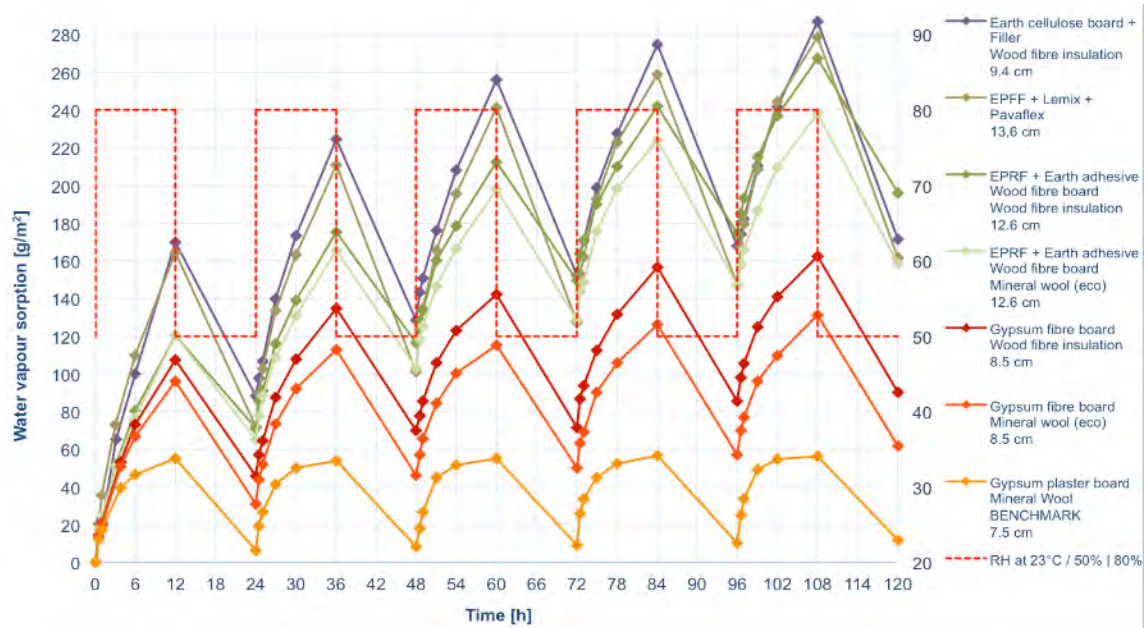

Figure 107: Results water vapour sorption tests (five 12 hour ad- and desorption cycles) of wall build-ups

Although this study is not exhaustive, it was observed that congeneric materials achieved very different results, which becomes obvious comparing the results of specimens earth dry board 1 and 2 (Figure 106). Similar tendencies, but even more distinct were observed for wood fibre and calcium silicate boards.

Material investigations at component level demonstrated the superior performance of natural building materials in comparison to conventional wall build-ups. Figure 107 demonstrates the impact of the earth cellulose board, pure earthen plasters in combination with wood fibre boards and wood fibre insulation or wood fibre flax sandwich boards in comparison to conventional wall build ups with gypsum plaster boards and mineral wool and clearly demonstrate that the insulation layer gets activated in case natural building materials were used, whereas mineral wool does not contribute to the adsorption at all.

The exact benefit on indoor air quality with regards to seasonal changes has to be determined, however it can be assumed that buildings fitted out with such walls, will benefit from evaporative cooling processes during hot summer months.

4.2 Emission tests

It is important to note that the AgBB criteria were developed for individual building materials. For the analysis of wall systems a different set of criteria would be more appropriate. The results can therefore only have an orienting character. Nevertheless it can be established that all other tested natural building materials were uncritical with respect to their emission properties and can be installed in buildings in almost any combination without concern.

4.3 Adsorption of airborne pollutants

The adsorption tests revealed that earth plasters have a good adsorption capacity, which was particularly increased by the addition of aerogel granulate but also by the addition of aerogel powders.

4.4 Monitoring of real spaces

Monitoring data shown in Figure 4 indicate that temperatures in a living area facing South range 6 – 7 °C below outdoor temperatures during hot summer days, which would support the assumption that earth plasters contribute to cooler indoor air temperatures during summer through evaporative cooling.

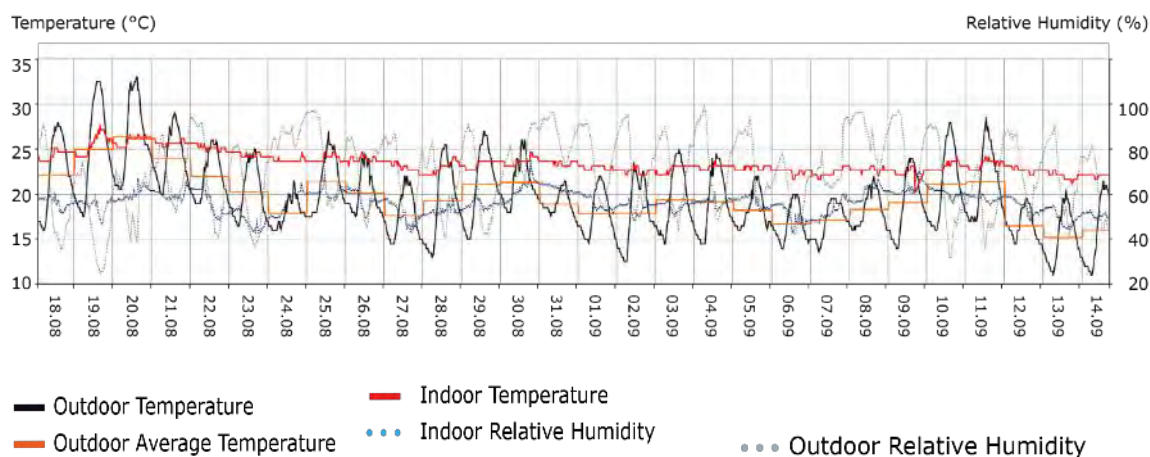

Figure 108: Monitoring results from a living room of a flat fitted out with earth plasters.

5. CONCLUSION AND OUTLOOK

Results presented in this study suggest that low emitting, natural building materials with enhanced hygroscopic properties such as earth plasters modified by addition of aerogels, wood fibre boards, wood fibre flax sandwich boards and strawboards in combination with natural ventilation offer robust alternatives to mechanical ventilation. Through application of materials able to adsorb airborne pollutants, indoor air quality can be enhanced further. Numerical simulations have started to translate current findings into hygrothermal models for the evaluation of indoor environment quality of residential buildings. The impact of air purifying materials has to be investigated further. The models will be used to predict suitability of materials for specific applications and damage-free constructions.

ACKNOWLEDGMENTS

This research study was made possible with the support of the European Union's 7th Framework Programme for research, technological development and demonstration under grant agreement no. 608893 ([H]house, www.h-house-project.eu).

REFERENCES

- [1] DIN 18947 (2013): Earth Plasters- Terms and definitions, requirements, test methods
- [2] prEN 16516, 2015. Construction products – Assessment of release of dangerous substances – Determination of emissions into indoor air.
- [3] AgBB, 2015. Health-related evaluation procedure for volatile organic compounds emissions (VOC, VOC and SVOC) from building products.
- [4] ISO 16000-part 3, 2011. Indoor air – Determination of formaldehyde and other carbonyl compounds in indoor air and test chamber air – active sampling method.
- [5] ISO 16000-part 6, 2011. Indoor air – Determination of volatile organic compounds in indoor and test chamber air by active sampling on Tenax TA® sorbent, thermal desorption and gas chromatography using MS or MS-FID.
- [6] Richter et al., 2013: Determination of radon exhalation from construction materials using VOC emission test chambers. *Indoor Air*, 23:397-405.
- [7] ISO 16000-part 24, 2009. Indoor air - Performance test for evaluating the reduction of volatile organic compound (except formaldehyde) concentrations by sorptive building materials
- [8] Klinge, A. (2013) Natural materials with high hygroscopic properties in naturally ventilated buildings, Master thesis, London Metropolitan University.
- [9] Minke, G. (2012) Handbook earth construction 8th edition. Staufen bei Freiburg: ökobuch press.
- [10] Eckerman W. and Ziegert C. (2006) Impact of earthen construction materials on indoor air humidity (October 2006).

The Study on Durability Testing of Heat-insulation Coating

CHEN Chien-fu^a, HUANG Yuan-chang^b, HO Ming-chin^c, LIN Yu-hsin^d, LEE Shin-ku^e

^a National Cheng-Kung University, Taiwan, jeffjeffchen78@gmail.com

^b Material and Chemical Research Laboratories, Industrial Technology Research Institute, Taiwan, huangyc@itri.org.tw

^c Architecture and Building Research Institute, Ministry of the Interior, Taiwan, 2010hmc@gmail.com

^d Architecture and Building Research Institute, Ministry of the Interior, Taiwan, hsin1020@abri.gov.tw

^e National Cheng-Kung University, Taiwan, sklee1015@gmail.com

ABSTRACT

Building energy consumption accounts for the proportion of total national energy consumption is quite large, such as the United States accounts for about 40% of total energy consumption, Taiwan for about 30%, and China for 25%. The current strategy to reduce the energy consumption of the building is not only to improve energy efficiency of equipment in buildings (such as the use of high-efficiency air conditioning, lighting, etc.), but also to develop heat insulation materials for building envelopes. This study aims to investigate the relation between optical performance and durability of the heat insulation paint. 23 kinds of heat insulation paint on the market were selected to conduct the natural exposure testing and artificial accelerated aging testing, respectively, and the solar reflectance and emissivity of all samples were measured and compared.

The experimental results indicate that the test samples could produce blue-green algae and dust on the surface due to water vapour in the atmosphere, so the solar reflectance of the samples would have more significant decline. After 2000 hours artificial accelerated aging testing, the emissivity and solar reflectance was reduced by 2% and 10%, respectively.

Keywords: heat-insulation coating, durability, accelerated weathering test, solar reflectance, emissivity

1. INTRODUCTION

All countries in the world are investing a lot of manpower and resources to solve climate change and global warming problems. Energy consumption of building sector accounts for a country's total energy consumption is quite large. For example, building energy consumption accounts for about 40% of the total energy consumption in the United States, Taiwan is about 30%, China about 25%. Therefore, reducing the building energy consumption and urban heat island effect have become one of the most important issues in the world. The current strategy to reduce the energy consumption of the building is not only to improve energy efficiency of equipment in buildings (such as the use of high-efficiency air conditioning, lighting, etc.), but also to develop high performance heat insulation materials for building envelope. It is well known that installation of heat-insulated materials, insulation coatings and energy-saving windows in building envelope has a significant effect on reducing energy consumption. Cool Roof with high thermal insulation performance to reduce the roof temperature, has been proven by the US Environmental Protection Agency. Using cool roof material has been selected as one of the effective strategies to reduce building energy consumption and urban heat island effect.

In the past three decades, many accelerated weathering techniques have been developed and utilized to meet the requirement of rapid development of new cool roof materials. These accelerated test methods attempt to accelerate natural environments with higher stress, e.g. greater intensity of UV radiation and elevated temperature without changing the failure mechanism. With these methods, the performance of cool roof material can be estimated in a short test period. Among those accelerated weathering test methods, a QUV chamber and a xenon arc chamber have been commonly used in industry and academia to test the weathering durability of the coatings. In these two chambers, UVA or filtered xenon-arc radiation and water condensation are provided alternately.

In Taiwan, insulation coatings are cheaper and easier to use than other construction materials. They have been widely used in residential building facades and roofs, industrial manufactory, schools and even farmhouses. However, the claims of thermal insulation properties and durability of the coating are not compulsory requirement, a product-related information between insulation performance and durability of commercially available insulation coating so far is not unified in Taiwan. Therefore, it is necessary to develop the durability testing methods for insulation coating in order to encourage consumers and architects to use more insulation paint. The natural

phenomena can cause degradation in polymer systems. The elements of most concern to paints are ultraviolet radiation, moisture, humidity, high temperatures and temperature fluctuations. Thus, it is important for scientists and paint producers to understand durability and expected lifespan of paint products. This study aims to investigate the relation between optical performance and durability of the heat insulation paint.

2. TEST METHOD

The 23 kinds of commercially available paints were collected in this study. The colors of these samples are white, grey, green, blue and red. These paints were coated on the cement brick and steel substrates by using an RDS coating bar (no. 22, coating thickness: 50.29 μm), respectively. The sizes of steel substrate are 10 x 10 x 0.05 and 7 x 14 x 0.05 (length, width, height, cm), and size of cement brick substrate is 10 x 10 x 1 (length, width, height, cm).

Samples were subjected to natural weathering, xenon-arc lamp artificial weathering and UV lamp accelerated natural weathering based on CNS 15200 and CNS 1183, respectively. The testing conditions of these three tests are listed in Table 1. The total duration of the test was 2000 hr. Before and after each 500 hr aging tests, the solar reflectance and emissivity on the coating surfaces of samples were examined. The solar reflectance and emissivity were carried out by means of spectrometer with integrating sphere, allowing characterizing the solar reflectance capability of the samples before and after the accelerated weathering tests. The solar reflectance and emissivity of samples are measured by using UV/VIS/NIR spectrometer and FTIR spectrometer based on ISO 9050 and 10292.

3. RESULTS AND DISCUSSION

Figure 1 to 3 show how the solar reflectance of 20 samples varied with time after 2000 hours weathering testing. All samples show reflectance reductions over time. During the first 500 hours there is a significant variability. The results of natural weathering testing indicated that the data after 500 hours are consistent with optical stability for these samples, with reflectance changes being due to dust accumulation in this study. It is because that Taiwan is located in the subtropical region with high temperature, humidity and high level of invisible pollutants such as dust and toxic aerosols in the air. After 2000 hours of natural weathering exposure the solar reflectance difference changed from 6.22 % to -11.62 % among white color samples, from -2.72 % to -4.20 % among grey color samples, from -0.75 % to -11.92% among green color samples, and from -3.57 % to -11.77 % among blue color samples. On the other hands, the results of two accelerated weathering tests indicated that there is no significant difference on solar reflectance with various colors of coatings.

test conditions	CNS 15200 : Methods of test for paints – Part 7-5: Long-period performance of film – Natural weathering	CNS 15200: Methods of test for paints – Part 7-6: Long-period performance of film – Artificial weathering and exposure to artificial radiation(Exposure to filtered xenon-arc radiation)	CNS 1183: Laminated glass 7.3Radiation resistance test
Irradiance	-	290 nm-400 nm	295 nm-360 nm
Water quality	-	conductivity < 2 $\mu\text{S}/\text{cm}$, a residue on evaporation < 1 mg/kg	-
Operating mode	-	Continuous run	Continuous run
Air temperature	27.7 °C	38 \pm 3 °C	45 \pm 5 °C
Black panel temperature	-	63 \pm 2 °C	-
Relative humidity	75.7 %	40~60 %	-
Wetting time, min	-	(18 \pm 0.5) min	-
Dry period, min	-	102 min	-

Table 1: Accelerated outdoor weathering, Quv, xenon arc exposure test conditions

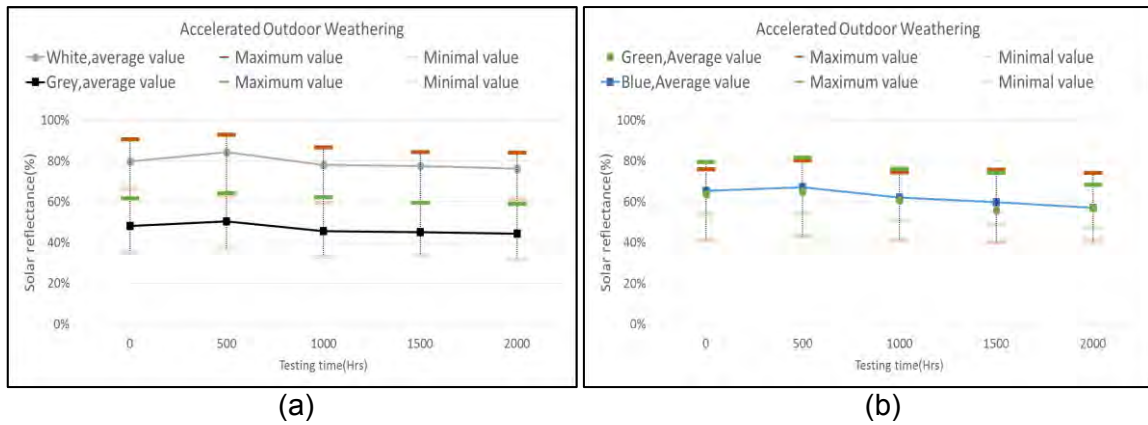

Figure 1: Solar reflectance versus time for different coating colors by natural weathering test: (a) white-and-grey (b) green-and-blue

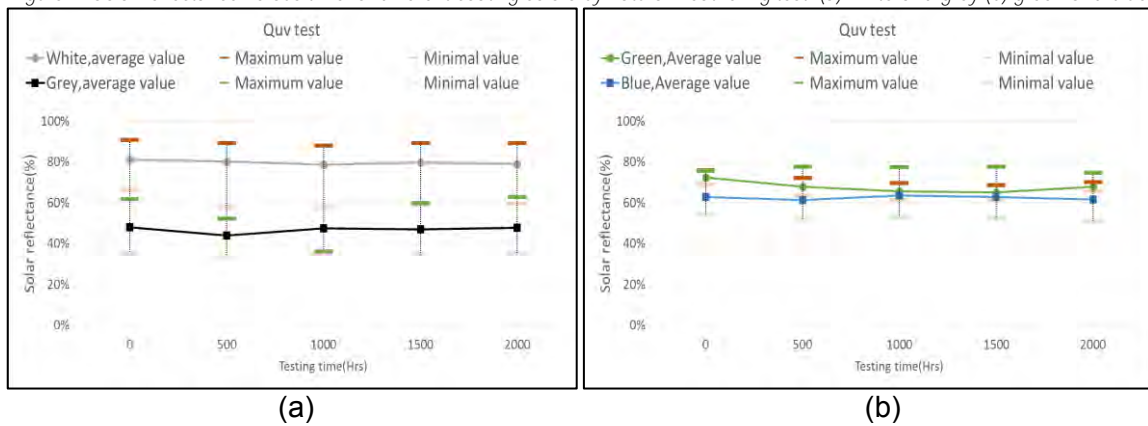

Figure 2: Solar reflectance versus time for different coating colors by QUV weathering test: (a) white-and-grey (b) green-and-blue

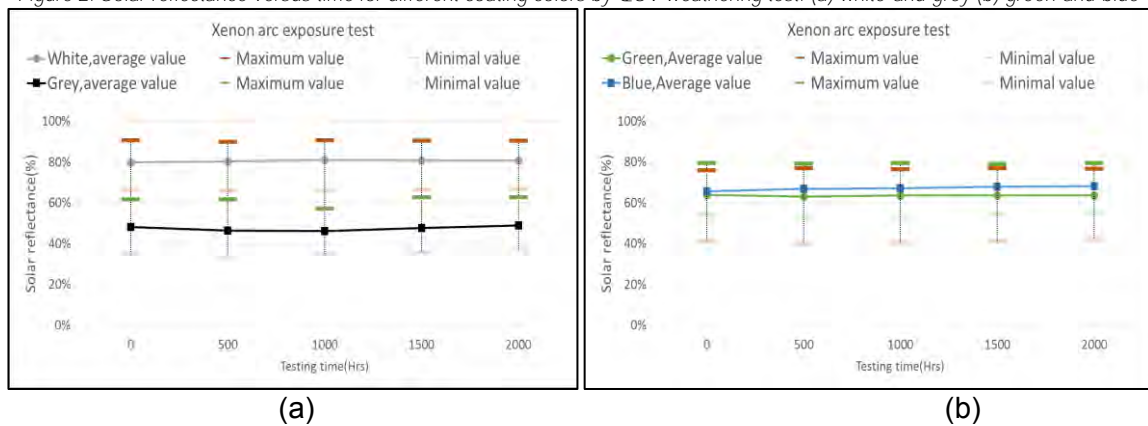

Figure 3: Solar reflectance versus time for different coating colors by xenon arc exposure test: (a) white-and-grey (b) green-and-blue

Figure 4 to 7 show the comparison between the solar reflectance and emissivity of samples before weathering test and those of after 2000 hours weathering test. The experimental results indicated that the difference between initial solar reflectance of steel plate samples and those after 2000 hours weathering test is in the range of $\pm 10\%$. The emissivity deviation of steel plate samples and cement brick is in the range of $\pm 2\%$ and $\pm 5\%$, respectively. In the natural weathering test, the maximum and average attenuation rate of solar reflectance is 18.89% and 8.38% for steel plate specimens. The maximum and average attenuation rate of the solar reflectance for cement brick specimens is 22.3% and 5.13%, respectively. In addition, the specimen subjected to outdoor natural weathering could produce algae on the surface due to moisture in the atmosphere, will lead solar reflectance to be more significant for the decline, but emissivity will not be affected by the dust in the air. It is worth noting in this study that natural weathering test can reflect the effect of actual climate and solar radiation conditions on the thermal insulation properties degradation of coating materials. It usually takes more than 2 years to get the results, not only wasting time, but also the different testing sites will also cause significant differences.

In the cases of xenon arc exposure and QUV weathering test, the most samples declines in reflectance by only 1.43 % and 3.62 % over the 2000 hours period. The results have been shown in Fig. 5 and Fig. 7 indicated that thermal emissivity declines similar to solar reflectance, but the declines are smaller in magnitude. According to the statistics data of sunshine duration in Taiwan, the area with the largest daily solar energy intensity is Chiayi area, and the UVA energy accounts for 1.23 % of the total solar radiation energy. Thus, 266 hours UV accelerated aging test is approximately equal to 1 year of Taiwan UV radiation exposure. We can deduce that a sample subjected to 2660 hours in xenon test chamber or accelerated weathering QUV tester equals 10 years of outdoor exposure. However, many of the factors, such as temperature, humidity, solar radiation, climate and test material that affect the aging of the paint should be considered. It is theoretically impossible to have a single magic number that you can multiply by weathering tester exposure hours to compute years of outdoor exposure.

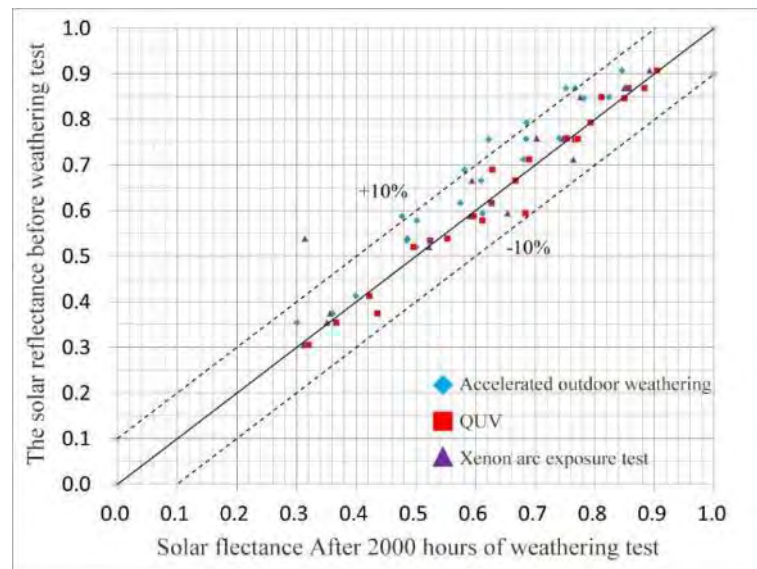

Figure 4: Comparison between the solar reflectance of samples before weathering test and those of after 2000 hours weathering test (steel plate)

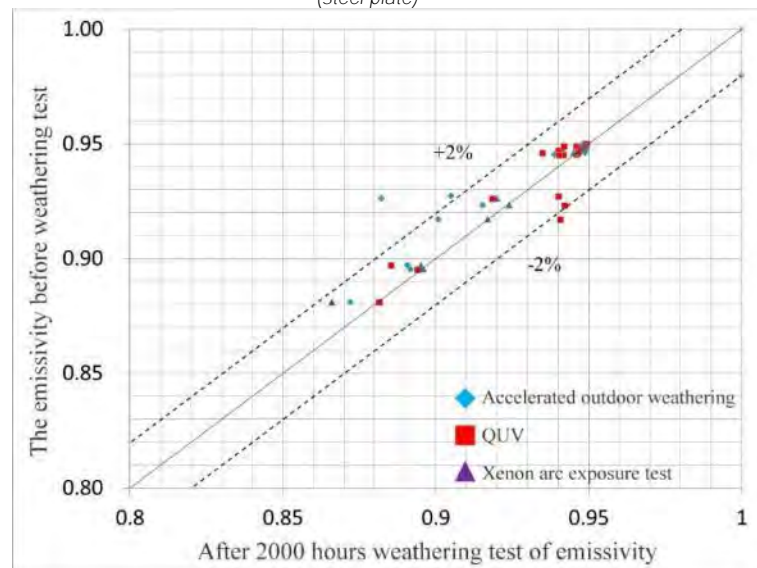

Figure 5: Comparison between the emissivity of samples before weathering test and those of after 2000 hours weathering test (steel plate)

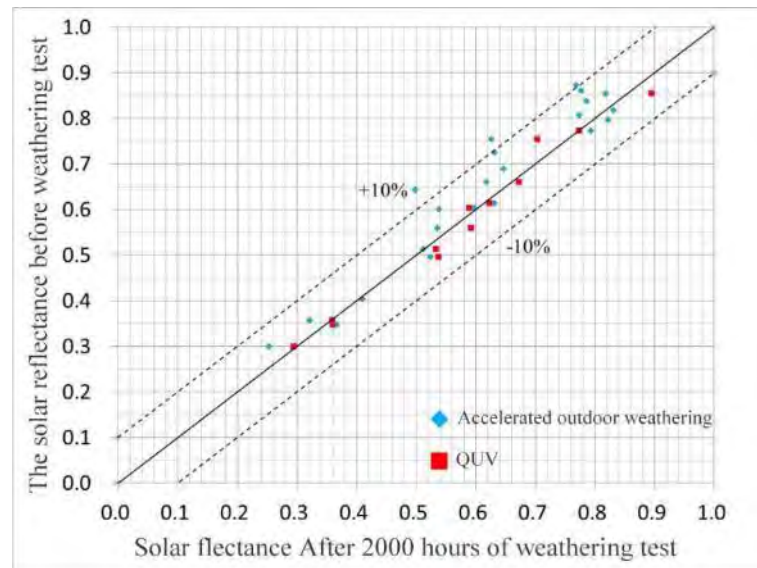

Figure 6: Comparison between the solar reflectance of samples before weathering test and those of after 2000 hours weathering test (cement brick)

4. CONCLUSION

In this study, 23 kinds of heat insulation paint on the market were selected to conduct the natural exposure testing and artificial accelerated aging testing, respectively, and the solar reflectance and emissivity of all samples were measured and compared. The research conclusions are described, as follows:

- The xenon arc exposure and QUV weathering test are suitable for evaluating the durability of paints in Taiwan. A sample subjected to 2660 hours in xenon test chamber or accelerated weathering QUV tester equals 10 years of outdoor exposure.
- In the natural weathering test, the average solar reflectance degradation are 8.38 % and 5.13 % for steel plate specimens and cement brick specimens, respectively. The specimen subjected to outdoor natural weathering could produce algae on the surface due to moisture in the atmosphere, will lead solar reflectance to be more significant for the decline
- In the cases of xenon arc exposure and QUV weathering test, the most samples declines in reflectance by only 1.43 % and 3.62 % over the 2000 hours period. The thermal emissivity declines similar to solar reflectance, but the declines are smaller in magnitude.

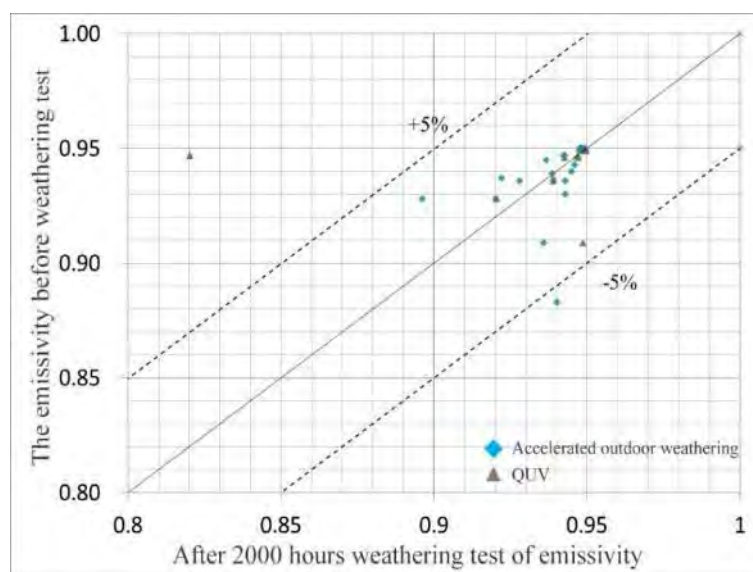

Figure 7: Comparison between the emissivity of samples before weathering test and those of after 2000 hours weathering test (cement brick)

ACKNOWLEDGMENTS

This study was supported by the Architecture and Building Research Institute, Ministry of the Interior of Taiwan under Projects PG10402-0042.

REFERENCES

- [1] Maria van der Hoeven, "Energy and Climate Change – World Energy Outlook Special Report." International Energy Agency, 2015.
- [2] Akbari, H., S. Konopacki and M. Pomerantz, Cooling energy savings potential of reflective roofs for residential and commercial buildings in the United States, *Energy*, Vol 24, pp391–407, 1999.
- [3] Yang X. F., Tallman D. E., Bierwagen G.P., Croll S.G. and Rohlik S., Blistering and degradation of polyurethane coatings under different accelerated weathering tests, *Polym. Degrad. Stab.* Vol. 77, pp103–109, 2002.
- [4] CNS Standard 15200 7-5. **Methods of test for paints – Part 7-5: Long-period performance of film – Natural weathering**, 2013.

Utilizing Palm Rachis for Eco-Friendly and Flexible Construction in Egypt

Yasser MANSOUR^a, Hamed ELMOUSLY^b, Eman Atef DARWISH^c

^a Department of Architecture, Ain Shams University-Cairo, Egypt, yasser_mansour@eng.asu.edu.eg

^b Department of Architecture, Ain Shams University-Cairo, Egypt, cdsilt@idsc.gov.eg

^c Department of Architecture, Ain Shams University-Cairo, Egypt, eman.atef@eng.asu.edu.eg

ABSTRACT

Date Palm rachis, known as palm leaves, is one of the most abundant pruning wastes that were used traditionally in simple and cheap sheathing in rural areas and Eco-Lodges Egypt and the Middle East. However, due to the natural diversity of Palm Rachis members and the shortage of their mechanical details information, most of the previous palm rachis-based structures failed to cover wide spans while sustaining high flexibility in form and function in the design of multifunctional public halls, as the researches had to depend entirely on onsite decisions due to the absence of the pre-construction structural analysis data. This paper aims to study Palm Rachis as an innovative building material that can be used for constructing eco-friendly and cheap multi-purpose structures that are characterised by form and function flexibility, structural integrity and ease of construction.

This paper suggests using palm rachis to build arched space truss system that is characterized by simplicity in joints, flexibility in form and function and high structural integrity. This aim is served firstly by investigating the previous examples of Palm Rachis structures, then designing an 8m span structural system using Palm Rachis **that's structurally analysed using a scaled physical model and digital analysis using SAP2000 in order to address** the potentials of the system. This system prove to be structurally safe, flexible, simple and highly qualified for further structural analysis to identify the structural details in depth. This paper is presented to natural building materials researchers, natural builders and activists and Environmental Tourism stakeholders.

Keywords: palm rachis, affordable housing, structural simulation

1. INTRODUCTION

Date Palm residues, shown in Figures 1, are one of the most important agricultural residues that are used traditionally in cheap and rural construction in Egypt (Elmously, 2001). Palm Rachis occupy the largest percentage of the pruning residues quantities of palm trees, with 9.75 ton/ year per palm and 105.3 thousand ton/ year in Egypt which counts for 32% of the total residues (Elmously, 2001). Therefore, Date Palm Rachis became the main renewable resource of natural sheathing materials traditionally in cheap and rural construction in Egypt as shown in Figure 2. In addition, Local contemporary Eco-Lodges utilize Date Palm Rachis, to emphasize the cultural originality of such Environmental Tourism oriented projects. Adrere Amellal, an Eco-Lodge in Siwa Oasis in Egypt, utilized palm rachis in the sheathing of the palm trunk-based roofs as shown in Figure 3 (Alamuiddin, 2001). However, the utilization of Date Palm Rachis did not develop as the main structural material of rural construction instead of imported timber in Egypt, due to the natural diversity of Palm Rachis members and the missing mechanical properties of Palm Rachis required for the structural analysis prior to construction.



Figure 109: Date palm main parts (Asdurabali et al., 2015)



Figure 110: Palm trunk and rachis used for traditional roofing In Sinai. (Ibrahim, 2010)



Figure 111: Roofing by palm rachis adreere amellal eco-lodge(Alamuddin, 2001)

Therefore, previous researchers such as (Piesik, 2012) and (Peter Sheehan et al., 2015) had to depend entirely on building physical models in order to design the members structurally according to the onsite structural behaviour of the members. The systems had to depend on strict grids and internal vertical supports according to the onsite behaviour and to ensure safety during the building process. This decreased the structural integrity and flexibility of the form and function of the resulting systems. In addition, unpredictable forces such as wind can be very critical that they can cause the structure to fail later, as they were not taken in consideration.

Thus, the knowledge gap lies within examining the structural safety of date palm rachis-based structural systems in the pre-construction phase without depending on onsite decisions. This paper aims to design palm rachis-based structures that are firm, simple and cost-effective while maintaining the aspects of ease of construction and flexibility in form and function.

This aim is served firstly by investigating the previous examples of Palm Rachis structures, then designing a structural system using Palm Rachis that is structurally analyzed using a scaled physical model and digital analysis using SAP2000 in order to identify the structural potentials and limitations of the system.

2. PREVIOUS EXPERIMENTS OF UTILIZING DATE PALM RACHIS IN CONSTRUCTION

2.1 Arched date palm rachis bundles

(Piesik, 2012) made the first attempt to construct using Arched Palm Rachis Bundles in order to exploit the curved nature of Date Palm Rachis in UAE as shown in Figures 4, 5 and 6. The vault was constructed using arched bundles of Palm Rachis with circular cross section of 20cm diameter to cover a span of 13 m. Every arch was planted 30cm deep in wet soil, and then supported by 4 palm trunks on intervals of 3.25 m approximately and ropes were used to bend the bundles and tie them to the palm trunks. The covering was made using a woven mat **over the Rachis purlins that are arranged and tied to the arches. However, it's criticized of using internal trunks** every 3.25 m which can interrupt the continuity of the activities inside.



Figure 112: The vault during construction (Piesik,2012)



Figure 5: Internal columns (Piesik, 2012)



Figure 6: Rope based connections.(Piesik,2012)

2.2 Cross arched palm midribs bundles

An improvement from the vault in (Piesik, 2012), (Sheehan et al., 2015) constructed a food shelter in Al-Ain UNESCO world heritage site in UAE using cross arched Palm Rachis Bundles as shown in Figures 7 and 8. Two perpendicular 8x8m grids of arched Palm Rachis bundles were built where the load of each arch is totally distributed on the perpendicular grid of arches (Sheehan et al.,2015). The arches ends are planted 30cm deep in concrete foundation boxes and ropes were used to ensure the stability of the overlaps of the arches. For covering, light tent fabrics were used and fixed to basic nodes to make a tent-like form (Sheehan et al., 2015). However, the future extensions are limited to repeating whole modules, while at the same time. In addition, the tent-like form that was used due to the double curvature in the structure is distant from the majority of the rural context in Egypt.



Figure 7: Cross arched module (Sheehan et al., 2015)



Figure 8: Tent-like covered module (Sheehan et al., 2015)

2.3 Objectives of the suggested system

According to the discussed literature review, the new suggested system in this paper should be characterized of the following:

- Structural integrity: covers the widest span that is capable to host multifunctional halls firmly.
- Form and function flexibility: free of strict grids and internal supports that may interrupt the continuity of the indoor functions.
- Simple yet Durable connections: non-dependent solely on ropes for connections, as ropes will be the weakest points of the system due to their low climatic and structural durability

3. METHODOLOGY

3.1 Mechanical properties measurement

The measurements were taken according to the European Standard EN 408: 2003, which is concerned with the determination of the mechanical properties of Structural timber and glued laminated timber. The 2x2 cm approx. samples were taken from the mid section of the 7 meter-tall Baladi Date Palm Rachis brought from the Nile Valley in Minya Governorate. The measurements took place in the Metalloid Laboratory in Faculty of Engineering, Ain Shams University, Egypt.

3.2 Digital structural simulation

Digital simulation is used to identify the structural limitations of the system and to examine multiple spans using SAP2000. SAP2000 is a common structural program in Egypt to analyze simple and complicated structural cases using predefined properties of concrete and steel. Therefore, the required properties are defined manually in the program to calculate axial forces and bending moment on members' sections.

4. DISCUSSION

According to the systems discussed earlier in the literature review, the cross arched bundles interdependence (Sheehan et al., 2015) was the main solution to the need of intermediate columns that were used in the vault (Piesik, 2012). This was accomplished by turning the whole structural mesh from a planar 2 dimensional arch into a 3 dimensional structural dome. This solution originally imitates the main concept of Space Trusses.

4.1 Structural development of arched palm rachis bundles

Space truss is used to cover wide spans using interacting light members without disturbing internal supporters (Ambrose and Tripney, 2012). Space trusses originated from plane grid truss that would have high bending moment when used to cover wide spans. This moment is supported by increasing the cross sections of the members or by adding another grid, thus turning into a 3 dimensional truss i.e. space truss (Lan, 2005). However, the design of joints would be critical while using the naturally varied Palm Rachis bundles.

The solution is to depend on friction in order to drive the ends of intermediate bracings into the bundles without any dependence on ropes or metal plates. The arched bundles will have to transform all the bending moment into compression forces while decreasing tension forces as much as possible. Therefore, the arches ought to take the pure compression form i.e. a parabola. The compression forces in the parabolic arch allow using friction connection,

as the tension forces resulting from bending that would dismantle the arch range from minimal to none (Ambrose and Tripney, 2012). Therefore, Parabolic Arched Space Truss, shown in Figure 9, is the chosen structure system to design and simulate using Palm Rachis bundles.

4.2 Suggested structural system

The suggested structural system, as shown in details in Figures 10 and 11, was assigned to cover the span of 8m with 6m axis to axis spacing as an initial span that would be modified to understand the limitations of the system according to the simulation results. Additional Structures were added to examine the versatility of the form and function. The cross sections of the arches were assigned to be 20 cm dia., according to the previous works of (Piesik, 2012) and (Sheehan et al., 2015).

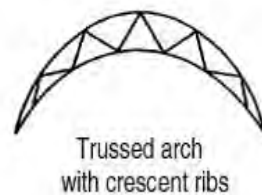

Figure 9: Trussed arch with crescent ribs (Ambrose and Tripney, 2012)

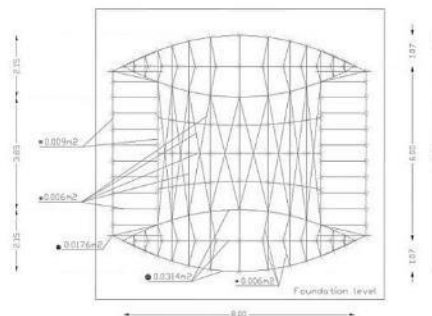

Figure 10: Plan and cross sections of the system (Author)

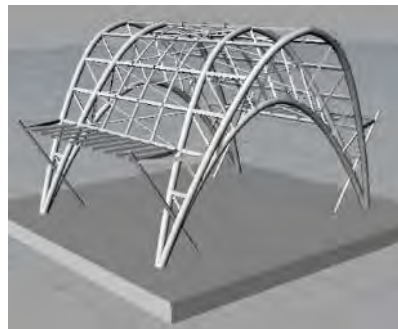

Figure 11: 3D model for the system by rhinoceros 5 (Author)

In addition, a physical model was made by the researchers in order to study the close details of the system, as shown in Figures 12, 13 and 14. The 1:20 scale was chosen due to the available space and manpower limitation. The used material is dried Palm Rachis that were sliced as thin as possible to imitate the true members, as each member on the model imitates 4-6 members in real life.



Figure 12: The main arches of the space truss (Author)



Figure 13: Adding the space truss bracings using friction connections (Author)



Figure 14: The final shape of the physical model (Author)

4.3 Mechanical properties measurements

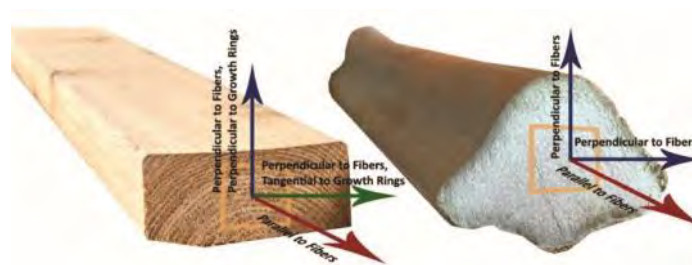

Figure 1113: Comparison of the material axes between timber and palm rachis (Author)

In terms of engineering elastic models, Anisotropic Lignocelluloses structural materials such as wood are usually treated as an orthotropic materials, supposing in the linear orthotropic model that there are 3 perpendicular planes of symmetry in the material, and in the same time the shear behaviour is supposed to be independent of the extensional behaviour and temperature change (Mascia and Lahr, 2006).

The tangential and radial directions in wood are identified according to their intersection with the annual growth rings as shown in Figure 15 (Green et al., 2010). However, due to the lack of growth rings in palm rachis, the mechanical properties which are perpendicular to fibres are similar in both tangential and radial directions.

The perpendicular modulus of Elasticity was measured using compression (EN 408-2003) as shown in Figure 16. The longitudinal modulus of Elasticity was measured using bending (EN 408-2003) as shown in Figure 17. The

Shear modulus was calculated by the Variable Span Method using flexural test (EN 408-2003) as shown in Figure 18. Due to the limitations of the laboratory, the Poisson Ratios and Stresses were assumed according to the properties of Spruce Wood (Green et al., 2010) that was proven to be close to Date Palm Rachis (Elmously,2001). The mechanical properties are shown in Table 2.



Figure 1114: Compression test perpendicular to fibers (Author)



Figure 1115: Bending test -shear modulus via variable span method (Author)



Figure 1116: Bending test -longitudinal modulus of elasticity (Author)

Property Description	Value
Longitudinal Modulus of Elasticity - E_L	10287.8 MPa
Tangential Modulus of Elasticity- E_T	105.45 MPa
Radial Modulus of Elasticity- E_R	105.45 MPa
Longitudinal- Radial Poisson's Ratio - V_{LR}	0.372
Longitudinal- Tangential Poisson's Ratio - V_{LT}	0.467
Radial- Tangential Poisson's Ratio - V_{RT}	0.435
Longitudinal-Radial Shear Modulus- G_{LR}	109.2 MPa
Longitudinal-Tangential Shear Modulus- G_{LT}	109.2 MPa
Radial-Tangential Shear Modulus- G_{RT}	39.05 MPa
Mass per Unit Volume	0.95 gm/cm ³
Effective Yield Stress	45 MPa
Effective Tensile Stress	54 MPa

Table 26: Mechanical properties of date palm rachis : EN408-2003 (Moisture Content=7%) (Author)

4.4 Digital simulation

The materials properties were defined manually into SAP2000, then the values of Normal Forces and Bending Moments due to Dead Loads and Wind Loads combined were calculated in order to check the safety of the system while covering variable spans as shown in Table 2. The connections were assigned to be firm friction connections and the bundles were assigned to be fully coherent.

The structural check was based on Allowable Stress Design method (ASD), where the actual loads are used in structural calculations, because of the lack of safety codes and adjustments of Palm Rachis as a relatively new structural material. The structural check used the combined stress interaction (CSI) equations, which is used for members such as wall studs and roof truss members that experience bending stress in addition to axial loading in wooden structures (Residential Structural Design Guide, 2000). Combined actual bending and axial compression design is checked

as shown in Eq. 1:

$$\left[\frac{f_a}{F_a}\right]^2 + \left[\frac{f_b}{F_b}\right]^2 \leq 1$$

Equation 1

where f_a is the actual axial load (compression or tension), F_a is the allowable axial load (compression or tension), f_b is the actual bending load and F_b is the allowable bending load.

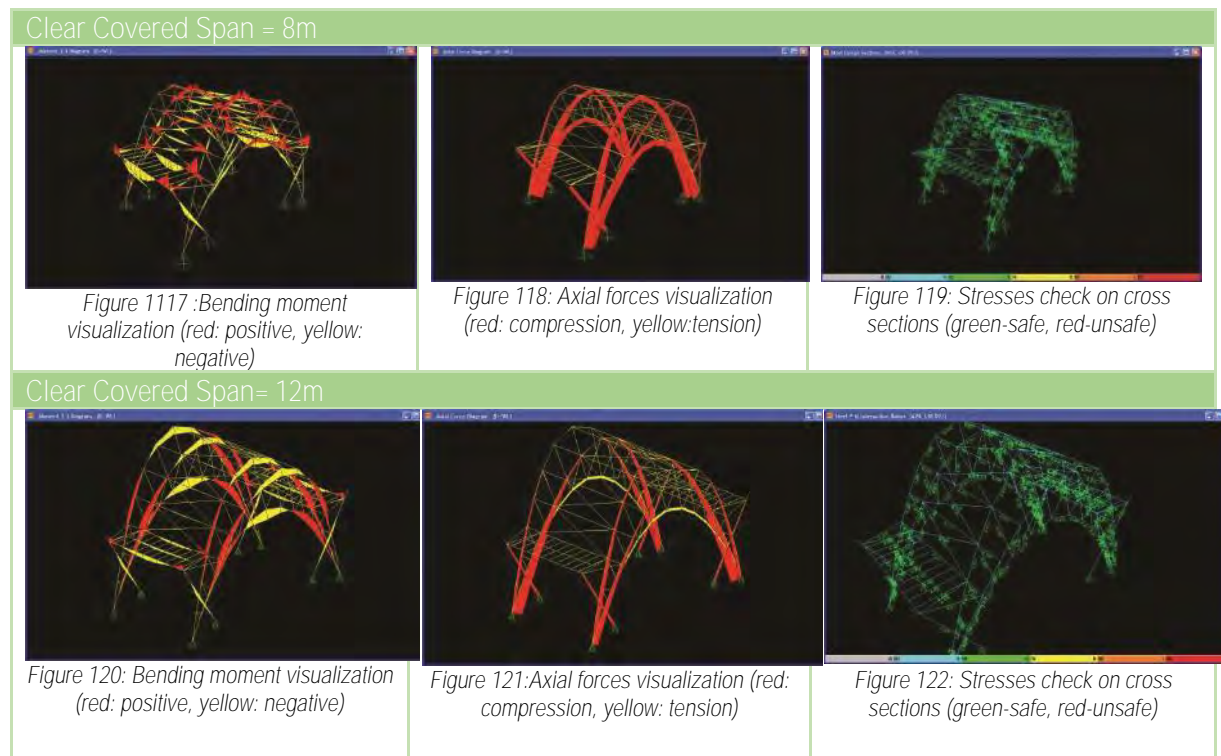

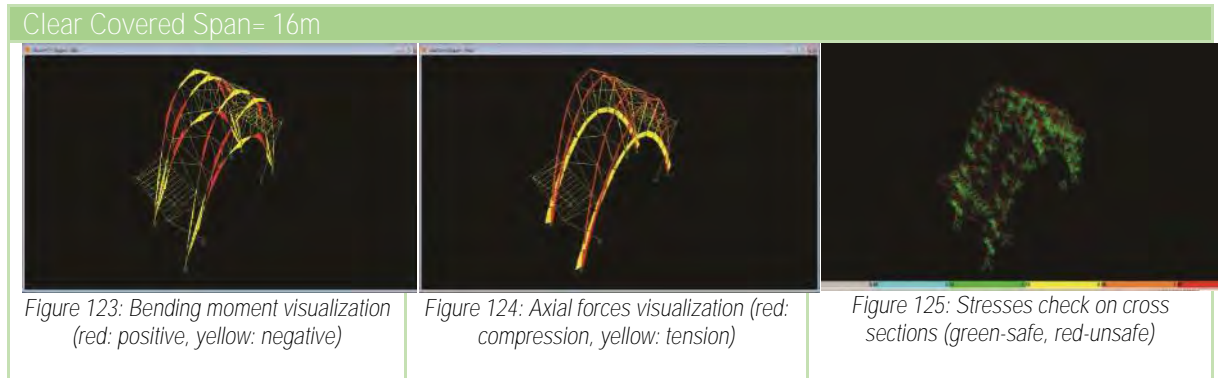

Table 27: Results of structural simulation while covering various spans (Author)

The results as shown in Table 2 from the digital structural simulation showed that the system is safe while covering 8 and 12m. However the system failed at covering 16m due to high buckling at the cross sections of the bracings.

5. CONCLUSION

Date Palm Rachis is a promising material in terms of construction. In this paper, several previous experiments of building using Date Palm Rachis were reviewed. The experiments showed the high potential of the material. However, the systems were not characterised by high flexibility in form and function. Therefore, the parabolic arched space truss structure was designed using Date Palm Rachis to introduce a versatile structure that can be used to cover multifunctional halls and public activities.

The scaled physical model was constructed in order to predict the ease of construction and durability. Then the mechanical properties were measured in order to define the material in SAP2000. The results from the digital simulation showed that the system is highly recommended to cover spans up to 12m. In addition to that, the majority of the normal forces along the members are compression, which means that friction connections are suitable for the structure as long as the used arches are parabolic.

This system can be used for multifunctional public halls such as markets, sport halls and recreational areas. This system provides the necessary flexibility, simplicity of connections and structural integrity, while depending on simple construction utilizing the highly available Date Palm Rachis.

These findings open the door for further structural studies regarding the spacing between the arches, the intensity of the bracings, the coverings and protection against fire and degradation.

REFERENCES

- [1] Ambrose, James and Tripney, Patrick, Building Structures, 3rd edn (London, UK: John Wiley & Sons, 2012).
- [2] **Asdrubali, Francesco; D'Alessandro, Francesco and Schiavoni, Samuele**, 'A review of unconventional sustainable building insulation materials', Sustainable Materials and Technologies, 4 (2015), 1-17.
- [3] Elmously, Hamed, 'THE INDUSTRIAL USE OF THE DATE PALM RESIDUES AN ELOQUENT EXAMPLE OF SUSTAINABLE DEVELOPMENT', in International Conference on Date Palms (Cairo, Egypt: United Arab Emirates University, 2001), II, 866-86.
- [4] Green, David and Winandy, Jerrold, and David Kretschmann, 'Mechanical Properties of Wood', in Wood Handbook: Wood as an Engineering Material, 100th edn (Wisconsin: United States Department of Agriculture, 2010), p. Chapter 5.
- [5] Ibrahim, Nashwa, Appropriate Building Patterns for Saint Catherine, Egypt (Cairo, Egypt: Egyptian Earth Mahdavi, Saeed; Kermanian, Hossein and Varshoei, Ali, 'Date Palm Properties', BioResources, 5(4) (2010), 2391-403.
- [6] Lan, Tien T., 'Space Frame Structures', in Handbook for Structural Engineering, ed. by W. Chen, 2nd edn (Tokyo, Japan: CRC Press, 2005), pp. 24-50.
- [7] Mascia, Nilson T., Lahr, Francisco A., 'Remarks on Orthotropic Elastic Models Applied to Wood', Materials Research, 9 (2006), 301-10.
- [8] Plesik, Sandra, Arish: Palm-Leaf Architecture, 2nd edn (London, UK: Thames & Hudson, 2012)

- [9] Residential Structural Design Guide: 2000 Edition (Washington, US: U.S. Department of Housing and Urban Development: Office of Policy Development and Research, 2000).
- [10] Sheehan, Peter et al, 'A paradigm of agro-ecosystems of date palm oases understood in the wider context of economic and cultural ecosystems through transfer of knowledge and technology in the desert regions.', in UNCCD Scientific Conference (CANCUN, MEXICO: Research Gate, 2015), 3rd..

Bamboo for the 21st Century

Martin TAM Tin-fong^a

^a Able Mart Limited, Hong Kong SAR, martinttam@gmail.com

ABSTRACT

Taking forward the COP 20 Resolution (2014 Lima, Peru) to adopt Bamboo as a strategic resource to combat global warming, detailed studies in multiple directions must commence without further hesitation.

Our World have always strived to understand the practical needs of our nations and our regions, and is dedicated to the advancement of society through education and research. The last 15 years have seen a dramatic growth in the variety of commercial bamboo products such as flooring, laminated furniture, building panels, high quality yarn **and fabrics, activated carbon and bamboo extracts. Bamboo's appearance, strength and hardness combined with** its rapid growth cycle and capacity for sustainable harvesting make it increasingly attractive for advancing socio-enviro-economic growths. The market outlook for bamboo is strong, and international trade runs rampant.

These recent developments have created new opportunities for bamboo markets to be targeted for rural development and poverty reduction. In particular, the emergence of near-source value-addition in modern supply **chains increases the sector's potential economic impact on poor rural communities.**

This presentation attempts to cover the essential aspects and considerations necessary to support the bamboo revolution/revival from plantation to harvesting, manufacturing to fabrication, marketing to product readiness, in all aspect of human living, from food to travel, from built environment to clothing

The search is on, to move human activities along the Bamboo Age

1. INTRODUCTION

The effects of global warming are induced by social changes and environmental oversight (directly or indirectly) by human emissions of greenhouse gases. There is a scientific consensus that climate change attributes human activities as the primary driver. Many impacts of climate change have already been observed, including glacier retreat, changes in the timing of seasonal events (e.g., earlier flowering of plants), and changes in agricultural productivity.

Future effects of climate change will vary depending on climate change policies and social development. The two main policies to address climate change are reducing human greenhouse gas emissions (climate change mitigation) and adapting to the impacts of climate change. Geoengineering is another policy option.

The United Nation's global climate summit 2014 in Lima, Peru, kick-started the tackling of greenhouse gas emissions and 40 countries agreed that Bamboo is a strategic resource against climate change in the Lima, Peru Convention on Climate Change COP20.

In 2015, the Paris Climate Change Agreement signed by 196 countries, for the first time, developing and developed countries have agreed on a common agenda to reduce greenhouse gases, limit temperature rises to two degrees (or 1.5 degrees) of pre-industrial levels, and achieve a zero-carbon future.



Global Warming



Natural Ecological crisis



Extreme weather

1.1 What is bamboo?

Bamboo is one of the fastest growing plants in the world, it grows 1030 mm per day & reaches full height in 4-6 months, and it has unique rhizome-dependent system. The root system can extend up to 100km/ha and live for a hundred years.

There are over 70 categories and 1250 species of bamboo plants worldwide. China is abundant in bamboo species, with over 40 categories and 500 types of bamboo plants, of which the economic bamboo accounts for over 50 categories.



Figure 1: Distribution of bamboo in the world

There are about 70 Genera, 1000 species (not including herbaceous bamboos growing in Latin America)

Source: International Network for Bamboo and Rattan (INBAR)

2. WHAT MUST WE DO?

2.1 Fight the climate change

- Bamboo absorbs relatively more CO₂ than trees, thereby releases relatively more O₂ than trees
- Bamboo is a great natural carbon sink - Fast biomass generation and Fast re-growth even after regular harvesting

2.2 Bamboo indirectly reduce greenhouse gas emissions by:

- Producing bamboo products usually requires lower energy than comparable fossil-fuel based products
- Selectively harvested bamboo provides woody biomass
- Transformed into durable products with long life spans increase terrestrial carbon sink

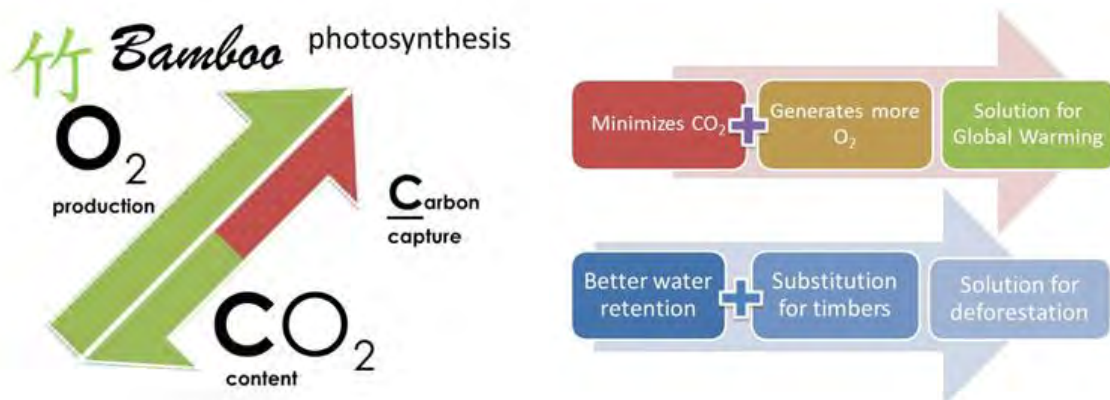

2.3 Other benefits of bamboo

- Improves the Indoor Air Quality (IAQ) within and around buildings and structures, especially as it relates to the health and comfort of building occupants;
- Positive impacts on natural environment and human health;
- Uses renewable resources more efficiently and wisely;
- Reducing the pace of deforestation, indeed increase forests via bamboo plantations;
- Relieving global warming and natural ecological crisis;
- **“Natural Oxygen Bars”;**
- 2 times negative oxygen ions concentration comparing to evergreen broad-leaved forest (ChaShanZhuHai National Forest Park in Chongqing city);
- Bamboo leaf can capture 4 to 8 g/m of dust;
- Bamboo belt reduce noise (10 to 15 dB by 40m wide belt);
- For climate change mitigation
 - Rapidly sequesters carbon, avoids fossil fuel use
 - Offers a highly renewable source of biomass energy – as a substitute for wood fuel and fossil fuels
- For landscape restoration
 - Rapidly restores degraded lands in the tropics
 - Thrives on problem soils and steep slopes that are unsuitable for other crops, e.g. HK Tuen Mun highway.
 - To date, millions of hectares of degraded lands have been restored with bamboo, many millions more can benefit
- For adaptation
 - Protects communities from natural disasters as a part of sustainable forestry & agro-forestry systems
 - Rapid growth allows frequent harvesting, helping farmers respond adapt changing weather patterns

Bamboo is the GREEN material to save our planet!

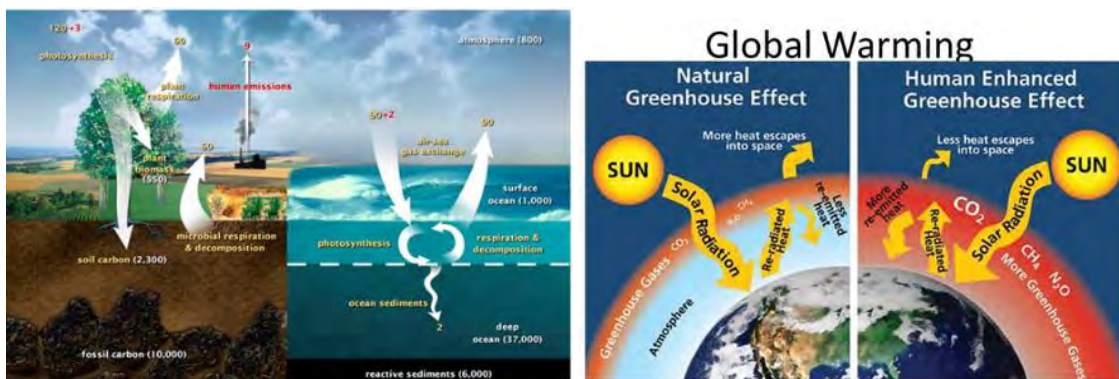

Figure 2: Movement of carbon between land, atmosphere and greenhouse gas effect due to increased CO₂

3. USE AND UTILIZE EXTENSIVELY

3.1 Why use bamboo?

- Bamboo can be harvested within 4 - 6 years
- Extraordinary physical characteristics
- Suitable for all types of structures and constructions
- Light building material for easy transportation & storage

3.2 Facts to be noted

- Are processed and compressed with chemical-based glue
 - Formaldehyde out-gassing, especially bamboo product made with low quality glue
- Durability
 - Bamboo flooring last 30 – 50 years (while some solid hardwood last 125 years or longer)

3.3 Economical

Bamboo also widely known as resources that empower the poor. They already play a critical role in supporting poverty alleviation contributing to livelihoods of millions for people worldwide.



3.4 Architecture

3.4.1 As a building material

- Often referred to as the poor man's timber,
- Becoming increasingly popular among Western architects and engineers
- A major building material in many countries, particularly in Asia, Africa and South America
- Well Known for its strong characteristics, light weight and flexible properties
- Can be used for almost all parts of houses, including posts, roofs, walls, floors, beams, and trusses

3.4.2 Mechanical properties

- In general, bamboo is stronger than wood in bending strength, compression strength parallel to grain and is similar in shear strength parallel to grain
- The strength of bamboo in grain direction is extremely high, especially Modulus of Rupture and Modulus of Elasticity. It might be suitable as the raw material for such products as oriented structural boards which bears unidirectional load
- Bamboos have low shear strength parallel to grain. The bamboo veneers can be peeled from straight culms of a thick-walled bamboo species



Rising Poles

Source:
http://share.iclient.ifeng.com/sharenews.f?aid=cmpp_040740044439911&from=timeline&isappinstalled=0



ZCB – Bamboo Pavilion

By Team from CUHK School of Architecture

The ZCB Bamboo Pavilion is a public event space built for the Construction Industry Council's Zero Carbon Building (ZCB) in the summer of 2015 in Kowloon Bay, Hong Kong. It is a four-storey-high long-span bending-active bamboo gridshell structure with a footprint of approximately 350m² and a seating capacity of 200 people.



It is built from **475 large bamboo poles** that are bent onsite to shape the structure and that are hand-tied together with metal wire using techniques based on Cantonese bamboo scaffolding craftsmanship. The shape is a large diagrid shell structure that is folded down into three hollow columns. These columns rest on three circular concrete footings. A tailor-made white tensile fabric is stretched over the structure and is brightly lit from inside the three legs.



Address:
Truong Sa Road, Ngu Hanh Son District, Danang

bamboo restaurant and beach bar to spa resort in Vietnam by Vo Trong Nghia Architects [3]

the beach bar lies adjacent to the infinity pool along the coastal front of the resort complex. visualized as a semi-open space –allowing a constant breeze to flow through– the structure is composed of bamboo, stone and finished with a thatch roof. the process in which the robust, natural material was formed was through a method of using fire, soaking and fumigation. approached as a simple, pitched roof structure, the unobtrusive building blends with its tropical setting where the naturally treated bamboo frame reflects the region's characteristics.

Naman Conference Hall in Vietnam by Vo Trong Nghia Architects [4]



The main bearing structure are the **bamboo frames** which overcome a span of 13,5 m in the hall and 4 m in the corridor with the roof height of 9,5m. The arch-like impression is created by the bent bamboo that are part of the main structure. Thanks to the positioning of the glass facade which is stepped backwards into the volume, 3 frames of the arch structure are in the exterior, opening the entrance as the space serves as a foyer to welcome the guests.

3.4.2 Interior design

Awards and Recognition



A GREEN CAMPUS – A Living Education

HONG KONG MANAGEMENT COLLEGE

- HSMC campus herself serves as an educational tool by introducing bamboo plantations and bamboo material, making herself a tangible **BAMBOO GARDEN** for education;
- Breathing in extra fresh air, the whole Campus is in fact a healthy built-environment for the students and teaching facilities, nurturing behavioral changes of the students and the public, with bees and birds around;
- IAQ excellent class has been achieved.

4. SUSTAINABLE DEVELOPMENT

Through sustainable management and utilization of bamboo resources, the international community can significantly reduce pressure on fast depleting forest resources conserve biodiversity & fight climate change.

The development of bamboo industry is speeding up, scale and level takes the lead internationally, perfect industrial system has been formed and bamboo industry has become the most competitive industry worldwide. In the east and south of China, bamboo industry has become the strong growth point of economy. The abundant bamboo resources provide not only the basis of the industry but also the extensive development room for the chemical utilization of new bamboo industry.

5. PRODUCT: CLOTHING, FOOD, LIVING, TRANSPORT AND LUXURY GOODS

Since the beginning of the century, particularly in recent years, bamboo has entered into multiple-use period, such as bamboo vinegar, leaf, protein of bio and chemical industry, fiber & textile industry, laminated wood, decorative materials manufacturing, distinct ecological tourism of bamboo and commercial & service of bamboo.

5.1 Textiles

- Bamboo fabric is a natural textile made from the pulp of the bamboo grass
- Bamboo fabric has been growing in popularity because it has many unique properties and is more sustainable than most textile fibers
- Bamboo fabric is light and strong, has excellent wicking properties, and is to some extent antibacterial
- Bamboo fiber resembles cotton in its unspun form, a puffball of light, airy fibers
- To make bamboo fiber, bamboo is heavily pulped until it separates into thin component threads of fiber, which can be spun and dyed for weaving into cloth
- Bamboo fabric is very soft and can be worn directly next to the skin
- Many people who experience allergic reactions to other natural fibers, such as wool or hemp, do not complain of this issue with bamboo
- The fiber is naturally smooth and round without chemical treatment, meaning that there are no sharp spurs to irritate the skin



5.2 Bamboo as culinary

- Bamboo is rich in minerals & high in fiber, which can be a great addition to any nutritious, well balanced diet
- Most food center on the bamboo shoots, which are tender and delicious vegetables, used in numerous Asian dishes and broths
- Frequently used for cooking utensils within many cultures, and is used in the manufacture of chopsticks, yakatori sticks etc

6. INTERNATIONAL BAMBOO TRADE

Despite this progress the present lack of uniform international standards for the vast majority of bamboo products has long stood in the way of further rapid growth in international trade. The need and imperative for establishing an international platform to set standards on bamboo is now more pressing than ever.

6.1 Combining state of art knowledge on current research: Industry processes and trade

The newly proposed ISO Technical Committee for Bamboo will provide the bamboo sector with valuable guidance on terminology, methods and stands for major internationally traded products. The technical committee will firstly focus on publishing basic stands, covering terminology and classification criteria of bamboo and their related products.

6.2 Provide scientific and unified approach for evaluating bamboo properties

The committee will establish standards for methods, covering test methods on the physical, mechanical and chemical properties of bamboo.

6.3 Committee to define standards for internationally traded bamboo products

These standards will guide industry globally, with small and medium-sized enterprises in developing nations being among the main beneficiaries. This will lead to improvements in the processing and quality of bamboo products, enhancing their value and competitiveness in the global market.

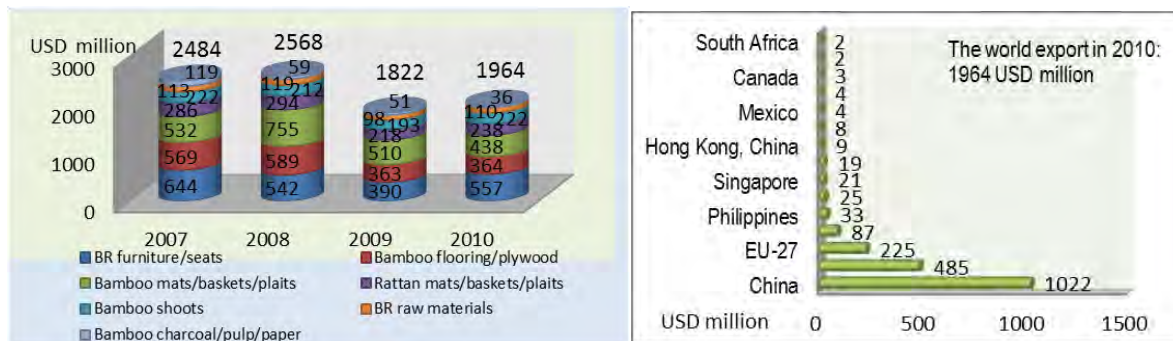

Figure 3: The world export in 2010: USD 1964 million and processing type of bamboo
Source: International Network for Bamboo and Rattan (INBAR)

7. STANDARD SYSTEM OF BAMBOO PRODUCTS IN CHINA

- Standards are applied in bamboo's applications in Furniture, construction, decoration, paper and pulp making, chemicals, textiles, foods, healthcare products, agriculture, electronic and other fields.
- Up to date, China's bamboo related standards include 33 national standards, 70 standards in the forestry sector, 50 industry standards in other sectors and 167 local standards regarding to bamboo and rattan.
- Now there are 19 national standards and 45 standards in the forest sector are under development.

7.1 Policy challenges of developing bamboo industry

- Adjustment of property right of bamboo forest in rural areas: Unreasonable land distribution, forestry right dispute, efficiency and fairness.
- Heavy burden of bamboo farmers: Unreasonable fees charged by local authorities.
- Poor control and management of private bamboo process enterprise: Poor standards and quality control.
- Dilemma of support policies for small-and mid-sized bamboo processing enterprises: Weak R&D abilities and lack of advantage products.
- The sustainable operation system needs improving: The qualification and operation of bamboo forests need improving.
- Bamboo forest insurance: The disaster losses of bamboo forests are not corresponded to the high premium and harsh compensation conditions.
- Early warning of bamboo industry: The market information of the farmers and enterprise are not interrelated, and the information network needs to be improved.

7.2 Policy challenges of developing bamboo industry

- Gradual establishment of GSP system for bamboo industry subsidy policy
- Build up and upgrade bamboo forest insurance mechanism under the financial supports
- Encourage financial organizations to develop financial products adapted to the multiple functions of bamboo industry

7.3 Forestry subsidy policy (Ministry of Finance, State Forestry Administration, 2013)

- Subsidy for forest seedling: 600 yuan/mu for seed orchard and germplasm resource bank, 300 yuan/mu for cutting orchard, and 100 yuan/mu for mother forest and experiment forest;
- Subsidy for afforestation: For artificial afforestation, 200 yuan/mu for arbor forest and woody oil forest, 120 yuan/mu for shrub forest (200 yuan/mu in Inner Mongolia, Ningxia, Gansu, Xingjian, Qinghai, Shanxi and Shanxi), 100 yuan/mu for bamboo forest and other forest including fruit and woody medicine forest; For artificial regeneration and low-efficiency forest improvement, the subsidy standard is 100 yuan/mu. No final cutting is allowed in 10 years for arbor forest established with the subsidy for afforestation from the central finance.
- Subsidy for forest tending: The subsidizing standard for forest tending is averagely 100 yuan/mu, and the subsidy targets young and middle-aged state-owned forest and young and middle-aged ecological forests owned collectively and individually.
- Subsidy for forestry hazard prevention and reduction: Including subsidies for forest fire control, forest disease and pest control, productive hazard relief, and forestry technology extension & demonstration.
- Subsidy for protected areas: Including subsidies for wetland, national forestry natural reserve and closed reserves in sandified area.

Bamboo is a truly unique non-timer forest resource!

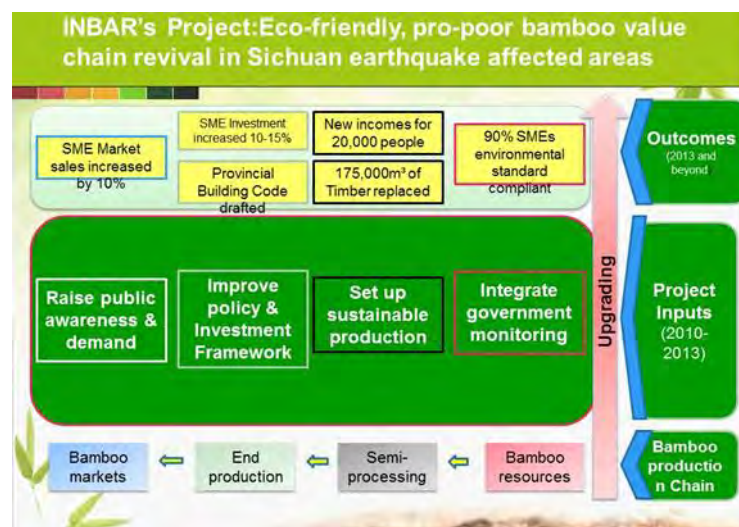

8. CONCLUSION

Bamboos' utilization and trade play important roles in many countries, especially in developing countries. Bamboos are commonly called the "poor man's timber", "green gold", and are closely related with people's Livelihood, in some places people say that bamboos are used "from cradle to grave". Bamboos' applications are quite diversified, the bamboo culms can be processed into various products, bamboo shoots can be utilized for food and fodder, the bamboo forests can provide ecological services and develop eco-tourism; besides, bamboos are closely related with civilization in many cultures, they are processed into various art works, and there are different bamboo cultures in many countries in the world. Bamboos are very important for the livelihoods of the people in the producing areas. Now we must use much more bamboo products, especially to improve our built-environment, where there are much scope and room for applications; as demonstrated in the Hang Seng Management College in HK.



REFERENCES

- [1] The 20th session of the Conference of Parties United Nations Framework Convention on Climate Change. Retrieved from: <http://www.cop20lima.org/about/cop20.1.html> [Retrieved on 9 December 2014].
- [2] The 21st session of the Conference of Parties United Nations Framework Convention on Climate Change. Retrieved from: <http://www.cop21.gouv.fr/en> [Retrieved on 12 December 2015].
- [3] Vo Trong Nghia Architects. Retrieved from: <http://votrongnghia.com/projects/naman-beach-bar/> [Retrieved on 1 April 2015]
- [4] Vo Trong Nghia Architects. Retrieved from: <http://votrongnghia.com/projects/naman-conference-hall/> [Retrieved on 1 April 2015]

Community Empowerment through Mud-Concrete Technology: Sustainable Building Techniques to Revitalise the War Victim Communities in Batticaloa, Sri Lanka

Rizna AROOZ^a, Rangika HALWATURA^b, Chameera UDAWATTE^c

^a University of Moratuwa, Sri Lanka, rizznaz@gmail.com

^b University of Moratuwa, Sri Lanka, rangikauh@gmail.com

^c University of Moratuwa, Sri Lanka, udawatthe@gmail.com

ABSTRACT

Empowering war victim community is a challenge where people live in extreme poverty line and left with limited choices to fulfil fundamental needs. While conducting the post war reconstruction programmes lot of international donors were raised hand to support the development of war victim communities, cause Sri Lanka is still a developing country. But, prior to develop the local community there was an urge to understand the local conditions and then sustain their demands. Thus, it was understood using appropriate, sustainable building construction technologies would be a highly viable solution to boost up the process. Within this process Mud-Concrete technology was introduced to build the community centers for identified war victim communities in Batticaloa. Mud-Concrete technology is a novel concept which was developed through utilizing readily available materials and using locally available cost effective resources. This paper explores a conceptual framework, that how an appropriate, sustainable and innovative building technology could serve to empower the war victim communities within their context. Further, it concludes the three stages of research process of introducing the Mud-Concrete technology to local communities and how they bridged together in reaching empowerment within the revitalising programme.

Keywords: community Empowerment, appropriate technology, sustainable building material, Mud-Concrete technology

1. INTRODUCTION

Community empowerment bring up the process of helping communities to growth control over their lives. "Communities" are groups of people that may or may not be spatially connected, nevertheless who share common wellbeing, or identities. ("WHO | Track 1," 2009) **These communities could be local, national or international, with specific or broad interests.** 'Empowerment' denotes to the process by which people gain control over the factors and decisions that shape their lives. People cannot "be empowered" by others; they can only empower themselves by obtaining more of power's in different forms. (Laverack and Keshavarz Mohammadi, 2011) Empowerment is a powerful approach for solving many community problems. (Kasmel and Andersen, 2011) Within the process of empowering the community, selecting an appropriate technology is an important factor. It should be the ultimate goal of any community development projects.

Appropriate Technology is a concept which represents providing for human needs with the least effect on the **Earth's limited resources and it will fill in the gap to make over community development into community empowerment.** (Wicklein, 2004) Appropriate technology is based on the idea that advanced technology is often inappropriate for the needs that it is attempting to address within developing countries. The principle behind Appropriate technology curtails the use of non-renewable resources to solve technological problems while encouraging self-confidence. (Wicklein, 2004) According to Robert Wicklein, if technology matters to people, **there's a criteria to judge the appropriateness of the technology.** (Wicklein, 2004)

DESIGN CRITERIA	DESCRIPTION
Systems-independence	This criteria refers the capability of technological devise to perform the job with minimum supporting facilities
Image of modernity	People must believe the technology should raise their social status as well as meet the basic human needs.
Individual technology vs. Collective technology	Technology must tally with the cultural norms of its community/society. Then that will be the most appropriate technology which will provide the best service to that society.
Cost of Technology	The reduction of costs is an urge, when designing technological devices for developing countries. The cost of the device must be reduced significantly for the people to afford the expense. Thus it could help to meet the basic needs of life.
Risk Factor	The risk to the success of appropriate technology must be considered in detail but not necessarily be totally removed.
Evolutionary Capacity of Technology	Appropriate technology should allow for (i.e., have design characteristics) a continuation of development. This technology should capable to expand and be reconfigured to undertake a higher volume of work or mass production.

Table 1: Design criteria to judge the appropriateness of technology (Wicklein, 2004)

It is clear that rural communities must be transformed to reach empowerment and it will make sure the continuity of sustainable development. In order to get sustainability among rural communities, technology become a booster to reach it. Predominantly, appropriate technology have a strategic position among the transformation process. There were three logical stages have been identified in appropriate technology in community transformation such as development, sustainable development and then empowerment. According to Sianipar et al, frame work of empowerment has been concluded as below. (Sianipar et al., 2013)

	Triple bottom line in sustainable development	Trio perspectives of appropriate technology	Three parties in community empowerment
	Social	People	Community members
	Environment	Planet	ACADEMIA
	Economic	Profit	Government
DEVELOPMENT	SUSTAINABLE DEVELOPMENT		EMPOWERMENT

Table 2: Framework of empowerment (Sianipar et al., 2013)

When considering about sustainable building materials 'Soil' can be considered as a sustainable raw material which has been used extensively for building construction since ancient times, particularly in developing countries. (Al-Ajmi et al., 2016) Soil-based construction has been very popular in ancient times, though it is not so in the present context of the industry. These Earth based techniques are becoming unpopular day by day due to social believes on their strength and durability parameters. Also it is considered that these technologies only employ for poor who runs with low cost budget though these products got eco manufacturing process. Therefore, the attempt is to incorporate the strength and durability parameters of concrete to mud-based constructions and combined the traditional techniques with modern technologies to provide a highly sustainable material for future of construction.

Thus, Mud-Concrete Block (MCB) could be introduced as one of the recent Soil-based product has been developed and patented under Intellectual Property Act No.36 of 2003. (Halwatura, 2016) It discloses the Mud concrete block **is a novel product which employs a 'Concrete' made using soil. It is a mixture of soil, cement and water. Mud concrete block comprising, a mixture of fine <10% (\leq sieve size 0.425mm), sand 55 - 60% (sieve size 0.425mm \leq sand \leq 4.25 mm), gravel 30 - 35% (sieve size 4.25mm \leq gravel \leq 20mm), at least 4% cement and water 18 - 20% from the dry mix.** Mixture of Mud-Concrete block could pour into the block moulds without any compaction and then curing to obtain the required strength.

Therefore, it is worth to consider how and why Mud-Concrete technology could use or convert as an appropriate sensitive technology in community empowerment projects in developing countries. Following case study was mainly a beneficiary participant project which conducted in war-victim areas in Batticaloa. Financial assistance was given by foreign donor agencies. General technical advices and the assistance on the new technique as well as **the implementation targeting the quality and cost reduction was done by inventors' who were relating to academia.** In order to develop the social interaction within immediate community the international donors & Non-Governmental

organisation (NGO) were proposed to build a prototype model of community centers in identified areas. The goal of a new community centres set in create a unique place that will unite people in a neighbourhood by providing a setting that will bring the community together, once again. The principle element that these war victim communities lack is a cultural or social bond. By providing a place where members of the community can gather together, celebrate and share their different cultures will ultimately create a new cultural and social bond within the neighbourhood and the greater community. Also by providing a place for everyday activities to take place within the community, rather than remote from its core, will allow for more social interaction.

2. METHODOLOGY

Empowerment as transitional process of a community should be understood completely through scientific thoughts as well as real field problems. (Sianipar et al., 2013) Therefore, three main stages have been identified in the process of empowering the community through a newly introduced building technology.

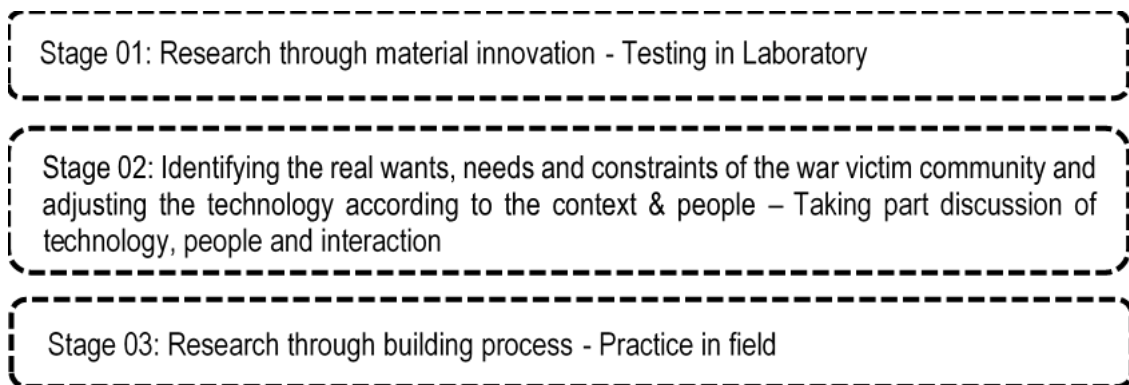

3. DISCUSSION

3.1 Stage 01: Research through material innovation - Testing in Laboratory

The novel concept of Mud-Concrete technology was introduced, in order to develop the strength & durability of soil based construction. **Mud-Concrete employs a 'Concrete' made using earth/ soil. Concrete is a composite** construction material made out of cement, sand, metal and water. Here, metal (coarse aggregate) governs the strength, cement acts as the binder and sand (fine aggregate) reduces the porosity and water acts as the reactor to cement. In Mud-Concrete, the intended functions of sand and metal of concrete are replaced by fraction of soil. The precise gravel percentage governs the strength of Mud-Concrete. The cement in this concrete is also used as a stabilizer in very low quantities. According to gradual experiment process, the best mix proportions of unique Mud concrete block is achieved through fraction of soils, with minimum cement percentage and optimum water requirement which allows its self-compacting nature. Excess water in the mix will create a porous structure that will later act in cooling the building through convection. This will increase the thermal comfort of the interior than other earth based constructions. Unlike conventional approaches to mud based construction, the MCB as a sensitive technology explained significant innovative ideas which could utilize people ambitions in real world construction.

3.2 Stage 02: Identifying the real wants, needs and constraints of the war victim community and adjusting the technology according to the context & people – Taking part discussion of technology, people and interaction

First of all, several presentations & workshops were conducted to introduce the Mud-Concrete technology to donor and beneficiary communities by inventors. Then selected sites for construction have been visited and soil samples were borrowed for tests. Then the all soil samples borrowed from the proposed sites were analysed at laboratory and introduced possible techniques to bring the soil up to required level. Sample Mud-Concrete block walls were constructed for exhibit to local people and make them familiar with the appearance and the modernity of the block, **prior to introduce the technology. Donors and beneficiaries community in the area was identified "Mud Concrete technology" as an appropriate cost effective** technology. Therefore, three community centres out of six were decided to construct using Mud-Concrete Blocks.



Figure 1: Borrowed soil samples from each site were tested in laboratory and develop the soil up to required level of construction

3.3 Stage 03: Research through building process - Practice in field

Training programmes and workshops were conducted to introduce the technology to people and maintain a responsive relationship with the local community. Through this programmes skilled and unskilled labour force was identified within the community. Community labour was used to cast the Mud-Concrete blocks at sites. 225mm x 200mm x 150mm size blocks were casted for construction the walls. Cement 1: soil 3: and sand 4 Mortar proportion were used during the masonry construction. Sieving the soil and sand from a mesh size of 6mm is essential in case of removing the coarser particles and to achieve good homogeneity of the mortar in the joints between the blocks. The water content of the mortar is decided by achieving a good workable mix. Once the foundation was done the floor concrete was laid to get a uniform surface to do the block casting. This will make sure a continuous water seal membrane at the foundation level and hence, it will minimize/ totally eliminate water movements due to capillary action as well as can reduce the termite attacks. Further, with this a good workable platform will be created and hence, quality of block production will be endorsed. Project cost also can be reduced by avoiding brick work at the foundation level. Foundation work was kept for 14 days to achieve the strength and until that the labours at the site were used to cast the blocks. 120 blocks were made for a day and the total requirement was 2750 blocks for the whole buildings. As an average amount, 20 days were required to cast the blocks for construct a community building. Hence when the site is ready for waling, the blocks were ready. Several work studies were carried out to find the optimum construction labour/ machinery cost. Several trials were done with 1-3 moulds and found the best as to have 2 laboures at each site while sharing the production cost of 3 moulds among more than 2 sites, to gain the best cost saving for the buildings. With the careful and continuous supervision, the labour cost of a block can be reduced from LKR. 31.20 to LKR.7.15 and this will lead to an extra cost saving of Rs.60, 000.00 by having 3 laboures at the site with 2 moulds and increasing the number of cycle of casting. The calculations are based on reusing of the moulds for at least 10 sites. Further, study was carried out to minimize the Material cost through optimizing added cement from 8% to 4%.



Figure 2: Educating the community people through the building process

During the site visits, successful progress was observed towards using MCBs. Then the Form work was developed and introduced most optimum way of casting the blocks with the available resources to maintain easy manufacturing through less involvement of technology. The working community has grasped the essence and the **correct technology of casting procedures. By improving the timber mould into steel moulds and having 4" and 6" moulds** within the steel frame gives the evidence that the community is satisfied with the MCBs and has optimistic view towards the technology and reflects their attempts of improving the technology more conveniently. According to the project records, the typical prototype modelled community centers constructed through Sand-Crete blocks was cost 2.995 million and Brickwork (rat trap bond) was cost 2.966 million. But the community center constructed through Mud-Concrete block technology was cost only 2.84 million and the technology saved nearly 0.1 million from a building and saved 0.3 million from three projects which constructed at Batticaloa. To control the quality of work, there was a necessity to pre-plan for controllable failures. Therefore, easy handling simple tools were introduced to levelling and aligning the mortar joints and construction of walls. Continuous monitoring and quality controlling measures were provided by inventors/ academia and technical officers during construction and up-to completion of the project.



Figure 3: Easily handled simple tools & techniques were introduced to maintain the quality of construction

4. CONCLUSION

Though there were different walling materials were introduced to build the community centres in identified areas in Batticaloa, Mud-concrete technology was identified as a highly viable solution which could use locally available soil in construction sites. When comparing with the other walling materials MCB took a prime place in load bearing, durability and thermal comfort while maintaining low embodied energy. Further, the Mud-Concrete technology is able to,

- Save cost, quality and time,
- Maintain the flexibility in production, assembly & use,
- Cater the human errors of design, manufacturing and use,
- Flexible enough to adapt for social circumstances,
- Allow to increase the labour productivity and educate the community through the building process.
- Acknowledge all participating groups in the process and transfer of the knowledge across the construction sector.

Thus the research process of Mud-Concrete technology, achieve its appropriateness to the context through stage by stage in empowering the war victim community in Batticaloa.



Figure 4: One of the completed community center building made out of Mud: Concrete Blocks in Batticaloa

DESIGN CRITERIA	DESCRIPTION
Systems-independence	MCB technology is capable enough to standalone, to fulfil the community needs. No need advance techniques or methods. Technology was develop through locally available materials and construction could continue with using simple tools.
Image of modernity	MCB technology is coming with new appearance, textures and colours. Technology is assured with strength & durability aspects. There is a flexibility in finishing work, to achieve different Architectural languages.
Individual technology vs. Collective technology	MCB technology could practice either as an individual technology (ex: construction of individual houses) or as a collective technology (ex: construction of community centers). Technology is flexible enough to adapt according to the context and society.
Cost of Technology	Lot of strategies were used in cost reduction. Starting from raw material (ex: locally available materials) to end product, all the stages in construction were optimised to reduce the cost of block and the construction process. No need advance technologies or advance tools. Technology was flexible enough to make the skilled labour force through the construction process within the community.
Risk Factor	Strength & durability aspects were tested according to the universal standards when developing the technology.
Evolutionary Capacity of Technology	Technology has the capability to expand and be reconfigured to accomplish a higher volume of work and/or more sophisticated production processes. (Udawattha et al., 2016)

Table 3: Mud-Concrete technology (MCB) as an appropriate technology in community empowerment process.

REFERENCES

- [1] Al-Ajmi, F., Abdalla, H., Abdelghaffar, M., Almatawah, J., 2016. Strength Behavior of Mud Brick in Building Construction. *Open J. Civ. Eng.* 6, 482. doi:10.4236/ojce.2016.63041
- [2] Halwatura, R.U., 2016. Mud Concrete Block. 17616, E04C 1/100, B28B, B28C.
- [3] Kasmel, A., Andersen, P.T., 2011. Measurement of Community Empowerment in Three Community Programs in Rapla (Estonia). *Int. J. Environ. Res. Public Health* 8, 799. doi:10.3390/ijerph8030799
- [4] Laverack, G., Keshavarz Mohammadi, N., 2011. What remains for the future: strengthening community actions to become an integral part of health promotion practice. *Health Promot. Int.* 26, ii258-ii262. doi:10.1093/heapro/dar068
- [5] Sianipar, C.P.M., Yudoko, G., Adhiutama, A., Dowaki, K., 2013. Community Empowerment through Appropriate Technology: Sustaining the Sustainable Development. *Procedia Environ. Sci.*, The 3rd International Conference on Sustainable Future for Human Security, SUSTAIN 2012, 3-5 November 2012, Clock Tower Centennial Hall, Kyoto University, JAPAN 17, 1007–1016. doi:10.1016/j.proenv.2013.02.120
- [6] Udawattha, C., Arooz, F.R., Halwatura, R.U., 2016. Manufacturing framework and cost optimization for Building Mud-Concrete Blocks, in: *Science for the People: Mobilizing Modern Technologies for Sustainable*

- Development in Asia. Presented at the 16th Conference of the Science Council of Asia, National Science Foundation, National Academy of Sciences of Sri Lanka, Colombo, Sri Lanka, pp. 326–331.
- [7] WHO | Track 1: Community empowerment [WWW Document], 2009. . 7th Glob. Conf. Health Promot. URL <http://www.who.int/healthpromotion/conferences/7gchp/track1/en/> (accessed 9.29.16).
- [8] Wicklein, R., 2004. Appropriate Technology and the Third World: Technology as if People Matter. Int. Technol. Eng. Ing Educ. Assoc. PATT14.

Session 7.6: Green Construction Materials (2)

Self-Compacting Clay Concrete: A Sustainable and Innovative Process to Build with Earth

Gnanli LANDROU^a, Coralie BRUMAUD^b, Guillaume HABERT^c

^a ETH Zürich, Switzerland, glandrou@ethz.ch

^b ETH Zürich, Switzerland, brumaud@ibi.baug.ethz.ch

^c ETH Zürich, Switzerland, habert@ibi.baug.ethz.ch

ABSTRACT

In the construction sector, cement and concrete are responsible for 8% of total CO₂ emission and this value will increase with respect to the global population growth. Developing a sustainable and green constructive materials for future generation became an urgent need. Without transport needs and with infinite recycling possibilities, earth is one of the building materials with the lowest environmental impact. However, its development is hindered by the time and the manpower required in conventional earthen construction techniques. The purpose of this research is to develop strategy for earth-based material that would be as easy and as cheap to use as current concrete products, then implement it at mortar scale.

To do so, we focused on the modification of earth binder: clay. With the use of sodium hexametaphosphate (NaHMP), we improved the fluidity which allow to cast easily the material; then with addition of magnesium oxide, we enable an internal coagulation during time. Rheological tests show the effect of additives at level clay paste. Furthermore, on the mortar scale, we show that not only NaHMP improve the workability of the clay based concrete but also increases the compressive strength. More, the coagulant also enables the acceleration of formwork removal but also influence the final compressive strength. As main findings, water content, the percentage of dispersant, the ratio coagulant-dispersant are relevant parameters to improve earth based concrete mechanical properties.

Keywords: climate change, innovative process, deflocculation-coagulation

1. INTRODUCTION

Without transport and with infinite recycling possibilities, earth is one of the building materials, with the lowest environmental impact (Anger, 2009; Morel et al., 2007; Shukla et al., 2009), used in most climate and society. Additionally, it provides a very efficient temperature and moisture regulation of indoor living spaces (Parra-Saldivar and Batty, 2006). Nowadays, we can observe a strong development of earth construction due to the current environmental threats. However, its development is limited as the conventional earth construction techniques are time and cost intensive. On the other hand, we have cement and concrete, which are an incredibly easy to use material with a significant environmental impact (Schneider et al., 2011). While science and engineering efforts were invested to improve the understanding and the processing of cement-based concrete, few research and engineering improvements have been brought into earthen material (Ouellet-Plamondon and Habert, 2016).

The objective of this study is therefore to transform earthen architecture by providing a material that is as easy and as cheap to use as current concrete products, thanks to novel technologies borrowed to science and technology of cement and concrete. This technology transfer can be done as cement and clays have a lot of analogies in terms of colloidal interactions and adhesion forces (Pellenq et al., 2008). Though, the cohesion forces between clay particles are much weaker as no chemical reaction occurs in presence of water.

To improve the material fluidity while working at low dosage of water, a careful control of the rheology of clays requires a better understanding of colloidal interactions between particles and knowledge transfer from the fundamental physics of grain and colloidal interactions to the civil engineering. As unique binder in earth, clay, an inorganic negatively charged particle, can have its surface interaction changed with the help of dispersants mainly coming from the ceramic industries. Among common dispersants used, we focus on the use of sodium hexametaphosphate known to guarantee an efficient dispersion of natural clay minerals (Andreola et al., 2006).

On the contrary clay flocculation can be achieved through the introduction of calcium or magnesium ions coming from the dissolution of natural minerals. These ions interact both with the surface of clay particles, the deflocculant and the ions release in solutions (Andreola et al., 2006).

In this paper, we focus on the strategy used to develop a self-compacting clay concrete SCCC at the clay paste scale by modifying the surface charge and the rheological behaviour of earth binder. Then we investigate on the mortar scale the effect of dispersant and coagulant on the final compressive strength. Moreover, we discuss the influence of dispersant on the porosity and the arrangement of clay particles in the mortar.

2. METHODS

2.1 Materials

The studied clay; kaolin FP80 powder is a commercially available clay supplied from Alberto Luisoni AG, Switzerland with a specific density 2.62 and a specific surface area $SSA_{BET} = 9.10 \text{ m}^2 \cdot \text{g}^{-1}$. The mean particle size assessed by Laser Particle Size Analyzer is $8.69 \mu\text{m}$. The mineralogical phase quantification, the purity of kaolin clay was determined by X-Ray diffraction which reveals that more than 87% of kaolin FP80 is kaolinite clay; specifically a non-swelling clay minerals.

The dispersant investigated in this study is an inorganic deflocculant sodium hexametaphosphate noted here NaHMP sourced from Fischer Chemicals in powder form. Magnesium oxide in a powder form (MgO, 98% purity; Sigma Aldrich) is used as coagulant

2.2 Experimental process:

2.2.1 Rheological measurements

Rheology measurements were carried out on clay pastes in order to study the effect of dispersants on the rheological properties of the suspension such as the yield stress. To compare the results obtained from different measurements, the water to clay ratio (W/C) for clay paste was kept constant. Only the dosage of the dispersant was varied from one sample to another. In this paper, all dosages are expressed as a percentage of the mass of solids in the system and water is deionized. The tested clay pastes were prepared using the following mixing procedure: the dispersant is added to the required amount of mixing water in order to ensure its dissolution before introduction into the solid phase. Water (with or without dispersant) is mixed with clay during 3min at 365rpm with a mechanical stirrer.

The rheology measurements were carried out using a Malvern Kinexus Lab+, a rotational rheometer equipped with vane geometry at room temperature ($23 \pm 0.1^\circ\text{C}$). Ten minutes after the first contact of constituents, the cup of the rheometer was filled and covered to limit evaporation, and the sequence was started. The flow curve data acquisition cycle is as followed: an increase ramp from 0.1 to 300 s^{-1} in 300s considered as a pre-shearing to ensure that all samples were in the same reference state of stress then a decrease ramp from 300 to 0.1 s^{-1} in 300 s. The yield stress is obtained at low shear rate during the decreasing ramp using the Bingham model. At this low shear rate, the viscosity effects were negligible.

2.2.2 Mortar sample preparation and testing procedure

To study the mechanical properties and to confirm the adopted SCCC strategy, a model earth mortar is used. The mortar is composed of a binding phase: here kaolinite paste and solid phase: sand (Figure 1).

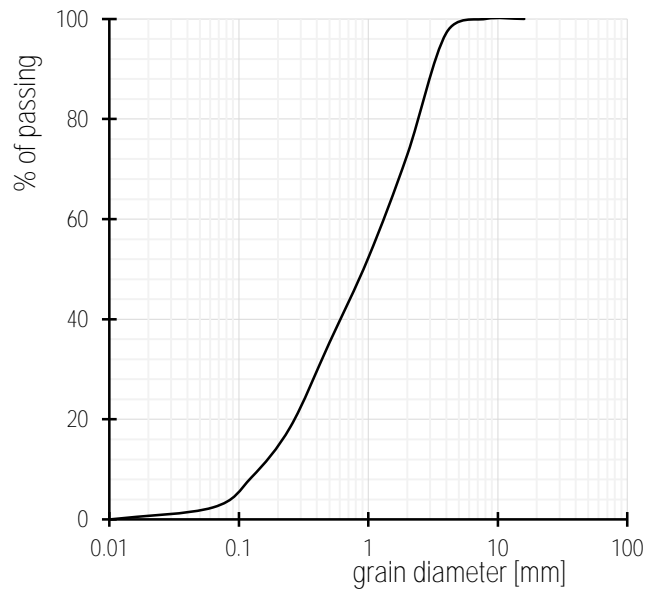

Figure 1: Grain size distribution of sand

The samples were prepared by homogenizing first at dry state sand and clay. Then the liquid phase (water with or without dispersant) is added to the dried grains particles. The samples were mixed then with help of automatic mixer (Laboratory Mortar Mixer, MATEST) for 2 min in order to have a homogeneous consistency. After 2 minutes, the coagulant was added to the mix and homogenize again for 2 minutes. For each samples, 4x4x16 cm mold are filled. The samples are after dried in oven at 105°C to ensure a stability of weight before measurement of compressive strength. The measurements are done using Unitronic 50KN (MATEST) adapted for soil.

3. RESULTS AND DISCUSSIONS

3.1 Strategy for SCCC: Level of clay paste

3.1.1 Deflocculation process: Effect of dispersant and stability

The Figure 2 left reports the evolution of yield stress of clay paste as a function of amount of dispersant. It compares the efficiency and the stability range of concentrated clay suspension in presence of NaHMP. The full line represents rheological measurement right after mixing (3min) and the dash line is measurement done after 300 min. To visualize the efficiency of dispersant, the reference paste has a higher yield stress; around 1000Pa; with no workability. The yield stress characterize the force needed to induce flow of suspension. Higher is the value difficult it is to deform the material.

As expected the yield stress decreases with progressive addition of NaHMP. In this regime, the yield stress of the reference paste is significantly reduced and the minimum yield stress is reached at 0.3wt% NaHMP (0.1Pa). At such yield stress, it is observed that the paste is fluid to be cast and does not show any sedimentation with respect to the experiments time. More the dispersants are stable during time as the range of evolution of yield stress are narrow. This results strengthen existing findings highlighted in literatures (Andreola et al., 2006; Landrou et al., 2016). NaHMP is then a robust and efficient deflocculant as the percentage needed to obtain a fluid suspension is low and the yield stress is reduced by factor 1000.

The decrease of yield stress as highlighted in (Landrou et al., 2016) is due to the adsorption of negatively charge phosphate ion in the positive clay rim. This implies an increase of negative surface charge and allow an electrostatic repulsion between clay particles. Indeed it was observed by doing zeta potential measurement that at 0.3wt% NaHMP, the surface charge is above -66 mV. The contact between (-) face / (-) rim is reduced and the formation of weak agglomerate is avoided due to the long range interaction between clay particles after adsorption of phosphate ions.

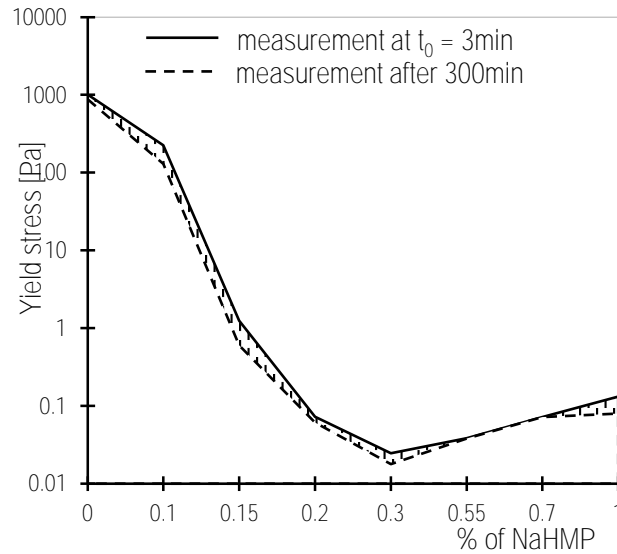

Figure 2: Semi-logarithmic plot: Evolution of yield stress measured for a concentrated clay paste containing different dosage of NaHMP
Rheological observation of effect of dispersants and their stability

3.1.2 Coagulation process: Effect of MgO addition

We plot in Figure 3 the yield stress as function of experiment time. The graph represents the rheological behavior of coagulated clay suspensions during time. After addition of MgO to the dispersed paste, it is noted that at t_0 that the paste is still fluid and workable to process. However the yield stress increases during time

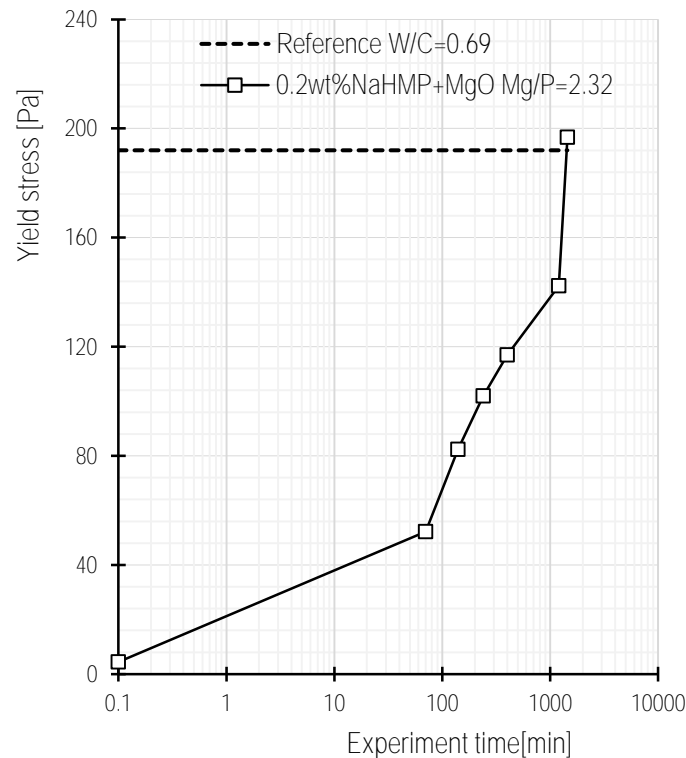

Figure 3: Variation of the yield stress versus experiment time for mixture of kaolinite + 0.2wt%NaHMP + MgO

Contrary to Figure 2 left where the value of yield stress doesn't change during time, the yield stress measured in presence of MgO increases during time which refers to an irreversible rheological behavior. We can suggest a chemical reaction between ions in solution and MgO which allow the hardening during time. MgO action is then highlighted as it delays the coagulation while accelerating the formwork removal. Magnesium oxide acts as anti-plasticizers. Indeed, similar phenomenon is observed in (Landrou et al., 2016) when $\text{Ca}(\text{OH})_2$ was used instead

of MgO. The authors stress that calcium addition increases the storage modulus during time due to a reaction between calcium and phosphate to form an Apatite based mineral. Furthermore, they reported that the reaction is irreversible and suggest that the delay of hardening can be controlled by the dissolution rate of coagulant.

At this stage, we stress that the deflocculation and coagulation strategy adopted allow the development of SCCC. In fact, using NaHMP allows to fluidify clay based materials at low water while adding magnesium ion allows to coagulate the suspension which harden during time.

3.2 Optimization of mix design: Level of clay mortar

3.2.1 Influence of sand and water content on compressive strength

In the Figure 4, we plot the compressive strength versus the ratio sand/ paste for different mixture. The graph illustrates the influence of water ratio on the compressive strength. As expected, at high water to clay ratio the compressive strength determined is low. More, it was observed sedimentation and bleeding problem at high water content.

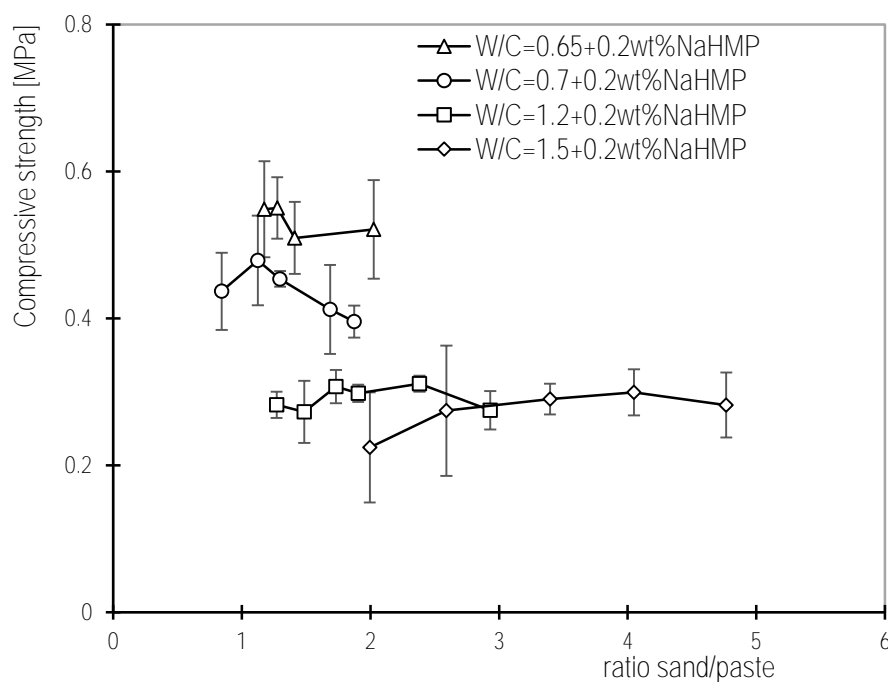

Figure 4: Variation of compressive strength with increase of ratio s/p (sand/ paste) for different mortar mixtures: Change in W/C (water to clay) ratio at constant dosage of dispersant

While the influence of water is anticipated, the influence of sand content or ratio sand/ paste seems to play minor effect on the final mechanical strength even though at low ratio W/C, a maximum can be observed. In fact at high water to clay ratio, the porosity is high and problem such as sedimentation occurs which influence the final strength.

3.2.2 Influence of additives on the mechanical property

In the Figure 5, we illustrate the relationship of NaHMP addition on the compressive strength measured after drying of the sample and stability of the weight. As mentioned in Figure 1, the addition of NaHMP enhance the workability of the clay paste with the reduction of the yield stress. This finding is also highlighted at the mortar level as clay behaviour control the fresh state behaviour of the mortar. However, the graph shows an increase of compressive strength while increasing dispersant amount.

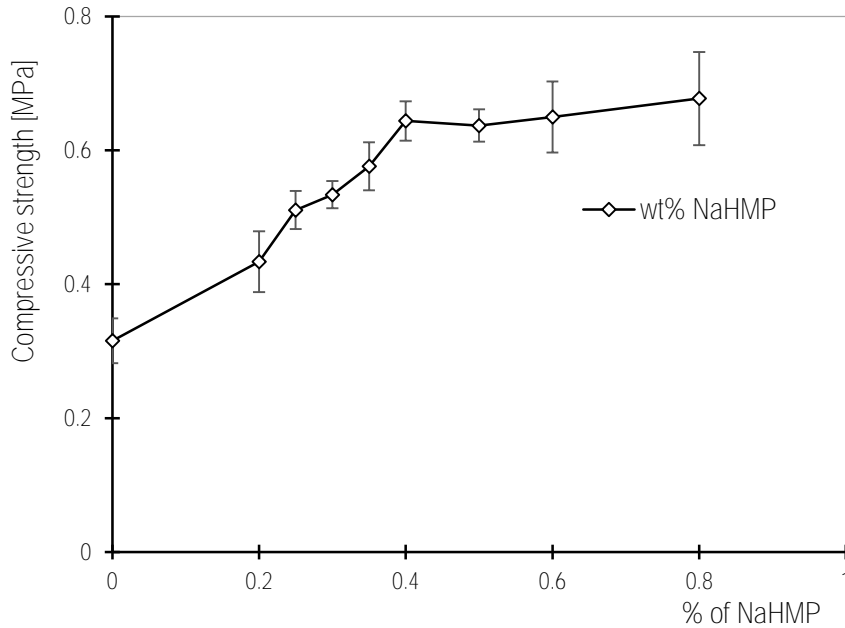

Figure 5: Relationship between the dosage of dispersant and the final strength for a mortar mixture of W/C=0.7 and ratio s/p (sand/paste) = 1.69

The results, even though surprising have been reported recently in (Moevus et al., 2016). It suggests that the compressive strength increase is related to clay re-arrangement at high dosage of dispersant. At low concentration of NaHMP, even though Figure 2 shows a low yield stress, addition measurements as zeta potential measurement reveals not all clay particles are deflocculated while at high dosage the percentage of surface cover by phosphate anions is high. This implies less contact face (-) / (-) edge between clay particles but more a slow contact face (-) / (-) face (Lagaly and Ziesmer, 2003). This re-organization might allow the reduction pore size.

Furthermore, Table 1 reports an increase of compressive strength while increasing the ratio of magnesium to phosphate (Mg/P). Meaning that the deflocculation and coagulation strategy develop to achieve a SCCC improve the final compressive strength of the mixtures.

	Reference	0.8wt% NaHMP	0.8wt%NaHMP+ MgO (Mg/P=1.67)	0.8wt%NaHMP+Mg O (Mg/P=4.85)	0.8wt%NaHMP+ MgO (Mg/P=5.73)
Compressive strength [MPa]	0.31 ±0.03	0.63 ±0.07	0.72 ±0.01	0.82 ±0.06	0.91 ±0.13

Table 1: Evolution of compressive strength for different of mortar samples prepared at water to clay ratio (W/C) of 0.7 and ratio sand to paste (s/p) of 1.69

These findings enable us to determine the key parameters influencing the different steps during the development of a self-compacting clay concrete (SCCC)

4. CONCLUSION

Strategy that has been tested is promising and allow developing a process to cast a clay based concrete as easily as a cement bound concrete. Through a modification of clay properties, adding NaHMP leads to a strong deflocculation of clay particles by creating repulsive forces between particles. The yield stress is reduced and earth material becomes fluid to be poured in the formwork. Then, the addition of magnesium allow to accelerate the hardening process through the dissolution of magnesium and the chemical reaction between magnesium and ions releases in pore solution.

Furthermore, on the mortar scale, we show that not only NaHMP improve the workability of the clay based concrete but also increases the compressive strength. More, the coagulant also enables to accelerate formwork removal but also influence the final compressive strength. As a consequence, water content, the percentage of dispersant, the ratio coagulant-dispersant are relevant parameters to improve earth based concrete mechanical properties, however further works need to be done to identify the effect of bigger aggregates on the compressive strength, but also the morphology of the aggregates and quality of paste on the final strength.

ACKNOWLEDGMENTS

Financial support by the Swiss National Fund (SNF) is gratefully acknowledged (project N°. 205121-153368, SCCC – Self Compacted Clay based Concrete).

REFERENCES

- [1] Andreola, F., Castellini, E., Ferreira, J.M.F., Olhero, S. and Romagnoli, M., 2006. Effect of sodium hexametaphosphate and ageing on the rheological behaviour of kaolin dispersions. *Applied Clay Science*, 31(1–2), 56-64.
- [2] Anger, R.F., Laetitia. 2009. *Bâtir en terre: du grain de sable à l'architecture*.
- [3] Lagaly, G. and Ziesmer, S., 2003. Colloid chemistry of clay minerals: the coagulation of montmorillonite dispersions. *Advances in Colloid and Interface Science*, 100, 105-128.
- [4] Landrou, G., Brumaud, C., Winnefeld, F., Flatt, R. and Habert, G., 2016. Lime as an Anti-Plasticizer for Self-Compacting Clay Concrete. *Materials*, 9(5), 330.
- [5] Moevus, M., Jorand, Y., Olagnon, C., Maximilien, S., Anger, R., Fontaine, L. and Arnaud, L., 2016. Earthen construction: an increase of the mechanical strength by optimizing the dispersion of the binder phase. *Materials and Structures*, 49(4), 1555-1568.
- [6] Morel, J.-C., Pkla, A. and Walker, P., 2007. Compressive strength testing of compressed earth blocks. *Construction and Building Materials*, 21(2), 303-309.
- [7] Ouellet-Plamondon, C.M. and Habert, G., 2016. Self-Compacted Clay based Concrete (SCCC): proof-of-concept. *Journal of Cleaner Production*, 117, 160-168.
- [8] Parra-Saldivar, M.L. and Batty, W., 2006. Thermal behaviour of adobe constructions. *Building and Environment*, 41(12), 1892-1904.
- [9] Pellenq, R.J.M., Lequeux, N. and van Damme, H., 2008. Engineering the bonding scheme in C–S–H: The iono-covalent framework. *Cement and Concrete Research*, 38(2), 159-174.
- [10] Schneider, M., Romer, M., Tschudin, M. and Bolio, H., 2011. Sustainable cement production—present and future. *Cement and Concrete Research*, 41(7), 642-650.
- [11] Shukla, A., Tiwari, G.N. and Sodha, M.S., 2009. Embodied energy analysis of adobe house. *Renewable Energy*, 34(3), 755-761.

Trend of Dynamic Glass in Green Building

HY CHIU^a

^a Full Treasure, Hong Kong SAR, hychiu@fulltreasure.com

ABSTRACT

After hundred years (200 to 300 years) when “redox-coloration” chemistry has been discovered; and the research and development on “electrochromism” which has been published for the recent fifty years; and a decade of the emergence of the electrochromic and thermochromic glass in the market, dynamic glass is one of the new trends in the green building development and help earning credit points for green building certification.

Tint of the dynamic glass is adjustable (tintable, darkened from clear) as an automatic sun-shading device when it responses to the environment which is dynamically changing including sunlight, temperature and weather. Chromogenic material is used in the dynamic glass which is darkened at the presence of a physical property (such as heat, ions, UV or gas) and returning to clear when the property disappears.

Electrochromic (EC) and thermochromic (TC) and are two of the major chromogenic technologies found in the market, nowadays, as the dynamic glass in building industry, such that they change color in response to the presence of ions and heat, respectively.

The benefits of dynamic glass in buildings is to reduce the solar heat gain, UV and glare without any shading device(s), either external shading and side fins or internal blinds and curtain, and without reducing the natural daylight performance because it is always see-through, and hence enhancing the comfort level of occupant at any time. The SHGC (solar heat gain coefficient) per each dynamic glass is typically varying from 0.1 to 0.4 with the Tvis (visible light transmission rate) from 6% to 60%, respectively. The reduction of solar heat gain, cooling electricity consumption and peak cooling loading is better than the conventional low-E glazing by 58%, 10% and 22% respectively, and hence the overall energy cost saving is 17% to 30% which makes it the next generation of glazing in buildings.

Keywords: energy saving, high-performance building, dynamic glass

1. INTRODUCTION

Since 1990's, the conscious about environmental protection had led to the “green” considerations in the design and construction of buildings in order to reduce the harms to the earth and optimize the limited resources in the earth. The standards of green building therefore emerged.

The needs of improving quality of life and the awareness of people about their health, well-being, comfort level, happiness and productivity in the built environment lead to the re-thinking about the design of buildings. Besides, the relationship between humans and the nature when they are in the buildings are also addressed. More interaction of the occupants with the nature is enabled for the new design of buildings. People are seeking for balancing to the harmony between humans and nature as it had been practised in the ancient countries. It is an extension of the section of IEQ (indoor environmental quality) in the green building certification standards to more human-oriented consideration about human-nature relationship and again to be standardized as “well building”.

Therefore, it is to investigate the re-thinking about interaction and relationship between humans and nature in buildings including: daylighting-to-health, daylighting-to-productivity, natural view-to-human; and how the dynamic glass can help in the aspects. The application includes windows, facades and skylights of buildings.

1.1 Role of window in buildings

Building shall be not only a shelter of humans, but also a comfortable place for them to stay in and minimizing the harm to the earth when either the construction of the building or post-occupancy. Window (and skylight) is one of the major interfaces between humans and nature in buildings.

However, architects are always facing the trade-off between visible light transmission and solar heat gain when designing windows because of the nature of sun light which is a spectrum of ultra-violet (UV), visible light and infra-red (IR) with wavelength of 10 to 400nm, 400 to 700nm and 700nm to 1mm, respectively. When designing window, architects always want the clearest and the largest glass panel the possible to maximize the view and connecting to outdoor for occupants. But it is also the most energy consuming because of the greatest heat transfer through the glass is by radiation (solar heat gain), which is the primary mode of heat flow including conduction and convection; and accounting for over 50 to 93% of heat flow from different directions of buildings.

Therefore, additional design of shading such as external shading, overhang above windows, automatic sun-shading device, internal blinds, shades, curtains; and the orientation of the building facing to the sun over a year are considered to prevent excess energy for HVAC about cooling and heating load in summer and winter, respectively.

However, the blinds or shades remain shut in 59% of area of windows and over 75% of buildings have more than half of their windows are shut by blinds or shades. This includes residential and commercial buildings. This means the function of windows in building is not fully utilized as designed.

As a result, the shade – becomes an unexpected barrier between the occupants and the outdoor view. It may cause decreasing the productivity and health of occupants, gradually, who are not aware.

As part of the evolution of glass over thousand years, dynamic glass can help eliminating the barrier of disconnecting occupants and outdoor view in traditional window and shading system and without compromising the view and solar heat gain.

1.2 Humans in buildings

Productivity of occupants in office will be increased by direct daylighting and/ or natural view available to them, because daylighting enhances positive attitude, improving mood, holding attention, lower absenteeism, fewer errors or defects in products, reduced fatigue, and reduced eyestrain, reducing stress, decreasing anxiety. Proper use of daylighting decreases the occurrence of headaches, SAD (seasonal affective disorder) and eyestrain. People have different response to open view and reflecting on their behavior and activity in building. For example, the garden view enhances the creativity of the occupants.

This can be achieved by having employees closer to windows may have contributed to the productivity increase from 5% to 25%. If it is quantified in hourly salary of employees in the office, the financial benefits is far significant more than that from the energy saving from low-e windows using nowadays. In fact, many countries in Europe require that workers be within 27 feet of a window (Franta and Anstead 1994).

The importance of daylight and large windows in school is also reflected on the finding of 7 to 18% higher scores of students in most daylighting classroom than those in rooms with the least. Their classrooms progress is 20% to 26% and 15 to 23% faster in daylighting and the largest window classrooms, respectively.

Dynamic glass resolves the trade-off between the undesired excess energy from sunlight and the human comfort, that is found in the traditional glass. Therefore, it is a trend that the user-friendly dynamic glass is used in buildings because occupants are beneficial from not only the energy saving by reducing the solar heat gain as low-e glass, but also the reconnecting of human-nature relationship by its capability of self-tinting and sun-shading; and the improvement of their well-being in the buildings.

1.3 Chromogenism in dynamic glass

Chromogenic material is used in the dynamic glass of which the optical property is changed at the presence of a physical property (such as heat, ions, ultra-violet or gas) and returning to clear when the property disappears. It is a reversible process.

Electrochromic (EC) and thermochromic (TC) are two of the major mature chromogenic technologies found in the market, nowadays, as the dynamic glass in building industry. They change the light transmission in response to the presence of ions and certain amount of heat, respectively.

Photochromic material changes the light transmission because of the presence of ultra-violet (UV). It is commonly used in sun glass.

Gasochromic material changes the light transmission because of the presence of particular gas.

SPD (suspended particles device) is controlled by electrical voltage on the liquid-like layer in which numerous microscopic particles are suspended. It changes from clear to dark when voltage is applied and vice versa. In its unpowered state the particles are randomly oriented and partially block sunlight transmission and view.

PDLC (polymer dispersed liquid crystal) has been in the market for over 25 years. It is also found in the glass called switchable glass for privacy control as the glass changes from opaque to clear when voltage is applied to the PDLC. In its unpowered stage, the PDLC molecules orient randomly to diffuse light transmission and hence leading to opaque. When voltage is applied the molecules orient in the same direction of light so the light can pass through and hence transparent.

Thermochromism and photochromism are classified as passive control as their self-tinting property; and the electrochromism, gasochromism, SPD and PDLC are classified as active control as color (or tinting level or the degree of darkness) can be manipulated by the user.

2 DYNAMIC GLASS

Over centuries, the studies in the optical effects in electrochromism were developed. For example, the early discovery of Prussian Blue as an excellent dye by Diesbach in 1704, . Berzelius , reported in 1815 about color change in tungsten trioxide with hydrogen. Wöhler, reported in 1824 about color change in tungsten oxide with sodium. Kobosew and Nekrassow, found that the tungsten oxide powders could be colored blue by electrochemical reduction in 1930. Brimm et al , mentioned in 1951 about the reversible color changes. The electrolytic recording paper was proposed by Talmey,], in 1942 for the electrochromic device. A description of electrochromism in W oxide films was made in 1953 by Kraus , . **The term “electrochromism” was introduced by Platt , in 1961. S.K. Deb’s publication about electrochromism in W oxide films in 1969, and 1973, are the widely known and cited paper.**

The term “smart window” was coined in 1984 by Svensson and C.G. Cranqvist., , . The works and published by Chang (in 1976), Faughnan and Crandall (in 1980), Byker, Harlan J. (in 1994) and C.G. Cranqvist (in 1995) , Monk, Mortimer and Rosseinsky were the important sources of literature in the development. Electrochromic mirror was developed as the rear-view mirrors in automotive market in 1994 to reduce the headlight glare from the vehicles behind. The evolution of chromogenic materials entered into commercialization in the building market since the recent decades.

2.1 Electrochromic – The product

When some of the metal oxides are ionized, it is colored; and it is reversible to colorless when de-ionized. Visible light is retained transmitting through by the electrochromic (EC) glass in the light spectrum during the action, as shown in Figure 1. Tungsten oxide (W oxide) is the most widely studied in electrochromism, while other metal oxides such as nickel oxide, iridium oxide, vanadium oxide, molybdenum oxide and etc. are also the choice. There are five thin layers of the electrochromic device as shown in Figure 2. Sputter deposition is used to coat the thin film layers on the surface of glass substrate in the vacuum chamber. It is coated on the inner surface of IGU (insulated glazing unit) called surface 2 of the outboard lite, as shown in Figure 3.

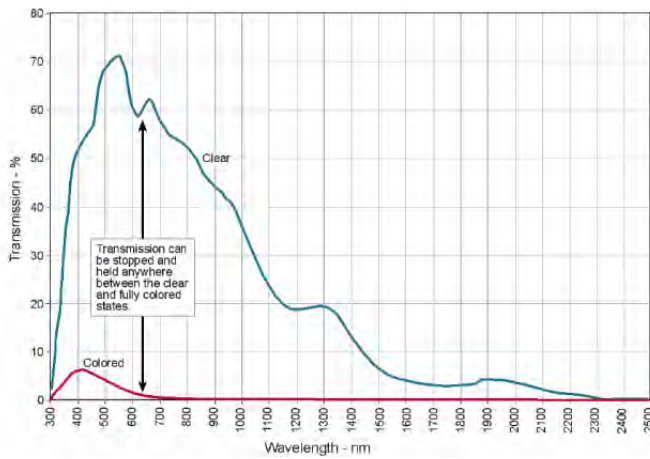

Figure 1: Shading effect of EC glass

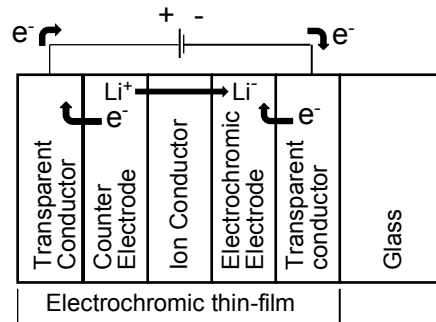

Figure 2: EC thin film

The driving or operating voltage of the EC glass is about 5V DC and the power consumption is about 1 Watt per m² when holding the tinted state; and about average on 2.8 Watts per m² during tinting.

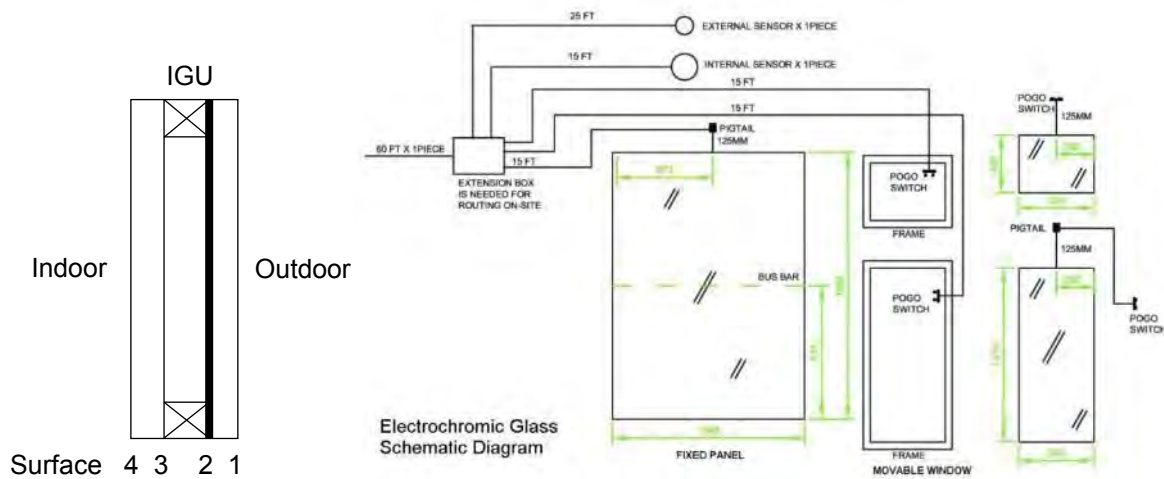

Figure 3: Section view of EC IGU

Figure 4: Schematic diagram of EC glass system

Light sensors can be installed in the system as shown in Figure 4 so the light intensity of indoor and outdoor can be compared to control the tint of the glass automatically. Manual mode is enabled when user press on the switch to over-ride the auto mode to select the desired tint at any time.

2.2 Thermo-chromic – The product

Thermo-chromic (TC) material changes to colored or more colored when absorbing heat energy, Δ ; and returning back (bleaching) to colorless or less colored when the heat energy disappears or less, $-\Delta$. It is a continuous and reversible changing process, see Figure 5. The transition time takes about few minutes to steady stage.

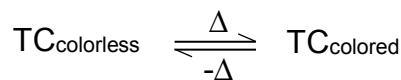

Equation 1

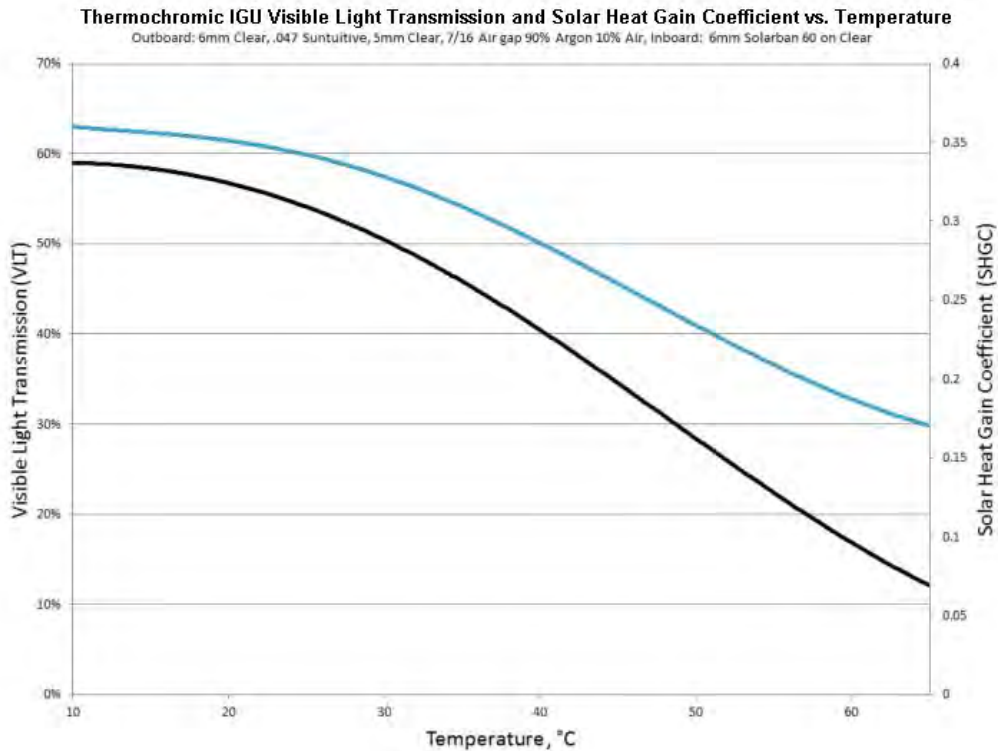

Figure 5: Response of TC glass with temperature

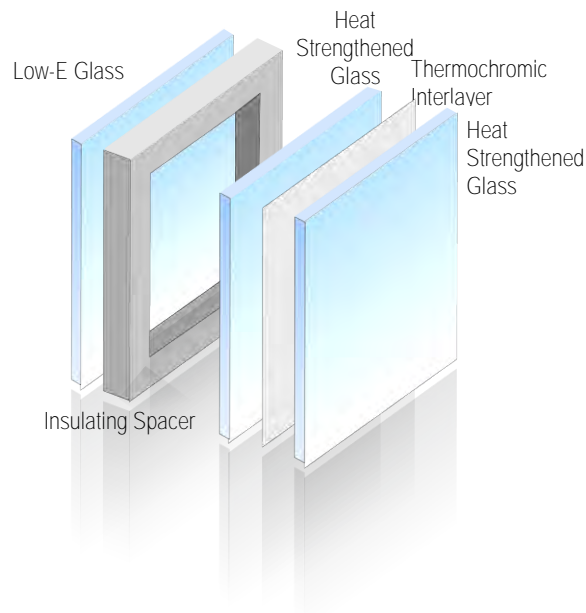

Figure 6: Construction of TC glass

Thermotropic material changes to colored completely when it reaches at a certain temperature; and returns back to colorless when drops below the temperature. It is a two stages changing process.

The TC materials are extruded with PVB (polyvinyl butyral) as a multiple layers which are laminated in between the heat strengthened glass panels, see Figure 6. Furthermore, it is integrating into normal IGU (insulating glazing unit) configuration. All the glass fabrication and lamination process are the typical standard process in the glass industry. From the installation point of view, there is no difference between TC and traditional glass since it does not require any electrical power and wiring as EC glass.

2.3 Quality

As one of the members of glass family, quality standards on dynamic glass are the same in the industry such as ASTM C1046, ASTM C1048, ASTM C1172, BS6206 and etc.

In addition, for the electrochromic glass, ASTM E2141 “Standard Test Method for Accelerated Aging of Electrochromic Devices in Sealed Insulating Glass Units” is commonly referred to describe about the testing and life time of the product.

3. BENEFITS FROM DYNAMIC GLASS

Some of the benefits from dynamic glass are summarised as following. Not only the outperform of the shading of solar heat gain and energy saving over the traditional glass, but also the enhancing human comfort through connecting to the outdoor by the dynamic glass.

Occupant Comfort

- Reduction of heat gain
- Reduction of glare
- Reduction of temperature differential
- Block 99.96% UV and prevent fading of furniture and covers
- Optimal daylighting and view
- Connection to outdoor undistorted view
- Natural lighting
- Increase productivity of occupant

Energy Saving

- Up to 30% energy reduction of buildings
- Reduce heat gain by 58% over low-e glass
- Powered by heat of sun, no electrical power (for thermochromic)
- Low solar heat gain coefficient SHGC (or shading coefficient SC)
- Reduce HVAC and lighting costs
- Downsize heating and cooling system
- A LEED product

Sustainability

- Most energy efficient window system
- Adding values to the buildings
- Adaptive to sunlight changes
- No energy cost (for thermochromic)
- No operation cost (for thermochromic)
- Maintenance-free (for thermochromic)

Design Versatility

- To all types of building, new construction or retrofit (for thermochromic)
- To all possibilities of glass, IGU, curved, shaped, specific thickness
- Window, skylight, façade, vertical or sloped
- Constructed by laminated heat strengthened glass panels (for thermochromic)

3.1 Heat gain reduction

Figure 7 shows the reduction of glare and heat from the sunlight. The chart in Figure 8 shows an example of significant reduction in heat gain with over 80% by thermochromic (TC) glass comparing with conventional glass.

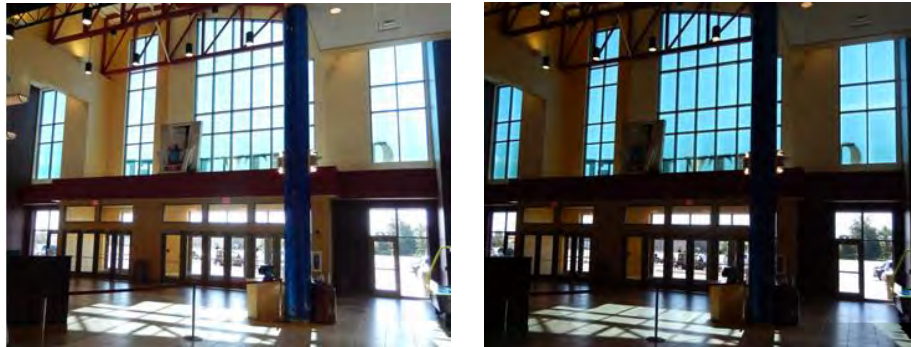

Figure 7: Change of tint of the dynamic glass

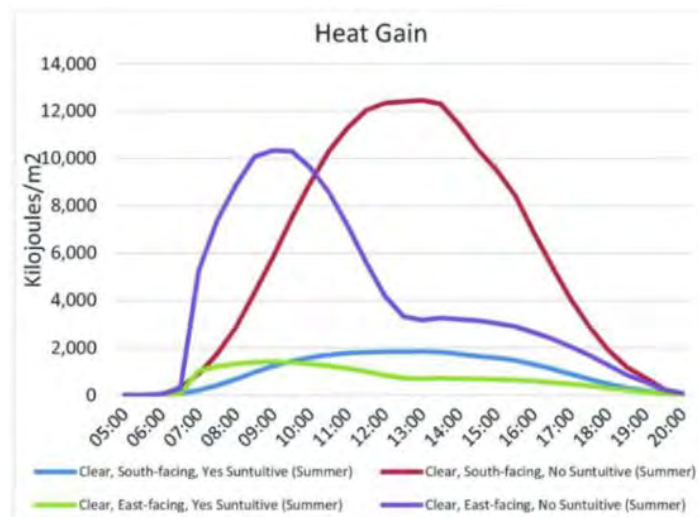

Figure 8: Heat gain reduction of TC glass

3.2 OTTV

Dynamic glass helps drop the OTTV 20 to 70% because of the significant shading capability which is shown in the value of SC, shading coefficient.

$$\text{OTTV}_w = \frac{\text{heat conduction} + \text{heat radiation}}{A_{ow}} + (A_{fw} \times SC \times \text{ESM} \times \text{SF})$$

Dyn Glass: SC=0.1
IGU (lowE): SC=0.3

= Overall thermal transfer value of the external wall, W/m²

4. CONCLUSIONS

As the next generation of glass, dynamic glass differentiates from “static” (traditional) glass through its adaptive tinting property to the outdoor environment and climate which are changing dynamically. It enhances the interaction between humans and nature and hence improving their well-being and productivity in buildings.

Cost of the dynamic glass is one of the crucial factors of success for massive application in the market. Due to the simplicity of thermochromic (TC) glass in terms of manufacturing, supply-chain model, installation, operation and maintenance, the cost is about one-third to half of that of electrochromic (EC) glass.

The premium cost of dynamic glass over traditional glass is about 30 to 50% more for TC glass and 2 to 2.5 times more for EC glass. It is offset by the outperform of energy saving from less HVAC load and artificial lighting load. The total life-cycle cost (LCC) of the dynamic glass system in long-term is lower than that of traditional glass. The payback period of the dynamic glass is about 3 to 10 years depending on the design and location of the building and electricity cost.

Besides, together with the extended design flexibility of the dynamic glass over the traditional glass and all makes it a new trend in modern buildings.

REFERENCES

- [1] Berzelius J.J., *Afhandlingar I fysik*, 1815. kemi och mineralogy 4, 293-307.
- [2] Brimm E.O., J.C. Brantley, J.H. Lorenz and M.H. Jellinek, *J. Am. Chem. Soc.* 73, 5427-5432.
- [3] Byker, Harlan J., Jul. 2000. Thermochromic Devices, U.S. Patent 6,084,702.
- [4] Byker, Harlan J., Sep. 2002. Thermochromic Devices, U.S. Patent 6,446,402.
- [5] C. G. Granqvist, 1995. *Handbook of Inorganic Electrochromic Materials*, Elsevier, Amsterdam.
- [6] **"Code of Practice for Overall Thermal Transfer Value in Buildings"**, Building Authority, Hong Kong, April 1995.
- [7] Deb S.K., 1969. *Appl. Opt. Suppl.* 3, 192-195.
- [8] Deb S.K., 1973. *Philos. Mag.* 27, 801-822.
- [9] Eleanor S. Lee, Xiufeng Pang, Sabine Hoffmann, 2013. An empirical study of a full-scale polymer thermochromic window and its implications on material science development objectives, *Solar Energy Materials and Solar Cells*, 116 (2013) 14-26, Elsevier.
- [10] Helen Rose Wilson, 2002. Chromogenic Glazing: Performance and Durability Issues as addressed in IEA Task 27, IEA Solar Heating and Cooling Programme, Task 27.
- [11] **Jonah "Cecil" Scheib**, Russell Unger, December 2013. *Seduced by The View: A Closer Look at All-Glass Buildings*, Urban Green Council, the USGBC of New York..
- [12] **J. L. Warner, M. S. Reilly, S. E. Selkowitz, D. K. Arasteh, and G. D. Ander**, 1992. **"Utility and economic benefits of electrochromic smart windows"**, *Proceedings of the ACEEE 1992 Summer Study on Energy Efficiency in Buildings*, August 30 - September 5, 1992, Pacific Grove, CA. LBL Report 32638, Lawrence Berkeley Laboratory, Berkeley, CA.
- [13] Kaufman G.G., 1981. *Inorganic Coordination Compounds: Nobel Prize Topics in Chemistry*, Heyden, Philadelphia.
- [14] Kobosew N. and N.I. Nekrassow, 1930. *Z Elektrochr.* 36, 529-544.
- [15] Kraus T., Laboratory Report at Balzers AG, Liechtenstein (entry made 30 July 1953), unpublished.
- [16] L. Edwards and P. Torcellini, July 2002. A Literature Review of the Effects of Natural Light on Building Occupants, National Renewable Energy Laboratory.
- [17] Lisa Heschong, October 2003. *Windows and Classrooms: A Study of Student Performance and the Indoor Environment*. Heschong Mahone Group.
- [18] Neil L. Sbar, Evaluation of Integrated Wall Systems Incorporating Electrochromic Window, Small Business Innovation Research Program, U.S. Department of Energy.
- [19] Paul Monk, Roger Mortimer and David Rosseinsky, 2007. *Electrochromism and Electrochromic Devices*, Cambridge University Press.
- [20] Platt J.R., 1961. *J. Chem. Phys.* 34, 862-863.
- [21] Svensson J.S.E.M. and C.G. Granqvist, 1984. *Proc. Soc. Photo-Opt. Instrum. Engr.* 502, 30-37.
- [22] Svensson J.S.E.M. and C.G. Granqvist, 1985. *Solar Energy Mater.* 12, 391-402.
- [23] Talmey P., 1942. U.S. Patent 2,281,013.
- [24] Talmey P., 1943. U.S. Patent 2,319,765.
- [25] Wöhler F., 1824. *Ann. Phys.* 2, 350-358.

Upgraded Mineral Sand fraction from MSWI Bottom Ash: An Alternative Solution for the Substitution of Natural Aggregates in Concrete Application

Jacques Rémy MINANE^a, Frédéric BECQUART^b, Nor-Edine ABRIAK^c, Christophe DEBOFFE^d

^a *IMT Lille-Douai, LGCgE-GCE, France, remyminane@gmail.com*

^b *IMT Lille-Douai, LGCgE-GCE, France, frederic.becquart@imt-lille-douai.fr*

^c *IMT Lille-Douai, LGCgE-GCE, France, nor-edine.abriak@imt-lille-douai.fr*

^d *Néo-Eco Développement, France, cdeboffe@neo-eco.fr*

This paper was presented at SBE16 Sydney Regional Conference. Please view the full paper [here](#).

Autonomous Repair in Cementitious Material by Combination of Superabsorbent Polymers and Polypropylene Fibres: A Step Towards Sustainable Infrastructure

Souradeep GUPTA^a, KUA Harn-wei^b, PANG Sze-dai^c

^a National University of Singapore, Singapore, souradeepnus@gmail.com

^b National University of Singapore, Singapore, bdgkuahw@nus.edu.sg

^c National University of Singapore, Singapore, ceepsd@nus.edu.sg

ABSTRACT

Manual maintenance and repair of cracks in concrete structures are often unsustainable because of associated labor, capital and environmental damage. Introduction of microfibers and superabsorbent polymers is a material solution to restrict crack propagation and enhance self-healing efficiency. Therefore, the study focus on development of a more sustainable cementitious system (cement mortar) comprising of polypropylene(PP) fibers and superabsorbent polymers (SAP) which would facilitate autonomous healing and recover original mechanical and durability properties of mortar.

To investigate crack sealing and recovery in mechanical and durability properties of mortar post healing, specimens were damaged by compressive and flexural loading. Mechanical strength, sorptivity and water penetration of healed mortars were compared to that of undamaged mortar at same age to estimate recovery of original properties while crack sealing was investigated by means of optical microscopy. Experimental results show mortar with combination of PP fibers and SAP showed full recovery of mechanical strength after healing while recovery in durability up to 90% was recorded. Microscopic images show that average crack-sealing ratio of 85% could be achieved under moist condition by combination of SAP and PP fibers while sealing under drier air curing condition is also significantly higher than reference samples with only fibers. Crack width up to 330 μ m has been found to be completely sealed by carbonate crystals. Furthermore, mortar with SAP and PP fibers retain about 70% of their original 28-day strength after three cycles of loading while reference mortar samples were found to retain only about 40-50% of their original strength.

Effective crack sealing and high recovery of original properties in mortars with SAP and fibers suggest that this material combination would reduce the need for environmentally damaging and expensive repairs during the service life which will be an important step towards achieving economical and environmentally sustainable construction practice.

Keywords: super absorbent polymers, self-healing, green construction technology

1. INTRODUCTION

Cementitious materials are prone to cracking due to action of various loading and environmental factors. Cracks give easy passage to foreign chemicals and moisture into concrete structures which affect its serviceability. Therefore, if micro-cracks can be healed at early stage, it will reduce further propagation and arrest access of contaminants into the structure. Manual repair of cracks is often limited due to accessibility and high cost. Moreover, chemical or cement based repair materials present threats including material incompatibility, health and environmental hazards (De Muynck et al., 2010) which makes their use highly unsustainable. Self-healing in cementitious material is a sustainable solution to maintenance of concrete structures because it reduces the manual repair operations and concomitant environmental hazards. Although cementitious materials including cement mortar possesses autogenous self-healing capability by secondary hydration of calcium silicate hydrate and precipitation of calcium carbonate, the effectiveness of such healing mechanism is only limited to narrow cracks (Edvardsen, 1999; Ter Heide, 2005). Yang et al. (2009) observed complete healing of crack width below 50 μ m while cracks beyond 150 μ m were partially healed. It is concluded from the existing studies that the most essential conditions for effective autogenous self-healing in mortar include presence of calcium or carbonate ions, presence of moisture and restriction of crack width typically between 50 – 150 μ m (Yang et al., 2009). Therefore, it means

that effective healing can be obtained by a dedicated material design which can restrict crack width and source for moisture at the crack site for secondary hydration and precipitation of carbonate to seal cracks.

This study investigates the material design by combination of two different mechanisms on autogenous healing capacity in mortar. The first mechanism is the introduction of polypropylene (PP) fiber to restrict crack widths through bridging action during matrix micro-cracking or macro-cracking. The second mechanism involves the use of superabsorbent polymers (SAP) which can absorb high volume of moisture (up to 500 times of its own weight) and retain in its structure without dissolving. The moisture retained by SAP particles are gradually desorbed and made available for further hydration in the cement matrix. Lee et al. (2010) observed the healing effect of SAP by expansion and blocking of crack opening when moisture ingress through cracks takes place. SAP can also provide internal healing because it absorbs water from surrounding and seal cracks by secondary hydration. Snoeck et al. (2014) reported that combination of PVA fibers and SAP offer effective self-healing even when moisture is not available through secondary hydration and precipitation of calcium carbonate which seal cracks. However, besides sealing of cracks recovery of original properties post-healing is essential for delivering durable and sustainable infrastructure.

The objective of this study is to investigate the ability of combination of SAP and PP fibers to recover mechanical and durability properties of cementitious mortar after healing of damage created by structural loading. In addition, recovery of compressive strength after multiple cycles of loading and sealing of cracks under two different curing conditions is also studied in this article.

2. MATERIALS AND METHODS

The materials used in the study include CEMI 52.5 N Portland cement (500 kg/m^3) which meets ASTM C150 specification, natural sand (1375 kg/m^3) with specific gravity of 2.55 and fineness modulus 2.54, polypropylene fibers (manufactured by W.R.Grace Singapore) and potassium based ionic superabsorbent polymers with average particle size ranging between 130-180 μm and water uptake capacity of $56 \pm 1 \text{ g/g}$ of SAP. The average length of polypropylene fibers used in the study is 19 mm with elastic modulus of 3.50 GPa and density 0.91 g/cc .

The mix designs of different batches prepared are mentioned in Table 1. Water-cement ratio is maintained at 0.40 for all the mixes. From initial tests on effect of dosage on mortar properties it was confirmed that 0.70% of SAP and 0.60% addition of PP fibers by weight of cement do not affect strength and permeability. Therefore, the combination of PP fibers and SAP comprised of 0.70% SAP and 0.60% PP fiber by cement weight. Two other mixes - with only 0.60% fiber and only 0.70% SAP were studied as reference for comparison of recovery of original concrete properties with those in samples with combination of SAP and PP fibers.

Mix codes	Mix description	Mix ratio (cement:sand:water:SAP:fiber)	Curing condition
Plain mortar	Without SAP and fiber	1:2.75:0.4	
Fib0.60_REF1	Mix with 0.60% PP fiber	1:2.75:0.4:0:0.006	
SAP0.70_REF2	Mix with 0.70% SAP	1:2.75:0.4:0.007:0	27±2 °C, RH>95%
M1	Mix with 0.60% PP fiber and 0.70% SAP	1:2.75:0.4:0.70:0.007:0.006	

Table 1: Mix design and description used in this study

2.1 Methodology to study self-healing

At age of 14 days the samples are subjected to compressive strength test. Strength test has been done to ascertain the compressive strength of the samples from each batch to determine the pre-loading load levels which are 50% and 70% of 14-day strength. After introduction of damage by pre-loading at 14 day, the samples are allowed to cure at $25 \pm 2^\circ\text{C}$ and $> 95\%$ RH for three weeks for the healing to occur. After three weeks of curing, the samples have been tested for mechanical strength and durability properties to calculate recovery post-healing. At the time

pre-loaded samples are tested for recovery of mechanical and durability properties, the samples are 35 day old (14 day of initial curing +21 days of healing period) from the day of casting. Therefore, to estimate the extent of recovery of original properties (if there were no damage), undamaged samples were tested for the same mechanical and durability properties after 35 days of curing. While compressive and flexural strength tests have been conducted to enumerate recovery in strength, sorptivity and depth of water penetration tests are conducted to estimate recovery of durability properties post-healing. Minimum of three samples is tested to attain statistically relevant results. While mechanical strength testing and water penetration was conducted following BS EN standards, sorptivity has been conducted following ASTM C1585. Recovery of mechanical and durability properties upon self-healing is calculated using the following expressions.

$$\text{Recovery in strength} = \frac{\text{Peak strength (MPa) after healing}}{\text{Peak strength (MPa) of undamaged samples at 35 day}}$$

$$\text{Recovery in penetration depth} = \frac{\text{Maximum penetration (mm) in undamaged sample at 35 day}}{\text{Maximum penetration depth (mm) after healing}}$$

$$\text{Recovery in sorptivity} = \frac{\text{Initial sorptivity } \left(\frac{\text{mm}}{\sqrt{\text{s}}}\right) \text{ of undamaged samples at 35 day}}{\text{Initial sorptivity } \left(\frac{\text{mm}}{\sqrt{\text{s}}}\right) \text{ of healed samples}}$$

Recovery of initial sorptivity is considered because initial sorptivity is more sensitive to presence of micro-cracks induced by preloading of the specimens. Secondary sorptivity is contributed mostly by air voids in the specimen and therefore excluded from the calculation of recovery in sorptivity. Recovery greater equal to 1 would mean that the healed samples have completely regained the original concrete properties while a number less than 1 means partial healing of samples in terms of recovery of strength or durability.

2.2 Recovery of compressive strength after multiple loading cycle

Recovery of compressive strength under multiple cycles of loading was studied by subjecting cylinder specimens to three cycles of loading. In each cycle the specimens were loaded to 70% of their ultimate strength and were allowed to cure for 21 days between subsequent cycles of loading. The recovery of compressive strength after three cycles is expressed as percentage of 28-day strength of the mix.

$$R(\%) = \frac{\text{Compressive strength (MPa) after three cycles of loading}}{\text{28 day compressive strength of the mix}} * 100$$

2.3 Measurement of crack sealing

Sealing of cracks was monitored and recorded over a period of three weeks using optical microscope (Olympus SZX10 with Leica illumination system). Prism samples (40x40x160mm) were unloaded at the point of flexural failure and width of the crack formed at failure has been recorded. For controlled creation of crack steel fibers were placed in prism samples targeted for study of crack sealing. Cracked samples were moist cured except M1 which was both moist and air-cured during the healing period. The percentage reduction in crack width is calculated by using the following expression.

$$\text{Percentage reduction in crack width}(\%) = \frac{\text{crack width}_i - \text{crack width}_t}{\text{crack width}_i} * 100$$

crack width_t refers to average crack width recorded at time t (for example, t = 5 when crack width is measured on day 5).

crack width_i refers to average initial crack width recorded just after introduction of cracks.

3. RESULTS AND ANALYSIS

3.1 Recovery of compressive strength

It can be observed from Figure 1 that recovery ratio of strength is considerably higher in M1 at 50% and 70% preloading compared to the reference although 35-day compressive strength of M1 is similar to that of plain mortar and SAP0.70_REF2.

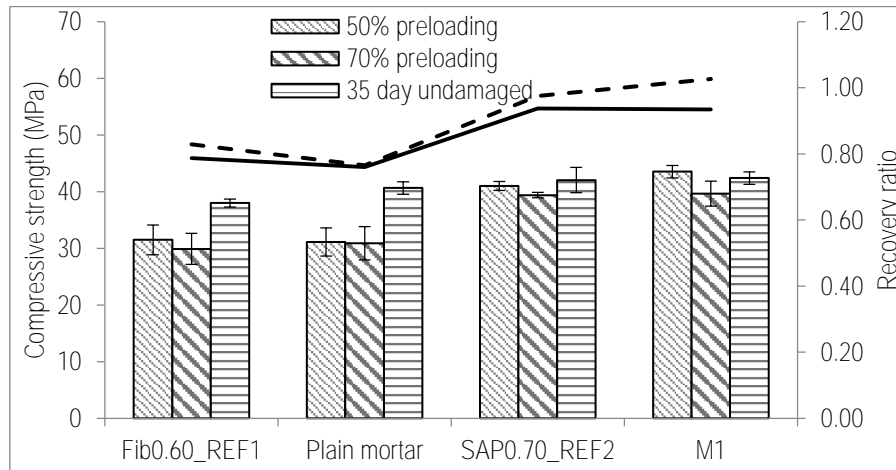

Figure 1: Compressive strength of healed samples, 35day undamaged samples and recovery ratio at 50% and 70% preloading

It can be explained by joint action of fiber and SAP where fibers tend to restrict crack width and SAP particles improve the rate of autogenous healing by supplying moisture to interior of mortar. Generation of hydration products bridge the cracks and impart strength to damaged mortar post healing. Moreover, water desorbed from SAP is rich in calcium ion which reacts with carbon dioxide from surrounding environment resulting in sealing of cracks by precipitation of calcium carbonate at the crack face. Apart from restricting crack width and increasing efficiency of autogenous healing, fibers act as anchors for calcium carbonate crystals. In absence of fibers, the carbonate crystals may not have any anchor to attach to and may be washed away by incoming fluid. SAP0.70_REF2 contained SAP but absence of fibers had little effect on restricting crack propagation which explains its lower compressive strength post-healing.

3.2 Recovery of water penetration

Figure 2 shows samples with SAP and fiber shows higher recovery ratio upon healing. In case of plain mortar and fiber reinforced mortar, healing of microcracks take longer time because of unavailability of moisture in the interior of mortar resulting in partial healing of cracks. Therefore, water under pressure can flow into the concrete without much resistance. In SAP containing samples, healing is more complete because SAP particles can absorb moisture from the moist environment (during curing) and supply for hydration to continue and heal the cracks. Moreover, near the crack faces where there are hydration products calcium carbonate precipitation takes place due to presence of calcium ion (Snoeck and De Belie, 2015).

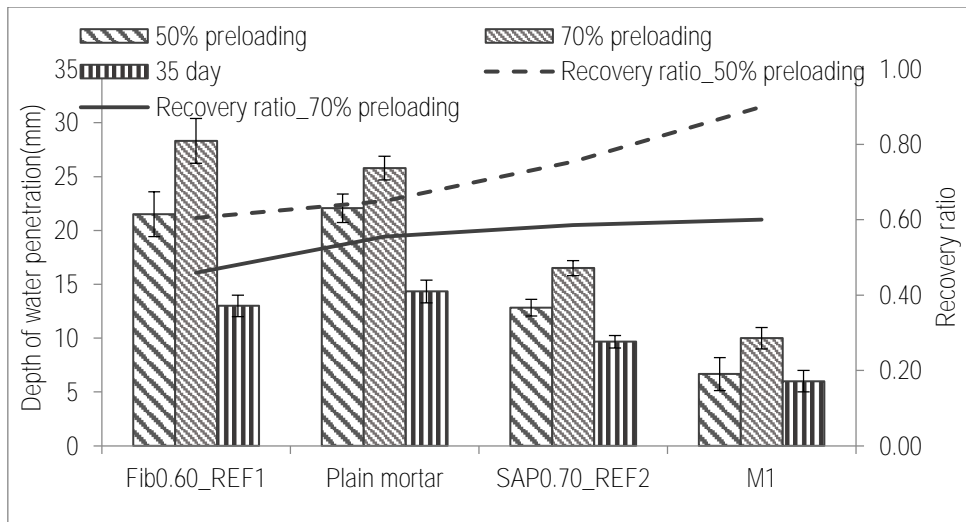

Figure 2: Water penetration depth in healed samples, 35day undamaged samples and recovery ratio at 50% and 70% preloading

Formation of calcium carbonate bridges and seals the cracks. In presence of fibers across microcracks, calcium carbonate can attach to fibers which prevent them from being washed off from the crack face. This explains higher healing ratio in M1 samples. Moreover, voids containing SAP particles create weak planes which make cracks to cross those voids. SAP s along crack faces swell immediately when it comes in contact with water thus blocking further penetration (Snoeck et al., 2014). However, when preloaded to high stress level localized wider cracks are formed which may not be sufficiently bridged by fibers or blocked by swelled SAP particles. It explains similar recovery ratio in M1 and SAP containing reference samples at 70% preloading level.

3.3 Recovery of sorptivity

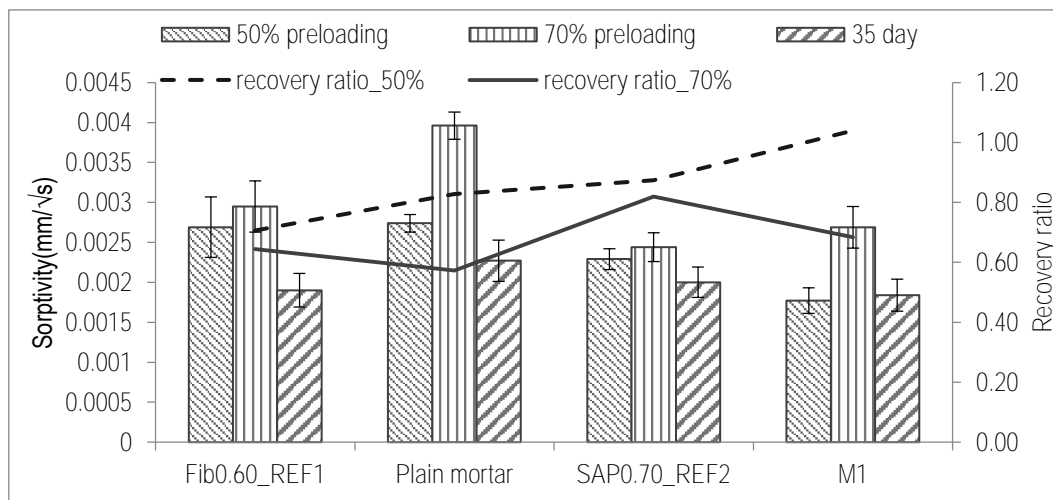

Figure 3: Sorptivity in healed samples, 35day undamaged samples and recovery ratio at 50% and 70% preloading

From Figure 3, one can observe that recovery of sorptivity is highest for M1 samples when subject to 50% preloading although at 70%, the recovery ratio is similar to the reference mortars. This may be attributable to crack profiles created in fiber reinforced mortar under stress. Incorporation of fibers bridge cracks and reduce permeability when the loading is below a certain limit called the threshold level. Above this threshold fibers may cause more localized unrecoverable deformation compared to plain mortar (Hosseini et al., 2009). 70% preloading may have introduced local deformation in the mortar that could not be fully healed or recovered which explains higher sorptivity in M1 samples at 70% preloading.

3.4 Recovery of compressive strength under cyclical loading

From Figure 4 one can observe that mix M1 retains highest percentage, about 70% of 28-day compressive strength after being subject to three loading cycles.

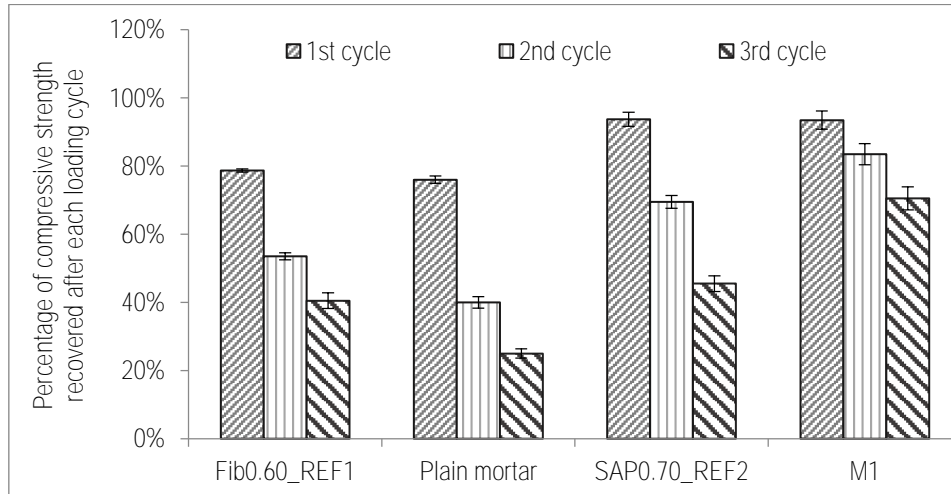

Figure 4: Recovery percentage of compressive strength of mixes subject to three cycles of loading

It may be justified by the role played by PP fibers in mitigating crack propagation which is also observed when Fib0.6_REF 1 and plain mortar are compared. Plain mortar regained only about 25% of its 28-day strength after three loading cycles compared to 40% in case of Fib0.6_REF1. Addition of SAP also plays an important part in accelerating the healing process. With age the microstructure of mortar becomes denser and therefore less external water tends to reach interior of concrete. Therefore, autogenous healing is mitigated due to lower availability of water. Due to their affinity to water, SAP plays an important role by uptaking moisture from the environment and supplying them for faster autogenous healing in damaged mortar. Therefore, controlled crack width due to addition of fibers and autogenous healing by SAP better performance of M1 samples under cyclical loading.

3.5 Sealing of cracks

Figure 5 shows that samples with SAP and fiber showed about 85% crack healing compared to only 30-40% healing in reference samples. Figure 6 (b) and (c) shows only partial healing in plain mortar and Fib0.6_REF1 samples which is attributed to limited availability of moisture at the crack site in absence of SAP particles.

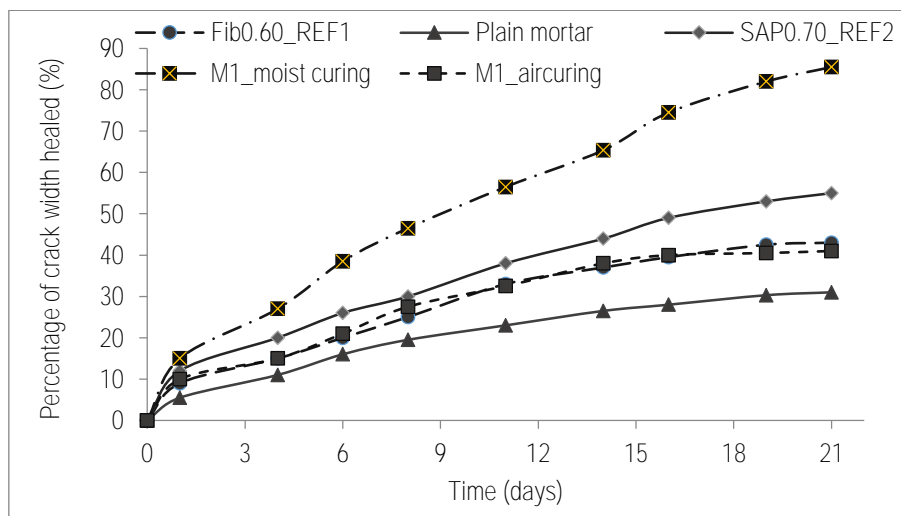

Figure 5: Percentage of crack width healed over the healing period in different mixes under moist curing condition and in M1 under moist curing and air curing condition

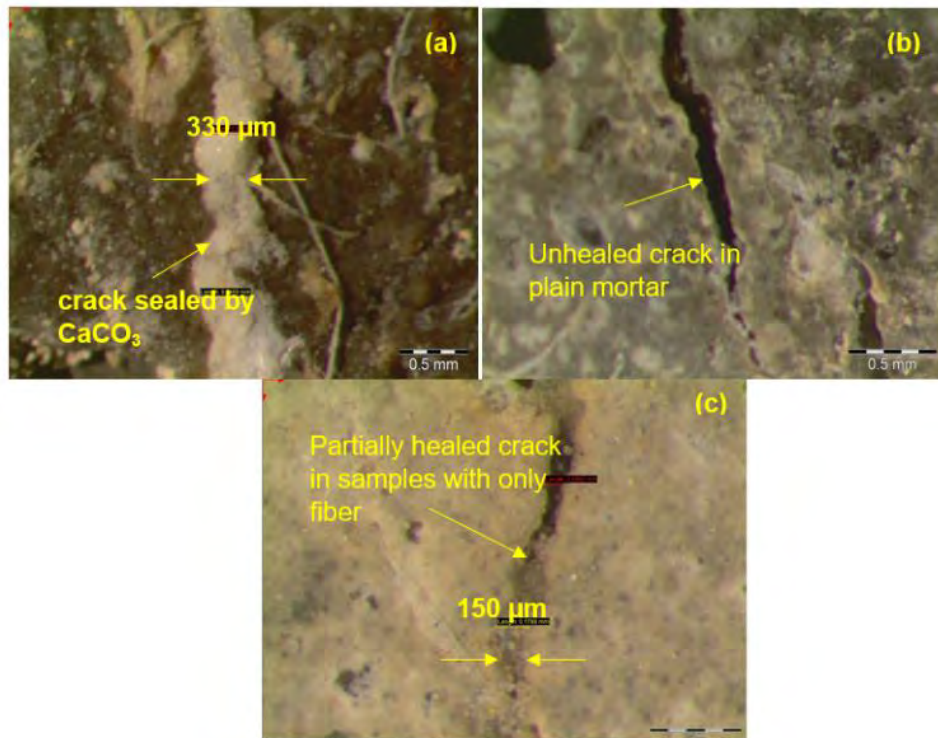

Figure 6: Crack healing in (a)M1 sample (b)Plain mortar samples and (c)Fib0.6_REF1 under moist curing condition

The range of crack width created in M1 samples was 220 – 380 μm at failure while it was in the range of 200 - 300 μm in Fib0.6_REF1. It means that M1 showed slightly higher crack width at failure which may be attributed to weak spots created due to desorption of water from SAP. While complete sealing of cracks up to 330μm was noted in M1 (Figure 6a), cracks beyond 330μm were healed partially.

The unhydrated cement particles near the crack location had ready access to moisture supplied by SAP for further hydration. Moreover, calcium ions at crack face may have reacted with water containing dissolved carbon dioxide or bicarbonate to form calcium carbonate which sealed the cracks. M1 samples placed under air curing also shows similar healing ratio as Fib0.60_REF1 which suggests that presence of SAP particles ensure availability of moisture even under dry condition to seal cracks by further hydration or precipitation of calcium carbonate. However, rate of healing under air-curing dropped beyond 12 days because most of the water absorbed by SAP has been desorbed and utilized for hydration.

4. CONCLUSION

The major findings from this study can be summarized as follows:

- Almost complete recovery of mechanical strength has been observed for samples containing SAP and fibers which is considerably higher than samples containing only fibers. It means that durable and strong infrastructure can be delivered by combining reinforcing effect of fibers and healing effect of SAP particles.
- SAP particles play an important role in sealing of crack width. In three weeks, about 85% crack width healing was observed in samples containing SAP and fibers of carbonate and formation of hydration products to seal up the cracks.
- Penetration of moisture is significantly reduced by action of SAP and fibers in healed and undamaged samples which mean that healed structures would be much less prone to damage by ingress of foreign chemicals and would require lower maintenance.

The findings suggest that SAP containing self-healing system would be most suitable in regions with high humidity. The SAP s can draw moisture from the air to facilitate self-healing by further hydration and carbonate precipitation. **However, further research is to be conducted to study this system's effectiveness in dry climate because lack of moisture may slow down or affect the rate of autonomous healing.**

Although superabsorbent polymers do not have any health hazard, some precautions may be needed while handling of polypropylene fibers. Fine polypropylene fiber filaments may penetrate in to respiratory system by inhalation that creates respiratory symptoms. Therefore, use of personal protection equipment (PPE), especially face mask and gloves are recommended while handling polypropylene fibers during preparation of concrete mix.

REFERENCES

- [1] DE MUYNCK, W., DE BELIE, N. & VERSTRAETE, W. 2010. Microbial carbonate precipitation in construction materials: a review. *Ecological Engineering*, 36, 118-136.
- [2] EDVARSEN, C. 1999. Water permeability and autogenous healing of cracks in concrete. *ACI Materials Journal*, 96.
- [3] HOSEINI, M., BINDIGANAVILE, V. & BANTHIA, N. 2009. The effect of mechanical stress on permeability of concrete: A review. *Cement and Concrete Composites*, 31, 213-220.
- [4] LEE, H., WONG, H. & BUENFELD, N. 2010. Potential of superabsorbent polymer for self-sealing cracks in concrete. *Advances in Applied Ceramics*, 109, 296-302.
- [5] SNOECK, D. & DE BELIE, N. 2015. Repeated autogenous healing in strain-hardening cementitious composites by using superabsorbent polymers. *Journal of Materials in Civil Engineering*, 28, 04015086.
- [6] SNOECK, D., VAN TITTELBOOM, K., STEUPERAERT, S., DUBRUEL, P. & DE BELIE, N. 2014. Self-healing cementitious materials by the combination of microfibres and superabsorbent polymers. *Journal of Intelligent Material Systems and Structures*, 25, 13-24.
- [7] TER HEIDE, N. 2005. Crack healing in hydrating concrete. Delft University of Technology.
- [8] YANG, Y., LEPECH, M. D., YANG, E.-H. & LI, V. C. 2009. Autogenous healing of engineered cementitious composites under wet-dry cycles. *Cement and Concrete Research*, 39, 382-390.

Poster Session

Study on the Shading Performance of Expanded Metal Mesh

LIN Chien-hsun^a, TSAY Yaw-shyan^b, YANG Jhih-hong^c, YANG Yu-fang^d

^a Department of Architecture, National Cheng Kung University, Taiwan, hsunhsun16@gmail.com

^b Department of Architecture, National Cheng Kung University, Taiwan, tsayys@mail.ncku.edu.tw

^c Department of Architecture, National Cheng Kung University, Taiwan, johny8910@hotmail.com.tw

^d Shang Kai Steel Co., Ltd., Taiwan, salesintl@sksteel.tw

ABSTRACT

Recently, architects have praised expanded metal mesh for its visual penetration and shading performance and **thus applied it as an element in the façade design of many buildings. In Taiwan's "Technical Code for the Energy Conservation Design of Buildings", the energy conservation efficiency of a building's perforated metal sheets can be determined using the shading factor K_i , which is related only to perforation rate.**

However, some previous studies on perforated metal sheets have suggested that material, color, emissivity, opening shape, and distribution can also influence their energy saving performance. Some studies have even demonstrated that when expanded metal mesh is used for shading purposes, different specific angles of solar radiation can have a significant impact on the energy conservation effect. This phenomenon occurs because the opening form of expanded metal mesh is a type of three-dimensional pattern.

In this study, we built an experimental house with a single room and performed field measurements to investigate the shading performance of expanded metal mesh. We selected three types of expanded metal mesh with different opening forms for comparison and two types of installation angles (upward/downward) to determine the influence of solar angle. The results show that the practical shading factor in downward installation cases is lower than that in the building code, which means that the higher shading performance can be evaluated. When the perforation rates are similar, expanded metal mesh with larger holes have shown better shading performance than that with small openings. However, we found significant reduction in shading performance when the expanded metal mesh was installed upward, which is important for architects in their designs.

Keywords: shading factor, perforation rate, energy saving

1. INTRODUCTION

In recent years, designers have praised expanded metal mesh for its visual penetration and shading performance and have thus frequently applied it as an element of façade design. The difference in the shape of the openings, as well as the distribution of the expanded metal mesh, affect shading performance.

According to Taiwan's "Technical Code for the Energy Conservation Design of Buildings", the energy conservation efficiency of a building's shading device can be determined with the shading factor K_i , which incorporates different directions, depth ratio, and perforation. Considered a perforated shading device, expanded metal mesh's shading factor K_i can be calculated, but only by its vertical projection perforated rate.

However, Blanco et al. (2014) showed that not just perforated rate affects the energy saving performance of perforated metal sheets. Such factors as material, color, emissivity, opening shape, and distribution also influence the surface temperature of perforated metal sheets, thus affecting the indoor thermal comfort. Furthermore, in five different climate zones in Spain, Blanco et al. (2015) discussed the energy saving capacity of different perforation rates, materials, and colors of perforated metal sheets applied in a double-skin system. The results demonstrated that the highest energy efficiency varied, and then the best perforated rates of the perforated metal sheets were **proposed for Spain's various climate zones.**

Mainini et al. (2013) studied the manner in which the different shapes, materials, and hole distributions of perforated metal sheets and metal mesh grid influenced shading performance. Their results revealed that angle of incidence played an important role and that the three-dimensional pattern of perforated metal sheets achieved different

shading performances with specific angles of incidence. Furthermore, Mainini et al. (2015) simulated the energy saving capacity of these two devices applied on different opening ratios of an office building and found that the energy saving can significantly increase only when applied to a curtain wall building. Oowada et al. (2012) studied three different mesh sizes and two installation angles of expanded metal mesh for their shading performance with southern orientation. The results showed that the installation angles achieved different performances.

All of these studies have demonstrated that determining the shading factor K_i of expanded metal mesh by only considering its perforated rate is not enough because many factors may contribute to shading performance. Moreover, relatively few studies have addressed the effect of different mesh sizes of expanded metal mesh on indoor thermal comfort in Taiwan. This study focuses on different mesh sizes of expanded metal mesh and how installation angles may affect not only shading performance but also thermal comfort as a reference for architects.

2. MEASURING SHADING PERFORMANCE

2.1. Field measurement set-up

We built an experimental house, with the measurements of 2 m x 2 m x 2.2 m, to perform field measurements, as shown in Figure 1. The opening was located on the west side, and we installed the expanded metal mesh on half of the opening, as shown in Figure 2. Three pyranometers were set outside and inside the experimental house to compare the opening with the expanded metal mesh against the one without it. The time interval of data collection was one minute, and the experiments were carried out from 9:00 to 18:00 in the summer of 2016.

2.2. Shape and installation method of the expanded metal mesh

The sample size of the expanded metal mesh was 1 m x 1 m, and the material was aluminium, but the mesh sizes of the three samples differed, with Type A being the largest, followed by Type B and then Type C. Details of the samples are shown in Table 1. To understand how sunlight penetrates the expanded mesh grid, two installation methods, downward and upward, were measured, as shown in Figure 3.



Figure 1: Experimental house with a single room a) exterior image b) interior image

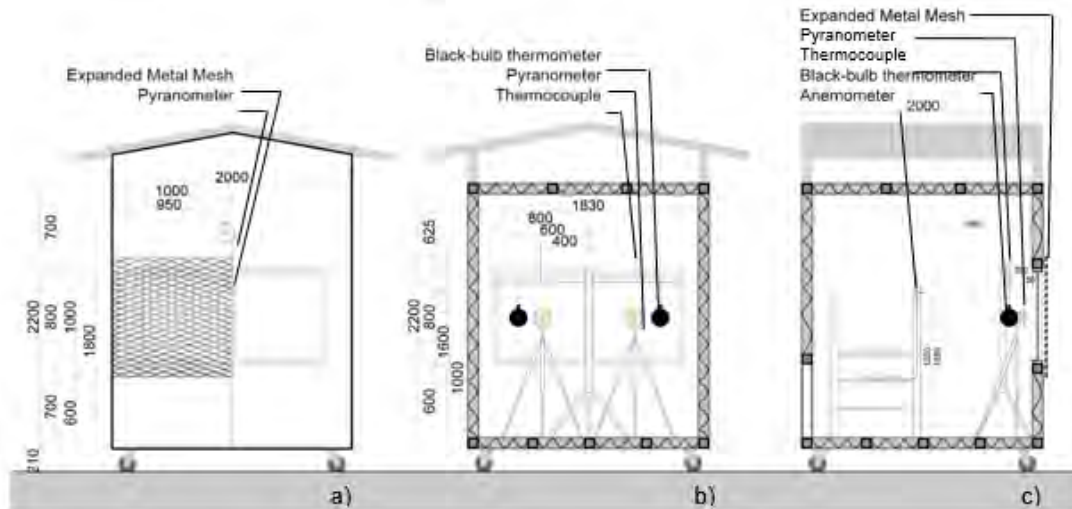

Figure 2: Dimensions of a) exterior façade b) interior façade c) section of experimental house sensor position for measurements

	Type A	Type B	Type C
LWD (cm)	13.70	10.25	7.55
SWD (cm)	5.05	3.50	3.05
W (cm)	1.40	1.00	0.75
T (cm)	0.20	0.20	0.20
MESH			
l (cm)	10.10	8.05	6.25
h (cm)	3.00	2.15	2.00
b (cm)	2.90	1.60	1.10
Perforated rate	0.56	0.58	0.64

Table 1: Features of expanded metal mesh

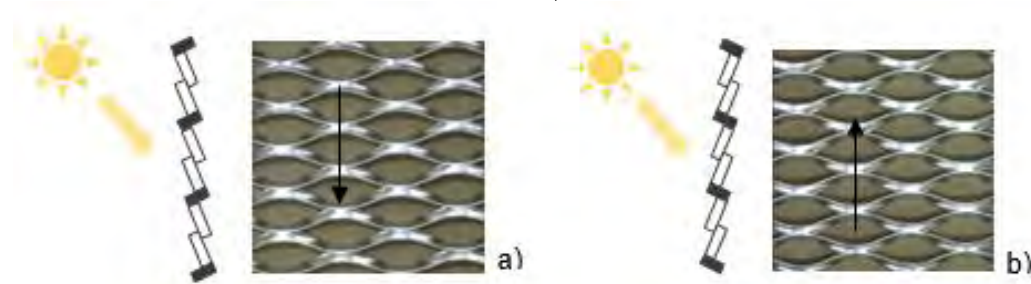

Figure 3: Installations of samples a) downward b) upward

3. RESULTS AND DISCUSSION

As shown in Figure 5, solar radiation clearly rose after 12:00 pm due to the direct sun hitting the west-facing opening. Therefore, we only discuss the shading performance of the expanded metal mesh using the data from the afternoon (13:00- 18:00). Shading factor K_i

To compare the differences between the shading factor in Taiwan's building code (Technical Code for the Energy Conservation Design of Buildings) and that obtained from our experiments, we defined the practical shading factor K_i , while the shading factor of downward and upward installation are defined as K_i^D and K_i^U , respectively.

The vertical solar radiation measured for the three kinds of expanded metal mesh with the two different installation methods is shown in Figure 6. Figure 6 a-c shows the downward installation, in which a significant reduction of solar radiation can be found in each case, and different fluctuations can be found with each different opening form. However, in the upward installation cases, as shown in Figure 6 d-f, no significant difference was found between whether expanded metal mesh was installed or not. Figure 7 shows the variation of K_i^D and K_i^U of each type of expanded metal mesh, revealing a difference of shading performance between the two installation methods. Figure 7a shows the installed downward situation, in which the K_i^D of Type A has the biggest fluctuation. This may be due to Type A having the largest mesh size. Type B was the most stable. Type C had a smaller fluctuation than Type A, but the average K_i^D , which is shown in Figure 8 is the largest, indicating that the shading performance is the worst of the three samples. This may be due to the mesh size and strand width (W) being the smallest, so this type could not effectively resist the sunlight. In Figure 7b, the K_i^U of all samples installed upward are higher than those installed downward, and the relationships of the samples revealed a similar trend. This is because the sunlight penetrated into the interior much more easily due to the mesh opening direction.

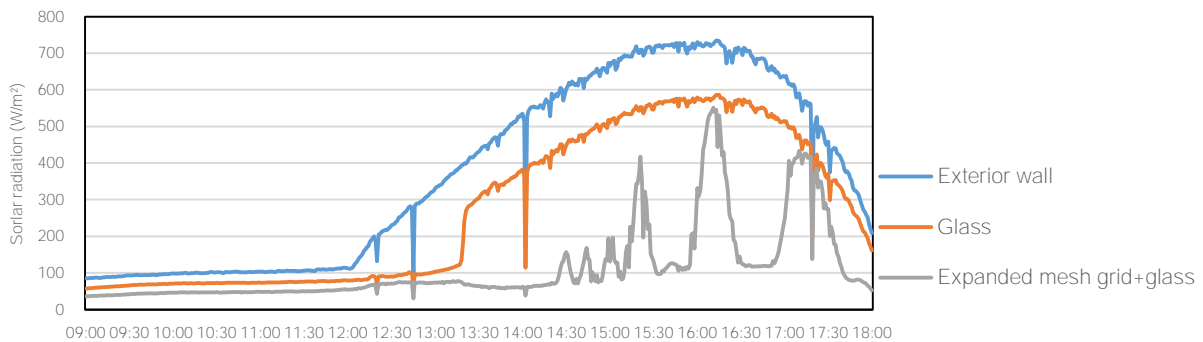

Figure 5: Variation of vertical solar radiation during 9:00-18:00 of type A installed downward

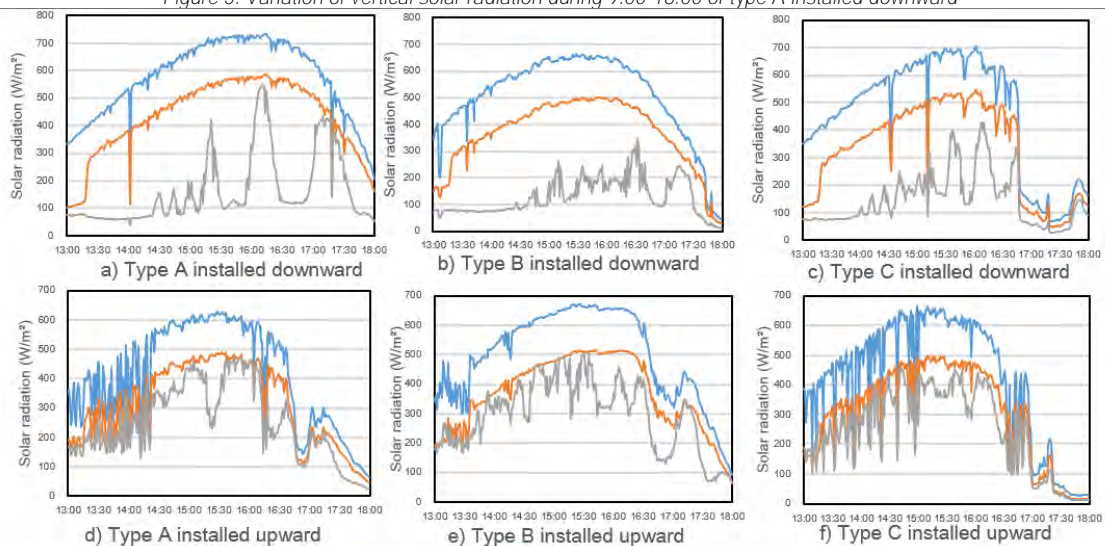

Figure 6: Variation of vertical solar radiation during 13:00-18:00

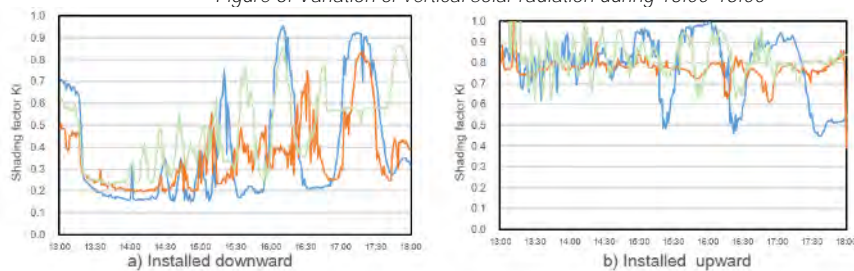

Figure 7: Comparisons of shading factor with difference installation methods

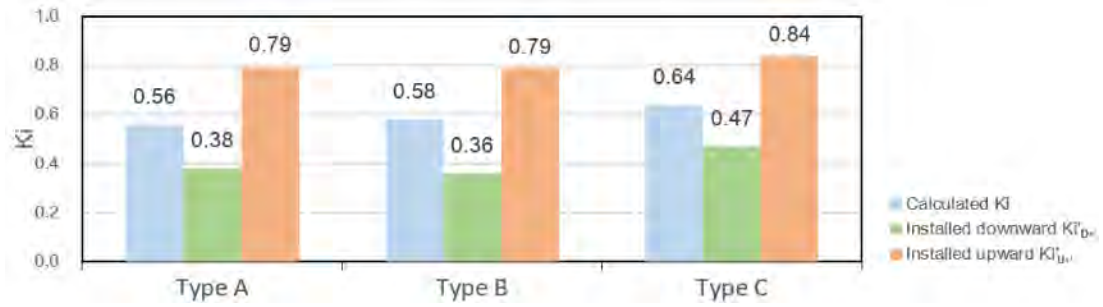

Figure 8: Comparisons of average shading factor K_i

The comparison of calculated K_i (according to the perforated rate) and average practical K_i' are shown in Figure 8. When we determined the shading performance using only K_i , which was calculated by vertical projection perforated rate alone, the shading performance may be significantly underestimated, and the influence of installation is not considered.

3.2. MRT and OT

Figure 9 shows the variation of MRT of the opening with/without expanded mesh grid. The differences between MRT and OT (operative temperature) when having expanded mesh installed or not are shown in Figure 10. In the installed downward cases, all of the MRT apparently decreased, with Type A showing the best shading performance. This difference may be caused by the shape of the mesh, as well as be related to the solar radiation, which was higher than in other cases, as shown in Figure 6a-c. Therefore, the shading performance was strengthened. In the installed upward cases, the shading effect **decreased since the practical Ki'U increased. However, even installed in the "wrong" way, ΔMRT_U around 1.42~1.36°C and ΔOT_U around 0.75~0.84°C were still found in the measurements.** Note that Type C mesh installed upward data is not available due to a technical problem.

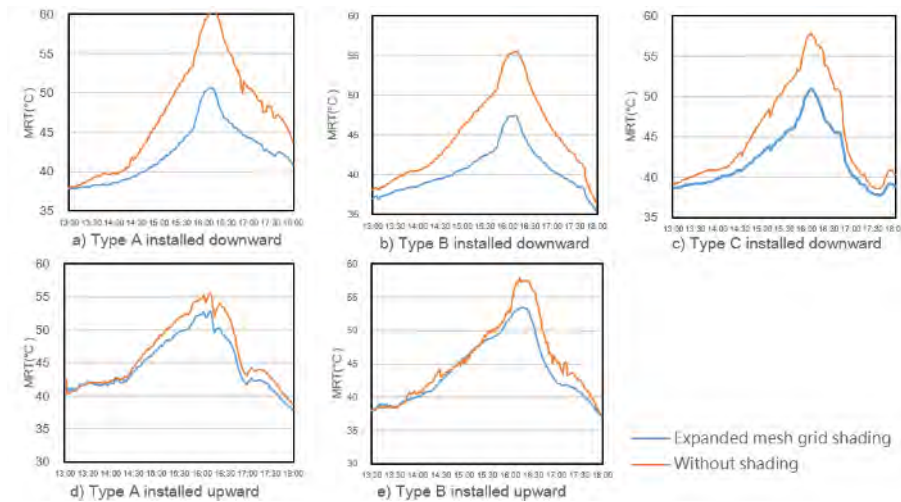

Figure 9: MRT during 13:00-18:00 of the different samples with different installation methods

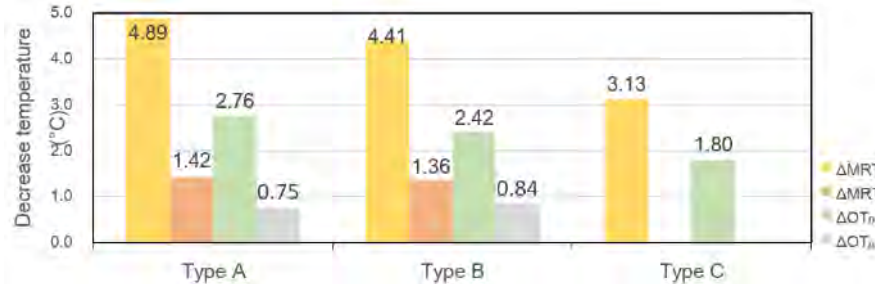

Figure 10: Comparisons of average ΔMRT and ΔOT

4. CONCLUSION

In this study, we carried out field measurements to study the shading performance of expanded metal mesh and found that only considering the perforated rate as shading factor K_i may underestimate shading performance. Furthermore, the installation method of devices plays an important role since expanded metal mesh is a three-dimensional material, and incorrect installation may reduce its effectiveness. Finally, regarding the difference of MRT and OT between the opening with/without expanded metal mesh, the reduction of MRT and can be up to 4.89°C and 2.76°C, respectively, when Type A was installed.

This research mainly focuses on expanded metal mesh installed facing west; however, discussing the influence of other directions, mesh sizes, or perforated rate would be beneficial in future studies.

REFERENCES

- [1] Blanco, J.M., Arriaga P., Rojí, E., Cuadrado, J., 2014. Investigating the thermal behavior of double-skin perforated sheet façades: Part A: Model characterization and validation procedure. Building and Environment, 82, 50-62.

- [2] Blanco, J.M., Buruaga A., Rojí, E., Cuadrado, J., Pelaz, B., 2015. Energy assessment and optimization of perforated metal sheet double skin façades through Design Builder; A case study in Spain. *Energy and Buildings*, 82, 326-336.
- [3] Mainini, A.G., Poli, T., Zinzi M., Speroni A., 2013. 'Spectral light transmission measure of metal screens for glass façades and assessment of their shading potential', *International Conference on Solar Heating and Cooling for Buildings and Industry*, Freiburg, Germany, 23-25 September.
- [4] Mainini, A.G., Poli, T., Zinzi M., Speroni A., 2015. 'Metal mesh as shading devices and thermal response of an office building: parametric analysis', *6th International Building Physics Conference, IBPC*.
- [5] Oowada, J. and Katoh, M., 2012. 'A Study on Sun Shading Effect of Expanded Metal', *The Society of Heating, Air-Conditioning Sanitary Engineers of Japan*, Sapporo, Japan, 5-7 September.

The Research of Enhancing the Performance of Impact Sound Insulation in Wooden Structure Floor

LIN Fang-ming^a, FENG Chun-hao^b, TSAI Yueh-han^c

^a National Pingtung University of science and technology, Taiwan, fmlin7@gmail.com

^b National Cheng Kung University, Taiwan, xzx679@gmail.com

^c National Pingtung University of science and technology, Taiwan, fang7799009@gmail.com

ABSTRACT

Wooden material is one of the eco-friendly materials with high sustainability. It is on the spotlight recently and getting higher standing in the world, especially countries drew up the regulations of green building and eco building material. But the performance of impact sound insulation of wooden structure floor cannot reach the same level as RC floor. In order to enhance the capability of wooden structure floor, this research set up the wooden structure floor referring by relative regulations, and conformed the performance of L_n, t, w accorded with the regulations, then investigated the effects of impact sound with various covering/surface materials. The result indicates the performance can be raised by putting resilient materials under the covering materials. As for raised wooden floor, the capabilities of impact sound insulation can be improved by inserting the rubber or glass wool under the beams.

Keywords: wooden structure floor, impact sound insulation, resilient material

1. INTRODUCTION

The impact of sound insulation in buildings with light wooden floors is normally much worse than those buildings with heavy floors such as a concrete floor. In Taiwan, most research is focused on improving impact sound insulation of heavy-weight floor such as concrete floors, but little research is about insulation of the other type, light-weight floor. Thus, this study pays attention on the impact sound property of wooden floors which is one of the light-weight floors. The reduction of impact sound by surface material on wooden floors is also taken in account in this study. The experiments of this paper are conducted in the Laboratory of Acoustic Performance in National Pingtung University of Science and Technology(NPUST), and all the experimental procedures are following ISO 140-11(2005) [Acoustics - Measurement of sound insulation in buildings and of building elements - Part 11: Laboratory measurements of the reduction of transmitted impact sound by floor coverings on light-weight reference floors] which includes methods of setting floor, measurement and rating. This research discusses the applicability of wooden floors, and the improvement of light-weight impact sound on diverse surface materials of wooden floors.

2. MEASUREMENT AND EVALUATION METHOD OF IMPACT SOUND INSULATION ON WOODEN-BASED FLOOR BY LIGHT-WEIGHT IMPACT SOUND SOURCE

2.1. Conditions of laboratory and establishment of wooden-based floor

There are two floors in the laboratory, the upper one is as for impact sound source room which the volume is 75.0 m³; the other one is sound receiving room with volume 115.0 m³. The area of impact sound testing is 10.5 m² (3.5 m * 3.0 m).

2.2. Measurement system and procedure

The thickness of bottom layer plank is 22 mm, and the density is 600 kg/m³. The height and width of truss section under the bottom plank are 120 mm and 180 mm. The length of truss is 3500 mm, and the gaps between trusses is 625 mm. The gaps are stuff with glass wool which the density is 20 kg/m³. The ceiling under the floor is made up with plasterboards which the thickness and the density are 13.5 mm and 720 kg/m³.

In this experiment, the light-weight source (tapping machine) was placed in the sound source room (the upper room), and microphones were put in the sound receiving room (the lower room). The items of measurement included the reverberation time of sound receiving room, background noise and the sound pressure level of tapping machine. The frequency measured in this research was 1/3 Octave band which range covering 100 to 3150 Hz. Besides, this experiment was conducted with 5 positions of microphones and 6 positions of impact sound source.

2.3. Calculation and evaluation method

- Impact sound pressure level

$$L_i = 10 \log \left(\frac{1}{n} \sum_{j=1}^n 10^{L_j/10} \right) \text{ dB}$$

Equation 1

In equation 1, L_j is impact sound pressure level of difference position in a room.

- Normalized impact sound pressure level

$$L_n = L_i + 10 \log A/A_0 \text{ dB}$$

Equation 2

In equation (2), L_i is impact sound pressure level, A is equivalent absorption area, A_0 is reference absorption area.

- Weighted reduction in Impact sound pressure level

$$L_{n,t,0} - L_{n,t} = \Delta L_t$$

Equation 3

$$L_{n,t,r,0} - \Delta L_t = L_{n,t,r}$$

Equation 4

$$\Delta L_{t,w} = L_{n,t,r,0,w} - L_{n,t,r,w} = 72 \text{ dB} - L_{n,t,r,w}$$

Equation 5

In equation (3)~(5), $L_{n,t,r}$ is the calculation normalized impact sound pressure level of wooden based floor with the floor covering, $L_{n,t,r,0}$ is the defined normalized impact sound pressure level of reference floor, ΔL_t is the reduction in impact sound pressure level measured in accordance with ISO 140-11(2005), $L_{n,t,r,w}$ is the calculation weighted normalized impact sound pressure level of the reference floor with the floor covering under test, $L_{n,t,r,0,w}$ is obtained from $L_{n,t,r,0}$ in accordance with Table1.

2.4. Factor types

2.4.1. The difference position and amount of light-weight impact sound source

This study hypothesized the permutations of tapping machine's position may influence the impact sound pressure level of sound receiving room. To argue this point, the experiment conducted with two cases of different amount of positions of tapping machine. In one of the cases, tapping machine was placed at 10 different positions, as Fig.1 shows. Position SL1-1 and SL1-2 were in between joints, SL2-1 and SL2-2 were at the intersection of truss and joint, SL3-1 and SL3-2 were on the joint, SL4-1 and SL4-2 were on the truss, SL5 was at on the intersection of joint and the diagonal of the room, and SL6 was at the central point of truss which was the central point of the specimen as well. There were 6 different positions in the other case: position SL1-1, SL2-2, SL3-2, SL4-2, SL5 and SL6. The single values were calculated by those cases and compared the margin between them.

Frequency (Hz)	$L_{n,t,r,0}$ (dB)	Frequency (Hz)	$L_{n,t,r,0}$ (dB)
100	78	630	72
125	78	800	69
160	78	1000	66
200	78	1250	63
250	78	1600	60
315	78	2000	57
400	76	2500	54
500	74	3150	51

Normalized impact sound pressure level weighting is 72 dB

Table 1: Normalized impact sound pressure level of the first and second type light-weight reference floor in ISO 717-2.

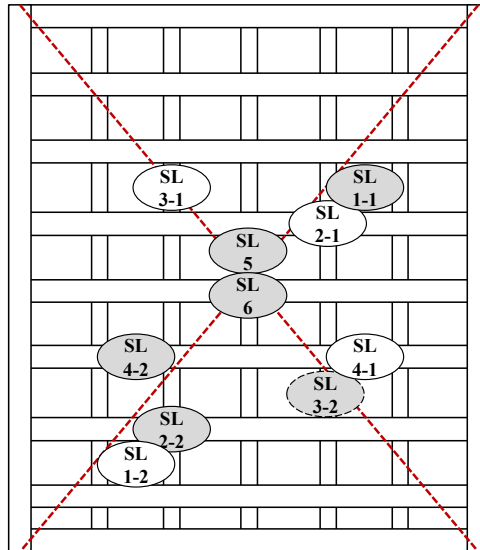

Figure 1: The difference position and amount of light-weight impact sound source on the wooden-based floor.

2.4.2. Factor conditions

To verify the applicability of impact sound experiments and the performance of impact sound insulation, the early stage of this study was focus on installing the wooden floor, discussing the application of measurement and comparison of different parameters of surface materials. The structure of surface materials on wooden floor included surface layer, raised struts, buffer materials and fillers as the Fig.2 shows. The names and sizes of application surface materials showed on table2.

structure	material	specification
surface	composite wooden floor	t = 9 mm ; d = 0.63 g/cm ³
	plywood	t = 15mm ; d = 0.60 g/cm ³
angle	southern pine	3600 mm×38 mm×90 mm ; d = 0.60 g/cm ³
filling material	glass wool	t = 25 mm ; 24K (kg/m ³)
resilience material	glass wool	t = 25 mm ; 80 K (kg/m ³)

t= thickness ; d=density

Table 2: Application materials in this study.

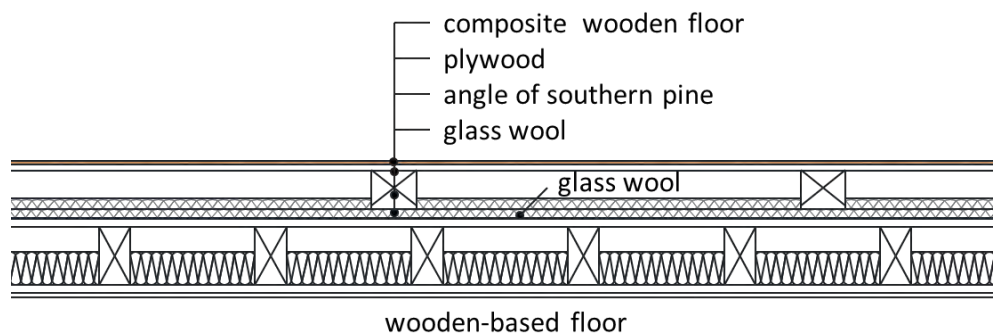

Figure 2: The wooden structure floor.

3. RESULT AND DISCUSSION

number	Surface: composite wooden floor(9 mm) and plywood (15 mm)			condition	result	
	angle	resilience material	filling material	Position amount	$L_{n,t,w}$	ΔL_t
W00a		Wooden-based floor		10	71	-
W00b		Wooden-based floor		6	71	-
W01b	-	-	-	6	63	8
W02a	h= 90 mm ; i=450 mm	-	-	10	62	9
W02b	h= 90 mm ; i=450 mm	-	-	6	61	10
W03a	h= 90 mm ; i=450 mm	-	glass wool t=25 mm	10	60	11
W03b	h= 90 mm ; i=450 mm	-	glass wool t=25 mm	6	60	11
WG01	-	glass wool t=25 mm	-	6	60	11
WG02	h= 90 mm ; i=450 mm	glass wool t=25 mm	-	6	57	14
WG03	h= 90 mm ; i=450 mm	glass wool t=25 mm	glass wool t=25 mm	6	56	15

Note: i=interval ; h=high ; t= thickness

Table3. The result of impact sound insulation of difference wooden structure floor.

3.1. Comparison of impact sound insulation of wooden-based floor

Table3 shows the results of the impact sound insulation performance of wooden floor. The $L_{n,t,w}$ of light-weight impact sound of the wooden basic floor set up referring ISO in this study is 71 dB. Compared with the standard of type 1 and 2 of light-weight in ISO 140-11, the margin between them is just 1 dB. Fig.3 shows the comparisons of each frequency of them. The T-verification also shows there is no notable discrepancy between them. As the Table4 shows, the wooden floor meets the requirement of specifications.

3.2. Comparison of difference position of light-weight impact sound source

According to ISO 140-11, the tapping machine must be placed in 6 different asymmetric positions, and the minimum of microphones must be 4 at different positions. This study discusses whether the positions of tapping machine influence the impact sound pressure level. In addition, the wooden floor is a heterogeneous material, it may cause the difference of impact sound pressure as well. Compared with single values of 3 different positions, the maximum margin is 3 dB, as Table5 shows.

3.3. Comparison of amount of light-weight impact sound source

The measured results of different amounts of tapping machine shows the difference between single values of light-weight sources is 1 dB in the condition of the raised floor (W02a, W02b). The value of R^2 is 0.9 between the cases of 10 and 6 different positions of tapping machine in three variables of wooden floor, as the Fig.4 shows. Thus, others parameters were conducted with the 6 positions case.

3.4. Improvement of impact sound insulation of wooden-based floor

The result of the experiments shows the $L_{n,t,w}$ of light-weight impact sound of wooden floor with surface material is 63 dB, it is better than the case without surface material which is 71 dB. The case of the raised floor with surface material is 60 dB.

Both of paving surface material on wooden basic floor and the raised floor have effective improvements. The improvement by the raised floor are more significant than the other above the frequency of 250 Hz. Compared with

the raised floor with and without fillers in the cavity, the $L_{n,t,w}$ of formal is 60 dB, and the latter is 61 dB. Furthermore, the $L_{n,t,w}$ can be 57 dB if put glass wools under the trusses of the raised floor, as the Fig.5 shows.

object	$L_{n,t,w}$	p-value
W00b	71	0.7
light-weight reference floor of ISO 140-11	72	

*P<0.05 ; **P<0.01 ; ***P<0.001

Table5. The single-number quantities of difference position of light-weight impact sound source.

object	$L_{n,t,w}$	p-value
Position 1-1	76	0.7
Position 5(side of the joist)	73	
Position 6(on the joist)	74	

*P<0.05 ; **P<0.01 ; ***P<0.001

Table 4: Comparison W00b and light-weight reference floor for the single-number quantities.

4. CONCLUSION

This study set up the basic wooden floor by referring ISO 140-11, confirmed the applicability of the floors, and got the patterns of different impact sound insulations. The $L_{n,t,w}$ of light-weight impact sound of basic wooden floor which built in this study is 71 dB, it tallies with the standard of ISO 140-11. The wooden floor is a heterogeneous material, and it may cause the difference of impact sound pressure as well. To minimize the difference, the positions of tapping machine should take the position of truss of wooden floor into account, and selected 6 asymmetric positions of tapping machine to enhance the accuracy. The light-weight sound insulation of wooden floors can be improved by adding surface materials. The performance can be enhanced by paving buffer materials under the trusses in the condition of the wooden raised floor.

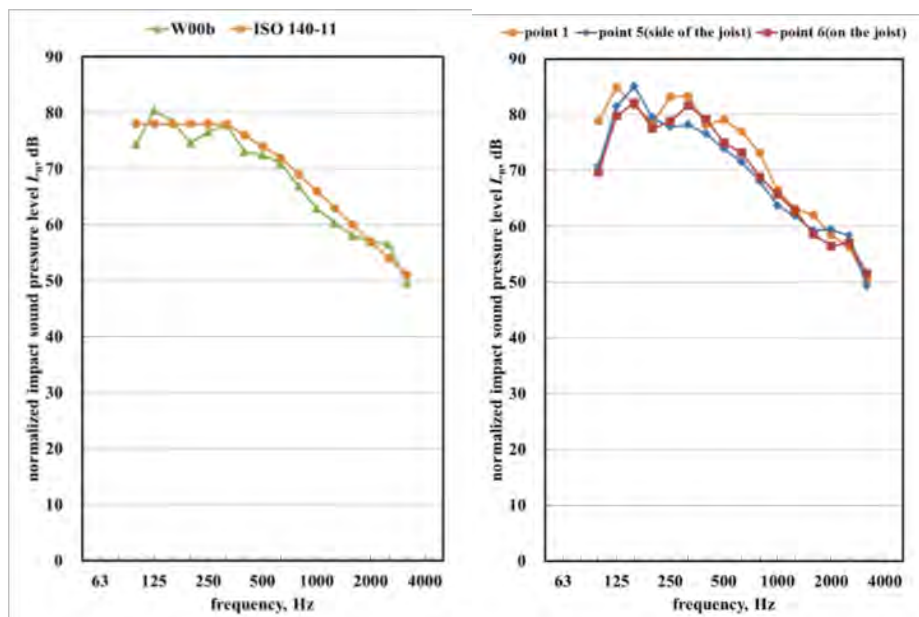

Figure 3: Comparison W00b with light-weight reference floor on $L_{n,t}$ (left) comparison of difference position of light-weight impact sound source on $L_{n,t}$ (right).

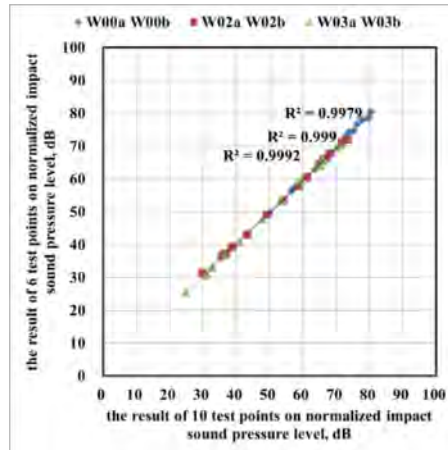

Figure 4: Comparison of relevance of difference impact sound source amount.

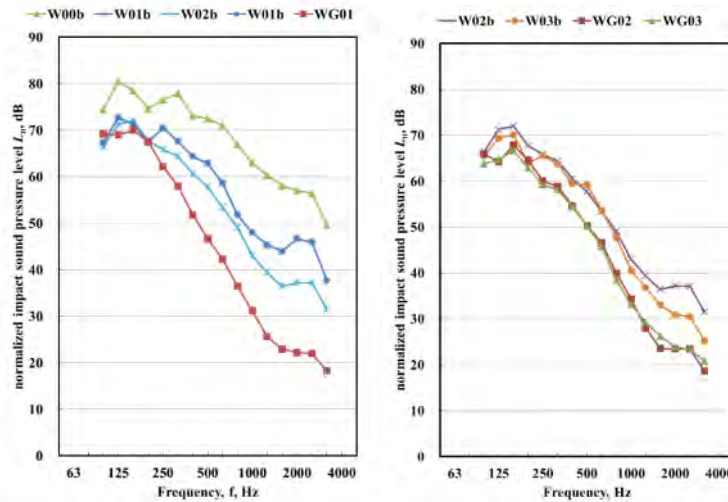

Figure 5: Comparison of impact sound insulation of difference wooden floor conditions.

5. ACKNOWLEDGEMENT

Support from the Ministry of Science and Technology of Taiwan, R.O.C. through grant NSC 101-2221-E-020-038 is gratefully acknowledged and especially grateful to ARCHLIFE Research Foundation for use of their experimental facilities.

REFERENCES

- [1] Fong, Jun-Hao, Che-Ming Chiang, Fang-Ming Lin, Sung Chin Chung, (2011) Measurement and Estimation of the wall between rooms and floors on Dwelling-Houses in Taiwan, International Conference on Multimedia Technology.
- [2] ISO 140-11(2005)Acoustics -- Measurement of sound insulation in buildings and of building elements -- Part 11: Laboratory measurements of the reduction of transmitted impact sound by floor coverings on light-weight reference floors.
- [3] ISO 717-2(1996)Acoustics -- Rating of sound insulation in buildings and of building elements -- Part 2: Impact sound insulation.

Construction of Green Residences for Ecological Immigrants - A Case Study of Ningqiang Area in the South of Shaanxi Province, China

HE Jiao^a, LI Jing^b, LIU Yu^c, WANG Ding^d

^a Northwestern Polytechnical University, Mainland China, hjiao0427@163.com

^b Northwestern Polytechnical University, Mainland China, teacherlj@nwpu.edu.cn

^c Northwestern Polytechnical University, Mainland China, liuyu@nwpu.edu.cn

^d Shanghai Construction NO.4 (Group) Co, Ltd. Architectural Design & Research Institute, Mainland China, 228575838@qq.com

ABSTRACT

The south of Shaanxi province in China is an important conservation area for “the South-to-North Water Diversion Project” and “the Han-to-Weihe River Water Diversion Project” of China. It possesses both unique ecological environments and rich historical and cultural heritages. In order to protect the source of Han River, the local government in this area has implemented a large-scale ecological immigration policy since 2013. At present, it is urgent to construct energy-saving and environmental-friendly rural residences for the immigrants. This paper analyses the characteristics of natural ecosystem, society and culture in Ningqiang Area in the South of Shaanxi Province, discusses the survey results of the traditional residences and the new houses for the immigrants, explores approaches to the design and construction of contemporary green rural residences with regional characteristics and sense of belonging, and makes suggestions for the sustainable development of green rural residences for the ecological immigrants.

Keywords: ecological immigrants, rural residences, green construction technology

1. RESEARCH BACKGROUND AND PURPOSE

The southern part of Shaanxi Province in China is an important protection area for the projects of "South-to-North Water Diversion" and "Han-Wei-Wei" project in China. It is the birthplace of Hanjiang River. It has unique natural ecological environment, rich historical and cultural accumulation. As the southern part of Shaanxi province in 2008 Wenchuan earthquake disaster area, most of the original houses were destroyed, the government launched a "post-disaster reconstruction" construction project. To protect the source of the "South-to-North Water Diversion Project" - the source of the Hanjiang River, the government has implemented large-scale ecological relocation policy since 2013.

The source of Hanjiang River is located in Hanyuan Town, which belongs to Ningqiang County. Therefore, this paper selects Ningqiang County as a case for the study. The purpose is to discuss the ways and methods of constructing green rural houses with regional characteristics and sense of belonging considering based on analysis of both the traditional houses and contemporary houses, and provide useful references for the construction of local re-settlers and relocates based on the problems in existing houses of immigrants.

2. NATURAL ECOLOGY AND SOCIAL CULTURAL CONDITIONS IN NINGQIANG AREA

2.1 Topography: Two mountains clip

Ningqiang is located in Shaanxi, Gansu, Sichuan junction, is a north-south intersection mountain counties. The terrain is varied and has "V" -shaped structure, including different geomorphic types. The highest elevation is 2103.7 meters while the minimum elevation is 520 meters. (Figure 1)



Figure 1: Location of Ningqiang county

2.2 Climate: Humid and rainy

Ningqiang is located in the hot summer and cold winter regions, it has subtropical humid climate, having the annual average temperature of 13°C, extreme minimum temperature of minus 10.3°C, extreme maximum temperature of 36.2°C. The region has high air humidity, intense rainfall and high frequent rainstorms. The overall wind direction in the summer is the southwest wind, in the winter is northeast wind.

2.3 Socio-economy: Full of mobility

Ningqiang is located in the upper reaches of the Han River region, frequent population movements causes the mobility of the social form. The local farming industry are regarded as the main source of income. With the establishment of surface transport, this region, as the transport hub of Sichuan and Shanxi province, enabling tea and other crops to be used as goods to all over the country, plays a significant role in promoting the local economic development.

2.4 Folk culture: Diversified

NingQiang is located in the region surrounded by three Qin, Chu, Shu major cultural circles, the special geographical environment makes it constantly influenced by different cultures and radiation. Coupled with the history of the great migration occurred, the culture showed a diversity of tendencies, along with the characteristics of the North-South cultural transition and the nature of the intersection.

3. TRADITIONAL RESIDENTIAL CONSTRUCTION

3.4. The traditional residential construction mode

3.1.1 Types of residence

It is found that traditional houses in Ningqiang area can be divided into two categories: "one bright and two dark" traditional adobe houses and "courtyard" courtyard houses.

"One bright and two dark" traditional adobe houses

The layout of "one bright and two dark" is the result of natural selection under the restriction of traditional ritual thought and ethics in the background of Chinese agricultural society and regarded as the most basic architectural style inherited from. "One bright and two dark" types of plane layout of NingQiang traditional houses can be divided into two types: the "—" form (Figure 2) and the "L" form (Figure 3,4), "—" form is the most basic flat form.

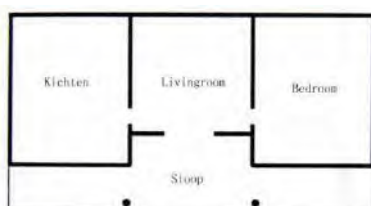

Figure 2: The "—" form plan

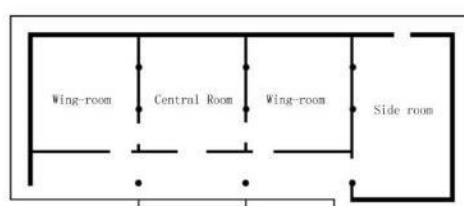

Figure 3: The "L" form plan



Figure 4: The appearance

"Courtyard" type residential courtyard

Ningqiang's trade exchanges led to the development of local commodity economy, so the local courtyard houses, according to their functions, can be divided into two types: "independent courtyard" and "front shop and back house" residences.

Independent courtyard residential flat form are shown in Figure 5, courtyard-style compound courtyard space uses one courtyard as a structural unit. The form of "Front shop and back house" is similar to the stand-alone patio layout, but it's characterized by the fact that the commercial space and living space is not absolute separated. Connected high-density shops and closed external form of the building make these houses achieve lighting, ventilation and drainage function only by using patio courtyard (Figure 6,7).

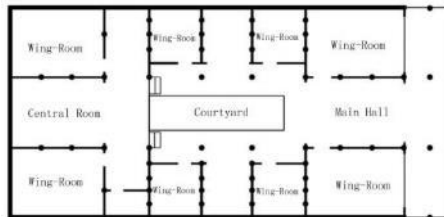

Figure 5: The courtyard house plan



Figure 6: The patio



Figure 7: Overall appearance

3.1.2 Materials technology

The material is made of local building materials suitable for the environment. The structure of residence is both uses the through-jointed frame and the post-lintel frame method. The wall is mainly rammed with 300~500mm thick rammed earth walls and the bamboo-earth walls. Because there are lots of local rainwater, the traditional houses are mostly made of stone blocks, rammed earth, (Angle range is 27°~33°). The triangular space formed in the lower part of the double-slope roof has certain heat insulation and ventilation function. The roof is made of cold-proof tiles and cold- Small green tiles. Eaves have the far-reaching construction and there are cornices under the overhead layer, both having hanging purposes. Most of the windows are open to southern walls, window frames and doors are all made of wood. In addition to building the foundation of the steps, the laying of the streets and courtyards are also covered with quartzite, the foundation part of the building wall is also built with pebbles.

3.5. Low tech ecological wisdom of the traditional residential

3.2.1 Far-reaching eaves and arcades

In order to speed up the discharge of rain, increase the disheartened space and storage space, eaves and arcades have the far-reaching construction. (Figure 8)

3.2.2 Earth and rock segmented retaining structures

Due to the wet and rainy conditions, and the wealth of wood, stone, loess, bamboo and other natural resources, local traditional houses formed with the individual architectural form which is composed by stone masonry, wood structure, and bamboo-earth retaining structure. (Figure 9)

3.2.3 Promote ventilation gable portals

In order to promote the attic space ventilation, people usually set the preformed hole on the gable. And in the winter , people close the hole with wood or bamboo for reduce the loss of warm air. (Figure 10)



Figure 8: Far-reaching eaves and arcades



Figure 9: The gable structure



Figure 10: The hole on the gable structure

4. THE CONSTRUCTION OF CONTEMPORARY RURAL HOUSE

4.3 The contemporary rural house construction mode

Through the field survey of contemporary self-built houses (Figure 11), it is found that the layout has the following features: compact layout, mostly three-bay and multi-deep layout; brick-concrete structure, the main materials are **clay brick and shale Brick; roof can be divided into flat roof or sloping roof, slope roof's form is a combination of** traditional residential sloping roof form, the makers add a wooden roof structure above the flat roof; Window area is generally larger than the traditional rural house, mostly using aluminum sliding window and ordinary single-layer glass.



Figure 11: Self-built rural house



a



b



c

Figure 12: "Beichen" Village

4.4 Problems in the contemporary rural houses

4.2.1 Poor thermal comfort

In a research conducted in the winter, February 2015, researchers personally felt that the thermal comfort of contemporary houses is poor. It could be found from the thermal imaging test data that temperature in the external walls of the house wall was below zero and temperature inside room was the same as the outside temperature or even lower. The villagers set up stoves, coal stoves, charcoal and other heating facilities in the living room to gain more heat. Most villagers living in the "Beichen Village" transform the original open balcony into a closed balcony in order to improve the insulation effect (Figure 12a).

4.2.2 Poor lighting ventilation effect

Due to the restrictions of the relocation of the house base, most of the contemporary rural house use the layout of small width and deep depth, that caused insufficient indoor lighting and poor ventilation problems.

4.2.3 Ignore the drainage design

The design of agricultural houses in the "Beichen Village" resettlement project failed to take full account of the local rainy climatic factors, so the resettlement residents transform the housing in accordance with their own needs. For example, each household installed color plates on the yard and balcony to improve the drainage of the roof (Figure 12b).

4.2.4 Lack of drying storage space

The staircases, each balcony and the yards are filled with debris, agricultural tools and crops needed to dry because of the unique lifestyle of the farmers (Figure 9a), which not only makes the space messy, but also makes it inconvenient to remove the stuff. In order to meet the storage use needs, some farmers will close up overhead space on the first floor next to the door for storage rooms for agricultural tools, timber (Figure 12c).

4.2.5 Lose of regional culture

Ningqiang's contemporary rural houses exist in various forms, different styles, contemporary industrial design and construction of the local houses make the houses lose their unique style features, and also ignores the ancient folk heritage of low-tech construction experiences, the unique characteristics of the houses are gradually losing.

5. GREEN CONSTRUCTION OF ECOLOGICAL MIGRATION IN NINGQIANG AREA

In May 2016, undergraduate students studying in Northwestern Polytechnical University and me attended the "Zhongtian Cup" Fifth China Dream Green Building Creative Design Competition, winning the second prize finally. The content of this contest is the design of the green rural house group in Ningqiang area. "Gathering soil for home" was used as the theme and following green building strategies and methods were applied:

5.5 Low-tech strategy

5.1.1 Ventilation and lighting

- Natural ventilation: The main room arranged in the windward side of the summer, the auxiliary room arranged in the leeward side, setting the overhead layer (Attic) below the slope roof to strengthen the ventilation,
- Natural lighting: Set up big interval to prevent the houses from blocking the sunlight. Choose a good orientation to guarantee enough sun radiation; Design the size of the window in a rational way so that the room can maximize the acceptance of natural light.

5.1.2 Temperature adjustment

Ningqiang area has the characteristics of hot summer and cold winter. It needs to keep warm in winter and avoid heat in summer.

- Cooling: The sun visor hanging outside that can be controlled can block the solar radiation according to the need, green plant can not only absorb the sun's radiation heat, but also cool down the temperature using leaf's water transpiration.
- Warm insulation: Ningqiang is located in junction of the cold winter hot summer areas and the cold areas. Compared with the summer heat avoiding, winter insulation is more important. So we choose a right form to reduce the lost of heat, and use the thermal material as the envelope structure to adjust the indoor temperature and humidity.
- Additional sunlight room: Establishment of the sunlight room and the use of the heat generated by solar radiation can be used to regulate the indoor air temperature, to achieve the effect of winter insulation. (Figure 13). During the daytime, solar radiation enters the sunlight room to heat the cold air. Through the air return, the indoor temperature is increased to reduce the heating energy in the winter. In the night, the heat stored in the sunlight room can adjust the indoor temperature to the appropriate state. When it comes to the next day, the sunlight enters into the sunlight room again, and those circles can reduce heating energy consumption.

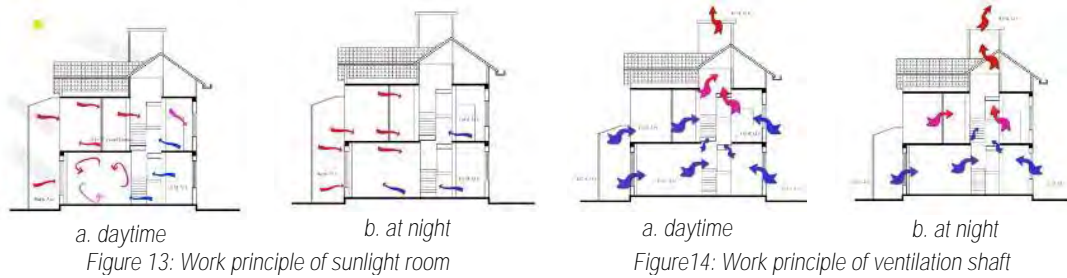

- Establishment of the ventilation shaft: Setting the ventilation shaft can achieve the summer cooling (Figure 14). During the daytime, the outdoor air is cooled by the down pipe and the surface of the ground. The cold air flows from the bottom to the top through the ventilation shaft. The hot air is taken away by the ventilation shaft and the side window. In the nights, cool air form outside enter into the inside room by windows, taking away the hot air inside the room through the air circulation.

5.1.3 Drain and moisture proof

Due to local rainfall, we use the slope whose value is 35 degrees and the slope should be used in rural houses because it is not only conducive to rapid drainage, but also conducive to people when residents could still have outdoor spaces for conversation or labor. It can also be used to raise the bottom of the foundation. Setting the overhead layer plays the important role of avoiding moisture.

5.1.4 Energy use

- The use of solar energy: Green agricultural houses in Ningqiang area can set up the sunlight room to achieve the passive use of solar energy; the active use of the solar energy is to install solar collectors on the roofs whose slope values are 35 degrees to heat and supply hot water.
- The use of biogas: Replacing the traditional energy with biogas is a good way to solve the problem of energy shortage and achieve the goal of energy saving and environmental protection.
- Collection and re-use of water resources: We design a new system of recycling usage of water, Rain is collected through the eaves, and can be used after the filter for toilet flushing as well as irrigation of plants. Energy utilization cycle diagram is as follows. (Figure 15)

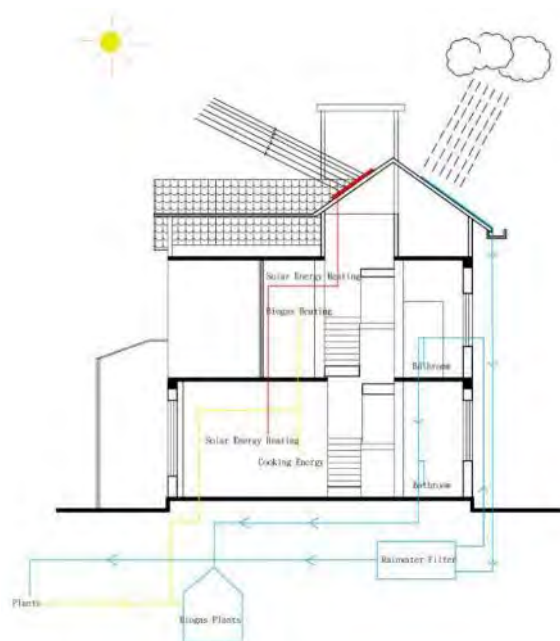

Figure 15: The cycle of energy utilization

5.1.5 Material selection

We use materials that are low energy consumption, recyclable, renewable, easily degradable such as grass bricks, straw composite panels, fiber composite panels when we considering the requirement of minimizing the consumption of the architectural materials.

5.6 Integrated construction methods

Compared with the traditional building construction method, the integrated construction method has the advantages of improving the construction quality, reducing the artificial demand and so on. In the construction of green house, the government will train the villagers and teach them how to mix industrial production of the finished product together, so that it could not only save labor costs but also obtain a higher construction accuracy.

5.7 Evoking humanistic care

Due to the earthquake damage, people moved to the resettlement area and the original neighborhood relationship has become fragmented. Considering this particular social phenomenon, it is important to reconstruct the neighborhood network among the villagers. We found that most of the villagers lost their plowing space because of the lack of land after moving. Increase collective farm areas is identified as a great way to not only restore the traditional labor life and achieve the aspirations of the villagers to cultivate, but also enhance neighborhood relations and reconstruct the broken neighborhood relationship through collective labor activity. As shown in Figure 16 is the rural life vision "soil for home".



Figure 16: The rural life vision "Soil for home"

6. CONCLUSION

The South of Shaanxi province in China has a special geographical environment, the construction of contemporary greenhouses is the most suitable way for the development of local houses. We should not only learn from the green experience inherited by the ancients and build new green rural house for residents to adapt to local climate Characteristics and to have comfort, sustainable living space through the low-tech and low-energy strategy, integrated building construction methods and the construction concept that is suitable for local traditional folk and life needs, but also provide reference experience for the construction for immigrants.

REFERENCES

- [1] He Shuyuan, Research of the "front shop back house" courtyard residential houses in southern Shaanxi [D], Shenyang University of Architecture, 2012.12.
- [2] Wu Xinlan, Research on the strategy and evaluation of the climate adaptive design of rural houses in the region of south Shaanxi province, [D], Northwestern Polytechnical University, 2016.3.
- [3] Yan Jie, analysis of factors that contribute to the formation of residential buildings in southern Shaanxi [J], Sichuan Building Research, 2009.3.
- [4] Yao Runming, green building for the future - examples of the world's outstanding green building [M] Chongqing University Press, 2008.

Optimization of Aggregates for Sustainable Low Cement Concrete for Interlocking Concrete Block Pavers

Chamod Kosala HETTIARACHCHI^a, Wasantha Kumara MAMPEARACHCHI^b

^a University of Moratuwa, Sri Lanka, chamod.hettiarachchi@gmail.com

^b University of Moratuwa, Sri Lanka, wk.mampearachchi@gmail.com

ABSTRACT

Particle packing optimization is a process of selecting optimum aggregate proportions that result in minimum voids and maximum density thus requirement of cement and water can be minimized. The concept of particle packing is adopted to determine sustainable concrete mix for interlocking concrete block pavers (ICBP). Typically the aggregates used for the ICBP are 12mm coarse aggregates with manufactured sand and natural sand as fine aggregates. Fresh concrete is poured into the mold and both vibration and compaction is applied to cast the block. The mold is removed soon after the block is cast. Hence a low water cement ratio and high green strength needs to prevent edge falling and cracking of freshly cast ICBP. Present industrial practice seems to be far less economical due to the use of high amount of cement, wastage of aggregates, and high energy consumption of machines due to improper mix proportions. Hence high strength variations within the same batch is visible. Theoretical packing models such as Toufar, De-Larrad, CPM, LPDM, Powers, Shilstone chart were analysed to determine the most suitable packing model. This study proposes improved sustainable mix design using packing density method by optimization of parameters such as water-cement ratio, coarse to fine aggregate ratio, quarry dust to natural sand ratio, cement content and compaction effort. Trial mixes were tested increasing excessive cement content from 20% to 40% in 5% intervals. The water cement ratio of 0.32-0.36 is suitable with 65-70% of fine aggregates. Further, 65-70% of manufactured sand (as a percentage of total fine aggregate) should be used to maintain green strength of the mix. Optimum vibration time should be 5-7 seconds with an optimum compression of 1.7 -2.0 MPa. The study reveals that optimization of mixture design parameters can reduce the cement content by 30% while maintaining the same concrete strength.

Keywords: green construction technology, particle packing optimization, sustainable concrete

1. INTRODUCTION

Heavy usage of cement in modern construction industry has led to numerous environmental problems. The cement industry is one of the main industries which release carbon dioxide, a major greenhouse gas. Raw material extraction to manufacture cement, heavy damage to the limestone deposits on earth when mining are causing major environmental pollution. (Mishra & Siddiqui, 2014) Hence reduction of cement usage in concrete industry is critical for a sustainable future. Particle packing optimization method can be successfully used to reduce the cement content while maintaining the quality of the concrete.

Reducing the cement content of concrete while maintaining the required quality of concrete is challenging. Consider a unit volume of concrete. Aggregate form the skeleton of this unit volume and cement paste will fill the void spaces among aggregates and create a bond between aggregates. If we can reduce the number of void spaces in concrete we can reduce the cement content required for the filling and bonding. Minimizing the voids can be done by selecting aggregates proportion and sizes carefully. Optimization of aggregate is the process of determining the most suitable aggregate particle sizes and distribution to minimize the voids content of an aggregate mix. An optimized aggregate mix will have lesser amount of voids which needs to be filled with cement paste resulting low cement, high quality concrete.

Optimization of aggregates to achieve higher strengths with lower cement content has been studied for various applications over the past decade. Though those studies were successful for more generalized applications, there were limitations when applying the results for specialized applications such as zero slump concrete, pre-cast concrete, roller compacted concrete, self-compacting concrete, high performance concrete etc. The main reason for such limitations in generalized approach is the variation of the required properties of concrete in each application. (I.e. Low water content requirement in zero slump concrete, roller compacted concrete and pre-cast concrete, high water requirements in self-compacting concrete etc.)

Concrete mixes used in ICBP industry seem to be far less economical and highly unsustainable. The manufacturers use high amount of cement to achieve higher strengths. There are high variations in strength within the same batch of blocks. This paper proposes a method to determine concrete mix proportions with the use of particle packing optimization method for ICBP to overcome above mentioned problems.

2. PARTICLE PACKING OPTIMIZATION

Studies on particle packing concepts were started in the 19th century. Earliest studies on particle packing for concrete mixes was presented by R. Feret in 1892 (Goltermann, et al., 1997), (Andersen & Johansen, 1991). Number of literature on particle packing concepts were published in the 1930s describing the optimization of packing followed by Furnas in 1929 and by Westmann and Huggill in 1930 (Goltermann, et al., 1997).

Powers (1968) stated that the voids ratio of a mix of a binary particulate system would be minimum at a particular combination. Voids ratio (U) is defined as the ratio between the volume of voids (E) and the volume of solids ($1-E$) of a particulate system.

In 1989, Petersen showcased the use of particle packing in relation to the mechanical and the rheological properties. Petersen observed that the model by Aim and Goff predicted the best fit of the theoretical to the experimental packing densities for small particle diameter ratios and that the model by Toufar et al. (Toufar, et al., 1976) produced the best fit for larger diameter ratios. Goltermann et al. (1997) used three models in their tests for the comparison, i.e. the Aim model, the Toufar model and the modified Toufar model. (Andersen & Johansen, 1991; Senthilkumar & Santhanam, 2003) A large variety in particle size and size distribution of natural and crushed aggregates were considered in their research and observed that the Toufar model, and especially the modified Toufar model, agrees very well with the measured packing degrees. The Aim model did not fit the test results and could not be used for the aggregates.

Pedersen & Glavind (1999) stated that when choosing a concrete mix design, it is always necessary to blend the aggregates as densely as possible. Apart from an evident economic benefit, a minimum of binder in concrete results in less shrinkage and creep and a denser and consequently a more robust and strong concrete mix.

The French concrete specialists Sedran and Larrard (De Larrard & Sedran, 2002) have found a method that uses a novel method for concrete mixing. Their software, Bétonlab, is reliable with their mathematical models. In addition to assessing the packing degree by use of the models, the authors presented that models can determine the fresh concrete properties and also the compressive strength.

Kwan & Wong (2008) measured the packing densities of cementitious materials comprising ordinary Portland cement, pulverized fly ash and condensed silica fume. The results for non-blended materials showed that the addition of a superplasticizer would increase the packing densities of ordinary Portland cement and pulverized fly ash, the addition of a polycarboxylate based superplasticizers could reduce the packing density of condensed silica fume.

Wong & Kwan (2014) proposed three tier system design. The mix design would be divided into three stages. At preliminary stage the packing density of the cementitious materials would decide the water demand, and at the second stage the aggregate particles smaller than 1.2mm would decide the paste demand and at third stage the aggregate particles larger than 1.2mm would decide the mortar demand.

From the above studies, it is observed that packing density mix design method can be used to minimize voids to increase particle packing and to reduce the cement content.

3. APPLICABILITY OF EXISTING PACKING MODEL

Several packing models were studied to determine the applicability of existing theoretical packing models for this application. Compressible packing model (CPM), Kwan three parameter model, modified Toufar model were **selected for the optimization. The model proposed by Golterman et al., based on the Toufar's model have been** validated by comparing around 800 test results from multiple sources. Kwan et al. three parameter model has considered three interaction effects. Loosening effect, wall effect and wedging effect. This is a semi empirical model where he has used experimental data and regression analysis to determine the wall effect, loosening effect and wedging effect parameters. Compressible packing model was developed by de larrad (2002). Out of these three models only compressible packing model addressed the packing process. It uses a compaction index (K) value which suggest a value of 9 for vibration.

To determine the suitability of suggested models, a laboratory experiment was carried out. The results indicated that the predicted packing densities by selected models were not accurate for the given conditions. The selected models could only predict the packing density for pre-defined packing process. Both Toufar model and Kwan 3 parameter model does not consider packing process into the calculation. Compressible packing model considers packing process but K value given for vibration does not satisfy the vibration and compression process applied in the packing process. The observed results were always greater than the results obtained from theoretical models. The figure 1 shows the comparison of selected models with laboratory experiment results.

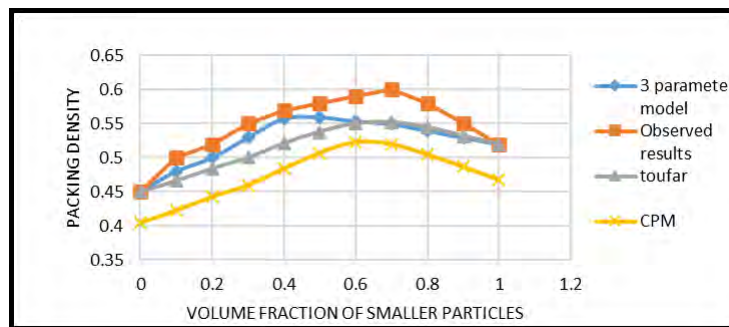

Figure 1: Comparison of packing models

4. EXPERIMENTAL PROGRAM

Considering the concrete mix requirements particle packing optimization found to be the most suitable mix design methodology to follow. 12mm coarse aggregates, quarry dust and natural sand were used as aggregates for the mix. According to Indian Standards (IS15658, 2006) the nominal maximum aggregate size is limited to 12 mm considering the block size. Since the vibration and compaction plays a major role in aggregate packing density, it is essential to select the optimum vibration duration and compression stress. The figure 2 and 3 show the variation of packing density with respect to vibration duration and compression.

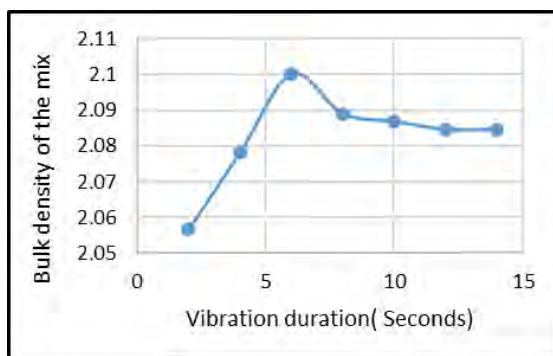

Figure 2: Bulk density Vs. Vibration

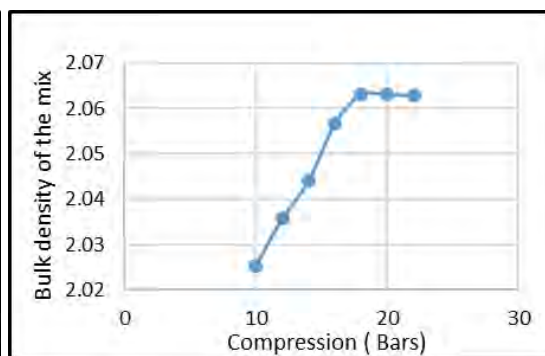

Figure 3: Bulk density Vs. Compression

The optimum vibration period was selected as 6 seconds as shown in figure and the optimum compaction was selected as 18 Bars. The results were used for the selection of aggregate proportions.

4.1 Selection of aggregate proportions

Initially it was planned to optimize the mix using a packing model. But considering the limitations for the applicability of packing model, it was decided to select aggregate proportions using laboratory experiments based on the concept of packing density. Selected vibration and compaction parameters were fixed to determine the aggregate proportions in the laboratory.

4.2 Coarse aggregate to fine aggregate ratio

Aggregates were mixed in proportions and selected vibration (6 seconds) and compression (18 bars) was applied. Then the packing density was determined. The packing density of aggregate mixture is defined as the solid volume in a unit total volume. The aim of obtaining packing density is to combine aggregate particles in order to minimize the porosity, which allows the use of least possible amount of binder. One size fraction of coarse aggregates and Natural sand (river) and quarry dust were selected for the study i.e. 10mm coarse aggregates, 2.36 mm downsize fine aggregate. The values of bulk density of the coarse aggregate were first determined separately. The coarse aggregate and fine aggregate were mixed in different proportions by mass, such as 90:10, 80:20, 70:30 and 60:40 etc., and the bulk density of each mixture is determined. The Figure 4 shows the variation of packing density with respect to aggregate proportions. Addition of fine aggregate increases the bulk density of the mix. However, a stage is reached when the bulk density of aggregate mixture, which instead of increasing, decreases again. Initially when coarse particles are dominant in the mix, voids in between coarse particles are high. Thus, the bulk density is very low. When fine particles are introduced to the mix, it will fill the voids in between coarse particles resulting a high bulk density in the mix. The packing of coarse particles is disturbed and the amount of voids further increase when fine particles dominate the mix. The mix proportion which produces highest bulk density is taken as the optimum mix.

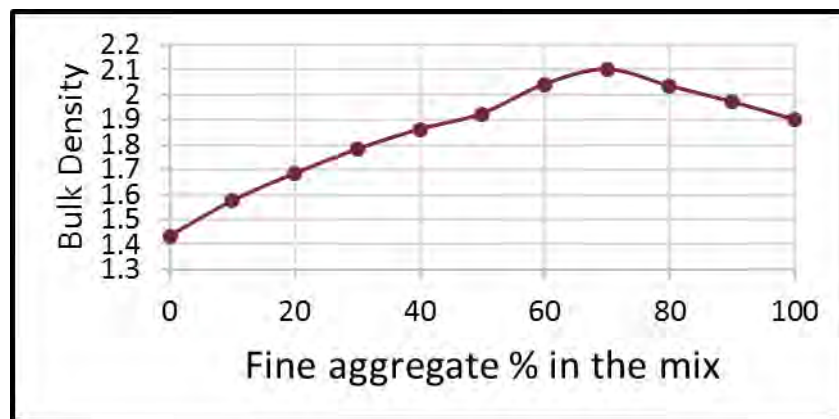

Figure 4: Bulk density vs. fine aggregate % in the mix

4.3 Natural sand to quarry dust proportion

Natural sand to quarry dust proportion in the mix is selected considering the characteristics of ICBP. According to previous studies it was found that adding replacing manufactured sand partially to the mix can significantly increase the strength of the concrete. Plenty of studies have been carried out during past decade and it was found that addition of 50% to 80% quarry dust to the total fine aggregate would increase the strength of the concrete. (Fate, 2014; Uma & Banu, 2015), (Zeghichi, et al., 2012; Priyanka, et al., 2013; Arivalagan, 2013; KrishnaRao, et al., 2013) Quarry dust percentage was selected based on production requirements as well. Since the mold is removed as soon as the block is cast, it is necessary to maintain high green strength in fresh concrete. When the quarry dust percentage is higher, the green strength is high due to the interlocking action in angular quarry dust particles. But on the other hand, high amount of quarry dust will increase the voids in the mix due to the shape factor. Quarry dust may not easily fill the voids in coarse particles. Due to the angular nature of the quarry dust particles, extra effort needs to be applied (Uma and Banu, 2015). But natural sand is round and produces more workable concrete. Hence natural sand can be easily used to fill the voids in coarse aggregates (Fate, 2014). Considering the above limitations in order to maintain high green strength with a workable concrete, 70% quarry dust and 30% natural sand was selected from total fine aggregates.

4.4 Water/ Cement Ratio

Water/cement ratio is critical in ICBP concrete mix. Since a dry concrete mix is used to cast blocks, the water/cement ratio needs to be kept to an optimum level. But too dry mix will break the fresh block after casting as well as the required surface texture cannot be achieved. Too wet concrete mix will slump the block after casting and mold will not be able to remove soon after compaction. Therefore, to select the most suitable water/ cement ratio box test was carried out. Box test revealed that 0.34 - 0.38 W/C ratio provides a better concrete mix which satisfies the required criteria. The figures (5, 6 and 7) shows the surface texture resulted in box test with respect to the W/C ratio.



Figure 5: 0.3 W/C



Figure 6: 0.35 W/C



Figure 7: 0.4 W/C

4.5 Excessive cement paste

Excessive cement paste is the amount of cement paste that will remain after filling all the voids in the aggregate matrix. This cement paste will coat the aggregate and act as a bonding agent for aggregates. Increase of excessive cement paste will increase thickness of the bond between two aggregates thus improving the strength of the bond. Since the aggregate is packed as densely as possible and the water/ cement ratio is kept to an optimum level it is the excessive cement paste that will improve the strength of the concrete. According to Taylor (2012) excessive cement paste can be increased up to 130% to increase the strength of the concrete.

According to table 1 the ACI mix design method uses 588.23 kg/m³ while the proposed packing density method only uses 369.49 kg/m³. It is 37.18% saving of cement. The proportions were used to cast paver blocks using industrial machines. Table 2 shows the results obtained from factory trial mixes. Figure 8 shows the final ICBP product.

Excessive paste content %	Quarry kg/m ³	SAND kg/m ³	Coarse agg. (12mm) kg/m ³	CEMENT kg/m ³	WATER (After corrected for absorption) kg/m ³	7day (N/mm ²)	28day (N/mm ²)	Grade of concrete
15	820	545	585	334	127	13.8	20.12	20
20	810	540	580	328	125	22.4	28.3	25
25	800	530	570	342	130	25.67	34.12	30
30	790	525	560	356	135	28.91	37.26	35
35	780	520	555	370	140	32.4	43.25	40
ACI(G40)	450	125	910	590	210	27.15	40.7	40
Factory (G40)	900	410	340	525	-	-	45	40

Table 1: Mix proportions used for laboratory experiment

Sample	Excessive cement content %	3 day strength (N/mm ²)	7 day strength (N/mm ²)	28 day strength (N/mm ²)
1	20	12.4	18.9	26.3
2	25	15.2	21.4	30.5
3	30	18.6	27.6	36.4
4	35	22.6	30.1	43
5	40	28.3	37.4	52.1

Table 2: Results obtained from factory experiments



Figure 8: Sample ICBP

5. CONCLUSION

Optimization of aggregate to minimize the voids in the concrete can be effectively used to reduce the cement content used for ICBP. Even though the reduction of cement content in concrete has been widely studied, the application of such studies is limited. The importance of this study is, it focuses on a specific range of products and apply the particle optimization knowledge to produce high quality more sustainable product. The methodology proposed in this paper can be modified and applied to determine a suitable mix design for any type of concrete product especially in pre-cast industry.

Determination of optimum compaction effort (Both vibration and compression), Determination of optimum aggregate proportion and determination of optimum water/ cement ratio are the three main stages of proposed method. In case if there are more than one coarse aggregates in the mix, the optimum proportion can be determined in several stages. First select the optimum coarse aggregate proportion by mixing coarse aggregates and determining the packing density. Then select the optimum fine aggregate proportion in the same manner. Finally, the selected coarse aggregate mix and fine aggregate mix can be used to find the optimum coarse aggregate to fine aggregate proportions. Optimum water cement ratio can be selected using box test. Water content and the strength has an inversely proportionate relationship. Since the concrete mix is dealing with low water content the strength is not a concern according to the Abrams law (Sear, et al., 1996).

The pilot study shows that the strength of the ICBP can be achieved with a low cement content producing more sustainable ICBP. Industrial survey revealed that the proposed mix uses 37% less amount of cement to achieve the same strength of the ICBP. It can be concluded that the particle optimization method can be used for sustainable concrete applications.

REFERENCES

- [1] Andersen, P. J. & Johansen, V., 1991. Particle packing and concrete properties. *Materials Science of Concrete II*, pp. 111-146.
- [2] Arivalagan, S., 2013. Evaluate the properties of concrete using manufactured sand as fine aggregate. *World journal of engineering sciences*, 1(5), pp. 176-187.
- [3] De Larrad, F. & Sedran, T., 2002. Mixture proportioning of high performance concrete. *Cement and Concrete Research*, Volume 32, pp. 1699-1704.
- [4] Fate, S., 2014. Concrete with Smart Material (Manufactured Crushed Sand)-A Review. *IOSR Journal of Mechanical and Civil Engineering (IOSR-JMCE)*, pp. 27-29.
- [5] Goltermann, P., Johansen, V. & Palbol, L., 1997. Packing of aggregates: An alternative tool to determine the optimal aggregate mix. *ACI Materials Journal*, 94(5), pp. 435-443.
- [6] IS15658, 2006. Precast concrete blocks for paving- Specification, New Delhi: Bureau of Indian Standards.
- [7] Kantha Rao, V. V. L. & Krishnamoorthy, S., 2014. Aggregate mixtures for least-void content for use in polymer concrete. *IOSR Journal of Mechanical and Civil Engineering (IOSR-JMCE)*, 11(2), pp. 34-46.
- [8] KrishnaRao, S., ChandraSekharRao, T. & Sravan, P., 2013. Effect of Manufacture sand on Strength Characteristics of Roller Compacted Concrete. *International Journal of Engineering Research & Technology (IJERT)*, 2(2), pp. 1-9.
- [9] Kwan, A. K. H. & Wong, H. H. C., 2008. Packing density of cementitious materials: part 1-measurement using a wet packing method. *Materials and Structures*, Volume 41, pp. 689-701.
- [10] Mishra, S. & Siddiqui, N. A., 2014. A Review On Environmental and Health Impacts Of Cement Manufacturing Emissions. *International Journal of Geology, Agriculture and Environmental Sciences*, 2(3), pp. 26-31.
- [11] Pedersen, E. J. & Glavind, M., 1999. Packing Calculations Applied for Concrete Mix Design. *Proceedings Creating with Concrete*, pp. 1-10.
- [12] Powers, T. C., 1968. *The properties of fresh concrete*. 1st ed. New York: John Wiley and Sons, Inc.
- [13] Priyanka, A., Jadhav, A. & Dilip K. Kulkarni, 2013. Effect of replacement of natural sand by manufactured sand on the properties of cement mortar. *INTERNATIONAL JOURNAL OF CIVIL AND STRUCTURAL ENGINEERING*, 3(3), pp. 621-628.
- [14] S.A.A.M. Fennis & J.C. Walraven, 2008. Measuring the packing density to lower the cement content in concrete. *Tailor Made Concrete Structures*, pp. 419-424.
- [15] Sear, L. et al., 1996. Abrams law, air and high water-to-cement ratios. *Construction and building materials*, 10(3), pp. 221-226.
- [16] Senthilkumar, V. & Santhanam, M., 2003. Particle packing theories and their application in concrete mixture proportioning: a review. *The Indian Concrete Journal*, pp. 1324-1331.
- [17] Taylor, P., 2012. *Optimizing Cementitious Content in Concrete Mixtures for Required Performance*, Iowa: Iowa State University.
- [18] **Toufar, W., Born, M. & Klose, E., 1976. "Contribution of optimization of components of different density in polydispersed particle systems. Freiburger Booklet A, Volume 558, pp. 29-44.**
- [19] Uma, M. & Banu, S., 2015. STRENGTH AND DURABILITY STUDIES ON CONCRETE WITH FLYASH AND ARTIFICIAL SAND. *International Journal of Engineering Research and General Science*, 3(1), pp. 138-146.
- [20] Wong & Kwan, 2014. A 3-parameter model for packing density prediction of ternary mixtures of spherical particles. *Powder Technology*, Volume 268, pp. 357-367.
- [21] Zeghichi, L., Benghazi, Z. & Baali, L., 2012. Comparative Study of Self-Compacting Concrete with Manufactured and Dune Sand. *Journal of Civil Engineering and Architecture*, 6(10), pp. 1429-1434.

Development of a Functional Interior Material Using Scallop Shell Lime

Hinako UEHARA^a, Yusuke NAKAJIMA^b

^a Kogakuin University, Japan, dm16011@ns.kogakuin.ac.jp

^b Kogakuin University, Japan, yusuke@cc.kogakuin.ac.jp

ABSTRACT

About 360,000 tons of scallop are unloaded in Japan now, and most of them are concentrated in Hokkaido. The illegal dumping of the scallop shell became the problem, but the recycling rate largely rose by subsidies in late years. However, subsidies are not necessarily continuing permanently.

It was found that scallop shell lime is a natural material with little environmental load and high environmental performance, such as effects of humidity control, absorbing smells and VOC, and preventing mold. In addition, water resistance was confirmed by polished finish, this performance is not appeared in general lime made from limestone.

In this paper, water resistance and environmental performances are compared between scallop shell lime and general lime.

From the result of the examination, it was found that the examination body of the scallop shell lime with polished finish could have both humidity control effect and water resistance performance. From these results, it is anticipated that the scallop shell lime with polished finish is effective as an interior material of the places such as restroom or kitchen.

In addition, in the investigation about the water resistant mechanism, a prediction that expression of water resistance is influenced by the speed of carbonation was provided.

Keywords: indoor environmental quality, scallop shell lime, natural materials

1. INTRODUCTION

Today, about 360,000 tons of scallops are landed throughout Japan, with almost all of that being concentrated in Hokkaido. There was previously a problem with illegal dumping of scallop shells, but in recent years subsidies have been provided, and the recycling rate has increased greatly due to use as soil improvement material, underdrainage channeling material, and in other applications. However, these subsidies will not continue forever. Also, there are substitutes other than shells for applications such as soil improvement material and underdrainage channeling material, and these applications do not make use of the special characteristics of scallop shells.

In previous research, a basic survey was carried out of environmental adjustment type building materials using scallop shell lime, and it was confirmed that this is a building material employing natural materials that has low environmental impact and good performance. It also exhibits water resistance when given a polished finish.

This report examines the use of plastering materials having the added value of environment adjustment function, while comparing between scallop shell lime and regular lime in areas such as differences in water resistance and environmental performance when given a polished finish.

2. OVERVIEW OF REGULAR LIME BASED PLASTERING MATERIALS

In this report, scallop shells ground into powder are called “scallop shell powder,” calcined scallop shell powder is called “scallop shell lime,” slaked scallop shell lime is called “scallop shell paste,” and material such as aggregate mixed with scallop shell paste is called “scallop shell plastering material.” In addition, ordinary finishing is called “mortar finishing,” and further finishing by applying pressure with a trowel is called “polish finishing.”

Quicklimes made by calcining limestone and scallop shell lime have the same ingredient (calcium oxide) aside from impurities such as minute amounts of iron, and scallop shell lime is a material which can substitute for regular lime, as shown by the fact that shell mortar was previously used as a plastering material in Japan.

3. WATER RESISTANCE TEST

3.1 Overview of test

It was thought that perhaps there are differences in the degree that water resistance is exhibited due to factors such as the temperature of the water used when slaking scallop shell lime. Three slaking conditions were established: ordinary temperature (approx. 23°C), low temperature (approx. 10°C), and high temperature (approx. 50°C). Immediately after slaking at ordinary temperature, ice-chilled paste was made by cooling with ice water. A frame was attached to a 20 cm × 20 cm test specimen made using this paste, and 100 cc of water was added. Water was wiped off after 1 minute, and the water absorption rate for 1 minute was found by determining the difference in weight of the test specimen before adding water and after wiping off water.

3.3 Test result

Figure 1 shows the results of water resistance testing. It is evident that shell lime polishing exhibits higher water resistance compared to regular lime polishing. The difference between shell lime polishing 1 and shell lime polishing 2 is likely to be an error arising because the specimen was prepared by hand, rather than an effect due to the different temperatures of water used for slaking.

With regular lime polishing, there are large differences in appearance depending on whether other materials such as cellulose fiber are mixed in, and types with mixed material seem to have a stronger surface luster. However, the results showed it is unlikely that the presence/absence of mixed materials has a major effect on water resistance.

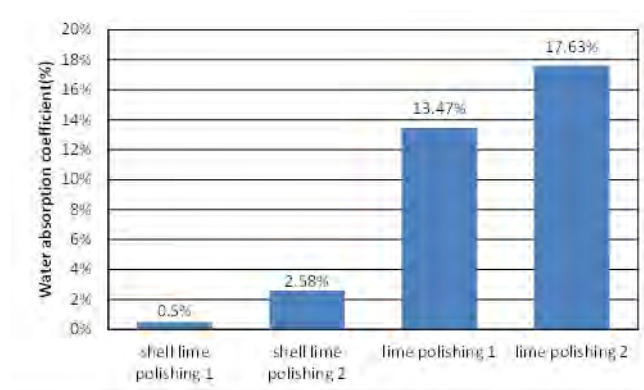

Figure 1: Result of water resistant examination

4 INVESTIGATION OF COMPOSITION VIA XRD ANALYSIS

4.1 Overview

Using the paste prepared in section 3, an investigation was carried out to determine whether differences in slaking conditions have an impact on exhibiting water resistance, and whether the method of component growth during the curing stage plays a role in exhibiting water resistance. Also, as shown in Figure 2, it was thought that aragonite, a calcium carbonate component with a horizontal structure allows water to pass through less readily than calcite with its vertical structure, and this may have an effect on manifestation of water resistance. Therefore, the content percentages of aragonite and calcite were investigated through XRD analysis.



Figure 2: Crystal structure of calcite and aragonite

4.2 Test result

Test results are shown in Figure 3. The type slaked at low temperature and the type slaked at high temperature showed no appearance of calcium carbonate, and no difference was evident. The type slaked at ordinary temperature showed appearance of calcium carbonate, primarily of the calcite type. With ice chilling, there was appearance of calcium carbonate of both the aragonite and calcite type, and the aragonite type calcium carbonate was thought to have an effect on exhibiting water resistance, but as shown by the results of water resistance testing in section 3, there were no differences between the test specimens in terms of water resistance.

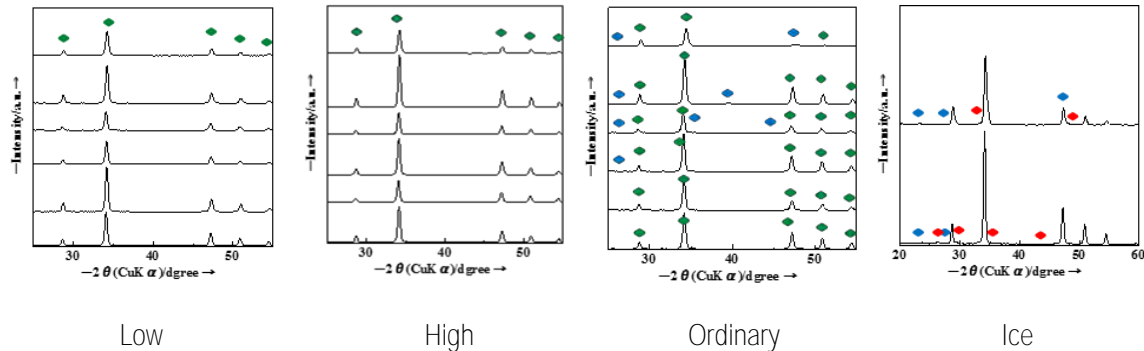

Figure 3: Result of XRD analysis

5 INVESTIGATION OF VARIOUS TYPES OF PERFORMANCE USING TEST SPECIMENS

5.1 Overview of test

Table 1 and Figure 4 provide an overview of test specimens. An undercoating and middle coating were applied to a 20 cm × 20 cm plasterboard, and this was given a mortar finish. Then a luster was brought out by applying pressure with a trowel, and the result was taken to be the polished finish.

specimen	under coat	intermediate coat			finish	
	material	material	aggregate	ratio	material	aggregate
shell lime polishing	under coat material	shell lime	shell powder	1:0.1	shell lime	—
lime polishing		lime	kansui	01:00.5	lime	—
shell lime mortar		shell lime	shell powder	1:0.1	—	—
lime mortar		lime	hakuryu	01:00.5	—	—

Table 1: Examination body summary

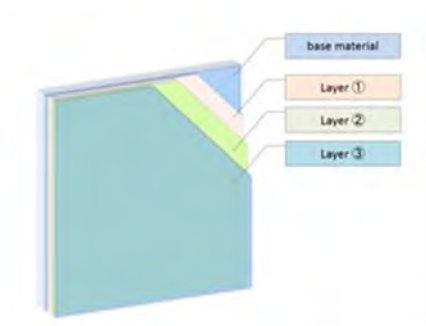

Figure 4: Cross section of the examination body

5.2 Test of moisture adsorption/ desorption performance

In accordance with JIS A 1470-1 “**Determination of water vapour adsorption/desorption properties for moisture-regulating building materials — Part 1: Response to humidity variation,**” the test specimen was left to stand in a constant temperature and humidity bath. The moisture adsorption process was done at 23°C/ 75% and the moisture desorption process at 23°C/ 50%, and in each case the process was carried out 12 hours at a time, and changes in test specimen weight were recorded.

Figure 5 shows the results combined with wallpaper data from previous research. The shell lime test specimen has performance almost on a par with regular lime, in terms of both moisture adsorption and moisture desorption rate, and result were obtained with moisture adsorption 2 times or more higher and moisture desorption 3 times or more higher than ordinary wall paper (vinyl cloth). The notable point here is the polished finish, and moisture adsorption/desorption performance on a par with an ordinary mortar finishing was confirmed, regardless of having water resistance.

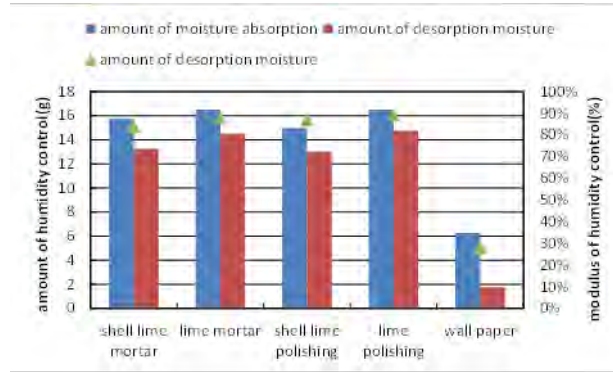
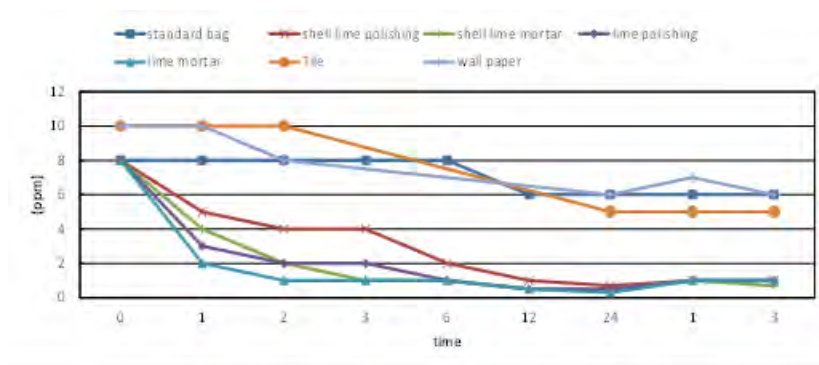

Figure 5: Structure of scallop lime

5.3 Adsorption-emission testing for ammonia-formaldehyde

Each of the test specimens in Table 1 was made into a 10 cm × 10 cm size and placed into a bag with capacity of 20 L. Ammonia was set to an initial concentration of 10 ppm and formaldehyde to an initial concentration of 0.4 ppm, and the decline in concentration over time was measured for each test specimen. As shown in Figure 6, the results showed that although there are differences in adsorption speed for both ammonia and formaldehyde, in the end adsorption up to about 1/10 or less was reached after 24 hours for both shell lime polished/mortar and regular lime polished/mortar.



Ammonia

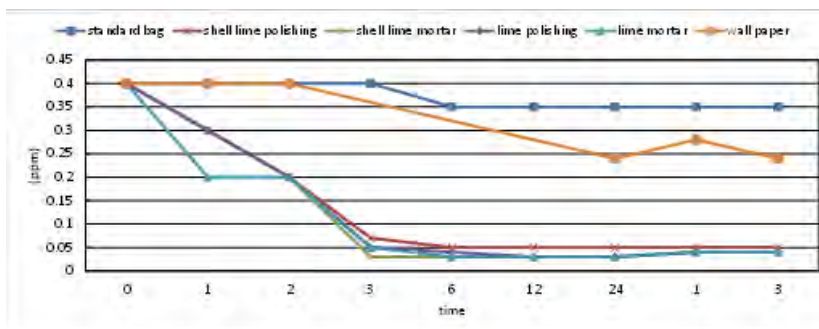

Formaldehyde

Figure 6: Result of ammonia and formaldehyde adsorption examination

5.4 Fungus resistance test

Fungus was sprayed onto each type of test specimen: shell lime polished, shell lime mortar, regular lime polished, regular lime mortar, wall paper, plaster board, wood, and earth wall. The inside of the sealed container was set to a humidity of 90% or more, and growth of fungus was observed. The results showed that fungus grew in a condition like white cotton on the plaster board, wood and earth wall, but no growth of fungus was evident on the shell lime and regular lime test specimens.

6 XRD DIFFRACTION IN POLISHED PLASTERING MATERIALS

6.1 Overview of test

Among the items prepared in Table 2, those used as test specimens were: polished finish plastering material made with ice chilled scallop shell paste (shell lime polished), and for comparison polished finish plastering material made from regular lime (regular lime polished).

6.2 Test results

Figure 7 shows the test results. In the shell lime polished specimen, the surface layer is almost entirely calcium carbonate, and in the regular lime polished specimen it is calcium hydroxide. It was confirmed that carbonization progresses more quickly with the shell lime polished specimen. In general, the density of calcium carbonate is 2.7 g/cm^3 , and the density of calcium hydroxide is 2.2 g/cm^3 . The results suggest the possibility that the difference between these components covering the surface relate to manifestation of water resistance.

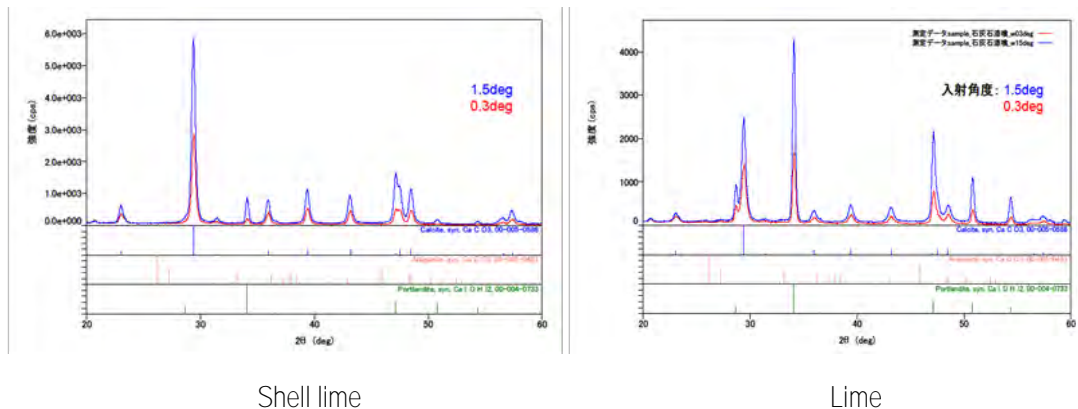

Figure 7: Result of XRD diffraction in polished plastering materials

7 CONCLUSION

In investigating various types of environmental performance using test specimens, it was confirmed that shell lime has moisture-regulating, gas adsorption and anti-fungal performance on a par with regular lime. Also, in water resistance testing, it was confirmed that water resistance typical of scallop polishing is exhibited, and in investigation of the water resistance mechanism, the results indicated that perhaps the high speed of carbonization compared to regular lime has an effect on manifestation of water resistance.

Plastering material using scallop shell lime has outstanding environmental performance, and is an environmentally-friendly building material because it reuses waste. In addition, it exhibits water resistance when given a polished finish, and has potential for use in settings involving plumbing. Even when polished, environmental performance such as adsorption-desorption performance does not degrade, and can be realized together with water resistance performance, and thus there is potential for applications such as wall material in plumbing-related setting such as toilets where odors are a particular worry.

REFERENCES

- [1] Kazusi Yajima,(2012) Basic physical properties and environmental performances as interior materials of Japanese scallop lime. AIJ KAnto

Research on Environmental Safety of Nanomodified Building Materials

Petr ZHUK^a

^a *Moscow Architectural Institute (State Academy), Russia, peter_05@bk.ru*

ABSTRACT

The research methodology includes two directions: 1 ecotoxicological; 2 construction materials life cycle analysis. Ecotoxicological researches suggest definition of nanocomponents specifications, tracking of spreading medium, methods for identification of nano-particles in the environment (microscopic, chromatographic, spectroscopic and diffractive). The life cycle analysis was conducted on the base of approaches from risk theory, with the use of graph theory as well, which allowed to consider maximum amount of factors during materials or constructions exploitation under different conditions.

As results of the research, classification of nanomodified construction materials was introduced, risks of cytotoxic components invasion in geosphere components were analyzed, some dependences of nanocomponents toxicity from abiotic factors were studied. Under the method for assessment of environmental safety of nanomodified construction materials an approach allowing to consider both positive and negative effect of their utilization at the same time is proposed.

At the stage of designing materials and specific building elements with the use of nanomodifying additions one should foresee both positive and possible negative consequences for the environment. The article proposes ranging environmental risks for certain constructions, materials, nanomodified additions with different areas of use in construction. Approaches to reducing negative impacts on the environment when using certain nanomodifying components are developed.

Keywords: environmental safety, nanomodification, life cycle assessment, ecotoxicological studies

1. INTRODUCTION

The goal of this research was to form a single method for assessment of environmental safety of nanomodified construction materials. Under this assessment it is necessary to consider possible impact on human and the environment during the whole product life cycle. Wide expansion of nanomodification and nanostructurization methods for improving efficiency of different building elements is a reason for developing a single approach to problems of environmental safety on the base of risk theory.

Nowadays the implementation of nanomodified materials in high-performance buildings construction practice tends to grow due to their unique properties. At the first glance, the direct relationship between advanced technologies in nanostructures implementation area and materials which are traditionally used in architecture is rather hard to perceive. At the same time, any materials based on cementing agents (concrete, in particular) are perfect examples of nanostructures, because their durability features are formed as a result of crystallization processes, the scale of which lies exactly in this range. One of the most promising directions is fiber reinforcement of composite materials with carbon fiber and other materials. For instance, advantages of carbon-fiber reinforcing bars are that its durability factors are three times more than of carbon steel, while the density is much lower. Fibers of nanostructured materials can be used both as a complement to reinforcing rods and for fiber reinforcement of polymer materials and materials based on mineral binders. Base directions of nanostructural modification implementation are shown in the Table 1.

Material groups by designation	Nanostructural modification examples	Modification result
Structural materials	Using nanoparticles of silicon dioxide in form of silicic acid synthetic derivatives as an additive to high-strength concrete.	Increase of porosity as well as adhesional strength between concrete and steel reinforcement bars or between old and new concrete.
Buildings heat insulation	Electro-chromic, gas-chromic and thermotropic nanocoatings for glass, able to adjust light transmission on their own.	Light transmission of electro-chromic glasses can vary from 80% to 20%.
External finishing materials	Formation of self-cleaning surfaces with photo-catalytic effect due to nanoparticles of titanium dioxide insertion.	Due to the catalytic effect, hydrogen peroxide forms from water under the influence of ultraviolet and destroys organic pollutions which are then washed away by rain.
Internal finishing materials	Implementation of titanium dioxide nanoparticles as additives to coatings.	Protection from bleaching under the influence of natural or artificial light.

Table 1: Directions of construction materials nanostructural modification

Table 1 shows that base materials used in modern construction process, during the making of which nanostructuring technologies are being successfully implemented, are composite materials (in particular, carbon fiber reinforced plastics as well as modified lightweight concretes). In road building nanostructuring is actively used for asphalt concrete modification. Moreover, nanotechnologies are actively used for coating of different materials both for building face and interiors. In addition to those shown in the Table 1, such coatings include anti-graffiti systems, which protect surfaces from painting and corrosion protection systems for metals. One of the first materials referred to as “nano”, named after Richard Buckminster Fuller fullerene was also found useful in architectural and building practices. In particular, it is used as an additive in intumescent (swelling) fire-protective paints. Due to fullerene insertion under the influence of temperature during fire the paint swells and a dense coked cellular layer is formed, which strongly increases heating time to critical thermal point of constructions under protection.

At present there are certain structures built with the use of nanostructured materials. Those are, for instance, bridge across Volga river in Kimry and across Vyatka river, built with the use of nanostructured concrete, as well as bridges near art museum in Sochi and across Mansanares river in Madrid, built with the use of polymeric composite material – carbon fiber. The last structure, built by Acciona company, is 44 meters long and 3.5 meters wide and has an impressive jointless structure without abutments. In the builder company opinion, bridges building is getting easier due to using of carbon fiber reinforcement, and prime cost is lower as well. In particular, the above-mentioned bridge was constructed for two hours and materials include near 12 tons of carbon fiber.

2. EFFECTS ON THE ENVIRONMENT RELATED TO IMPLEMENTATION OF NANOSTRUCTURED MATERIALS

The rise of nanostructured materials implementation for solving architecture and building problems makes experts consider safety of such materials for human and the environment. To get a full picture of materials with nanostructural modification safety we need a method of their environmental assessment. Such assessment must take into account capabilities of nanostructured materials in unburdening the environment. They are related, for example, to ultrafiltration with the help of ferroxane or alumoxane membranes for pollutants discharge, using nanocatalysts for refining processes, lowering waste quantity and production energy consumption as well as getting higher quality materials structure (for instance, glass fiber made from gel or natural disperse formations). Table 2 shows possible positive and negative effects from implementation of nanostructured materials, related to impact on the environment.

Positive effects	Negative effects
<p>Saving in material resources consumption (for instance, reducing of coatings layers thickness due to nanostructuring additives insertion); Reducing of byproducts quantity (through primary reactions with the use of nanocatalysts); Improvement of energy transformation efficiency (by using nanostructured materials); Lowering material costs (for example, by applying small amounts of coatings to surface); Removing burdening materials from the environment (for instance, removing water pollution through nanofilters); Increasing safety (by improving sensor devices while testing materials).</p>	<p>Spreading of nanoparticles in air and water and their diffusion after release from materials; Some of nanostructured materials (for example, with the use of fullerene and nanotubes) do not belong to nature and it is hard for them to embed themselves into ecosystems biogeochemical cycle; Recycling materials with the use of nanotechnologies can be difficult; Cytotoxicity of some nanostructuring components for living cells.</p>

Table 2: Positive and negative effects on the environment related to implementation of nanostructured materials

Taking into account a significant amount of positive and negative dimensions of nanostructured materials implementation there rises a problem of their impartial assessment from the environmental point of view. The assessment system must have complexity and allow comparing materials with the use of nanostructuring additives and without them in case if such materials have the same functional value. For example, comparison of steel and carbon-fiber reinforcement bars. Since the production assessment is going under environment quality control system (ISO standards series 14040-14044), we can use directions already tested on construction materials. The main aspects necessary to take into account in full assessment include the following:

- impact on human if ingested;
- environmental impact through all stages of the life-cycle including intrusion into the atmosphere, water, soil, food chains as well as production power consumption;
- positive impact on unburdening the environment through all stages of the life-cycle.

Nanoparticles release from construction materials is possible at any stage of the life-cycle, starting from materials production on out to recycling. Particular attention must be paid to the operational stage. Similar to a range of researches, coatings testing under different effects were performed (attrition, atmospherical effects, hostile environments modeling).

3. RESEARCH ON ENVIRONMENTAL SAFETY OF NANOMODIFIED BUILDING MATERIALS

Under different impacts nanoparticles with size less than 100 nm were released from coatings, but nanocomponents themselves were always bound by the binding matrix. Researches on possible release of TiO₂ nanoparticles from coatings applied to different bases (wood, polymers, ceramics) were conducted under mechanical and atmospheric impacts. At the same time particles with size from 15 to 600 nm diffusion calculation was performed (Hsu and Chein, 2007). Researches confirmed general conclusions that release of free nano-objects from coatings is possible only in case of chemical or thermal destruction of matrix material, but not under mechanical impact. Additional researches are required on processes of possible matrix material containing nanocomponents destruction under environmental impacts. Those processes can lead to release of isolated nanoparticles. For example, such outcome is possible in case of destruction of matrices bearing nanocomponents, made of materials prone to photochemical breakdown. In particular, small amounts of artificial silver particles size from 20 to 300 nm can enter environment from facade paints due to erosion and rain (Kaegi et al., 2010). Nanoparticles are not washed away from dry coatings, but can enter air along with binding during coating surface attrition.

The entrance of nanoparticles in human body is possible through respiration air (via inhalation), with food (via mouth) and through skin. Nanotubes, implemented in many areas, when enter lungs can lead to consequences similar to those from asbestos fibers with the distinction that the latter have larger size (micron range). Nanoparticles can easily pass through cell membranes, which can be used to deliver medicines, but in some cases can lead to negative consequences (Paschen et al., 2003).

For the first time the cytotoxicity of fullerene clusters dissolved in water was discovered on fish brain tissue. The influence on cell membranes is related to presence of free radicals. At the same time fullerene is hydrophobic and poorly soluble in water on its own, but when its concentration reaches around 100 ppm it becomes able to form clusters, which lead to the above-mentioned negative impacts on the environment (Williams, Adams, 2007). When studying nanoparticles toxicity for living cells it is necessary to take into account that this index depends on the following characteristics: mobility, particles size, their chemical constitution, surface charge, shape, structure, etc.

The nanoparticles mobility is regarded as their ability to enter any systems as well as their influence in aerosols and liquid forms. While in medicine such ability of nanoparticles is a unique positive feature, in case of possible environment pollution the appraisal becomes the opposite.

That being said, it is possible to reduce the toxic effect of nanoparticles using functionalisation and derivatisation methods. Functionalisation means joining lesser molecular fragments to surface of, for example, fullerene. This can gradually (approximately two times) reduce toxicity of the same amount of nanoparticles (Williams, Adams, 2007). Fullerene functionalisation reactions include: Diels-Alder reaction (cycloconnection of elements with multiple bond, activated by adjacent electron-withdrawing group), Prato reaction (reaction with attachment of azomethine ylides), Bingel reaction, hydrogenation (during which compounds $C_{60}H_2 \dots C_{60}H_{50}$ are formed). All these reactions are reversible. Derivatisation refers to formation of secondary chemical elements and with its help it is also possible to reduce nanoparticles toxicity in an effective way (Williams, Adams, 2007).

For the full-scale analysis of nanoparticles toxicity at the materials production stage, experts suggest risk theory methods. In particular, the risk is considered as product toxicity by influence duration. For instance, in the Center for the Environmental Implications of NanoTechnology – CEINT of Duke University (North Carolina, USA) researches and comparative analysis of toxicity equivalent of such nanomaterials as fullerene, single-layer nanotubes, alumoxane nanoparticles and titanium dioxide are being conducted under the guidance of professor Mark R. Wiesner (Wiesner et al., 2008). According to experts of the above-mentioned center, the risk in nanomaterials production is equal to such in production of materials traditionally implemented in architectural practices.

Methods for evaluation of risks related to implementation of nanomodified materials have several distinctions. For instance, risk can be calculated as product of toxicity by influence duration (Williams, Adams, 2007), or we can calculate a risk ratio, which refers to a ratio of undesired events amount to current hazard factor scale (full amount of hazardous events) (Godymchuk et al., 2012). In this article, calculations were based on the definition of risk as a product of hazardous situation probability on damage value.

Nanoparticles name	Relative environmental risk index of production, %	Relative environmental risk index of operation, %
Single-layer carbon-fiber nanotubes	20	5
Fullerene	40	10
Alumoxane nanoparticles	35	15
Titanium dioxide nanoparticles	50	20

Table 3: Comparative index of environmental risk at nanomodified materials production and operational stages

Basing on the results of risk calculation, we must note that in general indexes at the operational stage are gradually lower than those at the production stage, which is explained by considerably lower probability of unbound particles entry in the environment. Moreover, there is a correlation between relative risk indexes for different nanoparticle types at both life-cycles stages of the products made with their implementation.

Positive effects may be related to using nanoparticles as part of construction materials in order to give them fireproof, waterproof, bioresistant features and to secure their longevity. In particular, there are examples of nanostructural components implementation for absorption of possible hazardous components emission through chemisorption. Figure 1 shows the principle of formaldehyde chemisorption from pressed wood boards through implementation of paint base with nanoparticles (Maltsev, 2012).

4. CONCLUSION

At present, a range of fundamental type nanopowders used in building construction is produced on an industrial scale. Those are, in particular, aluminum, silicon and titanium oxides. The fundamental technology of their production is aerosol pyrolysis (Foster, 2006). Several other methods of nanostructuring components production have also been brought to industrial level. Among them is plasma-chemical method, which can provide high efficiency of production and a possibility to lower powder agglomeration. But it is important to characterize not only nanostructuring components production but also materials, in which they are implemented.

Instruments of the graph theory can be proposed as a methodical base for environmental assessment of nanostructured materials, as long as directed graphs and formed matrixes allow considering simultaneously both positive and negative aspects of implementing production in architecture and building. Furthermore, using negative feedback principle, which is widely spread both in environmental studies and in product quality assessment, shows good results. The negative feedback stands for the link which declines the shift from optimum. Risk (toxicity for living cells) parameters and the amount of power lost in nanostructured material production can be used as indicators of assessment system. When using the negative feedback principle it is important to consider noises, which can include accelerated diffusion of nanoparticles in the environment. While in ecology the negative feedback principle is used to define scales of homeostatic plateau, within which the ecosystem preserves self-maintenance and self-regulation abilities, in case of material properties assessment we can simply define the upper limit of its safety at any stage of the life-cycle.

REFERENCES

- [1] Foster, L., 2006. *Nanotechnology: Science, Innovation and Opportunity*. Prentice Hall, Upper Saddle River, NJ.
- [2] Godymchuk, A., Savelyev, G., and Zykova, A., 2012, "Ecology of nanomaterials", *BINOM Transl. Russian*, Moscow, 272.
- [3] Hsu, L., Chein, H., 2007. Evaluation of nanoparticle emission for TiO₂ nanopowder coating materials. *Journal of Nanoparticle Research*, 9, 157-163.
- [4] Kaegi, R., Sinnet, B., Zuleeg, S., Hagendorfer, H., Mueller, E., Vonbank, R., Boller, M., Burkhardt, M., 2010. Release of silver nanoparticles from outdoor facades. *Environmental Pollution*, 158, 2900-2905.
- [5] Maltsev, V., 2012. "Nanotechnology in the production of environmentally friendly building materials, chemicals and compositions", paper presented at the High Technologies and Human Ecology Conference, Moscow, 17-19 April.
- [6] Paschen, H., Coenen, Ch., Fleischer, T., Gruenwald, R., Oertel, D., Revermann, Ch., July 2003, "Nanotechnology. Final report TA-Project. Technology results evaluation", *Transl. German, No. 92*
- [7] Williams, L. and Adams, W., 2007. *Nanotechnology demystified*. McGraw-Hill, New York.
- [8] Wiesner, M.R., Hotze, E.M., Brant, J.A., and Espinasse, B., 2008. Nanomaterials as possible contaminants: the fullerene example. *Water Science and Technology*, 3(57), 305-310.

IX. AUTHOR INDEX

- ABE Hiroshi, 669
ABRAHAM Yewande, 1325
ABRIAK Nor-Edine, 2865
ABU-EISHEH Sameer, 2678
ADEWUMI Solomon, 2555
AGAR Joshua, 97, 1265
AGHNIAEY Sama, 1742
AGUIAR Fabianne Miranda, 100, 2072
AGUSTÍ-JUAN Isolda, 2141
AHMADZADE RAZKENARI Mohamad, 930
Akhmad Fritz, 2446
AKIMOTO Takashi, 1730
Alberto Carlos, 400
ALSEMA Erik, 103, 977
ALVARADO Valeria, 1237
ALVARADO ROMAN Valeria Isabel, 351
ALVAREZ Cristina Engel, 122, 123
ALWAER Husam, 2555
AMADO Miguel, 2426
AMBROSE Michael, 105, 2469
AN Karl, 2147
ANDAMON Mary Myla, 1452
ANDERS Stephan, 846
ANDERSON Glen, 462
ANDES Lisa, 2272
ANDRESEN Inger, 2713
ANDREWS Clinton, 1561
ANINK David, 103, 977
ANN Andy, 237
ARAZ Mustafa, 105, 370
ARBABI Hadi, 888
ARMSTRONG Tony, 132
AROOZ Rizna, 2843
ARRIZABALAGA Eneko, 1173
ASADI Somayeh, 1325
ASAMI Yasushi, 815
ASCIONE Fabrizio, 1132
AU Benny, 133, 1345
AU Christine, 1717
AU Nicholas, 1717
AUER Thomas, 109
AUGUSTSSON Johan, 245
AYE Lu, 861, 1042, 1179, 2127
BABU Sushanth, 2161
BACH Harry Robert, 122
BADLAND Hannah, 2340
BAILLON François, 121
BAIRD George, 115, 1939, 2327
BAKENS Wim, 121
BAKER Hannah, 2390
BALDWIN Andrew, 122
BALOUKTSI Maria, 97, 901, 989, 2279
BAMM Mathew, 1699
BANSAL Sakshi, 1955
BAPTISTA Sheyla Mara, 101, 2217
BARBEY Kristin, 95, 2245
BARBOSA Sabrina Andrade, 284
BARRETO Douglas, 101, 2217
BECQUART Frédéric, 105, 2865
BELKERT Ann-Kristin, 2719
BENEITEZ Jorge, 2584
BERCHTOLD-DOMIG Markus, 937, 984
BERGGREN Björn, 245
BERNEGGER Heinz J, 2040
BERRISFORD Carl, 205
BERTOLDE Adelmo Inacio, 100, 2072
BHATTACHARJEE Sushismita, 1620
BIANCO Nicola, 1132
BIDARMAGHZ Asal, 2127
BILEK Vlastimil, 304
BINNEKAMP Ruud, 1555
BIYIK Emrah, 105, 370
BOETTCHER Olaf, 1132
BOHNE Rolf André, 103, 1992
BOKEL Regina, 880
BONHAM-CARTER Claire, 131
BORG Ruben Paul, 121
BOURDREAU Marie-claude, 1742
BRAGANÇA Luis, 122, 123, 996
BRAGÉE Sarah, 245
BRATTEBØ Helge, 653
BRAUNE Anna, 846
BREW James Scott, 1586, 1616
BROCKMANN Tanja, 605, 2108
BRUMAUD Coralie, 2850
BRUNKLAUS Birgit, 647
BÜHLER Robert, 1605
BURROUGHS Steve, 1904
CABRERA-JARA Natasha, 101, 2066
CAI Wei, 1439
CALICE Claudia, 641
CALLAGHAN Ann, 101, 1397
CANDY Seona, 1042
CAPPALAI Francesco, 809

World Sustainable Built Environment Conference 2017 Hong Kong

CASE Mark, 484
CATLIN Kit-wai Stephen, 735
CELIS D'AMICO Flavio, 100
CHAN Albert KB, 131
CHAN Alex, 1487
CHAN Antonio CM, 124, 1793
CHAN Cary, 436, 1800
CHAN Cary WH, 2265
CHAN Danica, 183, 184
CHAN Derek, 412
CHAN Edmund, 2005
CHAN Edwin, 205, 246, 251, 271, 418, 741, 747, 1354, 1876
CHAN Florence, 205
CHAN Hor-yin, 429
CHAN Kin-hong, 406
CHAN Mary, 2549
CHAN Ming-yee, 1649
CHAN Pak-cheung, 542, 2692
CHAN Peter, 1710
CHAN Ping-sun, 429
CHAN Stephen, 2537
CHAN Tze-chun, 472
CHAN Wai-yee, 517
CHAN William, 126, 129
CHAN Yiu-hon, 1737
CHAN Chi-kee Henry, 183
CHAN Chi-wai Stanley, 2258
CHANG Kuei-feng, 1807, 2182, 2433, 2452, 2674, 2685
CHANG Wan-ting, 2433
CHANG Yi-hsuan, 1674
CHAO Chien-chiao, 562, 853
CHAO Yu-chan, 1081, 2752
CHAU Chi-kwan, 251
CHE Wenwei, 1300
CHEN Chen-chun, 2752
CHEN Cheng-chen, 1031
CHEN Chien-fu, 2818
CHEN Jui-ling, 1031
CHEN Ming-chang, 2182
CHEN Philip, 1487
CHEN Ping-hung, 1807
CHEN Po-han, 2786
CHEN Xi, 950
CHEN Ying-sheng, 2193
CHEN Yishan, 1280
CHEN Yu-cheng, 1049
CHEN Yu-jia, 2182
CHENG Cheng-li, 567
CHENG Irene, 1717, 2492, 2511
CHENG Jack CP, 573
CHENG Josh, 1338
CHENG Louie, 2347
CHENG Ming-jen, 1081
CHENG Vincent, 133, 174, 205, 207, 237, 238, 290, 412, 1338, 1876, 1910, 2707
CHENG Ka-yang Kevin, 1389
CHEONG Siu-hung Edmond, 1737
CHERN Szu-jen, 567
CHESHMEHZANGI Ali, 791
CHEUNG Eric, 206, 436
CHEUNG Frank, 191
CHEUNG Gary, 2596
CHEUNG Karen, 1800
CHEUNG Karen HY, 2265
CHEUNG Kwok-fai, 1649
CHEUNG Matthew, 108
CHEUNG Man-chit Jovian, 472, 1737
CHEUNG Yun-hing Richard, 1022
CHIANG Wei-hwa, 2114
CHIH Ying-yi, 957
CHIU Aletta, 2176
CHIU Chun-ting, 542
CHONG Adrian, 2101
CHORUENGWIWAT Jittapat, 1813
CHOU Po-cheng, 562, 1807
CHOW Benny KM, 2265
CHOW Christy, 1770
CHOW Stanley KH, 1837
CHOW Tin-tai, 1075, 1748
CHU Cynthia, 2492
CHU Paul, 2399
CHU Ka-wai Ophelia, 1022
CHUI Wai-lok, 1710
CHUNG Lawrence KW, 2005
CHUNG Po-ren, 853, 1897, 2199, 2618
CHUNG Shih-yen, 2182
CHUNG Wang-leung Thomas, 1405
CÍGLER Jiří, 2188
CISAR Sasha Nikolaus, 840
CLEMENTE Carola, 641
CLIFFORD Matthew, 2347
COLE Raymond, 110
COLELLA Marc, 132
COLLETO Giseli Mary, 1244
CONEJOS Sheila, 271
CONLEY Daniel, 528
CORRAO Rossella, 702
CORREIA Marcia Castilho, 996
COSTALONGA Filipe Galina, 777
CRAFT William James, 716

World Sustainable Built Environment Conference 2017 Hong Kong

CROWHURST David, 1102
CRUZ Marta Monteiro da Costa , 100, 2072
CUCUZZELLA Carmela, 2517
CURZON Mark, 244
DA Vanessa Gomes, 1244
DA CASA MARTIN Fernando, 100
DALIBI Salisu Gidado, 1459, 1495
DALKOWSKI Andreas, 2543
DARWISH Eman Atef, 106, 2824
DAWODU Ayotunde, 791
DAY Yeong-tyi, 1383
DE MACEDO Maira, 1287
DE MIGUEL SANCHEZ Manuel, 100
DE SILVA Wasana, 2505
DEBOFFE Christophe, 105, 2865
Deemah SALAMEH, 2678
DEL CAÑO Teodosio, 370
DELAGADO CONDE Ignacio, 100
DENSLEY TINGLEY Danielle, 888
DESHA Cheryl Julia Kiran , 1634
DEUTSCH Richard, 95, 2779
DEWANCKER Bart Julien, 2446
DI Yanqiang, 117, 1673
DIAS DA SILVA Fabiana, 2020
DING Lan, 124, 716
DING Xiaoying, 2321
DOMINGUEZ GOMEZ Patricia, 100
DONATH Dirk, 1933
DONZE Geurt, 103, 977
DOOLEY Ken, 123, 2353
DORJ Nergui, 2806
DORN-PFAHLER Sabine, 2543
DRUHMANN Carsten K, 2040
DRUMMOND Ana Rita, 101, 1251
DU VERLE Frederic Daniel, 2654
DULAC John, 112
DUMAS Jean-Pierre, 244
DURKIN Michael, 888
DUTTON Hugh, 1345
ECHEVERRIA Ernesto Enrique, 100
EINARSSON Kristina, 1192
ELMOUSLY Hamed, 106, 2824
ELYANA Aida, 1785
ENGEL DE Cristina, 777
ENGEL DE ALVAREZ Cristina, 100, 1211
ERKAL Aygen, 121
ERTEN Duygu, 508
ESSAH Emmanuel, 370
ESSIG Natalie, 1002
FAN Ke, 741
FEMENÍAS Paula, 647, 682
FENG Chun-hao, 2881
FENG Jing-chun, 1459
FENNER Andriel, 930
FERNÁNDEZ John, 1140
FERRO Irene, 722
FIALA Ctislav, 304
FIGL Hildegund, 2108
FIGUERES Christiana, 108, 111, 112
FISCHER Gernot, 95, 2779
FLOERKE Paul, 102, 1945
FOLIENSTE Greg, 97, 115, 122, 901, 1088, 1152, 2340
FONG Tom, 184
FONSECA Jimeno, 326
FONTAN YANES Eugenio Maria , 2584
FONTANA Patrick, 96, 2811
FOO Chee-hung, 1986
FORGUES Daniel, 809
FORT-BRESCIA Bernardo, 1345
FRATTARI Antonio, 722
FUJIHARA Maria Carolina, 827
FUJII Tatsuo, 1730
FUNG Ada, 125, 127, 2492, 2511
FUNG Clarence, 2492
FUNG Ka-kit, 1300
FUNG Katy, 1710
FUNG Ka-yan, 406
FUNG Siu-man, 1883, 2661
FUNG Chi-hung Jimmy, 2147
FUNG Kook-koon Edwin, 1230
GAN Hock-beng, 1986
GAO Chun-ping, 2161
GARRIGAN Curt, 111
GEISSLER Susanne, 591
GERMAR Fernando, 122
GERRITSEN Esther, 1555
GLAUS Mathias, 809
GODAGER Bjørn Arild, 1998, 2033
GOH Alice, 2161
GONZALEZ Alexander, 100, 784
GOSSE Georgia Dodge, 1634
GOSTIC Samo, 2734
GÖSWEIN Verena, 1140
GRABER Anna, 2641
GRECO Angela, 1555, 1580
GREEN Jemma, 528
GRICE Alistair, 244
GRYNBERG Yann, 2161
GU Wei, 741, 747
GÜL Korkmaz, 104, 1160
GUNATILAKE Sachie, 1525

World Sustainable Built Environment Conference 2017 Hong Kong

GUO Hongshan, 364
GUO Mengdi, 2079
GUO Nan, 747
GUPTA Souradeep, 2866
GUSTAFSSON Tomas, 245
GUTHRIE Peter, 109
HABERT Guillaume, 121, 840, 1140, 2053, 2141, 2850
HAJ HUSSEIN Muhannad, 2678
HAJEK Petr, 304
HAKIM Hamed, 930
HAKKINEN Tarja, 2734
HALL Anders, 244, 765
HALWATURA Rangika, 2843
HAMID Zuhairi Abd, 1986
HAN Dan, 2239
HAN Jianbo, 251
HANGARTNER Diego, 1224
HANSEN Hanne Tine Ring, 598, 2531
HAO Tong-ping April, 803
HARGROVES Karlson Charles, 528
HAYLES Carolyn S., 2635
HE Jiao, 2887
HEBERT Lios, 528
HEJL Jaroslav, 304
HEPBASLI Arif, 105, 370
HERDA Gregor, 112
HERMIDA M. Augusta, 100, 101, 2066, 2252
HERNANDEZ Jaime Jr., 97, 1265
HERNANDEZ Patxi, 1173
HES Dominique, 2523
HETTIARACHCHI Chamod Kosala, 2894
HILL Justin, 1742
HINTERBRANDNER Angelika, 989
HIRANO Katsuhiko, 669
HIRAOKA Masaya, 1776
HIROMOTO Shinichi, 1776
HIRSCH Eric, 2347
HO Antony, 125, 290, 1510, 1910
HO John HL, 1258
HO Ming-chin, 567, 1081, 2818
HO Raymond, 1487
HO Shin-jia, 1679
HO Yen-yi, 1679
HO Ho-man Patrick, 1724
HO Kin-wai Stephen, 2661
HOFF Guido, 611, 1102
HOFSTADLER Christian, 579
HOLLBERG Alexander, 1933
HOLLMULLER Pierre, 96, 1166
HOLMQUIST Jenny, 245
Hon-wan Edwin CHAN, 251, 418
HOPPE Johannes, 96, 2811
HOR Kevin, 1547
HORYNA Vladimír, 2188
HOU Shan-shan, 1889
HOULIHAN Aoife Anne-Marie, 97, 1825
HOZATLI Burak, 104, 1160
HSIEH Hung-ren, 2440
HSIEH Shanshan, 326
HSU Nai-yun, 1426
HSU Wen-chi, 2674
HSU Shu-chien Mark, 1237
HU Jinshan, 406
HUANG Chih-ming, 562
HUANG Chi-ming, 853
HUANG Dan, 2114
HUANG Jianxiang, 1369, 2079
HUANG Lin-lin, 1807
HUANG Lizhen, 1998
HUANG Ning, 1102
HUANG Qiong, 880
HUANG Wei-chih, 1679
HUANG Yuan-chang, 2818
HUI Hok-tung, 2212
HUNG, Chieh-jen, 2452
HUNZIKER Roland, 112
HUO Xiaosen, 1686
HUOVILA Pekka, 112, 122
IBRAHIM DANJA Isa, 1495
IDZIHAR Ahmad, 1547
IKAGA Toshiharu, 107, 815, 2699
IKUTA Yuichi, 2699
ILOMAKI Ari, 1146
IP Kenneth, 284
IP Tony, 2299
ISHIGURO Takeshi, 669
ISHINO Hisaya, 1730
ISSA Mohamed H., 102, 2371
IYER-RANIGA Usha, 1844
IZADI MOUD Hashem, 930
JACOBS Anne, 501
JAILLON Lara Celine, 1126
JALAM Usman Aliyu, 728
JAMES Melissa, 105, 2469
JAREEMIT Daranee, 1813
JENSEN Rasmus L, 1967
JENSEN Stina Rask, 689, 702
JIA Yan, 120
JIANG Yiqiang, 117
JIAO Liudan, 1037
JOHANSSON Anders, 245

JONATHAN Tim, 1580
JONES Phil, 133, 150, 358, 1369, 1889
JULPANWATTANA Panpisu, 1813
JUNG Nusrat, 2734
KABAKCI Oguz Kursat, 1160
KAHRAMAN İlker, 104, 2133
KAM Margaret, 1819
KAMARI Aliakbar, 689, 702
KAO Kuo-sheng, 2618
KARA Hudai, 104, 2133
KARABACAK Asli, 104, 1160
KARIM Sardar Masud, 2406
KARLSSON HJORTH Hans-Olof, 1192
KASPERSEN Benedicte, 1992
KAUSCHEN Jan Schipull, 2046
KAWAKAMI Hiroki, 669
KAWAKUBO Shun, 107, 815
KAWAYOKE Takahiro, 2699
KENNEDY Rosemary Jean, 1961
KERZ Nicolas, 924, 1132
KHARSEH Mohamad, 675, 709
KHOJA Ahmed, 94, 2095
KHOURY Jad, 96, 1166
Kian-seng ANG, 964
KIBERT Charles Joseph, 930
KILBURN Mike, 2537
KILKIS Birol, 103, 341
KINAY Uygur, 104, 1160
KIRKEGAARD Poul Henning, 689, 702
KJENDSETH Marianne Rose, 97, 1825
KLINGE Andrea, 96, 2811
KNIES Jürgen, 1870
KNUDSTRUP Mary-ann, 598, 2531
KO Chien-hung, 1807
KOCH Christian, 635, 1115, 1643
KOČÍ Vladimír, 2188
KOHLMAN-RABBANI Emilia, 101, 1251
KOJIO Ryusuke, 2603
KOMIYAMA Tsutsumi, 2699
KOMODA Hideharu, 1776
KONCZ Peter, 2026
KONG Ka-wah, 542
KONG Wen-ping, 1761
KONSTANTINOU Thaleia, 1555
KOPFMÜLLER Jürgen, 2272, 2279
KOPPELHUBER Jörg, 579
KOVÁCS Peter, 682
KREINER Helmut, 989, 2155
KREIßIG Johannes, 846
KRIGSVOLD Guri, 2033
KRIGSVOLL Guri, 1998
KRONES Jonathan, 1140
KUA Harn-wei, 2866
KUO Wu-wei, 2182, 2674
KUO Yi-chun, 562, 752
KURKOWSKA Izabela, 675, 709
KUSCHE Oliver, 2108
KUZUKI Ryota, 1730, 2699
KWAN Bing, 207
KWAN Calvin Lee, 207
KWAN Chris, 207, 2596
KWAN Kai-yin, 735
KWAN Rebecca, 1910
KWOK Grace, 183, 184, 191
KWOK Kenneth, 1710
KWOK Raymond, 174
KWONG Samuel, 1611
L. Pinky Devi, 907
LABBÉ Françoise, 1571
LACHAL Bernard, 96, 1166
LAGNERÖ Linda, 1192
LAI Andrew, 1699
LAI Andy, 183, 191
LAI Joseph, 436
LAI Ming, 1667
LAI Wan-ting, 2752
LAI Siu-ming Jeffrey, 2668
LAI Sze-yuen Matthew, 1230
LAIBLOVA Lenka, 304
LAIN Miloš, 2188
LAM Ho-yin, 2612
LAM Joseph C., 1837
LAM Khee-poh, 2101
LAM Lewis, 183, 198
LAM Man-san, 1015
LAM Schuman, 418
LAM Simon, 436
LAM Tony, 1338, 1876
LAM Tsz-kin, 311
LAM Chor-man Charmane, 1237
LAM Wai-kei Harris, 1724
LAM Yu-Hin Lewis, 198
LAMANO Adrian, 2161
LANDROU Gnanli, 2850
LANGBROEK Ruben, 182
LARSEN Tine S, 1967
LARSSON Nils, 112, 123, 124
LAU Kwok-keung, 585
LAU Vetus, 1510
LAU Wilfred, 246, 278
LAU Wing-kam, 1710
LAU Wing-wah, 1389

World Sustainable Built Environment Conference 2017 Hong Kong

LAU Kai-hon Alexis, 1300
LAU Ka-lun Kevin, 1049
LAU Siu-kei Dominic, 1864
LAU Siu-yu Stephen, 99, 448, 803
LAW Christopher, 182
LAWRENCE Thomas Mark, 1742
LAYKE Jennifer, 112
LECHÓN Juan Luis, 105, 370
LEE Charles, 206
LEE Chee-kwan, 585
LEE Ching-chang, 1031
LEE Dennis, 1973
LEE Eric WM, 1837
LEE Hackman, 184
LEE Ivy SW, 2561
LEE Ju-yii, 2685
LEE Matthew, 2561
LEE Ming Wai, 1126
LEE Raymond, 131
LEE Shin-ku, 2818
LEE Shun-cheng, 246, 265
LEE Siew-eang, 1755
LEE Tony, 311
LEE Tzan-chain, 492
LEE Po-heng Henry, 1237
LEE Yang-pin Kelvin, 99, 2765
LE-HOAI Long, 957
LEINDECKER Herbert Claus, 2334
LEMAITRE Christine, 846
LEONG Lincoln, 115
LEONG I-man Echo, 1389
LEOTO Ricardo Ferreira, 1655
LEUNG Denise, 1345
LEUNG Eugene, 237
LEUNG Gary, 2596
LEUNG Wai-ho, 1770
LEUNG Wai-Ho, 174
LEUNG Wing-hong, 1864
LEUNG Chi-Fai Patrick, 198
LEUNG Chung-lap Michael, 1230
LEUNG Wah-ming Richard, 2258
LI Danny HW, 1837
LI Haixi, 1643
LI Jiexin, 2457
LI Jing, 2887
LI Justin, 1819
LI Ke-han, 2462
LI Li-hong, 2746
LI Ming-da, 2440
LI Qiyuan, 2011
LI Ricky, 1876
Li SHAO, 105
LI Siu-lung, 1008
LI Tan-yui, 1300
LI Tao, 1770
LI Wenpeng, 1761
LI Xianting, 118
LI Xiaojun, 358
LIAO Wan-ju, 567
LIEN Anne G, 653
LIM Chong-teik, 2765
LIN Chia-hsiung, 2618
LIN Chien-hsun, 2874
LIN Han, 1412
LIN Hisn-I, 2199
LIN Hungchun, 1897
LIN Tzu-ping, 1049
LIN Wei, 2114
LIN Yvonne, 184
LIND Jonas, 2719
LIU Edmond WF, 1705
LIU Lu, 627
LIU Xingjian, 950
LIU Yi, 1439, 1667
LIU Yisheng, 1667
LIUNG Hing-heng, 2433
LIZARRALDE Gonzalo, 1655
LO Alvin, 174, 207, 1770, 2384, 2596
LO Irene MC, 573
LO Nelson, 183
LO Siu-kuen, 2692
LO Sunny, 2624
LOH Christine, 112, 115
LÖHNERT Günter, 208, 229, 2543
LOK Timothy, 290
LOO Becky PY, 2654
LORENZ David, 1599
LOU Siwei, 1837
LOW David, 2457
LU Bryant, 114, 1307, 2569, 2574
LU Lin, 1419
LU Mei-chen, 1426
LU Weisheng, 950
LU Yuan-hua, 2452
LUI Chun-wan Alex, 246, 247
LUI Yin-park Patrick, 2486
LUK Harry, 134
LUPISEK Antonin, 121
LUPÍŠEK Antonin, 2188
LUTTEMAN Anders, 635, 1643
LÜTZKENDORF Thomas, 97, 113, 122, 208, 209,
611, 901, 989, 1102, 1146, 1599, 2272, 2279

World Sustainable Built Environment Conference 2017 Hong Kong

LYSLO SKULLESTAD Julie, 1992
MA Tao, 1419
MABE Lara, 1173
MACHARM Ene, 591
MAGDOLEN Simone, 424
MAGORI Bumpei, 379, 1541
MAING Minjung, 1054
MAK Andrew, 311
MAK Ka-chun, 1864
MAK Michael Y, 2486
MAK Kei-choi Henry, 2668
MAKAKA Golden, 758
MALLORY-HILL Shauna, 101, 1397
MALMQVIST Tove, 2719
MAMPEARACHCHI Wasantha Kumara, 2894
MANLEY Karen Jane, 2798
Man-nin Chris LAU, 1389
MANSOUR Yasser, 106, 2824
MARIN Laura, 100, 784
MARINO Raul, 1088
MARTIN SAN CRISTOBAL Francisco, 100
MARTINEZ Vincent, 2457
MATA Érika, 696
MAUND Kim, 2771
MCCORD Steven, 2347
MCCREA Rod, 2340
MCCULLEN Nick, 2635
MCPHEE Rodney, 1102
MEGGERS Forrest, 364
MEIJER Arjen, 103, 977
MEIJER Frits, 549
MENDONÇA Lizelda Maria, 101, 1251
MENG Chong, 120
MENNEL Stefan, 1224
MENTI Urs-Peter, 1224
METIBOGUN Lesley, 1939
MEYER Edson Leroy, 758
MICHL Peter, 1599
MIERA Eduardo, 1173
MINANE Jacques Rémy, 105, 2865
MIRHOSSEINI Homeira, 1445
MITTERMEIER Paul, 94, 123, 2095
MIYAZAKI Go, 1692
MIZUIDE Kitaro, 133, 165
MO Kevin, 100, 119
MODICA José Eduardo, 1287
MOHAMMADPOUR Javad, 1742
MOHAMMED Bashir Abdulmalik, 728
MOHAMMED Nma Yakubu, 728
MONCASTER Alice, 2390
MOOSAVI Sareh, 2523
MORAIS NETO Gregório Coelho de , 2072
MORENO GATA Kevin, 100
MORISHITA Yu, 379, 1541
MORO Andrea, 121, 123, 920, 937, 984
MOSCHETTI Roberta, 653
MUHAMMAD Abubakar Yahaya, 728
MUI Kwok-wai, 1199
MÜLLER Julia, 208, 213
MÜLLER Richard Carl, 833
MURAKAMI Shuzo, 107, 815, 1730, 2699
NADIM Wafaa, 121
NÄGELI Claudio, 709
NÄGELI Claudio, 675
NAJI Sareh, 861
NAKAJIMA Yusuke, 1294, 1692, 2901
NAPHADE Nakul, 2161
NARSILIO Guillermo, 2127
NAVARRO Rafael, 462, 484
NAZEER Fathima Sabrina, 1525
NEGENDAHL Kristoffer, 2046
NEIRA Mateo, 100, 2252
NENG Jeffery, 964
NEVES Leticia de Oliveira, 1244
NEWMAN Peter, 528
NG Edward, 2462
NG Kevin, 2590
NG Ting-sing, 2692
NG Vicky, 1510
NG Yong-kong, 1785
NG Yu-ting Ivan, 2258
NGUBANE Njabulo Sydney, 821
NGUYEN Hung Duy, 957
NGUYEN Long Duy, 957
NI Kuo-chun, 2685
NI Meng, 351
NIBEL Sylviane, 611
NICO-RODRIGES Edna Aparecida, 777
NIELSEN Anne N, 1967
NING Andrew, 1793
NINOMIYA Hiroshi, 1730
NISSEN Søren B, 1967
NOGUCHI Masa, 861, 1179
NOGUEIRA Viviany, 101, 1251
NOHARA Fumio, 1730
NORMAN Åsa, 245
OGUNMAKINDE Olabode Emmanuel, 2771
Ohis AIGBAVBOA Clinton, 821
OKE Ayodeji Emmanuel, 821
OLIVEIRA Ana Claudia Figueiredo , 400
OMAR Osama Mohamed, 1377
ONO Eikichi, 1776

World Sustainable Built Environment Conference 2017 Hong Kong

ONYANGO Vincent, 2555
OPSTELTEN Ivo, 122
OREGI Xabat, 1173
ORELLANA Daniel, 101, 2066
OSORIO Pablo, 100, 2252
ÖSTERBRING Magnus, 696
OSTERMEYER York, 675, 709
OSWALD Ferdinand, 279
OU Po-cheng, 752
OUF Mohamed, 2371
OVEREN Ochuko Kelvin, 758
OWADA Jun, 1776
ÖZELER KANAN Nilay, 104, 1160
P. HELÅSEN Anne Lise , 1998
PALANIAPPAN Sivakumar, 907
PAN Mi, 555
PAN Wei, 555, 874, 914, 1095, 1831
PANG Sze-dai, 2866
PANG Wing-sum, 1300
PANTAZARAS Alexandros, 1755
PARRA Elizabeth, 100, 1362
PARROTT Madeline Kathleen, 2120
PASSER Alexander, 95, 208, 220, 989, 2053, 2155, 2779
PATTERSON Jo, 358
PAZHOOHESH Mehdi, 2366
PEDERSEN Stine Skøtt, 2531
PEKERICLI Mehmet Koray, 394
PELAEZ Andres, 784
PENG Rong, 1369
PERERA Srinath, 522
PERES Sérgio, 101, 1251
PETTIT Chris, 1088, 2340
PHILIPP Conrad, 251, 1354
PICKLES David, 1699
PIPRALIA Satish, 1955
PLOYET Valentin, 861
POOLE Kevin, 132, 2205
POON Chi Sun, 1126
POON Dicken, 2561
POON Eric, 1510
POON Ka-man, 517
POON Larry, 125, 126, 130
POON Wing-chi Gigi, 1389
PRASAD Deo, 122, 716
PRYOR Matthew, 1591
PU Po-yen, 2685
QIAN Queen K, 2792
QIAN Queena, 741
QIN Jean, 141, 1761
QIN Weicong, 351
Qing YE, 119
QUADIR Jabeen, 611
QUISPE POLANCO Omar, 2086
RAJPUT Shahid Ahmad, 1628
RAMACHANDRA Thanuja, 1525
RAMALHETE Ines, 2426
RAMIREZ Leidy Johana, 100, 1362
RASMUSSEN Torben Valdbjørn, 2307
REN Zhengen, 1152
RESCH Eirik, 103, 2713
RICHARDSON Mark, 174, 2293, 2384
RICHTER Matthias, 96, 2811
RICO Elena, 105, 370
RIETZ Andreas, 209, 924
RÖCK Martin, 2053
ROJAS-AREVALO Angela Maria, 1042
RÖSCH Christine, 2272
ROSE Timothy, 1634, 2798
ROSWAG-KLINGE Eike, 96, 208, 226, 2811
RUDOLPHI Alexander, 846
RUTH Jürgen, 1933
RUZICKA Jan, 304
SAADE Marcella Ruschi, 895
SADIQ Abubakar, 1459, 1495
SAIZ Sergio, 1173
SALAT Serge, 94, 113, 1571, 2725
SALGADO Monica Santos, 943, 996, 2020
SALTER Liam, 182
SANDERS Fred, 2477
SANI BELLO Bello, 1459
SANTAMOURIS Mat, 1755
SANTANDER Alvaro MOZAS, 100
SARVAIYA Jatin, 2161
SASAJIMA Kenichi, 1730
SASE Takeshi, 333
SAT Paul, 1800
SAT Paul SK, 2265
SATOH Makoto, 1730
SAYARY Samer EL, 1377
SCHAMBER Olga, 833
SCHERZ Marco, 2155
SCHIPPER Roel, 1555
SCHLUCK Thomas, 1605, 2470
SCHLUETER Arno, 113, 326, 2741
SCHNEIDER Stefan, 96, 1166
SCHNEIDER Sven, 1933
SCHULTMANN Frank, 833
SCHULZE Joachim, 387
SCHÜTZ Stephan, 298
SCOTT Lloyd Martin, 1620
SENIOR Gérard, 611, 1102

World Sustainable Built Environment Conference 2017 Hong Kong

SEO Seongwon, 97, 901, 1152
SEOH Alvin, 2161
SETO Shirley, 1510
SHAHMIR Raja, 2060
SHAHRESTANI Mehdi, 105, 370
SHAN Kui, 442
SHAN Ming, 1468, 1504
SHAO Annie, 1338
SHAO Li, 370
SHEN Edward, 803
SHEN Liyin, 1037
SHEN Tim, 1565
SHER William David, 2771
SHI Zhongming, 2741
SHIE Chih-chang, 752
SHIN Sungwoo, 122
SHUAI Chenyang, 1037
SHUM Chung-yee, 542
SIBER Birgit, 101, 534
SILVA Maristela Gomes, 895
SILVA Vanessa Gomes, 895
SIMÕES ROCON Carolina, 100, 1211
SIMPSON Andrew, 2384
SIOW Jeffrey, 484
SIRTULI Bruna Perovano, 777
SIU May, 964
SKEIE Kristian S, 653
SKOPEK Jiri, 123, 1475, 1482, 2457
SKOPEK Simone, 1475
ŚMIECHOWSKI Dariusz, 95, 2232
SMITH Shane Ida, 1445
SO YS, 1761
SOJKOVÁ Kateřina, 2188
SÖLKNER Petra, 95, 2779
SPAUN Sebastian, 95, 2779
SRIRUTTRAKUL Pimchanok, 1536
STEINMANN Christian, 2155
STELZER Volker, 2279
STEPHAN André, 2523
STJELJA Davor, 2353
STRANGE Anders, 689
STRAUB Ad, 103, 977, 2792
STRITTER Jessica, 2543
SU Chih-hsun, 562
SU Yunshan, 108
SULZER Matthias, 1224, 1605, 2470
SULZER Sabine, 1605
SUM Pang-tuen Barry, 1230
SUN Yanchen, 880
SZCZEPANOWSKI Charlotta, 245
SZE Timothy, 184, 191
TAI Joyce, 1487
TAI Lee-siang, 113
TAI Philip, 478
TAI Samson, 237
TAI Tak-him, 1737
TAKAI Hiroaki, 669
TAKEMASA Yuichi, 1776
TAKKANON Pattaranan, 1061
TAM Tin-fong Martin, 2834
TAMURA Eriko, 2293
TAN Teri, 2596
TAN Tian-chong, 115, 2161
TAN Yongtao, 1037
TAN Siow-hwei Joanne, 1468
TANAKA Kouji, 669
TANG Chee-khoay, 1204, 1547, 1785
TANG Jie, 119
TANG Matthew, 1611
TANG Shiu-keung, 246, 258
TANG Simon, 1926
TANG Yuqi, 1926
TANG Yu-tin, 2758
TANG Sek-khuen Thomas, 2498
TANYER Ali Murat, 394
TENCAR Jiří, 2188
TEPAVCEVIC Aleksandar, 1850
THILAKARATNE Ruffina, 2399
THOMPSON Susan, 2406
THUVANDER Liane, 647, 682, 696
TONG Amen, 206
TONG Jimmy, 238, 1300
TONG Jimmy CK, 205, 237, 1332
TONG Kum-kong, 99, 2765
TONG Yun-on, 1412
TONG Chun-kuen Jimmy, 1300
TSANG Sonia, 191
TSANG Tsz-wun, 1199
TSANG Kwok-leung Anthony, 1699
TSANG Siu-chung Isaac, 311
TSAY Yaw-shyan, 1426, 1674, 1679, 2193, 2874
TSCHETWERTAK Julia, 1933
TSE Norman, 1748
TSENG Pin-chieh, 562
TSIKALOUDAKI Aikaterini, 121
TSIKOS Marios, 2046
TSUI Simon, 436
TSUJIMARU Norie, 1730
TUPAC VALDIVIA Yvan, 2086
TY LO Alvin, 2265
TZENG Ping-chieh, 2199
UDAWATTE Chameera, 2843

World Sustainable Built Environment Conference 2017 Hong Kong

UEHARA Hinako, 2901
URBAN Miroslav, 2188
VALLIAPPAN Selvam, 122, 2161
VAN DEN DOBBELSTEEN Andy, 880, 1555, 1580
VAN HAL Anke, 102, 772
VAN HULTEN Saskia, 977
VANOLI Giuseppe Peter, 1132
VARA-URAIRAT Panita, 2378
VEEROJA Piret, 2340
VEGA Juan Manuel, 100
VICTORIA Michele, 522
VIENOT Etienne, 937, 984
VINHAL Laís David, 101, 2217
VISSCHER Henk, 1121, 2792
VOLF Martin, 304
VOLK Rebekka, 833
VUJOVIC Vuk, 1109
W K LEE Edward, 2176
W L MAK Bevis, 2176
WADA Kazuki, 669
WAI Joanna, 1487
WAI Rosman, 2511
WALL Johannes, 579
WALLBAUM Holger, 675, 696, 709
WAN Kevin, 290, 1910
WAN Man-pun, 2161
WANG Hong, 1412
WANG Jie, 914
WANG Junliang, 660
WANG Qiancheng, 351
WANG Qingqin, 660
WANG Richard, 412
WANG Runsheng, 1439
WANG Shanshan, 1699
WANG Shengwei, 442
WANG Wen-an, 1432
WANG Yitian, 351
WANG Youwei, 113
WANG Yucheng, 455
WANG Yu-jie, 2674
WANG Yun, 119
WANG Zhuo, 2746
WANGEL Josefin, 2719
WÄNGGREN Bengt, 245
WAREING Sara, 2327
WATSON Rick, 1742
WEBERBERGER Armin, 2334
WEI Qingpeng, 133, 141
WELSCH Merten, 94, 924, 970
WHYTE Fergal, 1699
WILLIAMS Mike, 101, 534
WILLIAMS Peter, 2406
WISMAYER Amber, 2635
WO Yaki, 2457
WON Jongsung, 573
WONG Carmen YS, 1793
WONG Chi-chung, 131
WONG Clement, 206
WONG Conrad TC, 1793
WONG Guymo, 2574
WONG Kam-sing, 111
WONG Ling-tim, 1199
WONG Man-lung, 2612
WONG MW, 1258
WONG Samuel, 207
WONG Simon, 868, 2147
WONG Sui-kan, 1389
WONG Sylvester Timothy, 132
WONG Wei-jin, 2433
WONG Kam-hay Arthur, 1649
WONG Pow-chew James, 1452
WONG Sze-ming Simon, 2147
WONG Yat-hang Felix, 2758
WONG Yee-Ting Bonny, 198
WOO Douglas, 115
Wu DENG, 791
WU Hongjuan, 2792
WU Xuchao, 2347
WU YL, 141
WU Yat-fei Alex, 2258
XIAO Yana, 2399
XIONG Jian James, 1926
XU Haoran, 351
XU Weili, 2101
YAHAYA MUHAMMAD Abubakar, 1495
YAM Peter, 2569
YAMASAKI Junya, 107, 815
YANG Hongxing, 1419
YANG Jason, 1926
YANG Jason JZ, 2265
YANG Jianrong, 118
YANG Wei, 627, 2011
YAO Runming, 105, 370
YAO Ting, 134, 311
YAP Cheng-chwee, 99, 2765
YARIME Masaru, 1218
YASHIRO Tomonari, 379, 1102, 1541
YAU Ka-tai, 1710
YAU Raymond, 133, 134, 141, 174, 182, 1345, 1761, 1770
YEO Joonho, 1300
YEUNG Maurice, 585

YEUNG Sau-kuen Sammy, 406
YIK Wilson, 2561
YIM Stephen, 1258, 1717, 2492
YIMPRAYOON Chanikarn, 495
YIU Cheuk-man, 472
YOKOTA Alessandra Akemi, 1179
YTREHUS Egil, 1992
YU Franklin, 2361
YU Hanze, 627, 2011
YU Linda, 2347
YU Wenjuan, 1068
YUE Frenky, 174
YUEN Belinda, 131
YUEN Piu-hung, 429
YUEN Ka-yiu Thomas, 1883, 2661
YUNG Esther, 246, 251, 271, 747
YUNG Hiu-kwan Esther, 246, 271
ZAKUCIOVÁ Kristina, 2188
ZENISEK Michal, 304
ZETTERSTRÖM Emilie, 245
ZEULE Ludimilla de Oliveira, 101, 2217
ZHANG Cheng, 2060, 2366
ZHANG Qianning, 99, 448
ZHANG Rui, 2239
ZHANG Wei, 1661, 2314
ZHANG Wenjing, 1075
ZHANG Xiaoling, 617
ZHANG Xuefan, 119
ZHANG Ye, 1761
ZHANG Yifan, 2011
ZHANG Yinping, 120
ZHANG Yukun, 2239, 2321
ZHANG Zhe, 2161
ZHANG Zhidong Edison, 803
ZHAO Li, 117
ZHAO Yimin, 1643
ZHAO Zhidan, 1325
ZHOU Haoran, 1439
ZHOU Jian, 2161
ZHOU Yanmin, 1889
ZHOU Yu, 2127
ZHU Lei, 1468, 1504
ZHUK Petr, 2907
ZIEGERT Christof, 96, 2811
ZINKERNAGEL Roland, 107, 121, 2285
ZIONI Eleonora, 1287

Sponsors

Platinum Sponsors



Gold Sponsors



Silver Sponsors



Parallel Session Organisers

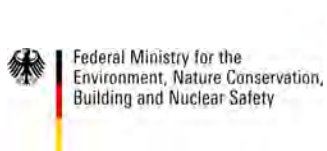

Federal Ministry for the Environment, Nature Conservation, Building and Nuclear Safety



Federal Institute for Research on Building, Urban Affairs and Spatial Development
within the Federal Office for Building and Regional Planning



信和集團
Sino Group



**International Youth (IYC)
Sponsor**

**Conference Lanyard
Sponsor**



**Green Building Tour
Sponsor**

**Volunteers' T-shirt
Sponsor**



Supporting Organisations



10YFP Sustainable Buildings and Construction (SBC) Programme



AFRIKArchi



Architectural Services Department



ASHRAE Hong Kong Chapter



Association of Consulting Engineers of Hong Kong



Australia Institute of Building Hong Kong Chapter



BEAM Society Limited



Business Environment Council Limited



Building Services Operation and Maintenance Executives Society (BSOMES)



Buildings Department



Centre for Corporate Sustainability and Innovations (Hang Seng Management College)



Chartered Institution of Water and Environmental Management Hong Kong (CIWEM)



Civil Engineering and Development Department



Consulate General of Canada



Council for Sustainable Development (SCD)



Department for International Trade



Department of Architecture and Civil Engineering, City University of Hong Kong



Department of Building and Real Estate, The Hong Kong Polytechnic University



Department of Civil and Environmental Engineering, The Hong Kong Polytechnic University



Department of Civil and Environmental Engineering, The Hong Kong University of Science and Technology



Department of Civil Engineering, The University of Hong Kong



Department of Land Surveying and Geo-Informatics, The Hong Kong Polytechnic University



Development Bureau



DGNB e.V. (German Sustainable Building Council)



Drainage Services Department



Electrical and Mechanical Services Department



Emirates Green Building Council



Energizing Kowloon East Office, Development Bureau, HKSARG



Environment Bureau



Environmental Protection Department



Federation of Hong Kong Industries (FHKI)



FFG Österreichische Forschungsförderungsgesellschaft



Friends of the Earth (HK)



German Industry and Commerce Ltd.



Good Lab



Green Building Council Australia

Supporting Organisations



GBC BRASIL

Green Building Council Brasil



Green Building Council España (GBCe)



Green Building Council Indonesia



Green Council



Greeners Action



Highways Department



Hong Kong Association of Energy Engineers



Hong Kong Association of Energy Service Companies (HAESCO)



Hong Kong Baptist University



Hong Kong Construction Association



Hong Kong Environmental Industry Association



Hong Kong General Building Contractors Association



Hong Kong General Chamber of Commerce



Hong Kong Housing Authority



Hong Kong Housing Society



Hong Kong Institute of Construction Managers



Hong Kong Institute of Steel Construction



Hong Kong Construction Sub-contractors Association

Hong Kong Construction Sub-contractors Association



香港城市設計學會
Hong Kong Institute of Urban Design

Hong Kong Institute of Urban Design



Hong Kong Productivity Council



Hong Kong Science and Technology
Parks Corporation



HONG KONG
WASTE MANAGEMENT ASSOCIATION
香港廢物管理學會

Hong Kong Waste
Management Association



Hungary Green Building Council



Indian Green Building Council /
Confederation of Indian Industry



Institution of
Civil Engineers of Hong Kong



Institute for Entrepreneurship,
The Hong Kong Polytechnic University



ISO/TC 59 Buildings and civil
engineering works



Korea Green Building Council



Lebanon Green Building Council



Malaysia Green Building Confederation



Master of Science in
Environmental Management Programme,
The University of Hong Kong



Meetings & Exhibitions Hong Kong
(MEHK)



Mission Healthy Greens



Mongolia Green Building Council



Peru Green Building Council



Planning Department

Supporting Organisations



Professional Green Building Council



Qatar Green Building Council



Research Institute for Sustainable Urban Development,
The Hong Kong Polytechnic University



RICS



Singapore Green Building Council



Sustainable Building Council
Bosnia and Herzegovina



Sweden Green Building Council



The American Institute of Architects
Hong Kong Chapter



The Association of Architectural Practices



The British Chamber of Commerce
in Hong Kong



The Chartered Institute of Building
(Hong Kong)



The Chartered Institution of Building Services
Engineers (Hong Kong Branch)



The Chinese University of Hong Kong



The Hong Kong Chapter of International
Facility Management Association



The Hong Kong Federation of Electrical and
Mechanical Contractors Limited



The Hong Kong Institute of Architects



The Hong Kong Institute of
Facility Management

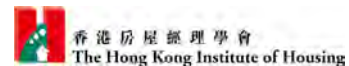

The Hong Kong Institute of Housing



The Hong Kong Institute of Landscape Architects



The Hong Kong Institute of Planners



The Hong Kong Institute of Surveyors



The Hong Kong Institution of Engineering Surveyors



The Hong Kong Institution of Engineers



The Hong Kong Retail Management Association



The Institution of Mechanical Engineers (Hong Kong Branch)



The Open University of Hong Kong



The Real Estate Developers Association of Hong Kong



Vietnam Green Building Council



Water Supplies Department



World Green Organisation

Official Carrier



CATHAY PACIFIC

Cathay Pacific Airways Limited

Media Partners



BCI Asia



Building Journal



Centre for Urban Greenery
and Ecology



Dot Property Co., Ltd



HK01



Journal of Construction Economy



Perspective



PRC Magazine



Southeast Asia Building



Urban City

Official News Distribution Partner



PR Newswire Asia

Journal Partners



Building Research & Information

Energy and Buildings

Indoor and Built Environment

Event Supporters



Build Eco Xpo (BEX) Asia



Eco Expo Asia

